



FCC RF Test Report

APPLICANT : Motorola Mobility LLC
EQUIPMENT : Mobile Phone
BRAND NAME : Motorola
MODEL NAME : XT2433-2, XT2433-1
FCC ID : IHDT56AS4
STANDARD : 47 CFR Part 2, 27
CLASSIFICATION : PCS Licensed Transmitter Held to Ear (PCE)
TEST DATE(S) : May 03, 2024 ~ Jun. 25, 2024

We, Sporton International Inc. (Kunshan), would like to declare that the tested sample has been evaluated in accordance with the procedures given in ANSI C63.26-2015 and shown compliance with the applicable technical standards.

This report contains data that were produced under subcontract by Sporton International Inc. (Shenzhen).

The test results in this report apply exclusively to the tested model / sample. Without written approval of Sporton International Inc. (Kunshan), the test report shall not be reproduced except in full.

Jason Jia

Approved by: Jason Jia



Sporton International Inc. (Kunshan)

**No. 1098, Pengxi North Road, Kunshan Economic Development Zone Jiangsu Province 215300
People's Republic of China**



TABLE OF CONTENTS

REVISION HISTORY... 3
SUMMARY OF TEST RESULT ... 4
1 GENERAL DESCRIPTION ... 5
1.1 Applicant ... 5
1.2 Manufacturer ... 5
1.3 Product Feature of Equipment Under Test ... 5
1.4 Product Specification of Equipment Under Test ... 6
1.5 Modification of EUT ... 6
1.6 Maximum EIRP and Emission Designator ... 7
1.7 Testing Location ... 8
1.8 Test Software ... 8
1.9 Applicable Standards ... 9
1.10 Specification of Accessory ... 9
2 TEST CONFIGURATION OF EQUIPMENT UNDER TEST ... 10
2.1 Test Mode ... 10
2.2 Connection Diagram of Test System ... 12
2.3 Support Unit used in test configuration and system ... 12
2.4 Measurement Results Explanation Example ... 12
2.5 Frequency List of Low/Middle/High Channels ... 13
3 CONDUCTED TEST ITEMS ... 15
3.1 Measuring Instruments ... 15
3.2 Test Setup ... 15
3.3 Test Result of Conducted Test ... 15
3.4 Conducted Output Power and EIRP ... 16
3.5 Peak-to-Average Ratio ... 17
3.6 Occupied Bandwidth ... 18
3.7 Conducted Band Edge ... 19
3.8 Conducted Spurious Emission ... 20
3.9 Frequency Stability ... 21
4 RADIATED TEST ITEMS ... 22
4.1 Measuring Instruments ... 22
4.2 Test Setup ... 22
4.3 Test Result of Radiated Test ... 23
4.4 Radiated Spurious Emission ... 24
5 LIST OF MEASURING EQUIPMENT ... 25
6 MEASUREMENT UNCERTAINTY ... 26
APPENDIX A. TEST RESULTS OF CONDUCTED TEST
APPENDIX B. TEST RESULTS OF RADIATED TEST
APPENDIX C. TEST SETUP PHOTOGRAPHS



REVISION HISTORY

REPORT NO.	VERSION	DESCRIPTION	ISSUED DATE
FG422904G	Rev. 01	Initial issue of report	Jul. 26, 2024



SUMMARY OF TEST RESULT

Report Section	FCC Rule	Description	Limit	Result	Remark
3.4	§2.1046	Conducted Output Power	Reporting Only	PASS	-
	§27.50(h)(2)	Equivalent Isotropic Radiated Power (5G NR n7, n41, n38)	EIRP < 2Watt		
3.5	N/A	Peak-to-Average Ratio	<13 dB	PASS	-
3.6	§2.1049	Occupied Bandwidth	Reporting Only	PASS	-
3.7	§27.53(m)(4)	Conducted Band Edge Measurement (5G NR n7, n41, n38)	§27.53(m)(4)	PASS	
3.8	§2.1051 §27.53(m)(4)	Conducted Spurious Emission (5G NR n7, n41, n38)	< 55+10log ₁₀ (P[Watts])	PASS	
3.9	§2.1055 §27.54	Frequency Stability Temperature & Voltage	Within Authorized Band	PASS	-
4.4	§2.1053 §27.53(m)(4)	Radiated Spurious Emission (5G NR n7, n41, n38)	< 55+10log ₁₀ (P[Watts])	PASS	Under limit 14.92 dB at 5031.41 MHz

Conformity Assessment Condition:
1. The test results (PASS/FAIL) with all measurement uncertainty excluded are presented against the regulation limits or in accordance with the requirements stipulated by the applicant/manufacture who shall bear all the risks of non-compliance that may potentially occur if measurement uncertainty is taken into account.
2. The measurement uncertainty please refer to each test result in the section "Measurement Uncertainty"
Disclaimer:
The product specifications of the EUT presented in the test report that may affect the test assessments are declared by the manufacturer who shall take full responsibility for the authenticity.



1 General Description

1.1 Applicant

Motorola Mobility LLC
222 W, Merchandise Mart Plaza,Chicago,IL60654 USA

1.2 Manufacturer

Motorola Mobility LLC
222 W, Merchandise Mart Plaza,Chicago,IL60654 USA

1.3 Product Feature of Equipment Under Test

Product Feature	
Equipment	Mobile Phone
Brand Name	Motorola
Model Name	XT2433-2, XT2433-1
FCC ID	IHDT56AS4
IMEI Code	Conducted: 356304130045015/356304130015023 Radiation: 356304130082957/ 356304130122761
HW Version	DVT2
SW Version	UOA34.101
EUT Stage	Identical Prototype

Remark:

1. The above EUT's information was declared by manufacturer. Please refer to the specifications or user's manual for more detailed description.
2. The two models are only different for market segment, all the others are same.



1.4 Product Specification of Equipment Under Test

Standards-related Product Specification	
Tx Frequency	5G NR n7 : 2500 MHz ~ 2570 MHz 5G NR n38 : 2570 MHz ~ 2620 MHz 5G NR n41 : 2496 MHz ~ 2690 MHz
Rx Frequency	5G NR n7 : 2620 MHz ~ 2690 MHz 5G NR n38: 2570 MHz ~ 2620 MHz 5G NR n41 : 2496 MHz ~ 2690 MHz
Bandwidth	n7: 5MHz / 10MHz / 15MHz / 20MHz / 25MHz / 30MHz / 40MHz / 50MHz n38: 10MHz / 15MHz / 20MHz / 25MHz / 30MHz / 40MHz n41 : 10MHz / 15MHz / 20MHz / 30MHz / 40MHz / 50MHz / 60MHz / 70MHz / 80MHz / 90MHz / 100MHz
SCS	15kHz for n7 30kHz for n38/n41
Antenna Gain	<Ant. 1> : n7: -3.2 dBi <Ant. 4> : n7: -3.1 dBi n38: -3.2 dBi n41: -3.1 dBi
Type of Modulation	CP-OFDM: QPSK / 16QAM / 64QAM / 256QAM DFT-s-OFDM: PI/2 BPSK / QPSK / 16QAM / 64QAM / 256QAM

Remark:

1. The maximum EIRP is calculated from max output power and max antenna gain, only the maximum EIRP of ANT 4 for 5G NR n7/n38/n41 are shown in the report.
2. 5G NR n7/n38/n41 support SA mode and NSA mode. According to the maximum power between SA and NSA mode, SA covers NSA mode.
3. All the supported ENDC combinations are verified conducted power, only the ENDC combination with highest power are shown in the report.
4. The EN-DC mode combination could be referred to the product spec.

1.5 Modification of EUT

No modifications are made to the EUT during all test items.



1.6 Maximum EIRP and Emission Designator

5G NR n7		PI/2 BPSK / QPSK		16QAM / 64QAM / 256QAM	
BW (MHz)	Frequency Range (MHz)	Maximum EIRP(W)	Emission Designator (99%OBW)	Maximum EIRP(W)	Emission Designator (99%OBW)
5	2502.5 ~ 2567.5	0.1194	4M48G7D	0.0995	4M50W7D
10	2505.0 ~ 2565.0	0.1169	9M30G7D	0.1005	9M31W7D
15	2507.5 ~ 2562.5	0.1178	14M1G7D	0.1000	14M1W7D
20	2510.0 ~ 2560.0	0.1153	18M9G7D	0.1005	19M0W7D
25	2512.5 ~ 2557.5	0.1183	23M7G7D	0.1002	23M7W7D
30	2515.0 ~ 2555.0	0.1189	28M6G7D	0.0995	28M6W7D
40	2520.0 ~ 2550.0	0.1178	38M6G7D	0.1000	38M7W7D
50	2525.0 ~ 2545.0	0.1230	48M1G7D	0.1028	48M2W7D
5G NR n38		PI/2 BPSK / QPSK		16QAM / 64QAM / 256QAM	
BW (MHz)	Frequency Range (MHz)	Maximum EIRP(W)	Emission Designator (99%OBW)	Maximum EIRP(W)	Emission Designator (99%OBW)
10	2575.0 ~ 2615.0	0.0927	8M58G7D	0.0782	8M59W7D
15	2577.5 ~ 2612.5	0.0923	13M6G7D	0.0789	13M6W7D
20	2580.0 ~ 2610.0	0.0927	18M2G7D	0.0767	18M3W7D
25	2582.5 ~ 2607.5	0.0920	23M2G7D	0.0773	23M3W7D
30	2585.0 ~ 2605.0	0.0946	27M9G7D	0.0733	27M9W7D
40	2590.0 ~ 2600.0	0.0942	37M9G7D	0.0841	38M0W7D
5G NR n41		PI/2 BPSK / QPSK		16QAM / 64QAM / 256QAM	
BW (MHz)	Frequency Range (MHz)	Maximum EIRP(W)	Emission Designator (99%OBW)	Maximum EIRP(W)	Emission Designator (99%OBW)
10	2501.01 ~ 2685.00	0.1016	8M58G7D	0.0953	8M59W7D
15	2503.50 ~ 2682.48	0.1007	13M6G7D	0.0863	13M6W7D
20	2506.02 ~ 2679.99	0.1028	18M2G7D	0.0959	18M3W7D
30	2511.00 ~ 2674.98	0.0993	27M9G7D	0.0942	27M9W7D
40	2516.01 ~ 2670.00	0.0995	37M9G7D	0.0948	38M0W7D
50	2521.02 ~ 2664.99	0.0971	47M3G7D	0.0925	47M5W7D
60	2526.00 ~ 2659.98	0.0977	57M9G7D	0.0796	57M9W7D
70	2531.01 ~ 2655.00	0.0975	67M9G7D	0.0861	67M9W7D
80	2536.02 ~ 2649.99	0.0979	77M5G7D	0.0899	77M7W7D
90	2541.00 ~ 2644.98	0.0982	87M4G7D	0.0855	87M5W7D
100	2546.01 ~ 2640.00	0.1062	97M3G7D	0.0847	97M4W7D

Note:

- 5G NR n41 overlaps the entire frequency range of 5G NR n38. Therefore, the test results provided in this report covers 5G NR n41 as well as 5G NR n38, except 25MHz for n38 is full tested.
- All modulations have been tested, only the worst test results of PSK & QAM are shown in the report.



1.7 Testing Location

Sporton International Inc. (Kunshan) is accredited to ISO/IEC 17025:2017 by American Association for Laboratory Accreditation with Certificate Number 5145.02.

Test Firm	Sporton International Inc. (Kunshan)		
Test Site Location	No. 1098, Pengxi North Road, Kunshan Economic Development Zone Jiangsu Province 215300 People's Republic of China TEL : +86-512-57900158		
Test Site No.	Sporton Site No.	FCC Designation No.	FCC Test Firm Registration No.
	TH01-KS	CN1257	314309

Sporton International Inc. (ShenZhen) is accredited to ISO/IEC 17025:2017 by American Association for Laboratory Accreditation with Certificate Number 5145.01.

Test Firm	Sporton International Inc. (ShenZhen)		
Test Site Location	101, 1st Floor, Block B, Building 1, No. 2, Tengfeng 4th Road, Fenghuang Community, Fuyong Street, Baoan District, Shenzhen City, Guangdong Province 518103 People's Republic of China TEL: +86-755-86066985		
Test Site No.	Sporton Site No.	FCC Designation No.	FCC Test Firm Registration No.
	03CH03-SZ	CN1256	421272

1.8 Test Software

Item	Site	Manufacture	Name	Version
1.	TH01-KS	Tonscend	JS1120-3 test system China_210602	3.3.10
2.	03CH03-SZ	AUDIX	E3	6.2009-8-24



1.9 Applicable Standards

According to the specifications of the manufacturer, the EUT must comply with the requirements of the following standards:

- 47 CFR Part 2, 27
- ANSI C63.26-2015
- FCC KDB 971168 D01 Power Meas License Digital Systems v03r01
- FCC KDB 412172 D01 Determining ERP and EIRP v01r01

Remark:

All test items were verified and recorded according to the standards and without any deviation during the test.

1.10 Specification of Accessory

Specification of Accessory				
AC Adapter 1(US)	Brand Name	Motorola(AOHAI)	Model Name	MC-201L
AC Adapter 1(EU)	Brand Name	Motorola(AOHAI)	Model Name	MC-202L
AC Adapter 1(UK)	Brand Name	Motorola(AOHAI)	Model Name	MC-203L
AC Adapter 1(IN)	Brand Name	Motorola(AOHAI)	Model Name	MC-204
AC Adapter 1(AU)	Brand Name	Motorola(AOHAI)	Model Name	MC-205L
AC Adapter 1(AR)	Brand Name	Motorola(AOHAI)	Model Name	MC-206L
AC Adapter 2(US)	Brand Name	Motorola(Salcomp)	Model Name	MC-201L
AC Adapter 2(EU)	Brand Name	Motorola(Salcomp)	Model Name	MC-202L
AC Adapter 2(UK)	Brand Name	Motorola(Salcomp)	Model Name	MC-203L
AC Adapter 2(AU)	Brand Name	Motorola(Salcomp)	Model Name	MC-205L
AC Adapter 2(AR)	Brand Name	Motorola(Salcomp)	Model Name	MC-206L
AC Adapter 2(Chile)	Brand Name	Motorola(Salcomp)	Model Name	MC-209L
AC Adapter 3(US)	Brand Name	Motorola(Chenyang)	Model Name	MC-201L
AC Adapter 3(EU)	Brand Name	Motorola(Chenyang)	Model Name	MC-202L
AC Adapter 3(AR)	Brand Name	Motorola(Chenyang)	Model Name	MC-206L
AC Adapter 3(BR)	Brand Name	Motorola(Chenyang)	Model Name	MC-207L
AC Adapter 4(BR)	Brand Name	Motorola(Cliptech)	Model Name	MC-207L
AC Adapter 5(IN)	Brand Name	Motorola(XIHI)	Model Name	MC-204
Battery 1	Brand Name	Motorola(ATL)	Model Name	QG50
Battery 2	Brand Name	Motorola(Sunwoda)	Model Name	QG50
Battery 3	Brand Name	Motorola(JIADE)	Model Name	QG50
USB Cable 1	Brand Name	Saibao	Model Name	SZN-A026A
USB Cable 2	Brand Name	Juwei	Model Name	JWUB1606-ZN01H



2 Test Configuration of Equipment Under Test

2.1 Test Mode

Antenna port conducted and radiated test items are performed according to KDB 971168 D01 Power Meas License Digital Systems v03r01 with maximum output power.

For radiated measurement, pre-scanned in three orthogonal panels, X, Y, Z. The worst cases (Z plane) were recorded in this report.

The device is investigated from 30MHz to 10 times of fundamental signal for radiated spurious emission test under different RB size/offset and modulations in exploratory test. Subsequently, only the worst case emissions are reported.

Orthogonal Planes of EUT	X Plane	Y Plane	Z Plane
			

Test Items	5G NR	Bandwidth (MHz)														Modulation					RB #		Test Channel		
		5	10	15	20	25	30	40	50	60	70	80	90	100	PI/2 BPSK	QPSK	16 QAM	64 QAM	256 QAM	1	Full	L	M	H	
Max. Output Power	n7	v	v	v	v	v	v	v	v	-	-	-	-	-	v	v	v	v	v	v	v	v	v	v	v
	n38	-	v	v	v	v	v	v	-	-	-	-	-	-	v	v	v	v	v	v	v	v	v	v	v
	n41	-	v	v	v	-	v	v	v	v	v	v	v	v	v	v	v	v	v	v	v	v	v	v	v
Peak-to-Average Ratio	n7				v					-	-	-	-	-	v	v				v	v		v		
	n38	-				v				-	-	-	-	-	v	v				v	v		v		
	n41	-			v	-									v	v				v	v		v		
26dB and 99% Bandwidth	n7	v	v	v	v	v	v	v	v	-	-	-	-	-		v	v	v	v		v		v		
	n38	-				v				-	-	-	-	-		v	v	v	v		v		v		
	n41	-	v	v	v	-	v	v	v	v	v	v	v	v		v	v	v	v		v		v		
Conducted Band Edge	n7	v				v			v	-	-	-	-	-	v	v				v	v	v		v	
	n38	-				v				-	-	-	-	-	v	v				v	v	v		v	
	n41	-	v			-			v						v	v				v	v	v		v	
Conducted Spurious Emission	n7	v				v			v	-	-	-	-	-	v	v				v		v	v	v	
	n38	-				v				-	-	-	-	-	v	v				v		v	v	v	
	n41	-	v			-			v						v	v				v		v	v	v	
Frequency Stability	n7				v					-	-	-	-	-	v						v		v		
	n38	-				v				-	-	-	-	-	v						v		v		
	n41	-			v	-									v						v		v		
E.I.R.P.	n7	v	v	v	v	v	v	v	v	-	-	-	-	-	v	v	v	v	v	v	v	v	v	v	
	n38	-	v	v	v	v	v	v	-	-	-	-	-	-	v	v	v	v	v	v	v	v	v	v	
	n41	-	v	v	v	-	v	v	v	v	v	v	v	v	v	v	v	v	v	v	v	v	v	v	



Test Items	5G NR	Bandwidth (MHz)													Modulation					RB #		Test Channel				
		5	10	15	20	25	30	40	50	60	70	80	90	100	PI/2 BPSK	QPSK	16 QAM	64 QAM	256 QAM	1	Full	L	M	H		
Radiated Spurious Emission	n7	Worst Case																							v	
	n41	Worst Case																							v	
Note	1. The mark "v " means that this configuration is chosen for testing 2. The mark "-" means that this bandwidth is not supported. 3. The device is investigated from 30MHz to 10 times of fundamental signal for radiated spurious emission test under different RB size/offset and modulations in exploratory test. Subsequently, only the worst case emissions are reported. 4. Frequency Stability : Normal Voltage = 3.91V ; Low Voltage =3.60V. ; High Voltage =4.50V																									

2.2 Connection Diagram of Test System

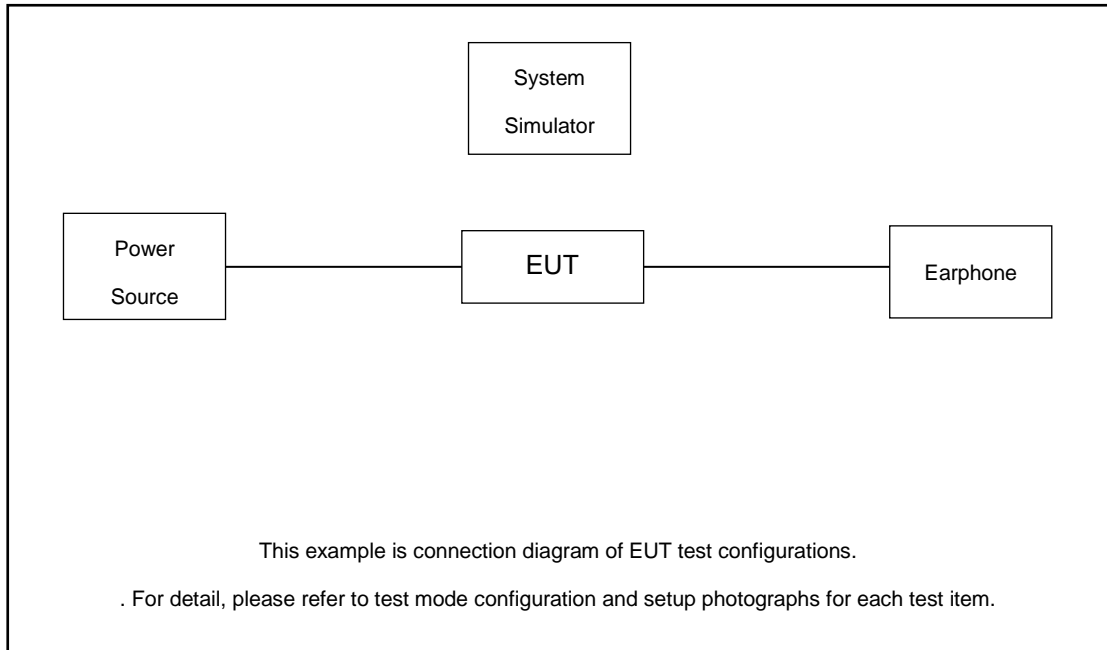

The EUT has been configuration operated in a manner tended to maximize its emission characteristics in a typical application.

2.3 Support Unit used in test configuration and system

Item	Equipment	Trade Name	Model No.	FCC ID	Data Cable	Power Cord
1.	DC Power Supply	GW	GPS-3030D	N/A	N/A	Unshielded, 1.8 m
2.	LTE Base Station	Anritsu	MT8821C	N/A	N/A	Unshielded, 1.8 m
3.	NR Base Station	Anritsu	MT8000A	N/A	N/A	Unshielded, 1.8 m

2.4 Measurement Results Explanation Example

For all conducted test items:

The offset level is set in the spectrum analyzer to compensate the RF cable loss and attenuator factor between EUT conducted output port and spectrum analyzer. With the offset compensation, the spectrum analyzer reading level is exactly the EUT RF output level.

The spectrum analyzer offset is derived from RF cable loss and attenuator factor.

Offset = RF cable loss + attenuator factor.

Following shows an offset computation example with cable loss 6.4 dB and 10dB attenuator.

Example :

Offset(dB) = RF cable loss(dB) + attenuator factor(dB).

$$= 6.4 + 10 = 16.4 \text{ (dB)}$$



2.5 Frequency List of Low/Middle/High Channels

5G NR n7 Channel and Frequency List				
BW [MHz]	Channel/Frequency(MHz)	Lowest	Middle	Highest
50	Channel	505000	507000	509000
	Frequency	2525	2535	2545
40	Channel	504000	507000	510000
	Frequency	2520	2535	2550
30	Channel	503000	507000	511000
	Frequency	2515	2535	2555
25	Channel	502500	507000	511500
	Frequency	2512.5	2535	2557.5
20	Channel	502000	507000	512000
	Frequency	2510	2535	2560
15	Channel	501500	507000	512500
	Frequency	2507.5	2535	2562.5
10	Channel	501000	507000	513000
	Frequency	2505	2535	2565
5	Channel	500500	507000	513500
	Frequency	2502.5	2535	2567.5

5G NR n38 Channel and Frequency List				
BW [MHz]	Channel/Frequency(MHz)	Lowest	Middle	Highest
40	Channel	518000	519000	520000
	Frequency	2590	2595	2600
30	Channel	517000	519000	521000
	Frequency	2585	2595	2605
25	Channel	516500	519000	521500
	Frequency	2582.5	2595	2607.5
20	Channel	516000	519000	522000
	Frequency	2580	2595	2610
15	Channel	515500	519000	522500
	Frequency	2577.5	2595	2612.5
10	Channel	515000	519000	523000
	Frequency	2575	2595	2615



5G NR n41 Channel and Frequency List for SCS 30k				
BW [MHz]	Channel/Frequency(MHz)	Lowest	Middle	Highest
100	Channel	509202	518598	528000
	Frequency	2546.01	2592.99	2640
90	Channel	508200	518598	528996
	Frequency	2541	2592.99	2644.98
80	Channel	507204	518598	529998
	Frequency	2536.02	2592.99	2649.99
70	Channel	506202	518598	531000
	Frequency	2531.01	2592.99	2655
60	Channel	505200	518598	531996
	Frequency	2526	2592.99	2659.98
50	Channel	504204	518598	532998
	Frequency	2521.02	2592.99	2664.99
40	Channel	503202	518598	534000
	Frequency	2516.01	2592.99	2670
30	Channel	502200	518598	534996
	Frequency	2511	2592.99	2674.98
20	Channel	501204	518598	535998
	Frequency	2506.02	2592.99	2679.99
15	Channel	500700	518598	536496
	Frequency	2503.5	2592.99	2682.48
10	Channel	500202	518598	537000
	Frequency	2501.01	2592.99	2685

3 Conducted Test Items

3.1 Measuring Instruments

See list of measuring instruments of this test report.

3.2 Test Setup

3.2.1 Conducted Output Power



3.2.2 Peak-to-Average Ratio, Occupied Bandwidth ,Conducted Band-Edge and Conducted Spurious Emission

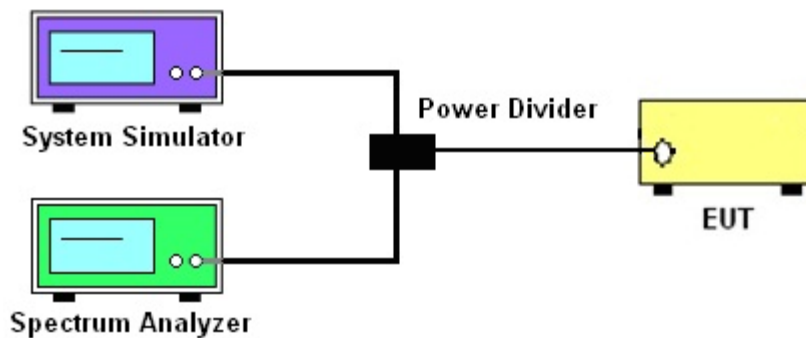

3.2.3 Frequency Stability



3.3 Test Result of Conducted Test

Please refer to Appendix A.



3.4 Conducted Output Power and EIRP

3.4.1 Description of the Conducted Output Power Measurement and EIRP Measurement

A system simulator was used to establish communication with the EUT. Its parameters were set to force the EUT transmitting at maximum output power. The measured power in the radio frequency on the transmitter output terminals shall be reported.

The EIRP of mobile transmitters must not exceed 2 Watts for 5G NR n7, n38, n41.

According to KDB 412172 D01 Power Approach,

$EIRP = P_T + G_T - L_C$, $ERP = EIRP - 2.15$, where

P_T = transmitter output power in dBm

G_T = gain of the transmitting antenna in dBi

L_C = signal attenuation in the connecting cable between the transmitter and antenna in dB

3.4.2 Test Procedures

1. The testing follows ANSI C63.26 Section 5.2
2. The transmitter output port was connected to the system simulator.
3. Set EUT at maximum power through the system simulator.
4. Select lowest, middle, and highest channels for each band and different modulation.
5. Measure and record the power level from the system simulator.



3.5 Peak-to-Average Ratio

3.5.1 Description of the PAR Measurement

Power Complementary Cumulative Distribution Function (CCDF) curves provide a means for characterizing the power peaks of a digitally modulated signal on a statistical basis. A CCDF curve depicts the probability of the peak signal amplitude exceeding the average power level. Most contemporary measurement instrumentation include the capability to produce CCDF curves for an input signal provided that the instrument's resolution bandwidth can be set wide enough to accommodate the entire input signal bandwidth. In measuring transmissions in this band using an average power technique, the peak-to-average ratio (PAR) of the transmission may not exceed 13 dB.

3.5.2 Test Procedures

1. The testing follows ANSI C63.26 Section 5.2.3.4 (CCDF).
2. The EUT was connected to spectrum and system simulator via a power divider.
3. Set the CCDF (Complementary Cumulative Distribution Function) option in spectrum analyzer.
4. The highest RF powers were measured and recorded the maximum PAPR level associated with a probability of 0.1 %.
5. Record the deviation as Peak to Average Ratio.



3.6 Occupied Bandwidth

3.6.1 Description of Occupied Bandwidth Measurement

The occupied bandwidth is the width of a frequency band such that, below the lower and above the upper frequency limits, the mean powers emitted are each equal to a specified percentage 0.5% of the total mean transmitted power.

The 26 dB emission bandwidth is defined as the frequency range between two points, one above and one below the carrier frequency, at which the spectral density of the emission is attenuated 26 dB below the maximum in-band spectral density of the modulated signal. Spectral density (power per unit bandwidth) is to be measured with a detector of resolution bandwidth equal to approximately 1.0% of the emission bandwidth.

3.6.2 Test Procedures

1. The testing follows ANSI C63.26 Section 5.4
2. The EUT was connected to spectrum analyzer and system simulator via a power divider.
3. The spectrum analyzer center frequency is set to the nominal EUT channel center frequency. The span range for the spectrum analyzer shall be between two and five times the anticipated OBW.
4. The nominal resolution bandwidth (RBW) shall be in the range of 1 to 5 % of the anticipated OBW, and the VBW shall be at least 3 times the RBW.
5. Set the detection mode to peak, and the trace mode to max hold.
6. Determine the reference value: Set the EUT to transmit a modulated signal. Allow the trace to stabilize. Set the spectrum analyzer marker to the highest level of the displayed trace.
(this is the reference value)
7. Determine the “-26 dB down amplitude” as equal to (Reference Value – X).
8. Place two markers, one at the lowest and the other at the highest frequency of the envelope of the spectral display such that each marker is at or slightly below the “-X dB down amplitude” determined in step 6. If a marker is below this “-X dB down amplitude” value it shall be placed as close as possible to this value. The OBW is the positive frequency difference between the two markers.
9. Use the 99 % power bandwidth function of the spectrum analyzer and report the measured bandwidth.



3.7 Conducted Band Edge

3.7.1 Description of Conducted Band Edge Measurement

27.53(m)(4)

For mobile digital stations, the attenuation factor shall be not less than $40 + 10 \log (P)$ dB on all frequencies between the channel edge and 5 megahertz from the channel edge, $43 + 10 \log (P)$ dB on all frequencies between 5 megahertz and X megahertz from the channel edge, and $55 + 10 \log (P)$ dB on all frequencies more than X megahertz from the channel edge, where X is the greater of 6 megahertz or the actual emission bandwidth as defined in paragraph (m)(6) of this section. In addition, the attenuation factor shall not be less that $43 + 10 \log (P)$ dB on all frequencies between 2490.5 MHz and 2496 MHz and $55 + 10 \log (P)$ dB at or below 2490.5 MHz. Mobile Satellite Service licensees operating on frequencies below 2495 MHz may also submit a documented interference complaint against BRS licensees operating on channel BRS Channel 1 on the same terms and conditions as adjacent channel BRS or EBS licensees.

3.7.2 Test Procedures

1. The testing follows ANSI C63.26 section 5.7
2. The EUT was connected to spectrum analyzer and system simulator via a power divider.
3. The band edges of low and high channels for the highest RF powers were measured.
4. Set RBW \geq 1% EBW in the 1MHz band immediately outside and adjacent to the band edge.
5. Beyond the 1 MHz band from the band edge, RBW=1MHz was used or a narrower RBW was used (generally limited to no less than 1% of the OBW) and the measured power was integrated over the full required measurement bandwidth.
6. Set spectrum analyzer with RMS detector.
7. The RF fundamental frequency should be excluded against the limit line in the operating frequency band.
8. Checked that all the results comply with the emission limit line.
9. When using the integration method, the starting frequency of the integration shall be centered at one-half of the RBW away from the band edge.



3.8 Conducted Spurious Emission

3.8.1 Description of Conducted Spurious Emission Measurement

For 5G NR n7/n38/n41:

The power of any emission outside of the authorized operating frequency ranges must be lower than the transmitter power (P) by a factor of at least $55 + 10 \log (P)$ dB.

It is measured by means of a calibrated spectrum analyzer and scanned from 30 MHz up to a frequency including its 10th harmonic.

3.8.2 Test Procedures

1. The testing follows ANSI C63.26 section 5.7
2. The EUT was connected to spectrum analyzer and system simulator via a power divider.
3. The RF output of EUT was connected to the spectrum analyzer by RF cable and attenuator. The path loss was compensated to the results for each measurement.
4. The middle channel for the highest RF power within the transmitting frequency was measured.
5. The conducted spurious emission for the whole frequency range was taken.
6. Make the measurement with the spectrum analyzer's RBW = 1MHz, VBW = 3MHz.
7. Set spectrum analyzer with RMS detector.
8. Taking the record of maximum spurious emission.
9. The RF fundamental frequency should be excluded against the limit line in the operating frequency band.

10. For 5G NR n7/n38/n41

The limit line is derived from $55 + 10\log(P)$ dB below the transmitter power P(Watts)
= P(W)- [55+ 10log(P)] (dB)
= [30+ 10log(P)] (dBm) - [55+ 10log(P)] (dB)
= -25dBm.



3.9 Frequency Stability

3.9.1 Description of Frequency Stability Measurement

The frequency stability shall be measured by variation of ambient temperature and variation of primary supply voltage to ensure that the fundamental emission stays within the authorized frequency block. The frequency stability of the transmitter shall be maintained within $\pm 0.00025\%$ ($\pm 2.5\text{ppm}$) of the center frequency.

3.9.2 Test Procedures for Temperature Variation

1. The testing follows ANSI C63.26 section 5.6.4
2. The EUT was set up in the thermal chamber and connected with the system simulator.
3. With power OFF, the temperature was decreased to -30°C and the EUT was stabilized before testing. Power was applied and the maximum change in frequency was recorded within one minute.
4. With power OFF, the temperature was raised in 10°C step up to 50°C . The EUT was stabilized at each step for at least half an hour. Power was applied and the maximum frequency change was recorded within one minute.

3.9.3 Test Procedures for Voltage Variation

1. The testing follows ANSI C63.26 section 5.6.5
2. The EUT was placed in a temperature chamber at $20\pm 5^{\circ}\text{C}$ and connected with the system simulator.
3. The power supply voltage to the EUT was varied from 85% to 115% of the nominal value for other than hand carried battery equipment.
4. For hand carried, battery powered equipment, reduce the primary ac or dc supply voltage to the battery operating end point, which shall be specified by the manufacturer.
5. The variation in frequency was measured for the worst case.

4 Radiated Test Items

4.1 Measuring Instruments

See list of measuring instruments of this test report.

4.2 Test Setup

4.2.1 For radiated test below 30MHz

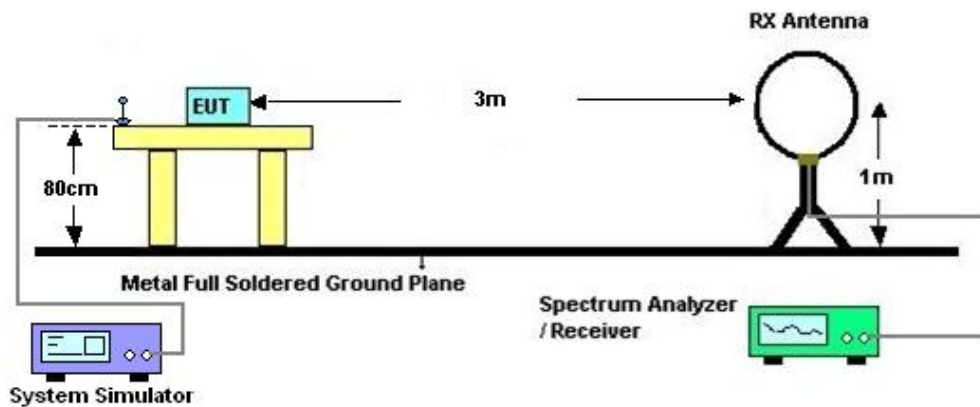

4.2.2 For radiated test from 30MHz to 1GHz

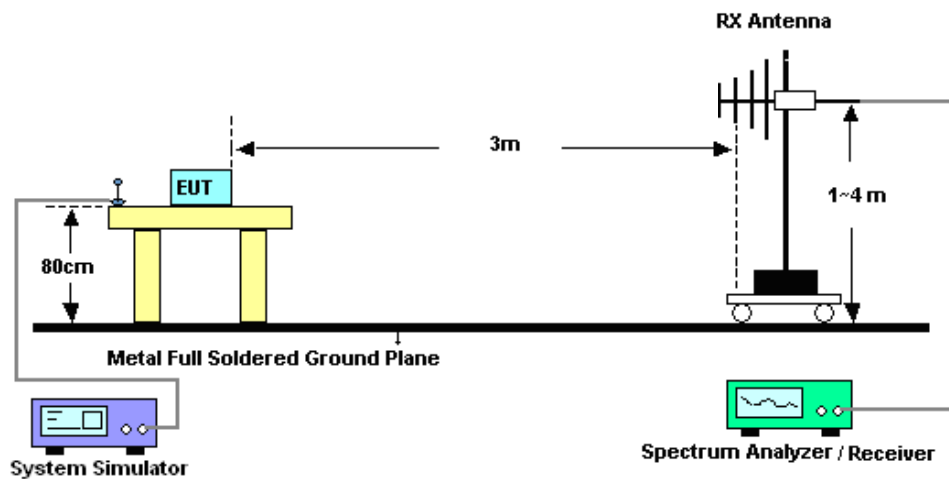

4.2.3 For radiated test above 1GHz

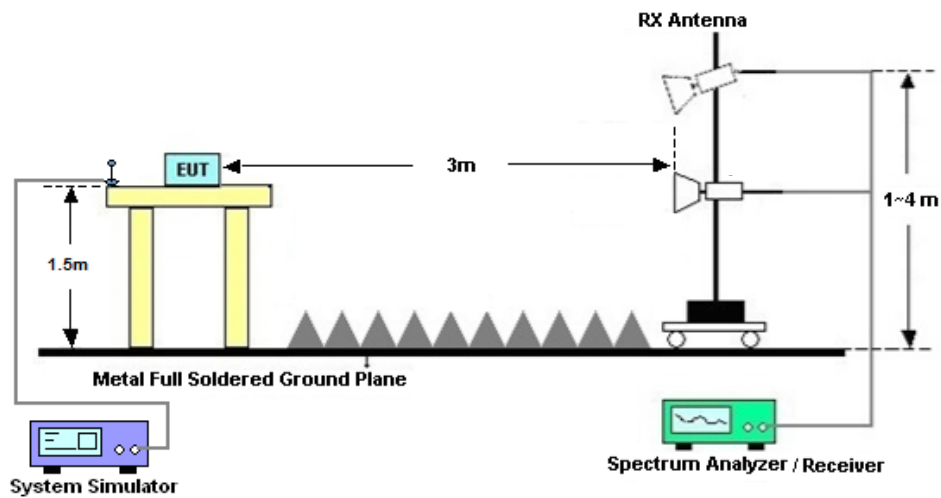

4.3 Test Result of Radiated Test

The low frequency, which started from 9 kHz to 30MHz, was pre-scanned and the result which was 20dB lower than the limit line was not reported.

Please refer to Appendix B.



4.4 Radiated Spurious Emission

4.4.1 Description of Radiated Spurious Emission

For 5G NR n7/n38/n41

The power of any emission outside of the authorized operating frequency ranges must be attenuated below the transmitter power (P) by a factor of at least $55 + 10 \log (P)$ dB.

The spectrum is scanned from 30 MHz up to a frequency including its 10th harmonic.

4.4.2 Test Procedures

1. The testing follows ANSI C63.26 Section 5.5
2. The EUT was placed on a turntable with 0.8 meter height for frequency below 1GHz and 1.5 meter height for frequency above 1GHz respectively above ground.
3. The EUT was set 3 meters from the receiving antenna mounted on the antenna tower.
4. The table was rotated 360 degrees to determine the position of the highest spurious emission.
5. The height of the receiving antenna is varied between 1m to 4m to search the maximum spurious emission for both horizontal and vertical polarizations.
6. During the measurement, the system simulator parameters were set to force the EUT transmitting at maximum output power.
7. Make the measurement with the spectrum analyzer's RBW = 1MHz, VBW = 3MHz, taking the record of maximum spurious emission.
8. A horn antenna was substituted in place of the EUT and was driven by a signal generator.
9. Tune the output power of signal generator to the same emission level with EUT maximum spurious emission.
10. $EIRP \text{ (dBm)} = S.G. \text{ Power} - Tx \text{ Cable Loss} + Tx \text{ Antenna Gain}$
11. $ERP \text{ (dBm)} = EIRP - 2.15$
12. The RF fundamental frequency should be excluded against the limit line in the operating frequency band.

For 5G NR n7/n38/n41:

The limit line is derived from $55 + 10\log(P)$ dB below the transmitter power P(Watts)The limit line is derived from $55 + 10\log(P)$ dB below the transmitter power P(Watts)



5 List of Measuring Equipment

Instrument	Manufacturer	Model No.	Serial No.	Characteristics	Calibration Date	Test Date	Due Date	Remark
Spectrum Analyzer	R&S	FSV40	101040	10Hz~40GHz	Oct. 11, 2023	May 03, 2024~ May 28, 2024	Oct. 10, 2024	Conducted (TH01-KS)
Power divider	STI	STI08-0055	-	0.5~40GHz	NCR	May 03, 2024~ May 28, 2024	NCR	Conducted (TH01-KS)
Temperature & humidity chamber	Hongzhan	LP-150U	H2014011440	-40~+150°C 20%~95%RH	Jul. 06, 2023	May 03, 2024~ May 28, 2024	Jul. 05, 2024	Conducted (TH01-KS)
EMI Test Receiver&SA	KEYSIGHT	N9038A	MY54450083	20Hz~8.4GHz	Apr. 09, 2024	Jun. 25, 2024	Apr. 08, 2025	Radiation (03CH03-SZ)
EXA Spectrum Analyzer	KEYSIGHT	N9010A	MY55150246	10Hz~44GHz;	Apr. 09, 2024	Jun. 25, 2024	Apr. 08, 2025	Radiation (03CH03-SZ)
Loop Antenna	R&S	HFH2-Z2	100354	9kHz~30MHz	Jun. 28, 2022	Jun. 25, 2024	Jun. 27, 2024	Radiation (03CH03-SZ)
Bilog Antenna	TeseQ	CBL6112D	35408	30MHz-2GHz	Aug. 20, 2023	Jun. 25, 2024	Aug. 19, 2025	Radiation (03CH03-SZ)
Double Ridge Horn Antenna	SCHWARZBECK	BBHA9120D	9120D-1355	1GHz~18GHz	Apr. 09, 2024	Jun. 25, 2024	Apr. 08, 2025	Radiation (03CH03-SZ)
SHF-EHF Horn	com-power	AH-840	101071	18Ghz-40GHz	Apr. 09, 2024	Jun. 25, 2024	Apr. 08, 2025	Radiation (03CH03-SZ)
Amplifier	Burgeon	BPA-530	102211	0.01Hz ~3000MHz	Oct. 18, 2023	Jun. 25, 2024	Oct. 17, 2024	Radiation (03CH03-SZ)
HF Amplifier	MITEQ	TTA1840-35-HG	1871923	18GHz~40GHz	Jul. 07, 2023	Jun. 25, 2024	Jul.06, 2024	Radiation (03CH03-SZ)
Amplifier	Agilent Technologies	83017A	MY39501302	500MHz~26.5GHz	Dec. 27, 2023	Jun. 25, 2024	Dec. 26, 2024	Radiation (03CH03-SZ)
AC Power Source	Chroma	61601	616010002729	N/A	Oct. 18, 2023	Jun. 25, 2024	Oct. 17, 2024	Radiation (03CH03-SZ)
Turn Table	EM	EM1000	N/A	0~360 degree	NCR	Jun. 25, 2024	NCR	Radiation (03CH03-SZ)
Antenna Mast	EM	EM1000	N/A	1 m~4 m	NCR	Jun. 25, 2024	NCR	Radiation (03CH03-SZ)

NCR: No Calibration Required



6 Measurement Uncertainty

The measurement uncertainties shown below were calculated in accordance with the requirements of ANSI 63.26-2015. All the measurement uncertainty value were shown with a coverage K=2 to indicate 95% level of confidence. The measurement data show herein meets or exceeds the CISPR measurement uncertainty values specified in CISPR 16-4-2 and can be compared directly to specified limit to determine compliance.

Uncertainty of Conducted Measurement

Conducted Spurious Emission & Bandedge	±2.26 dB
Occupied Channel Bandwidth	±0.1%
Conducted Power	±0.46 dB
Peak to Average Ratio	±0.46 dB
Frequency Stability	±0.4 Hz

Uncertainty of Radiated Emission Measurement (30 MHz ~ 1 GHz)

Measuring Uncertainty for a Level of Confidence of 95% (U = 2Uc(y))	3.0 dB
---	--------

Uncertainty of Radiated Emission Measurement (1 GHz ~ 18 GHz)

Measuring Uncertainty for a Level of Confidence of 95% (U = 2Uc(y))	3.6 dB
---	--------

Uncertainty of Radiated Emission Measurement (18 GHz ~ 40 GHz)

Measuring Uncertainty for a Level of Confidence of 95% (U = 2Uc(y))	3.8 dB
---	--------

----- THE END -----



Appendix A. Test Results of Conducted Test

Test Engineer :	Simle Wang	Temperature :	22~23°C
		Relative Humidity :	40~42%



FR1 N7 (ANT4)

Transmitter Conducted Output Power And EIRP, (GT - LC)= -3.1dB

NR Band	SCS	BandWidth	Arfcn	Freq(MHz)	Modulation	RB	Conducted Power(dBm)	EIRP (dBm)	EIRP (W)
7	15	50	505000	2525	DFT-s-OFDM PI/2 BPSK	135@67	23.39	20.29	0.1069
7	15	50	505000	2525	DFT-s-OFDM PI/2 BPSK	1@1	23.6	20.5	0.1122
7	15	50	505000	2525	DFT-s-OFDM PI/2 BPSK	1@268	23.52	20.42	0.1102
7	15	50	505000	2525	DFT-s-OFDM QPSK	135@67	23.55	20.45	0.1109
7	15	50	505000	2525	DFT-s-OFDM QPSK	1@1	23.82	20.72	0.1180
7	15	50	505000	2525	DFT-s-OFDM QPSK	1@268	23.73	20.63	0.1156
7	15	50	505000	2525	DFT-s-OFDM 16 QAM	135@67	22.63	19.53	0.0897
7	15	50	505000	2525	DFT-s-OFDM 16 QAM	1@1	23.07	19.97	0.0993
7	15	50	505000	2525	DFT-s-OFDM 16 QAM	1@268	23.03	19.93	0.0984
7	15	50	505000	2525	DFT-s-OFDM 64 QAM	135@67	20.79	17.69	0.0587
7	15	50	505000	2525	DFT-s-OFDM 64 QAM	1@1	20.69	17.59	0.0574
7	15	50	505000	2525	DFT-s-OFDM 64 QAM	1@268	20.87	17.77	0.0598
7	15	50	505000	2525	DFT-s-OFDM 256 QAM	135@67	19.53	16.43	0.0440
7	15	50	505000	2525	DFT-s-OFDM 256 QAM	1@1	19.47	16.37	0.0434
7	15	50	505000	2525	DFT-s-OFDM 256 QAM	1@268	19.64	16.54	0.0451
7	15	50	505000	2525	CP-OFDM QPSK	135@67	22.3	19.2	0.0832
7	15	50	505000	2525	CP-OFDM QPSK	1@1	22.24	19.14	0.0820
7	15	50	505000	2525	CP-OFDM QPSK	1@268	22.38	19.28	0.0847
7	15	50	507000	2535	DFT-s-OFDM PI/2 BPSK	135@67	23.45	20.35	0.1084
7	15	50	507000	2535	DFT-s-OFDM PI/2 BPSK	1@1	23.17	20.07	0.1016
7	15	50	507000	2535	DFT-s-OFDM PI/2 BPSK	1@268	23.53	20.43	0.1104
7	15	50	507000	2535	DFT-s-OFDM QPSK	135@67	23.66	20.56	0.1138
7	15	50	507000	2535	DFT-s-OFDM QPSK	1@1	23.43	20.33	0.1079
7	15	50	507000	2535	DFT-s-OFDM QPSK	1@268	23.69	20.59	0.1146
7	15	50	507000	2535	DFT-s-OFDM 16 QAM	135@67	22.71	19.61	0.0914
7	15	50	507000	2535	DFT-s-OFDM 16 QAM	1@1	23.02	19.92	0.0982
7	15	50	507000	2535	DFT-s-OFDM 16 QAM	1@268	23.11	20.01	0.1002
7	15	50	507000	2535	DFT-s-OFDM 64 QAM	135@67	21.02	17.92	0.0619
7	15	50	507000	2535	DFT-s-OFDM 64 QAM	1@1	22.01	18.91	0.0778
7	15	50	507000	2535	DFT-s-OFDM 64 QAM	1@268	21.68	18.58	0.0721
7	15	50	507000	2535	DFT-s-OFDM 256 QAM	135@67	19.53	16.43	0.0440
7	15	50	507000	2535	DFT-s-OFDM 256 QAM	1@1	20.57	17.47	0.0558
7	15	50	507000	2535	DFT-s-OFDM 256 QAM	1@268	20.22	17.12	0.0515
7	15	50	507000	2535	CP-OFDM QPSK	135@67	22.34	19.24	0.0839
7	15	50	507000	2535	CP-OFDM QPSK	1@1	22.3	19.2	0.0832
7	15	50	507000	2535	CP-OFDM QPSK	1@268	22.34	19.24	0.0839
7	15	50	509000	2545	DFT-s-OFDM PI/2 BPSK	135@67	23.36	20.26	0.1062
7	15	50	509000	2545	DFT-s-OFDM PI/2 BPSK	1@1	23.73	20.63	0.1156
7	15	50	509000	2545	DFT-s-OFDM PI/2 BPSK	1@268	23.59	20.49	0.1119



7	15	50	509000	2545	DFT-s-OFDM QPSK	135@67	23.53	20.43	0.1104
7	15	50	509000	2545	DFT-s-OFDM QPSK	1@1	24	20.9	0.1230
7	15	50	509000	2545	DFT-s-OFDM QPSK	1@268	23.77	20.67	0.1167
7	15	50	509000	2545	DFT-s-OFDM 16 QAM	135@67	22.62	19.52	0.0895
7	15	50	509000	2545	DFT-s-OFDM 16 QAM	1@1	23.22	20.12	0.1028
7	15	50	509000	2545	DFT-s-OFDM 16 QAM	1@268	23.02	19.92	0.0982
7	15	50	509000	2545	DFT-s-OFDM 64 QAM	135@67	19.98	16.88	0.0488
7	15	50	509000	2545	DFT-s-OFDM 64 QAM	1@1	21.05	17.95	0.0624
7	15	50	509000	2545	DFT-s-OFDM 64 QAM	1@268	19.8	16.7	0.0468
7	15	50	509000	2545	DFT-s-OFDM 256 QAM	135@67	18.84	15.74	0.0375
7	15	50	509000	2545	DFT-s-OFDM 256 QAM	1@1	19.92	16.82	0.0481
7	15	50	509000	2545	DFT-s-OFDM 256 QAM	1@268	18.63	15.53	0.0357
7	15	50	509000	2545	CP-OFDM QPSK	135@67	22.29	19.19	0.0830
7	15	50	509000	2545	CP-OFDM QPSK	1@1	22.34	19.24	0.0839
7	15	50	509000	2545	CP-OFDM QPSK	1@268	22.33	19.23	0.0838
7	15	5	500500	2502.5	DFT-s-OFDM PI/2 BPSK	1@1	23.51	20.41	0.1099
7	15	5	500500	2502.5	DFT-s-OFDM QPSK	1@1	23.67	20.57	0.1140
7	15	5	500500	2502.5	DFT-s-OFDM 16 QAM	1@1	23.02	19.92	0.0982
7	15	5	507000	2535	DFT-s-OFDM PI/2 BPSK	1@1	23.63	20.53	0.1130
7	15	5	507000	2535	DFT-s-OFDM QPSK	1@1	23.87	20.77	0.1194
7	15	5	507000	2535	DFT-s-OFDM 16 QAM	1@1	23.08	19.98	0.0995
7	15	5	513500	2567.5	DFT-s-OFDM PI/2 BPSK	1@1	23.4	20.3	0.1072
7	15	5	513500	2567.5	DFT-s-OFDM QPSK	1@1	23.66	20.56	0.1138
7	15	5	513500	2567.5	DFT-s-OFDM 16 QAM	1@1	22.89	19.79	0.0953
7	15	10	501000	2505	DFT-s-OFDM PI/2 BPSK	1@1	23.42	20.32	0.1076
7	15	10	501000	2505	DFT-s-OFDM QPSK	1@1	23.6	20.5	0.1122
7	15	10	501000	2505	DFT-s-OFDM 16 QAM	1@1	22.97	19.87	0.0971
7	15	10	507000	2535	DFT-s-OFDM PI/2 BPSK	1@1	23.54	20.44	0.1107
7	15	10	507000	2535	DFT-s-OFDM QPSK	1@1	23.78	20.68	0.1169
7	15	10	507000	2535	DFT-s-OFDM 16 QAM	1@1	23.12	20.02	0.1005
7	15	10	513000	2565	DFT-s-OFDM PI/2 BPSK	1@1	23.41	20.31	0.1074
7	15	10	513000	2565	DFT-s-OFDM QPSK	1@1	23.58	20.48	0.1117
7	15	10	513000	2565	DFT-s-OFDM 16 QAM	1@1	22.93	19.83	0.0962
7	15	15	501500	2507.5	DFT-s-OFDM PI/2 BPSK	1@1	23.4	20.3	0.1072
7	15	15	501500	2507.5	DFT-s-OFDM QPSK	1@1	23.6	20.5	0.1122
7	15	15	501500	2507.5	DFT-s-OFDM 16 QAM	1@1	23.1	20	0.1000
7	15	15	507000	2535	DFT-s-OFDM PI/2 BPSK	1@1	23.57	20.47	0.1114
7	15	15	507000	2535	DFT-s-OFDM QPSK	1@1	23.81	20.71	0.1178
7	15	15	507000	2535	DFT-s-OFDM 16 QAM	1@1	22.82	19.72	0.0938
7	15	15	512500	2562.5	DFT-s-OFDM PI/2 BPSK	1@1	23.43	20.33	0.1079
7	15	15	512500	2562.5	DFT-s-OFDM QPSK	1@1	23.67	20.57	0.1140
7	15	15	512500	2562.5	DFT-s-OFDM 16 QAM	1@1	22.94	19.84	0.0964
7	15	20	502000	2510	DFT-s-OFDM PI/2 BPSK	1@1	23.45	20.35	0.1084
7	15	20	502000	2510	DFT-s-OFDM QPSK	1@1	23.61	20.51	0.1125
7	15	20	502000	2510	DFT-s-OFDM 16 QAM	1@1	23.11	20.01	0.1002



7	15	20	507000	2535	DFT-s-OFDM PI/2 BPSK	1@1	23.5	20.4	0.1096
7	15	20	507000	2535	DFT-s-OFDM QPSK	1@1	23.72	20.62	0.1153
7	15	20	507000	2535	DFT-s-OFDM 16 QAM	1@1	22.93	19.83	0.0962
7	15	20	512000	2560	DFT-s-OFDM PI/2 BPSK	1@1	23.46	20.36	0.1086
7	15	20	512000	2560	DFT-s-OFDM QPSK	1@1	23.67	20.57	0.1140
7	15	20	512000	2560	DFT-s-OFDM 16 QAM	1@1	23.12	20.02	0.1005
7	15	25	502500	2512.5	DFT-s-OFDM PI/2 BPSK	1@1	23.44	20.34	0.1081
7	15	25	502500	2512.5	DFT-s-OFDM QPSK	1@1	23.6	20.5	0.1122
7	15	25	502500	2512.5	DFT-s-OFDM 16 QAM	1@1	23.02	19.92	0.0982
7	15	25	507000	2535	DFT-s-OFDM PI/2 BPSK	1@1	23.65	20.55	0.1135
7	15	25	507000	2535	DFT-s-OFDM QPSK	1@1	23.83	20.73	0.1183
7	15	25	507000	2535	DFT-s-OFDM 16 QAM	1@1	23.11	20.01	0.1002
7	15	25	511500	2557.5	DFT-s-OFDM PI/2 BPSK	1@1	23.51	20.41	0.1099
7	15	25	511500	2557.5	DFT-s-OFDM QPSK	1@1	23.64	20.54	0.1132
7	15	25	511500	2557.5	DFT-s-OFDM 16 QAM	1@1	23.05	19.95	0.0989
7	15	30	503000	2515	DFT-s-OFDM PI/2 BPSK	1@1	23.42	20.32	0.1076
7	15	30	503000	2515	DFT-s-OFDM QPSK	1@1	23.62	20.52	0.1127
7	15	30	503000	2515	DFT-s-OFDM 16 QAM	1@1	23.08	19.98	0.0995
7	15	30	507000	2535	DFT-s-OFDM PI/2 BPSK	1@1	23.63	20.53	0.1130
7	15	30	507000	2535	DFT-s-OFDM QPSK	1@1	23.85	20.75	0.1189
7	15	30	507000	2535	DFT-s-OFDM 16 QAM	1@1	22.89	19.79	0.0953
7	15	30	511000	2555	DFT-s-OFDM PI/2 BPSK	1@1	23.49	20.39	0.1094
7	15	30	511000	2555	DFT-s-OFDM QPSK	1@1	23.71	20.61	0.1151
7	15	30	511000	2555	DFT-s-OFDM 16 QAM	1@1	23.02	19.92	0.0982
7	15	40	504000	2520	DFT-s-OFDM PI/2 BPSK	1@1	23.47	20.37	0.1089
7	15	40	504000	2520	DFT-s-OFDM QPSK	1@1	23.65	20.55	0.1135
7	15	40	504000	2520	DFT-s-OFDM 16 QAM	1@1	22.97	19.87	0.0971
7	15	40	507000	2535	DFT-s-OFDM PI/2 BPSK	1@1	23.6	20.5	0.1122
7	15	40	507000	2535	DFT-s-OFDM QPSK	1@1	23.81	20.71	0.1178
7	15	40	507000	2535	DFT-s-OFDM 16 QAM	1@1	23.1	20	0.1000
7	15	40	510000	2550	DFT-s-OFDM PI/2 BPSK	1@1	23.51	20.41	0.1099
7	15	40	510000	2550	DFT-s-OFDM QPSK	1@1	23.72	20.62	0.1153
7	15	40	510000	2550	DFT-s-OFDM 16 QAM	1@1	22.85	19.75	0.0944



Frequency Stability

NR Band	SCS (kHz)	Bandwidth (MHz)	Arfcn	Freq (MHz)	Modulation	RB	Deviation (ppm)	Verdict	Environment
7	15	20	507000	2535.0	DFT-s-OFDM PI/2 BPSK	100@0	-0.0557	PASS	NV
7	15	20	507000	2535.0	DFT-s-OFDM PI/2 BPSK	100@0	-0.0544	PASS	LV
7	15	20	507000	2535.0	DFT-s-OFDM PI/2 BPSK	100@0	-0.0560	PASS	HV
7	15	20	507000	2535.0	DFT-s-OFDM PI/2 BPSK	100@0	-0.0576	PASS	-30°C
7	15	20	507000	2535.0	DFT-s-OFDM PI/2 BPSK	100@0	-0.0546	PASS	-20°C
7	15	20	507000	2535.0	DFT-s-OFDM PI/2 BPSK	100@0	-0.0561	PASS	-10°C
7	15	20	507000	2535.0	DFT-s-OFDM PI/2 BPSK	100@0	-0.0541	PASS	0°C
7	15	20	507000	2535.0	DFT-s-OFDM PI/2 BPSK	100@0	-0.0588	PASS	10°C
7	15	20	507000	2535.0	DFT-s-OFDM PI/2 BPSK	100@0	-0.0553	PASS	20°C
7	15	20	507000	2535.0	DFT-s-OFDM PI/2 BPSK	100@0	-0.0579	PASS	30°C
7	15	20	507000	2535.0	DFT-s-OFDM PI/2 BPSK	100@0	-0.0550	PASS	40°C
7	15	20	507000	2535.0	DFT-s-OFDM PI/2 BPSK	100@0	-0.0594	PASS	50°C



Peak to Average Ratio

NR Band	SCS (kHz)	Bandwidth (MHz)	Arfcn	Freq (MHz)	Modulation	RB	Result (dB)	Limit (dB)	Verdict
7	15	20	507000	2535.0	DFT-s-OFDM PI/2 BPSK	100@0	4.76	13	PASS
7	15	20	507000	2535.0	DFT-s-OFDM PI/2 BPSK	1@0	3.75	13	PASS
7	15	20	507000	2535.0	DFT-s-OFDM QPSK	100@0	5.57	13	PASS
7	15	20	507000	2535.0	DFT-s-OFDM QPSK	1@0	3.91	13	PASS

B2_N7(20M)_DFT-s-OFDM_PI_2-BPSK_Outer_Full_Mid_CH



B2_N7(20M)_DFT-s-OFDM_PI_2-BPSK_Edge_1RB_Left_Mid_CH



B2_N7(20M)_DFT-s-OFDM_QPSK_Outer_Full_Mid_CH



B2_N7(20M)_DFT-s-OFDM_QPSK_Edge_1RB_Left_Mid_CH

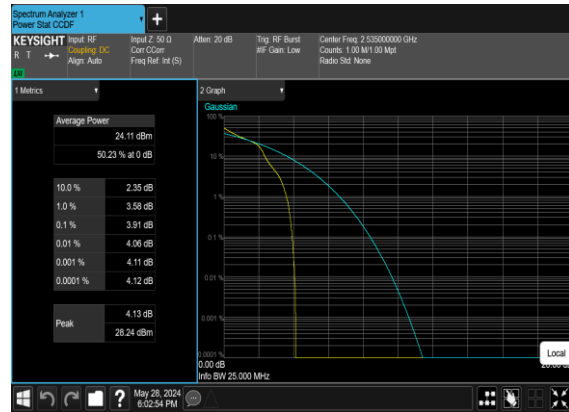



Occupied Bandwidth

NR Band	SCS (kHz)	Bandwidth (MHz)	Arfcn	Freq (MHz)	Modulation	RB	OBW (MHz)	26dB BW (MHz)
7	15	5	507000	2535.0	CP-OFDM QPSK	25@0	4.475	4.878
7	15	5	507000	2535.0	CP-OFDM 16 QAM	25@0	4.4744	4.874
7	15	5	507000	2535.0	CP-OFDM 64 QAM	25@0	4.4958	4.883
7	15	5	507000	2535.0	CP-OFDM 256 QAM	25@0	4.4825	4.888
7	15	10	507000	2535.0	CP-OFDM QPSK	52@0	9.2985	9.88
7	15	10	507000	2535.0	CP-OFDM 16 QAM	52@0	9.2929	9.806
7	15	10	507000	2535.0	CP-OFDM 64 QAM	52@0	9.3067	9.758
7	15	10	507000	2535.0	CP-OFDM 256 QAM	52@0	9.2755	9.743
7	15	15	507000	2535.0	CP-OFDM QPSK	79@0	14.111	14.76
7	15	15	507000	2535.0	CP-OFDM 16 QAM	79@0	14.109	14.82
7	15	15	507000	2535.0	CP-OFDM 64 QAM	79@0	14.13	14.83
7	15	15	507000	2535.0	CP-OFDM 256 QAM	79@0	14.144	14.76
7	15	20	507000	2535.0	CP-OFDM QPSK	106@0	18.945	19.66
7	15	20	507000	2535.0	CP-OFDM 16 QAM	106@0	18.957	19.74
7	15	20	507000	2535.0	CP-OFDM 64 QAM	106@0	18.98	19.62
7	15	20	507000	2535.0	CP-OFDM 256 QAM	106@0	18.93	19.79
7	15	25	507000	2535.0	CP-OFDM QPSK	133@0	23.676	24.77
7	15	25	507000	2535.0	CP-OFDM 16 QAM	133@0	23.743	24.71
7	15	25	507000	2535.0	CP-OFDM 64 QAM	133@0	23.704	24.62
7	15	25	507000	2535.0	CP-OFDM 256 QAM	133@0	23.635	24.79
7	15	30	507000	2535.0	CP-OFDM QPSK	160@0	28.627	29.65
7	15	30	507000	2535.0	CP-OFDM 16 QAM	160@0	28.587	29.7
7	15	30	507000	2535.0	CP-OFDM 64 QAM	160@0	28.599	29.52
7	15	30	507000	2535.0	CP-OFDM 256 QAM	160@0	28.594	29.56
7	15	40	507000	2535.0	CP-OFDM QPSK	216@0	38.611	39.87
7	15	40	507000	2535.0	CP-OFDM 16 QAM	216@0	38.605	39.99
7	15	40	507000	2535.0	CP-OFDM 64 QAM	216@0	38.593	39.93
7	15	40	507000	2535.0	CP-OFDM 256 QAM	216@0	38.691	39.86
7	15	50	507000	2535.0	CP-OFDM QPSK	270@0	48.145	49.82
7	15	50	507000	2535.0	CP-OFDM 16 QAM	270@0	48.172	49.75
7	15	50	507000	2535.0	CP-OFDM 64 QAM	270@0	48.144	49.74
7	15	50	507000	2535.0	CP-OFDM 256 QAM	270@0	48.139	49.83



B2_N7(5M)_CP-OFDM_QPSK_Outer_Full_Mid_CH

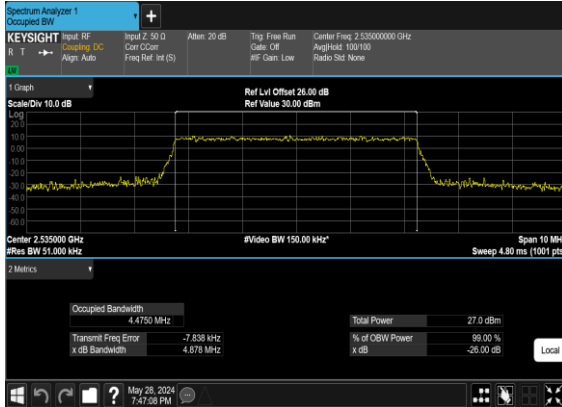

B2_N7(5M)_CP-OFDM_16 QAM_Outer_Full_Mid_CH

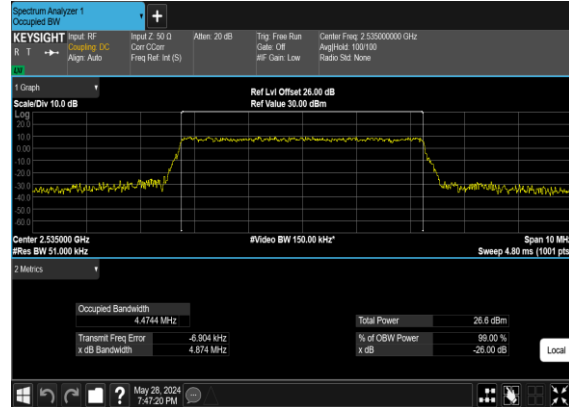

B2_N7(5M)_CP-OFDM_64 QAM_Outer_Full_Mid_CH

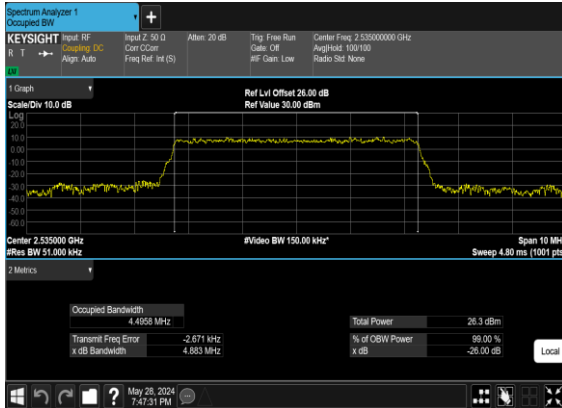

B2_N7(5M)_CP-OFDM_256 QAM_Outer_Full_Mid_CH

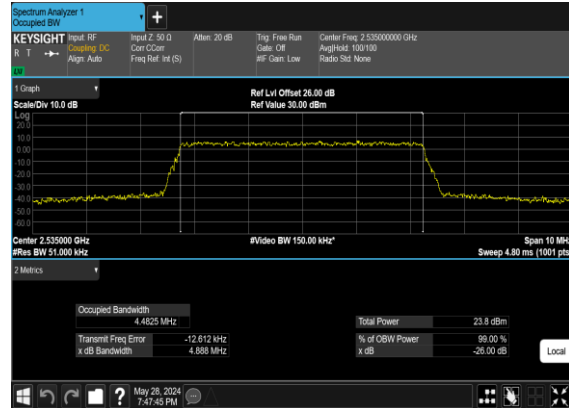

B2_N7(10M)_CP-OFDM_QPSK_Outer_Full_Mid_CH

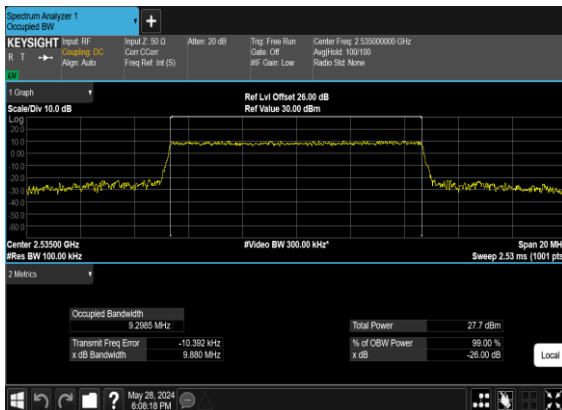

B2_N7(10M)_CP-OFDM_16 QAM_Outer_Full_Mid_CH

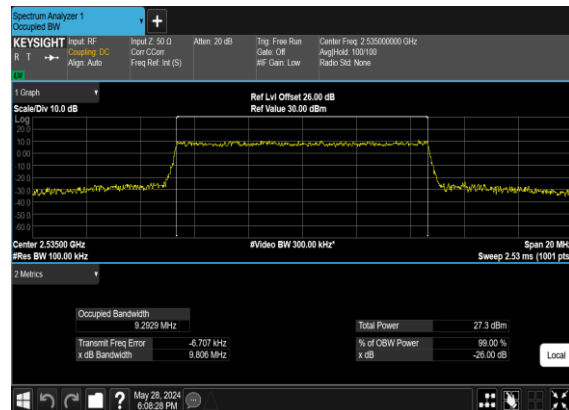



B2_N7(10M)_CP-OFDM_64 QAM_Outer_Full_Mid_CH

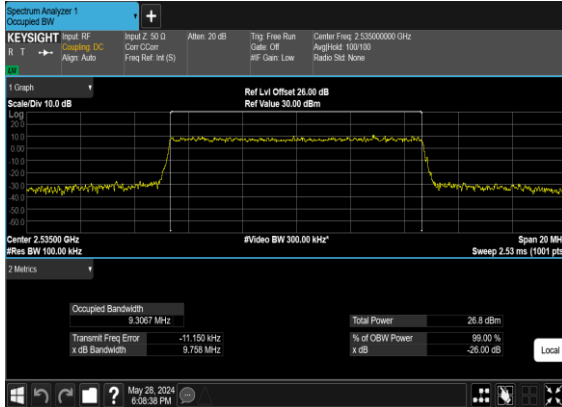

B2_N7(10M)_CP-OFDM_256 QAM_Outer_Full_Mid_CH



B2_N7(15M)_CP-OFDM_QPSK_Outer_Full_Mid_CH

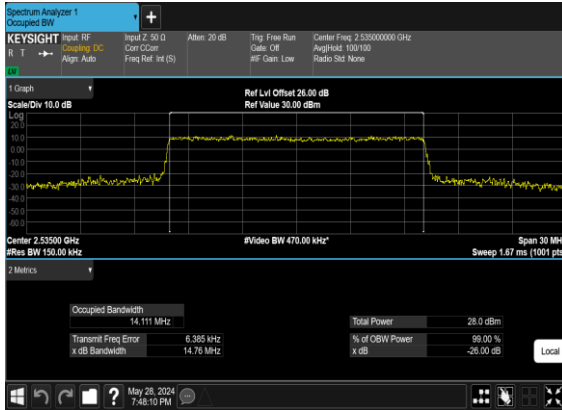

B2_N7(15M)_CP-OFDM_16 QAM_Outer_Full_Mid_CH

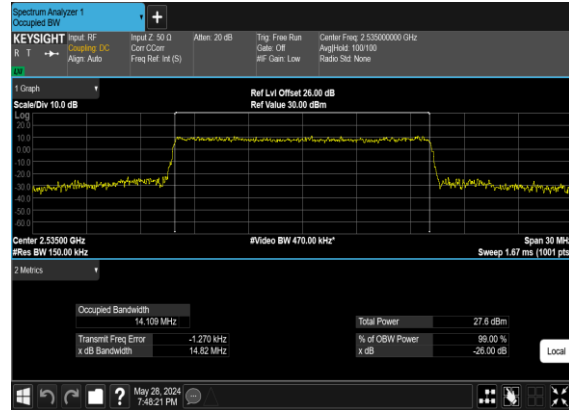

B2_N7(15M)_CP-OFDM_64 QAM_Outer_Full_Mid_CH

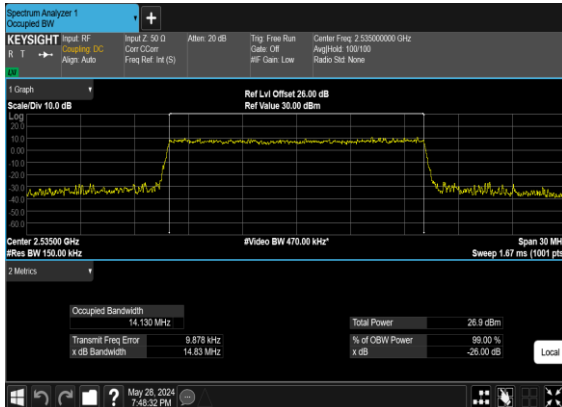

B2_N7(15M)_CP-OFDM_256 QAM_Outer_Full_Mid_CH

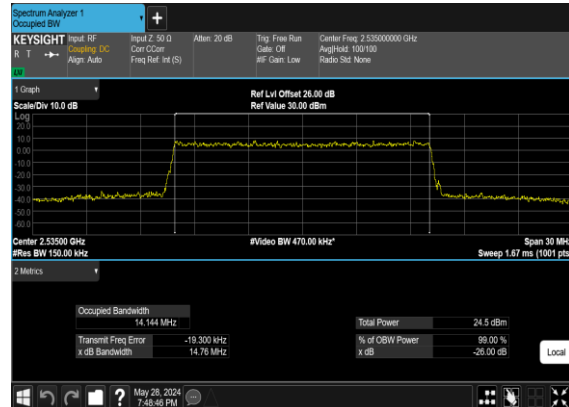



B2_N7(20M)_CP-OFDM_QPSK_Outer_Full_Mid_CH



B2_N7(20M)_CP-OFDM_16QAM_Outer_Full_Mid_CH

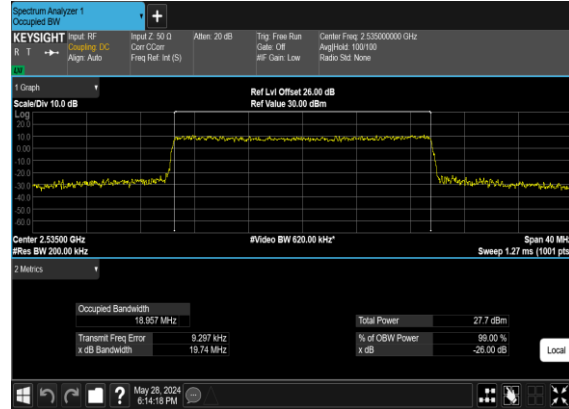

B2_N7(20M)_CP-OFDM_64QAM_Outer_Full_Mid_CH

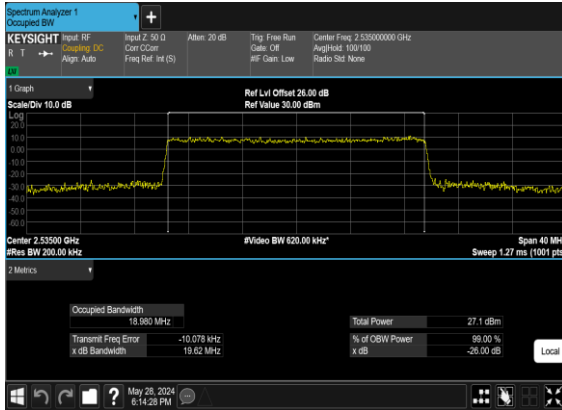

B2_N7(20M)_CP-OFDM_256QAM_Outer_Full_Mid_CH

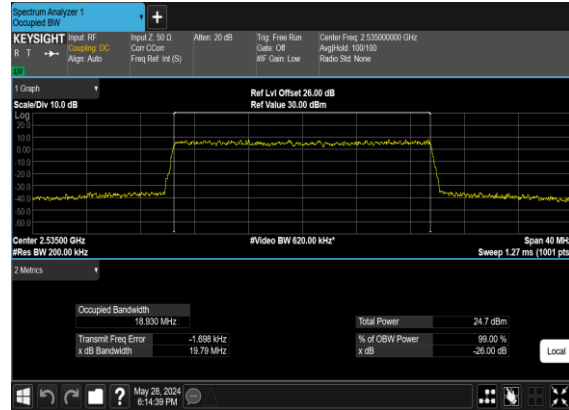

B2_N7(25M)_CP-OFDM_QPSK_Outer_Full_Mid_CH

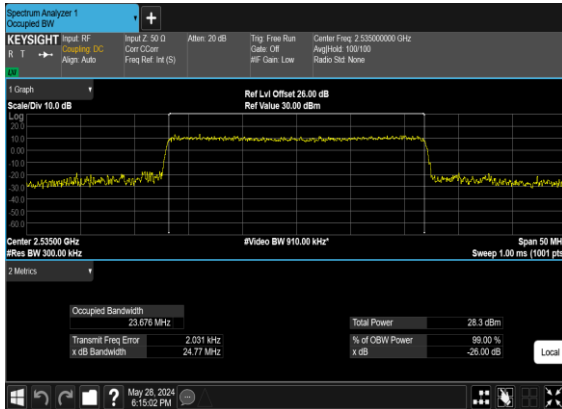

B2_N7(25M)_CP-OFDM_16QAM_Outer_Full_Mid_CH

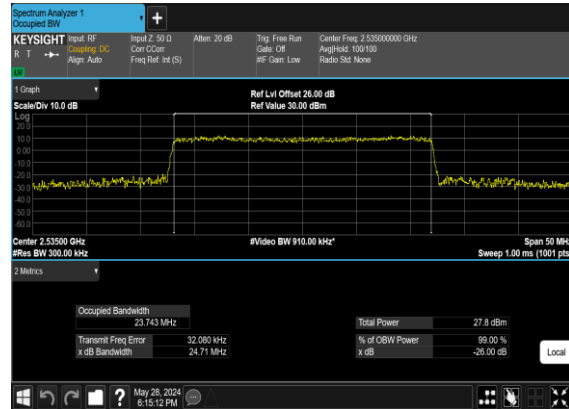



B2_N7(25M)_CP-OFDM_64 QAM_Outer_Full_Mid_CH

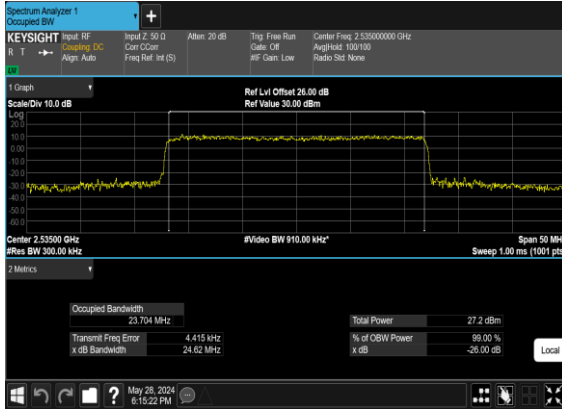

B2_N7(25M)_CP-OFDM_256 QAM_Outer_Full_Mid_CH

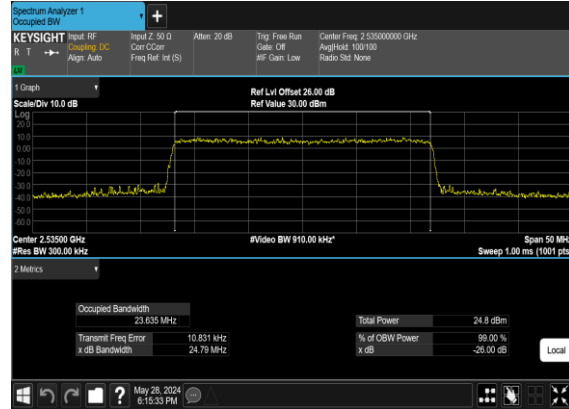

B2_N7(30M)_CP-OFDM_QPSK_Outer_Full_Mid_CH

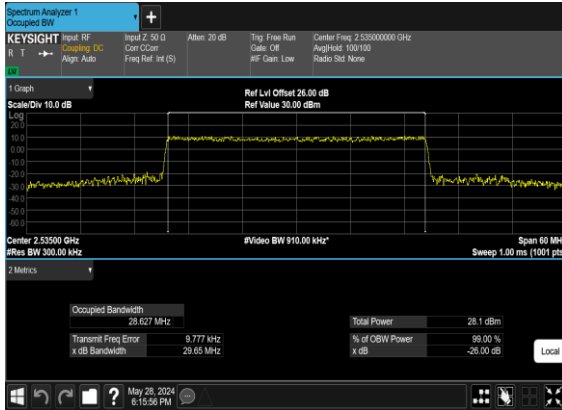

B2_N7(30M)_CP-OFDM_16 QAM_Outer_Full_Mid_CH

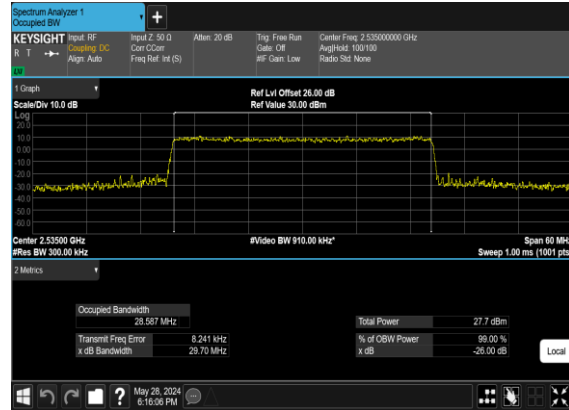

B2_N7(30M)_CP-OFDM_64 QAM_Outer_Full_Mid_CH

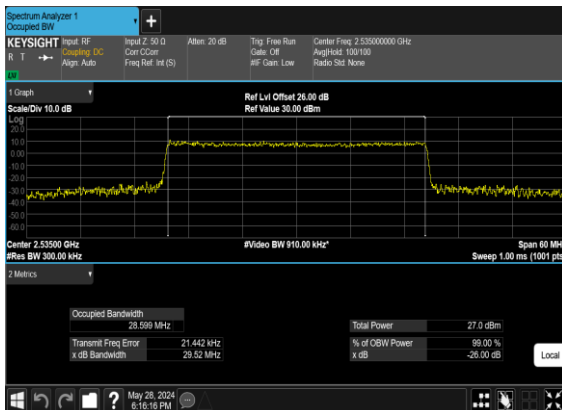

B2_N7(30M)_CP-OFDM_256 QAM_Outer_Full_Mid_CH

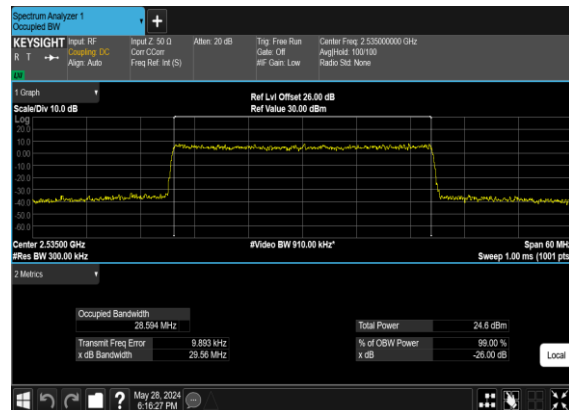



B2_N7(40M)_CP-OFDM_QPSK_Outer_Full_Mid_CH

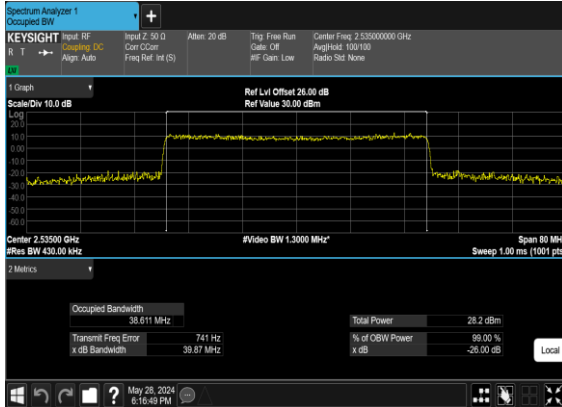

B2_N7(40M)_CP-OFDM_16QAM_Outer_Full_Mid_CH

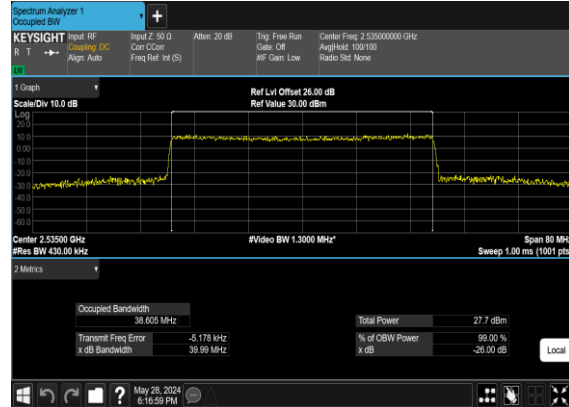

B2_N7(40M)_CP-OFDM_64QAM_Outer_Full_Mid_CH

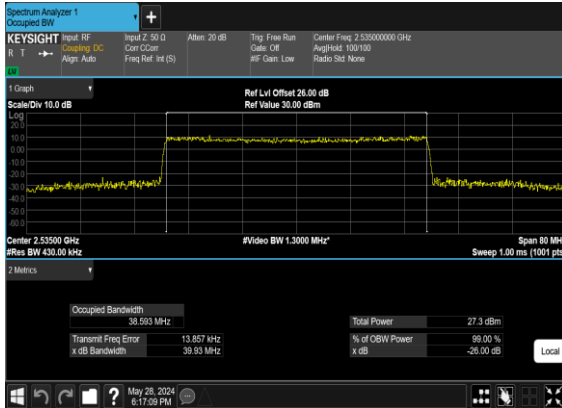

B2_N7(40M)_CP-OFDM_256QAM_Outer_Full_Mid_CH

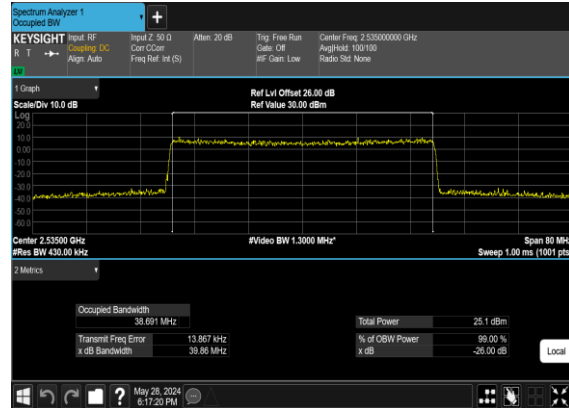

B2_N7(50M)_CP-OFDM_QPSK_Outer_Full_Mid_CH

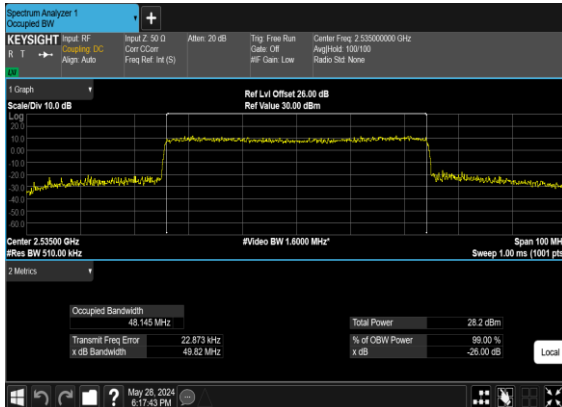

B2_N7(50M)_CP-OFDM_16QAM_Outer_Full_Mid_CH

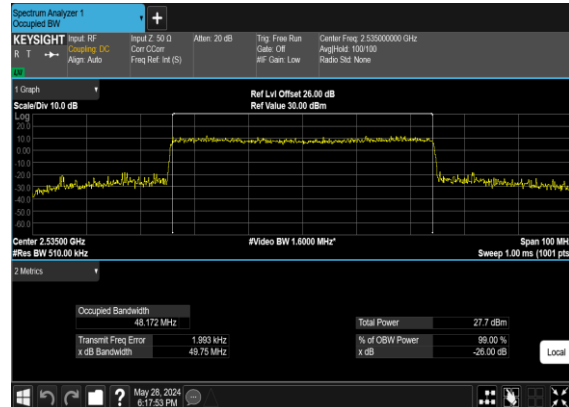



B2_N7(50M)_CP-OFDM_64
QAM_Outer_Full_Mid_CH

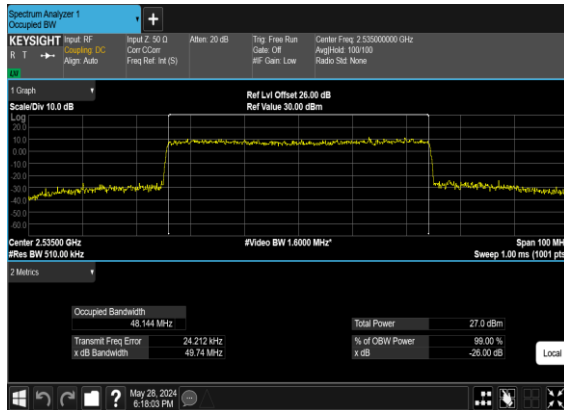

B2_N7(50M)_CP-OFDM_256
QAM_Outer_Full_Mid_CH

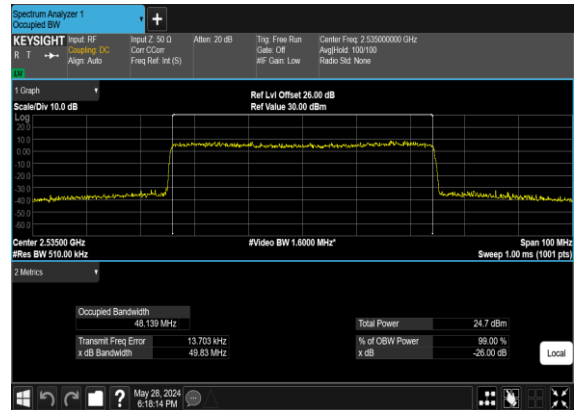



Conducted Spurious Emissions

NR Band	SCS (kHz)	Bandwidth (MHz)	Arfcn	Freq (MHz)	Modulation	RB	Result	Verdict
7	15	5	500500	2502.5	DFT-s-OFDM BPSK	1@0	see graph	---
7	15	5	500500	2502.5	DFT-s-OFDM BPSK	1@0	see graph	PASS
7	15	5	500500	2502.5	DFT-s-OFDM BPSK	1@0	see graph	PASS
7	15	5	500500	2502.5	DFT-s-OFDM QPSK	1@0	see graph	---
7	15	5	500500	2502.5	DFT-s-OFDM QPSK	1@0	see graph	PASS
7	15	5	500500	2502.5	DFT-s-OFDM QPSK	1@0	see graph	PASS
7	15	5	507000	2535.0	DFT-s-OFDM BPSK	1@0	see graph	---
7	15	5	507000	2535.0	DFT-s-OFDM BPSK	1@0	see graph	PASS
7	15	5	507000	2535.0	DFT-s-OFDM BPSK	1@0	see graph	PASS
7	15	5	507000	2535.0	DFT-s-OFDM QPSK	1@0	see graph	---
7	15	5	507000	2535.0	DFT-s-OFDM QPSK	1@0	see graph	PASS
7	15	5	507000	2535.0	DFT-s-OFDM QPSK	1@0	see graph	PASS
7	15	5	513500	2567.5	DFT-s-OFDM BPSK	1@0	see graph	---
7	15	5	513500	2567.5	DFT-s-OFDM BPSK	1@0	see graph	PASS
7	15	5	513500	2567.5	DFT-s-OFDM BPSK	1@0	see graph	PASS
7	15	5	513500	2567.5	DFT-s-OFDM QPSK	1@0	see graph	---
7	15	5	513500	2567.5	DFT-s-OFDM QPSK	1@0	see graph	PASS
7	15	5	513500	2567.5	DFT-s-OFDM QPSK	1@0	see graph	PASS
7	15	20	502000	2510.0	DFT-s-OFDM BPSK	1@0	see graph	---
7	15	20	502000	2510.0	DFT-s-OFDM BPSK	1@0	see graph	PASS
7	15	20	502000	2510.0	DFT-s-OFDM BPSK	1@0	see graph	PASS
7	15	20	502000	2510.0	DFT-s-OFDM QPSK	1@0	see graph	---
7	15	20	502000	2510.0	DFT-s-OFDM QPSK	1@0	see graph	PASS
7	15	20	502000	2510.0	DFT-s-OFDM QPSK	1@0	see graph	PASS
7	15	20	507000	2535.0	DFT-s-OFDM BPSK	1@0	see graph	---
7	15	20	507000	2535.0	DFT-s-OFDM BPSK	1@0	see graph	PASS
7	15	20	507000	2535.0	DFT-s-OFDM BPSK	1@0	see graph	PASS
7	15	20	507000	2535.0	DFT-s-OFDM QPSK	1@0	see graph	---
7	15	20	507000	2535.0	DFT-s-OFDM QPSK	1@0	see graph	PASS
7	15	20	507000	2535.0	DFT-s-OFDM QPSK	1@0	see graph	PASS
7	15	20	512000	2560.0	DFT-s-OFDM BPSK	1@0	see graph	---
7	15	20	512000	2560.0	DFT-s-OFDM BPSK	1@0	see graph	PASS
7	15	20	512000	2560.0	DFT-s-OFDM BPSK	1@0	see graph	PASS
7	15	20	512000	2560.0	DFT-s-OFDM QPSK	1@0	see graph	---
7	15	20	512000	2560.0	DFT-s-OFDM QPSK	1@0	see graph	PASS
7	15	20	512000	2560.0	DFT-s-OFDM QPSK	1@0	see graph	PASS
7	15	50	505000	2525.0	DFT-s-OFDM BPSK	1@0	see graph	---
7	15	50	505000	2525.0	DFT-s-OFDM BPSK	1@0	see graph	PASS
7	15	50	505000	2525.0	DFT-s-OFDM BPSK	1@0	see graph	PASS
7	15	50	505000	2525.0	DFT-s-OFDM QPSK	1@0	see graph	---
7	15	50	505000	2525.0	DFT-s-OFDM QPSK	1@0	see graph	PASS
7	15	50	505000	2525.0	DFT-s-OFDM QPSK	1@0	see graph	PASS
7	15	50	507000	2535.0	DFT-s-OFDM BPSK	1@0	see graph	---
7	15	50	507000	2535.0	DFT-s-OFDM BPSK	1@0	see graph	PASS



7	15	50	507000	2535.0	DFT-s-OFDM BPSK	1@0	see graph	PASS
7	15	50	507000	2535.0	DFT-s-OFDM QPSK	1@0	see graph	---
7	15	50	507000	2535.0	DFT-s-OFDM QPSK	1@0	see graph	PASS
7	15	50	507000	2535.0	DFT-s-OFDM QPSK	1@0	see graph	PASS
7	15	50	509000	2545.0	DFT-s-OFDM BPSK	1@0	see graph	---
7	15	50	509000	2545.0	DFT-s-OFDM BPSK	1@0	see graph	PASS
7	15	50	509000	2545.0	DFT-s-OFDM BPSK	1@0	see graph	PASS
7	15	50	509000	2545.0	DFT-s-OFDM QPSK	1@0	see graph	---
7	15	50	509000	2545.0	DFT-s-OFDM QPSK	1@0	see graph	PASS
7	15	50	509000	2545.0	DFT-s-OFDM QPSK	1@0	see graph	PASS



B2_N7(5M)_DFT-s-OFDM_BPSK_Edge_1RB_Left_Low_CH

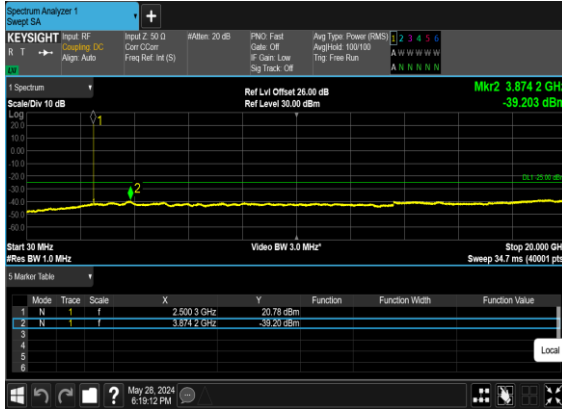

B2_N7(5M)_DFT-s-OFDM_BPSK_Edge_1RB_Left_Low_CH

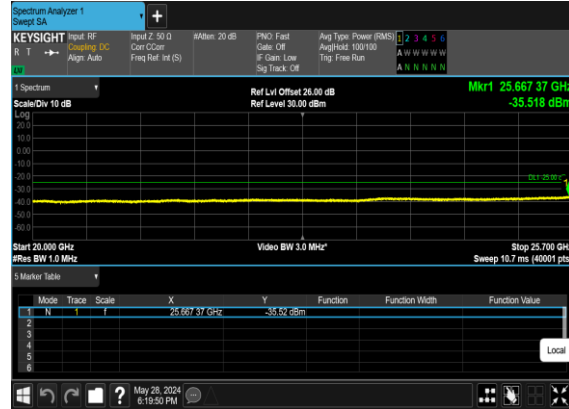

B2_N7(5M)_DFT-s-OFDM_QPSK_Edge_1RB_Left_Low_CH

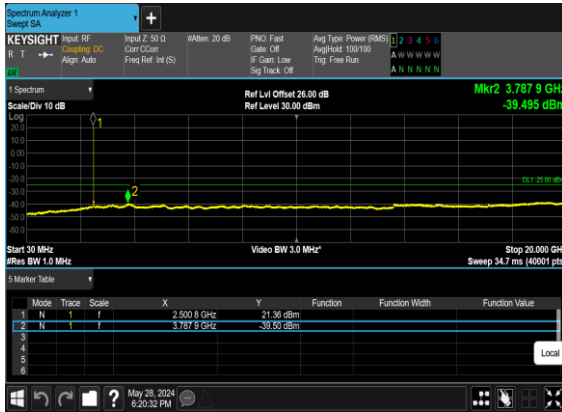

B2_N7(5M)_DFT-s-OFDM_QPSK_Edge_1RB_Left_Low_CH

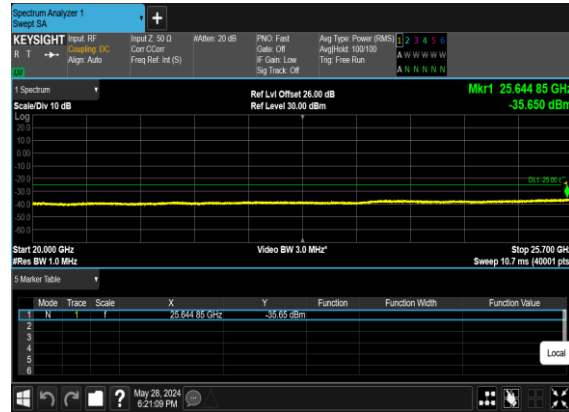

B2_N7(5M)_DFT-s-OFDM_BPSK_Edge_1RB_Left_Mid_CH

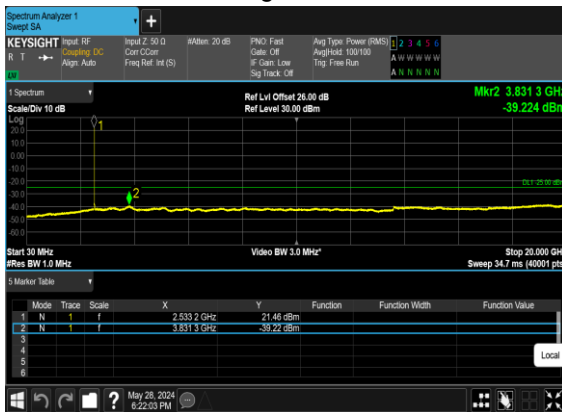

B2_N7(5M)_DFT-s-OFDM_BPSK_Edge_1RB_Left_Mid_CH

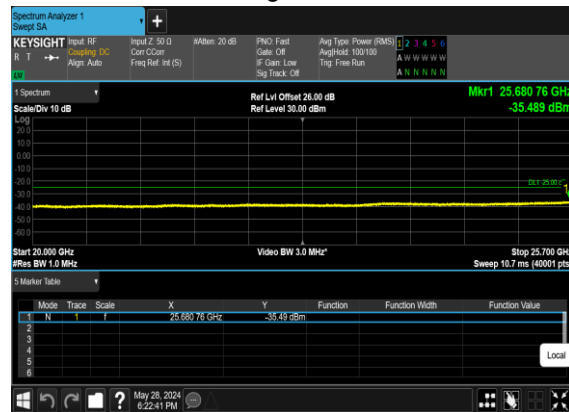



B2_N7(5M)_DFT-s-OFDM_QPSK_Edge_1RB_Left_Mid_CH

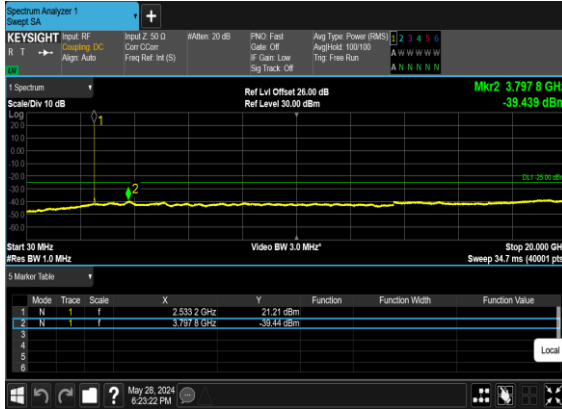

B2_N7(5M)_DFT-s-OFDM_QPSK_Edge_1RB_Left_Mid_CH

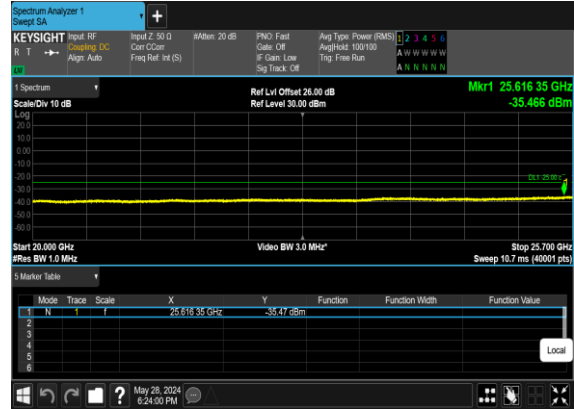

B2_N7(5M)_DFT-s-OFDM_BPSK_Edge_1RB_Left_High_CH

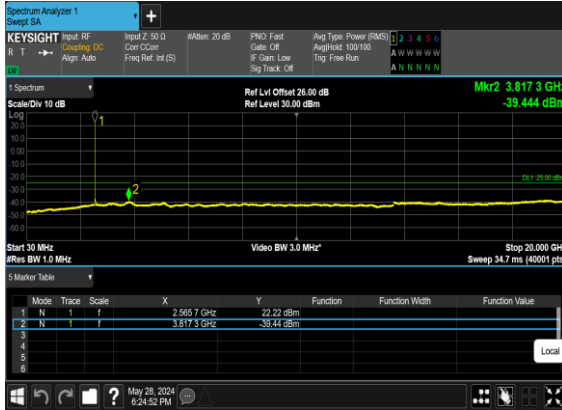

B2_N7(5M)_DFT-s-OFDM_BPSK_Edge_1RB_Left_High_CH

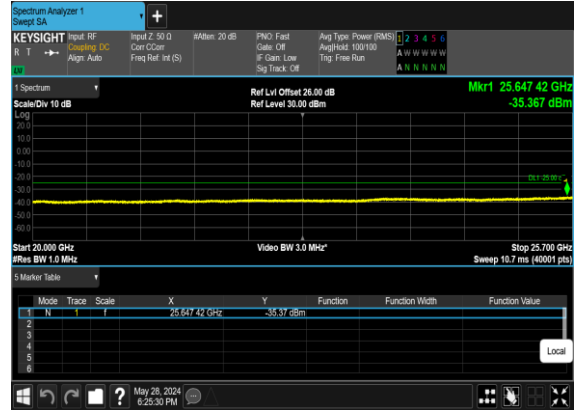

B2_N7(5M)_DFT-s-OFDM_QPSK_Edge_1RB_Left_High_CH



B2_N7(5M)_DFT-s-OFDM_QPSK_Edge_1RB_Left_High_CH

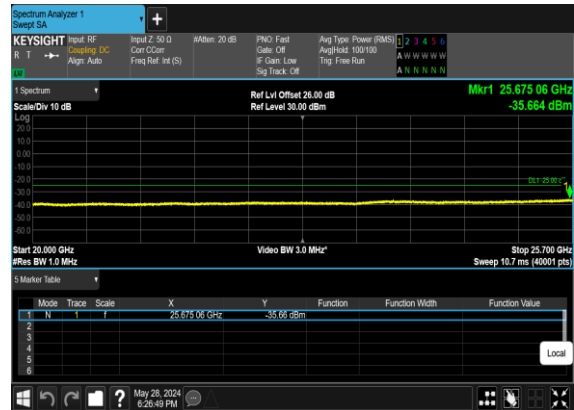



B2_N7(20M)_DFT-s-OFDM_BPSK_Edge_1RB_Left_Low_CH

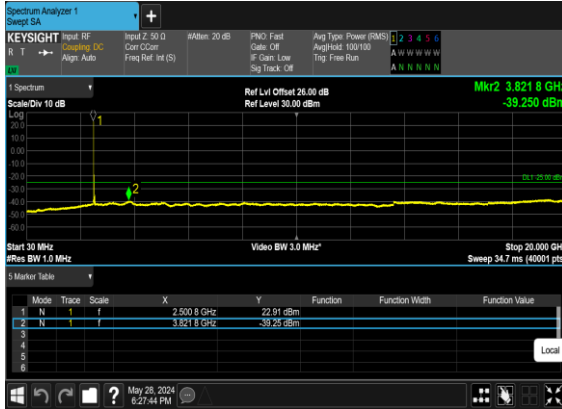

B2_N7(20M)_DFT-s-OFDM_BPSK_Edge_1RB_Left_Low_CH

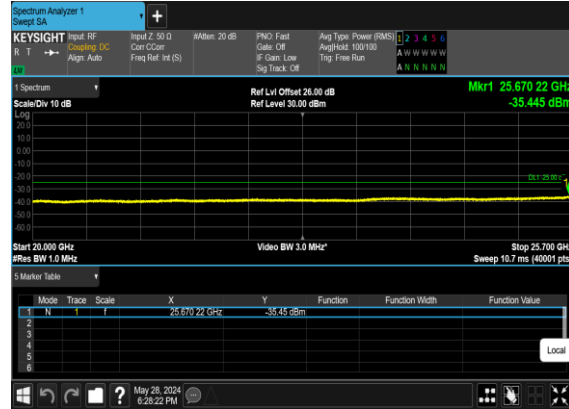

B2_N7(20M)_DFT-s-OFDM_QPSK_Edge_1RB_Left_Low_CH

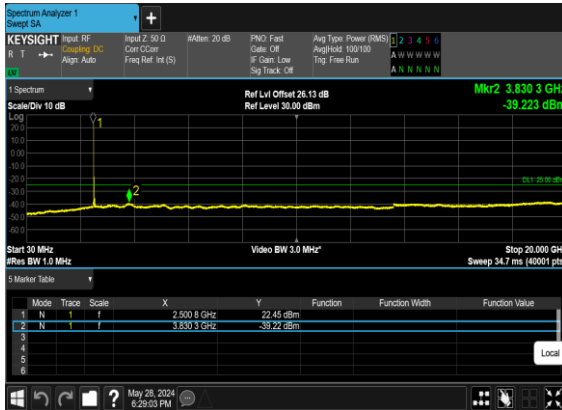

B2_N7(20M)_DFT-s-OFDM_QPSK_Edge_1RB_Left_Low_CH

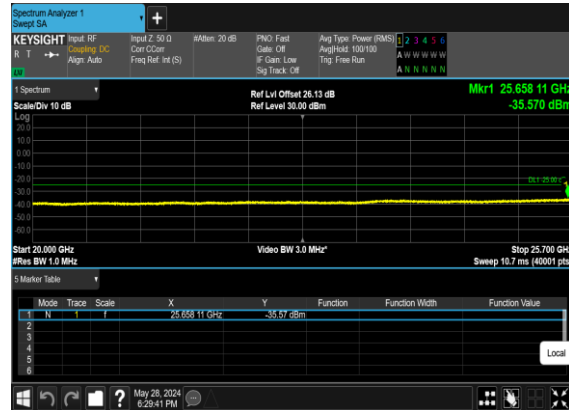

B2_N7(20M)_DFT-s-OFDM_BPSK_Edge_1RB_Left_Mid_CH



B2_N7(20M)_DFT-s-OFDM_BPSK_Edge_1RB_Left_Mid_CH





B2_N7(20M)_DFT-s-OFDM_QPSK_Edge_1RB_Left_Mid_CH

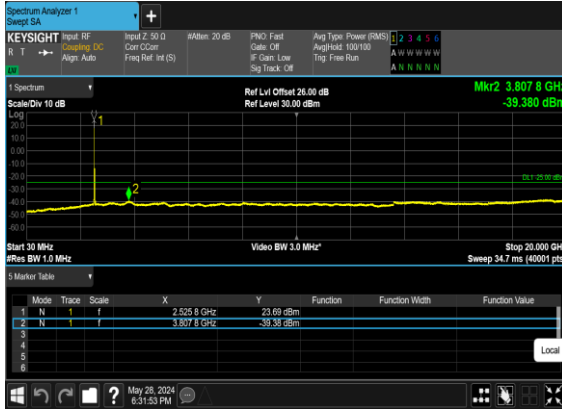

B2_N7(20M)_DFT-s-OFDM_QPSK_Edge_1RB_Left_Mid_CH

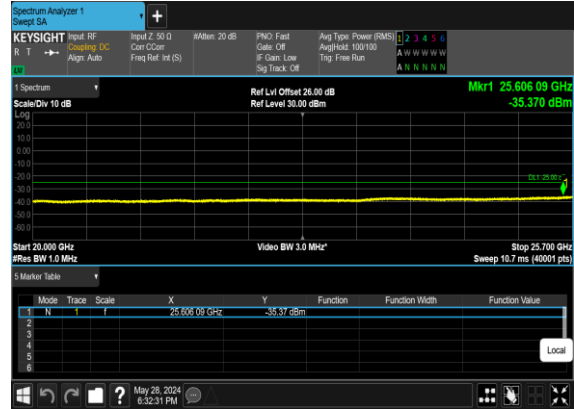

B2_N7(20M)_DFT-s-OFDM_BPSK_Edge_1RB_Left_High_CH



B2_N7(20M)_DFT-s-OFDM_BPSK_Edge_1RB_Left_High_CH

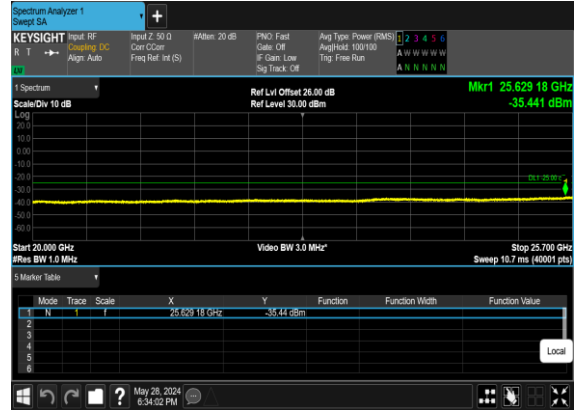

B2_N7(20M)_DFT-s-OFDM_QPSK_Edge_1RB_Left_High_CH

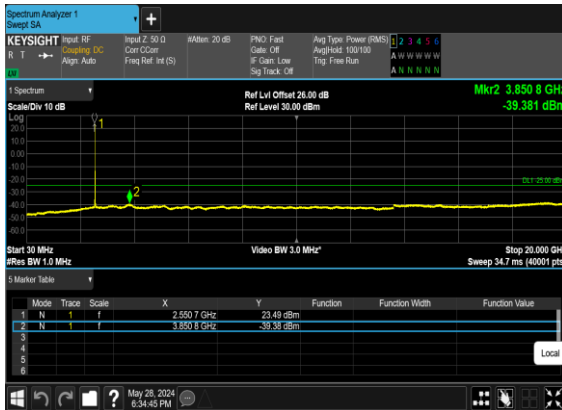

B2_N7(20M)_DFT-s-OFDM_QPSK_Edge_1RB_Left_High_CH

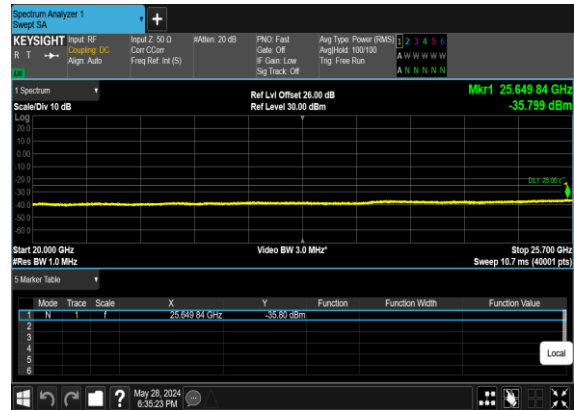



B2_N7(50M)_DFT-s-OFDM_BPSK_Edge_1RB_Left_Low_CH



B2_N7(50M)_DFT-s-OFDM_BPSK_Edge_1RB_Left_Low_CH



B2_N7(50M)_DFT-s-OFDM_QPSK_Edge_1RB_Left_Low_CH

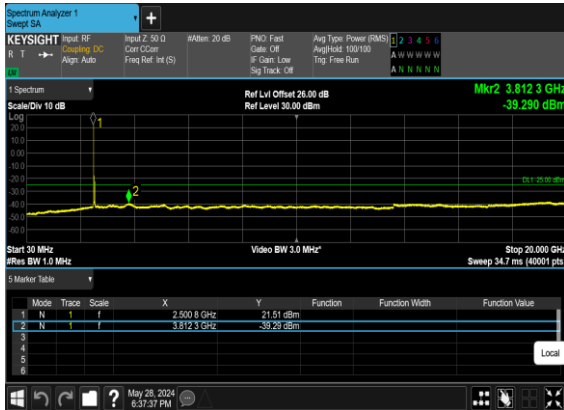

B2_N7(50M)_DFT-s-OFDM_QPSK_Edge_1RB_Left_Low_CH

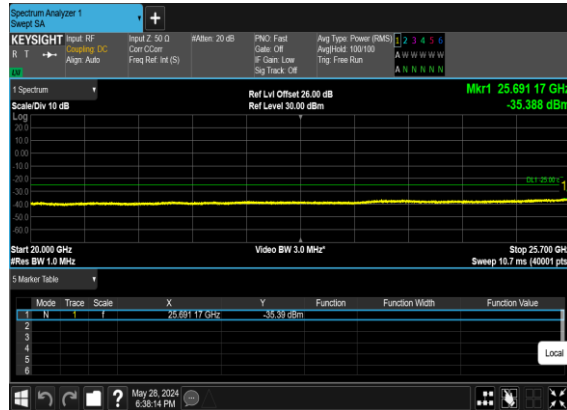

B2_N7(50M)_DFT-s-OFDM_BPSK_Edge_1RB_Left_Mid_CH



B2_N7(50M)_DFT-s-OFDM_BPSK_Edge_1RB_Left_Mid_CH

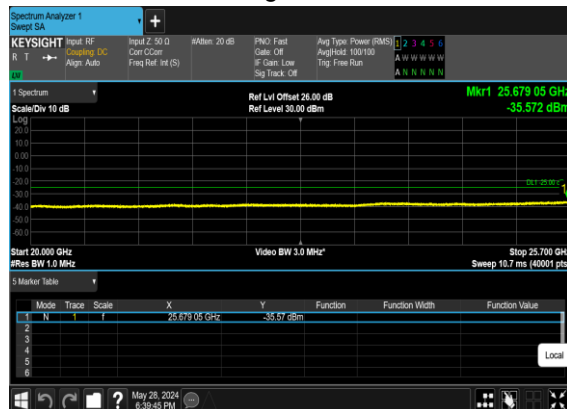



B2_N7(50M)_DFT-s-OFDM_QPSK_Edge_1RB_Left_Mid_CH

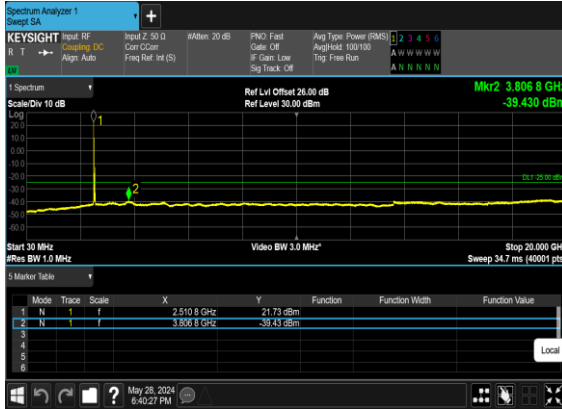

B2_N7(50M)_DFT-s-OFDM_QPSK_Edge_1RB_Left_Mid_CH

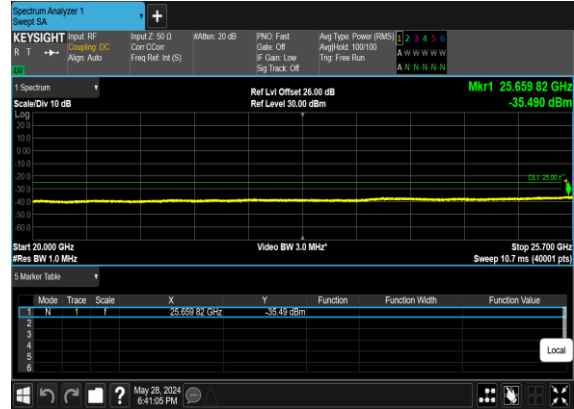

B2_N7(50M)_DFT-s-OFDM_BPSK_Edge_1RB_Left_High_CH

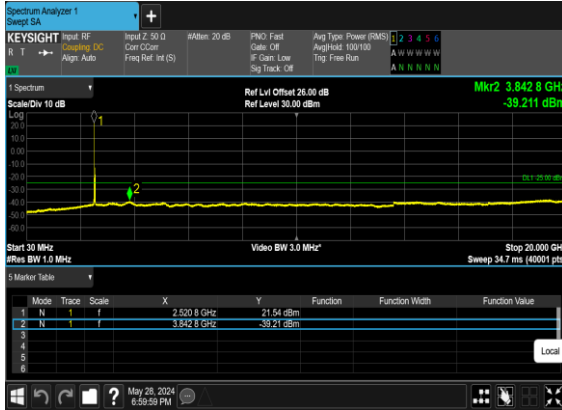

B2_N7(50M)_DFT-s-OFDM_BPSK_Edge_1RB_Left_High_CH

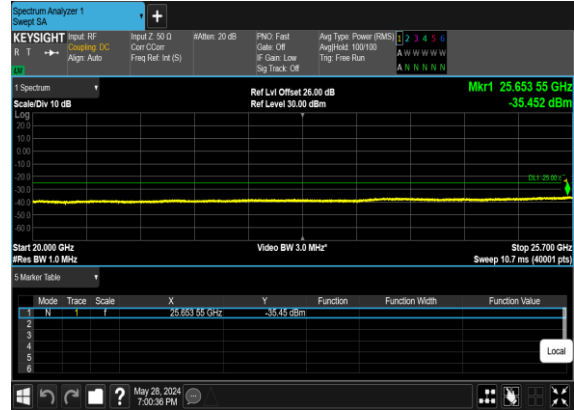

B2_N7(50M)_DFT-s-OFDM_QPSK_Edge_1RB_Left_High_CH

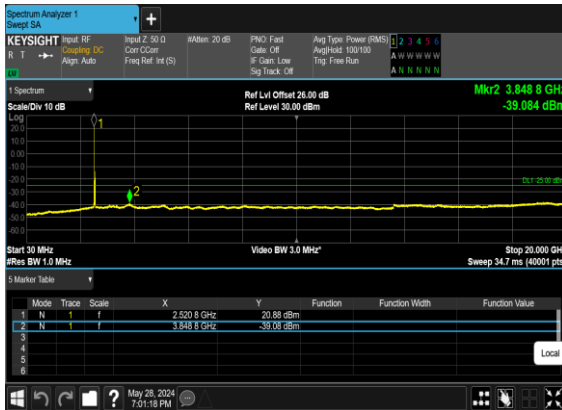

B2_N7(50M)_DFT-s-OFDM_QPSK_Edge_1RB_Left_High_CH

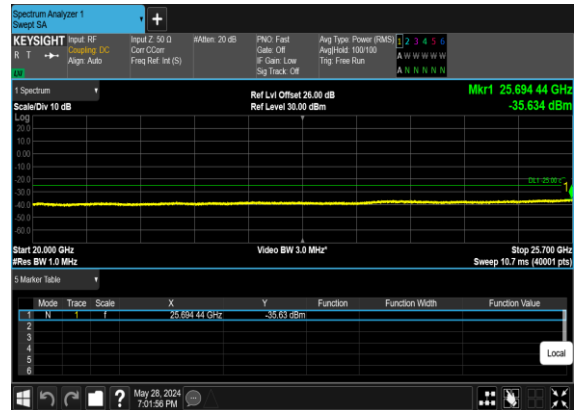



Conducted Band Edge

NR Band	SCS (kHz)	Bandwidth (MHz)	Arfcn	Freq (MHz)	Modulation	RB	Result	Verdict
7	15	5	500500	2502.5	DFT-s-OFDM BPSK	1@0	see graph	PASS
7	15	5	500500	2502.5	DFT-s-OFDM QPSK	1@0	see graph	PASS
7	15	5	500500	2502.5	DFT-s-OFDM BPSK	25@0	see graph	PASS
7	15	5	500500	2502.5	DFT-s-OFDM QPSK	25@0	see graph	PASS
7	15	5	513500	2567.5	DFT-s-OFDM BPSK	1@24	see graph	PASS
7	15	5	513500	2567.5	DFT-s-OFDM QPSK	1@24	see graph	PASS
7	15	5	513500	2567.5	DFT-s-OFDM BPSK	25@0	see graph	PASS
7	15	5	513500	2567.5	DFT-s-OFDM QPSK	25@0	see graph	PASS
7	15	20	502000	2510.0	DFT-s-OFDM BPSK	1@0	see graph	PASS
7	15	20	502000	2510.0	DFT-s-OFDM QPSK	1@0	see graph	PASS
7	15	20	502000	2510.0	DFT-s-OFDM BPSK	100@0	see graph	PASS
7	15	20	502000	2510.0	DFT-s-OFDM QPSK	100@0	see graph	PASS
7	15	20	512000	2560.0	DFT-s-OFDM BPSK	1@105	see graph	PASS
7	15	20	512000	2560.0	DFT-s-OFDM QPSK	1@105	see graph	PASS
7	15	20	512000	2560.0	DFT-s-OFDM BPSK	100@0	see graph	PASS
7	15	20	512000	2560.0	DFT-s-OFDM QPSK	100@0	see graph	PASS
7	15	50	505000	2525.0	DFT-s-OFDM BPSK	1@0	see graph	PASS
7	15	50	505000	2525.0	DFT-s-OFDM QPSK	1@0	see graph	PASS
7	15	50	505000	2525.0	DFT-s-OFDM BPSK	270@0	see graph	PASS
7	15	50	505000	2525.0	DFT-s-OFDM QPSK	270@0	see graph	PASS
7	15	50	509000	2545.0	DFT-s-OFDM BPSK	1@269	see graph	PASS
7	15	50	509000	2545.0	DFT-s-OFDM QPSK	1@269	see graph	PASS
7	15	50	509000	2545.0	DFT-s-OFDM BPSK	270@0	see graph	PASS
7	15	50	509000	2545.0	DFT-s-OFDM QPSK	270@0	see graph	PASS



B2_N7(5M)_DFT-s-OFDM_BPSK_Edge_1RB_Left_Low_CH

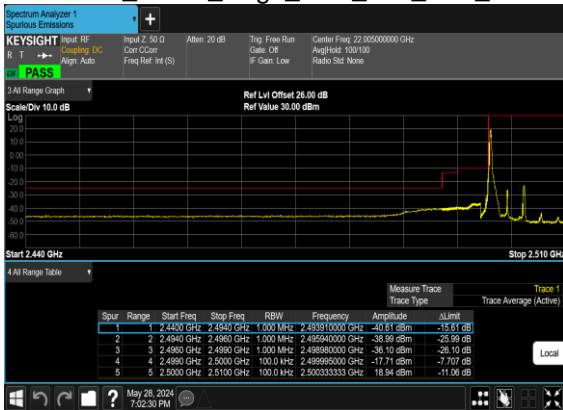

B2_N7(5M)_DFT-s-OFDM_QPSK_Edge_1RB_Left_Low_CH

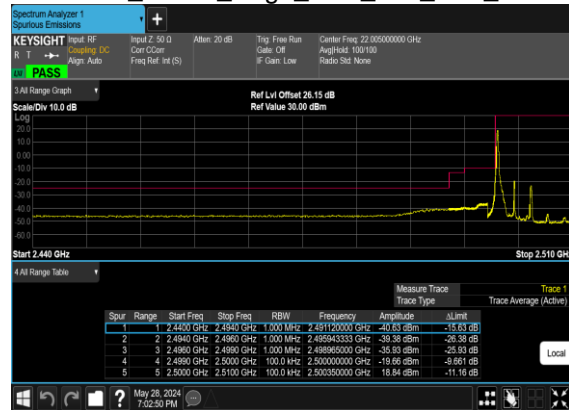

B2_N7(5M)_DFT-s-OFDM_BPSK_Outer_Full_Low_CH

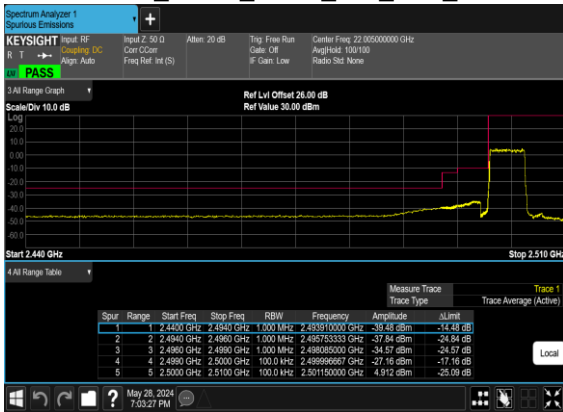

B2_N7(5M)_DFT-s-OFDM_QPSK_Outer_Full_Low_CH



B2_N7(5M)_DFT-s-OFDM_BPSK_Edge_1RB_Right_High_CH

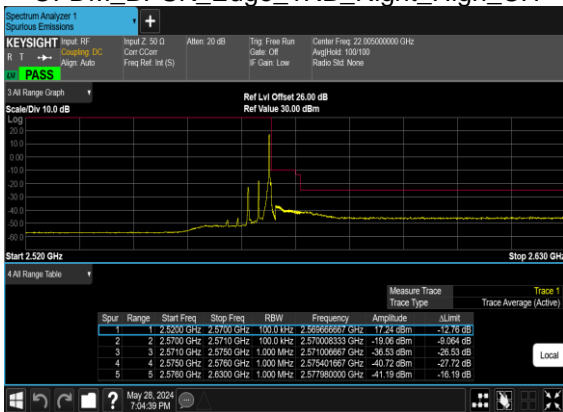

B2_N7(5M)_DFT-s-OFDM_QPSK_Edge_1RB_Right_High_CH

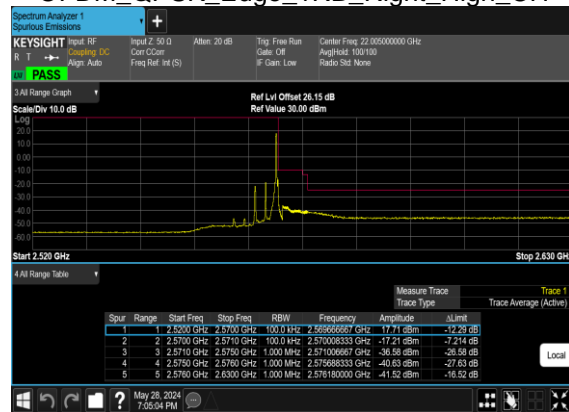



B2_N7(5M)_DFT-s-OFDM_BPSK_Outer_Full_High_CH

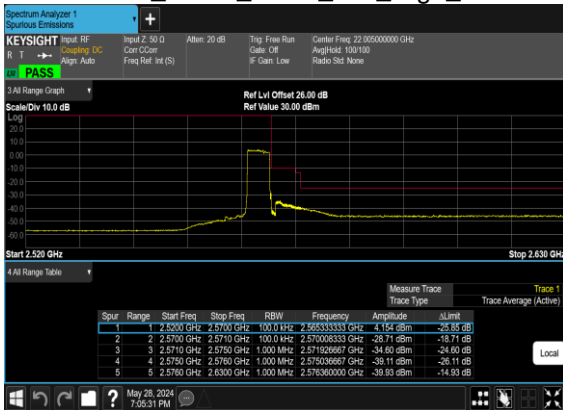

B2_N7(5M)_DFT-s-OFDM_QPSK_Outer_Full_High_CH

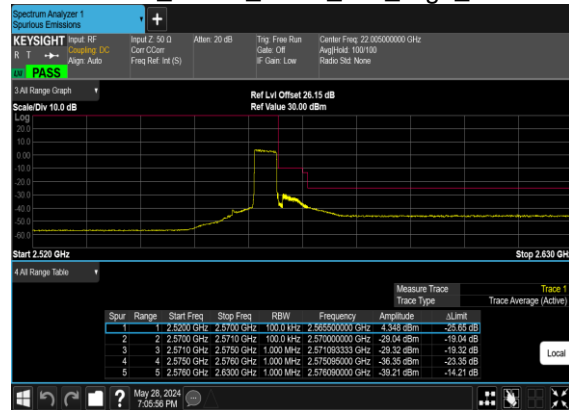

B2_N7(20M)_DFT-s-OFDM_BPSK_Edge_1RB_Left_Low_CH

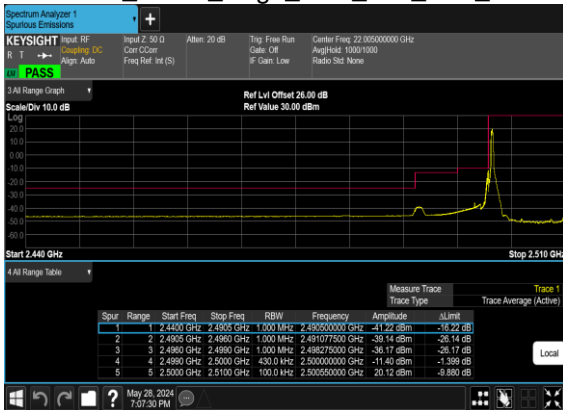

B2_N7(20M)_DFT-s-OFDM_QPSK_Edge_1RB_Left_Low_CH

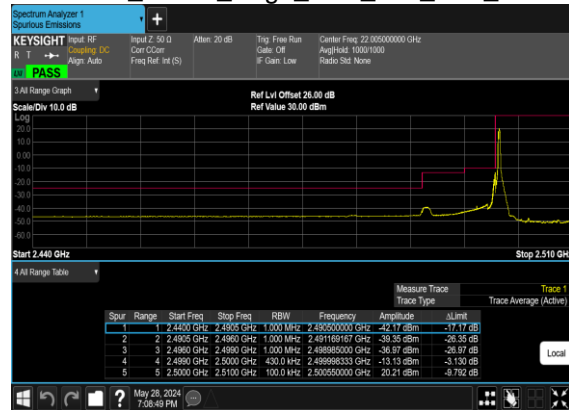

B2_N7(20M)_DFT-s-OFDM_BPSK_Outer_Full_Low_CH

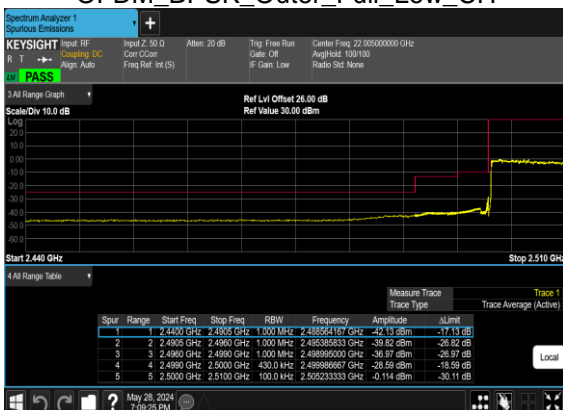

B2_N7(20M)_DFT-s-OFDM_QPSK_Outer_Full_Low_CH

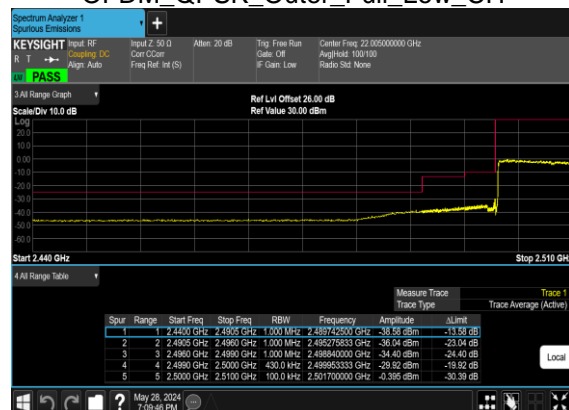



B2_N7(20M)_DFT-s-OFDM_BPSK_Edge_1RB_Right_High_CH

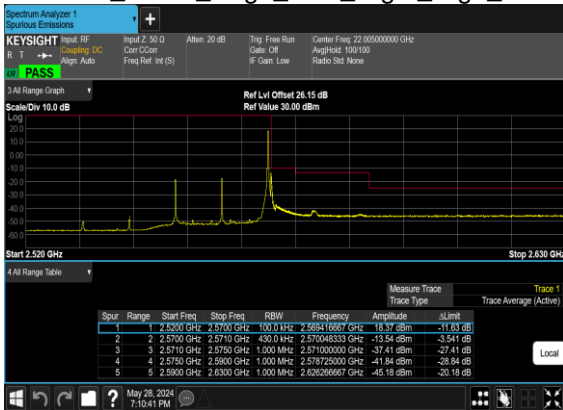

B2_N7(20M)_DFT-s-OFDM_QPSK_Edge_1RB_Right_High_CH

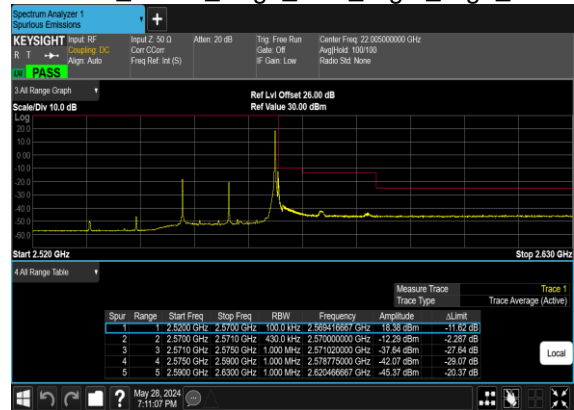

B2_N7(20M)_DFT-s-OFDM_BPSK_Outer_Full_High_CH

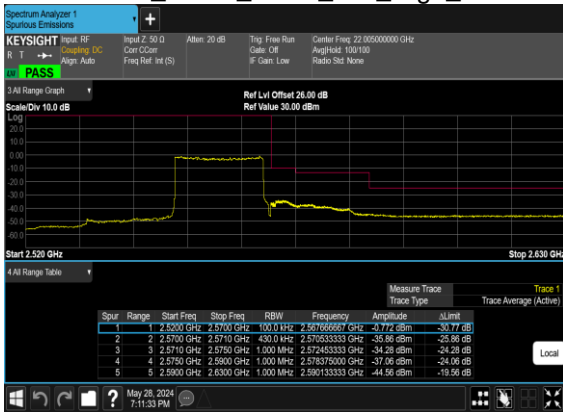

B2_N7(20M)_DFT-s-OFDM_QPSK_Outer_Full_High_CH

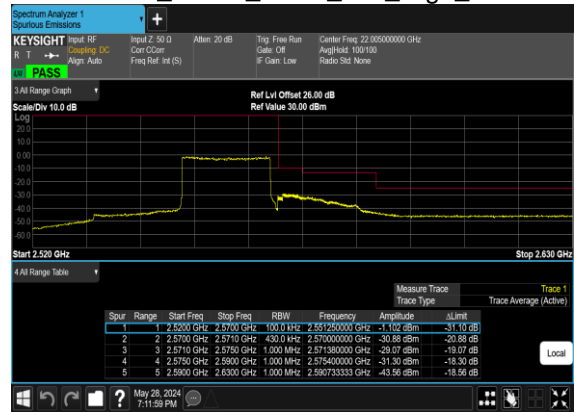

B2_N7(50M)_DFT-s-OFDM_BPSK_Edge_1RB_Left_Low_CH

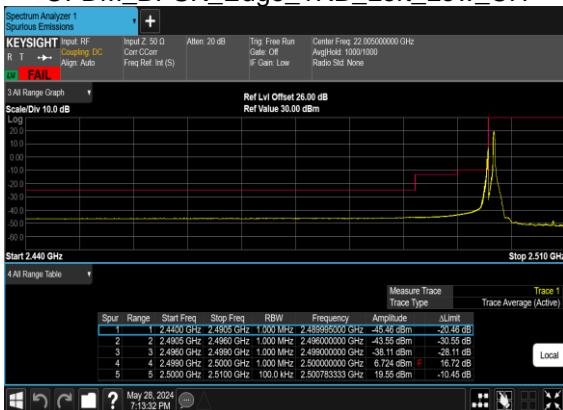

B2_N7(50M)_DFT-s-OFDM_BPSK_Edge_1RB_Left_Low_CH_CHP_PASS

