



# FCC RF Test Report

**APPLICANT** : Motorola Mobility LLC  
**EQUIPMENT** : Mobile Cellular Phone  
**BRAND NAME** : Motorola  
**MODEL NAME** : XT2403-1, XT2403-2  
**FCC ID** : IHDT56AQ5  
**STANDARD** : 47 CFR Part 2, 22(M)  
**CLASSIFICATION** : PCS Licensed Transmitter Held to Ear (PCE)  
**TEST DATE(S)** : Dec. 29, 2023 ~ Jan. 15, 2024

We, Sporton International Inc. (Kunshan), would like to declare that the tested sample has been evaluated in accordance with the procedures given in ANSI C63.26-2015 and shown compliance with the applicable technical standards.

This report contains data that were produced under subcontract by Sporton International Inc. (Shenzhen)

The test results in this report apply exclusively to the tested model / sample. Without written approval of Sporton International Inc. (Kunshan), the test report shall not be reproduced except in full.

Jason Jia

Approved by: Jason Jia



**Sporton International Inc. (Kunshan)**

**No. 1098, Pengxi North Road, Kunshan Economic Development Zone Jiangsu Province 215300  
People's Republic of China**



TABLE OF CONTENTS

REVISION HISTORY...3
SUMMARY OF TEST RESULT...4
1 GENERAL DESCRIPTION...5
1.1 Applicant...5
1.2 Manufacturer...5
1.3 Product Feature of Equipment Under Test...5
1.4 Product Specification of Equipment Under Test...5
1.5 Modification of EUT...6
1.6 Maximum ERP/EIRP Power and Emission Designator...7
1.7 Testing Location...9
1.8 Test Software...9
1.9 Applicable Standards...10
1.10 Specification of Accessory...10
2 TEST CONFIGURATION OF EQUIPMENT UNDER TEST...11
2.1 Test Mode...11
2.2 Connection Diagram of Test System...13
2.3 Support Unit used in test configuration and system...13
2.4 Measurement Results Explanation Example...13
2.5 Frequency List of Low/Middle/High Channels...14
3 CONDUCTED TEST ITEMS...18
3.1 Measuring Instruments...18
3.2 Test Setup...18
3.3 Test Result of Conducted Test...18
3.4 Conducted Output Power and ERP/EIRP...19
3.5 Peak-to-Average Ratio...20
3.6 Occupied Bandwidth...21
3.7 Conducted Band Edge...22
3.8 Conducted Spurious Emission...23
3.9 Frequency Stability...24
4 RADIATED TEST ITEMS...25
4.1 Measuring Instruments...25
4.2 Test Setup...25
4.3 Test Result of Radiated Test...26
4.4 Radiated Spurious Emission...27
5 LIST OF MEASURING EQUIPMENT...28
6 MEASUREMENT UNCERTAINTY...29
APPENDIX A. TEST RESULTS OF CONDUCTED TEST
APPENDIX B. TEST RESULTS OF RADIATED TEST
APPENDIX C. TEST SETUP PHOTOGRAPHS



### REVISION HISTORY

REPORT NO.	VERSION	DESCRIPTION	ISSUED DATE
FG3D1818C	Rev. 01	Initial issue of report	Jan. 26, 2024



### SUMMARY OF TEST RESULT

Report Section	FCC Rule	Description	Limit	Result	Remark
3.4	§2.1046	Conducted Output Power	-	Report Only	-
	§27.50(h)(2)	Equivalent Isotropic Radiated Power (Band 7) (Band 38) (Band 41)	EIRP < 2Watt		-
3.5	§24.232(d)	Peak-to-Average Ratio	<13 dB	PASS	-
3.6	§2.1049	Occupied Bandwidth	-	Report Only	-
3.7	§27.53(m)(4)	Conducted Band Edge Measurement (Band 7) (Band 38) (Band 41)	§27.53(m)(4)	PASS	-
3.8	§2.1051 §27.53(m)(4)	Conducted Spurious Emission(Band 7) (Band 38) (Band 41)	< 55+10log <sub>10</sub> (P[Watts])	PASS	-
3.9	§2.1055 §22.355	Frequency Stability Temperature & Voltage	< 2.5 ppm for Part 22	PASS	-
	§2.1055 §24.235 §27.54		Within Authorized Band		
4.4	§2.1053 §27.53(m)(4)	Radiated Spurious Emission (Band 7) (Band 38) (Band 41)	< 55+10log <sub>10</sub> (P[Watts])	PASS	Under limit 22.14 dB at 12624.00 MHz
	§2.1053 §27.53(m)(4)	Radiated Spurious Emission (Band 7) (Band 38) (Band 41)	< 55+10log <sub>10</sub> (P[Watts])		

**Conformity Assessment Condition:**

- The test results (PASS/FAIL) with all measurement uncertainty excluded are presented against the regulation limits or in accordance with the requirements stipulated by the applicant/manufacturer who shall bear all the risks of non-compliance that may potentially occur if measurement uncertainty is taken into account.
- The measurement uncertainty please refer to each test result in the section "Measurement Uncertainty"

**Disclaimer:**

The product specifications of the EUT presented in the test report that may affect the test assessments are declared by the manufacturer who shall take full responsibility for the authenticity.



# 1 General Description

## 1.1 Applicant

Motorola Mobility LLC  
222 W,Merchandise Mart Plaza, Chicago IL 60654 USA

## 1.2 Manufacturer

Motorola Mobility LLC  
222 W,Merchandise Mart Plaza, Chicago IL 60654 USA

## 1.3 Product Feature of Equipment Under Test

Product Feature	
Equipment	Mobile Cellular Phone
Brand Name	Motorola
Model Name	XT2403-1, XT2403-2
FCC ID	IHDT56AQ5
IMEI Code	Conducted: 35495844026590/354958440026608 Radiation: 354958440023894/354958440023902
HW Version	DVT2
SW Version	U2UM34.9
EUT Stage	Identical Prototype

**Remark:**

1. The above EUT's information was declared by manufacturer. Please refer to the specifications or user's manual for more detailed description.
2. There are two models: XT2403-1 is pSIM+pSIM sample, XT2403-2 is pSIM + eSIM sample, no other difference, full test with the model XT2403-2.

## 1.4 Product Specification of Equipment Under Test

Standards-related Product Specification	
Tx Frequency	LTE Band 7 : 2500 MHz ~ 2570 MHz LTE Band 38 : 2570 MHz ~ 2620 MHz LTE Band 41 : 2496 MHz ~ 2690 MHz
Rx Frequency	LTE Band 7 : 2620 MHz ~ 2690 MHz LTE Band 38: 2570 MHz ~ 2620 MHz LTE Band 41 : 2496 MHz ~ 2690 MHz
Bandwidth	LTE Band 7 : 5MHz/ 10MHz / 15MHz / 20MHz LTE Band 38 : 5MHz / 10MHz / 15MHz / 20MHz LTE Band 41 : 5MHz / 10MHz / 15MHz / 20MHz
Maximum Output Power to Antenna	<b>Ant.0</b> LTE Band 7 : 20.94 dBm LTE Band 38 : 24.38 dBm LTE Band 41 : 24.55 dBm



	LTE Band 7C : 20.85 dBm LTE Band 38C : 24.29 dBm LTE Band 41C : 24.42 dBm <b>Ant.1</b> LTE Band 7 : 21.15 dBm LTE Band 38 : 24.66 dBm LTE Band 41 : 24.70 dBm LTE Band 7C : 21.09 dBm LTE Band 38C : 24.46 dBm LTE Band 41C : 21.06 dBm <b>Ant.2</b> LTE Band 7 : 22.80 dBm LTE Band 38 : 25.35 dBm LTE Band 41 : 25.45 dBm LTE Band 7C : 22.66 dBm LTE Band 38C : 25.16 dBm LTE Band 41C : 25.33 dBm <b>Ant.10</b> LTE Band 7 : 22.95 dBm LTE Band 38 : 25.84 dBm LTE Band 41 : 25.89 dBm LTE Band 7C : 22.81 dBm LTE Band 38C : 25.66 dBm LTE Band 41C : 25.66 dBm
Antenna Gain	<b>Ant.0</b> LTE Band 7 : -6.9 dBi LTE Band 38 : -6.8 dBi LTE Band 41 : -6.8 dBi <b>Ant.1</b> LTE Band 7 : -3.3 dBi LTE Band 38 : -3.3 dBi LTE Band 41 : -3.3 dBi <b>Ant.2</b> LTE Band 7 : -3.8 dBi LTE Band 38 : -3.8 dBi LTE Band 41 : -3.8 dBi <b>Ant.10</b> LTE Band 7 : -6.5 dBi LTE Band 38 : -6.8 dBi LTE Band 41 : -6.8 dBi
Type of Modulation	QPSK / 16QAM / 64QAM/256QAM

Remark:

1. The maximum EIRP is calculated from max output power and max antenna gain, only the maximum EIRP of Ant.2 for LTE Band 7/38/41/7C/38C/41C are shown in the report.
2. LTE Band 38/41 support HPUE.

### 1.5 Modification of EUT

No modifications are made to the EUT during all test items.



### 1.6 Maximum ERP/EIRP Power and Emission Designator

LTE Band 7		QPSK		16QAM/64QAM/256QAM	
BW (MHz)	Frequency Range (MHz)	Maximum EIRP(W)	Emission Designator (99%OBW)	Maximum EIRP(W)	Emission Designator (99%OBW)
5	2502.5 ~ 2567.5	0.0776	4M51G7D	0.0605	4M50W7D
10	2505.0 ~ 2565.0	0.0780	9M01G7D	0.0614	9M01W7D
15	2507.5 ~ 2562.5	0.0771	13M5G7D	0.0607	13M5W7D
20	2510.0 ~ 2560.0	0.0794	18M0G7D	0.0621	17M9W7D
LTE Band 38		QPSK		16QAM/64QAM/256QAM	
BW (MHz)	Frequency Range (MHz)	Maximum EIRP(W)	Emission Designator (99%OBW)	Maximum EIRP(W)	Emission Designator (99%OBW)
5	2572.5 ~ 2617.5	0.1377	4M51G7D	0.1099	4M50W7D
10	2575.0 ~ 2615.0	0.1393	9M01G7D	0.1094	9M09W7D
15	2577.5 ~ 2612.5	0.1393	13M5G7D	0.1102	13M5W7D
20	2580.0 ~ 2610.0	0.1429	17M9G7D	0.1122	17M9W7D
LTE Band 41		QPSK		16QAM/64QAM/256QAM	
BW (MHz)	Frequency Range (MHz)	Maximum EIRP(W)	Emission Designator (99%OBW)	Maximum EIRP(W)	Emission Designator (99%OBW)
5	2498.5 ~ 2687.5	0.1445	4M51G7D	0.1130	4M50W7D
10	2501.0 ~ 2685.0	0.1429	9M01G7D	0.1132	9M09W7D
15	2503.5 ~ 2682.5	0.1445	13M5G7D	0.1135	13M5W7D
20	2506.0 ~ 2680.0	0.1462	17M9G7D	0.1169	17M9W7D

LTE Band CA_7C		QPSK		16QAM/64QAM/256QAM	
BW (MHz)		Maximum EIRP(W)	Emission Designator (99%OBW)	Maximum EIRP(W)	Emission Designator (99%OBW)
10MHz+20MHz		0.0753	27M7G7D	0.0582	27M7W7D
15MHz+15MHz		0.0759	28M6G7D	0.0590	28M4W7D
15MHz+20MHz		0.0760	32M6G7D	0.0600	32M9W7D
15MHz+10MHz		0.0759	23M4G7D	0.0579	23M4W7D
20MHz+10MHz		0.0757	28M2G7D	0.0587	28M1W7D
20MHz+15MHz		0.0764	32M7G7D	0.0601	32M7W7D
20MHz+20MHz		0.0769	37M7G7D	0.0605	37M3W7D



LTE Band CA_38C	QPSK		16QAM/64QAM/256QAM	
BW (MHz)	Maximum EIRP(W)	Emission Designator (99%OBW)	Maximum EIRP(W)	Emission Designator (99%OBW)
15MHz+15MHz	0.1352	28M7G7D	0.1072	28M8W7D
20MHz+20MHz	0.1368	38M0G7D	0.1084	37M8W7D

LTE Band CA_41C	QPSK		16QAM/64QAM/256QAM	
BW (MHz)	Maximum EIRP(W)	Emission Designator (99%OBW)	Maximum EIRP(W)	Emission Designator (99%OBW)
5MHz+20MHz	0.1390	22M9G7D	0.1089	22M9W7D
10MHz+20MHz	0.1400	28M2G7D	0.1099	27M8W7D
10MHz+15MHz	0.1387	23M4G7D	0.1079	23M4W7D
15MHz+15MHz	0.1406	28M7G7D	0.1102	28M8W7D
15MHz+20MHz	0.1403	32M8G7D	0.1079	32M9W7D
15MHz+10MHz	0.1406	23M5G7D	0.1107	23M5W7D
20MHz+5MHz	0.1403	23M2G7D	0.1074	23M3W7D
20MHz+10MHz	0.1416	28M3G7D	0.1089	28M0W7D
20MHz+15MHz	0.1393	32M9G7D	0.1130	32M9W7D
20MHz+20MHz	0.1422	38M0G7D	0.1156	37M8W7D

Note:

LTE Band 41 overlaps the entire frequency range of LTE Band 38. Therefore, the test results provided in this report covers Band 41 as well as Band 38.





### 1.7 Testing Location

Sporton International Inc. (Kunshan) is accredited to ISO/IEC 17025:2017 by American Association for Laboratory Accreditation with Certificate Number 5145.02.

<b>Test Firm</b>	Sporton International Inc. (Kunshan)		
<b>Test Site Location</b>	No. 1098, Pengxi North Road, Kunshan Economic Development Zone Jiangsu Province 215300 People's Republic of China TEL : +86-512-57900158		
<b>Test Site No.</b>	<b>Sporton Site No.</b>	<b>FCC Designation No.</b>	<b>FCC Test Firm Registration No.</b>
	03CH04-KS	CN1257	314309

Sporton International Inc. (ShenZhen) is accredited to ISO/IEC 17025:2017 by American Association for Laboratory Accreditation with Certificate Number 5145.01.

<b>Test Firm</b>	Sporton International Inc. (ShenZhen)		
<b>Test Site Location</b>	1/F, 2/F, Bldg 5, Shiling Industrial Zone, Xinwei Village, Xili, Nanshan, Shenzhen, 518055 People's Republic of China TEL: +86-755-86379589 FAX: +86-755-86379595		
<b>Test Site No.</b>	<b>Sporton Site No.</b>	<b>FCC Designation No.</b>	<b>FCC Test Firm Registration No.</b>
	TH01-SZ	CN1256	421272

### 1.8 Test Software

Item	Site	Manufacture	Name	Version
1.	03CH04-KS	AUDIX	E3	210616



### 1.9 Applicable Standards

According to the specifications of the manufacturer, the EUT must comply with the requirements of the following standards:

- 47 CFR Part 2, 22(M)
- ANSI C63.26-2015
- FCC KDB 971168 D01 Power Meas License Digital Systems v03r01
- FCC KDB 412172 D01 Determining ERP and EIRP v01r01

**Remark:**

1. All test items were verified and recorded according to the standards and without any deviation during the test.
2. This EUT has also been tested and complied with the requirements of FCC Part 15, Subpart B, recorded in a separate test report.

### 1.10 Specification of Accessory

Accessories Information				
AC Adapter 1(US)	Brand Name	Motorola(Chenyang)	Model Name	MC-1251
AC Adapter 1(EU)	Brand Name	Motorola(Chenyang)	Model Name	MC-1252
AC Adapter 1(UK)	Brand Name	Motorola(Chenyang)	Model Name	MC-1253
AC Adapter 1(AU)	Brand Name	Motorola(Chenyang)	Model Name	MC-1255
AC Adapter 1(AR)	Brand Name	Motorola(Chenyang)	Model Name	MC-1256
AC Adapter 1(BR)	Brand Name	Motorola(Chenyang)	Model Name	MC-1257
AC Adapter 2(US)	Brand Name	Motorola(AOHAI)	Model Name	MC-1251
AC Adapter 2(EU)	Brand Name	Motorola(AOHAI)	Model Name	MC-1252
AC Adapter 2(UK)	Brand Name	Motorola(AOHAI)	Model Name	MC-1253
AC Adapter 2(AU)	Brand Name	Motorola(AOHAI)	Model Name	MC-1255
AC Adapter 2(AR)	Brand Name	Motorola(AOHAI)	Model Name	MC-1256
AC Adapter 2(BR)	Brand Name	Motorola(AOHAI)	Model Name	MC-1257
AC Adapter 2(CHILE)	Brand Name	Motorola(AOHAI)	Model Name	MC-1259
AC Adapter 2(IN)	Brand Name	Motorola(AOHAI)	Model Name	MC-1254
AC Adapter 3(IN)	Brand Name	Motorola(Acbel)	Model Name	MC-684N
Battery	Brand Name	Motorola (ATL)	Model Name	QM45
USB Cable 1	Brand Name	Saibao	Model Name	SC18D71644
USB Cable 2	Brand Name	Luxshare	Model Name	SC18E08104
Wireless Earphone	Brand Name	Motorola	Model Name	XT2441-1
Wireless Charging dock	Marketing Name	Turbo Power 50W Wireless Charging Stand	Model Name	MW-02



## 2 Test Configuration of Equipment Under Test

### 2.1 Test Mode

Antenna port conducted and radiated test items listed below are performed according to KDB 971168 D01 Power Meas License Digital Systems v03r01 with maximum output power.

Radiated measurements are performed by rotating the EUT in three different orthogonal test planes to find the maximum emission. (Y Plane)

Test Items	Band	Bandwidth (MHz)						Modulation				RB #			Test Channel			
		1.4	3	5	10	15	20	QPSK	16 QAM	64 QAM	256 QAM	1	Half	Full	L	M	H	
Max. Output Power	7	-	-	v	v	v	v	v	v	v	v	v	v		v	v	v	v
	38	-	-	v	v	v	v	v	v	v	v	v	v		v	v	v	v
	41	-	-	v	v	v	v	v	v	v	v	v	v		v	v	v	v
Peak-to-Average Ratio	7	-	-					v	v	v	v			v			v	
	41	-	-					v	v	v	v			v			v	
26dB and 99% Bandwidth	7	-	-	v	v	v	v	v	v						v		v	
	41	-	-	v	v	v	v	v	v						v		v	
Conducted Band Edge	7	-	-	v	v	v	v	v	v	v			v		v	v		v
	41	-	-	v	v	v	v	v	v	v			v		v	v		v
Conducted Spurious Emission	7	-	-	v	v	v	v	v					v			v	v	v
	41	-	-	v	v	v	v	v					v			v	v	v
Frequency Stability	7	-	-		v			v							v		v	
	41	-	-		v			v							v		v	
E.R.P / E.I.R.P	7	-	-	v	v	v	v	v	v	v	v	v	v		v	v	v	v
	38	-	-	v	v	v	v	v	v	v	v	v	v		v	v	v	v
	41	-	-	v	v	v	v	v	v	v	v	v	v		v	v	v	v
Radiated Spurious Emission	7	Worst Case															v	
	41	Worst Case															v	
Note	<ol style="list-style-type: none"> <li>The mark "v" means that this configuration is chosen for testing</li> <li>The mark "-" means that this bandwidth is not supported.</li> <li>The device is investigated from 30MHz to 10 times of fundamental signal for radiated spurious emission test under different RB size/offset and modulations in exploratory test. Subsequently, only the worst case emissions are reported.</li> </ol>																	



Test Items	Band	Bandwidth (MHz)										Modulation			RB #			Test Channel					
		20+20	20+15	15+20	20+10	10+20	20+5	5+20	15+15	15+10	10+15	QPSK	16 QAM	64 QAM	256 QAM	1	Half	Full	L	M	H		
Max. Output Power	7C_CA	v	v	v	v	v	-	-	v	v	-	v	v	v	v	v				v			
	38C_CA	v	-	-	-	-	-	-	v	-	-	v	v	v	v	v				v			
	41C_CA	v	v	v	v	v	v	v	v	v	v	v	v	v	v	v				v			
26dB and 99% Bandwidth	7C_CA	v	v	v	v	v	-	-	v	v	-	v	v					v		v			
	38C_CA	v	-	-	-	-	-	-	v	-	-	v	v					v		v			
	41C_CA	v	v	v	v	v	v	v	v	v	v	v	v					v		v			
Conducted Band Edge	7C_CA	v	v	v	v	v	-	-	v	v	-	v	v	v			v		v	v	v		
	38C_CA	v	-	-	-	-	-	-	v	-	-	v	v	v			v		v	v	v		
	41C_CA	v	v	v	v	v	v	v	v	v	v	v	v	v			v		v	v	v		
Conducted Spurious Emission	7C_CA	v	v	v	v	v	-	-	v	v	-	v					v			v	v	v	
	38C_CA	v	-	-	-	-	-	-	v	-	-	v					v			v	v	v	
	41C_CA	v	v	v	v	v	v	v	v	v	v	v					v			v	v	v	
E.I.R.P.	7C_CA	v	v	v	v	v	-	-	v	v	-	v	v	v	v	v					v		
	38C_CA	v	-	-	-	-	-	-	v	-	-	v	v	v	v	v					v		
	41C_CA	v	v	v	v	v	v	v	v	v	v	v	v	v	v	v					v		
Radiated Spurious Emission	7C_CA	Worst Case																				v	
	38C_CA	Worst Case																				v	
	41C_CA	Worst Case																				v	
Note	1. The mark "v" means that this configuration is chosen for testing 2. The mark "-" means that this bandwidth is not supported. 3. The device is investigated from 30MHz to 10 times of fundamental signal for radiated spurious emission test under different RB size/offset and modulations in exploratory test. Subsequently, only the worst case emissions are reported.																						

## 2.2 Connection Diagram of Test System

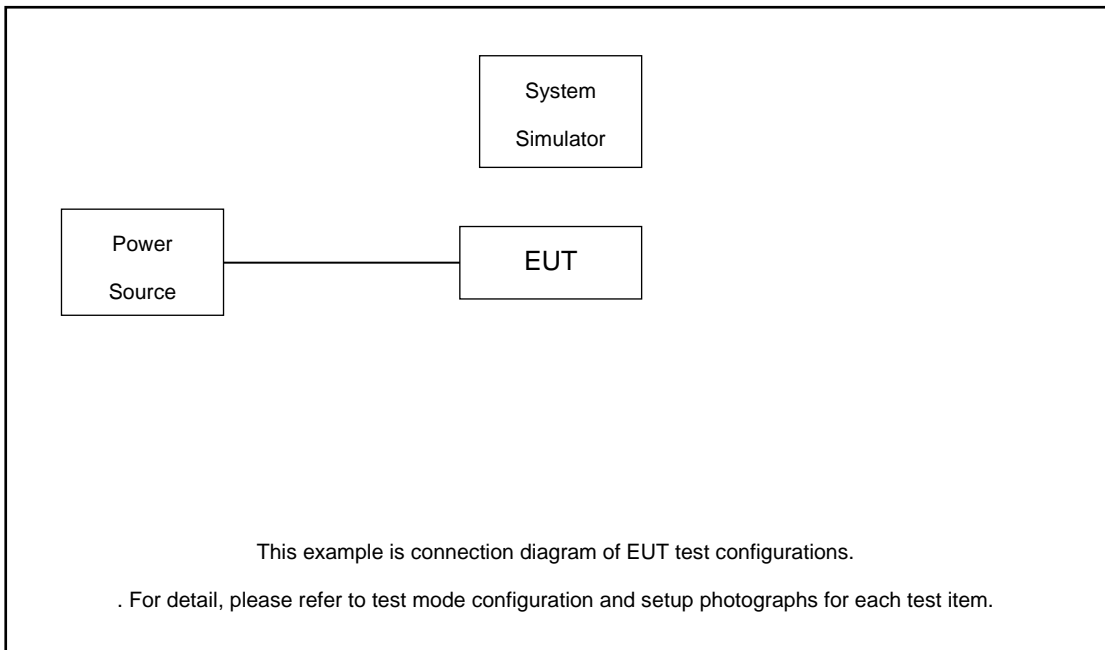

## 2.3 Support Unit used in test configuration and system

Item	Equipment	Trade Name	Model No.	FCC ID	Data Cable	Power Cord
1.	Power Supply	GWINSTEK	PSS-2002	N/A	N/A	Unshielded, 1.8 m
2.	LTE Base Station	Anritsu	MT8820C	N/A	N/A	Unshielded, 1.8 m

## 2.4 Measurement Results Explanation Example

### For all conducted test items:

The offset level is set in the spectrum analyzer to compensate the RF cable loss and attenuator factor between EUT conducted output port and spectrum analyzer. With the offset compensation, the spectrum analyzer reading level is exactly the EUT RF output level.

The spectrum analyzer offset is derived from RF cable loss and attenuator factor.

$$\text{Offset} = \text{RF cable loss} + \text{attenuator factor}.$$

Following shows an offset computation example with cable loss 5.0 dB and 10dB attenuator.

Example :

$$\begin{aligned} \text{Offset(dB)} &= \text{RF cable loss(dB)} + \text{attenuator factor(dB)}. \\ &= 5.0 + 10 = 15.0 \text{ (dB)} \end{aligned}$$



### 2.5 Frequency List of Low/Middle/High Channels

LTE Band 7 Channel and Frequency List				
BW [MHz]	Channel/Frequency(MHz)	Lowest	Middle	Highest
20	Channel	20850	21100	21350
	Frequency	2510	2535	2560
15	Channel	20825	21100	21375
	Frequency	2507.5	2535	2562.5
10	Channel	20800	21100	21400
	Frequency	2505	2535	2565
5	Channel	20775	21100	21425
	Frequency	2502.5	2535	2567.5

LTE Band 38 Channel and Frequency List				
BW [MHz]	Channel/Frequency(MHz)	Lowest	Middle	Highest
20	Channel	37850	38000	38150
	Frequency	2580	2595	2610
15	Channel	37825	38000	38175
	Frequency	2577.5	2595	2612.5
10	Channel	37800	38000	38200
	Frequency	2575	2595	2615
5	Channel	37775	38000	38225
	Frequency	2572.5	2595	2617.5

LTE Band 41 Channel and Frequency List				
BW [MHz]	Channel/Frequency(MHz)	Lowest	Middle	Highest
20	Channel	39750	40620	41490
	Frequency	2506	2593	2680
15	Channel	39725	40620	41515
	Frequency	2503.5	2593	2682.5
10	Channel	39700	40620	41540
	Frequency	2501	2593	2685
5	Channel	39675	40620	41565
	Frequency	2498.5	2593	2687.5



LTE Band 7C_CA Channel and Frequency List					
BW [MHz]	Channel/Frequency(MHz)		Lowest	Middle	Highest
20 + 20	PCC	Channel	20850	21001	21152
		Frequency	2510.0	2525.1	2540.2
	SCC	Channel	21048	21199	21350
		Frequency	2529.8	2544.9	2560.0
20 + 15	PCC	Channel	20850	21026	21201
		Frequency	2510.0	2527.6	2545.1
	SCC	Channel	21021	21197	21372
		Frequency	2527.1	2544.7	2562.2
15 + 20	PCC	Channel	20828	21003	21179
		Frequency	2507.8	2525.3	2542.9
	SCC	Channel	20999	21174	21350
		Frequency	2524.9	2542.4	2560.0
20 + 10	PCC	Channel	20850	21051	21251
		Frequency	2510.0	2530.1	2550.1
	SCC	Channel	20994	21195	21395
		Frequency	2524.4	2544.5	2564.5
10 + 20	PCC	Channel	20805	21006	21206
		Frequency	2505.5	2525.6	2545.6
	SCC	Channel	20949	21150	21350
		Frequency	2519.9	2540.0	2560.0
15 + 15	PCC	Channel	20825	21025	21225
		Frequency	2507.5	2527.5	2547.5
	SCC	Channel	20975	21175	21375
		Frequency	2522.5	2542.5	2562.5
15 + 10	PCC	Channel	20825	21051	21277
		Frequency	2507.5	2530.1	2552.7
	SCC	Channel	20945	21171	21397
		Frequency	2519.5	2542.1	2564.7



LTE Band 38C_CA Channel and Frequency List					
BW [MHz]	Channel/Frequency(MHz)		Lowest	Middle	Highest
20 + 20	PCC	Channel	37850	37901	37952
		Frequency	2580.0	2585.1	2590.2
	SCC	Channel	38048	38099	38150
		Frequency	2599.8	2604.9	2610.0
15+ 15	PCC	Channel	37825	37925	38025
		Frequency	2577.5	2587.5	2597.5
	SCC	Channel	37975	38075	38175
		Frequency	2592.5	2602.5	2612.5

LTE Band 41C_CA Channel and Frequency List					
BW [MHz]	Channel/Frequency(MHz)		Lowest	Middle	Highest
20 + 20	PCC	Channel	39750	40521	41292
		Frequency	2506.0	2583.1	2660.2
	SCC	Channel	39948	40719	41490
		Frequency	2525.8	2602.9	2680.0
20 + 15	PCC	Channel	39750	40546	41341
		Frequency	2506.0	2585.6	2665.1
	SCC	Channel	39921	40717	41512
		Frequency	2523.1	2602.7	2682.2
15 + 20	PCC	Channel	39728	40523	41319
		Frequency	2503.8	2593.3	2662.9
	SCC	Channel	39899	40694	41490
		Frequency	2520.9	2600.4	2680.0
20 + 10	PCC	Channel	39750	40571	41391
		Frequency	2506.0	2588.1	2670.1
	SCC	Channel	39894	40715	41535
		Frequency	2520.4	2602.5	2684.5
10 + 20	PCC	Channel	39705	40526	41346
		Frequency	2501.5	2583.6	2665.6
	SCC	Channel	39849	40670	41490
		Frequency	2515.9	2598.0	2680.0





LTE Band 41C_CA Channel and Frequency List					
20 + 5	PCC	Channel	39750	40595	41440
		Frequency	2506.0	2590.5	2675.0
	SCC	Channel	39867	40712	41557
		Frequency	2517.7	2602.2	2686.7
5 + 20	PCC	Channel	39683	40528	41373
		Frequency	2499.3	2583.8	2668.3
	SCC	Channel	39800	40645	41490
		Frequency	2511.0	2595.5	2680.0
15 + 15	PCC	Channel	39725	40545	41365
		Frequency	2503.5	2585.5	2667.5
	SCC	Channel	39875	40695	41515
		Frequency	2518.5	2600.5	2682.5
10 + 15	PCC	Channel	39703	40549	41395
		Frequency	2501.3	2585.9	2670.5
	SCC	Channel	39823	40669	41515
		Frequency	2513.3	2597.9	2682.5
15 + 10	PCC	Channel	39725	40571	41417
		Frequency	2503.5	2588.1	2672.7
	SCC	Channel	39845	40691	41537
		Frequency	2515.5	2600.1	2684.7

### 3 Conducted Test Items

#### 3.1 Measuring Instruments

See list of measuring instruments of this test report.

#### 3.2 Test Setup

##### 3.2.1 Conducted Output Power



##### 3.2.2 Peak-to-Average Ratio, Occupied Bandwidth ,Conducted Band-Edge and Conducted Spurious Emission



##### 3.2.3 Frequency Stability

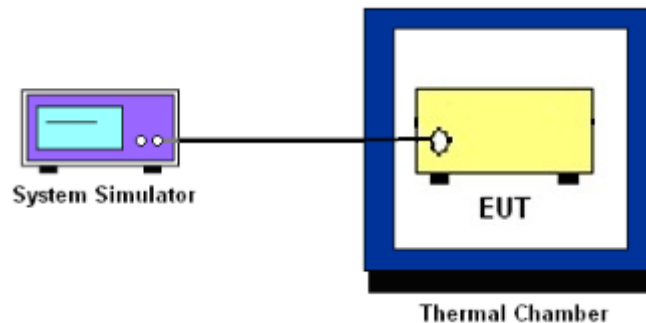

### 3.3 Test Result of Conducted Test

Please refer to Appendix A.



### 3.4 Conducted Output Power and ERP/EIRP

#### 3.4.1 Description of the Conducted Output Power Measurement and ERP/EIRP Measurement

A system simulator was used to establish communication with the EUT. Its parameters were set to force the EUT transmitting at maximum output power. The measured power in the radio frequency on the transmitter output terminals shall be reported.

The EIRP of mobile transmitters must not exceed 2 Watts for LTE Band 7 and Band 38 and Band 41.

According to KDB 412172 D01 Power Approach,

$EIRP = P_T + G_T - L_C$ ,  $ERP = EIRP - 2.15$ , where

$P_T$  = transmitter output power in dBm

$G_T$  = gain of the transmitting antenna in dBi

$L_C$  = signal attenuation in the connecting cable between the transmitter and antenna in dB

#### 3.4.2 Test Procedures

1. The testing follows ANSI C63.26 Section 5.2
2. The transmitter output port was connected to the system simulator.
3. Set EUT at maximum power through the system simulator.
4. Select lowest, middle, and highest channels for each band and different modulation.
5. Measure and record the power level from the system simulator.



## **3.5 Peak-to-Average Ratio**

### **3.5.1 Description of the PAR Measurement**

Power Complementary Cumulative Distribution Function (CCDF) curves provide a means for characterizing the power peaks of a digitally modulated signal on a statistical basis. A CCDF curve depicts the probability of the peak signal amplitude exceeding the average power level. Most contemporary measurement instrumentation include the capability to produce CCDF curves for an input signal provided that the instrument's resolution bandwidth can be set wide enough to accommodate the entire input signal bandwidth. In measuring transmissions in this band using an average power technique, the peak-to-average ratio (PAR) of the transmission may not exceed 13 dB.

### **3.5.2 Test Procedures**

1. The testing follows ANSI C63.26 Section 5.2.3.4 (CCDF).
2. The EUT was connected to spectrum and system simulator via a power divider.
3. Set the CCDF (Complementary Cumulative Distribution Function) option in spectrum analyzer.
4. The highest RF powers were measured and recorded the maximum PAPR level associated with a probability of 0.1 %.
5. Record the deviation as Peak to Average Ratio.



### 3.6 Occupied Bandwidth

#### 3.6.1 Description of Occupied Bandwidth Measurement

The occupied bandwidth is the width of a frequency band such that, below the lower and above the upper frequency limits, the mean powers emitted are each equal to a specified percentage 0.5% of the total mean transmitted power.

The 26 dB emission bandwidth is defined as the frequency range between two points, one above and one below the carrier frequency, at which the spectral density of the emission is attenuated 26 dB below the maximum in-band spectral density of the modulated signal. Spectral density (power per unit bandwidth) is to be measured with a detector of resolution bandwidth equal to approximately 1.0% of the emission bandwidth.

#### 3.6.2 Test Procedures

1. The testing follows ANSI C63.26 Section 5.4
2. The EUT was connected to spectrum analyzer and system simulator via a power divider.
3. The spectrum analyzer center frequency is set to the nominal EUT channel center frequency. The span range for the spectrum analyzer shall be between two and five times the anticipated OBW.
4. The nominal resolution bandwidth (RBW) shall be in the range of 1 to 5 % of the anticipated OBW, and the VBW shall be at least 3 times the RBW.
5. Set the detection mode to peak, and the trace mode to max hold.
6. Determine the reference value: Set the EUT to transmit a modulated signal. Allow the trace to stabilize. Set the spectrum analyzer marker to the highest level of the displayed trace.  
(this is the reference value)
7. Determine the “-26 dB down amplitude” as equal to (Reference Value – X).
8. Place two markers, one at the lowest and the other at the highest frequency of the envelope of the spectral display such that each marker is at or slightly below the “-X dB down amplitude” determined in step 6. If a marker is below this “-X dB down amplitude” value it shall be placed as close as possible to this value. The OBW is the positive frequency difference between the two markers.
9. Use the 99 % power bandwidth function of the spectrum analyzer and report the measured bandwidth.



### 3.7 Conducted Band Edge

#### 3.7.1 Description of Conducted Band Edge Measurement

27.53(m)(4)

For mobile digital stations, the attenuation factor shall be not less than  $40 + 10 \log (P)$  dB on all frequencies between the channel edge and 5 megahertz from the channel edge,  $43 + 10 \log (P)$  dB on all frequencies between 5 megahertz and X megahertz from the channel edge, and  $55 + 10 \log (P)$  dB on all frequencies more than X megahertz from the channel edge, where X is the greater of 6 megahertz or the actual emission bandwidth as defined in paragraph (m)(6) of this section. In addition, the attenuation factor shall not be less that  $43 + 10 \log (P)$  dB on all frequencies between 2490.5 MHz and 2496 MHz and  $55 + 10 \log (P)$  dB at or below 2490.5 MHz. Mobile Satellite Service licensees operating on frequencies below 2495 MHz may also submit a documented interference complaint against BRS licensees operating on channel BRS Channel 1 on the same terms and conditions as adjacent channel BRS or EBS licensees.

#### 3.7.2 Test Procedures

1. The testing follows ANSI C63.26 section 5.7
2. The EUT was connected to spectrum analyzer and system simulator via a power divider.
3. The band edges of low and high channels for the highest RF powers were measured.
4. Set RBW  $\geq 1\%$  EBW in the 1MHz band immediately outside and adjacent to the band edge.
5. Beyond the 1 MHz band from the band edge, RBW=1MHz was used or a narrower RBW was used and the measured power was integrated over the full required measurement bandwidth of 1 MHz.
6. Set spectrum analyzer with RMS detector.
7. The RF fundamental frequency should be excluded against the limit line in the operating frequency band.
8. Checked that all the results comply with the emission limit line.
9. When using the integration method, the starting frequency of the integration shall be centered at one-half of the RBW away from the band edge.



### 3.8 Conducted Spurious Emission

#### 3.8.1 Description of Conducted Spurious Emission Measurement

The power of any emission outside of the authorized operating frequency ranges must be lower than the transmitter power (P) by a factor of at least  $55 + 10 \log (P)$  dB.

It is measured by means of a calibrated spectrum analyzer and scanned from 30 MHz up to a frequency including its 10<sup>th</sup> harmonic.

#### 3.8.2 Test Procedures

1. The testing follows ANSI C63.26 section 5.7
2. The EUT was connected to spectrum analyzer and system simulator via a power divider.
3. The RF output of EUT was connected to the spectrum analyzer by RF cable and attenuator. The path loss was compensated to the results for each measurement.
4. The middle channel for the highest RF power within the transmitting frequency was measured.
5. The conducted spurious emission for the whole frequency range was taken.
6. Make the measurement with the spectrum analyzer's RBW = 1MHz, VBW = 3MHz.
7. Set spectrum analyzer with RMS detector.
8. Taking the record of maximum spurious emission.
9. The RF fundamental frequency should be excluded against the limit line in the operating frequency band.
10. The limit line is derived from  $55 + 10\log(P)$ dB below the transmitter power P(Watts)  
=  $P(W) - [55 + 10\log(P)]$  (dB)  
=  $[30 + 10\log(P)]$  (dBm) -  $[55 + 10\log(P)]$  (dB)  
= -25dBm.



## 3.9 Frequency Stability

### 3.9.1 Description of Frequency Stability Measurement

The frequency stability shall be measured by variation of ambient temperature and variation of primary supply voltage to ensure that the fundamental emission stays within the authorized frequency block. The frequency stability of the transmitter shall be maintained within  $\pm 0.00025\%$  ( $\pm 2.5\text{ppm}$ ) of the center frequency.

### 3.9.2 Test Procedures for Temperature Variation

1. The testing follows ANSI C63.26 section 5.6.4
2. The EUT was set up in the thermal chamber and connected with the system simulator.
3. With power OFF, the temperature was decreased to  $-30^{\circ}\text{C}$  and the EUT was stabilized before testing. Power was applied and the maximum change in frequency was recorded within one minute.
4. With power OFF, the temperature was raised in  $10^{\circ}\text{C}$  step up to  $50^{\circ}\text{C}$ . The EUT was stabilized at each step for at least half an hour. Power was applied and the maximum frequency change was recorded within one minute.

### 3.9.3 Test Procedures for Voltage Variation

1. The testing follows ANSI C63.26 section 5.6.5
2. The EUT was placed in a temperature chamber at  $20\pm 5^{\circ}\text{C}$  and connected with the system simulator.
3. The power supply voltage to the EUT was varied from 85% to 115% of the nominal value for other than hand carried battery equipment.
4. For hand carried, battery powered equipment, reduce the primary ac or dc supply voltage to the battery operating end point, which shall be specified by the manufacturer.
5. The variation in frequency was measured for the worst case.



## 4 Radiated Test Items

### 4.1 Measuring Instruments

See list of measuring instruments of this test report.

### 4.2 Test Setup

#### 4.2.1 For radiated test below 30MHz

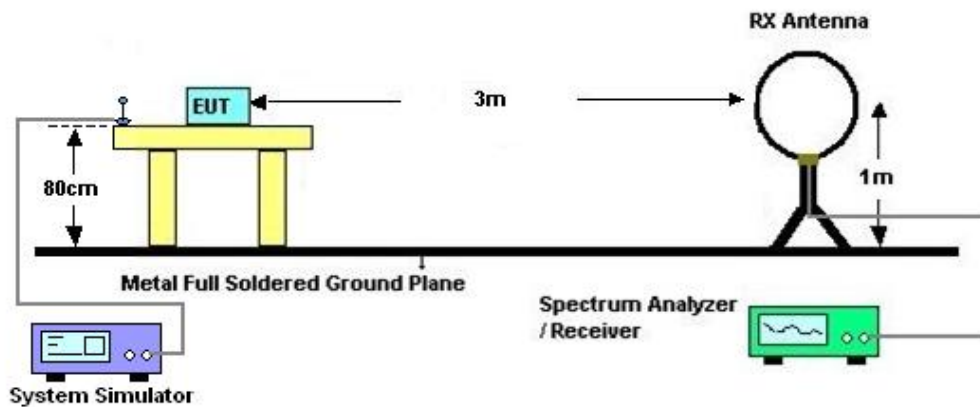

#### 4.2.2 For radiated test from 30MHz to 1GHz

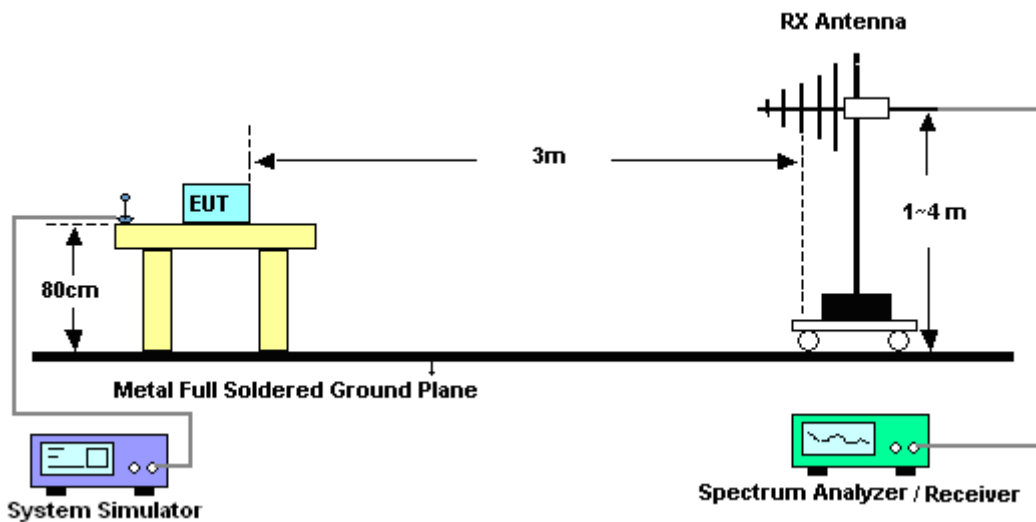

#### 4.2.3 For radiated test above 1GHz

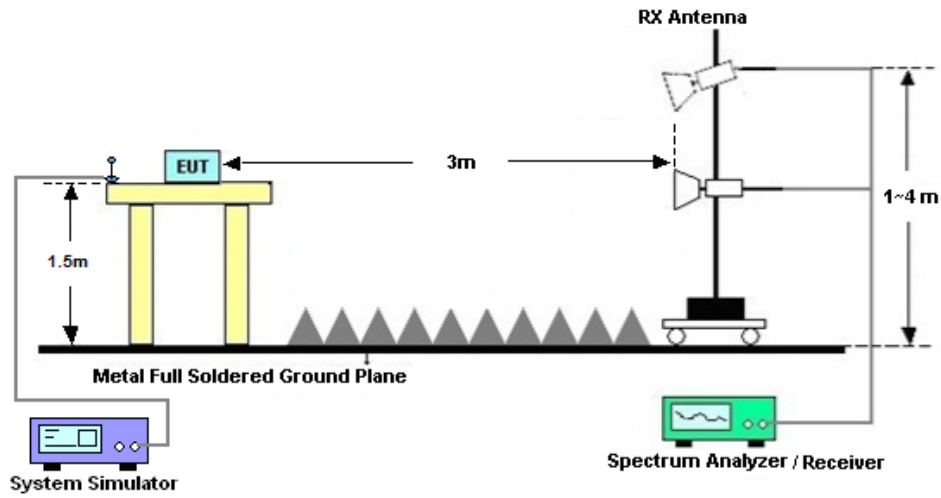

### 4.3 Test Result of Radiated Test

The low frequency, which started from 9 kHz to 30MHz, was pre-scanned and the result which was 20dB lower than the limit line was not reported.

Please refer to Appendix B.



## 4.4 Radiated Spurious Emission

### 4.4.1 Description of Radiated Spurious Emission

The power of any emission outside of the authorized operating frequency ranges must be attenuated below the transmitter power (P) by a factor of at least  $55 + 10 \log (P)$  dB.

The spectrum is scanned from 30 MHz up to a frequency including its 10th harmonic.

### 4.4.2 Test Procedures

1. The testing follows ANSI C63.26 Section 5.5
2. The EUT was placed on a turntable with 0.8 meter height for frequency below 1GHz and 1.5 meter height for frequency above 1GHz respectively above ground.
3. The EUT was set 3 meters from the receiving antenna mounted on the antenna tower.
4. The table was rotated 360 degrees to determine the position of the highest spurious emission.
5. The height of the receiving antenna is varied between 1m to 4m to search the maximum spurious emission for both horizontal and vertical polarizations.
6. During the measurement, the system simulator parameters were set to force the EUT transmitting at maximum output power.
7. Make the measurement with the spectrum analyzer's RBW = 1MHz, VBW = 3MHz, taking the record of maximum spurious emission.
8. A horn antenna was substituted in place of the EUT and was driven by a signal generator.
9. Tune the output power of signal generator to the same emission level with EUT maximum spurious emission.
10.  $EIRP \text{ (dBm)} = S.G. \text{ Power} - Tx \text{ Cable Loss} + Tx \text{ Antenna Gain}$
11.  $ERP \text{ (dBm)} = EIRP - 2.15$
12. The RF fundamental frequency should be excluded against the limit line in the operating frequency band.



## 5 List of Measuring Equipment

Instrument	Manufacturer	Model No.	Serial No.	Characteristics	Calibration Date	Test Date	Due Date	Remark
Spectrum Analyzer	R&S	FSV40	101078	10Hz~40GHz	Apr. 06, 2023	Dec. 29, 2023~Jan. 12, 2024	Apr. 05, 2024	Conducted (TH01-SZ)
DC Power Supply	TTI	PL330P	290070	Max 32V , 3A	Oct. 16, 2023	Dec. 29, 2023~Jan. 12, 2024	Oct. 15, 2024	Conducted (TH01-SZ)
Power Divider	TOJOIN	PS-2SM-04 265	60.06.020.007 7	0.4GHz~26.5GHz	Dec. 25, 2023	Dec. 29, 2023~Jan. 12, 2024	Dec. 24, 2024	Conducted (TH01-SZ)
Thermal Chamber	Ten Billion Hongzhangroup	LP-150U	H2014081803	-40~+150°C	Jul. 05, 2023	Dec. 29, 2023~Jan. 12, 2024	Jul. 04, 2024	Conducted (TH01-SZ)
EXA Spectrum Analyzer	Keysight	N9010B	MY57471079	10Hz-44G,MAX 30dB	Oct. 10, 2023	Jan. 15, 2024	Oct. 09, 2024	Radiation (03CH04-KS)
Loop Antenna	R&S	HFH2-Z2E	101125	9kHz~30MHz	Sep. 11 2023	Jan. 15, 2024	Sep. 10, 2024	Radiation (03CH04-KS)
Bilog Antenna	TeseQ	CBL6111D	49922	30MHz-1GHz	Apr. 09, 2023	Jan. 15, 2024	Apr. 08, 2024	Radiation (03CH04-KS)
Horn Antenna	Schwarzbeck	BBHA9120D	1284	1GHz~18GHz	Oct. 10, 2023	Jan. 15, 2024	Oct. 09, 2024	Radiation (03CH04-KS)
SHF-EHF Horn	Com-power	AH-840	101070	18GHz~40GHz	Jan. 05, 2024	Jan. 15, 2024	Jan. 04, 2025	Radiation (03CH04-KS)
Amplifier	SONOMA	310N	380827	9KHz-1GHz	Jul. 06, 2023	Jan. 15, 2024	Jul. 05, 2024	Radiation (03CH04-KS)
Amplifier	MITEQ	EM18G40G GA	060728	18~40GHz	Jan. 05, 2024	Jan. 15, 2024	Jan. 04, 2025	Radiation (03CH04-KS)
high gain Amplifier	EM	EM01G18G A	060840	1Ghz-18Ghz	Oct. 10, 2023	Jan. 15, 2024	Oct. 09, 2024	Radiation (03CH04-KS)
Amplifier	Agilent	8449B	3008A02370	1Ghz-18Ghz	Oct. 10, 2023	Jan. 15, 2024	Oct. 09, 2024	Radiation (03CH04-KS)
AC Power Source	Chroma	61601	F104090004	N/A	NCR	Jan. 15, 2024	NCR	Radiation (03CH04-KS)
Turn Table	ChamPro	EM 1000-T	060762-T	0~360 degree	NCR	Jan. 15, 2024	NCR	Radiation (03CH04-KS)
Antenna Mast	ChamPro	EM 1000-A	060762-A	1 m~4 m	NCR	Jan. 15, 2024	NCR	Radiation (03CH04-KS)

NCR: No Calibration Required



## 6 Measurement Uncertainty

The measurement uncertainties shown below were calculated in accordance with the requirements of ANSI 63.26-2015. All the measurement uncertainty value were shown with a coverage K=2 to indicate 95% level of confidence. The measurement data show herein meets or exceeds the CISPR measurement uncertainty values specified in CISPR 16-4-2 and can be compared directly to specified limit to determine compliance.

### Uncertainty of Conducted Measurement

Test Item	Uncertainty
Conducted Spurious Emission & Bandedge	±1.34 dB
Occupied Channel Bandwidth	±0.012 MHz
Conducted Power	±1.34 dB
Peak to Average Ratio	±1.34 dB
Frequency Stability	±1.3 Hz

### Uncertainty of Radiated Emission Measurement (9 KHz ~ 30 MHz)

Measuring Uncertainty for a Level of Confidence of 95% (U = 2Uc(y))	3.82
---------------------------------------------------------------------	------

### Uncertainty of Radiated Emission Measurement (30 MHz ~ 1000 MHz)

Measuring Uncertainty for a Level of Confidence of 95% (U = 2Uc(y))	3.56
---------------------------------------------------------------------	------

### Uncertainty of Radiated Emission Measurement (1 GHz ~ 40 GHz)

Measuring Uncertainty for a Level of Confidence of 95% (U = 2Uc(y))	3.54
---------------------------------------------------------------------	------

----- THE END -----



### Appendix A. Test Results of Conducted Test

Test Engineer :	Hank Lin	Temperature :	24~26°C
		Relative Humidity :	50~53%

### Conducted Output Power(Average power) and ERP/EIRP

#### LTE Band 7\_Ant.2:

BW [MHz]	Modulation	RB Size	RB Offset	Power Low Ch. / Freq.	Power Middle Ch. / Freq.	Power High Ch. / Freq.	EIRP(W)		
Channel				20850	20850	21350			
Frequency (MHz)				2510	2535	2560	L	M	H
20	QPSK	1	0	22.75	22.80	22.72	0.0785	0.0794	0.0780
20	QPSK	1	99	22.69	22.71	22.67	0.0774	0.0778	0.0771
20	QPSK	100	0	21.69	21.76	21.69	0.0615	0.0625	0.0615
20	16QAM	1	0	21.64	21.73	21.68	0.0608	0.0621	0.0614
20	64QAM	1	0	20.58	20.69	20.62	0.0476	0.0489	0.0481
20	256QAM	1	0	17.72	17.77	17.80	0.0247	0.0249	0.0251
Channel				20825	21100	21375	EIRP(W)		
Frequency (MHz)				2507.5	2535	2562.5	L	M	H
15	QPSK	1	0	22.67	22.67	22.58	0.0771	0.0771	0.0755
15	16QAM	1	0	21.53	21.63	21.61	0.0593	0.0607	0.0604
Channel				20800	21100	21400	EIRP(W)		
Frequency (MHz)				2505	2535	2565	L	M	H
10	QPSK	1	0	22.68	22.72	22.59	0.0773	0.0780	0.0757
10	16QAM	1	0	21.51	21.68	21.54	0.0590	0.0614	0.0594
Channel				20775	21100	21425	EIRP(W)		
Frequency (MHz)				2502.5	2535	2567.5	L	M	H
5	QPSK	1	0	22.70	22.65	22.67	0.0776	0.0767	0.0771
5	16QAM	1	0	21.51	21.62	21.54	0.0590	0.0605	0.0594



LTE Band 38\_Ant.2:

BW [MHz]	Modulation	RB Size	RB Offset	Power Low Ch. / Freq.	Power Middle Ch. / Freq.	Power High Ch. / Freq.	EIRP(W)		
Channel				37850	38000	38150	EIRP(W)		
Frequency (MHz)				2580	2595	2610	L	M	H
20	QPSK	1	0	25.22	25.35	25.27	0.1387	0.1429	0.1403
20	QPSK	1	99	25.15	25.23	25.23	0.1365	0.1390	0.1390
20	QPSK	100	0	24.21	24.36	24.12	0.1099	0.1138	0.1076
20	16QAM	1	0	24.15	24.30	24.20	0.1084	0.1122	0.1096
20	64QAM	1	0	23.22	23.43	23.29	0.0875	0.0918	0.0889
20	256QAM	1	0	20.45	20.56	20.50	0.0462	0.0474	0.0468
Channel				37825	38000	38175	EIRP(W)		
Frequency (MHz)				2577.5	2595	2612.5	L	M	H
15	QPSK	1	0	25.17	25.24	25.11	0.1371	0.1393	0.1352
15	16QAM	1	0	24.05	24.22	24.05	0.1059	0.1102	0.1059
Channel				37800	38000	38200	EIRP(W)		
Frequency (MHz)				2575	2595	2615	L	M	H
10	QPSK	1	0	25.06	25.24	25.21	0.1337	0.1393	0.1384
10	16QAM	1	0	24.08	24.19	24.08	0.1067	0.1094	0.1067
Channel				37775	38000	38225	EIRP(W)		
Frequency (MHz)				2572.5	2595	2617.5	L	M	H
5	QPSK	1	0	25.17	25.19	25.19	0.1371	0.1377	0.1377
5	16QAM	1	0	24.04	24.21	24.07	0.1057	0.1099	0.1064



LTE Band 41\_Ant.2:

BW [MHz]	Modulation	RB Size	RB Offset	Power Low Ch. / Freq.	Power Middle Ch. / Freq.	Power High Ch. / Freq.	EIRP(W)		
Channel				39750	40620	41490	EIRP(W)		
Frequency (MHz)				2506	2593	2680	L	M	H
20	QPSK	1	0	25.36	25.45	25.31	0.1432	0.1462	0.1416
20	QPSK	1	99	25.26	25.31	25.19	0.1400	0.1416	0.1377
20	QPSK	100	0	24.39	24.50	24.42	0.1146	0.1175	0.1153
20	16QAM	1	0	24.38	24.48	24.38	0.1143	0.1169	0.1143
20	64QAM	1	0	23.32	23.49	23.27	0.0895	0.0931	0.0885
20	256QAM	1	0	20.36	20.49	20.41	0.0453	0.0467	0.0458
Channel				39725	40620	41515	EIRP(W)		
Frequency (MHz)				2503.5	2593	2682.5	L	M	H
15	QPSK	1	0	25.24	25.40	25.16	0.1393	0.1445	0.1368
15	16QAM	1	0	24.29	24.35	24.25	0.1119	0.1135	0.1109
Channel				39700	40620	41540	EIRP(W)		
Frequency (MHz)				2501	2593	2685	L	M	H
10	QPSK	1	0	25.31	25.35	25.15	0.1416	0.1429	0.1365
10	16QAM	1	0	24.30	24.34	24.23	0.1122	0.1132	0.1104
Channel				39675	40620	41565	EIRP(W)		
Frequency (MHz)				2498.5	2593	2687.5	L	M	H
5	QPSK	1	0	25.26	25.40	25.20	0.1400	0.1445	0.1380
5	16QAM	1	0	24.26	24.33	24.29	0.1112	0.1130	0.1119





**CA Power and ERP/EIRP**

**LTE Band 7C\_Ant.2:**

Combination 20MHz+20MHz (100RB+100RB)							
Channel	Modulation	PCC		SCC		Measured Power	EIRP(W)
		RB Size	RB offset	RB Size	RB offset		
L	QPSK	1	Max	1	0	22.63	0.0764
M	QPSK	1	Max	1	0	22.66	0.0769
H	QPSK	1	Max	1	0	22.62	0.0762
L	16QAM	1	Max	1	0	21.59	0.0601
M	16QAM	1	Max	1	0	21.62	0.0605
H	16QAM	1	Max	1	0	21.58	0.0600
L	64QAM	1	Max	1	0	20.55	0.0473
M	64QAM	1	Max	1	0	20.58	0.0476
H	64QAM	1	Max	1	0	20.54	0.0472
L	256QAM	1	Max	1	0	17.66	0.0243
M	256QAM	1	Max	1	0	17.69	0.0245
H	256QAM	1	Max	1	0	17.65	0.0243
Combination 20MHz+15MHz (100RB+75RB)							
Channel	Modulation	PCC		SCC		Measured Power	EIRP(W)
		RB Size	RB offset	RB Size	RB offset		
M	QPSK	1	Max	1	0	22.63	0.0764
M	16QAM	1	Max	1	0	21.59	0.0601
Combination 15MHz+20MHz (75RB+100RB)							
Channel	Modulation	PCC		SCC		Measured Power	EIRP(W)
		RB Size	RB offset	RB Size	RB offset		
M	QPSK	1	Max	1	0	22.61	0.0760
M	16QAM	1	Max	1	0	21.58	0.0600
Combination 15MHz+15MHz (75RB+75RB)							
Channel	Modulation	PCC		SCC		Measured Power	EIRP(W)
		RB Size	RB offset	RB Size	RB offset		
M	QPSK	1	Max	1	0	22.60	0.0759
M	16QAM	1	Max	1	0	21.51	0.0590
Combination 20MHz+10MHz (100RB+50RB)							
Channel	Modulation	PCC		SCC		Measured Power	EIRP(W)
		RB Size	RB offset	RB Size	RB offset		
M	QPSK	1	Max	1	0	22.59	0.0757
M	16QAM	1	Max	1	0	21.49	0.0587
Combination 10MHz+20MHz (50RB+100RB)							
Channel	Modulation	PCC		SCC		Measured Power	EIRP(W)
		RB Size	RB offset	RB Size	RB offset		
M	QPSK	1	Max	1	0	22.57	0.0753
M	16QAM	1	Max	1	0	21.45	0.0582
Combination 15MHz+10MHz (75RB+50RB)							
Channel	Modulation	PCC		SCC		Measured Power	EIRP(W)
		RB Size	RB offset	RB Size	RB offset		
M	QPSK	1	Max	1	0	22.60	0.0759
M	16QAM	1	Max	1	0	21.43	0.0579



LTE Band 38C\_Ant.2:

Combination 20MHz+20MHz (100RB+100RB)							
Channel	Modulation	PCC		SCC		Measured Power	EIRP(W)
		RB Size	RB offset	RB Size	RB offset		
L	QPSK	1	Max	1	0	25.11	0.1352
M	QPSK	1	Max	1	0	25.16	0.1368
H	QPSK	1	Max	1	0	25.14	0.1361
L	16QAM	1	Max	1	0	24.10	0.1072
M	16QAM	1	Max	1	0	24.15	0.1084
H	16QAM	1	Max	1	0	24.13	0.1079
L	64QAM	1	Max	1	0	23.22	0.0875
M	64QAM	1	Max	1	0	23.27	0.0885
H	64QAM	1	Max	1	0	23.25	0.0881
L	256QAM	1	Max	1	0	20.39	0.0456
M	256QAM	1	Max	1	0	20.44	0.0461
H	256QAM	1	Max	1	0	20.42	0.0459
Combination 15MHz+15MHz (75RB+75RB)							
Channel	Modulation	PCC		SCC		Measured Power	EIRP(W)
		RB Size	RB offset	RB Size	RB offset		
M	QPSK	1	Max	1	0	25.11	0.1352
M	16QAM	1	Max	1	0	24.10	0.1072

LTE Band 41C\_Ant.2:

Combination 20MHz+20MHz (100RB+100RB)							
Channel	Modulation	PCC		SCC		Measured Power	EIRP(W)
		RB Size	RB offset	RB Size	RB offset		
L	QPSK	1	Max	1	0	25.17	0.1371
M	QPSK	1	Max	1	0	25.33	0.1422
H	QPSK	1	Max	1	0	25.15	0.1365
L	16QAM	1	Max	1	0	24.27	0.1114
M	16QAM	1	Max	1	0	24.43	0.1156
H	16QAM	1	Max	1	0	24.25	0.1109
L	64QAM	1	Max	1	0	23.29	0.0889
M	64QAM	1	Max	1	0	23.45	0.0923
H	64QAM	1	Max	1	0	23.27	0.0885
L	256QAM	1	Max	1	0	20.30	0.0447
M	256QAM	1	Max	1	0	20.46	0.0463
H	256QAM	1	Max	1	0	20.28	0.0445
Combination 20MHz+15MHz (100RB+75RB)							
Channel	Modulation	PCC		SCC		Measured Power	EIRP(W)
		RB Size	RB offset	RB Size	RB offset		
M	QPSK	1	Max	1	0	25.24	0.1393
M	16QAM	1	Max	1	0	24.33	0.1130
Combination 15MHz+20MHz (75RB+100RB)							
Channel	Modulation	PCC		SCC		Measured Power	EIRP(W)
		RB Size	RB offset	RB Size	RB offset		
M	QPSK	1	Max	1	0	25.27	0.1403



M	16QAM	1	Max	1	0	24.13	0.1079
Combination 15MHz+15MHz (75RB+75RB)							
Channel	Modulation	PCC		SCC		Measured Power	EIRP(W)
		RB Size	RB offset	RB Size	RB offset		
M	QPSK	1	Max	1	0	25.28	0.1406
M	16QAM	1	Max	1	0	24.22	0.1102
Combination 20MHz+10MHz (100RB+50RB)							
Channel	Modulation	PCC		SCC		Measured Power	EIRP(W)
		RB Size	RB offset	RB Size	RB offset		
M	QPSK	1	Max	1	0	25.31	0.1416
M	16QAM	1	Max	1	0	24.17	0.1089
Combination 10MHz+20MHz (50RB+100RB)							
Channel	Modulation	PCC		SCC		Measured Power	EIRP(W)
		RB Size	RB offset	RB Size	RB offset		
M	QPSK	1	Max	1	0	25.26	0.1400
M	16QAM	1	Max	1	0	24.21	0.1099
Combination 15MHz+10MHz (75RB+50RB)							
Channel	Modulation	PCC		SCC		Measured Power	EIRP(W)
		RB Size	RB offset	RB Size	RB offset		
M	QPSK	1	Max	1	0	25.28	0.1406
M	16QAM	1	Max	1	0	24.24	0.1107
Combination 10MHz+15MHz (50RB+75RB)							
Channel	Modulation	PCC		SCC		Measured Power	EIRP(W)
		RB Size	RB offset	RB Size	RB offset		
M	QPSK	1	Max	1	0	25.22	0.1387
M	16QAM	1	Max	1	0	24.13	0.1079
Combination 20MHz+5MHz (100RB+25RB)							
Channel	Modulation	PCC		SCC		Measured Power	EIRP(W)
		RB Size	RB offset	RB Size	RB offset		
M	QPSK	1	Max	1	0	25.27	0.1403
M	16QAM	1	Max	1	0	24.11	0.1074
Combination 5MHz+20MHz (25RB+100RB)							
Channel	Modulation	PCC		SCC		Measured Power	EIRP(W)
		RB Size	RB offset	RB Size	RB offset		
M	QPSK	1	Max	1	0	25.23	0.1390
M	16QAM	1	Max	1	0	24.17	0.1089



# LTE Band 7

## Peak-to-Average Ratio

Mode	LTE Band 7 / 20MHz			
Mod.	QPSK	16QAM	64QAM	Limit: 13dB
RB Size	Full RB	Full RB	Full RB	Result
Middle CH	5.01	6.06	6.61	PASS

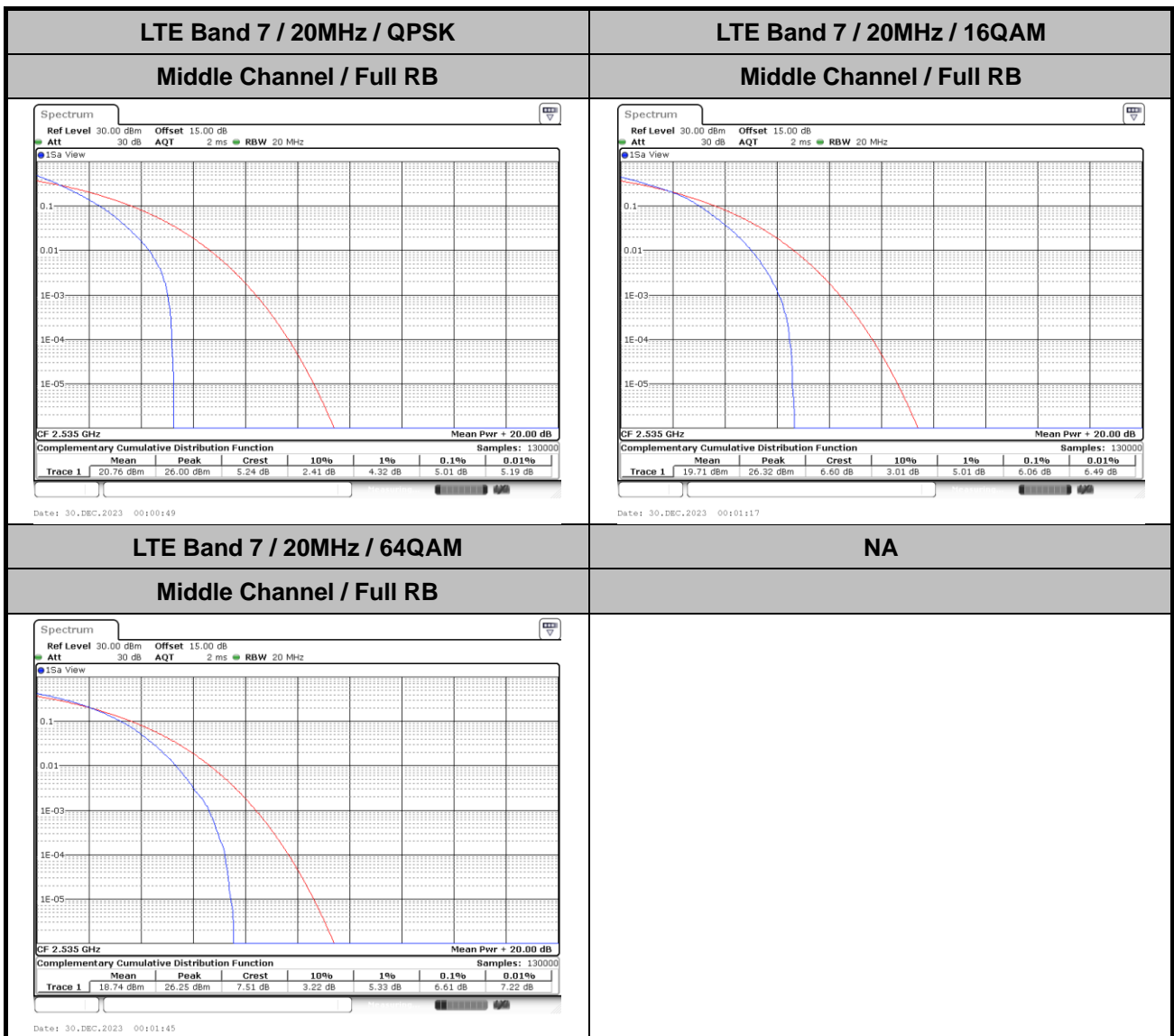



# 26dB Bandwidth

Mode	LTE Band 7 : 26dB BW(MHz)											
	BW		-		5MHz		10MHz		15MHz		20MHz	
Mod.	-	-	-	-	QPSK	16QAM	QPSK	16QAM	QPSK	16QAM	QPSK	16QAM
Middle CH	-	-	-	-	5.12	5.02	10.03	10.09	14.72	14.42	19.38	19.38

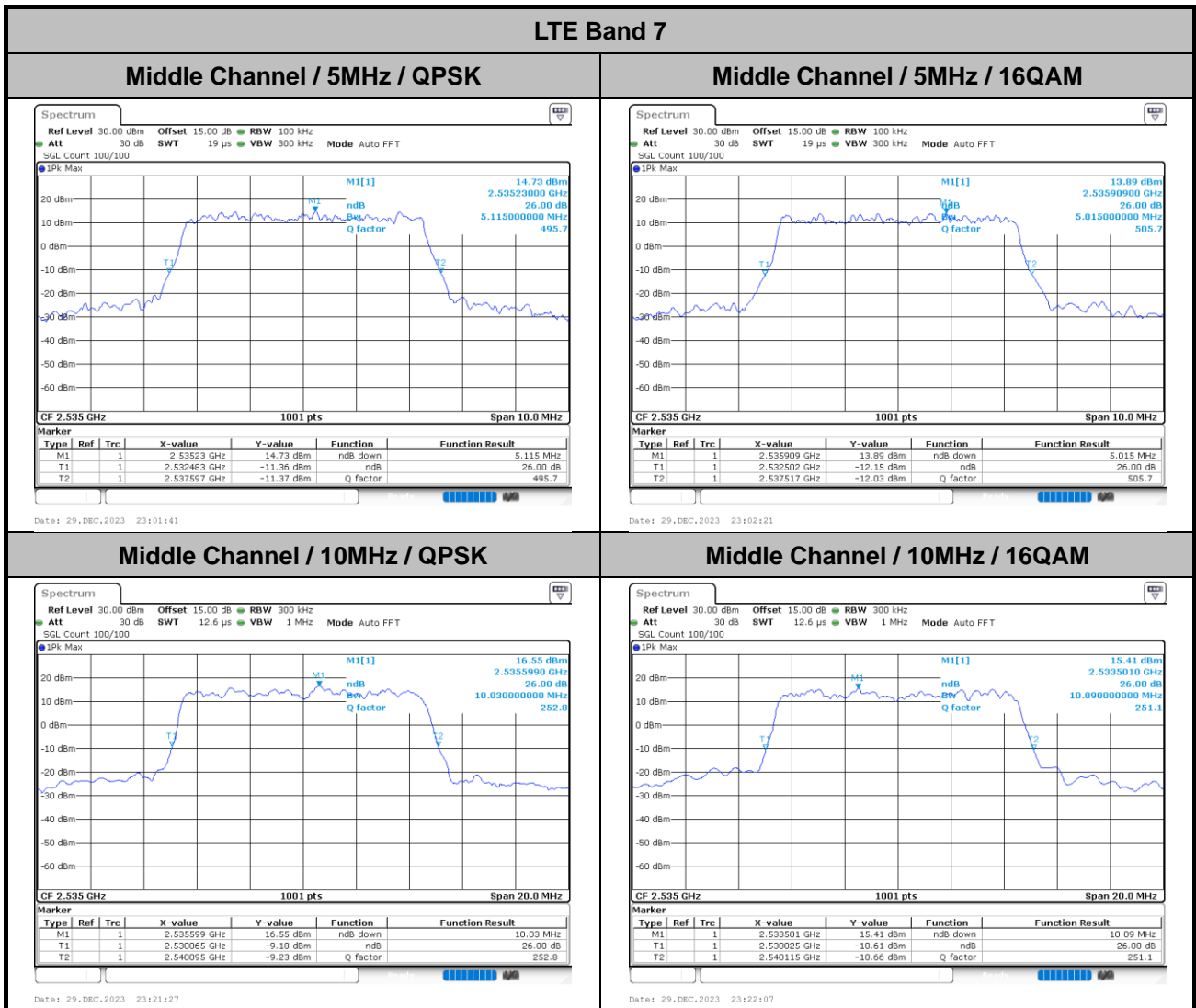



Middle Channel / 15MHz / QPSK

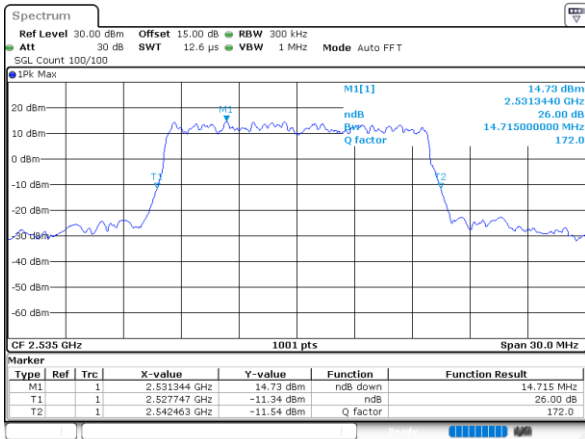

Date: 29, DEC, 2023 23:40:38

Middle Channel / 15MHz / 16QAM

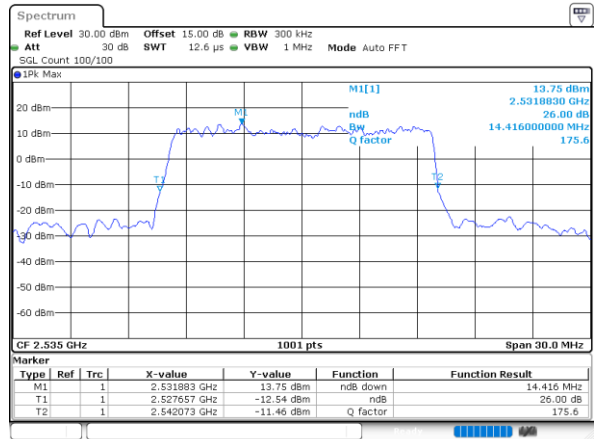

Date: 29, DEC, 2023 23:41:19

LTE Band 7

Middle Channel / 20MHz / QPSK

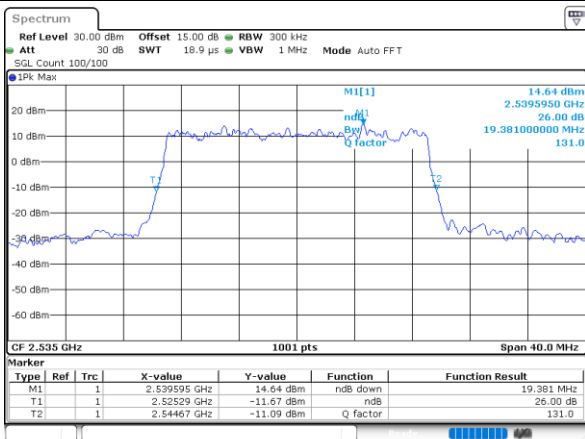

Date: 29, DEC, 2023 23:59:41

Middle Channel / 20MHz / 16QAM

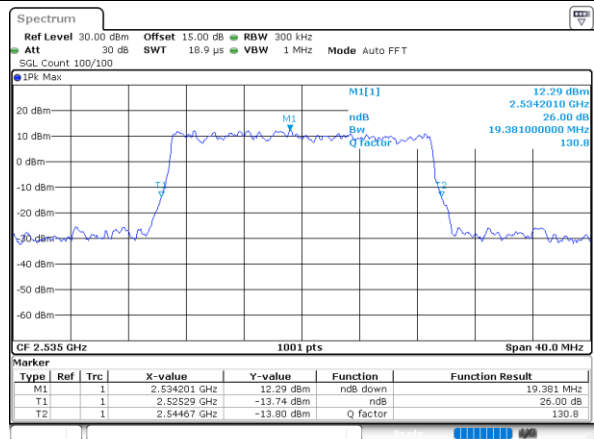

Date: 30, DEC, 2023 00:00:21



# Occupied Bandwidth

Mode	LTE Band 7 : 99%OBW(MHz)											
	BW		-		5MHz		10MHz		15MHz		20MHz	
Mod.	-	-	-	-	QPSK	16QAM	QPSK	16QAM	QPSK	16QAM	QPSK	16QAM
Middle CH	-	-	-	-	4.51	4.50	9.01	9.01	13.46	13.52	17.98	17.90

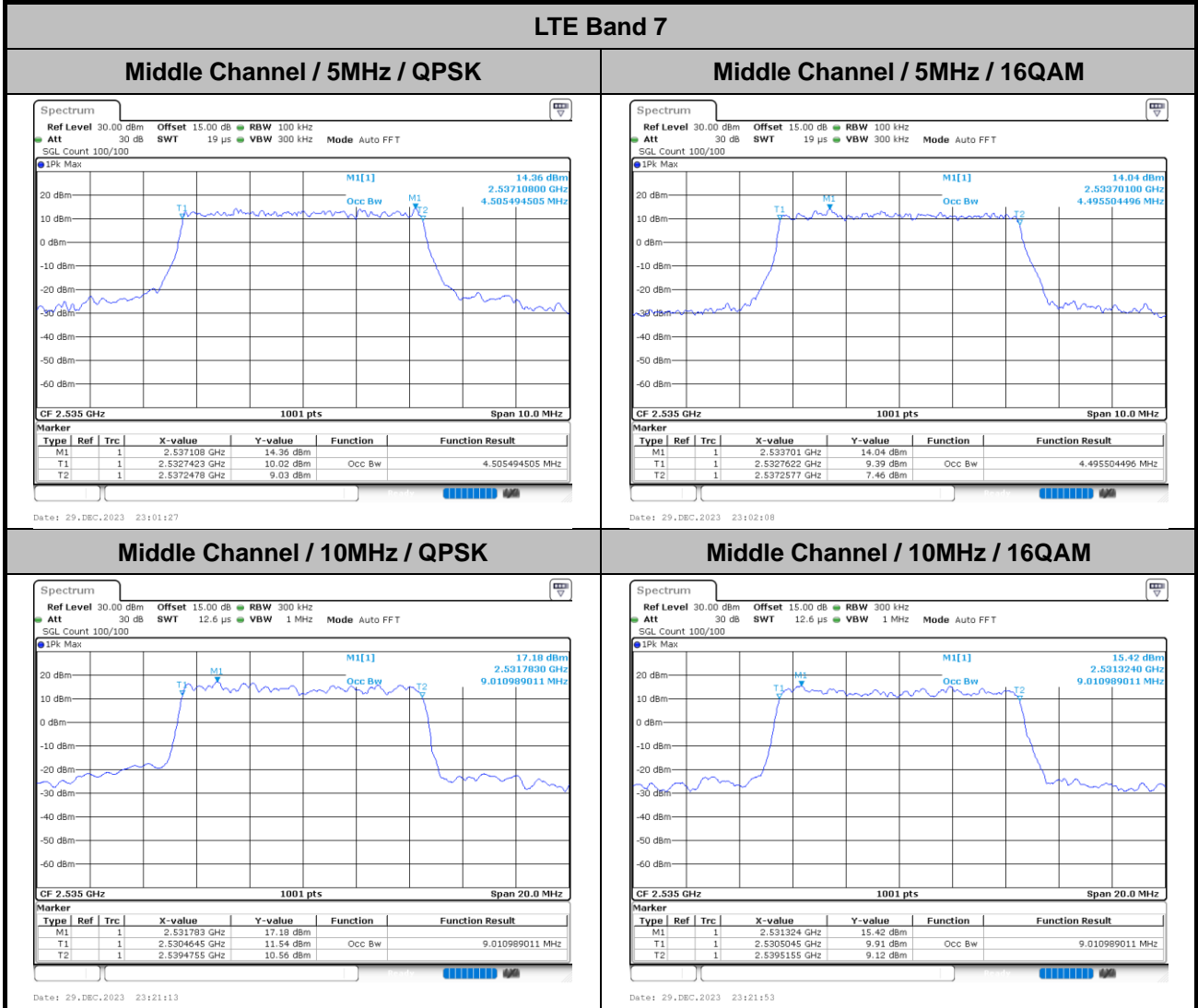



Middle Channel / 15MHz / QPSK

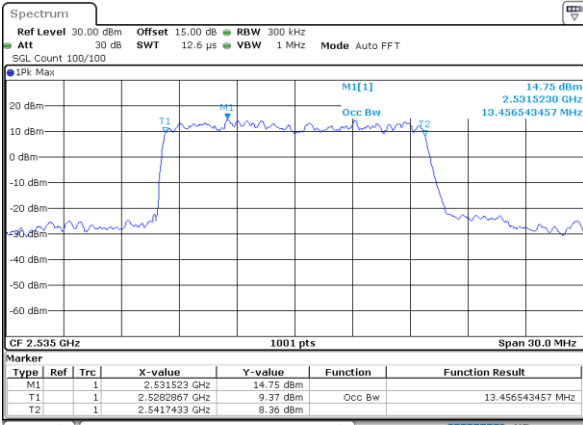

Date: 29, DEC, 2023 23:40:24

Middle Channel / 15MHz / 16QAM

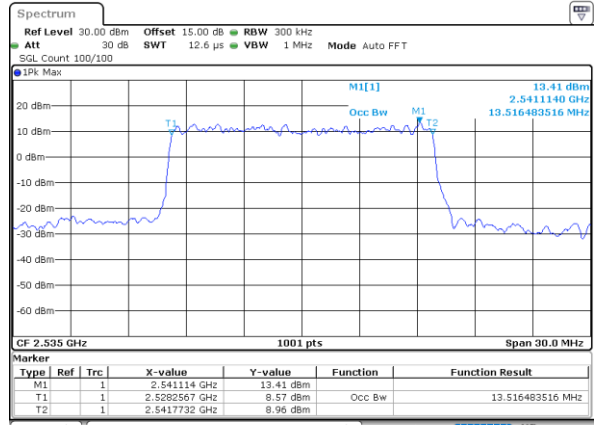

Date: 29, DEC, 2023 23:41:05

LTE Band 7

Middle Channel / 20MHz / QPSK

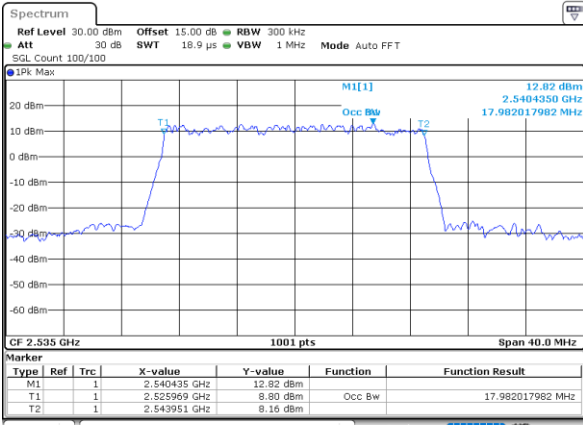

Date: 29, DEC, 2023 23:59:27

Middle Channel / 20MHz / 16QAM

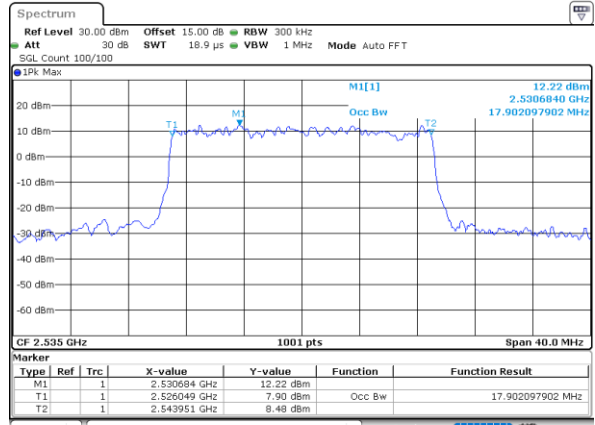

Date: 30, DEC, 2023 00:00:07





# Conducted Band Edge

## LTE Band 7 / 5MHz / QPSK

### Lowest Band Edge / 1 RB

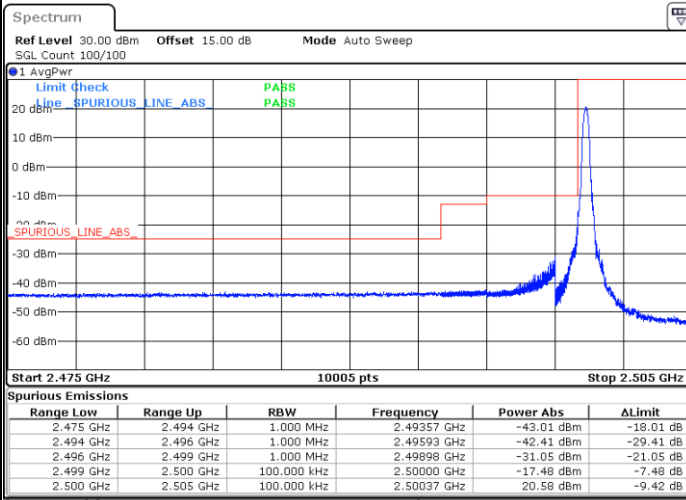

Date: 29.DEC.2023 22:53:30

### Highest Band Edge / 1 RB

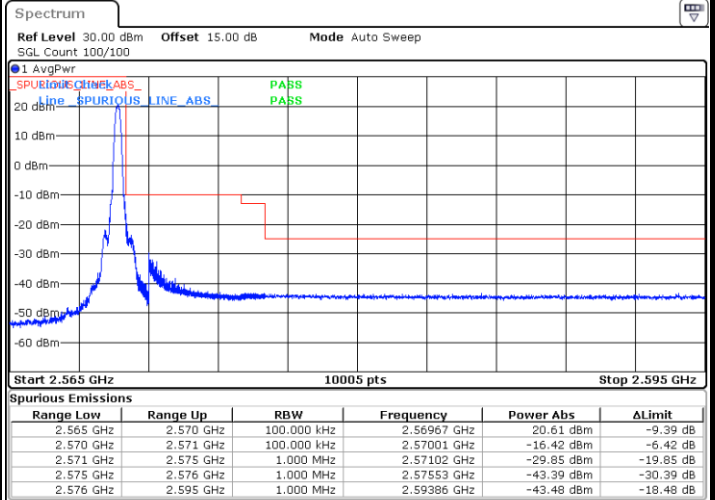

Date: 29.DEC.2023 23:03:22

### Lowest Band Edge / Full RB

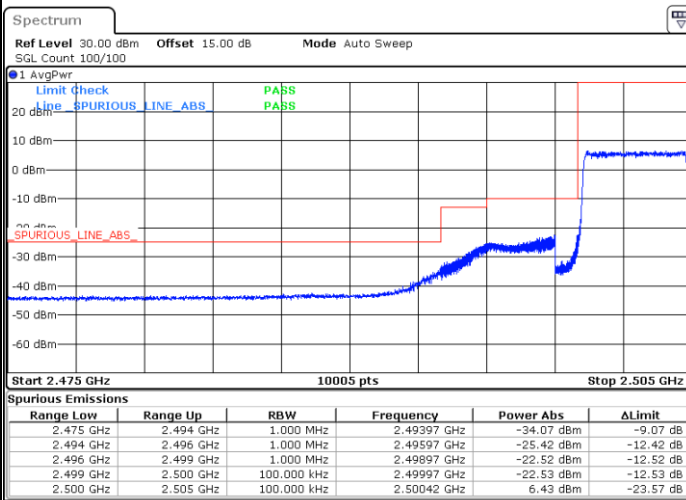

Date: 29.DEC.2023 22:56:36

### Highest Band Edge / Full RB

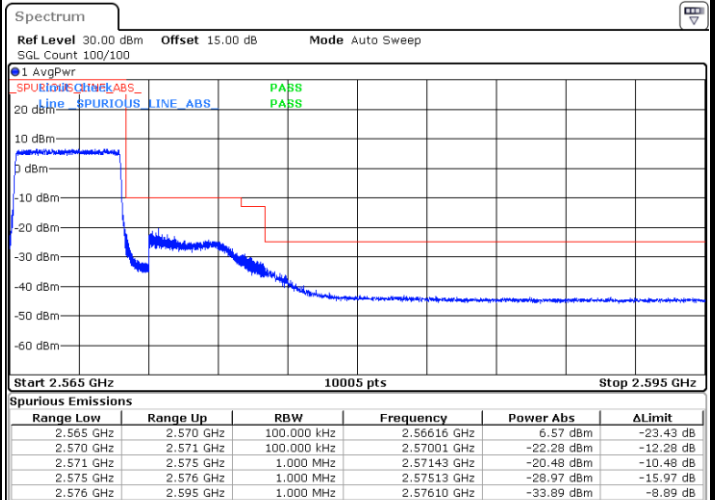

Date: 29.DEC.2023 23:06:27



LTE Band 7 / 5MHz / 16QAM

Lowest Band Edge / 1RB

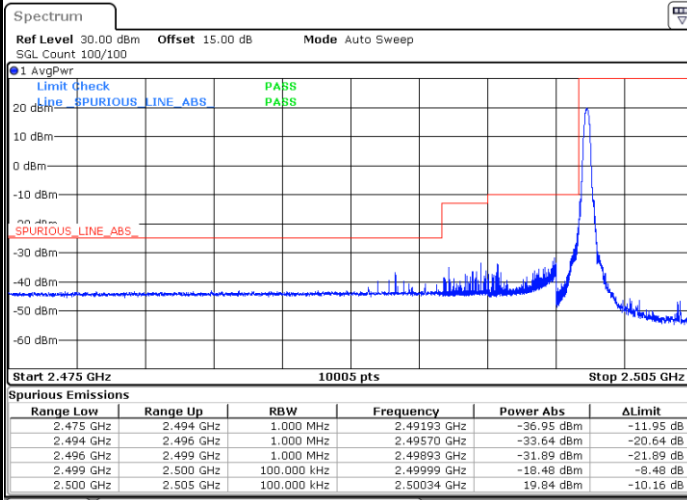

Date: 29.DEC.2023 22:54:32

Highest Band Edge / 1 RB

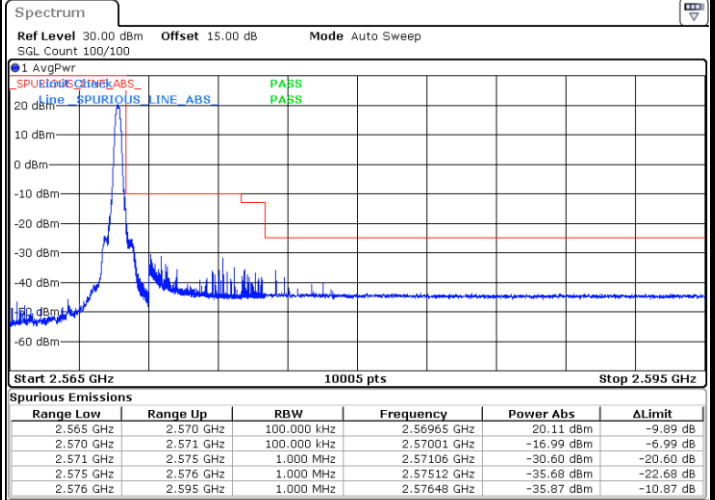

Date: 29.DEC.2023 23:04:24

Lowest Band Edge / Full RB

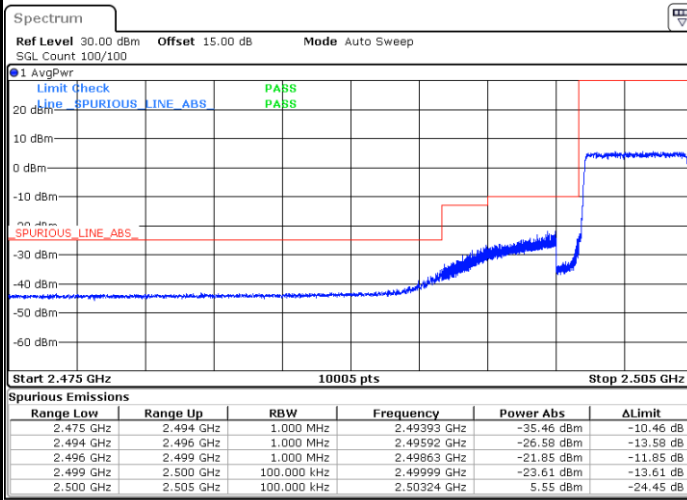

Date: 29.DEC.2023 22:57:37

Highest Band Edge / Full RB

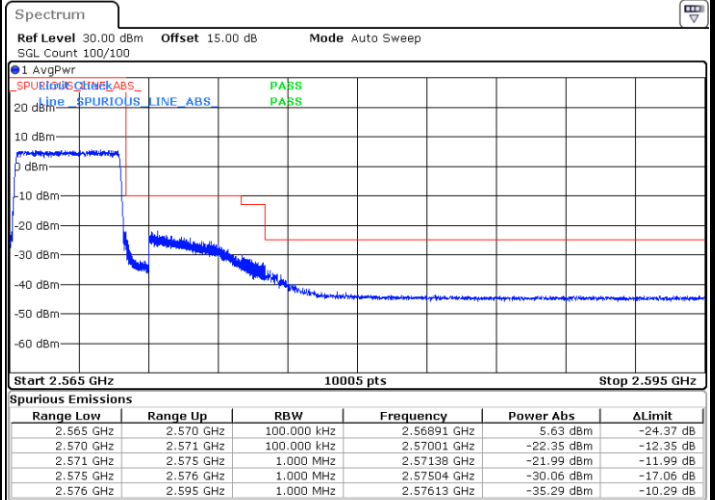

Date: 29.DEC.2023 23:07:29



LTE Band 7 / 5MHz / 64QAM

Lowest Band Edge / 1RB

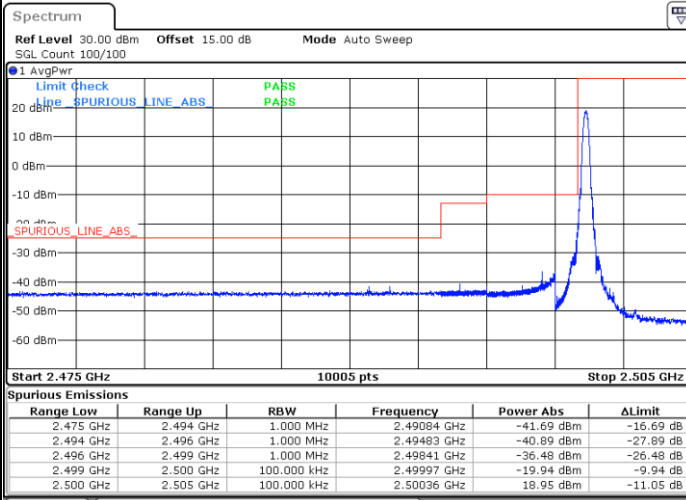

Date: 29.DEC.2023 22:55:34

Highest Band Edge / 1 RB

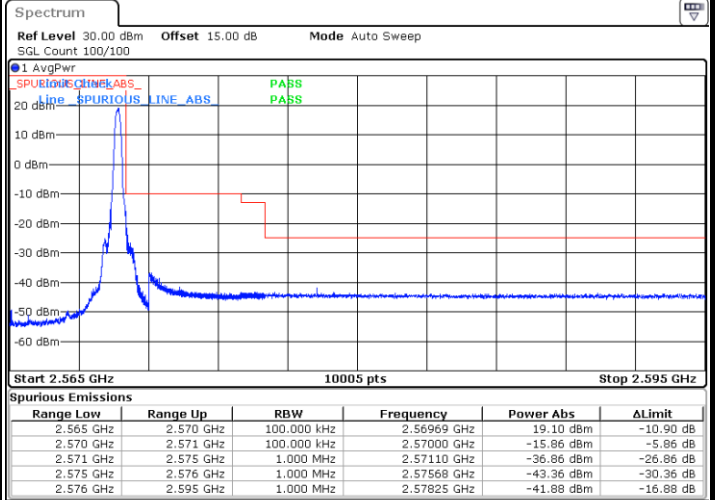

Date: 29.DEC.2023 23:05:25

Lowest Band Edge / Full RB

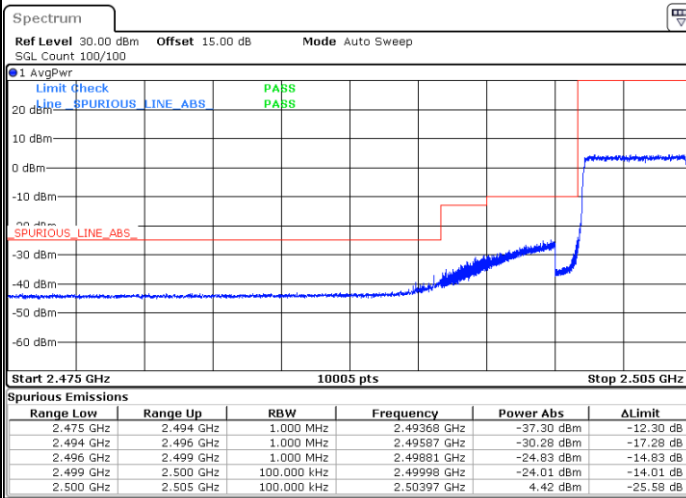

Date: 29.DEC.2023 22:58:39

Highest Band Edge / Full RB

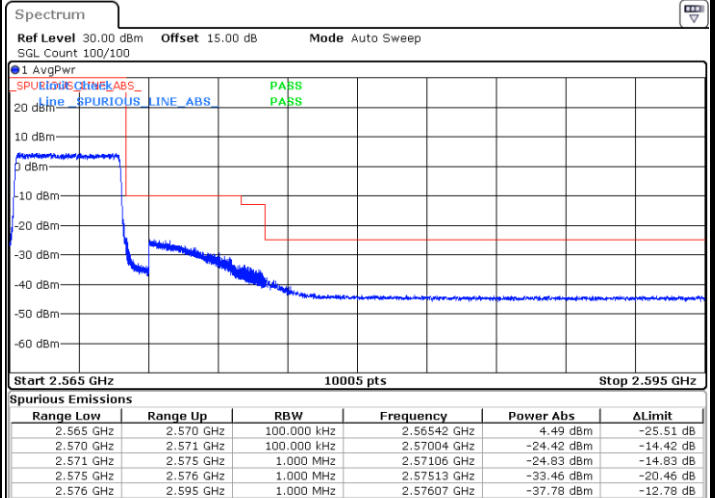

Date: 29.DEC.2023 23:08:31



LTE Band 7 / 10MHz / QPSK

Lowest Band Edge / 1 RB

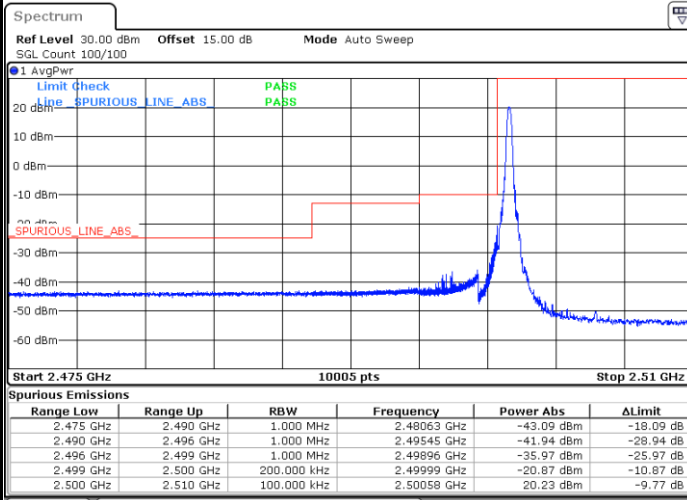

Date: 29.DEC.2023 23:13:16

Highest Band Edge / 1 RB

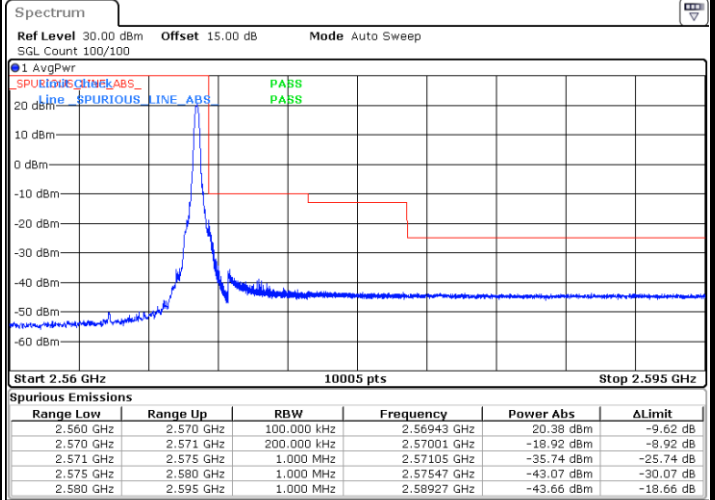

Date: 29.DEC.2023 23:23:08

Lowest Band Edge / Full RB

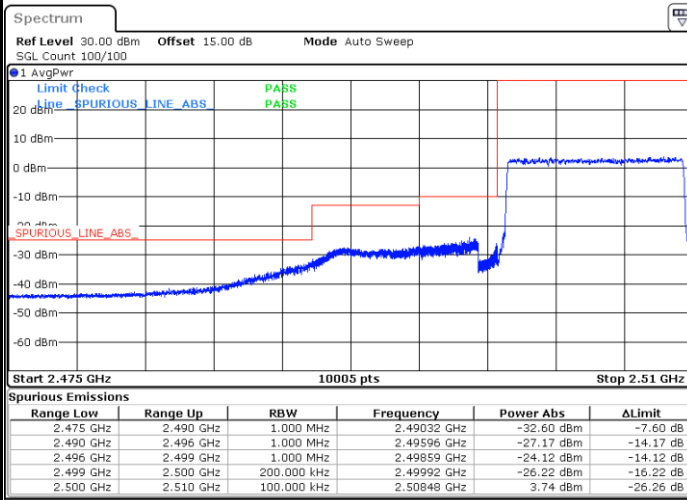

Date: 29.DEC.2023 23:16:21

Highest Band Edge / Full RB

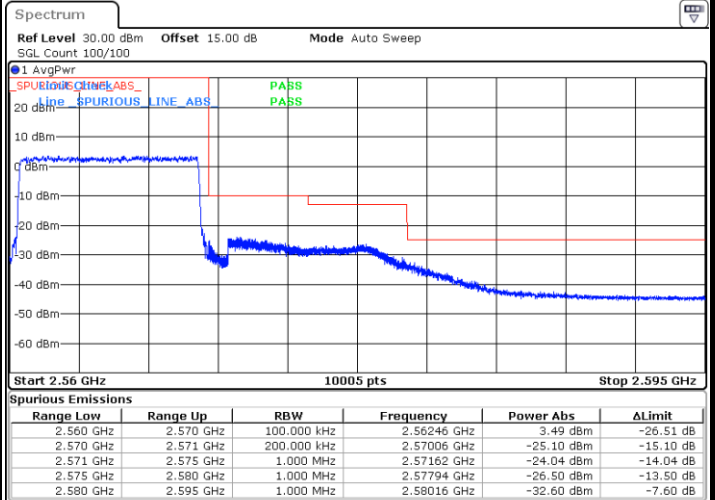

Date: 29.DEC.2023 23:26:13



LTE Band 7 / 10MHz / 16QAM

Lowest Band Edge / 1RB

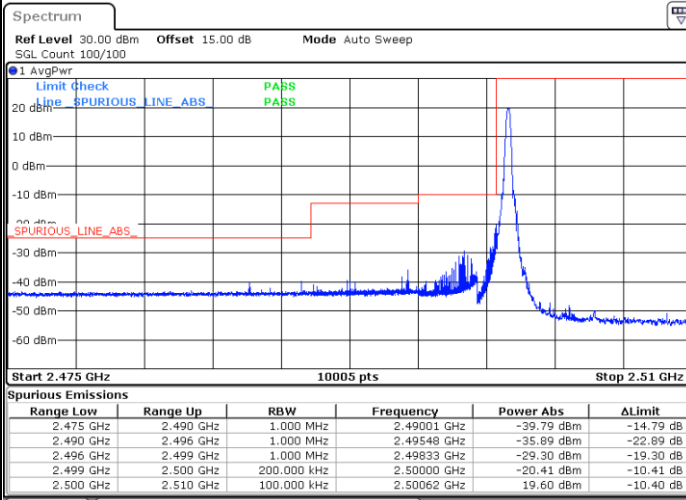

Date: 29.DEC.2023 23:14:18

Highest Band Edge / 1 RB

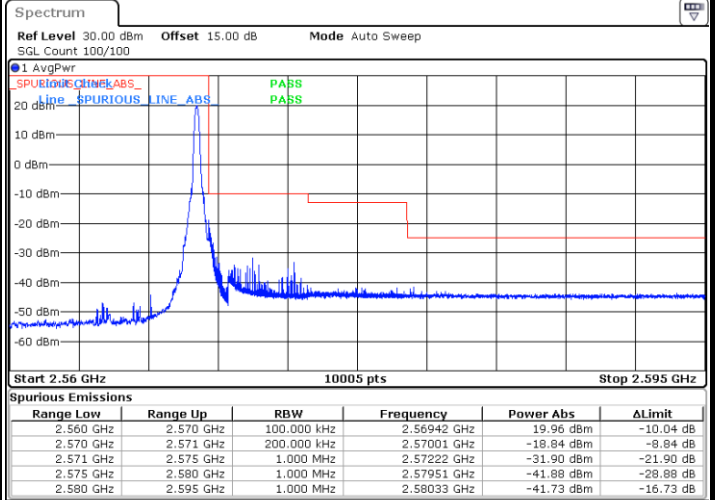

Date: 29.DEC.2023 23:24:10

Lowest Band Edge / Full RB

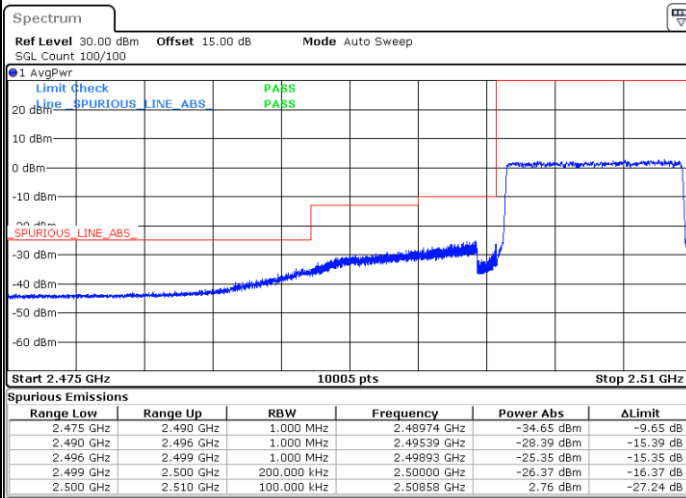

Date: 29.DEC.2023 23:17:23

Highest Band Edge / Full RB

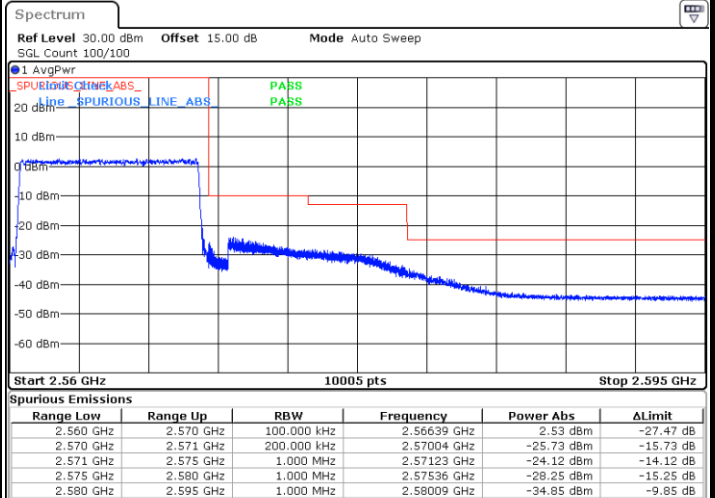

Date: 29.DEC.2023 23:27:15



LTE Band 7 / 10MHz / 64QAM

Lowest Band Edge / 1RB

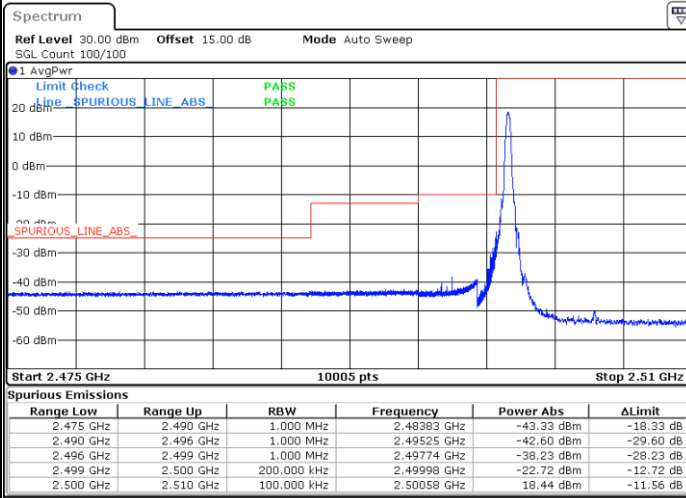

Date: 29.DEC.2023 23:15:19

Highest Band Edge / 1 RB

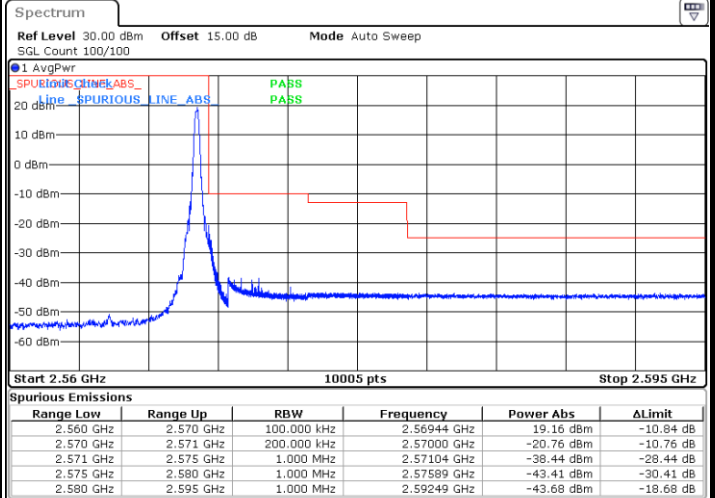

Date: 29.DEC.2023 23:25:11

Lowest Band Edge / Full RB

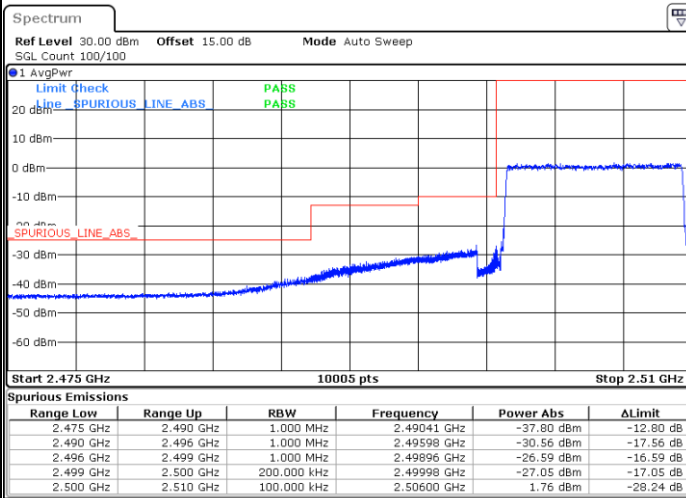

Date: 29.DEC.2023 23:18:25

Highest Band Edge / Full RB

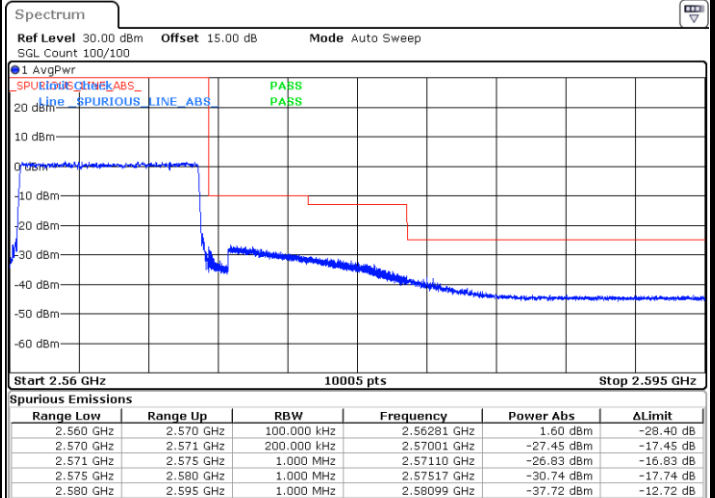

Date: 29.DEC.2023 23:28:17



LTE Band 7 / 15MHz / QPSK

Lowest Band Edge / 1 RB

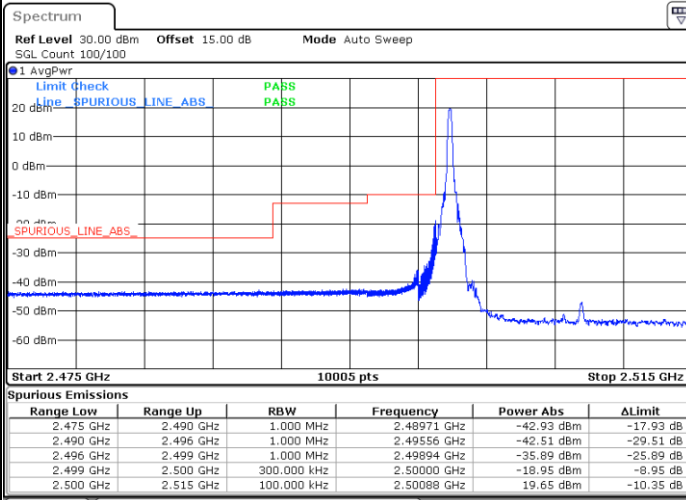

Date: 29. DEC. 2023 23:32:27

Highest Band Edge / 1 RB

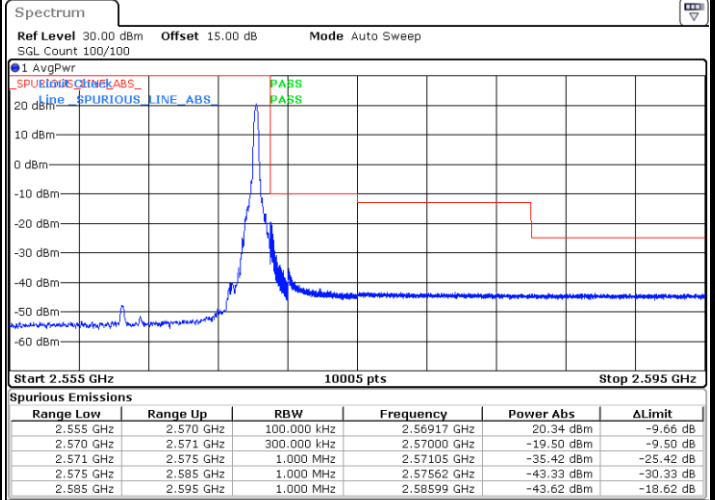

Date: 29. DEC. 2023 23:42:20

Lowest Band Edge / Full RB

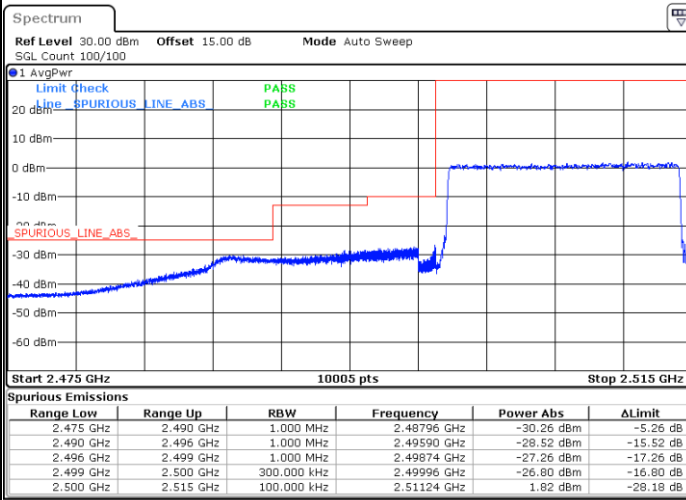

Date: 29. DEC. 2023 23:35:33

Highest Band Edge / Full RB

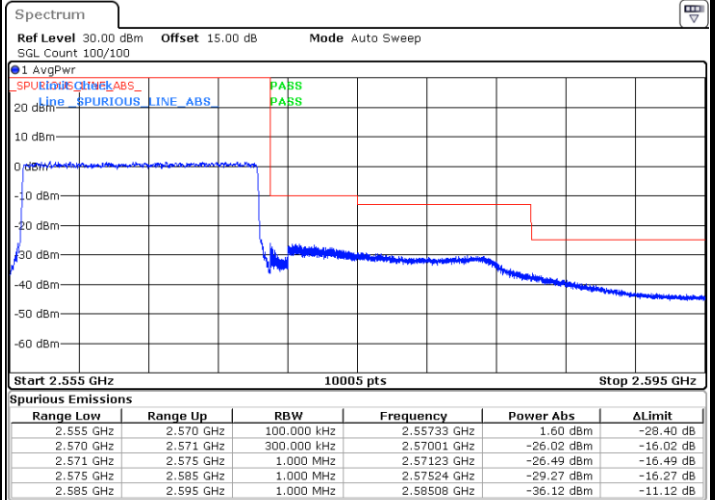

Date: 29. DEC. 2023 23:45:25





LTE Band 7 / 15MHz / 16QAM

Lowest Band Edge / 1RB

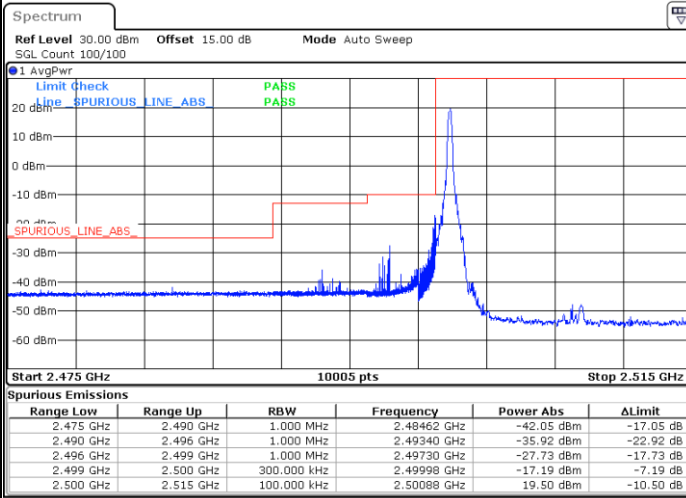

Date: 29.DEC.2023 23:33:29

Highest Band Edge / 1 RB

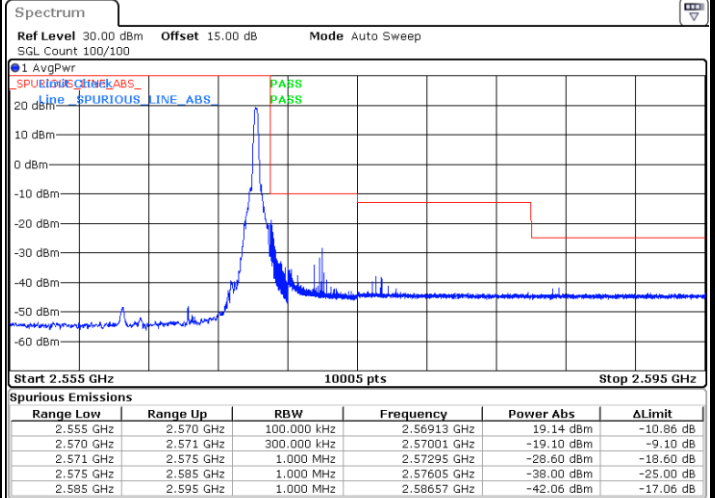

Date: 29.DEC.2023 23:43:21

Lowest Band Edge / Full RB

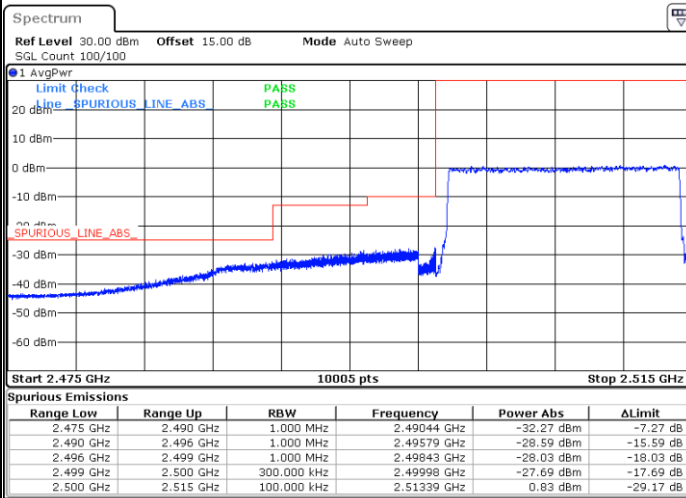

Date: 29.DEC.2023 23:36:35

Highest Band Edge / Full RB

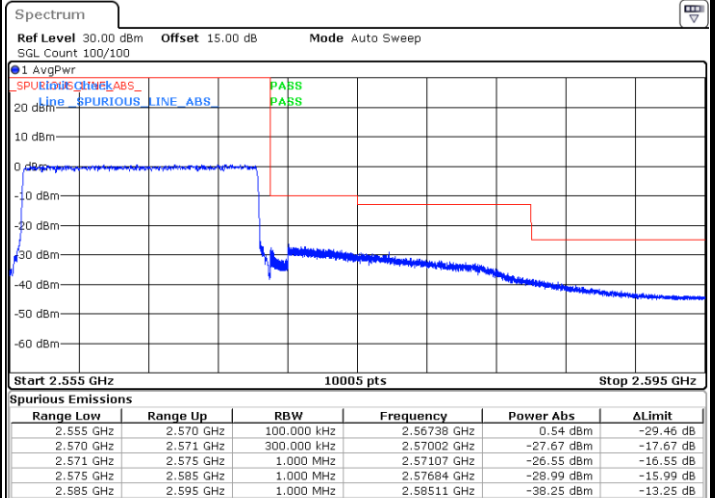

Date: 29.DEC.2023 23:46:27





LTE Band 7 / 15MHz / 64QAM

Lowest Band Edge / 1RB

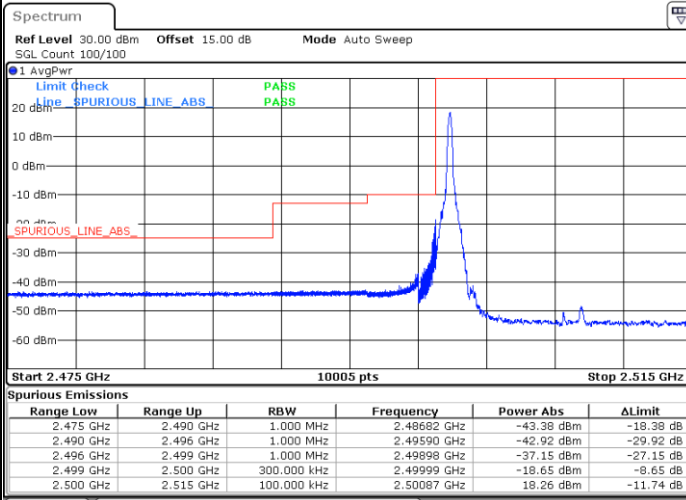

Date: 29.DEC.2023 23:34:31

Highest Band Edge / 1 RB

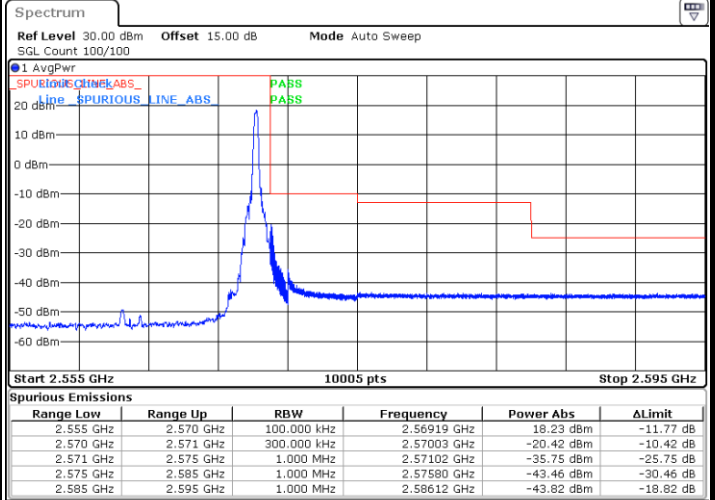

Date: 29.DEC.2023 23:44:23

Lowest Band Edge / Full RB

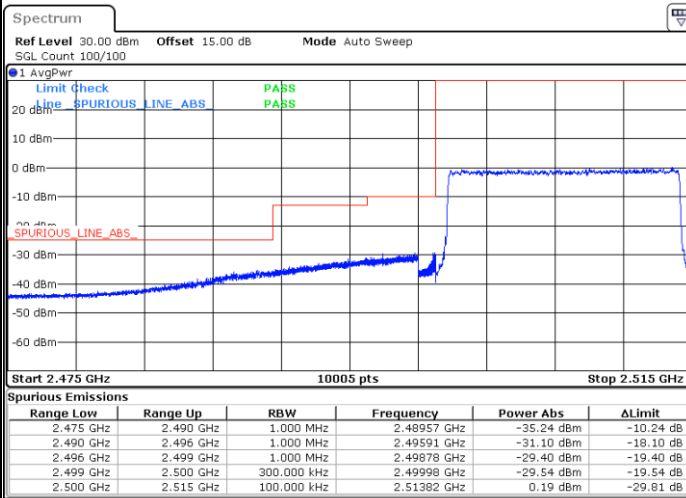

Date: 29.DEC.2023 23:37:37

Highest Band Edge / Full RB

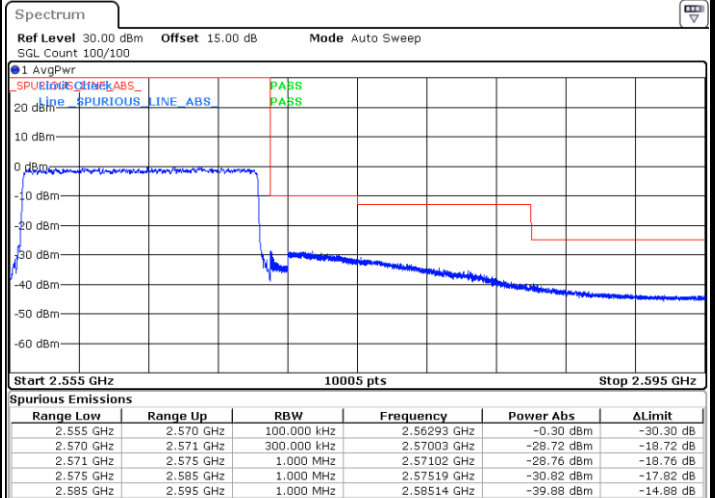

Date: 29.DEC.2023 23:47:29



LTE Band 7 / 20MHz / QPSK

Lowest Band Edge / 1 RB

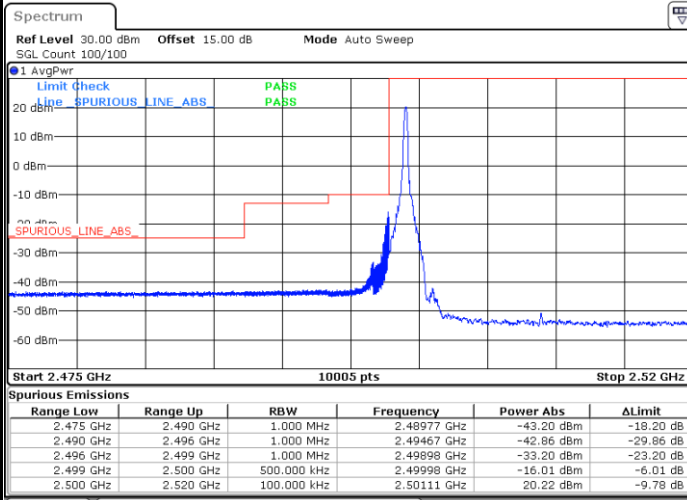

Highest Band Edge / 1 RB

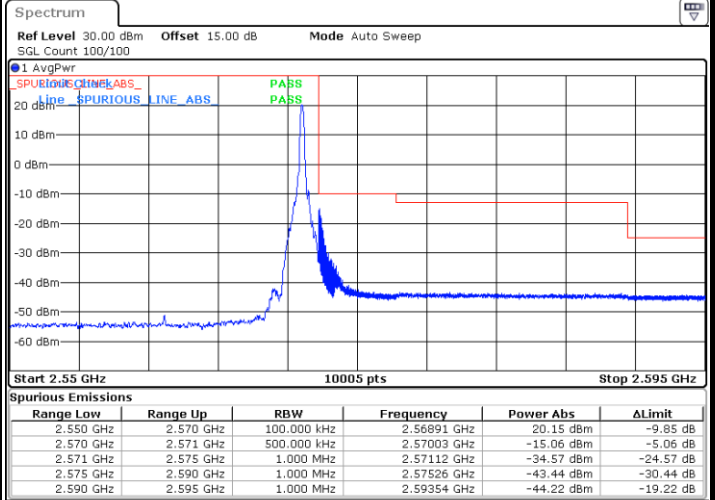

Lowest Band Edge / Full RB

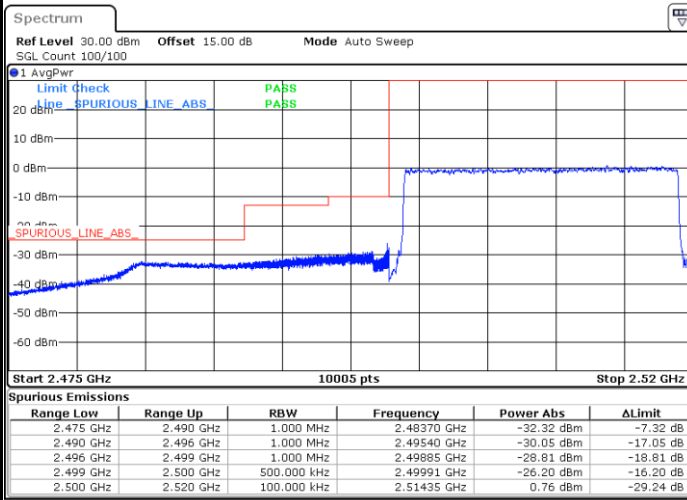

Highest Band Edge / Full RB

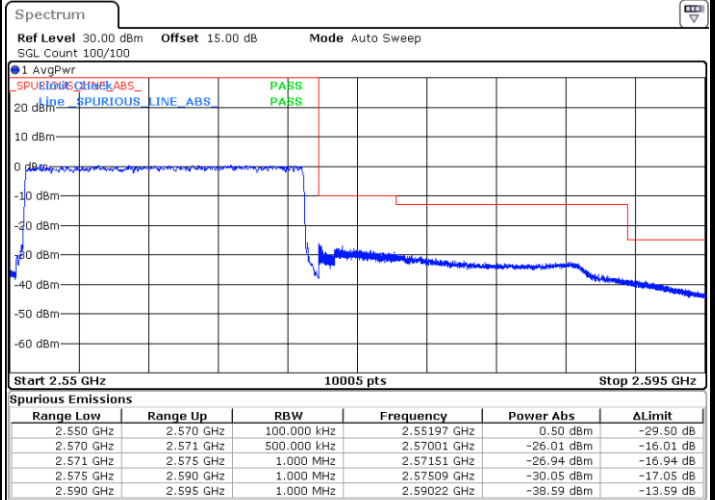



LTE Band 7 / 20MHz / 16QAM

Lowest Band Edge / 1RB

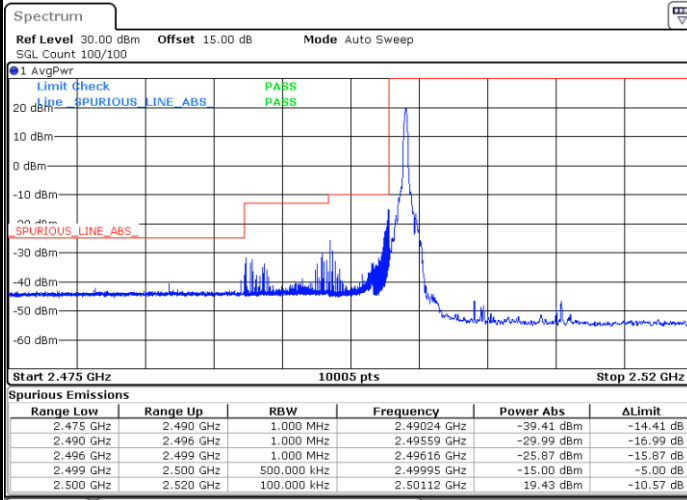

Date: 29.DEC.2023 23:52:31

Highest Band Edge / 1 RB

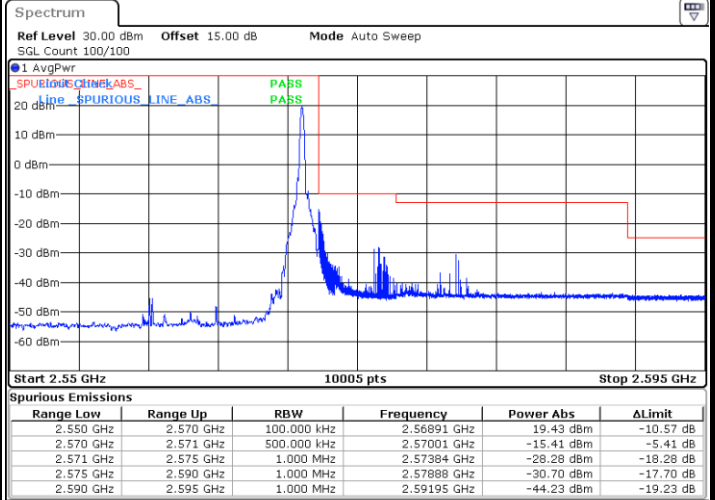

Date: 30.DEC.2023 00:03:48

Lowest Band Edge / Full RB

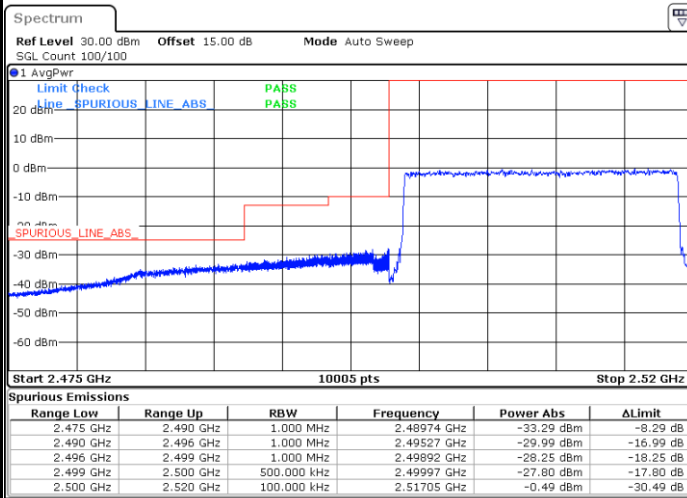

Date: 29.DEC.2023 23:55:37

Highest Band Edge / Full RB

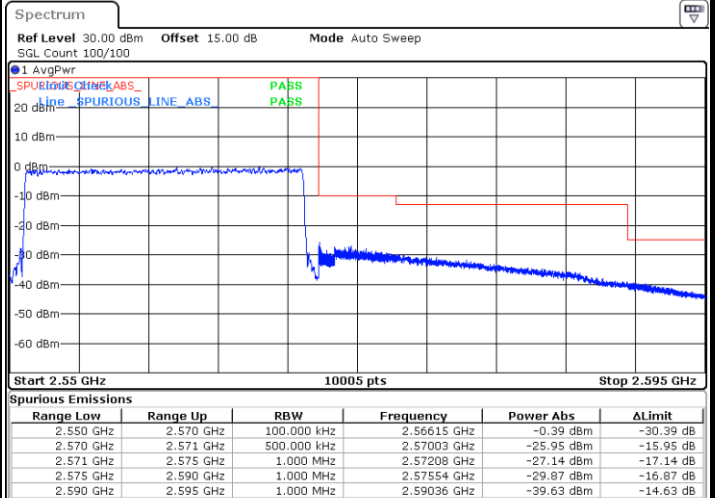

Date: 30.DEC.2023 00:06:53



LTE Band 7 / 20MHz / 64QAM

Lowest Band Edge / 1RB

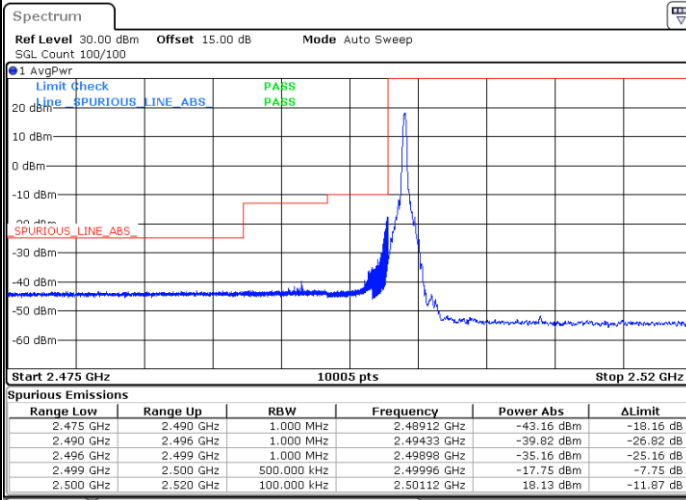

Highest Band Edge / 1 RB

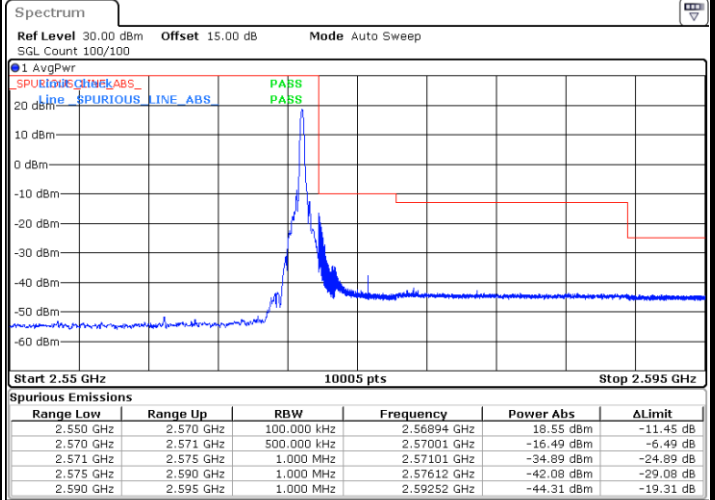

Lowest Band Edge / Full RB

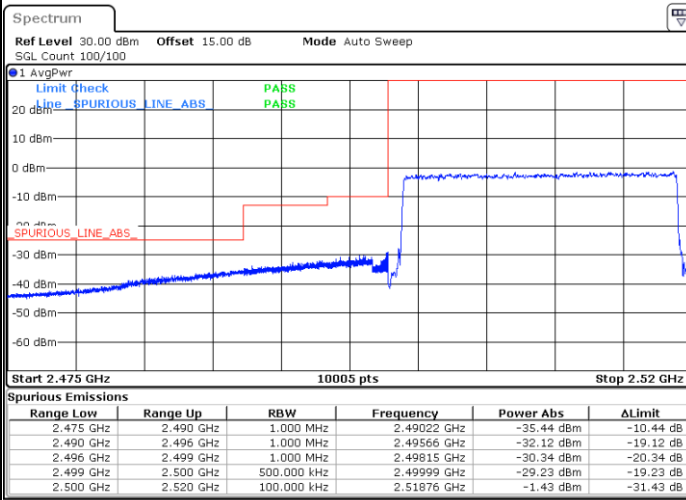

Highest Band Edge / Full RB

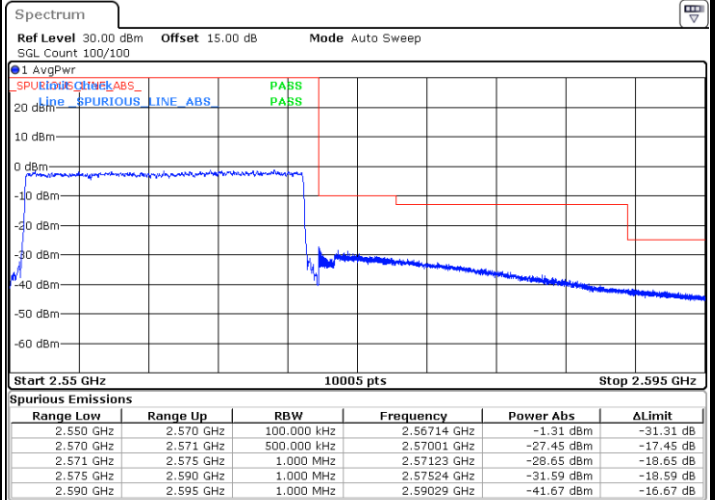



# Conducted Spurious Emission

## LTE Band 7 / 5MHz

### Lowest Channel / QPSK

### Middle Channel / QPSK

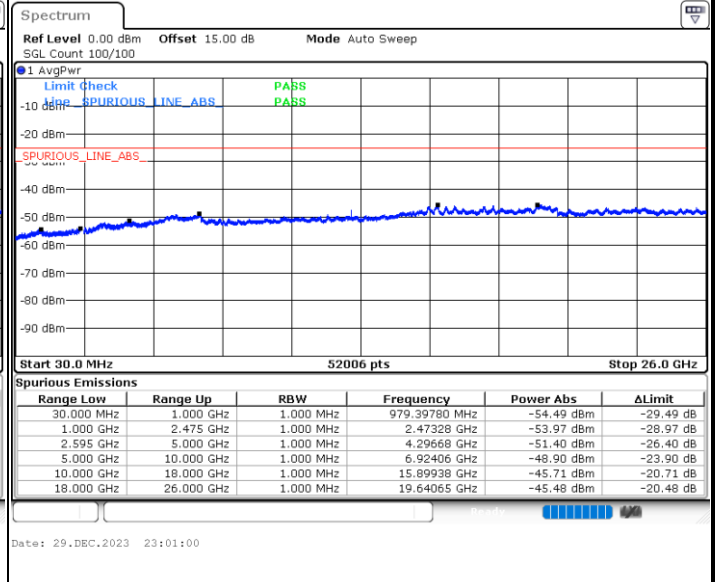
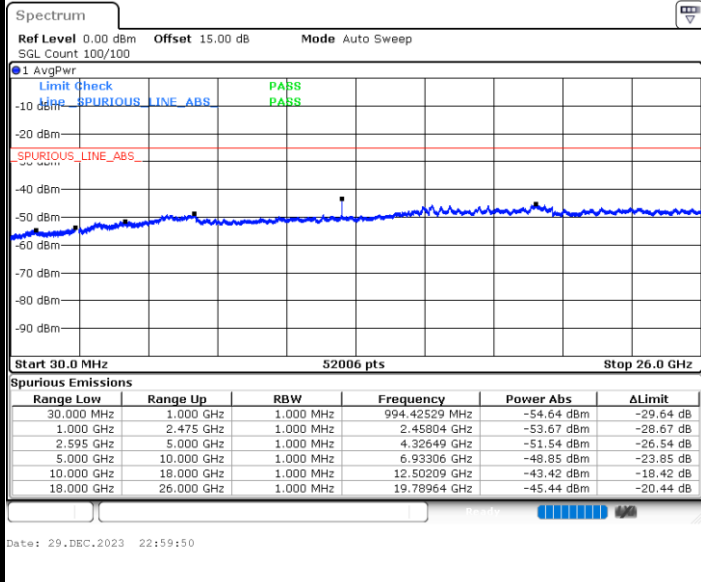

### Highest Channel / QPSK

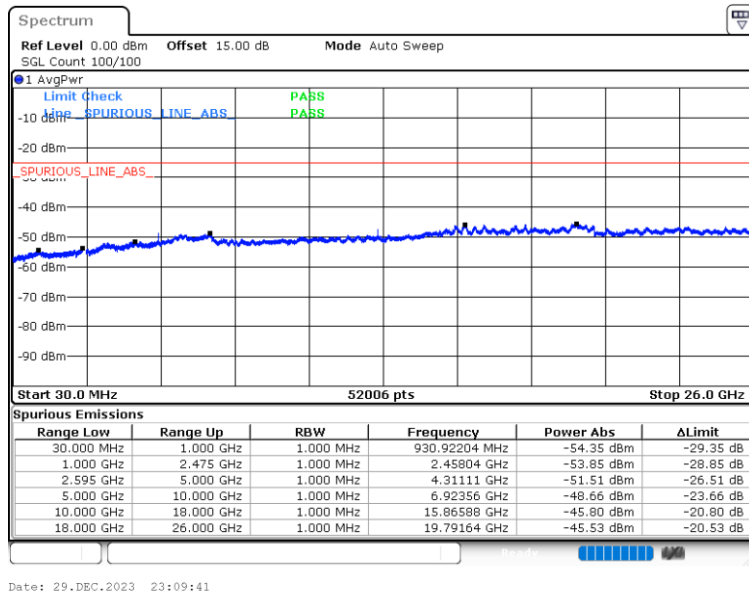



LTE Band 7 / 10MHz

Lowest Channel / QPSK

Middle Channel / QPSK

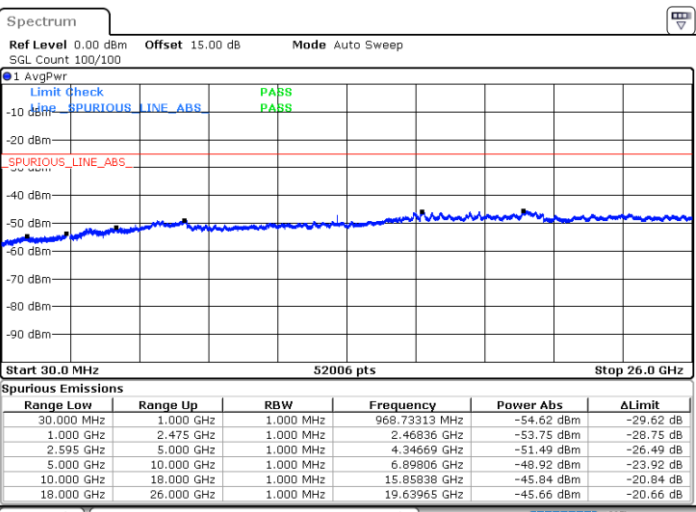
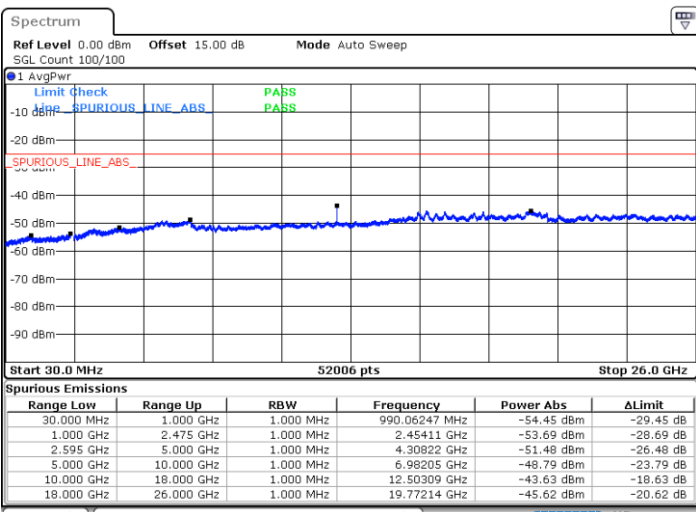

Date: 29.DEC.2023 23:19:35

Date: 29.DEC.2023 23:20:45

Highest Channel / QPSK

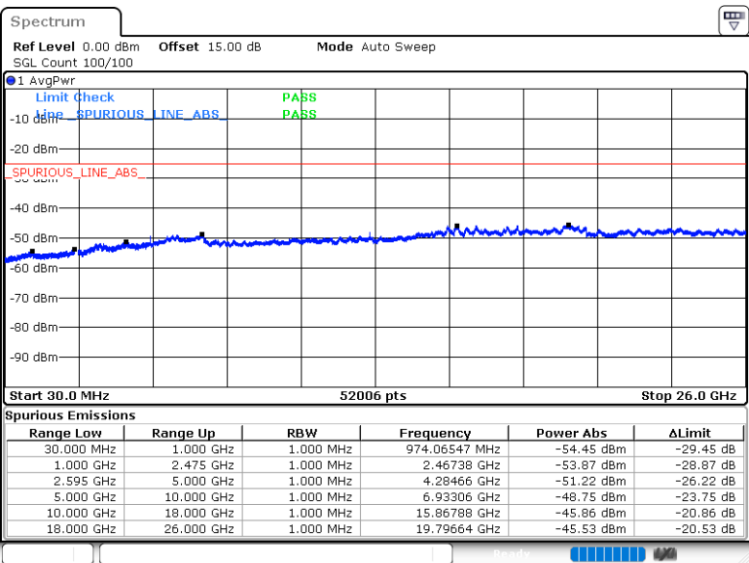

Date: 29.DEC.2023 23:29:27



LTE Band 7 / 15MHz

Lowest Channel / QPSK

Middle Channel / QPSK

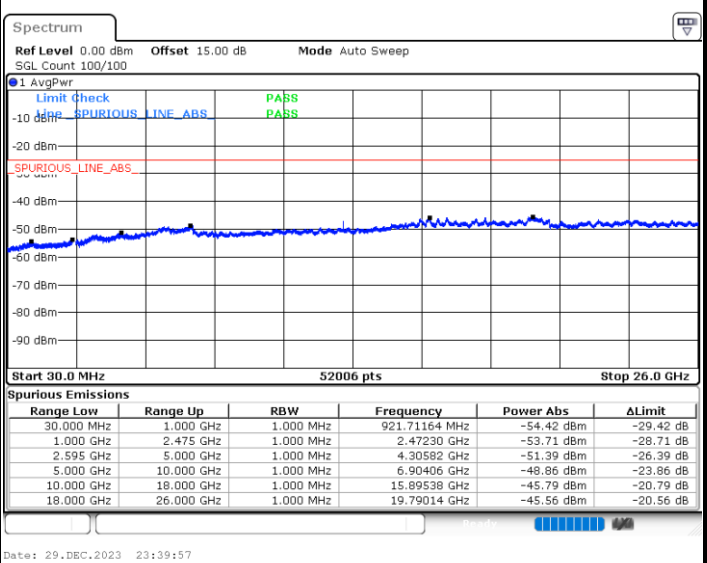
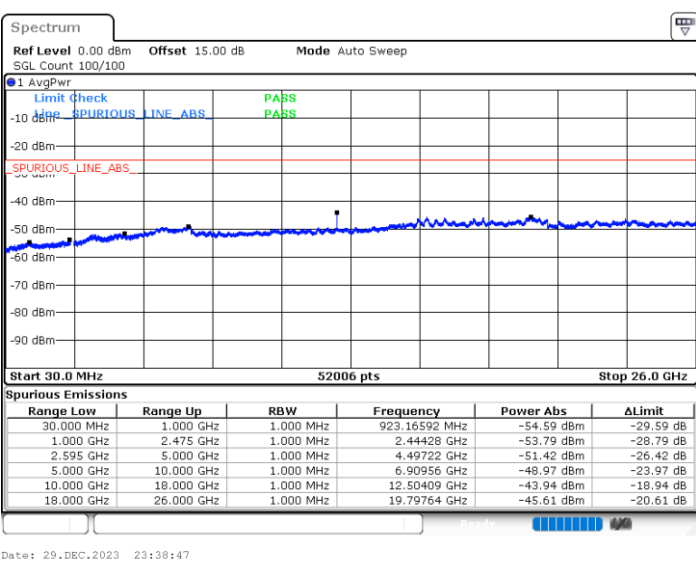

Highest Channel / QPSK

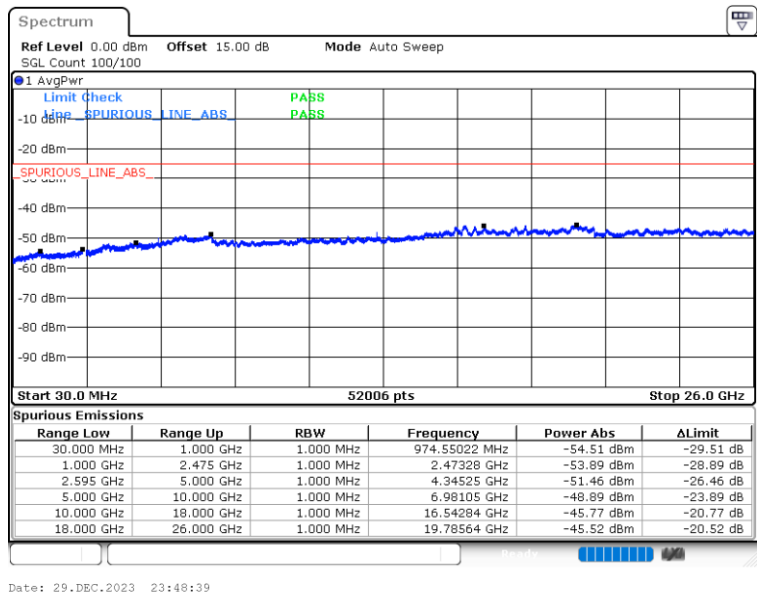



LTE Band 7 / 20MHz

Lowest Channel / QPSK

Middle Channel / QPSK

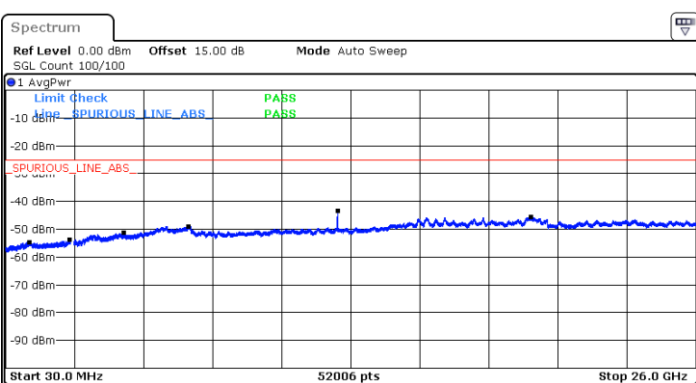

Range Low	Range Up	RBW	Frequency	Power Abs	ΔLimit
30.000 MHz	1.000 GHz	1.000 MHz	929.46777 MHz	-54.58 dBm	-29.58 dB
1.000 GHz	2.475 GHz	1.000 MHz	2.44182 GHz	-53.91 dBm	-28.91 dB
2.595 GHz	5.000 GHz	1.000 MHz	4.47173 GHz	-51.41 dBm	-26.41 dB
5.000 GHz	10.000 GHz	1.000 MHz	6.89356 GHz	-48.96 dBm	-23.96 dB
10.000 GHz	18.000 GHz	1.000 MHz	12.50559 GHz	-43.44 dBm	-18.44 dB
18.000 GHz	26.000 GHz	1.000 MHz	19.79914 GHz	-45.54 dBm	-20.54 dB

Date: 29.DEC.2023 23:57:50

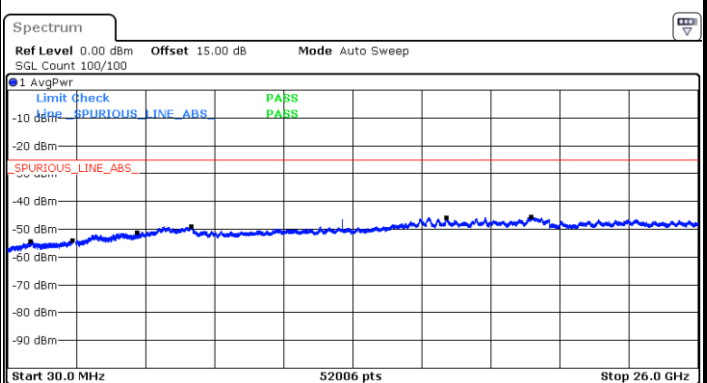

Range Low	Range Up	RBW	Frequency	Power Abs	ΔLimit
30.000 MHz	1.000 GHz	1.000 MHz	901.35182 MHz	-54.38 dBm	-29.38 dB
1.000 GHz	2.475 GHz	1.000 MHz	2.45857 GHz	-53.99 dBm	-28.99 dB
2.595 GHz	5.000 GHz	1.000 MHz	4.89685 GHz	-51.28 dBm	-26.28 dB
5.000 GHz	10.000 GHz	1.000 MHz	6.94656 GHz	-49.00 dBm	-24.00 dB
10.000 GHz	18.000 GHz	1.000 MHz	16.54234 GHz	-45.76 dBm	-20.76 dB
18.000 GHz	26.000 GHz	1.000 MHz	19.71614 GHz	-45.67 dBm	-20.67 dB

Date: 29.DEC.2023 23:59:00

Highest Channel / QPSK

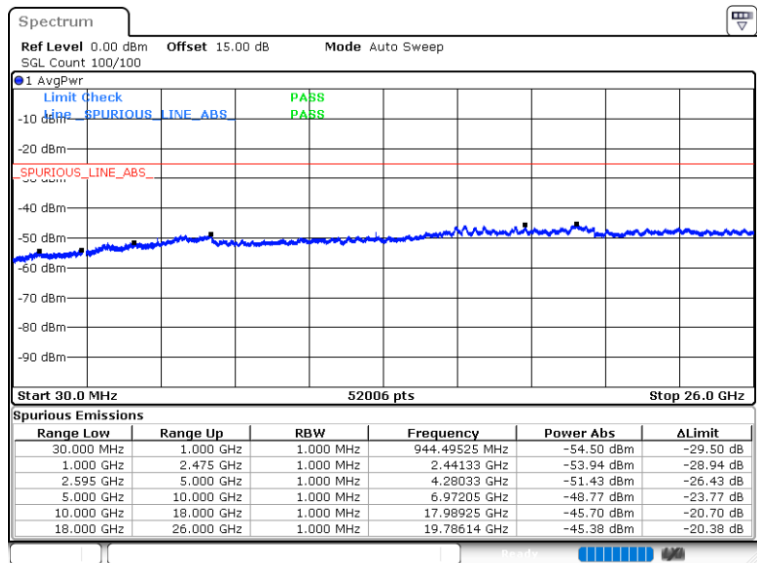

Range Low	Range Up	RBW	Frequency	Power Abs	ΔLimit
30.000 MHz	1.000 GHz	1.000 MHz	944.49525 MHz	-54.50 dBm	-29.50 dB
1.000 GHz	2.475 GHz	1.000 MHz	2.44133 GHz	-53.94 dBm	-28.94 dB
2.595 GHz	5.000 GHz	1.000 MHz	4.28033 GHz	-51.43 dBm	-26.43 dB
5.000 GHz	10.000 GHz	1.000 MHz	6.97205 GHz	-48.77 dBm	-23.77 dB
10.000 GHz	18.000 GHz	1.000 MHz	17.98925 GHz	-45.70 dBm	-20.70 dB
18.000 GHz	26.000 GHz	1.000 MHz	19.78614 GHz	-45.38 dBm	-20.38 dB

Date: 30.DEC.2023 00:09:06





### Frequency Stability

Test Conditions		LTE Band 7 (QPSK) / Middle Channel	Limit
Temperature (°C)	Voltage (Volt)	BW 10MHz	Note 2.
		Deviation (ppm)	Result
50	Normal Voltage	0.0006	PASS
40	Normal Voltage	0.0005	
30	Normal Voltage	0.0004	
20(Ref.)	Normal Voltage	0.0000	
10	Normal Voltage	0.0002	
0	Normal Voltage	0.0001	
-10	Normal Voltage	0.0015	
-20	Normal Voltage	2.0000	
-30	Normal Voltage	0.0018	
20	Maximum Voltage	0.0017	
20	Normal Voltage	0.0000	
20	Battery End Point	0.0016	

**Note:**

1. Normal Voltage = 3.89 V. ; Battery End Point (BEP) = 3.6 V. ; Maximum Voltage = 4.48 V.
2. The frequency fundamental emissions stay within the authorized frequency block.



# LTE Band 41

## Peak-to-Average Ratio

Mode	LTE Band 41 / 20MHz			
Mod.	QPSK	16QAM	64QAM	Limit: 13dB
RB Size	Full RB	Full RB	Full RB	Result
Middle CH	4.67	5.65	6.00	PASS

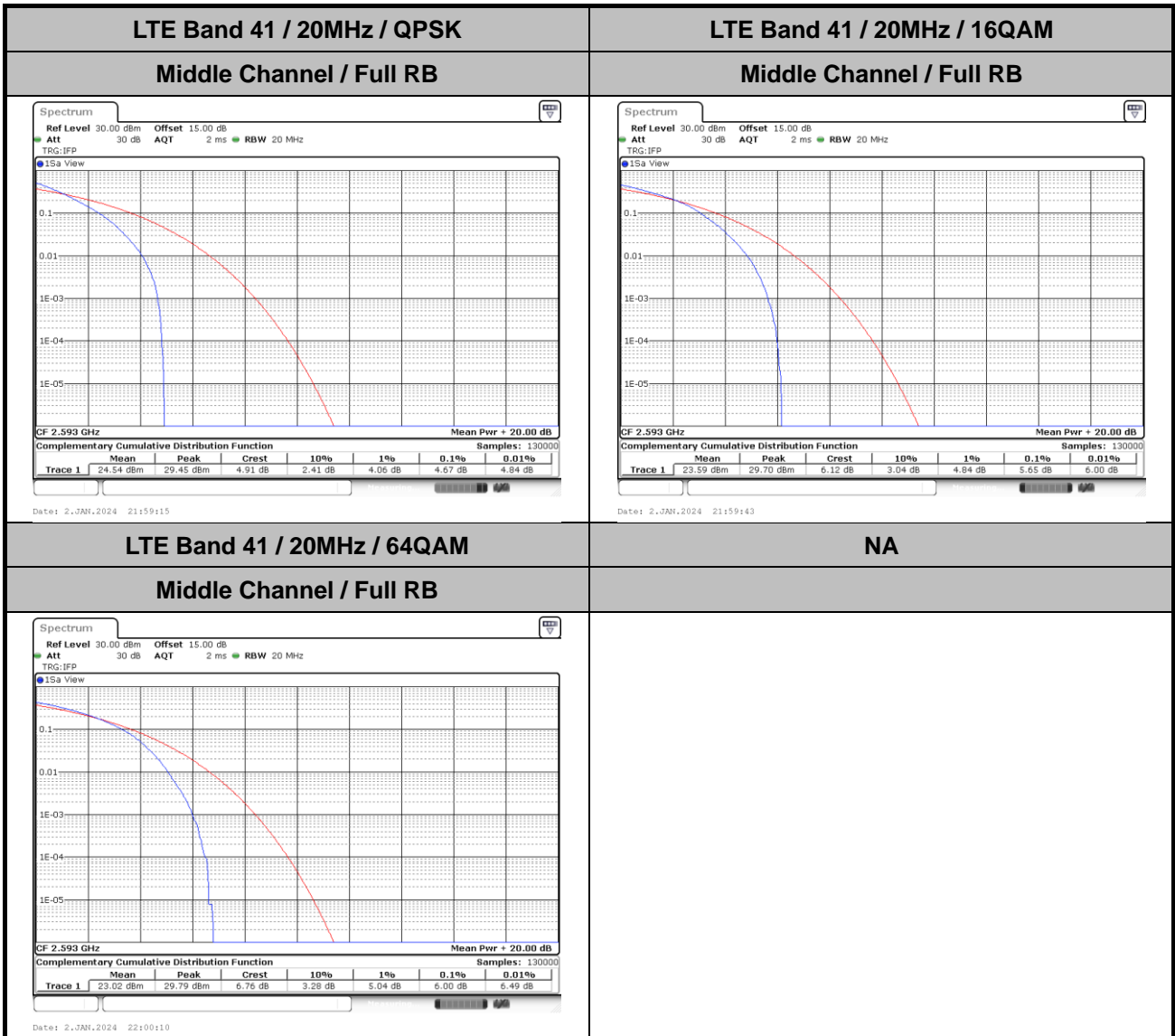



# 26dB Bandwidth

Mode	LTE Band 41 : 26dB BW(MHz)											
BW	-			5MHz		10MHz		15MHz		20MHz		
Mod.	-	-	-	-	QPSK	16QAM	QPSK	16QAM	QPSK	16QAM	QPSK	16QAM
Middle CH	-	-	-	-	5.14	4.86	9.93	10.07	14.12	14.63	19.14	18.74

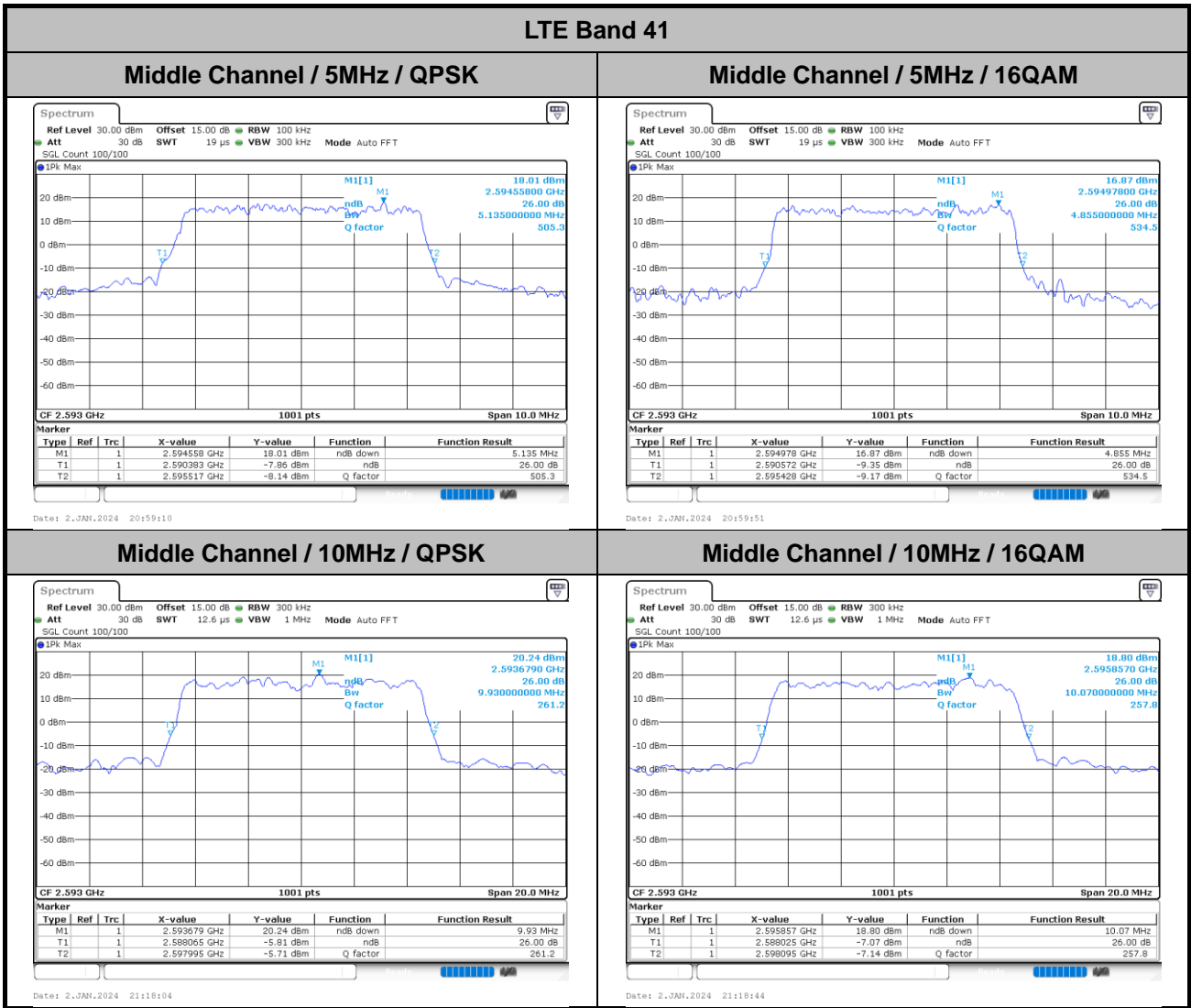



Middle Channel / 15MHz / QPSK

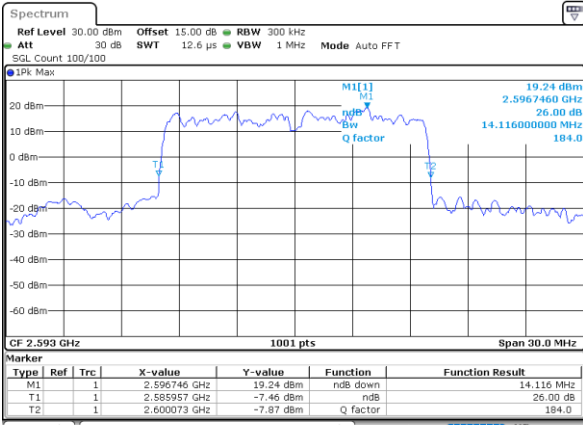

Date: 2, JAN, 2024 21:13:14

Middle Channel / 15MHz / 16QAM

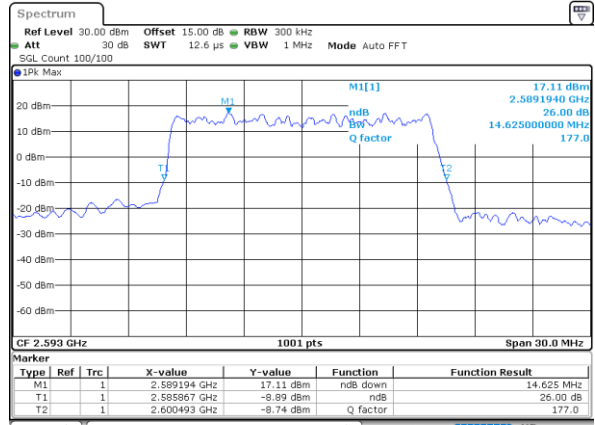

Date: 2, JAN, 2024 21:40:14

LTE Band 41

Middle Channel / 20MHz / QPSK

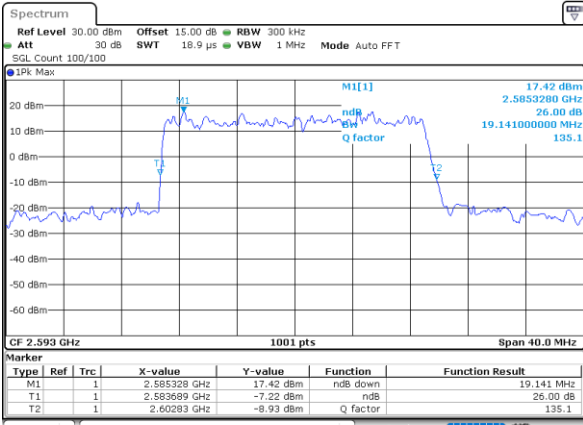

Date: 2, JAN, 2024 21:58:07

Middle Channel / 20MHz / 16QAM

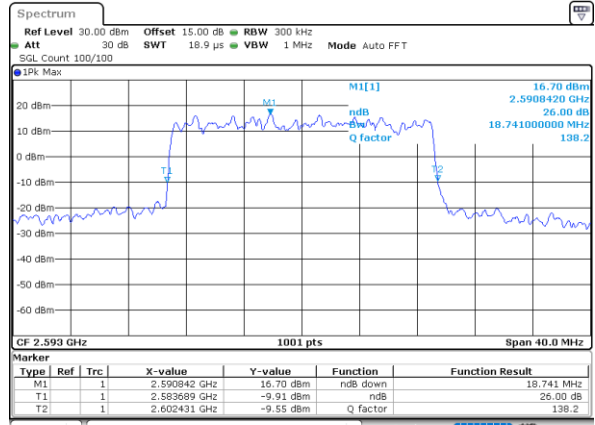

Date: 2, JAN, 2024 21:58:47