



# RF Exposure Report

## (Part 2: Test Under Dynamic Transmission Condition)

FCC ID : IHDT56AQ5  
Equipment : Mobile Cellular Phone  
Brand Name : Motorola  
Model Name : XT2403-1, XT2403-2  
Applicant : Motorola Mobility LLC  
222 W,Merchandise Mart Plaza,Chicago,IL60654 USA

We, Sporton International Inc. (Shenzhen), would like to declare that the tested sample has been evaluated in accordance with the test procedures and has been in compliance with the applicable technical standards.

The test results in this report apply exclusively to the tested model / sample. Without written approval of Sporton International Inc. (Shenzhen), the test report shall not be reproduced except in full.

A handwritten signature in black ink that reads "Si Zhang".

Approved by: Si Zhang

**Sporton International Inc. (Shenzhen)**

**1/F, 2/F, Bldg 5, Shiling Industrial Zone, Xinwei Village, Xili, Nanshan, Shenzhen, 518055  
People's Republic of China**

### History of this test report

Report No.	Version	Description	Issued Date
FA3D1818B	01	Initial issue of report	Jan. 30, 2024
FA3D1818B	02	Updated 5G NR n77/78 at ant4 DSI2 Plimit.	Feb. 18, 2024



# Contents

<b>1 Introduction .....</b>	<b>5</b>
1.1 Configurable parameters .....	6
<b>2 Tx Varying Transmission Test Cases and Test Proposal .....</b>	<b>8</b>
<b>3 SAR Time Averaging Validation Test Procedures .....</b>	<b>10</b>
3.1 Test sequence determination for validation .....	10
3.2 Test configuration selection criteria for validating Smart Transmit feature .....	10
3.2.1 Test configuration selection for time-varying Tx power transmission .....	11
3.2.2 Test configuration selection for change in call .....	11
3.2.3 Test configuration selection for change in technology/band .....	11
3.2.4 Test configuration selection for change in DSI .....	12
3.2.5 Test configuration selection for SAR exposure switching .....	12
3.2.6 Test configuration selection for change in time window .....	13
3.2.7 Test configuration selection for Exposure Category Switch .....	13
3.3 Test procedures for conducted power measurements .....	15
3.3.1 Time-varying Tx power transmission scenario .....	15
3.3.2 Change in call scenario .....	16
3.3.3 Change in technology and band .....	17
3.3.4 Change in antenna .....	19
3.3.5 Change in DSI .....	19
3.3.6 Change in time window .....	19
3.3.7 SAR exposure switching .....	21
3.3.8 Test procedure for Exposure Category Switch .....	22
3.4 Test procedure for time-varying SAR measurements .....	23
<b>4 Test Configurations .....</b>	<b>25</b>
4.1 WWAN (sub-6) transmission .....	25
<b>5 Conducted Power Test Results for Sub-6 Smart Transmit Feature Validation .....</b>	<b>31</b>
5.1 Measurement setup .....	31
5.2 $P_{limit}$ and $P_{max}$ measurement results .....	34
5.3 Time-varying Tx power measurement results .....	35
5.3.1 GSM850 .....	36
5.3.2 GSM1900 .....	38
5.3.3 WCDMA Band 5 .....	40
5.3.4 WCDMA Band 2 .....	42
5.3.5 LTE Band 2 .....	44
5.3.6 LTE Band 41 .....	46
5.3.7 5G NR FR1 n66 .....	48
5.3.8 5G NR FR1 n7 .....	50
5.4 Change in Call Test Results .....	52
5.5 Change in technology/band test results .....	53
5.6 Change in DSI test results .....	54
5.7 Change in Time window / antenna switch test results .....	55
5.7.1 Test case 1: transition from LTE Band 66 to LTE Band 48 (i.e., 100s to 60s), then back to LTE Band 66 .....	55
5.7.2 Test case 2: transition from LTE Band 48 to LTE Band 66 (i.e., 60s to 100s), then back to LTE Band 48 .....	56
5.8 Switch in SAR exposure test results (EN-DC Combination) .....	57



---

5.9 Exposure Category Switch Test results .....	58
<b>6 SAR Test Results for Sub-6 Smart Transmit Feature Validation .....</b>	<b>60</b>
6.1 Measurement setup .....	60
6.2 SAR measurement results for time-varying Tx power transmission scenario .....	61
6.2.1 GSM850 SAR test results .....	62
6.2.2 GSM1900 SAR test results .....	64
6.2.3 WCDMA Band 5 SAR test results .....	66
6.2.4 WCDMA Band 2 SAR test results .....	68
6.2.5 LTE Band 2 SAR test results .....	70
6.2.6 LTE Band 41 SAR test results .....	72
6.2.7 5G NR FR1 n66 SAR test results .....	74
6.2.8 5G NR FR1 n7 SAR test results .....	76
<b>7 Conclusions .....</b>	<b>77</b>
<b>Appendix A. Test Sequences</b>	
<b>Appendix B. Test Procedures for 5G NR + LTE Radio</b>	
<b>Appendix C. cDASY6 System Verification</b>	
<b>Appendix D. DASY Calibration Certificate</b>	
<b>Appendix E. Test Setup Photos</b>	



# 1 Introduction

The equipment under test (EUT) is a Mobile Cellular Phone (FCC ID: IHDT56AQ5), it contains the Qualcomm modem supporting 2G/3G/4G technologies and 5G NR bands. Both of these modems are enabled with Qualcomm Smart Transmit feature to control and manage transmitting power in real time and to ensure at all times the time-averaged RF exposure is in compliance with the FCC requirement.

This purpose of the Part 2 report is to demonstrate the EUT complies with FCC RF exposure requirement under Tx varying transmission scenarios, thereby validity of Qualcomm Smart Transmit feature for FCC equipment authorization. It serves to compliment the Part 0 and Part 1 Test Reports to justify compliance per FCC.

The  $P_{limit}$  used in this report is determined in Part 0 and Part 1 report. Refer to Part 1 SAR report, for product description and terminology used in this report.

Per Qualcomm's document, embedded file system (EFS) version 20 products are required to be verified for Smart Tx generation for relevant MCC settings. It was confirmed that this DUT contains embedded file system (EFS) version 20 configured for Smart Tx 2nd generation (GEN2) for Sub6, with MCC settings for the US market and WLAN/BT are the radios outside of Smart Transmit control.

### <Test Lab Information>

Test Firm Name	Sporton International Inc. (Shenzhen)
Test Firm Information	1/F, 2/F, Bldg 5, Shiling Industrial Zone, Xinwei Village, Xili, Nanshan, Shenzhen, 518055 People's Republic of China TEL: +86-755-86379589 FAX: +86-755-86379595
FCC Designation No.	CN1256
Test Firm Registration Number for FCC	421272
Test Site No.	SAR02-SZ
IMEI Code	Conducted: IMEI1: 354958440024637 IMEI2: 354958440024645 Radiated: IMEI1: 354958440023431 IMEI2: 354958440023449
Date of Start during the Test	1/9/2024
Date of End during the Test	1/18/2024
Test Engineers	Johnny Chen/Bran Yin

## 1.1 Configurable parameters

### ***Tx\_power\_at\_SAR\_design\_target (Plimit in dBm) for Tx transmitting frequency < 6 GHz:***

The maximum time-average transmit power, in dBm, at which this radio configuration (i.e., band and technology) reaches the *SAR\_design\_target*. This *SAR\_design\_target* is predetermined for the specific device and it shall be less than regulatory SAR limit after accounting for all design related tolerances. The time-averaged SAR is assessed against this *SAR\_design\_target* in real time to determine the compliance. The Plimit could vary with technology, band, antenna and DSI (device state index), therefore it has the unique value for each technology, band, antenna and DSI.

### **<Reserve\_power\_margin (dB)>:**

- For RTSAR EFS v17 and lower, enter the *reserve\_power\_margin\_dB* as configured in the EFS.
- For EFS v18, enter the *reserve\_power\_margin\_dB\_2g\_3g\_wwan* as configured in the EFS for 2G/3G
- For EFS v18, enter calculated value =  
 $-10 \cdot \log_{10}(\text{total\_min\_exp\_budget\_linear\_4g\_5g\_wwan})$  based on EFS configuration for 4G (LTE)
- For EFS v19, if *WLAN\_BT\_control* = OFF, enter  
calculated value =  $-10 \cdot \log_{10}(\text{TOTAL\_MIN\_RES\_RATIO})$
- For EFS v19, if *WLAN\_BT\_control* = ON, enter  
calculated value =  $-10 \cdot \log_{10}(\text{TOTAL\_MIN\_RES\_RATIO} + \text{BT\_AND\_2+\_RADIO\_SAME\_AG})$

The reserve margin for WWAN radios can be configured for each sub6 antenna group, and each exposure category as shown below:

For a given exposure category (head vs. non-head) and antenna group, OEM can configure:

- ***TOTAL\_MIN\_RES\_RATIO***  
This entry corresponds to the minimum reserve margin for WWAN radio or WLAN radio when operating in standalone mode per antenna group. Here, *TOTAL\_MIN\_RES\_RATIO* is in linear units ranging between [0 1].
- ***WWAN\_PRI\_SPLIT\_RATIO, WWAN\_SEC\_SPLIT\_RATIO***  
In multi-Tx scenarios in the same antenna group, minimum reserve for each active radio (i.e., WWAN primary radio, WWAN secondary radio) is a product of the corresponding fraction out of sum of active radio split ratios and *TOTAL\_MIN\_RES\_RATIO*.

Here, *WWAN\_PRI\_SPLIT\_RATIO* and *WWAN\_SEC\_SPLIT\_RATIO* are in linear units ranging between [0 1].

*Multi\_Tx\_factor*: ONLY applicable for Smart Transmit EFS version 19 (or higher).

The EFS version 19 (or higher) provides the entry to improve performance of sub6 radios in simultaneous transmission scenarios.



**With EFS version 19 or higher:**

In single Tx transmission scenarios, Smart Transmit ensures time-averaged RF exposure is  $\leq (SAR\_design\_target * 10(+ \text{sub6 device uncertainty}/10)) < \text{regulatory RF exposure limit for sub6 radio}$  managed by Smart Transmit. In simultaneous Tx transmission scenarios, Smart Transmit ensures time-averaged RF exposure is  $\leq (SAR\_design\_target * multi\_Tx\_factor * 10(+ \text{sub6 device uncertainty}/10)) < \text{regulatory RF exposure limit for sub6 radios}$  managed by Smart Transmit. These simultaneous transmission scenarios are listed below:

- 2-or-more radio scenarios within WWAN like EN-DC, LTE ULCA, etc.
- 2-or-more-radio across technologies such as WWAN+WLAN, WWAN+BT, WLAN+BT and WWAN+WLAN+BT transmission scenarios (if WLAN/BT radios are also managed by Smart Transmit).

*Hand exposure applicability when device held next to head:* Yes/No switch. ONLY applicable for Smart Transmit EFS version 19 (or higher).

If "Yes" is selected in Smart Transmit EFS version 19 (or higher) for the country/region of interest, then Smart Transmit will ensure time-averaged RF exposure compliance in both hand and head tissue regions when device is held next to head in a voice call. Otherwise, if "No" is selected, then Smart Transmit will ensure time-averaged RF exposure compliance only in head tissue region when device is held next to head.

This model's multi\_Tx\_factor is 1.0.



---

## 2 Tx Varying Transmission Test Cases and Test Proposal

---

To validate time averaging feature and demonstrate the compliance in Tx varying transmission conditions, the following transmission scenarios are covered in Part 2 test:

1. During a time-varying Tx power transmission: To prove that the Smart Transmit feature accounts for Tx power variations in time accurately.
2. During a call disconnect and re-establish scenario: To prove that the Smart Transmit feature accounts for history of past Tx power transmissions accurately.
3. During technology/band handover: To prove that the Smart Transmit feature functions correctly during transitions in technology/band.
4. During DSI (Device State Index) change: To prove that the Smart Transmit feature functions correctly during transition from one device state (DSI) to another.
5. During antenna (or beam) switch: To prove that the Smart Transmit feature functions correctly during transitions in antenna (such as AsDiv scenario) or beams (different antenna array configurations).
6. SAR exposure switching between two active radios (radio1 and radio2): To prove that the Smart Transmit feature functions correctly and ensures total RF exposure compliance when exposure varies among SAR\_radio1 only, SAR\_radio1 + SAR\_radio2, and SAR\_radio2 only scenarios.

As described in Part 1 report, the RF exposure is proportional to the Tx power for a SAR-characterized wireless device. Thus, feature validation in Part 2 can be effectively performed through conducted and radiated power measurement. Therefore, the compliance demonstration under dynamic transmission conditions and feature validation are done in conducted/radiated power measurement setup for transmission scenario 1 through 8.

To add confidence in the feature validation, the time-averaged SAR measurements are also performed but only performed for transmission scenario 1 to avoid the complexity in SAR measurement (such as, for scenario 3 requiring change in SAR probe calibration file to accommodate different bands and/or tissue simulating liquid).

The strategy for testing in Tx varying transmission condition is outlined as follows:

- Demonstrate the total RF exposure averaged over FCC defined time windows does not exceed FCC's SAR limits, through time-averaged power measurements
  - Measure conducted Tx power (for  $f < 6\text{GHz}$ ) versus time, and radiated Tx power (EIRP for  $f > 10\text{GHz}$ ) versus time.
  - Convert it into RF exposure and divide by respective FCC limits to get normalized exposure versus time.
  - Perform running time-averaging over FCC defined time windows.
  - Demonstrate that the total normalized time-averaged RF exposure is less than 1 for all transmission scenarios at all times.

Mathematical expression:

- For sub-6 transmission only:



$$1g\_or\_10gSAR(t) = \frac{conducted\_Tx\_power(t)}{conducted\_Tx\_power\_P_{limit}} * 1g\_or\_10gSAR\_P_{limit} \quad (1a)$$

$$\frac{\frac{1}{T_{SAR}} \int_{t-T_{SAR}}^t 1g\_or\_10gSAR(t) dt}{FCC\ SAR\ limit} \leq 1 \quad (1b)$$

where,  $conducted\_Tx\_power(t)$ ,  $conducted\_Tx\_power\_P_{limit}$ , and  $1g\_or\_10gSAR\_P_{limit}$  correspond to the measured instantaneous conducted Tx power, measured conducted Tx power at  $P_{limit}$ , and measured  $1gSAR$  or  $10gSAR$  values at  $P_{limit}$  corresponding to sub-6 transmission.

- Demonstrate the total RF exposure averaged over FCC defined time windows does not exceed FCC's SAR limits, through time-averaged SAR measurements. Note as mentioned earlier, this measurement is performed for transmission scenario 1 only.
  - For sub-6 transmission only, measure instantaneous SAR versus time; for LTE+ sub6 NR transmission, request low power (or all-down bits) on LTE so that measured SAR predominantly corresponds to sub6 NR.
  - Convert it into RF exposure and divide by respective FCC limits to obtain normalized exposure versus time.
  - Perform time averaging over FCC defined time window.
  - Demonstrate that the total normalized time-averaged RF exposure is less than 1 for transmission scenario 1 at all times.

Mathematical expression:

- For sub-6 transmission only:

$$1g\_or\_10gSAR(t) = \frac{pointSAR(t)}{pointSAR\_P_{limit}} * 1g\_or\_10gSAR\_P_{limit} \quad (3a)$$

$$\frac{\frac{1}{T_{SAR}} \int_{t-T_{SAR}}^t 1g\_or\_10gSAR(t) dt}{FCC\ SAR\ limit} \leq 1 \quad (3b)$$

where,  $pointSAR(t)$ ,  $pointSAR\_P_{limit}$ , and  $1g\_or\_10gSAR\_P_{limit}$  correspond to the measured instantaneous point SAR, measured point SAR at  $P_{limit}$ , and measured  $1gSAR$  or  $10gSAR$  values at  $P_{limit}$  corresponding to sub-6 transmission.

**NOTE:** cDASY6 measurement system by Schmid & Partner Engineering AG (SPEAG) of Zurich, Switzerland measures relative E-field, and provides ratio of  $\frac{[pointE(t)]^2}{[pointE\_input.power.limit]^2}$  versus time.

### 3 SAR Time Averaging Validation Test Procedures

---

This chapter provides the test plan and test procedure for validating Qualcomm Smart Transmit feature for sub-6 transmission. The 100 seconds time window for operating  $f < 3\text{GHz}$  is used as an example to detail the test procedures in this chapter.

#### 3.1 Test sequence determination for validation

Following the FCC recommendation, two test sequences having time-variation in Tx power are predefined for sub-6 ( $f < 6\text{GHz}$ ) validation:

- Test sequence 1: request EUT's Tx power to be at maximum power, measured  $P_{max}^{\dagger}$ , for 80s, then requesting for half of the maximum power, i.e., measured  $P_{max}/2$ , for the rest of the time.
- Test sequence 2: request EUT's Tx power to vary with time. This sequence is generated relative to measured  $P_{max}$ , measured  $P_{limit}$  and calculated  $P_{reserve}$  (= measured  $P_{limit}$  in dBm - Reserve\_power\_margin in dB) of EUT based on measured  $P_{limit}$ .

The details for generating these two test sequences is described and listed in Appendix A.

**NOTE:** For test sequence generation, “measured P<sub>limit</sub>” and “measured P<sub>max</sub>” are used instead of the “P<sub>limit</sub>” specified in EFS entry and “P<sub>max</sub>” specified for the device, because Smart Transmit feature operates against the actual power level of the “P<sub>limit</sub>” that was calibrated for the EUT. The “measured P<sub>limit</sub>” accurately reflects what the feature is referencing to, therefore, it should be used during feature validation testing. The RF tune up and device-to-device variation are already considered in Part 0 report prior to determining P<sub>limit</sub>.

#### 3.2 Test configuration selection criteria for validating Smart Transmit feature

For validating Smart Transmit feature, this section provides a general guidance to select test cases. In practice, an adjustment can be made in test case selection. The justification/clarification may be provided.

### 3.2.1 Test configuration selection for time-varying Tx power transmission

The Smart Transmit time averaging feature operation is independent of bands, modes, and channels for a given technology. Hence, validation of Smart Transmit in one band/mode/channel per technology is sufficient.

The criteria for the selection are based on the  $P_{limit}$  values determined in Part 1 report. Select the band in each supported technology that corresponds to the  $P_{limit}$  value that is less than  $P_{max}$  for validating Smart Transmit.

Note this test is designed for single radio transmission scenario. If UE supports sub6 NR in both non-standalone (NSA) and standalone (SA) modes, then validation in time-varying Tx power transmission scenario described in this section needs to be performed in SA mode. Otherwise, it needs to be performed in NSA mode with LTE anchor set to low power. The choice between SA and NSA mode needs to also take into account the selection criteria described below. In general, one mode out of the two modes (NSA or SA) is sufficient for this test.

### 3.2.2 Test configuration selection for change in call

The criteria to select a test configuration for call-drop measurement is:

- Select technology/band with least  $P_{limit}$  among all supported technologies/bands, and select the radio configuration (e.g., # of RBs, channel#) in this technology/band that corresponds to the highest *measured* 1gSAR at  $P_{limit}$  listed in Part 1 report.
- In case of multiple bands having same least  $P_{limit}$ , then select the band having the highest *measured* 1gSAR at  $P_{limit}$  in Part 1 report.

This test is performed with the EUT's Tx power requested to be at maximum power, the above band selection will result in Tx power enforcement (i.e., EUT forced to have Tx power at  $P_{reserve}$ ) for longest duration in one FCC defined time window. The call change (call drop/reestablish) is performed during the Tx power enforcement duration (i.e., during the time when EUT is forced to have Tx power at  $P_{reserve}$ ). One test is sufficient as the feature operation is independent of technology and band.

### 3.2.3 Test configuration selection for change in technology/band

The selection criteria for this measurement is, for a given antenna, to have EUT switch from a technology/band with lowest  $P_{limit}$  within the technology group (in case of multiple bands having the same  $P_{limit}$ , then select the band with highest *measured* 1gSAR at  $P_{limit}$ ) to a technology/band with highest  $P_{limit}$  within the technology group, in case of multiple bands having the same  $P_{limit}$ , then select the band with lowest *measured* 1gSAR at  $P_{limit}$  in Part 1 report, or vice versa.

This test is performed with the EUT's Tx power requested to be at maximum power, the technology/band switch is performed during Tx power enforcement duration (i.e., during the time when EUT is forced to have Tx power at  $P_{reserve}$ ).

### 3.2.4 Test configuration selection for change in DSI

The criteria to select a test configuration for DSI change test is

- Select a technology/band having the  $P_{limit} < P_{max}$  within any technology and DSI group, and for the same technology/band having a different  $P_{limit}$  in any other DSI group. Note that the selected DSI transition need to be supported by the device.

This test is performed with the EUT's Tx power requested to be at maximum power in selected technology/band, and DSI change is conducted during Tx power enforcement duration (i.e., during the time when EUT is forced to have Tx power at  $P_{reserve}$ ).

### 3.2.5 Test configuration selection for SAR exposure switching

If supported, the test configuration for SAR exposure switching should cover

1. SAR exposure switch when two active radios are in the same time window
2. SAR exposure switch when two active radios are in different time windows. One test with two active radios in any two different time windows is sufficient as Smart Transmit operation is the same for RF exposure switch in any combination of two different time windows.

The Smart Transmit time averaging operation is independent of the source of SAR exposure (for example, LTE vs. Sub6 NR) and ensures total time-averaged RF exposure compliance. Hence, validation of Smart Transmit in any one simultaneous SAR transmission scenario (i.e., one combination for LTE + Sub6 NR transmission) is sufficient, where the SAR exposure varies among  $SAR_{radio1}$  only,  $SAR_{radio1} + SAR_{radio2}$ , and  $SAR_{radio2}$  only scenarios.

The criteria to select a test configuration for validating Smart Transmit feature during SAR exposure switching scenarios is

- Select any two < 6GHz technologies/bands that the EUT supports simultaneous transmission (for example, LTE+ Sub6 NR).
- Among all supported simultaneous transmission configurations, the selection order is
  1. select one configuration where both  $P_{limit}$  of radio1 and radio2 is less than their corresponding  $P_{max}$ , preferably, with different  $P_{limits}$ . If this configuration is not available, then,
  2. select one configuration that has  $P_{limit}$  less than its  $P_{max}$  for at least one radio. If this can not be found, then,
  3. select one configuration that has  $P_{limit}$  of radio1 and radio2 greater than  $P_{max}$  but with least ( $P_{limit} - P_{max}$ ) delta.

SAR exposure switch validation with one simultaneous transmission scenario (i.e., either FR1 NSA or LTE inter-band ULCA) is sufficient as Smart Transmit operation is the same.

### 3.2.6 Test configuration selection for change in time window

FCC specifies different time window for time averaging based on operation frequency. The criteria to select a test configuration for validating Smart Transmit feature and demonstrating the compliance during the change in time window is

- Select any technology/band that has operation frequency classified in one time window defined by FCC (such as 100-seconds time window), and its corresponding  $P_{limit}$  is less than  $P_{max}$  if possible.
- Select the 2<sup>nd</sup> technology/band that has operation frequency classified in a different time window defined by FCC (such as 60-seconds time window), and its corresponding  $P_{limit}$  is less than  $P_{max}$  if possible.
- It is preferred both  $P_{limit}$  values of two selected technology/band less than corresponding  $P_{max}$ , but if not possible, at least one of technologies/bands has its  $P_{limit}$  less than  $P_{max}$ .

This test is performed with the EUT's Tx power requested to be at maximum power in selected technology/band. Test for one pair of time windows selected is sufficient as the feature operation is the same.

### 3.2.7 Test configuration selection for Exposure Category Switch

When exposure DSI changes from head to body-worn or vice versa, it is obvious that the exposure from an active radio does not expose the same tissues. Therefore, with Qualcomm Smart Transmit EFS version 18 (or higher), the exposure continuity is handled in two categories: Head exposure and non-head exposure.

- Head exposure category includes all 4 positions of left cheek, left tilted, right cheek and right titled
- Non-head exposure category includes all other exposure scenarios (except head), i.e., body-worn, hotspot, extremity, etc.

The purpose of this test is to demonstrate that Smart Transmit ensures time-averaged RF exposure compliance when the EUT exposure category changes. For this purpose, there are two tests performed: (a) start with head exposure and switch to non-head exposure and switch back to head exposure, and (b) start with non-head exposure and switch to head exposure and switch back to non-head exposure.

The criteria to select a test configuration for exposure category switch measurement is:

□ If  $P_{limit} < P_{max}$  for at least one radio out of all supported technology/band/antenna /DSI, then:

(a) Out of all head exposure DSIs, select a technology/band/antenna/DSI having the least  $P_{limit}$  ( $< P_{max}$ ), furthermore, having the largest difference between  $P_{max}$  and  $P_{limit}$  ( $P_{limit} < P_{max}$ ) should be considered in the selection. Then, select a second DSI in the nonhead exposure category DSI that has the least  $P_{limit}$  among all the non-head DSIs for the same technology/band/antenna. This technology/band /antenna and selected



DSIs are used for head to non-head to head exposure switch test. If the  $P_{limit} > P_{max}$  for all supported technology/band/antenna/DSI in head exposure category, then this test is not required.

(b) Similarly, out of all non-head exposure DSIs, select a technology/band/antenna /DSI having the least  $P_{limit} (< P_{max})$ , furthermore, having the largest difference between  $P_{max}$  and  $P_{limit} (P_{limit} < P_{max})$  should be considered in the selection. Then, select a second DSI in the head exposure category DSI that has the least  $P_{limit}$  among all the head DSIs for the same technology/band/antenna. This technology/band/antenna and selected DSIs are used for non-head to head to non-head exposure switch test. If the  $P_{limit} > P_{max}$  for all supported technology/band/antenna/DSI in non-head exposure category, then this test is not required.

□ If  $P_{limit} > P_{max}$  for all supported technology/band/antenna/DSIs for both head and nonhead DSI categories, then:

(c) select a supported sub6 simultaneous transmission scenario (like LTE + FR1 NSA, or LTE inter-band ULCA, or FR1 inter-band NR-DC, etc.) in head DSI that has  $P_{limit} < P_{max} + 10 \cdot \log(N)$  for all radios of selected technology(s)/band(s)/antenna(s), where N is the number of active radios in selected sub6 simultaneous transmission scenario. Note that the antennas determined for the selected radios of simultaneous transmission scenario should be in the same antenna group if EUT is configured with GEN2\_SUB6. Then, select a second DSI in the non-head exposure category that has the lowest  $P_{limit}$  among all the non-head DSIs for all the radios of the selected

technology(s)/band(s)/antenna(s) simultaneous transmission scenario. This selected technology(s)/band(s)/antenna(s) and selected DSIs are used for head to non-head to head exposure switch test. If the head DSI has  $P_{limit} > P_{max} + 10 \cdot \log(N)$  for all radios supported in sub6 simultaneous transmission scenarios, then this test is not required.

(d) select a supported sub6 simultaneous transmission scenario (like LTE + FR1 NSA, or LTE inter-band ULCA, or FR1 inter-band NR-DC, etc.) in non-head DSI that has  $P_{limit} < P_{max} + 10 \cdot \log(N)$  for all radios of the selected technology(s)/band(s) /antenna(s), where N is the number of active radios in selected sub6 simultaneous transmission scenario. Note that the antennas determined for the selected radios of simultaneous transmission scenario should be in the same antenna group if EUT is configured with GEN2\_SUB6. Then, select a second DSI in the head exposure category that has the lowest  $P_{limit}$  among all the head DSIs for all the radios of the selected technology(s)/band(s) /antenna(s) simultaneous transmission scenario. This selected technology(s)/band(s) /antenna(s) and selected DSIs are used for non-head to head to non-head exposure switch test. If the non-head DSI has  $P_{limit} > P_{max} + 10 \cdot \log(N)$  for all radios supported in sub6 simultaneous transmission scenarios, then this test is not required.

□ Use the highest measured 1g\_or\_10g SAR at  $P_{limit} (P_{limit} < P_{max})$  shown in Part 1 report for the selected tech/band/antenna/DSI out of all radio configurations and device positions in Equation (1a) and (3a) to calculate time-varying SAR. However, in the case of  $P_{limit} > P_{max}$ , the SAR measured in Part 1 report for the corresponding radio configuration selected and tested in Part 2 should be applied in Equation (1a) and (3a).



### 3.3 Test procedures for conducted power measurements

This section provides general conducted power measurement procedures to perform compliance test under dynamic transmission scenarios described in Section 2. In practice, an adjustment can be made in these procedures. The justification/clarification may be provided.

#### 3.3.1 Time-varying Tx power transmission scenario

This test is performed with the two pre-defined test sequences described in Section 3.1 for all the technologies and bands selected in Section 3.2.1. The purpose of the test is to demonstrate the effectiveness of power limiting enforcement and that the time-averaged SAR (corresponding time-averaged Tx power) does not exceed the FCC limit at all times (see Eq. (1a) and (1b)).

##### Test procedure

1. Measure  $P_{max}$ , measure  $P_{limit}$  and calculate  $P_{reserve}$  (= measured  $P_{limit}$  in dBm – Reserve\_power\_margin in dB) and follow Section 3.1 to generate the test sequences for all the technologies and bands selected in Section 3.2.1. Both test sequence 1 and test sequence 2 are created based on measured  $P_{max}$  and measured  $P_{limit}$  of the EUT. Test condition to measure  $P_{max}$  and  $P_{limit}$  is:
  - Measure  $P_{max}$  with Smart Transmit disabled and callbox set to request maximum power.
  - Measure  $P_{limit}$  with Smart Transmit Peak exposure mode enabled, callbox set to request maximum power.
  - Measure  $P_{reserve}$  via test sequence 1 measurement.
2. Set the EUT to the intended Smart Transmit exposure mode, and then set callbox requesting the EUT's Tx power to be at pre-defined test sequence 1, measure and record Tx power versus time, and then convert the conducted Tx power into 1gSAR or 10gSAR value (see Eq. (1a)) using measured  $P_{limit}$  from above Step 1. Perform running time average to determine time-averaged power and 1gSAR or 10gSAR versus time as illustrated in Figure 3-1 where using 100-seconds time window as an example.

**NOTE:** In Eq.(1a), instantaneous Tx power is converted into instantaneous 1gSAR or 10gSAR value by applying the measured worst-case 1gSAR or 10gSAR value at  $P_{limit}$  for the corresponding technology/band/antenna/DSI reported in Part 1 report.

**NOTE:** For an easier computation of the running time average, 0 dBm can be added at the beginning of the test sequences the length of the responding time window, for example, add 0dBm for 100-seconds so the running time average can be directly performed starting with the first 100-seconds data using excel spreadsheet. This technique applies to all tests performed in this Part 2 report for easier time-averaged computation using excel spreadsheet.

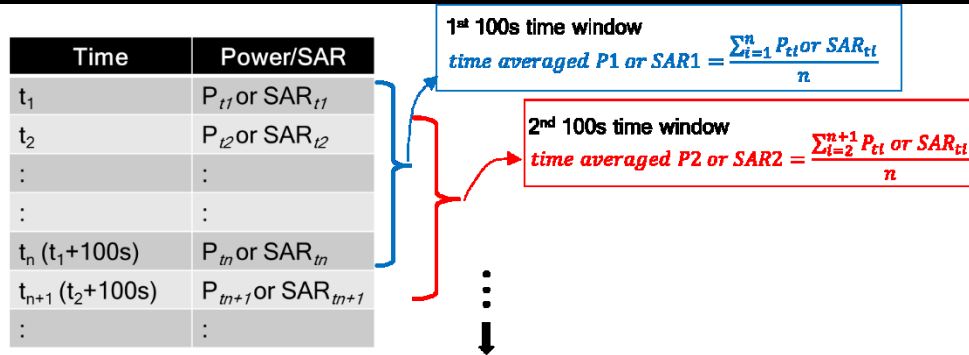

Figure 3-1 100s running average illustration

3. Make one plot containing:
  - a. Instantaneous Tx power versus time measured in Step 2,
  - b. Requested Tx power used in Step 2 (test sequence 1),
  - c. Computed time-averaged power versus time determined in Step 2,
  - d. Time-averaged power limit (corresponding to FCC SAR limit of 1.6 W/kg for 1gSAR or 4.0W/kg for 10gSAR) given by

$$Time\ averaged\ power\ limit = meas.P_{limit} + 10 \times \log\left(\frac{FCC\ SAR\ limit}{meas.SAR\_Plimit}\right) \quad (5a)$$

where  $meas.P_{limit}$  and  $meas.SAR\_Plimit$  correspond to measured power at  $P_{limit}$  and measured SAR at  $P_{limit}$ .

4. Make another plot containing:
  - a. Computed time-averaged 1gSAR or 10gSAR versus time determined in Step 2
  - b. FCC 1gSAR<sub>limit</sub> of 1.6W/kg or FCC 10gSAR<sub>limit</sub> of 4.0W/kg.
5. Repeat Steps 2 ~ 4 for pre-defined test sequence 2 and replace the requested Tx power (test sequence 1) in Step 2 with test sequence 2.
6. Repeat Steps 2 ~ 5 for all the selected technologies and bands.

The validation criteria are, at all times, the time-averaged power versus time shown in Step 3 plot shall not exceed the time-averaged power limit (defined in Eq. (5a)), in turn, the time-averaged 1gSAR or 10gSAR versus time shown in Step 4 plot shall not exceed the FCC limit of 1.6 W/kg for 1gSAR or 4.0 W/kg for 10gSAR (i.e., Eq. (1b)).

### 3.3.2 Change in call scenario

This test is to demonstrate that Smart Transmit feature accurately accounts for the past Tx powers during time-averaging when a new call is established.

The call disconnects and re-establishment needs to be performed during power limit enforcement, i.e., when the EUT's Tx power is at  $P_{reserve}$  level, to demonstrate the continuity of RF exposure management and limiting in call change scenario. In other words, the RF exposure averaged over any FCC defined time window (including the time



windows containing the call change) doesn't exceed FCC limit of 1.6 W/kg for 1gSAR or 4.0 W/kg for 10gSAR.

### Test procedure

1. Measure  $P_{limit}$  for the technology/band selected in Section 3.2.2. Measure  $P_{limit}$  with Smart Transmit Peak exposure mode enabled, callbox set to request maximum power.
2. Set *Reserve\_power\_margin* to actual (intended) value and reset power on EUT to enable Smart Transmit.
3. Establish radio link with callbox in the selected technology/band.
4. Request EUT's Tx power at 0 dBm for at least one time window specified for the selected technology/band, followed by requesting EUT's Tx power to be at maximum power for about ~60 seconds, and then drop the call for ~10 seconds. Afterwards, re-establish another call in the same radio configuration (i.e., same technology/band/channel) and continue callbox requesting EUT's Tx power to be at maximum power for the remaining time of at least another full duration of the specified time window. Measure and record Tx power versus time. Once the measurement is done, extract instantaneous Tx power versus time, convert the measured conducted Tx power into 1gSAR or 10gSAR value using Eq. (1a), and then perform the running time average to determine time-averaged power and 1gSAR or 10gSAR versus time.

**NOTE:** In Eq.(1a), instantaneous Tx power is converted into instantaneous 1gSAR or 10gSAR value by applying the measured worst-case 1gSAR or 10gSAR value at  $P_{limit}$  for the corresponding technology/band/antenna/DSI reported in Part 1 report.

5. Make one plot containing: (a) instantaneous Tx power versus time, (b) requested power, (c) computed time-averaged power, (d) time-averaged power limit calculated using Eq.(5a).
6. Make another plot containing: (a) computed time-averaged 1gSAR or 10gSAR versus time, and (b) FCC limit of 1.6 W/kg for 1gSAR or 4.0 W/kg for 10gSAR.

The validation criteria are, at all times, the time-averaged power versus time shall not exceed the time-averaged power limit (defined in Eq.(5a)), in turn, the time-averaged 1gSAR or 10gSAR versus time shall not exceed the FCC limit of 1.6 W/kg for 1gSAR or 4.0 W/kg for 10gSAR (i.e., Eq. (1b)).

### 3.3.3 Change in technology and band

This test is to demonstrate the correct power control by Smart Transmit during technology switches and/or band handovers.

Similar to the change in call test in Section 3.3.2, to validate the continuity of RF exposure limiting during the transition, the technology and band handover needs to be performed when EUT's Tx power is at  $P_{reserve}$  level (i.e., during Tx power enforcement) to make sure that the EUT's Tx power from previous  $P_{reserve}$  level to the new  $P_{reserve}$  level

(corresponding to new technology/band). Since the  $P_{limit}$  could vary with technology and band, Eq. (1a) can be written as follows to convert the instantaneous Tx power in 1gSAR or 10gSAR exposure for the two given radios, respectively:

$$1g\_or\_10gSAR_1(t) = \frac{conducted\_Tx\_power\_1(t)}{conducted\_Tx\_power\_P_{limit\_1}} * 1g\_or\_10gSAR\_P_{limit\_1} \quad (6a)$$

$$1g\_or\_10gSAR_2(t) = \frac{conducted\_Tx\_power\_2(t)}{conducted\_Tx\_power\_P_{limit\_2}} * 1g\_or\_10gSAR\_P_{limit\_2} \quad (6b)$$

$$\frac{1}{T_{SAR}} \left[ \int_{t-T_{SAR}}^{t_1} \frac{1g\_or\_10gSAR_1(t)}{FCC\ SAR\ limit} dt + \int_{t-T_{SAR}}^t \frac{1g\_or\_10gSAR_2(t)}{FCC\ SAR\ limit} dt \right] \leq 1 \quad (6c)$$

where,  $conducted\_Tx\_power\_1(t)$ ,  $conducted\_Tx\_power\_P_{limit\_1}$ , and  $1g\_or\_10gSAR\_P_{limit\_1}$  correspond to the measured instantaneous conducted Tx power, measured conducted Tx power at  $P_{limit}$ , and measured 1gSAR or 10gSAR value at  $P_{limit}$  of technology1/band1;  $conducted\_Tx\_power\_2(t)$ ,  $conducted\_Tx\_power\_P_{limit\_2}(t)$ , and  $1g\_or\_10gSAR\_P_{limit\_2}$  correspond to the measured instantaneous conducted Tx power, measured conducted Tx power at  $P_{limit}$ , and measured 1gSAR or 10gSAR value at  $P_{limit}$  of technology2/band2. Transition from technology1/band1 to the technology2/band2 happens at time-instant ' $t_1$ '.

## Test procedure

1. Measure  $P_{limit}$  for both the technologies and bands selected in Section 3.2.3. Measure  $P_{limit}$  with Smart Transmit Peak exposure mode enabled, callbox set to request maximum power.
2. Set *Reserve\_power\_margin* to actual (intended) value and reset power on EUT to enable Smart Transmit
3. Establish radio link with callbox in first technology/band selected.
4. Request EUT's Tx power at 0 dBm for at least one time window specified for the selected technology/band, followed by requesting EUT's Tx power to be at maximum power for about ~60 seconds, and then switch to second technology/band selected. Continue with callbox requesting EUT's Tx power to be at maximum power for the remaining time of at least another full duration of the specified time window. Measure and record Tx power versus time for the full duration of the test.
5. Once the measurement is done, extract instantaneous Tx power versus time, and convert the conducted Tx power into 1gSAR or 10gSAR value using Eq. (6a) and (6b) and corresponding measured  $P_{limit}$  values from Step 1 of this section. Perform the running time average to determine time-averaged power and 1gSAR or 10gSAR versus time.

**NOTE:** In Eq.(6a) & (6b), instantaneous Tx power is converted into instantaneous 1gSAR or 10gSAR value by applying the measured worst-case 1gSAR or 10gSAR value at  $P_{limit}$  for the corresponding technology/band/antenna/DSI reported in Part 1 report.

6. Make one plot containing: (a) instantaneous Tx power versus time, (b) requested power, (c) computed time-averaged power, (d) time-averaged power limit calculated using Eq.(5a).

7. Make another plot containing: (a) computed time-averaged 1gSAR or 10gSAR versus time, and (b) FCC limit of 1.6 W/kg for 1gSAR or 4.0 W/kg for 10gSAR.

The validation criteria are, at all times, the time-averaged 1gSAR or 10gSAR versus time shall not exceed the FCC limit of 1.6 W/kg for 1gSAR or 4.0 W/kg for 10gSAR (i.e., Eq. (6c)).

### 3.3.4 Change in antenna

This test is to demonstrate the correct power control by Smart Transmit during antenna switches from one antenna to another. The test procedure is identical to Section 3.3.3, by replacing technology/band switch operation with antenna switch. The validation criteria are, at all times, the time-averaged 1gSAR or 10gSAR versus time shall not exceed FCC limit of 1.6 W/kg for 1gSAR or 4.0 W/kg for 10gSAR.

**NOTE:** If the EUT does not support antenna switch within the same technology/band, but has multiple antennas to support different frequency bands, then the antenna switch test is included as part of change in technology and band (Section 3.3.3) test.

### 3.3.5 Change in DSI

This test is to demonstrate the correct power control by Smart Transmit during DSI switches from one DSI to another. The test procedure is identical to Section 3.3.3, by replacing technology/band switch operation with DSI switch. The validation criteria are, at all times, the time-averaged normalized exposure versus time shall not exceed the normalized limit of 1.0.

### 3.3.6 Change in time window

This test is to demonstrate the correct power control by Smart Transmit during the change in averaging time window when a specific band handover occurs. FCC specifies time-averaging windows of 100s for Tx frequency < 3GHz, and 60s for Tx frequency between 3GHz and 6GHz.

To validate the continuity of RF exposure limiting during the transition, the band handover test needs to be performed when EUT handovers from operation band less than 3GHz to greater than 3GHz and vice versa. The equations (3a) and (3b) in Section 2 can be written as follows for transmission scenario having change in time window,

$$1gSAR_1(t) = \frac{conducted\_Tx\_power\_1(t)}{conducted\_Tx\_power\_P_{limit\_1}} * 1g\_or\ 10g\_SAR\_P_{limit\_1} \quad (7a)$$

$$1gSAR_2(t) = \frac{conducted\_Tx\_power\_2(t)}{conducted\_Tx\_power\_P_{limit\_2}} * 1g\_or\ 10g\_SAR\_P_{limit\_2} \quad (7b)$$

$$\frac{1}{T1_{SAR}} \left[ \int_{t-T1_{SAR}}^{t_1} \frac{1g\_or\ 10g\_SAR_1(t)}{FCC\ SAR\ limit} dt \right] + \frac{1}{T2_{SAR}} \left[ \int_{t-T2_{SAR}}^t \frac{1g\_or\ 10g\_SAR_2(t)}{FCC\ SAR\ limit} dt \right] \leq 1 \quad (7c)$$

where,  $conducted\_Tx\_power\_1(t)$ ,  $conducted\_Tx\_power\_P_{limit\_1}(t)$ , and  $1g\_or\ 10g\_SAR\_P_{limit\_1}$  correspond to the instantaneous Tx power, conducted Tx power at  $P_{limit}$ , and compliance  $1g\_or\ 10g\_SAR$  values at  $P_{limit\_1}$  of band1 with time-averaging

window ' $T1_{SAR}$ ';  $conducted\_Tx\_power\_2(t)$ ,  $conducted\_Tx\_power\_P_{limit\_2}(t)$ , and  $1g\_or\ 10g\_SAR\_P_{limit\_2}$  correspond to the instantaneous Tx power, conducted Tx power at  $P_{limit}$ , and compliance  $1g\_or\ 10g\_SAR$  values at  $P_{limit\_2}$  of band2 with time-averaging window ' $T2_{SAR}$ '. One of the two bands is less than 3GHz, another is greater than 3GHz. Transition from first band with time-averaging window ' $T1_{SAR}$ ' to the second band with time-averaging window ' $T2_{SAR}$ ' happens at time-instant ' $t_j$ '.

### Test procedure

1. Measure  $P_{limit}$  for both the technologies and bands selected in Section 3.2.6. Measure  $P_{limit}$  with Smart Transmit Peak exposure mode enabled, callbox set to request maximum power.
2. Set *Reserve\_power\_margin* to actual (intended) value and enable Smart Transmit

### Transition from 100s time window to 60s time window, and vice versa

1. Establish radio link with callbox in the technology/band having 100s time window selected in Section 3.2.6.
2. Request EUT's Tx power to be at 0 dBm for at least 100 seconds, followed by requesting EUT's Tx power to be at maximum power for about ~140 seconds, and then switch to second technology/band (having 60s time window) selected in Section 3.2.6. Continue with callbox requesting EUT's Tx power to be at maximum power for about ~60s in this second technology/band, and then switch back to the first technology/band. Continue with callbox requesting EUT's Tx power to be at maximum power for at least another 100s. Measure and record Tx power versus time for the entire duration of the test.
3. Once the measurement is done, extract instantaneous Tx power versus time, and convert the conducted Tx power into 1gSAR or 10gSAR value (see Eq. (7a) and (7b)) using corresponding technology/band Step 1 result, and then perform 100s running average to determine time-averaged 1gSAR or 10gSAR versus time. Note that in Eq.(7a) & (7b), instantaneous Tx power is converted into instantaneous 1gSAR or 10gSAR value by applying the worst-case 1gSAR or 10gSAR value tested in Part 1 for the selected technologies/bands at  $P_{limit}$ .
4. Make one plot containing: (a) instantaneous Tx power versus time measured in Step 4.
5. Make another plot containing: (a) instantaneous 1gSAR versus time determined in Step 5, (b) computed time-averaged 1gSAR versus time determined in Step 5, and (c) corresponding regulatory  $1gSAR_{limit}$  of 1.6W/kg or  $10gSAR_{limit}$  of 4.0W/kg.

### Transition from 60s time window to 100s time window, and vice versa

1. Establish radio link with callbox in the technology/band having 60s time window selected in Section 3.2.6.
2. Request EUT's Tx power to be at 0 dBm for at least 60 seconds, followed by requesting EUT's Tx power to be at maximum power for about ~80 seconds, and then switch to second technology/band (having 100s time window) selected in Section 3.2.6. Continue with callbox requesting EUT's Tx power to be at maximum power for about ~100s in this second technology/band, and then switch back to the first technology/band. Continue with callbox requesting EUT's Tx power to be at

maximum power for the remaining time for a total test time of 500 seconds. Measure and record Tx power versus time for the entire duration of the test.

3. Repeat above Step 5~7 to generate the plots

The validation criteria is, at all times, the time-averaged 1gSAR or 10gSAR versus time shall not exceed the regulatory  $1gSAR_{limit}$  of 1.6W/kg or  $10gSAR_{limit}$  of 4.0W/kg

### 3.3.7 SAR exposure switching

This test is to demonstrate that Smart Transmit feature is accurately accounts for switching in exposures among SAR from radio1 only, SAR from both radio1 and radio2, and SAR from radio2 only scenarios, and ensures total time-averaged RF exposure complies with the FCC limit. Here, radio1 represents primary radio (for example, LTE anchor in a NR non-standalone mode call) and radio2 represents secondary radio (for example, sub6 NR). The detailed test procedure for SAR exposure switching in the case of LTE+ sub6 NR non-standalone mode transmission scenario is provided in Appendix B.2.

#### Test procedure:

1. Measure conducted Tx power corresponding to  $P_{limit}$  for radio1 and radio2 in selected band. Test condition to measure conducted  $P_{limit}$  is:
  - Establish device in call with the callbox for radio1 technology/band. Measure conducted Tx power corresponding to radio1  $P_{limit}$  with Smart Transmit Peak exposure mode enabled, callbox set to request maximum power.
  - Repeat above step to measure conducted Tx power corresponding to radio2  $P_{limit}$ . If radio2 is dependent on radio1 (for example, non-standalone mode of sub6 NR requiring radio1 LTE as anchor), then establish radio1 + radio2 call with callbox, and request all down bits for radio1 LTE. In this scenario, with callbox requesting maximum power from radio2 sub6 NR, measured conducted Tx power corresponds to radio2  $P_{limit}$  (as radio1 LTE is at all-down bits)
2. Set EUT to intended Smart Transmit exposure mode, with EUT setup for radio1 + radio2 call. In this description, it is assumed that radio2 has lower priority than radio1. Establish device in radio1+radio2 call, and request all-down bits or low power on radio1, with callbox requesting EUT's Tx power to be at maximum power in radio2 for at least one time window. After one time window, set callbox to request EUT's Tx power to be at maximum power on radio1, i.e., all-up bits. Continue radio1+radio2 call with both radios at maximum power for at least one time window, and drop (or request all-down bits on) radio2. Continue radio1 at maximum power for at least one time window. Record the conducted Tx power for both radio1 and radio2 for the entire duration of this test.
3. Once the measurement is done, extract instantaneous Tx power versus time for both radio1 and radio2 links. Convert the conducted Tx power for both these radios into 1gSAR or 10gSAR value (see Eq. (6a) and (6b)) using corresponding technology/band  $P_{limit}$  measured in Step 1, and then perform the running time average to determine time-averaged 1gSAR or 10gSAR versus time.



4. Make one plot containing: (a) instantaneous Tx power versus time measured in Step 2.
5. Make another plot containing: (a) instantaneous 1gSAR versus time determined in Step 3, (b) computed time-averaged 1gSAR versus time determined in Step 3, and (c) corresponding regulatory  $1gSAR_{limit}$  of 1.6W/kg or  $10gSAR_{limit}$  of 4.0W/kg.

The validation criteria is, at all times, the time-averaged 1gSAR or 10gSAR versus time shall not exceed the regulatory  $1gSAR_{limit}$  of 1.6W/kg or  $10gSAR_{limit}$  of 4.0W/kg.

### 3.3.8 Test procedure for Exposure Category Switch

This test is performed with the EUT being requested to transmit at maximum power in selected technology/band/antenna/DSI. The change in exposure category is preferably performed during Tx power enforcement (i.e., EUT forced to transmit at a sustainable level). One test is sufficient as this feature operation is independent of technology, band and antenna. Test procedure are:

In case of head to non-head to head exposure switch test, 'first DSI' in below test procedure refers to head DSI and 'second DSI' refers to non-head DSI. Similarly, in case of non-head to head to non-head exposure switch test, 'first DSI' in below test procedure refers to non-head DSI and 'second DSI' refers to head DSI.

1. Measure  $P_{limit}$  for all the technology(s)/band(s)/antenna(s)/DSI(s) selected following the above selection criteria. Measure  $P_{limit}$  with Smart Transmit Peak exposure mode enabled and callbox set to request maximum power.
2. Set EUT to intended Smart Transmit exposure mode.
3. Establish radio link with first DSI and with callbox in the selected technology(s)/band(s)/antenna(s).
4. Request EUT to transmit at 0 dBm for at least 100 seconds, followed by requesting EUT to transmit at maximum Tx power for the active radio(s) for half of the regulatory time window, and then switch to the second DSI for ~10s, and switch back to the first DSI for at least one time window. Throughout this test, when switching between DSIs (i.e., switching between exposure categories), continue with callbox requesting EUT to transmit at maximum Tx power for the active radio(s). Measure and record Tx power versus time for the entire duration of the test.
5. Once the measurement is done, extract instantaneous Tx power versus time, and convert the conducted Tx power into 1g\_or\_10gSAR value (see Eq. (7a) and (7b)) using the corresponding  $P_{limit}$  measured in Step 1 and 1g\_or\_10gSAR value measured in Part 1 report, and then perform 100s running average to determine time-averaged 1g\_or\_10gSAR versus time as illustrated in Figure 3-1. Note that in Eq.(7a) & (7b), instantaneous Tx power is converted into instantaneous 1g\_or\_10gSAR value by applying the worst-case 1gSAR value for the selected technologies/bands at  $P_{limit}$  as reported in Part 1 report.
6. Make one plot containing: (a) computed time-averaged normalized 1g\_or\_10gSAR of the selected technology(s)/band(s)/antenna(s) versus time determined in Step 5 for exposure under first DSI, (b) total time-averaged normalized exposure for exposure under first DSI if simultaneous transmission scenario was tested, and (c) normalized regulatory limit of 1.0.

7. Make another plot containing: (a) computed time-averaged  $1g\_or\_10gSAR$  of the selected technology(s)/band(s)/antenna(s) versus time determined in Step 5 for exposure under second DSI, (b) total time-averaged normalized exposure for exposure under second DSI if simultaneous transmission scenario was tested, and (c) normalized regulatory limit of 1.0.

The validation criteria is, at all times, the time-averaged normalized exposure versus time shall not exceed the normalized limit of 1.0 for both first & second DSIs (i.e., both head exposure category and non-head exposure category).

### 3.4 Test procedure for time-varying SAR measurements

This section provides general time-varying SAR measurement procedures to perform compliance test under dynamic transmission scenarios described in Section 2. In practice, an adjustment can be made in these procedures. The justification/clarification may be provided.

To perform the validation through SAR measurement for transmission scenario 1 described in Section 2, the “path loss” between callbox antenna and EUT needs to be calibrated to ensure that the EUT Tx power reacts to the requested power from callbox in a radiated call. It should be noted that when signaling in closed loop mode, protocol-level power control is in play, resulting in EUT not solely following callbox TPC (Tx power control) commands. In other words, EUT response has many dependencies (RSSI, quality of signal, path loss variation, fading, etc.) other than just TPC commands. These dependencies have less impact in conducted setup (as it is a controlled environment and the path loss can be very well calibrated) but have significant impact on radiated testing in an uncontrolled environment, such as SAR test setup. Therefore, the deviation in EUT Tx power from callbox requested power is expected, however the time-averaged SAR should not exceed FCC SAR requirement at all times as Smart Transmit controls Tx power at EUT.

The following steps are for time averaging feature validation through SAR measurement:

1. “Path Loss” calibration: Place the EUT against the phantom in the worst-case position determined based on Section 3.2.1. For each band selected, prior to SAR measurement, perform “path loss” calibration between callbox antenna and EUT. Since the SAR test environment is not controlled and well calibrated for OTA (Over the Air) test, extreme care needs to be taken to avoid the influence from reflections. The test setup is described in Section 6.1.
2. Time averaging feature validation:
  - i For a given radio configuration (technology/band) selected in Section 3.2.1, enable Smart Transmit Peak exposure mode, with callbox to request maximum power, perform area scan, conduct pointSAR measurement at peak location of the area scan. This point SAR value,  $pointSAR\_P_{limit}$ , corresponds to point SAR at the measured  $P_{limit}$  (i.e., measured  $P_{limit}$  from the EUT in Step 1 of Section 3.3.1).
  - ii Set *Reserve\_power\_margin* to actual (intended) value and reset power on EUT to enable Smart Transmit. Note, if *Reserve\_power\_margin* cannot be set wirelessly, care must be taken to re-position the EUT in the exact same position

relative to the SAM phantom as in above Step 2.i. Establish radio link in desired radio configuration, with callbox requesting the EUT's Tx power at power levels described by test sequence 1 generated in Step 1 of Section 3.3.1, conduct point SAR measurement versus time at peak location of the area scan determined in Step 2.i of this section. Once the measurement is done, extract instantaneous point SAR vs time data,  $pointSAR(t)$ , and convert it into instantaneous 1gSAR or 10gSAR vs. time using Eq. (3a), re-written below:

$$1g\_or\_10gSAR(t) = \frac{pointSAR(t)}{pointSAR\_P_{limit}} * 1g\_or\_10gSAR\_P_{limit}$$

where,  $pointSAR\_P_{limit}$  is the value determined in Step 2.i, and  $pointSAR(t)$  is the instantaneous point SAR measured in Step 2.ii,  $1g\_or\_10gSAR\_P_{limit}$  is the measured 1gSAR or 10gSAR value listed in Part 1 report.

- iii Perform 100s running average to determine time-averaged 1gSAR or 10gSAR versus time.
- iv Make one plot containing: (a) time-averaged 1gSAR or 10gSAR versus time determined in Step 2.iii of this section, (b) FCC limit of 1.6 W/kg for 1gSAR or 4.0 W/kg for 10gSAR.
- v Repeat 2.ii ~ 2.iv for test sequence 2 generated in Step 1 of Section 3.3.1.
- vi Repeat 2.i ~ 2.v for all the technologies and bands selected in Section 3.2.1.

The time-averaging validation criteria for SAR measurement is that, at all times, the time-averaged 1gSAR or 10gSAR versus time shall not exceed FCC limit of 1.6 W/kg for 1gSAR or 4.0 W/kg for 10gSAR (i.e., Eq. (3b)).





## 4 Test Configurations

### 4.1 WWAN (sub-6) transmission

The  $P_{limit}$  values, corresponding to SAR\_design\_target, for technologies and bands supported by EUT are derived in Part 0 report and summarized in Table 4-1. Note all  $P_{limit}$  power levels entered in Table 4-1 correspond to average power levels after accounting for duty cycle in the case of TDD modulation schemes (for e.g., GSM, LTE TDD & 5G NR TDD).

**Table 4-1:  $P_{limit}$  for supported technologies and bands ( $P_{limit}$  in EFS file)**

Band	Antenna	Head DSI 2	Body-Worn DSI 3	Hotspot DSI 7	Extremity DSI 6	Sensor off DSI 4	$P_{max}^*$
GSM850	Ant 0	33.6	23.9	23.9	27.0	24.7	24.7
GSM850	Ant 1	21.5	23.4	21.8	24.5	24.5	24.5
GSM1900	Ant 1	14.6	15.1	13.3	17.0	19.7	19.7
GSM1900	Ant 2	32.3	20.7	19.4	21.7	20.7	20.7
WCDMA II	Ant 1	13.7	13.1	11.6	17.4	21.5	21.5
WCDMA II	Ant 2	30.9	20.4	19.0	21.8	22.0	22.0
WCDMA IV	Ant 1	14.3	14.7	13.3	18.9	21.5	21.5
WCDMA IV	Ant 2	32.1	19.1	18.2	21.8	22.0	22.0
WCDMA V	Ant 0	31.7	23.1	23.1	23.0	23.0	23.0
WCDMA V	Ant 1	20	23.0	20.3	23.0	23.0	23.0
LTE Band 2	Ant 1	13.8	12.6	12.2	16.0	21.5	21.5
LTE Band 2	Ant 2	32.1	20.9	19.5	23.0	23.0	23.0
LTE Band 66(4)	Ant 1	15.3	14.7	12.9	18.3	21.5	21.5
LTE Band 66(4)	Ant 2	33.5	20.0	18.9	21.9	23.0	23.0
LTE Band 26(5)	Ant 0	31.1	25.5	25.5	23.0	23.0	23.0
LTE Band 26(5)	Ant 1	20.1	23.7	21.9	23.0	23.0	23.0
LTE Band 7	Ant 0	29.7	21.5	20.9	21.1	21.5	21.5
LTE Band 7	Ant 1	12.7	16.1	12.2	17.6	21.5	21.5
LTE Band 7	Ant 2	31.6	21.1	19.4	20.8	23.0	23.0
LTE Band 7	Ant 10	21.9	18.6	17.0	18.6	18.6	23.0
LTE Band 12(17)	Ant 0	31.2	24.8	24.8	23.0	23.0	23.0
LTE Band 12(17)	Ant 1	21	23.1	22.0	23.0	23.0	23.0
LTE Band 13	Ant 0	30.8	24.8	24.8	23.0	23.0	23.0
LTE Band 13	Ant 1	20.2	23.0	21.8	23.0	23.0	23.0
LTE Band 41(38)	Ant 0	29.6	19.8	16.9	19.5	21.9	20.0
LTE Band 41(38)HPUE	Ant 0	29.6	19.8	16.9	19.5	21.9	21.4
LTE Band 41(38)	Ant 1	12.8	15.4	10.9	17.5	21.9	20.0
LTE Band 41(38)HPUE	Ant 1	12.8	15.4	10.9	17.5	21.9	21.4
LTE Band 41(38)	Ant 2	31	20.5	19.5	20.9	21.9	20.5
LTE Band 41(38)HPUE	Ant 2	31	20.5	19.5	20.9	21.9	21.9
LTE Band 41(38)	Ant 10	20.3	19.0	16.2	19.0	19.0	21.0
LTE Band 41(38)HPUE	Ant 10	20.3	19.0	16.2	19.0	19.0	22.4
LTE Band 42 Part27Q	Ant 7	16.2	17.4	15.6	17.4	21.0	21.0
LTE Band 48(42 43)	Ant 7	16.2	17.4	15.6	17.4	21.0	21.0
FR1 n2	Ant 1	16.5	15.9	13.5	19.6	23.0	23.0
FR1 n2 other PA	Ant 1	16.5	15.9	13.5	19.6	22.0	22.0



FR1 n2	Ant 2	32.2	20.7	19.4	22.1	23.0	23.0
FR1 n2 other PA	Ant 2	32.2	20.7	19.4	22.1	22.0	22.0
FR1 n26(5)	Ant 0	32	25.4	25.4	23.0	23.0	23.0
FR1 n26(5)	Ant 1	22	23.1	22.0	23.0	23.0	23.0
FR1 n7	Ant 1	16	16.4	11.8	19.3	23.0	23.0
FR1 n7 other PA	Ant 1	16	16.4	11.8	19.3	21.5	21.5
FR1 n7	Ant 2	31.8	20.3	19.2	21.2	23.0	23.0
FR1 n66	Ant 1	15.9	15.8	14.0	18.9	23.0	23.0
FR1 n66 other PA	Ant 1	15.9	15.8	14.0	18.9	23.0	23.0
FR1 n66	Ant 2	32.7	20.9	19.2	22.3	23.0	23.0
FR1 n66 other PA	Ant 2	32.7	20.9	19.2	22.3	22.0	22.0
FR1 n41(38)	Ant 0	27.4	19.8	18.6	20.3	21.0	21.0
FR1 n41(38)	Ant 1	13.8	16.3	12.5	19.6	21.5	21.5
FR1 n41(38)	Ant 2	31.6	20.1	18.5	19.8	23.0	23.0
FR1 n41(38)	Ant 10	25.5	23.0	20.3	23.0	23.0	23.0
FR1 n77(78)	Ant 4	18.0	18.0	16.5	23.7	23.0	23.0
FR1 n77(78)HPUE	Ant 4	18.0	18.0	16.5	23.7	23.0	23.0
FR1 n77(78)	Ant 5	14.6	16.8	12.5	18.4	23.0	23.0
FR1 n77(78)HPUE	Ant 5	14.6	16.8	12.5	18.4	23.0	23.0
FR1 n77(78)	Ant 7	16.7	18.5	14.4	18.5	23.0	23.0
FR1 n77(78)HPUE	Ant 7	16.7	18.5	14.4	18.5	23.0	23.0
FR1 n77(78)	Ant 8	29.9	22.3	20.3	22.3	22.3	23.0
FR1 n77(78)HPUE	Ant 8	29.9	22.3	20.3	22.3	22.3	23.0

**Note:**

1. \*Pmax is used for RF tune up procedure. The maximum allowed output power is equal to Pmax +1dB device uncertainty.
2. All P<sub>limit</sub> power levels entered in the Table correspond to average power levels after accounting for duty cycle in the case TDD modulation schemes (for e.g., GSM & LTE TDD & NR TDD).
3. If DSI's P<sub>limit</sub> is higher than Pmax, then P<sub>limit</sub> is operate as Pmax power.
4. The following table is duty cycle and factor used for calculating time average power.

GSM/FDD/TDD	Duty Cycle	Time average calculation factor(dB)
GSM 1TX	12.50%	-9.0
GSM 2TX	25%	-6.0
GSM 3TX	37.50%	-4.3
GSM 4TX	50%	-3.0
FDD LTE	100%	0.0
TDD LTE	63.30%	-2.0
TDD HPUE	43.30%	-3.6
NR FDD/TDD	100%	0.0
NR TDD HPUE	50%	-3.0

**Antenna Group:**

<b>Antenna Group 0 (AG0)</b>	ANT1 & ANT4& ANT5& ANT7& ANT10
<b>Antenna Group 1 (AG1)</b>	ANT0 & ANT2 & ANT8



\*Pmax is used for RF tune up procedure. The maximum allowed output power is equal to Pmax +1dB device uncertainty.

Maximum target power, Pmax, is configured in NV settings in EUT to “limit maximum transmitting power”. This power is converted into “peak power in NV settings for TDD schemes”. The EUT maximum allowed output power is equal to Pmax +1dB device uncertainty. EFS file Plimit level will compare to Pmax, when Plimit is high than Pmax, the power will be limited to Pmax power level.

\*\*All Plimit power levels entered in the Table correspond to average power levels after accounting for duty cycle in the case TDD modulation schemes (for e.g., GSM & LTE TDD & NR TDD).

Based on selection criteria described in Section 3.2.1, the selected technologies/bands for testing time-varying test sequences are listed in Table 4-1.

The radio configurations used in Part 2 test for selected technologies, bands, DSIs and antennas are listed in Table 4-2. The corresponding worst-case radio configuration 1gSAR or 10gSAR values for selected technology/band/DSI are extracted from Part 1 report and are listed in the last column of Table 4-2.

Based on equations (1a) and (3a), it is clear that Part 2 testing outcome is normalized quantity, which implies that it can be applied to any radio configuration within a selected technology/band/DSI. Thus, as long as applying the worst-case SAR obtained from the worst radio configuration in Part 1 testing to calculate time-varying SAR exposure in equations (1a) and (3a), the accuracy in compliance demonstration remains the same.



**Table 4-2: Radio configurations selected for Part 2 test**

Test case #	Test scenario	Tech	Band	Ant	DSI	Channel	Freq (MHz)	BW	RB size	RB offset	mode	position	Position details	Part 1, SAR@Plimit 1g SAR (W/kg)
1	Time-Varying	GSM	850	1	2	189	836.4	-	-	-	GPRS (4 Tx slots)	Left Cheek	0mm	0.671
2		GSM	1900	1	7	661	1880	-	-	-	GPRS (4 Tx slots)	Back	5mm	0.505
3		WCDMA	5	1	7	4182	836.4	-	-	-	RMC 12.2Kbps	Back	5mm	0.470
4		WCDMA	2	1	7	9400	1880	-	-	-	RMC 12.2Kbps	Back	5mm	0.524
5		LTE	2	2	3	18700	1860	20	1	0	QPSK	Front	5mm	1.020
6		LTE	41	1	7	40620	2593	20	1	0	QPSK	Top Side	5mm	0.495
7		5G NR	n66	2	3	349000	1745	40	1	1	DFT-15,QPSK	Front	5mm	0.963
8		5G NR	n7	1	7	507000	2535	40	1	1	DFT-15,QPSK	Top Side	5mm	0.472
9	Call Drop	LTE	41	1	7	40620	2593	20	1	0	QPSK	Top Side	5mm	0.495
10	Tech Switch	LTE	2	1	2	19100	1900	20	1	0	QPSK	Right Tilted	0mm	0.644
		WCDMA	4	1	2	1513	1752.6	-	-	-	RMC 12.2Kbps	Right Tilted	0mm	0.652
11	100s-60s-100s	LTE	66	1	7	132322	1745	20	1	0	QPSK	Back	5mm	0.424
		LTE	48	7	7	56640	3690	20	1	0	QPSK	Left Side	5mm	0.445
12	60s-100s-60s	LTE	48	7	7	56640	3690	20	1	0	QPSK	Left Side	5mm	0.445
		LTE	66	1	7	132322	1745	20	1	0	QPSK	Back	5mm	0.424
13	Exposure Category Switch (Head→Non Head→Head)	LTE	41	1	2	41055	2636.5	20	1	0	QPSK	Right Tilted	0mm	0.702
		LTE	41	1	3	40620	2593	20	1	0	QPSK	Back	5mm	0.684
14	Exposure Category Switch (Non Head→Head→Non Head)	LTE	41	1	3	40620	2593	20	1	0	QPSK	Back	5mm	0.684
		LTE	41	1	2	41055	2636.5	20	1	0	QPSK	Right Tilted	0mm	0.702
15	DSI Switch	LTE	41	1	7	40620	2593	20	1	0	QPSK	Top Side	5mm	0.495
		LTE	41	1	3	40620	2593	20	1	0	QPSK	Back	5mm	0.684
16	EN-DC SAR vs SAR	LTE	5	1	2	20525	836.5	10	1	0	QPSK	Right Cheek	0mm	0.633
		5G NR	n78	7	2	650000	3750	100	135	69	DFT-30,QPSK	Right Cheek	0mm	0.708

Note that the EUT has a several DSI states to manage power for different RF exposure conditions, detail DSI states and trigger conditions shown on the following table, the maximum 1gSAR/or 10gSAR among all exposure scenarios is used in Smart Transmit feature for time averaging operation.



Trigger Conditions:

Exposure conditions	Measure Distance	Trigger Conditions	DSI	SAR design target
Head	touch&tilt 15deg	Receiver on	DSI2	1g SAR design target
Body Worn	5 mm	Sensor On	DSI3	1g SAR design target
Body Worn / Sensor Off	Sensor Trigger Distance -1mm	Receiver off/Sensor Off	DSI4	1g SAR design target
Hotspot	5 mm	Hotspot On	DSI7	1g SAR design target
Extremity	0mm	Sensor On	DSI6	10g SAR design target
Extremity / Sensor Off	Sensor Trigger Distance -1mm	Receiver off/Sensor Off	DSI4	10g SAR design target

SAR design Target:

Exposure conditions	Measure Distance	SAR (W/kg) WWAN 2/3/4/5G AG1	SAR (W/kg) WWAN 2/3/4/5G AG0
Body Worn (1g)	5 mm	1.03	0.71
Hotspot (1g)	5 mm	1.03	0.50
Head (1g)	touch&tilt 15deg	1.03	0.71
Extremity (10g)	0 mm	2.55	1.98

Based on the selection criteria described in Section 3.2, the radio configurations for the Tx varying transmission test cases listed in Section 2 are:

1. Technologies and bands for time-varying Tx power transmission: The test case 1~8 listed in Table 4-2 are selected to test with the test sequences defined in Section 3.1 in both time-varying conducted power measurement and time-varying SAR measurement.
2. Technology and band for change in call test: The test case 9 listed in Table 4-2 are selected for performing the call drop test in conducted power setup. LTE Band 41, Ant 1, DSI = 7 having the lowest  $P_{limit}$  among all technologies and bands
3. Technologies and bands for change in technology/band test: The test case 10 listed in Table 4-2 is selected for handover test from a technology/band (LTE Band 2, DSI = 2, Ant 1) to another technology/band (WCDMA Band 4, DSI = 2, Ant 1), in conducted power setup.
4. Technologies and bands for change in DSI: The test case 15 listed in Table 4-2 is selected for DSI switch test by establishing a call in LTE Band 41 in DSI = 7, and then handing over to DSI = 3 exposure scenario in conducted power setup.
5. Technologies and bands for change in time-window/antenna: The test case 11~12 listed in Table 4-2 is selected for time window switch between 60s window (LTE Band 48, Ant 7) and 100s window (LTE Band 66, Ant 1) in conducted power setup. LTE Band 48 is using different antenna from LTE Band 66, so this test also address the antenna change.
6. Technologies and bands for switch in SAR exposure: The test case 16 listed in Table 4-2 are selected for SAR exposure switching test in one of the supported simultaneous WWAN transmission scenario, i.e., LTE (LTE Band 5) + 5G NR (5G NR FR1 n78) active in the same 100s time window, in conducted power setup.
7. Exposure Category Switch: The test case 13~14 listed in Table 4-2 is selected for head to non-head to head exposure switch test for LTE Band 41, so this purpose, there are two tests performed: (a) start with head exposure and switch to non-head exposure and switch back to head exposure, and (b) start with non-head exposure and switch to head exposure and switch back to non-head exposure.



## 5 Conducted Power Test Results for Sub-6 Smart Transmit Feature Validation

---

### 5.1 Measurement setup

The Rohde & Schwarz CMW500 callbox is used in this test. The test setup schematic are shown in Figures 5-1. For single antenna measurement, one port (RF1 COM) of the callbox is connected to the RF port of the EUT using a directional coupler. For antenna & technology switch measurement, two ports (RF1 COM and RF3 COM) of the callbox used for signaling two different technologies are connected to a combiner, which is in turn connected to a directional coupler. The other end of the directional coupler is connected to a splitter to connect to two RF ports of the EUT corresponding to the two antennas of interest. In both the setups, power meter is used to tap the directional coupler for measuring the conducted output power of the EUT. For time averaging validation test (Section 3.3.1), call drop test (Section 3.3.2), and DSI switch test (Section 3.3.4), only RF1 COM port of the callbox is used to communicate with the EUT. For technology/band switch measurement (Section. 3.3.3), both RF1 COM and RF3 COM port of callbox are used to switch from one technology communicating on RF1 COM port to another technology communicating on RF3 COM port. All the path losses from RF port of EUT to the callbox RF COM port and to the power meter are calibrated and automatically entered as offsets in the callbox and the power meter via test scripts on the PC used to control callbox and power meter.

#### Sub6 NR test setup:

The Keysight UXM E7515B callbox is used in this test. The test setup schematic are shown in Figures 5-1. For single antenna measurement, one port (RF1 COM) of the callbox is connected to the RF port of the EUT using a directional coupler.

#### LTE+5G NR test setup:

The Keysight UXM E7515B callbox is used in this test. If LTE conducted port and 5G NR conducted port are same on this EUT (i.e., they share the same antenna), therefore, low-/high-pass filter are used to separate LTE and 5G NR signals for power meter measurement via directional couplers, as shown in below Figure 5-1 C (Appendix E – Test Setup Photo ).

All the path losses from RF port of DUT to the callbox RF COM port and to the power meter are calibrated and automatically entered as offsets in the callbox and the power meter via test scripts on the PC used to control callbox and power meter.

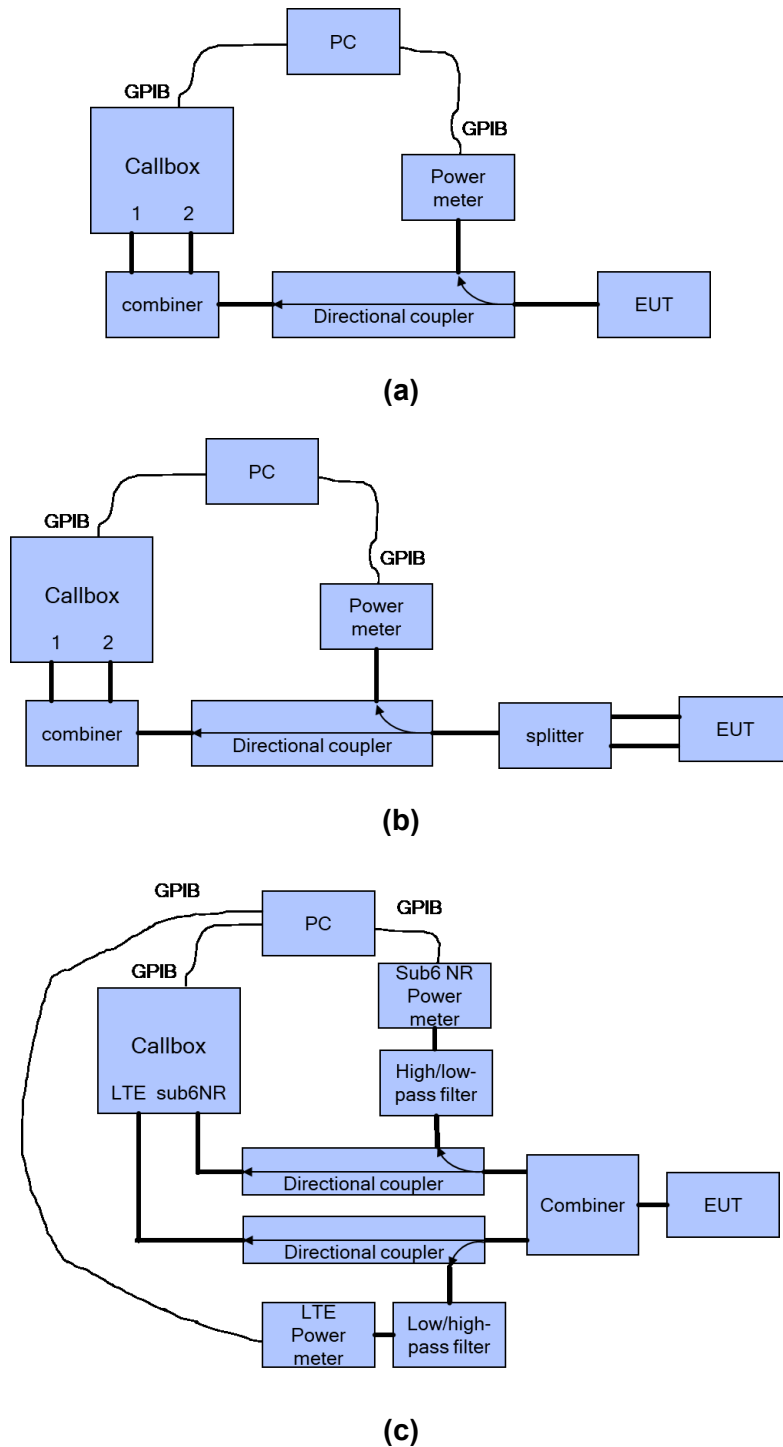

**Figure 5-1 Conducted power measurement setup**

Both the callbox and power meter are connected to the PC using GPIB cables. Two test scripts are custom made for automation, and the test duration set in the test scripts is 500 seconds.



For time-varying Tx power measurement, the PC runs the 1<sup>st</sup> test script to send GPIB commands to control the callbox's requested power versus time, while at the same time to record the conducted power measured at EUT RF port using the power meter. The commands sent to the callbox to request power are:

- 0dBm for 100 seconds
- test sequence 1 or test sequence 2 (defined in Section 3.1 and generated in Section 3.2.1), for 360 seconds
- stay at the last power level of test sequence 1 or test sequence 2 for the remaining time.

Power meter readings are periodically recorded every 100ms. A running average of this measured Tx power over 100 seconds is performed in the post-data processing to determine the 100s-time averaged power.

For call drop, technology/band/antenna switch, and DSI switch tests, after the call is established, the callbox is set to request the EUT's Tx power at 0dBm for 100 seconds while simultaneously starting the 2<sup>nd</sup> test script runs at the same time to start recording the Tx power measured at EUT RF port using the power meter. After the initial 100 seconds since starting the Tx power recording, the callbox is set to request maximum power from the EUT for the rest of the test. Note that the call drop/re-establish, or technology/band/antenna switch or DSI switch is manually performed when the Tx power of EUT is at  $P_{reserve}$  level. See Section 3.3 for detailed test procedure of call drop test, technology/band/antenna switch test and DSI switch test.

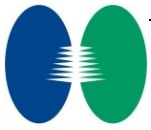

### 5.2 $P_{limit}$ and $P_{max}$ measurement results

The measured  $P_{limit}$  for all the selected radio configurations given in Table 4-2 are listed in below Table 5-1.  $P_{max}$  was also measured for radio configurations selected for testing time-varying Tx power transmission scenarios in order to generate test sequences following the test procedures in Section 3.1.

**Table 5-1: Measured  $P_{limit}$  and  $P_{max}$  of selected radio configurations**

Test case #	Test scenario	Tech	Band	Ant	DSI	Channel	Freq (MHz)	BW	RB size	RB offset	mode	position	Position details	Plimit EFS setting(dBm)	Target Pmax (dBm)	Measured Plimit (dBm)	Measured Pmax (dBm)
1	Time-Varying	GSM	850	1	2	189	836.4	-	-	-	GPRS (4 Tx slots)	Left Cheek	0mm	21.5	24.5	22.5	23.5
2		GSM	1900	1	7	661	1880	-	-	-	GPRS (4 Tx slots)	Back	5mm	13.3	19.7	14.3	18.7
3		WCDMA	5	1	7	4182	836.4	-	-	-	RMC 12.2Kbps	Back	5mm	20.3	23	20	22
4		WCDMA	2	1	7	9400	1880	-	-	-	RMC 12.2Kbps	Back	5mm	11.6	21.5	11.2	20.8
5		LTE	2	2	3	18700	1860	20	1	0	QPSK	Front	5mm	20.9	23	20.1	22.1
6		LTE	41	1	7	40620	2593	20	1	0	QPSK	Top Side	5mm	10.9	20	11.9	19.8
7		5G NR	n66	2	3	349000	1745	40	1	1	DFT-15,QPSK	Front	5mm	20.9	23	20.2	22.2
8		5G NR	n7	1	7	507000	2535	40	1	1	DFT-15,QPSK	Top Side	5mm	11.8	23	11.1	22.3
9	Call Drop	LTE	41	1	7	40620	2593	20	1	0	QPSK	Top Side	5mm	10.9	20	11.9	19.8
10	Tech Switch	LTE	2	1	2	19100	1900	20	1	0	QPSK	Right Tilted	0mm	13.8	21.5	12.9	20.5
		WCDMA	4	1	2	1513	1752.6	-	-	-	RMC 12.2Kbps	Right Tilted	0mm	14.3	21.5	13.8	20.8
11	100s-60s-100s	LTE	66	1	7	132322	1745	20	1	0	QPSK	Back	5mm	12.9	21.5	12.7	20.8
		LTE	48	7	7	56640	3690	20	1	0	QPSK	Left Side	5mm	15.6	21	14.6	20
12	60s-100s-60s	LTE	48	7	7	56640	3690	20	1	0	QPSK	Left Side	5mm	15.6	21	14.6	20
		LTE	66	1	7	132322	1745	20	1	0	QPSK	Back	5mm	12.9	21.5	12.7	20.8
13	Exposure Category Switch (Head→Non Head→Head)	LTE	41	1	2	41055	2636.5	20	1	0	QPSK	Right Tilted	0mm	12.8	20	13.8	19.8
		LTE	41	1	3	40620	2593	20	1	0	QPSK	Back	5mm	15.4	20	16.4	19.8
14	Exposure Category Switch (Non Head→Head→Non Head)	LTE	41	1	3	40620	2593	20	1	0	QPSK	Back	5mm	15.4	20	16.4	19.8
		LTE	41	1	2	41055	2636.5	20	1	0	QPSK	Right Tilted	0mm	12.8	20	13.8	19.8
15	DSI Switch	LTE	41	1	7	40620	2593	20	1	0	QPSK	Top Side	5mm	10.9	20	11.9	19.8
		LTE	41	1	3	40620	2593	20	1	0	QPSK	Back	5mm	15.4	20	16.4	19.8
16	EN-DC SAR vs SAR	LTE	5	1	2	20525	836.5	10	1	0	QPSK	Right Cheek	0mm	20.1	23	21.1	22.7
		5G NR	n78	7	2	650000	3750	100	135	69	DFT-30,QPSK	Right Cheek	0mm	16.7	23	17.3	22.2

**5.3 Time-varying Tx power measurement results**

The measurement setup is shown in Figures 5-1(a) and 5-1(c). The purpose of the time-varying Tx power measurement is to demonstrate the effectiveness of power limiting enforcement and that the time-averaged Tx power when represented in time-averaged 1gSAR or 10gSAR values does not exceed FCC limit as shown in Eq. (1a) and (1b), rewritten below:

$$1g\_or\_10gSAR(t) = \frac{conducted\_Tx\_power(t)}{conducted\_Tx\_power\_P_{limit}} * 1g\_or\_10gSAR\_P_{limit} \quad (1a)$$

$$\frac{\frac{1}{T_{SAR}} \int_{t-T_{SAR}}^t 1g\_or\_10gSAR(t) dt}{FCC\ SAR\ limit} \leq 1 \quad (1b)$$

where, *conducted\_Tx\_power(t)*, *conducted\_Tx\_power\_P<sub>limit</sub>*, and *1g\_or\_10gSAR\_P<sub>limit</sub>* correspond to the measured instantaneous conducted Tx power, measured conducted Tx power at *P<sub>limit</sub>*, and measured 1gSAR and 10gSAR values at *P<sub>limit</sub>* reported in Part 1 test (listed in Table 4-2 of this report as well).

Following the test procedure in Section 3.3, the conducted Tx power measurement for all selected configurations are reported in this section. In all the conducted Tx power plots, the dotted line represents the requested power by callbox (test sequence 1 or test sequence 2), the blue curve represents the instantaneous conducted Tx power measured using power meter, the green curve represents time-averaged power and red line represents the conducted power limit that corresponds to FCC limit of 1.6 W/kg for 1gSAR or 4.0 W/kg for 10gSAR.

Similarly, in all the 1g or 10gSAR plots (when converted using Eq. (1a)), the green curve represents the 100s/60s-time averaged 1gSAR or 10gSAR value calculated based on instantaneous 1gSAR or 10gSAR; and the red line limit represents the FCC limit of 1.6 W/kg for 1gSAR or 4.0 W/kg for 10gSAR.

The power limiting enforcement is effective in all the tests, and the time-averaged 1gSAR does not exceed the SAR design target + device uncertainty for all the tested technologies/bands. Therefore, Qualcomm Smart Transmit time averaging feature is validated.



5.3.1 GSM850

Test result for test sequence 1:

Above time-averaged conducted Tx power is converted/calculated into time-averaged 1gSAR using Equation (1a) and plotted below to demonstrate that the time-averaged 1gSAR versus time does not exceed the FCC limit of 1.6 W/kg for 1gSAR:

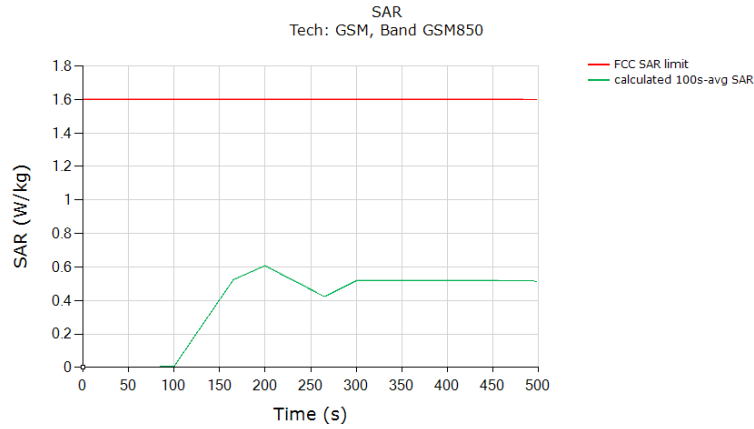

	(W/kg)
FCC 1gSAR limit	1.6
Max 100s-time averaged 1gSAR (green curve)	0.606
<b>Validated:</b> Max time averaged SAR (green curve) does not exceed measured SAR at Plimit +1dB device uncertainty	

Test result for test sequence 2:

Above time-averaged conducted Tx power is converted/calculated into time-averaged 1gSAR using Equation (1a) and plotted below to demonstrate that the time-averaged 1gSAR versus time does not exceed the FCC limit of 1.6W/kg for 1gSAR:

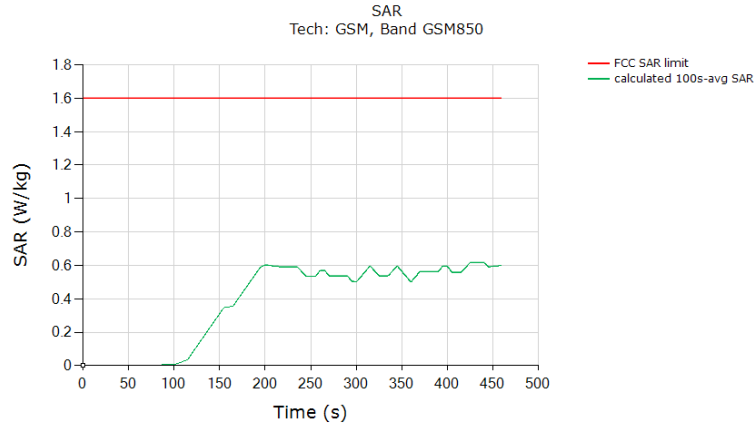

	(W/kg)
FCC 1gSAR limit	1.6
Max 100s-time averaged 1gSAR (green curve)	0.616
<b>Validated:</b> Max time averaged SAR (green curve) does not exceed measured SAR at Plimit +1dB device uncertainty	



### 5.3.2 GSM1900

#### Test result for test sequence 1:

Above time-averaged conducted Tx power is converted/calculated into time-averaged 1gSAR using Equation (1a) and plotted below to demonstrate that the time-averaged 1gSAR versus time does not exceed the FCC limit of 1.6 W/kg for 1gSAR:

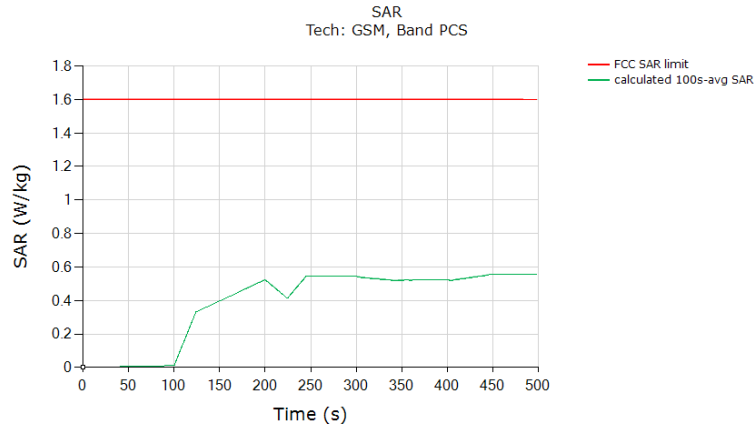

	(W/kg)
FCC 1gSAR limit	1.6
Max 100s-time averaged 1gSAR (green curve)	0.555
<b>Validated:</b> Max time averaged SAR (green curve) does not exceed measured SAR at Plimit +1dB device uncertainty	

Test result for test sequence 2:

Above time-averaged conducted Tx power is converted/calculated into time-averaged 1gSAR using Equation (1a) and plotted below to demonstrate that the time-averaged 1gSAR versus time does not exceed the FCC limit of 1.6W/kg for 1gSAR:

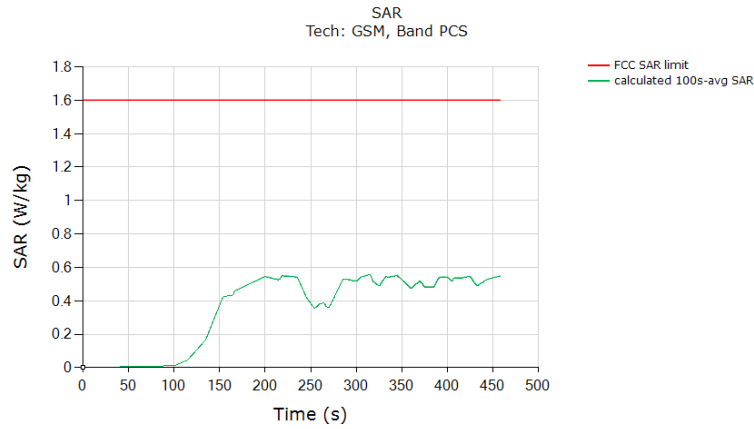

	(W/kg)
FCC 1gSAR limit	1.6
Max 100s-time averaged 1gSAR (green curve)	0.556
<b>Validated:</b> Max time averaged SAR (green curve) does not exceed measured SAR at Plimit +1dB device uncertainty	



5.3.3 WCDMA Band 5

Test result for test sequence 1:

Above time-averaged conducted Tx power is converted/calculated into time-averaged 1gSAR using Equation (1a) and plotted below to demonstrate that the time-averaged 1gSAR versus time does not exceed the FCC limit of 1.6 W/kg for 1gSAR:

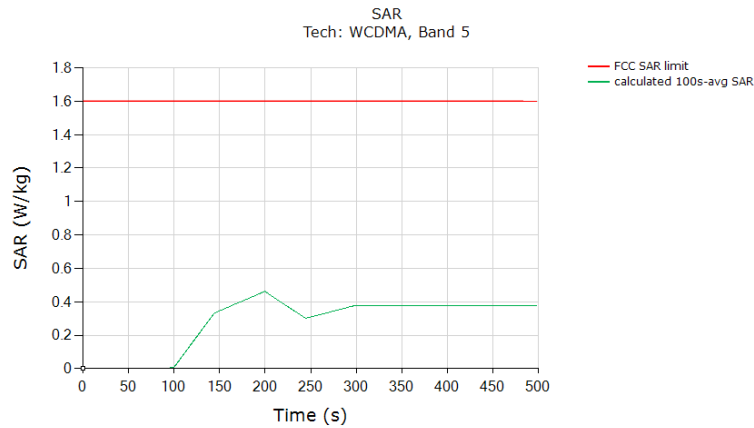

	(W/kg)
FCC 1gSAR limit	1.6
Max 100s-time averaged 1gSAR (green curve)	0.461
Validated: Max time averaged SAR (green curve) does not exceed measured SAR at Plimit +1dB device uncertainty	



Test result for test sequence 2:

Above time-averaged conducted Tx power is converted/calculated into time-averaged 1gSAR using Equation (1a) and plotted below to demonstrate that the time-averaged 1gSAR versus time does not exceed the FCC limit of 1.6 W/kg for 1gSAR:

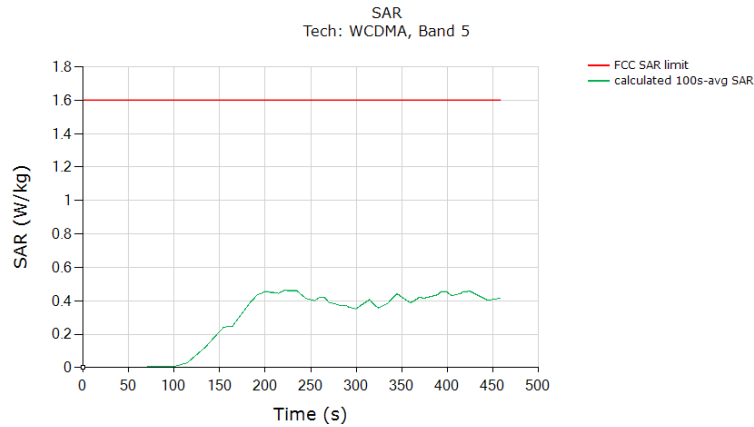

	(W/kg)
FCC 1gSAR limit	1.6
Max 100s-time averaged 1gSAR (green curve)	0.461
<b>Validated:</b> Max time averaged SAR (green curve) does not exceed measured SAR at Plimit +1dB device uncertainty	



**5.3.4 WCDMA Band 2**

Test result for test sequence 1:

Above time-averaged conducted Tx power is converted/calculated into time-averaged 1gSAR using Equation (1a) and plotted below to demonstrate that the time-averaged 1gSAR versus time does not exceed the FCC limit of 1.6 W/kg for 1gSAR:

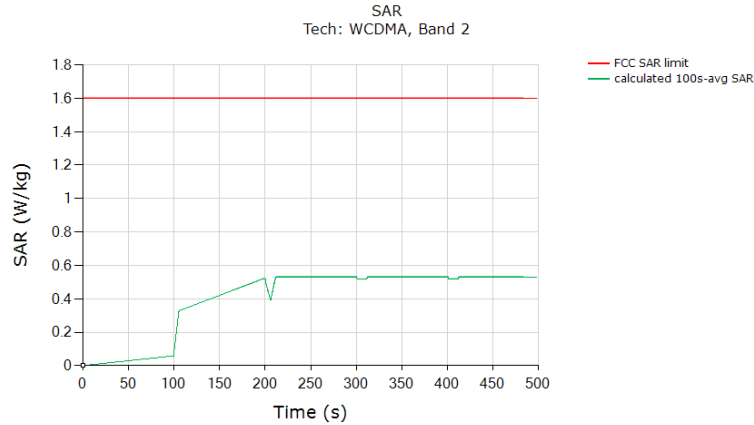

	(W/kg)
FCC 1gSAR limit	1.6
Max 100s-time averaged 1gSAR (green curve)	0.531
<b>Validated:</b> Max time averaged SAR (green curve) does not exceed measured SAR at P <sub>limit</sub> +1dB device uncertainty	

Test result for test sequence 2:

Above time-averaged conducted Tx power is converted/calculated into time-averaged 1gSAR using Equation (1a) and plotted below to demonstrate that the time-averaged 1gSAR versus time does not exceed the FCC limit of 1.6 W/kg for 1gSAR:

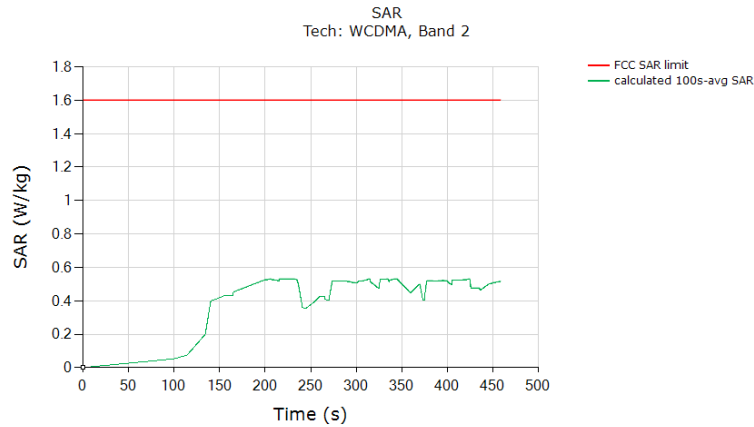

	(W/kg)
FCC 1gSAR limit	1.6
Max 100s-time averaged 1gSAR (green curve)	0.530
<b>Validated:</b> Max time averaged SAR (green curve) does not exceed measured SAR at Plimit +1dB device uncertainty	



**5.3.5 LTE Band 2**

Test result for test sequence 1:

Above time-averaged conducted Tx power is converted/calculated into time-averaged 1gSAR using Equation (1a) and plotted below to demonstrate that the time-averaged 1gSAR versus time does not exceed the FCC limit of 1.6 W/kg for 1gSAR:

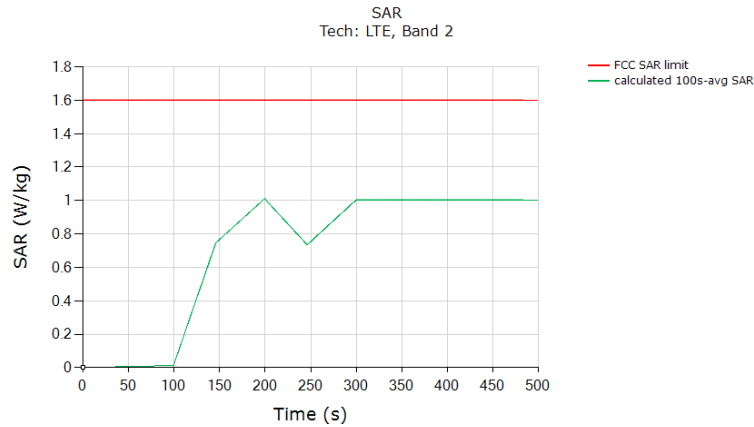

	(W/kg)
FCC 1gSAR limit	1.6
Max 100s-time averaged 1gSAR (green curve)	1.009
<b>Validated:</b> Max time averaged SAR (green curve) does not exceed measured SAR at P <sub>limit</sub> +1dB device uncertainty	

Test result for test sequence 2:

Above time-averaged conducted Tx power is converted/calculated into time-averaged 1gSAR using Equation (1a) and plotted below to demonstrate that the time-averaged 1gSAR versus time does not exceed the FCC limit of 1.6 W/kg for 1gSAR:

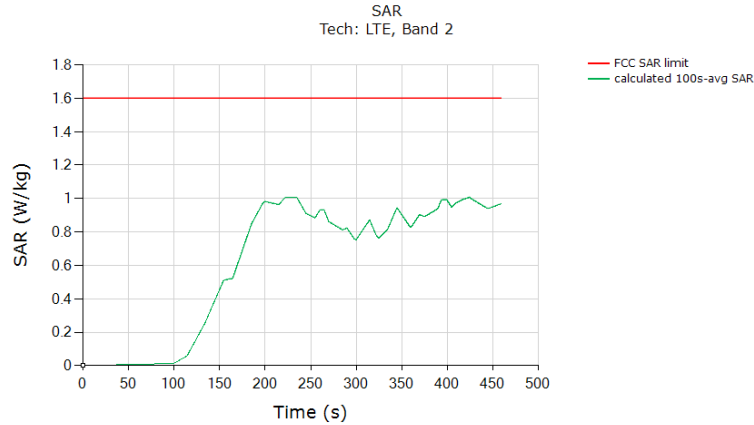

	(W/kg)
FCC 1gSAR limit	1.6
Max 100s-time averaged 1gSAR (green curve)	1.007
<b>Validated:</b> Max time averaged SAR (green curve) does not exceed measured SAR at Plimit +1dB device uncertainty	



5.3.6 LTE Band 41

Test result for test sequence 1:

Above time-averaged conducted Tx power is converted/calculated into time-averaged 1gSAR using Equation (1a) and plotted below to demonstrate that the time-averaged 1gSAR versus time does not exceed the FCC limit of 1.6 W/kg for 1gSAR:

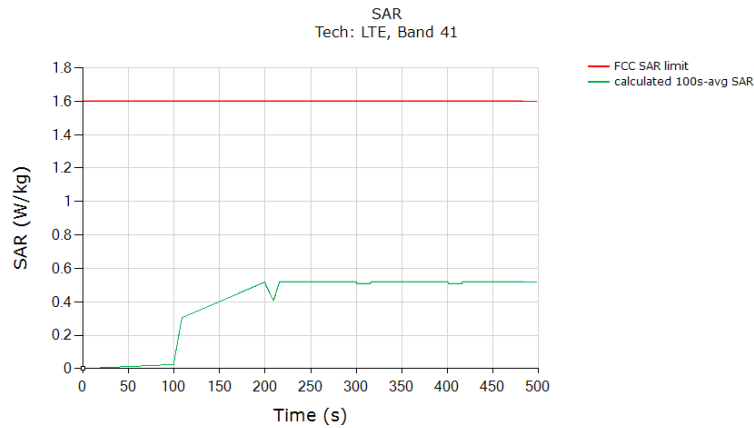

	(W/kg)
FCC 1gSAR limit	1.6
Max 100s-time averaged 1gSAR (green curve)	0.518
<b>Validated:</b> Max time averaged SAR (green curve) does not exceed measured SAR at Plimit +1dB device uncertainty	

Test result for test sequence 2:

Above time-averaged conducted Tx power is converted/calculated into time-averaged 1gSAR using Equation (1a) and plotted below to demonstrate that the time-averaged 1gSAR versus time does not exceed the FCC limit of 1.6 W/kg for 1gSAR:

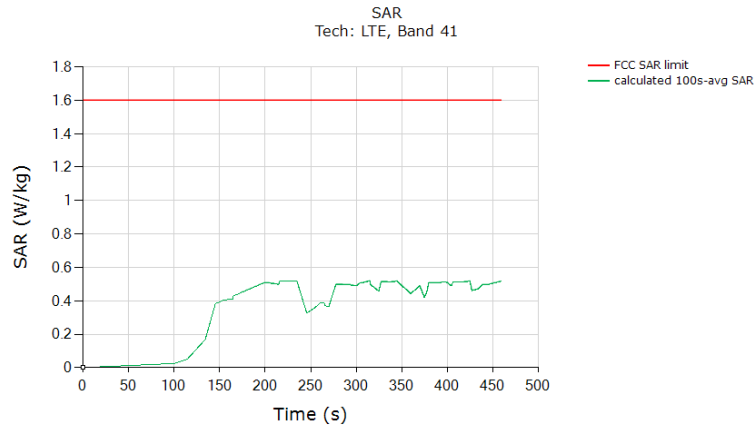

	(W/kg)
FCC 1gSAR limit	1.6
Max 100s-time averaged 1gSAR (green curve)	0.518
<b>Validated:</b> Max time averaged SAR (green curve) does not exceed measured SAR at Plimit +1dB device uncertainty	



**5.3.7 5GNR FR1 n66**

Test result for test sequence 1:

Above time-averaged conducted Tx power is converted/calculated into time-averaged 1gSAR using Equation (1a) and plotted below to demonstrate that the time-averaged 1gSAR versus time does not exceed the FCC limit of 1.6 W/kg for 1gSAR:

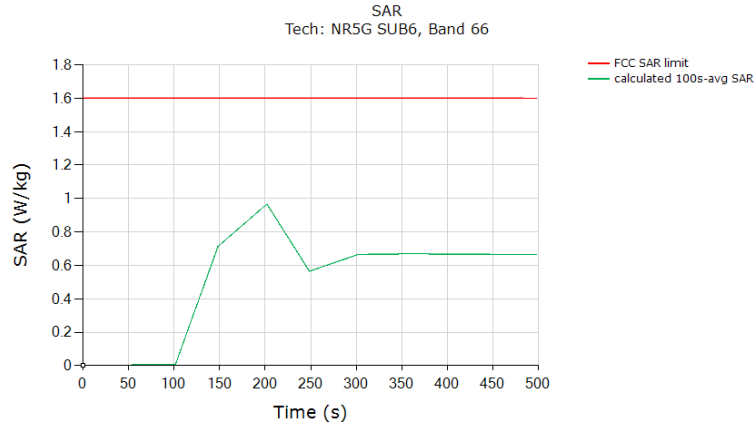

	(W/kg)
FCC 1gSAR limit	1.6
Max 100s-time averaged 1gSAR (green curve)	0.965
<b>Validated:</b> Max time averaged SAR (green curve) does not exceed measured SAR at Plimit +1dB device uncertainty	



Test result for test sequence 2:

Above time-averaged conducted Tx power is converted/calculated into time-averaged 1gSAR using Equation (1a) and plotted below to demonstrate that the time-averaged 1gSAR versus time does not exceed the FCC limit of 1.6 W/kg for 1gSAR:

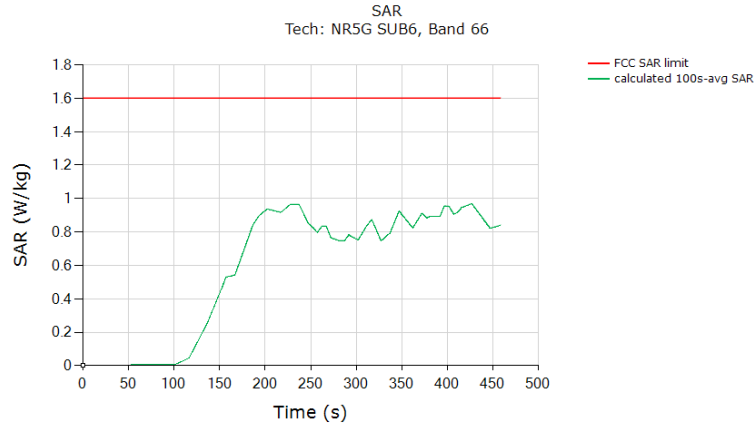

	(W/kg)
FCC 1gSAR limit	1.6
Max 100s-time averaged 1gSAR (green curve)	0.968
<b>Validated:</b> Max time averaged SAR (green curve) does not exceed measured SAR at Plimit +1dB device uncertainty	



### 5.3.8 5GNR FR1 n7

#### Test result for test sequence 1:

Above time-averaged conducted Tx power is converted/calculated into time-averaged 1gSAR using Equation (1a) and plotted below to demonstrate that the time-averaged 1gSAR versus time does not exceed the FCC limit of 1.6 W/kg for 1gSAR:

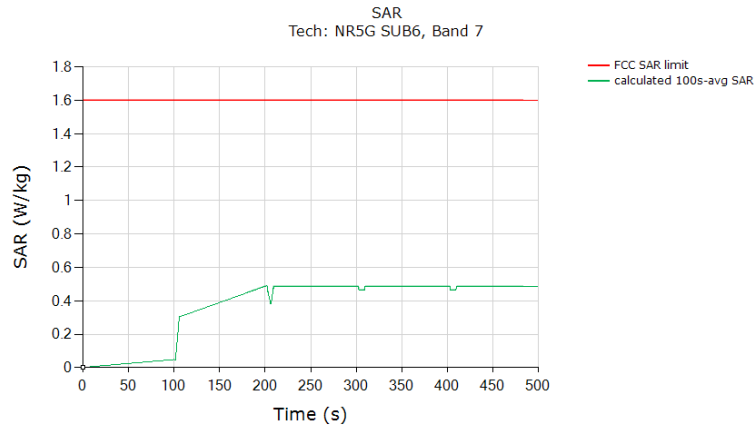

	(W/kg)
FCC 1gSAR limit	1.6
Max 100s-time averaged 1gSAR (green curve)	0.489
<b>Validated:</b> Max time averaged SAR (green curve) does not exceed measured SAR at Plimit +1dB device uncertainty	

Test result for test sequence 2:

Above time-averaged conducted Tx power is converted/calculated into time-averaged 1gSAR using Equation (1a) and plotted below to demonstrate that the time-averaged 1gSAR versus time does not exceed the FCC limit of 1.6 W/kg for 1gSAR:

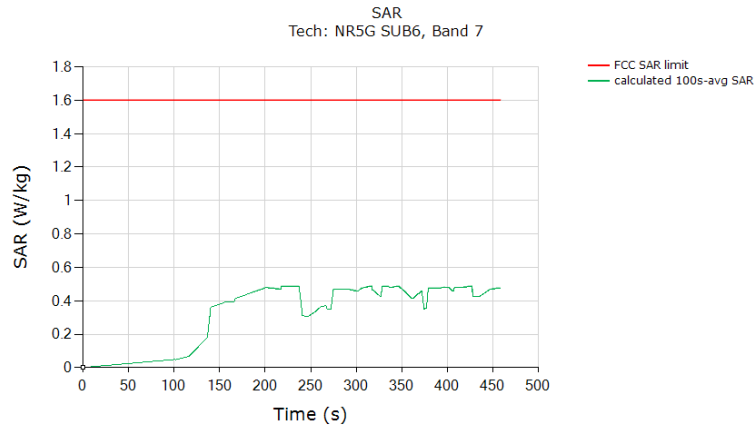

	(W/kg)
FCC 1gSAR limit	1.6
Max 100s-time averaged 1gSAR (green curve)	0.488
<b>Validated:</b> Max time averaged SAR (green curve) does not exceed measured SAR at Plimit +1dB device uncertainty	

**5.4 Change in Call Test Results**

This test was measured with LTE Band 41, Ant 1, DSI = 7, and with callbox requesting maximum power. The call drop was manually performed when the EUT is transmitting at  $P_{reserve}$  level as shown in the plot below (dotted black region). The measurement setup is shown in Figure 5-1. The detailed test procedure is described in Section 3.3.2.

Call drop test result:

Above time-averaged conducted Tx power is converted/calculated into time-averaged 1gSAR using Equation (1a) and plotted below to demonstrate that the time-averaged 1gSAR versus time does not exceed the FCC limit of 1.6 W/kg for 1gSAR:

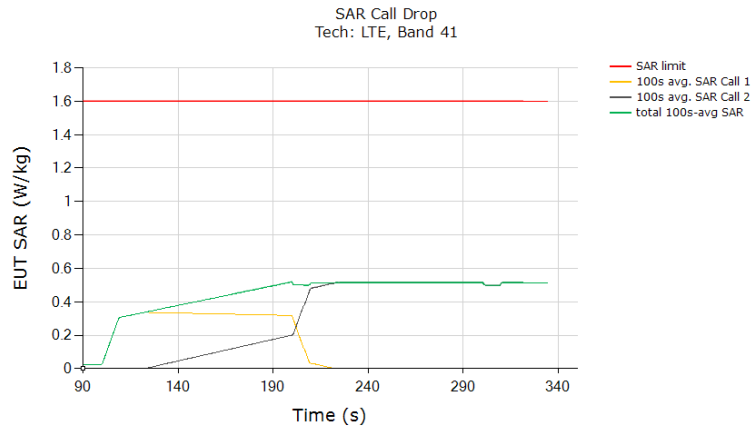

	(W/kg)
FCC 1gSAR limit	1.6
Max 100s-time averaged 1gSAR (green curve)	0.517
<b>Validated</b>	

The test result validated the continuity of power limiting in Change in Call scenario.

### 5.5 Change in technology/band test results

This test was conducted with callbox requesting maximum power, and with technology switch from LTE Band 2, DSI = 2, Ant 1 to WCDMA Band 4, DSI = 2, Ant 1. Following procedure detailed in Section 3.3.3, and using the measurement setup shown in Figure 5-1(a) and (c), the technology/band switch was performed when the EUT is transmitting at  $P_{reserve}$  level as shown in the plot below (dotted black region).

Test result for change in technology/band:

All the time-averaged conducted Tx power measurement results were converted into time-averaged normalized SAR values using Equation (6a), (6b) and (6c), and plotted below to demonstrate that the normalized time-averaged RF exposure does not exceed the FCC limit of 1.0:

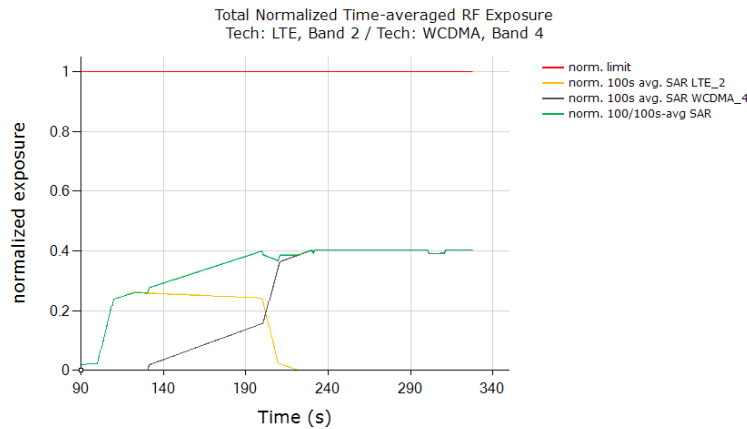

	Exposure Ratio
FCC normalized Exposure Ratio limit	1.0
Max 100s-time averaged normalized Exposure Ratio (green curve)	0.403
<b>Validated</b>	

The test result validated the continuity of power limiting in technology/band switch scenario.



### 5.6 Change in DSI test results

This test was conducted with callbox requesting maximum power, and with DSI switch from LTE Band 41 DSI = 7 to DSI = 3. Following procedure detailed in Section 3.3.5 using the measurement setup shown in Figure 5-1(a) and (c), the DSI switch was performed when the EUT is transmitting at  $P_{reserve}$  level as shown in the plot below (dotted black circle).

#### Test result for change in DSI:

All the time-averaged conducted Tx power measurement results were converted into time-averaged normalized SAR values using Equation (6a), (6b) and (6c), and plotted below to demonstrate that the normalized time-averaged RF exposure does not exceed the FCC limit of 1.0:

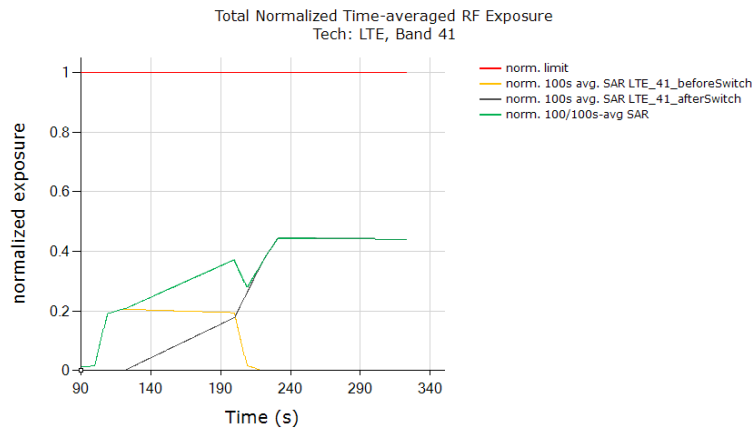

	Exposure Ratio
FCC normalized Exposure Ratio limit	1.0
Max 100s-time averaged normalized Exposure Ratio (green curve)	0.444
<b>Validated</b>	

The test result validated the continuity of power limiting in DSI switch scenario.



### 5.7 Change in Time window / antenna switch test results

#### 5.7.1 Test case 1: transition from LTE Band 66 to LTE Band 48 (i.e., 100s to 60s), then back to LTE Band 66

Test result for change in time-window (from 100s to 60s to 100s):

All the conducted Tx power measurement results were converted into time-averaged normalized SAR values using Equation (7a), (7b) and (7c), and plotted below to demonstrate that the normalized time-averaged RF exposure does not exceed the FCC limit of 1.0. Equation (7a) is used to convert the Tx power of device to obtain 100s-averaged normalized SAR in LTE Band 66 as shown in black curve. Similarly, equation (7b) is used to obtain 60s-averaged normalized SAR in LTE Band 48 as shown in orange curve. Equation (7c) is used to obtain total time-averaged normalized SAR as shown in green curve (i.e., sum of black and orange curves).

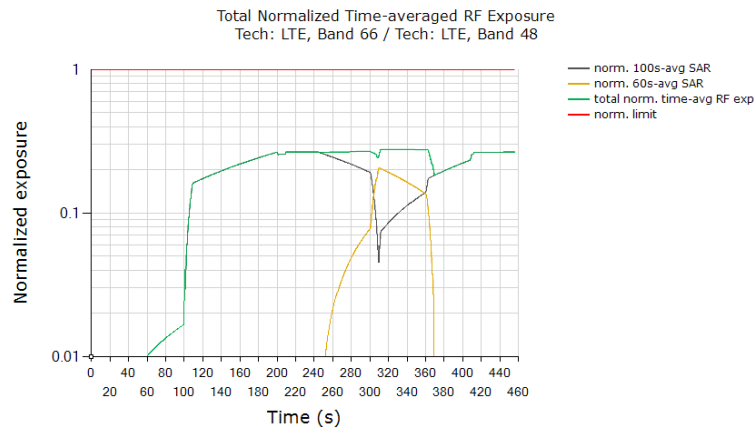

	Exposure Ratio
FCC normalized Exposure Ratio	1.0
Max time averaged normalized Exposure Ratio (green curve)	0.277
<b>Validated</b>	

**Plot Notes:**

Maximum power is requested by callbox for the entire duration of the test, with tech/band switches from 100s-to-60s window at ~245s time stamp, and from 60s-to-100s window at ~310s time stamp. Smart Transmit controls the Tx power during these time-window switches to ensure total time-averaged RF exposure, i.e., sum of black and orange curves given by equation (7c), is always compliant. In time-window switch test, at all times the total time averaged normalized RF exposure (green curve) should not exceed normalized SAR\_design\_target +1dB device uncertainty. In this test, with a maximum normalized SAR of 0.277 being  $\leq 0.56 (=0.71/1.6 +1\text{dB device uncertainty})$ , the above test result validated the continuity of power limiting in time-window switch scenario.

**5.7.2 Test case 2: transition from LTE Band 48 to LTE Band 66 (i.e., 60s to 100s), then back to LTE Band 48**

Test result for change in time-window (from 60s to 100s to 60s):

All the conducted Tx power measurement results were converted into time-averaged normalized SAR values using Equation (7a), (7b) and (7c), and plotted below to demonstrate that the normalized time-averaged RF exposure does not exceed the FCC limit of 1.0. Equation (7a) is used to convert the Tx power of device to obtain 60s-averaged normalized SAR in LTE Band 48 as shown in black curve. Similarly, equation (7b) is used to obtain 100s-averaged normalized SAR in LTE Band 66 as shown in orange curve. Equation (7c) is used to obtain total time-averaged normalized SAR as shown in green curve (i.e., sum of black and orange curves).

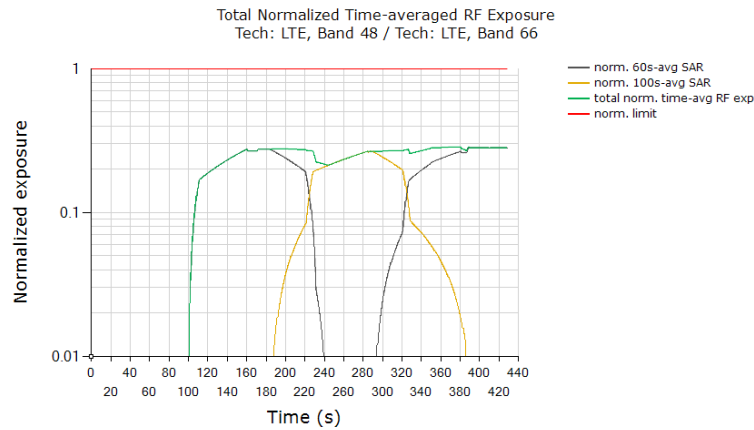

	Exposure Ratio
FCC normalized Exposure Ratio limit	1.0
Max time averaged normalized Exposure Ratio (green curve)	0.286
<b>Validated</b>	

**Plot Notes:**

Maximum power is requested by callbox for the entire duration of the test, with tech/band switches from 60s-to-100s window at ~185s time stamp, and from 100s-to-60s window at ~290s time stamp. Smart Transmit controls the Tx power during these time-window switches to ensure total time-averaged RF exposure, i.e., sum of black and orange curves given by equation (7c), is always compliant. In time-window switch test, at all times the total time averaged normalized RF exposure (green curve) should not exceed normalized SAR\_design\_target +1dB device uncertainty. In this test, with a maximum normalized SAR of 0.286 being  $\leq 0.56 (=0.71/1.6 +1\text{dB device uncertainty})$ , the above test result validated the continuity of power limiting in time-window switch scenario.





### 5.8 Switch in SAR exposure test results (EN-DC Combination)

This test was conducted with callbox requesting maximum power, and with the EUT in LTE Band 5 + 5G NR FR1 n78. Following procedure detailed in Section 3.3.7 and Appendix B.2, and using the measurement setup shown in Figure 5-1, the SAR exposure switch measurement is performed with the EUT in various SAR exposure scenarios.

All the conducted Tx power measurement results were converted into time-averaged normalized SAR values using Equation (7a), (7b) and (7c), and plotted below to demonstrate that the normalized time-averaged RF exposure does not exceed the FCC limit of 1.0. Equation (7a) is used to convert the LTE Tx power of device to obtain 100s-averaged normalized SAR in LTE Band 5 as shown in black curve. Similarly, equation (7b) is used to obtain 60s-averaged normalized SAR in 5G NR FR1 n78 as shown in orange curve. Equation (7c) is used to obtain total time-averaged normalized SAR as shown in green curve (i.e., sum of black and orange curves).

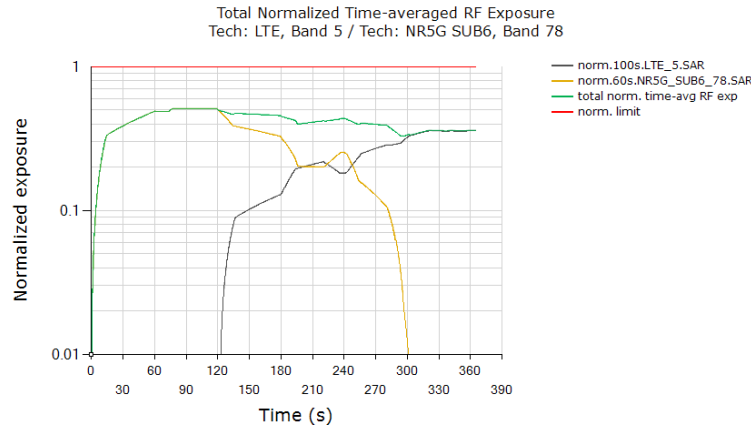

	Exposure Ratio
FCC normalized Exposure Ratio limit	1.0
Max time averaged normalized Exposure Ratio (green curve)	0.511
Validated	

**Plot Notes:**

Device starts predominantly in 5G NR SAR exposure scenario between 0s and 120s, and in LTE SAR + 5G NR SAR exposure scenario between 120s and 240s, and in predominantly in LTE SAR exposure scenario after t=240s. Here, Smart Transmit allocates a maximum of 100% of exposure margin (based on reserve margin setting) for 5G NR. This corresponds to a normalized 1gSAR exposure value = 0.708W/kg measured SAR at 5G NR Plimit /1.6W/kg limit = 0.443+ “+1dB ~ -1dB -1dB” device related uncertainty (see orange curve between 0s~120s). For predominantly LTE SAR exposure scenario, maximum normalized 1gSAR exposure should correspond to 100% exposure margin = 0.633W/kg measured SAR at LTE Plimit /1.6W/kg limit = 0.396+ “+1dB ~ -1dB” device related uncertainty (see black curve after t = 240s). Additionally, in SAR exposure switch test, at all times the total time-averaged normalized RF exposure (green curve) should not exceed normalized SAR\_design\_target

+1dB device uncertainty. In this test, with a maximum normalized SAR of 0.511 being  $\leq$  0.56 (=0.71/1.6 +1dB device uncertainty), the above test result validated the continuity of power limiting in SAR exposure switch scenario.

### 5.9 Exposure Category Switch Test results

In case of head to non-head to head exposure switch test for LTE Band 41, 'first DSI' in section 3.3.9 test procedure refers to head DSI and 'second DSI' refers to non-head DSI. Similarly, in case of non-head to head to non-head exposure switch test, 'first DSI' in section 3.3.9 test procedure refers to non-head DSI and 'second DSI' refers to head DSI.

The validation criteria is, at all times, the time-averaged normalized exposure versus time shall not exceed the normalized limit of 1.0 for both first & second DSIs (i.e., both head exposure category and non-head exposure category).

Test case 1: For head to non-head to head exposure switch test, the time-averaged normalized RF exposure in head exposure DSI (orange curve) did not exceed normalized limit of 1.0 at all times.

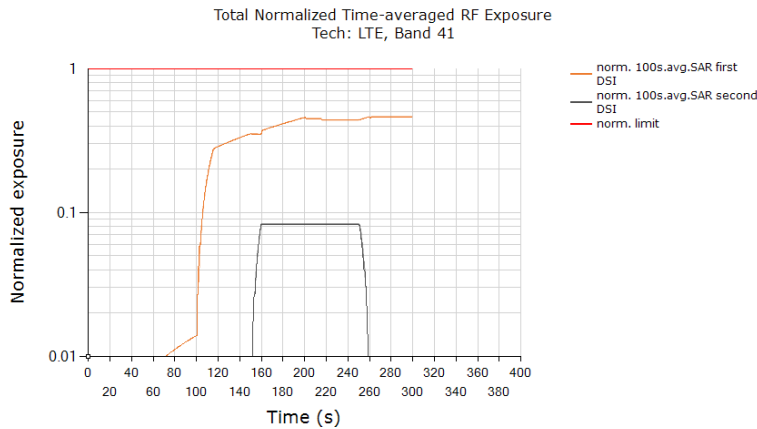

	Exposure Ratio
FCC normalized Exposure Ratio limit	1.0
Max 100s-time averaged normalized Exposure Ratio (orange curve)	0.463
<b>Validated</b>	

**Plot Notes:**

Maximum Tx power is requested at t=100s, time-averaged exposure in head DSI gradually increases until t~150s where the device is switched from head exposure DSI (first DSI, orange curve) to non-head exposure DSI (second DSI, black curve) as evident from increase in exposure of black curve and no change in orange curve between t~150s and t~160s. At t~160s, device is switched back from non-head exposure to head exposure as evident from increase in exposure of orange curve and no change in black curve. In this test, the time-averaged normalized RF exposure in head exposure DSI (orange curve) did not exceed normalized limit of 1.0 at all times, and is less than normalized measured 1gSAR of 0.463 being  $\leq$  0.56 (=0.71 / 1.6 +1dB device uncertainty), validating the exposure continuity when switching between head exposure and non-head exposure categories.

Test case 2: For non-head to head to non-head exposure switch test, the time-averaged normalized RF exposure in non-head exposure DSI (orange curve) did not exceed normalized limit of 1.0 at all times.

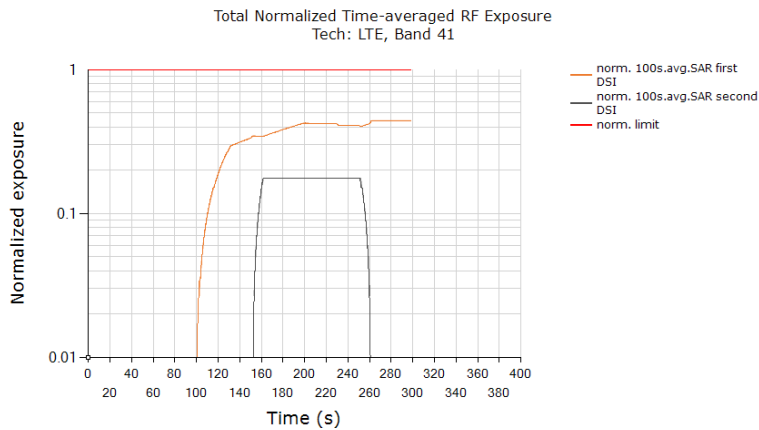

	Exposure Ratio
FCC normalized Exposure Ratio limit	1.0
Max 100s-time averaged normalized Exposure Ratio (orange curve)	0.442
<b>Validated</b>	

**Plot Notes:**

Maximum Tx power is requested at t=100s, time-averaged exposure in non-head DSI gradually increases until t~150s where the device is switched from non-head exposure DSI (first DSI, orange curve) to head exposure DSI (second DSI, black curve) as evident from increase in exposure of black curve and no change in orange curve between t~150s and t~160s. At t~150s, device is switched back from head exposure to non-head exposure as evident from increase in exposure of orange curve and no change in black curve. In this test, the time-averaged normalized RF exposure in non-head exposure DSI (orange curve) did not exceed normalized limit of 1.0 at all times, and is less than normalized measured 1gSAR of 0.442 being  $\leq 0.56$  ( $=0.71 / 1.6 + 1\text{dB}$  device uncertainty), validating the exposure continuity when switching between non-head exposure and head exposure categories.



---

## 6 SAR Test Results for Sub-6 Smart Transmit Feature Validation

---

### 6.1 Measurement setup

The measurement setup is similar to normal SAR measurements (see Appendix E). The difference in SAR measurement setup for time averaging feature validation is that the callbox is signaling in close loop power control mode (instead of requesting maximum power in open loop control mode) and callbox is connected to the PC using GPIB so that the test script executed on PC can send GPIB commands to control the callbox's requested power over time (test sequence). The same test script used in conducted setup for time-varying Tx power measurements is also used in this section for running the test sequences during SAR measurements, and the recorded values from the disconnected power meter by the test script were discarded.

As mentioned in Section 3.4, for EUT to follow TPC command sent from the callbox wirelessly, the "path loss" between callbox antenna and the EUT needs to be very well calibrated. Since the SAR chamber is in uncontrolled environment, precautions must be taken to minimize the environmental influences on "path loss". Similarly, in the case of time-varying SAR measurements in 5G NR (with LTE as anchor), "path loss" between callbox antenna and the EUT needs to be carefully calibrated for both LTE link as well as for 5G NR link.

The EUT is placed in worst-case position according to Table 4-2.

## 6.2 SAR measurement results for time-varying Tx power transmission scenario

Following Section 3.4 procedure, time-averaged SAR measurements are conducted using EX3DV4 probe at peak location of area scan over 500 seconds. cDASY6 system verification for SAR measurement is provided in Appendix C, and the associated SPEAG certificates are attached in Appendix D.

SAR probe integration times depend on the communication signal being tested. Integration times used by SPEAG for their probe calibrations can be downloaded from here (integration time is listed on the bottom of the first page for each tech):

<https://www.speag.com/assets/downloads/services/cs/UIDSummary171205.pdf>

Since the sampling rate used by cDASY6 for pointSAR measurements is not in user control, the number of points in 100s or 60s interval is determined from the scan duration setting in cDASY6 time-average pointSAR measurement by (100s or 60s / cDASY6\_scan\_duration \* total number of pointSAR values recorded). Running average is performed over these number of points in excel spreadsheet to obtain 100s-/60s-averaged pointSAR.

Following Section 3.4, for each of selected technology/band (listed in Table 4-2):

1. With EUT set to peak mode, area scan is performed at  $P_{limit}$ , and time-averaged pointSAR measurements are conducted to determine the pointSAR at  $P_{limit}$  at peak location, denoted as  $pointSAR_{P_{limit}}$ .
2. With EUT set to intended Smart Transmit exposure mode, two more time-averaged pointSAR measurements are performed at the same peak location for test sequences 1 and 2.

To demonstrate compliance, all the pointSAR measurement results were converted into 1gSAR or 10gSAR values by using Equation (3a), rewritten below:

$$1g\_or\_10gSAR(t) = \frac{pointSAR(t)}{pointSAR_{P_{limit}}} * 1g\_or\_10gSAR_{P_{limit}} \quad (3a)$$

where,  $pointSAR(t)$ ,  $pointSAR_{P_{limit}}$ , and  $1g\_or\_10gSAR_{P_{limit}}$  correspond to the measured instantaneous point SAR, measured point SAR at  $P_{limit}$  from above step 1 and 2, and measured 1gSAR or 10gSAR values at  $P_{limit}$  obtained from Part 1 report and listed in Table 4-2 in Section 5.1 of this report.

The power limiting enforcement is effective in all the tests, and the time-averaged 1gSAR does not exceed the SAR design target + device uncertainty for all the tested technologies/bands. Therefore, Qualcomm Smart Transmit time averaging feature is validated.

### 6.2.1 GSM850 SAR test results

SAR test results for test sequence 1:

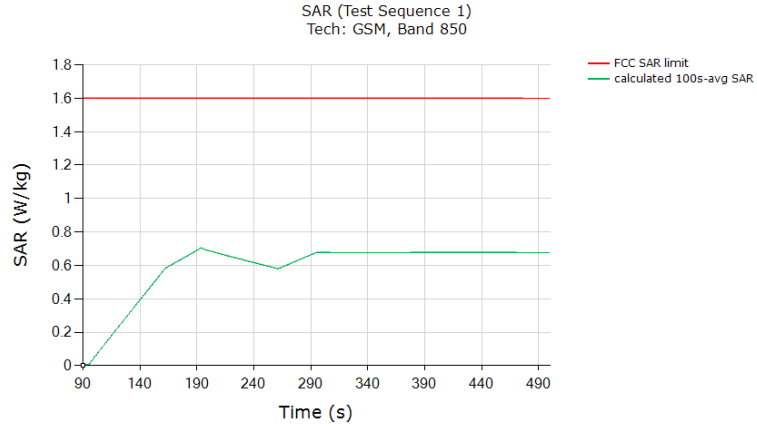

	(W/kg)
FCC 1gSAR limit	1.6
Max 100s-time averaged 1gSAR (green curve)	0.703
<b>Validated:</b> Max time averaged SAR (green curve) does not exceed measured SAR at Plimit +1dB device uncertainty	

SAR test results for test sequence 2:

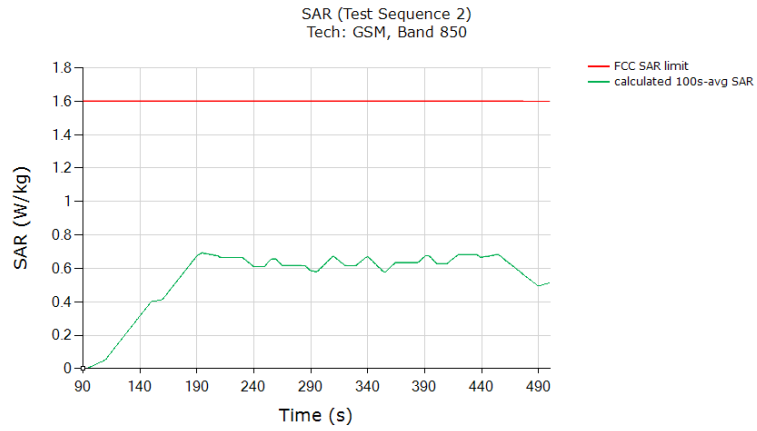

	(W/kg)
FCC 1gSAR limit	1.6
Max 100s-time averaged 1gSAR (green curve)	0.690
<b>Validated:</b> Max time averaged SAR (green curve) does not exceed measured SAR at Plimit +1dB device uncertainty	

### 6.2.2 GSM1900 SAR test results

SAR test results for test sequence 1:

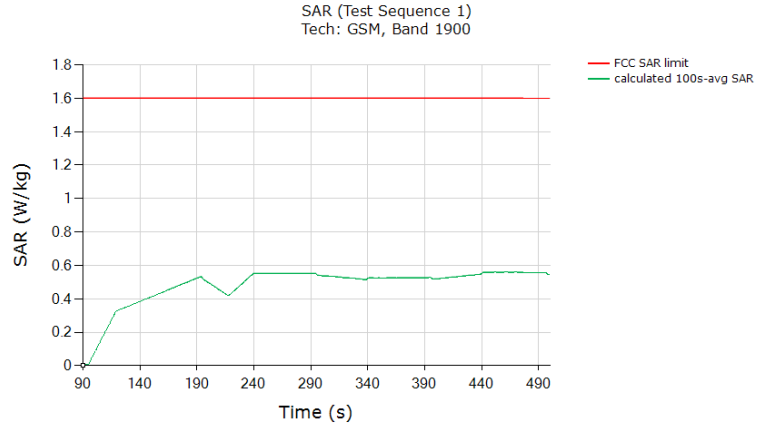

	(W/kg)
FCC 1gSAR limit	1.6
Max 100s-time averaged 1gSAR (green curve)	0.559
<b>Validated:</b> Max time averaged SAR (green curve) does not exceed measured SAR at Plimit +1dB device uncertainty	



SAR test results for test sequence 2:

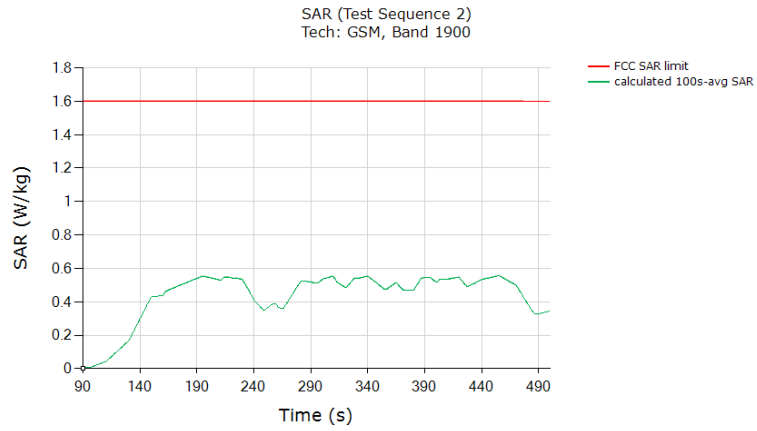

	(W/kg)
FCC 1gSAR limit	1.6
Max 100s-time averaged 1gSAR (green curve)	0.555
<b>Validated:</b> Max time averaged SAR (green curve) does not exceed measured SAR at Plimit +1dB device uncertainty	

### 6.2.3 WCDMA Band 5 SAR test results

SAR test results for test sequence 1:

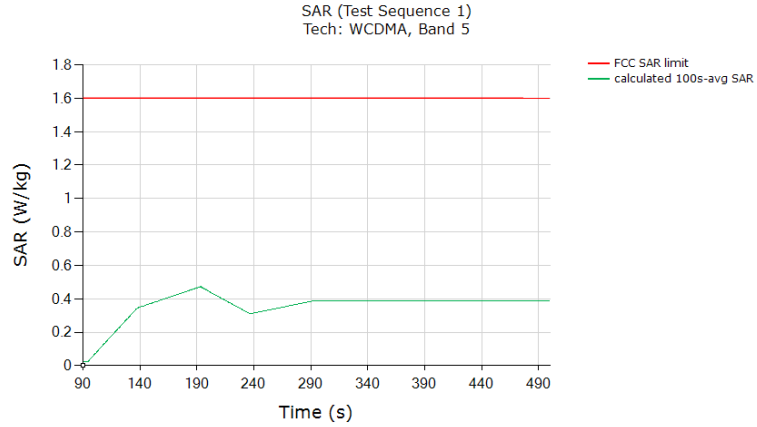

	(W/kg)
FCC 1gSAR limit	1.6
Max 100s-time averaged 1gSAR (green curve)	0.472
<b>Validated:</b> Max time averaged SAR (green curve) does not exceed measured SAR at Plimit +1dB device uncertainty	

SAR test results for test sequence 2:

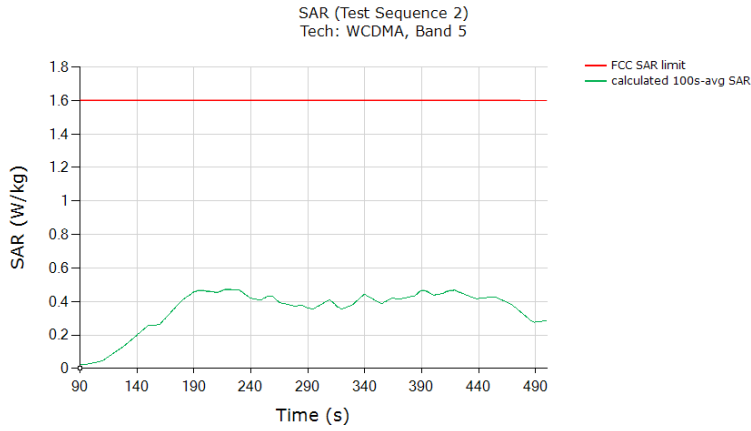

	(W/kg)
FCC 1gSAR limit	1.6
Max 100s-time averaged 1gSAR (green curve)	0.470
<span style="color: green;">Validated:</span> Max time averaged SAR (green curve) does not exceed measured SAR at Plimit +1dB device uncertainty	

### 6.2.4 WCDMA Band 2 SAR test results

SAR test results for test sequence 1:

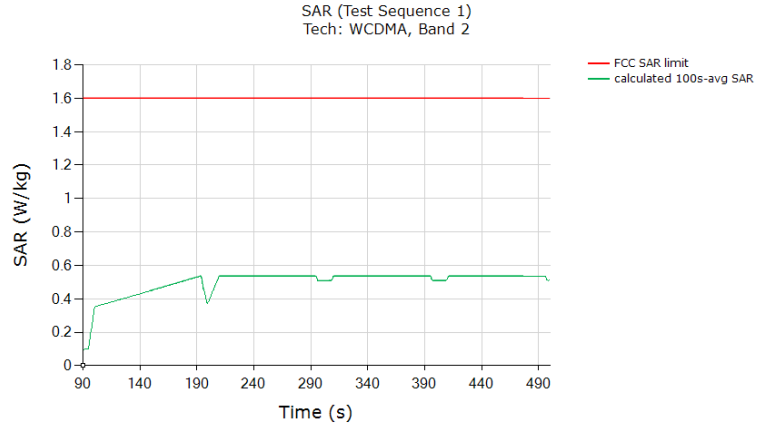

	(W/kg)
FCC 1gSAR limit	1.6
Max 100s-time averaged 1gSAR (green curve)	0.536
<b>Validated:</b> Max time averaged SAR (green curve) does not exceed measured SAR at Plimit +1dB device uncertainty	

SAR test results for test sequence 2:

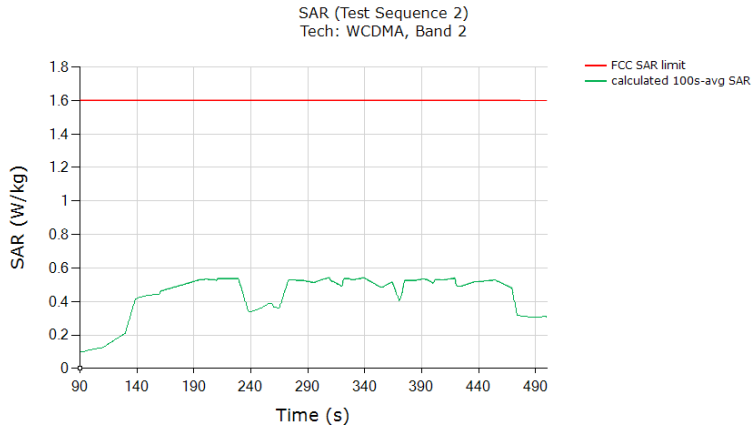

	(W/kg)
FCC 1gSAR limit	1.6
Max 100s-time averaged 1gSAR (green curve)	0.540
<b>Validated:</b> Max time averaged SAR (green curve) does not exceed measured SAR at Plimit +1dB device uncertainty	

**6.2.5 LTE Band 2 SAR test results**

SAR test results for test sequence 1:

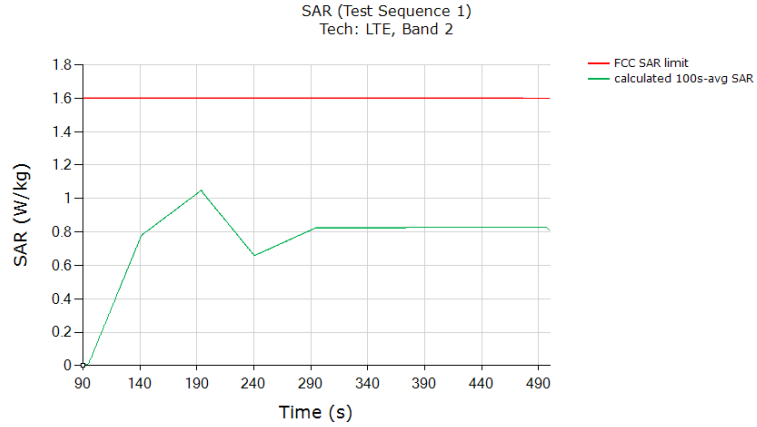

	(W/kg)
FCC 1gSAR limit	1.6
Max 100s-time averaged 1gSAR (green curve)	1.048
<b>Validated:</b> Max time averaged SAR (green curve) does not exceed measured SAR at Plimit +1dB device uncertainty	

SAR test results for test sequence 2:

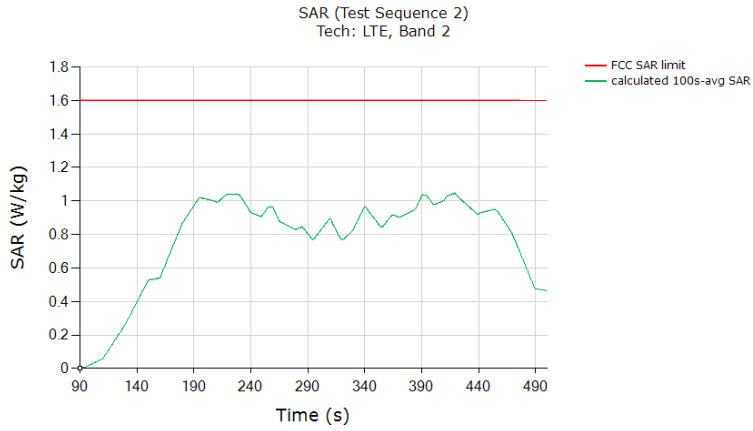

	(W/kg)
FCC 1gSAR limit	1.6
Max 100s-time averaged 1gSAR (green curve)	1.046
<b>Validated:</b> Max time averaged SAR (green curve) does not exceed measured SAR at Plimit +1dB device uncertainty	

**6.2.6 LTE Band 41 SAR test results**

SAR test results for test sequence 1:

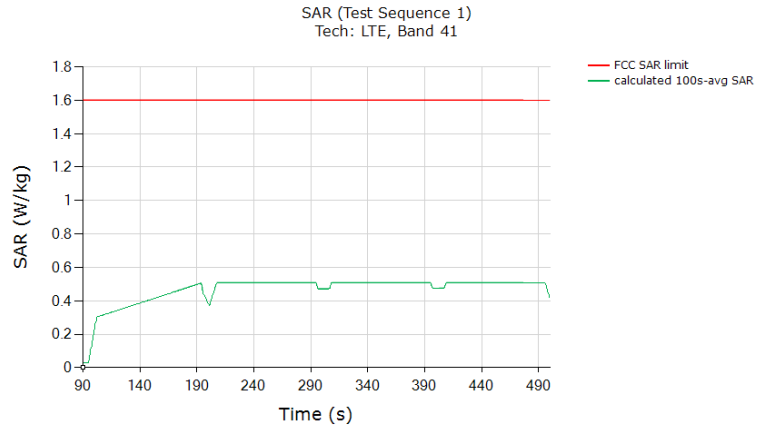

	(W/kg)
FCC 1gSAR limit	1.6
Max 100s-time averaged 1gSAR (green curve)	0.507
<b>Validated:</b> Max time averaged SAR (green curve) does not exceed measured SAR at Plimit +1dB device uncertainty	



SAR test results for test sequence 2:

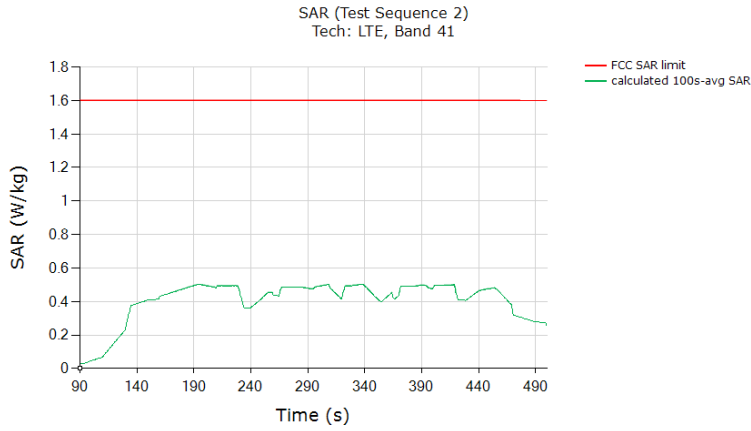

	(W/kg)
FCC 1gSAR limit	1.6
Max 100s-time averaged 1gSAR (green curve)	0.501
<b>Validated:</b> Max time averaged SAR (green curve) does not exceed measured SAR at Plimit +1dB device uncertainty	

### 6.2.7 5G NR FR1 n66 SAR test results

#### SAR test results for test sequence 1:

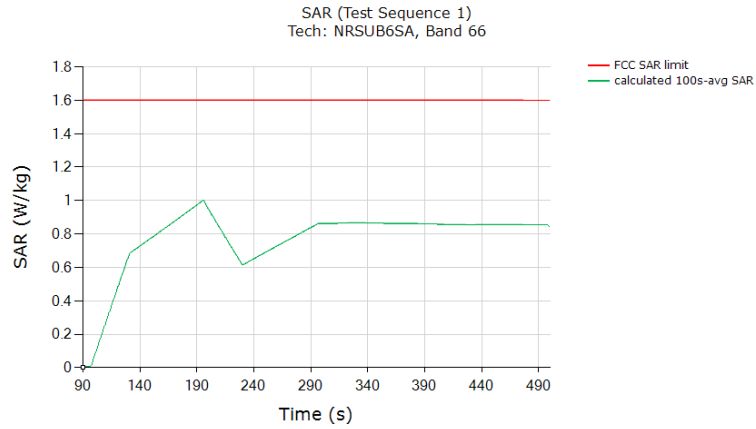

	(W/kg)
FCC 1gSAR limit	1.6
Max 100s-time averaged 1gSAR (green curve)	1.001
<b>Validated:</b> Max time averaged SAR (green curve) does not exceed measured SAR at Plimit +1dB device uncertainty	

SAR test results for test sequence 2:

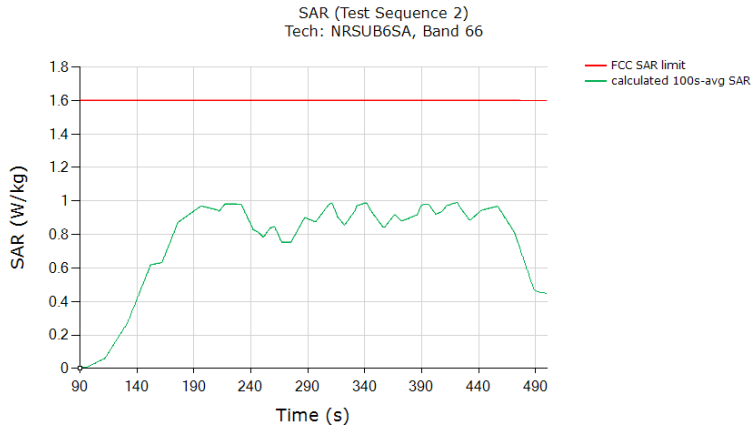

	(W/kg)
FCC 1gSAR limit	1.6
Max 100s-time averaged 1gSAR (green curve)	0.991
<b>Validated:</b> Max time averaged SAR (green curve) does not exceed measured SAR at Plimit +1dB device uncertainty	

### 6.2.8 5G NR FR1 n7 SAR test results

#### SAR test results for test sequence 1:

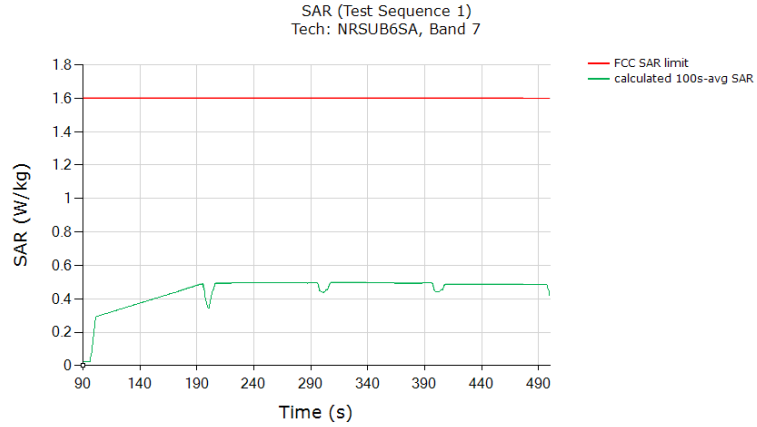

	(W/kg)
FCC 1gSAR limit	1.6
Max 100s-time averaged 1gSAR (green curve)	0.495
<b>Validated:</b> Max time averaged SAR (green curve) does not exceed measured SAR at Plimit +1dB device uncertainty	

SAR test results for test sequence 2:

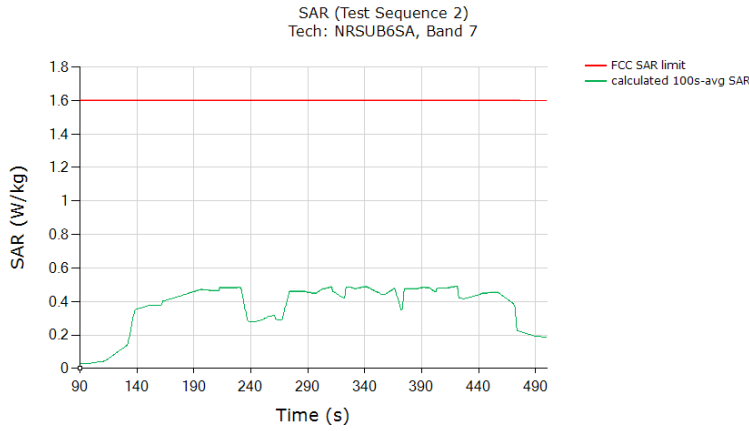

	(W/kg)
FCC 1gSAR limit	1.6
Max 100s-time averaged 1gSAR (green curve)	0.491
<b>Validated:</b> Max time averaged SAR (green curve) does not exceed measured SAR at Plimit +1dB device uncertainty	

## 7 Conclusions

Qualcomm Smart Transmit feature employed has been validated through the conducted/ radiated power measurement, as well as SAR measurement.

As demonstrated in this report, the power limiting enforcement is effective and the total normalized time-averaged RF exposure does not exceed 1.0 for all the transmission scenarios described in Section 2. Therefore, the EUT complies with FCC RF exposure requirement.

## Appendix A. Test Sequences

1. Test sequence is generated based on below parameters of the EUT:
  - a. Measured maximum power ( $P_{max}$ )
  - b. Measured Tx\_power\_at\_SAR\_design\_target ( $P_{limit}$ )
  - c. Reserve\_power\_margin (dB)
    - $P_{reserve} \text{ (dBm)} = \text{measured } P_{limit} \text{ (dBm)} - \text{Reserve\_power\_margin (dB)}$
  - d. SAR\_time\_window (100s for FCC)
2. Test Sequence 1 Waveform:

Based on the parameters above, the Test Sequence 1 is generated with one transition between high and low Tx powers. Here, high power =  $P_{max}$ ; low power =  $P_{max}/2$ , and the transition occurs after 80 seconds at high power  $P_{max}$ . As long as the power enforcement is taking into effective during one 100s/60s time window, the validation test with this defined test sequence 1 is valid, otherwise, select other radio configuration (band/DSI within the same technology group) having lower  $P_{limit}$  for this test. The Test sequence 1 waveform is shown below:

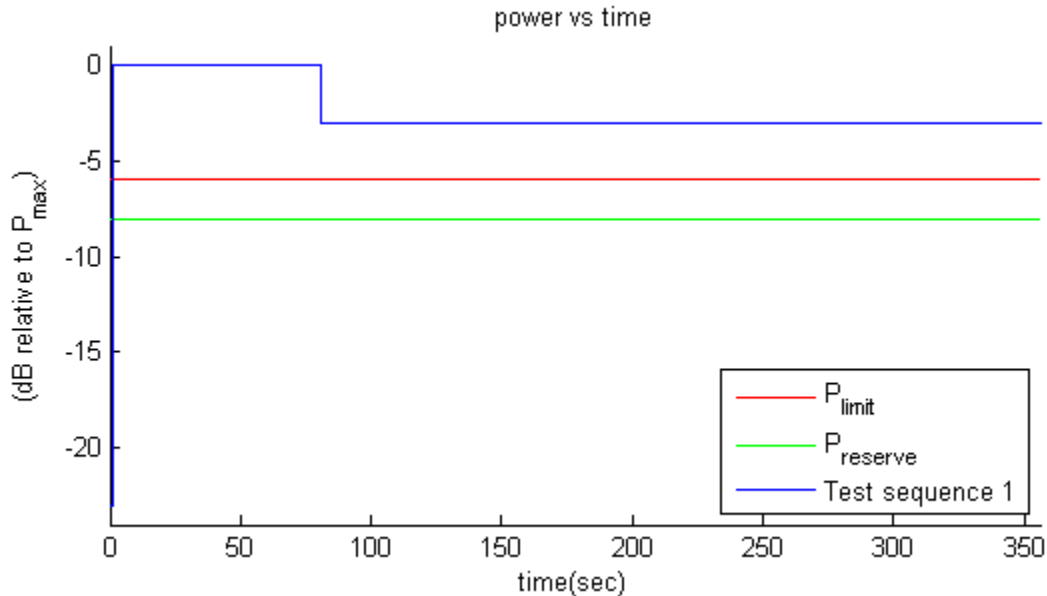

Figure 0-1 Test sequence 1 waveform



3. Test Sequence 2 Waveform:

Based on the parameters in A-1, the Test Sequence 2 is generated as described in Table 10-1, which contains two 170 second-long sequences (yellow and green highlighted rows) that are mirrored around the center row of 20s, resulting in a total duration of 360 seconds:

Table A-1 Test Sequence 2

Time duration (seconds)	dB relative to $P_{limit}$ or $P_{reserve}$
15	$P_{reserve} - 2$
20	$P_{limit}$
20	$(P_{limit} + P_{max})/2$ averaged in mW and rounded to nearest 0.1 dB step
10	$P_{reserve} - 6$
20	$P_{max}$
15	$P_{limit}$
15	$P_{reserve} - 5$
20	$P_{max}$
10	$P_{reserve} - 3$
15	$P_{limit}$
10	$P_{reserve} - 4$
20	$(P_{limit} + P_{max})/2$ averaged in mW and rounded to nearest 0.1 dB step
10	$P_{reserve} - 4$
15	$P_{limit}$
10	$P_{reserve} - 3$
20	$P_{max}$
15	$P_{reserve} - 5$
15	$P_{limit}$
20	$P_{max}$
10	$P_{reserve} - 6$
20	$(P_{limit} + P_{max})/2$ averaged in mW and rounded to nearest 0.1 dB step
20	$P_{limit}$
15	$P_{reserve} - 2$



The Test Sequence 2 waveform is shown in Figure A-2.

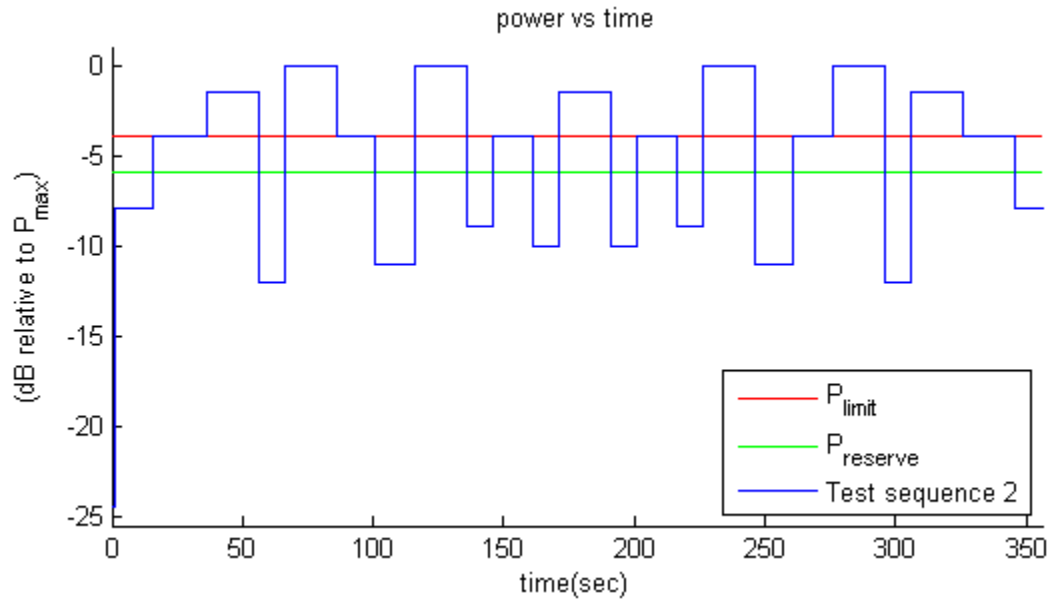



## Appendix B. Test Procedures for 5G NR + LTE Radio

---

Appendix B provides the test procedures for validating Qualcomm Smart Transmit feature for LTE + 5G NR non-standalone (NSA) mode transmission scenario, where sub-6GHz LTE link acts as an anchor.

### 1 Time-varying Tx power test for 5G NR in NSA mode

Follows Section 3.2.1 to select test configurations for time-varying test. This test is performed with two pre-defined test sequences (described in Section 3.1) applied to 5G NR (with LTE on all-down bits or low power for the entire test after establishing the LTE+5G NR call with the callbox). Follow the test procedures described in Section 3.3.1 to demonstrate the effectiveness of power limiting enforcement and that the time averaged Tx power of 5G NR when converted into 1gSAR values does not exceed the regulatory limit at all times (see Eq. (1a) and (1b)). 5G NR response to test sequence1 and test sequence2 will be similar to other technologies (say, LTE), and are shown in Sections 6.3.7 and 6.3.8.

### 2 Switch in SAR exposure between LTE vs. 5G NR during transmission

This test is to demonstrate that Smart Transmit feature accurately accounts for switching in exposures among SAR for LTE radio only, SAR from both LTE radio and 5G NR, and SAR from 5G NR only scenarios, and ensures total time-averaged RF exposure compliance with FCC limit.

#### Test procedure:

1. Measure conducted Tx power corresponding to  $P_{limit}$  for LTE and 5G NR in selected band. Test condition to measure conducted  $P_{limit}$  is:
  - Establish device in call with the callbox for LTE in desired band. Measure conducted Tx power corresponding to LTE  $P_{limit}$  with Smart Transmit Peak exposure mode enabled, callbox set to request maximum power.
  - Repeat above step to measure conducted Tx power corresponding to 5G NR  $P_{limit}$ . If testing LTE+5G NR in non-standalone mode, then establish LTE+5G NR call with callbox and request all down bits for radio1 LTE. In this scenario, with callbox requesting maximum power from 5G NR, measured conducted Tx power corresponds to radio2  $P_{limit}$  (as radio1 LTE is at all-down bits)
2. Set EUT to the intended Smart Transmit exposure mode for LTE + 5G NR call. First, establish LTE connection in all-up bits with the callbox, and then 5G NR connection is added with callbox requesting UE to transmit at maximum power in 5G NR. As soon as the 5G NR connection is established, request all-down bits on LTE link (otherwise, 5G NR will not have sufficient RF exposure margin to sustain the call with LTE in all-up bits). Continue LTE (all-down bits)+5G NR transmission for more than

- one time-window duration to test predominantly 5G NR SAR exposure scenario (as SAR exposure is negligible from all-down bits in LTE). After at least one time-window, request LTE to go all-up bits to test LTE SAR and 5G NR SAR exposure scenario. After at least one more time-window, drop (or request all-down bits) 5G NR transmission to test predominantly LTE SAR exposure scenario. Continue the test for at least one more time-window. Record the conducted Tx powers for both LTE and 5G NR for the entire duration of this test.
3. Once the measurement is done, extract instantaneous Tx power versus time for both LTE and 5G NR links. Similar to technology/band switch test in Section 3.3.3, convert the conducted Tx power for both these radios into 1gSAR value (see Eq. (6a) and (6b)) using corresponding technology/band  $P_{limit}$  measured in Step 1, and then perform 100s running average to determine time-averaged 1gSAR versus time as illustrated in Figure 3-1.
  4. Make one plot containing: (a) instantaneous Tx power versus time measured in Step 2.
  5. Make another plot containing: (a) instantaneous 1gSAR versus time determined in Step 3, (b) computed time-averaged 1gSAR versus time determined in Step 3, and (c) corresponding regulatory  $1gSAR_{limit}$  of 1.6W/kg.

The validation criteria is, at all times, the time-averaged 1gSAR versus time shall not exceed the regulatory  $1gSAR_{limit}$  of 1.6W/kg.

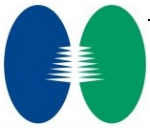

## Appendix C. cDASY6 System Verification

### 1 The system to be used for the SAR and near field power density measurement

- SPEAG DASY6 system
- SPEAG cDASY6 5G module software
- EUMmWVx probe
- 5G Phantom cover
- SAR phantom (SAM-Twin/ELI Phantom)
- SAR probe (EX3D, ES3D probes)

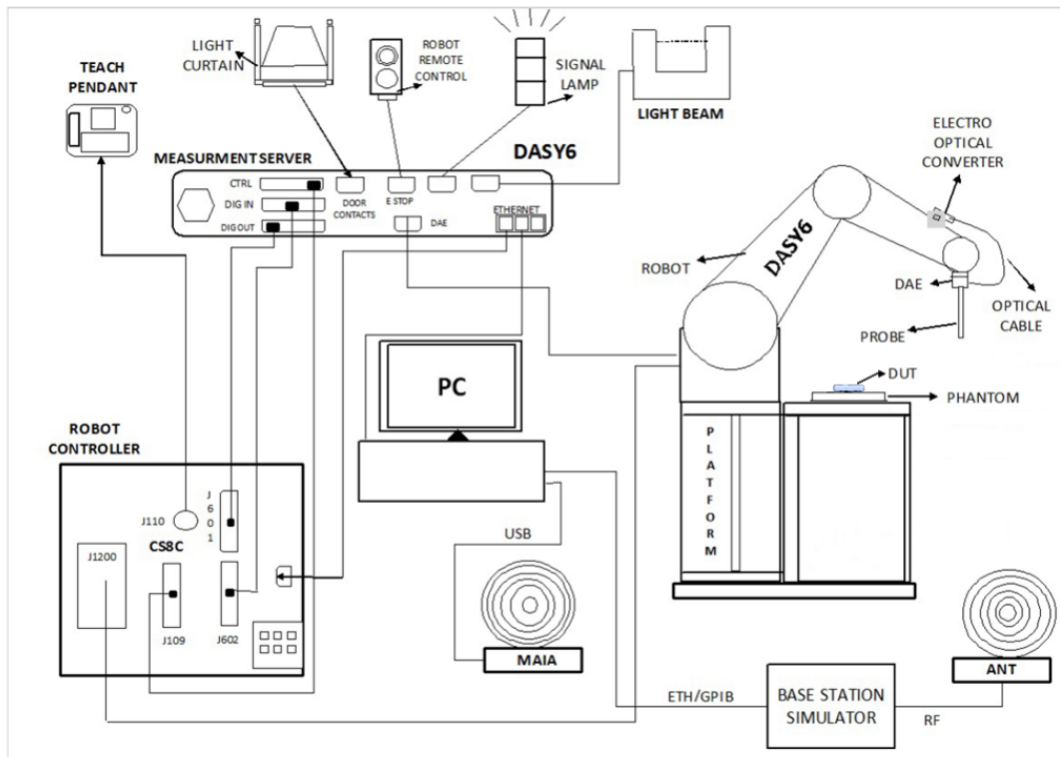

### 2 Test Site Location

Sporton International Inc. (Shenzhen) is accredited to ISO/IEC 17025:2017 by American Association for Laboratory Accreditation with Certificate Number 5145.01.

Testing Laboratory			
Test Firm	Sporton International Inc. (Shenzhen)		
Test Site Location	1/F, 2/F, Bldg 5, Shiling Industrial Zone, Xinwei Village, Xili, Nanshan, Shenzhen, 518055 People's Republic of China TEL: +86-755-86379589 FAX: +86-755-86379595		
Test Site No.	Sporton Site No.	FCC Designation No.	FCC Test Firm Registration No.
	SAR02-SZ	CN1256	421272

### 3 SAR E-Field Probe

<b>Construction</b>	Symmetric design with triangular core Built-in shielding against static charges PEEK enclosure material (resistant to organic solvents, e.g., DGBE)	
<b>Frequency</b>	10 MHz – >6 GHz Linearity: ±0.2 dB (30 MHz – 6 GHz)	
<b>Directivity</b>	±0.3 dB in TSL (rotation around probe axis) ±0.5 dB in TSL (rotation normal to probe axis)	
<b>Dynamic Range</b>	10 µW/g – >100 mW/g Linearity: ±0.2 dB (noise: typically <1 µW/g)	
<b>Dimensions</b>	Overall length: 337 mm (tip: 20 mm) Tip diameter: 2.5 mm (body: 12 mm) Typical distance from probe tip to dipole centers: 1 mm	

### 4 Data Acquisition Electronics (DAE)

The data acquisition electronics (DAE) consists of a highly sensitive electrometer-grade preamplifier with auto-zeroing, a channel and gain-switching multiplexer, a fast 16 bit AD-converter and a command decoder and control logic unit. Transmission to the measurement server is accomplished through an optical downlink for data and status information as well as an optical uplink for commands and the clock.

The input impedance of the DAE is 200 MOhm; the inputs are symmetrical and floating. Common mode rejection is above 80 dB.

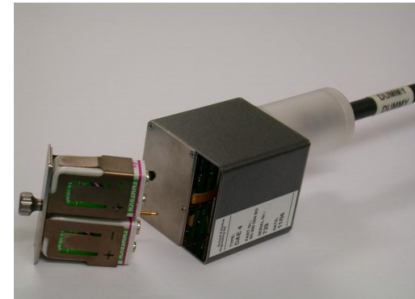

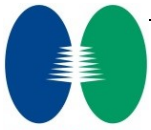

## 5 Test Equipment List

Manufacturer	Name of Equipment	Type/Model	Serial Number	Calibration	
				Last Cal.	Due Date
SPEAG	835MHz System Validation Kit	D835V2	4d162	Dec. 17, 2021	Dec. 15, 2024
SPEAG	1750MHz System Validation Kit	D1750V2	1090	Feb. 24, 2022	Feb. 23, 2025
SPEAG	1900MHz System Validation Kit	D1900V2	5d182	Dec. 20, 2021	Dec. 18, 2024
SPEAG	2600MHz System Validation Kit	D2600V2	1070	Dec. 20, 2021	Dec. 18, 2024
SPEAG	Data Acquisition Electronics	DAE4	1303	Nov. 20, 2023	Nov. 19, 2024
SPEAG	Dosimetric E-Field Probe	EX3DV4	3819	Jun. 06, 2023	Jun. 05, 2024
SPEAG	SAM Twin Phantom	QD 000 P40 CD	1670	NCR	NCR
SPEAG	Phone Positioner	N/A	N/A	NCR	NCR
R&S	Wideband Radio Communication Tester	CMW500	157651	Dec. 28, 2023	Dec. 27, 2024
Keysight	UXM 5G Wireless Test Platform	E7515B	MY59321492	Oct. 17, 2023	Oct. 16, 2024
Keysight	Network Analyzer	E5071C	MY46523671	Oct. 16, 2023	Oct. 15, 2024
Speag	Dielectric Assessment KIT	DAK-3.5	1071	Feb. 20, 2023	Feb. 19, 2024
Agilent	Signal Generator	N5181A	MY50145381	Dec. 28, 2023	Dec. 27, 2024
Anritsu	Power Sensor	MA2411B	1542004	Dec. 28, 2023	Dec. 27, 2024
Anritsu	Power Meter	ML2495A	1339473	Dec. 28, 2023	Dec. 27, 2024
R&S	Power Sensor	NRP33S	102184	Oct. 17, 2023	Oct. 16, 2024
R&S	Power Sensor	NRP50S	101254	Apr. 06, 2023	Apr. 05, 2024
R&S	Power Sensor	NRP8S	109228	Apr. 06, 2023	Apr. 05, 2024
TES	Hygrometer	1310	200505600	Jul. 08, 2023	Jul. 07, 2024
Anymetre	Thermo-Hygrometer	JR593	2015030904	Jul. 08, 2023	Jul. 07, 2024
SPEAG	Device Holder	N/A	N/A	N/A	N/A
AR	Amplifier	5S1G4	0333096	Apr. 06, 2023	Apr. 05, 2024
Mini-Circuits	Amplifier	ZVE-3W-83+	599201528	Apr. 06, 2023	Apr. 05, 2024
ARRA	Power Divider	A3200-2	N/A	Note 1	
TRM	Directional Coupler	DCS1070	50021-1	Note 1	
TRM	Directional Coupler	DCS1070	50021-2	Note 1	
ET Industries	Dual Directional Coupler	C-058-10	N/A	Note 1	
Weinschel	Attenuator 1	3M-10	N/A	Note 1	
Weinschel	Attenuator 2	3M-20	N/A	Note 1	

### General Note:

1. Prior to system verification and validation, the path loss from the signal generator to the system check source and the power meter, which includes the amplifier, cable, attenuator and directional coupler, was measured by the network analyzer. The reading of the power meter was offset by the path loss difference between the path to the power meter and the path to the system check source to monitor the actual power level fed to the system check source.
2. The dipole calibration interval can be extended to 3 years with justification according to KDB 865664 D01. The dipoles are also not physically damaged, or repaired during the interval. The justification data in appendix D can be found which the return loss is < -20dB, within 20% of prior calibration, the impedance is within 5 ohm of prior calibration for each dipole.

## 6 SAR system verification and validation

### 6.1. Tissue Verification

The tissue dielectric parameters of tissue-equivalent media used for SAR measurements must be characterized within a temperature range of 18°C to 25°C, measured with calibrated instruments and apparatuses, such as network analyzers and temperature probes. The temperature of the tissue-equivalent medium during SAR measurement must also be within 18°C to 25°C and within ± 2°C of the temperature when the tissue parameters are characterized. The tissue dielectric measurement system must be calibrated before use. The dielectric parameters must be measured before the tissue-equivalent medium is used in a series of SAR measurements.

The liquid tissue depth was at least 15cm in the phantom for all SAR testing

The following tissue formulations are provided for reference only as some of the parameters have not been thoroughly verified. The composition of ingredients may be modified accordingly to achieve the desired target tissue parameters required for routine SAR evaluation.

Frequency (MHz)	Water (%)	Sugar (%)	Cellulose (%)	Salt (%)	Preventol (%)	DGBE (%)	Conductivity (σ)	Permittivity (ε <sub>r</sub> )
835	40.3	57.9	0.2	1.4	0.2	0	0.90	41.5
1750, 1900, 2000	55.2	0	0	0.3	0	44.5	1.40	40.0
2300	55.0	0	0	0	0	45.0	1.67	39.5
2600	54.8	0	0	0.1	0	45.1	1.96	39.0

#### Simulating Liquid for 5GHz, Manufactured by SPEAG

Ingredients	(% by weight)
Water	64~78%
Mineral oil	11~18%
Emulsifiers	9~15%
Additives and Salt	2~3%

#### <Tissue Check Results>

Frequency (MHz)	Liquid Temp. (°C)	Conductivity (σ)	Permittivity (ε <sub>r</sub> )	Conductivity Target (σ)	Permittivity Target (ε <sub>r</sub> )	Delta (σ) (%)	Delta (ε <sub>r</sub> ) (%)	Limit (%)	Date
835	22.5	0.890	41.500	0.90	41.50	-1.11	0.00	±5	2024/1/17
1750	22.3	1.340	41.900	1.37	40.10	-2.19	4.49	±5	2024/1/17
1900	22.1	1.440	41.700	1.40	40.00	2.86	4.25	±5	2024/1/18
2600	22.3	1.940	40.700	1.96	39.00	-1.02	4.36	±5	2024/1/18



### 6.2. System Verification

Comparing to the original SAR value provided by SPEAG, the verification data should be within its specification of 10 %. Below table shows the target SAR and measured SAR after normalized to 1W input power. The table below indicates the system performance check can meet the variation criterion and the plots can be referred to Appendix D.

#### <System Verification Results>

##### 1g SAR

Date	Frequency (MHz)	Input Power (mW)	Dipole S/N	Probe S/N	DAE S/N	Measured 1g SAR (W/kg)	Targeted 1g SAR (W/kg)	Normalized 1g SAR (W/kg)	Deviation (%)
2024/1/17	835	250	4d162	3819	1303	2.510	9.640	10.04	4.15
2024/1/17	1750	250	1090	3819	1303	8.840	37.000	35.36	-4.43
2024/1/18	1900	250	5d182	3819	1303	10.100	39.600	40.4	2.02
2024/1/18	2600	250	1070	3819	1303	13.700	56.200	54.8	-2.49

##### 10g SAR

Date	Frequency (MHz)	Input Power (mW)	Dipole S/N	Probe S/N	DAE S/N	Measured 10g SAR (W/kg)	Targeted 10g SAR (W/kg)	Normalized 10g SAR (W/kg)	Deviation (%)
2024/1/17	835	250	4d162	3819	1303	1.640	6.260	6.56	4.79
2024/1/17	1750	250	1090	3819	1303	4.710	19.500	18.84	-3.38
2024/1/18	1900	250	5d182	3819	1303	5.240	20.200	20.96	3.76
2024/1/18	2600	250	1070	3819	1303	6.100	24.600	24.4	-0.81