



FCC RF Test Report

APPLICANT : Motorola Mobility LLC
EQUIPMENT : Mobile Cellular Phone
BRAND NAME : Motorola
MODEL NAME : XT2417-1, XT2417-2, XT2417-4, XT2417D
FCC ID : IHDT56AQ3
STANDARD : 47 CFR Part 2, 22(H), 24(E), 27(L)
CLASSIFICATION : PCS Licensed Transmitter Held to Ear (PCE)
TEST DATE(S) : Nov. 03, 2023 ~ Nov. 23, 2023

We, Sporton International Inc. (Kunshan), would like to declare that the tested sample has been evaluated in accordance with the procedures given in ANSI C63.26-2015 and shown compliance with the applicable technical standards.

The test results in this report apply exclusively to the tested model / sample. Without written approval of Sporton International Inc. (Kunshan), the test report shall not be reproduced except in full.

Jason Jia

Approved by: Jason Jia



Sporton International Inc. (Kunshan)

**No. 1098, Pengxi North Road, Kunshan Economic Development Zone Jiangsu Province 215300
People's Republic of China**



TABLE OF CONTENTS

REVISION HISTORY.....3

SUMMARY OF TEST RESULT4

1 GENERAL DESCRIPTION.....5

1.1 Applicant.....5

1.2 Manufacturer5

1.3 Product Feature of Equipment Under Test5

1.4 Product Specification of Equipment Under Test6

1.5 Modification of EUT.....6

1.6 Specification of Accessory7

1.7 Maximum ERP/EIRP Power, and Emission Designator7

1.8 Testing Location7

1.9 Test Software8

1.10 Applicable Standards8

2 TEST CONFIGURATION OF EQUIPMENT UNDER TEST.....9

2.1 Test Mode.....9

2.2 Connection Diagram of Test System10

2.3 Support Unit used in test configuration10

2.4 Measurement Results Explanation Example11

2.5 Frequency List of Low/Middle/High Channels.....11

3 CONDUCTED TEST RESULT.....12

3.1 Measuring Instruments.....12

3.2 Test Setup12

3.3 Test Result of Conducted Test.....12

3.4 Conducted Output Power and ERP/EIRP13

3.5 Peak-to-Average Ratio14

3.6 99% Occupied Bandwidth and 26dB Bandwidth Measurement.....15

3.7 Conducted Band Edge16

3.8 Conducted Spurious Emission17

3.9 Frequency Stability.....18

4 RADIATED TEST ITEMS19

4.1 Measuring Instruments.....19

4.2 Test Setup19

4.3 Test Result of Radiated Test.....20

4.4 Field Strength of Spurious Radiation Measurement21

5 LIST OF MEASURING EQUIPMENT22

6 MEASUREMENT UNCERTAINTY23

APPENDIX A. TEST RESULTS OF CONDUCTED TEST

APPENDIX B. TEST RESULTS OF RADIATED TEST

APPENDIX C. TEST SETUP PHOTOGRAPHS



REVISION HISTORY

REPORT NO.	VERSION	DESCRIPTION	ISSUED DATE
FG3O1303A	Rev. 01	Initial issue of report	Nov. 30, 2023



SUMMARY OF TEST RESULT

Report Section	FCC Rule	Description	Limit	Result	Remark
3.4	§2.1046	Conducted Output Power	-	Report Only	-
	§22.913(a)(5)	Effective Radiated Power	< 7 Watts	PASS	-
	§24.232(c)	Equivalent Isotropic Radiated Power	< 2 Watts	PASS	-
	§27.50(d)(4)	Equivalent Isotropic Radiated Power	< 1 Watts	PASS	-
3.5	§24.232(d)	Peak-to-Average Ratio	< 13 dB	PASS	-
3.6	§2.1049	Occupied Bandwidth	Reporting Only	PASS	-
3.7	§2.1051 §22.917(a) §24.238(a) §27.53(h)	Band Edge Measurement	< 43+10log10(P[Watts])	PASS	-
3.8	§2.1051 §22.917(a) §24.238(a) §27.53(h)	Conducted Emission	< 43+10log10(P[Watts])	PASS	-
3.9	§2.1055 §22.355	Frequency Stability for Temperature & Voltage	< 2.5 ppm for Part 22	PASS	-
	§2.1055 §24.235 §27.54		Within Authorized Band		
4.4	§2.1053; §22.917(a); §24.238(a); §27.53(h)	Field Strength of Spurious Radiation	< 43+10log10(P[Watts])	PASS	Under limit 35.64 dB at 9252.00 MHz

Conformity Assessment Condition:

- The test results (PASS/FAIL) with all measurement uncertainty excluded are presented against the regulation limits or in accordance with the requirements stipulated by the applicant/manufacturer who shall bear all the risks of non-compliance that may potentially occur if measurement uncertainty is taken into account.
- The measurement uncertainty please refer to each test result in the section "Measurement Uncertainty"

Disclaimer:

The product specifications of the EUT presented in the test report that may affect the test assessments are declared by the manufacturer who shall take full responsibility for the authenticity.



1 General Description

1.1 Applicant

Motorola Mobility LLC
222 W,Merchandise Mart Plaza, Chicago IL 60654 USA

1.2 Manufacturer

Motorola Mobility LLC
222 W,Merchandise Mart Plaza, Chicago IL 60654 USA

1.3 Product Feature of Equipment Under Test

Product Feature	
Equipment	Mobile Cellular Phone
Brand Name	Motorola
Model Name	XT2417-1, XT2417-2, XT2417-4, XT2417D
FCC ID	IHDT56AQ3
IMEI Code	Conducted: 354581940048052/354581940048060 Radiation: 350212100020376/350212100020384
HW Version	DVT2
SW Version	U1UFN34.35
EUT Stage	Identical Prototype

Remark:

1. The above EUT's information was declared by manufacturer. Please refer to the specifications or user's manual for more detailed description.
2. The four model names are only for market segment purpose, there is no other difference.



1.4 Product Specification of Equipment Under Test

Standards-related Product Specification	
Tx Frequency	GSM/GPRS/EDGE: 850: 824 MHz ~ 849 MHz 1900: 1850MHz ~ 1910MHz WCDMA: Band V: 824 MHz ~ 849 MHz Band II: 1850 MHz ~ 1910 MHz Band IV: 1710 MHz ~ 1755 MHz
Rx Frequency	GSM/GPRS/EDGE: 850: 869 MHz ~ 894 MHz 1900: 1930 MHz ~ 1990 MHz WCDMA: Band V: 869 MHz ~ 894 MHz Band II: 1930 MHz ~ 1990 MHz Band IV: 2110 MHz ~ 2155 MHz
Maximum Output Power to Antenna	GSM/GPRS/EDGE: 850: 32.71 dBm 1900: 29.90 dBm WCDMA: Band V: 23.00 dBm Band II: 23.01 dBm Band IV: 22.85 dBm
Antenna Type	PIFA Antenna
Antenna Gain	Cellular Band: -3.5 dBi PCS Band: -0.5 dBi AWS Band: -0.6 dBi
Type of Modulation	GSM: GMSK GPRS: GMSK EDGE: GMSK / 8PSK WCDMA: BPSK HSPA: QPSK HSPA+ : 16QAM DC-HSDPA : 64QAM

1.5 Modification of EUT

No modifications are made to the EUT during all test items.



1.6 Specification of Accessory

Accessories Information				
AC Adapter 1	Brand Name	Motorola(AOHAI)	Model Name	MC-101
AC Adapter 2	Brand Name	Motorola(Salcomp)	Model Name	MC-101
AC Adapter 3	Brand Name	Motorola(Chenyang)	Model Name	MC-101
Battery 1	Brand Name	Motorola(ATL)	Model Name	QF50
Battery 2	Brand Name	Motorola (Sunwoda)	Model Name	QF50
USB Cable 1	Brand Name	HE XIN	Model Name	HX-HQ-05
USB Cable 2	Brand Name	SAI BAO	Model Name	SHQ-A174
Earphone 1	Brand Name	Newleader	Model Name	EM313A-19SF

1.7 Maximum ERP/EIRP Power, and Emission Designator

FCC Rule	Frequency Band	Frequency Range (MHz)	Type of Modulation	Maximum ERP/EIRP (W)	Emission Designator
Part 22	GSM850 (GSM)	824.2 ~ 848.8	GMSK	0.5082	243KGXW
Part 22	GSM850 (EDGE)	824.2 ~ 848.8	8PSK	0.1262	243KG7W
Part 22	WCDMA Band V	826.4 ~ 846.6	BPSK	0.0543	4M13F9W
Part 24	GSM1900 (GSM)	1850.2 ~ 1909.8	GMSK	0.8710	242KGXW
Part 24	GSM1900 (EDGE)	1850.2 ~ 1909.8	8PSK	0.3556	251KG7W
Part 24	WCDMA Band II	1852.4 ~ 1907.6	BPSK	0.1782	4M15F9W
Part 27	WCDMA Band IV	1712.4 ~ 1752.6	BPSK	0.1679	4M15F9W

1.8 Testing Location

Sporton International Inc. (Kunshan) is accredited to ISO/IEC 17025:2017 by American Association for Laboratory Accreditation with Certificate Number 5145.02.

Test Firm	Sporton International Inc. (Kunshan)		
Test Site Location	No. 1098, Pengxi North Road, Kunshan Economic Development Zone Jiangsu Province 215300 People’s Republic of China TEL : +86-512-57900158		
Test Site No.	Sporton Site No.	FCC Designation No.	FCC Test Firm Registration No.
	03CH05-KS 03CH06-KS TH01-KS	CN1257	314309



1.9 Test Software

Item	Site	Manufacturer	Name	Version
1.	TH01-KS	SPORTON	Part2224_Ver5.0 200330	5.0
2.	03CH05-KS	AUDIX	E3	210616
3.	03CH06-KS	AUDIX	E3	210616

1.10 Applicable Standards

According to the specifications of the manufacturer, the EUT must comply with the requirements of the following standards:

- ♦ 47 CFR Part 2, 22(H), 24(E), 27(L)
- ♦ ANSI C63.26-2015
- ♦ FCC KDB 971168 D01 Power Meas. License Digital Systems v03r01
- ♦ FCC KDB 412172 D01 Determining ERP and EIRP v01r01

Remark:

1. All test items were verified and recorded according to the standards and without any deviation during the test.
2. This EUT has also been tested and complied with the requirements of FCC Part 15, Subpart B, recorded in a separate test report.



2 Test Configuration of Equipment Under Test

2.1 Test Mode

Antenna port conducted and radiated test items were performed according to KDB 971168 D01 Power Meas. License Digital Systems v03r01 with maximum output power.

Radiated measurements were performed with rotating EUT in different three orthogonal test planes to find the maximum emission.

Radiated emissions were investigated as following frequency range:

1. 30 MHz to 9000 MHz for GSM850 and WCDMA Band V
2. 30 MHz to 18000 MHz for WCDMA Band IV.
3. 30 MHz to 19100 MHz for GSM1900 and WCDMA Band II

All modes and data rates and positions were investigated.

Test modes are chosen to be reported as the worst case configuration below:

Test Modes		
Band	Radiated TCs	Conducted TCs
GSM 850	<ul style="list-style-type: none"> ■ GSM Link ■ EDGE 1 Tx slots Link 	<ul style="list-style-type: none"> ■ GSM Link ■ EDGE 1 Tx slots Link
GSM 1900	<ul style="list-style-type: none"> ■ GSM Link ■ EDGE 1 Tx slots Link 	<ul style="list-style-type: none"> ■ GSM Link ■ EDGE 1 Tx slots Link
WCDMA Band V	<ul style="list-style-type: none"> ■ RMC 12.2Kbps Link 	<ul style="list-style-type: none"> ■ RMC 12.2Kbps Link
WCDMA Band II	<ul style="list-style-type: none"> ■ RMC 12.2Kbps Link 	<ul style="list-style-type: none"> ■ RMC 12.2Kbps Link
WCDMA Band IV	<ul style="list-style-type: none"> ■ RMC 12.2Kbps Link 	<ul style="list-style-type: none"> ■ RMC 12.2Kbps Link

2.2 Connection Diagram of Test System

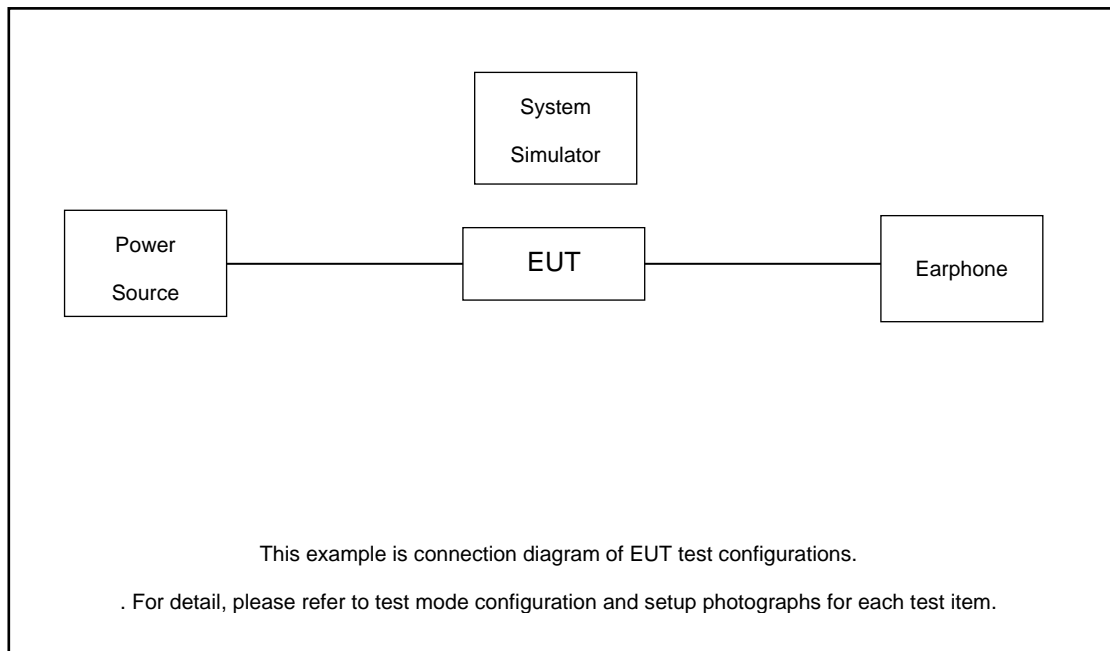

The EUT has been configuration operated in a manner tended to maximize its emission characteristics in a typical application.

2.3 Support Unit used in test configuration

Item	Equipment	Trade Name	Model No.	FCC ID	Data Cable	Power Cord
1.	System Simulator	R&S	CMU 200	N/A	N/A	Unshielded, 1.8 m
2.	System Simulator	Agilent	E5515C	N/A	N/A	Unshielded, 1.8 m



2.4 Measurement Results Explanation Example

For all conducted test items:

The offset level is set in the spectrum analyzer to compensate the RF cable loss and attenuator factor between RF conducted output port and spectrum analyzer. With the offset compensation, the spectrum analyzer reading level will be exactly the RF output level.

The spectrum analyzer offset is derived from RF cable loss and attenuator factor.

$$\text{Offset} = \text{RF cable loss} + \text{attenuator factor}.$$

The following shows an offset computation example with RF cable loss 5.0 dB and a 10dB attenuator.

Example :

$$\begin{aligned} \text{Offset(dB)} &= \text{RF cable loss(dB)} + \text{attenuator factor(dB)} \\ &= 5.0 + 10 = 15.0 \text{ (dB)} \end{aligned}$$

2.5 Frequency List of Low/Middle/High Channels

Frequency List				
Band	Channel/Frequency(MHz)	Lowest	Middle	Highest
GSM850	Channel	128	189	251
	Frequency	824.2	836.4	848.8
WCDMA Band V	Channel	4132	4182	4233
	Frequency	826.4	836.4	846.6
GSM1900	Channel	512	661	810
	Frequency	1850.2	1880.0	1909.8
WCDMA Band II	Channel	9262	9400	9538
	Frequency	1852.4	1880.0	1907.6
WCDMA Band IV	Channel	1312	1413	1513
	Frequency	1712.4	1732.6	1752.6
	Frequency	1851.25	1880.0	1908.75

3 Conducted Test Result

3.1 Measuring Instruments

See list of measuring instruments of this test report.

3.2 Test Setup

3.2.1 Conducted Output Power

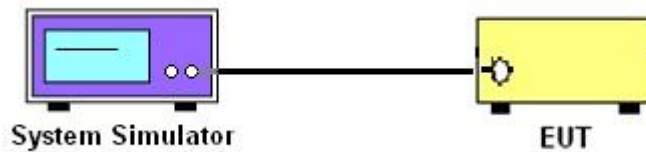

3.2.2 Peak-to-Average Ratio, Occupied Bandwidth, Conducted Band-Edge and Conducted Spurious Emission

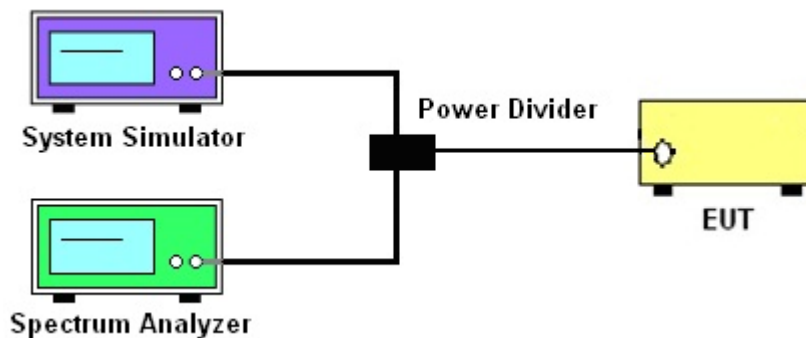

3.2.3 Frequency Stability

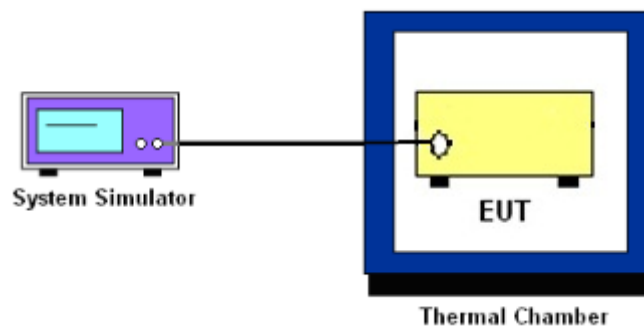

3.3 Test Result of Conducted Test

Please refer to Appendix A.



3.4 Conducted Output Power and ERP/EIRP

3.4.1 Description of the Conducted Output Power and ERP/EIRP

A system simulator was used to establish communication with the EUT. Its parameters were set to enforce EUT transmitting at the maximum power. The measured power in the radio frequency on the transmitter output terminals shall be reported.

The ERP of mobile transmitters must not exceed 7 Watts for GSM850 and WCDMA Band V.

The EIRP of mobile transmitters must not exceed 2 Watts for GSM1900 and WCDMA Band II.

The EIRP of mobile transmitters must not exceed 1 Watts for WCDMA Band IV.

According to KDB 412172 D01 Power Approach,

$EIRP = P_T + G_T - L_C$, $ERP = EIRP - 2.15$, where

P_T = transmitter output power in dBm

G_T = gain of the transmitting antenna in dBi

L_C = signal attenuation in the connecting cable between the transmitter and antenna in dB

3.4.2 Test Procedures

1. The testing follows ANSI C63.26 Section 5.2
2. The transmitter output port was connected to the system simulator.
3. Set EUT at maximum power through the system simulator.
4. Select lowest, middle, and highest channels for each band and different modulation.
5. Measure and record the power level from the system simulator.



3.5 Peak-to-Average Ratio

3.5.1 Description of the PAR Measurement

The peak-to-average ratio (PAR) of the transmission may not exceed 13 dB.

3.5.2 Test Procedures

1. The testing follows ANSI C63.26 Section 5.2.3.4 (CCDF).
2. The EUT was connected to spectrum and system simulator via a power divider.
3. Set the CCDF (Complementary Cumulative Distribution Function) option in spectrum analyzer.
4. The highest RF powers were measured and recorded the maximum PAPR level associated with a probability of 0.1 %.
5. Record the deviation as Peak to Average Ratio.



3.6 99% Occupied Bandwidth and 26dB Bandwidth Measurement

3.6.1 Description of 99% Occupied Bandwidth and 26dB Bandwidth Measurement

The occupied bandwidth is the width of a frequency band such that, below the lower and above the upper frequency limits, the mean powers emitted are each equal to a specified percentage 0.5% of the total mean transmitted power.

The 26 dB emission bandwidth is defined as the frequency range between two points, one above and one below the carrier frequency, at which the spectral density of the emission is attenuated 26 dB below the maximum in-band spectral density of the modulated signal. Spectral density (power per unit bandwidth) is to be measured with a detector of resolution bandwidth equal to approximately 1.0% of the emission bandwidth.

3.6.2 Test Procedures

1. The testing follows ANSI C63.26 Section 5.4
2. The EUT was connected to spectrum analyzer and system simulator via a power divider.
3. The spectrum analyzer center frequency is set to the nominal EUT channel center frequency. The span range for the spectrum analyzer shall be between two and five times the anticipated OBW.
4. The nominal resolution bandwidth (RBW) shall be in the range of 1 to 5 % of the anticipated OBW, and the VBW shall be at least 3 times the RBW.
5. Set the detection mode to peak, and the trace mode to max hold.
6. Determine the reference value: Set the EUT to transmit a modulated signal. Allow the trace to stabilize. Set the spectrum analyzer marker to the highest level of the displayed trace. (this is the reference value)
7. Determine the “-26 dB down amplitude” as equal to (Reference Value – X).
8. Place two markers, one at the lowest and the other at the highest frequency of the envelope of the spectral display such that each marker is at or slightly below the “-X dB down amplitude” determined in step 6. If a marker is below this “-X dB down amplitude” value it shall be placed as close as possible to this value. The OBW is the positive frequency difference between the two markers.
9. Use the 99 % power bandwidth function of the spectrum analyzer and report the measured bandwidth.



3.7 Conducted Band Edge

3.7.1 Description of Conducted Band Edge Measurement

The power of any emission outside of the authorized operating frequency ranges must be lower than the transmitter power (P) by a factor of at least $43 + 10 \log (P)$ dB.

3.7.2 Test Procedures

1. The testing follows ANSI C63.26 section 5.7
2. The EUT was connected to the spectrum analyzer and system simulator via a power divider.
3. The RF output of EUT was connected to the spectrum analyzer by an RF cable and attenuator. The path loss was compensated to the results for each measurement.
4. The band edges of low and high channels for the highest RF powers were measured.
5. The RF fundamental frequency should be excluded against the limit line in the operating frequency band.
6. The limit line is derived from $43 + 10\log(P)$ dB below the transmitter power P(Watts)



3.8 Conducted Spurious Emission

3.8.1 Description of Conducted Spurious Emission Measurement

The power of any emission outside of the authorized operating frequency ranges must be lower than the transmitter power (P) by a factor of at least $43 + 10 \log (P)$ dB.

It is measured by means of a calibrated spectrum analyzer and scanned from 30 MHz up to a frequency including its 10th harmonic.

3.8.2 Test Procedures

1. The testing follows ANSI C63.26 section 5.7
2. The EUT was connected to the spectrum analyzer and system simulator via a power divider.
3. The RF output of EUT was connected to the spectrum analyzer by an RF cable and attenuator. The path loss was compensated to the results for each measurement.
4. The middle channel for the highest RF power within the transmitting frequency was measured.
5. The conducted spurious emission for the whole frequency range was taken.
6. The RF fundamental frequency should be excluded against the limit line in the operating frequency band.
7. The limit line is derived from $43 + 10\log(P)$ dB below the transmitter power P(Watts)



3.9 Frequency Stability

3.9.1 Description of Frequency Stability Measurement

The frequency stability shall be measured by variation of ambient temperature and variation of primary supply voltage to ensure that the fundamental emission stays within the authorized frequency block. The frequency stability of the transmitter shall be maintained within $\pm 0.00025\%$ ($\pm 2.5\text{ppm}$) of the center frequency.

3.9.2 Test Procedures for Temperature Variation

1. The testing follows ANSI C63.26 section 5.6.4
2. The EUT was set up in the thermal chamber and connected with the system simulator.
3. With power OFF, the temperature was decreased to -30°C and the EUT was stabilized before testing. Power was applied and the maximum change in frequency was recorded within one minute.
4. With power OFF, the temperature was raised in 10°C step up to 50°C . The EUT was stabilized at each step for at least half an hour. Power was applied and the maximum frequency change was recorded within one minute.

3.9.3 Test Procedures for Voltage Variation

1. The testing follows ANSI C63.26 section 5.6.5
2. The EUT was placed in a temperature chamber at $20\pm 5^{\circ}\text{C}$ and connected with the system simulator.
3. The power supply voltage to the EUT was varied from 85% to 115% of the nominal value for other than hand carried battery equipment.
4. For hand carried, battery powered equipment, reduce the primary ac or dc supply voltage to the battery operating end point, which shall be specified by the manufacturer.
5. The variation in frequency was measured for the worst case.

4 Radiated Test Items

4.1 Measuring Instruments

See list of measuring instruments of this test report.

4.2 Test Setup

4.2.1 For radiated test below 30MHz

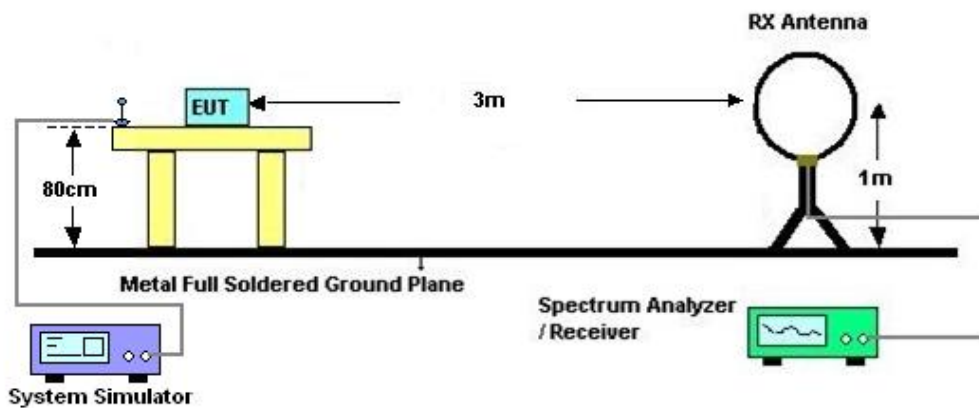

4.2.2 For radiated test from 30MHz to 1GHz

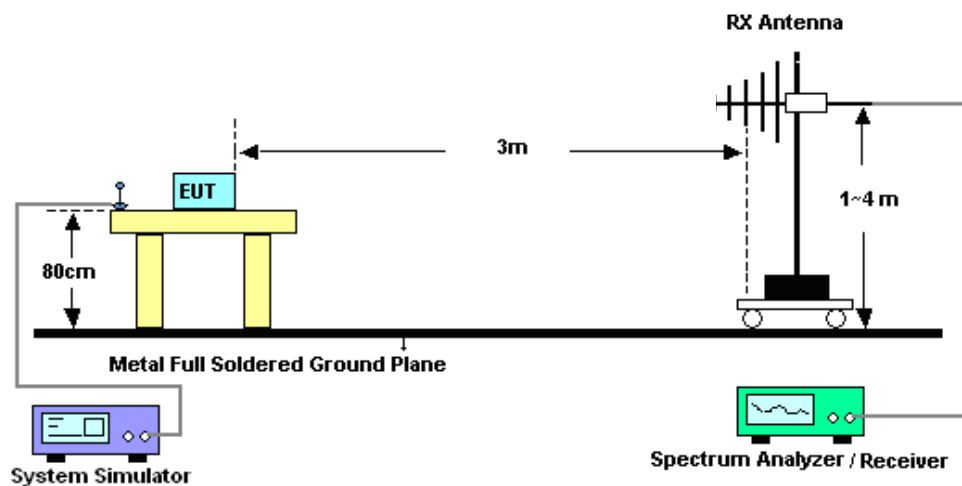

4.2.3 For radiated test above 1GHz

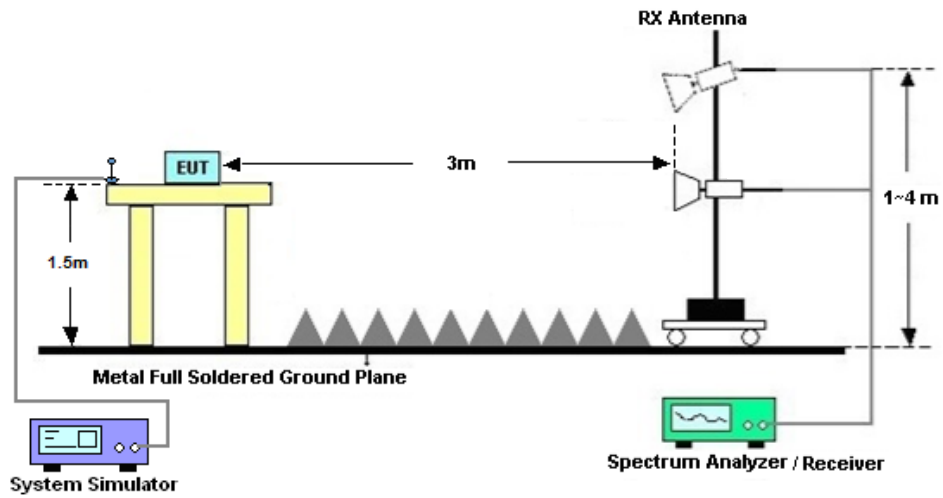

4.3 Test Result of Radiated Test

The low frequency, which started from 9 kHz to 30MHz, was pre-scanned and the result which was 20dB lower than the limit line was not reported.

Please refer to Appendix B.



4.4 Field Strength of Spurious Radiation Measurement

4.4.1 Description of Field Strength of Spurious Radiated Measurement

The power of any emission outside of the authorized operating frequency ranges must be attenuated below the transmitter power (P) by a factor of at least $43 + 10 \log (P)$ dB. The spectrum is scanned from 30 MHz up to a frequency including its 10th harmonic.

4.4.2 Test Procedures

1. The testing follows ANSI C63.26 Section 5.5
2. The EUT was placed on a rotatable wooden table 0.8 meters for frequency below 1GHz and 1.5 meter for frequency above 1GHz above the ground.
3. The EUT was set 3 meters from the receiving antenna, which was mounted on the antenna tower.
4. The table was rotated 360 degrees to determine the position of the highest spurious emission.
5. The height of the receiving antenna is varied between one meter and four meters to search for the maximum spurious emission for both horizontal and vertical polarizations.
6. Make the measurement with the spectrum analyzer's RBW = 1MHz, VBW = 3MHz, taking record of maximum spurious emission.
7. A horn antenna was substituted in place of the EUT and was driven by a signal generator.
8. Tune the output power of signal generator to the same emission level with EUT maximum spurious emission.
9. Taking the record of output power at antenna port.
10. Repeat step 7 to step 8 for another polarization.
11. $EIRP \text{ (dBm)} = S.G. \text{ Power} - Tx \text{ Cable Loss} + Tx \text{ Antenna Gain}$
12. $ERP \text{ (dBm)} = EIRP - 2.15$
13. The RF fundamental frequency should be excluded against the limit line in the operating frequency band.
14. The limit line is derived from $43 + 10\log(P)$ dB below the transmitter power P(Watts)



5 List of Measuring Equipment

Instrument	Manufacturer	Model No.	Serial No.	Characteristics	Calibration Date	Test Date	Due Date	Remark
Spectrum Analyzer	R&S	FSV40	101040	10Hz~40GHz	Oct. 11, 2023	Nov. 03, 2023~Nov. 07, 2023	Oct. 10, 2024	Conducted (TH01-KS)
Power divider	STI	STI08-0055	-	0.5~40GHz	NCR	Nov. 03, 2023~Nov. 07, 2023	NCR	Conducted (TH01-KS)
Temperature & humidity chamber	Hongzhan	LP-150U	H2014011440	-40~+150°C 20%~95%RH	Jul. 06, 2023	Nov. 03, 2023~Nov. 07, 2023	Jul. 05, 2024	Conducted (TH01-KS)
EMI Test Receiver	Keysight	N9038A	MY56400004	3Hz~8.5GHz;Max 30dBm	Oct. 10, 2023	Nov. 23, 2023	Oct. 09, 2024	Radiation (03CH06-KS)
EXA Spectrum Analyzer	Keysight	N9010B	MY60242126	10Hz~44GHz	Oct. 10, 2023	Nov. 23, 2023	Oct. 09, 2024	Radiation (03CH06-KS)
Loop Antenna	R&S	HFH2-Z2	100321	9kHz~30MHz	Oct. 10, 2023	Nov. 23, 2023	Oct. 09, 2024	Radiation (03CH06-KS)
Bilog Antenna	TeseQ	CBL6111D	49921	30MHz~1GHz	Apr. 09, 2023	Nov. 23, 2023	Apr. 08, 2024	Radiation (03CH06-KS)
Double Ridge Horn Antenna	ETS-Lindgren	3117	00218652	1GHz~18GHz	Apr. 06, 2023	Nov. 23, 2023	Apr. 05, 2024	Radiation (03CH06-KS)
SHF-EHF Horn	Com-power	AH-840	101093	18GHz~40GHz	Jan. 08, 2023	Nov. 23, 2023	Jan. 07, 2024	Radiation (03CH06-KS)
Amplifier	SONOMA	310N	380827	9KHz ~1GHZ	Jul. 06, 2023	Nov. 23, 2023	Jul. 05, 2024	Radiation (03CH06-KS)
Amplifier	MITEQ	EM18G40G GA	060728	18~40GHz	Jan. 05, 2023	Nov. 23, 2023	Jan. 04, 2024	Radiation (03CH06-KS)
high gain Amplifier	MITEQ	AMF-7D-00 101800-30-1 0P	2082395	1Ghz-18Ghz	Jan. 05, 2023	Nov. 23, 2023	Jan. 04, 2024	Radiation (03CH06-KS)
Amplifier	Keysight	83017A	MY53270319	500MHz~26.5GHz	Oct. 10, 2023	Nov. 23, 2023	Oct. 09, 2024	Radiation (03CH06-KS)
AC Power Source	Chroma	61601	F104090004	N/A	NCR	Nov. 23, 2023	NCR	Radiation (03CH06-KS)
Turn Table	ChamPro	EM 1000-T	060762-T	0~360 degree	NCR	Nov. 23, 2023	NCR	Radiation (03CH06-KS)
Antenna Mast	ChamPro	EM 1000-A	060762-A	1 m~4 m	NCR	Nov. 23, 2023	NCR	Radiation (03CH06-KS)
EXA Spectrum Analyzer	Keysight	N9010A	MY55150244	10Hz~44GHz	May 15, 2023	Nov. 23, 2023	May 14, 2024	Radiation (03CH05-KS)
Loop Antenna	R&S	HFH2-Z2	100321	9kHz~30MHz	Oct. 10, 2023	Nov. 23, 2023	Oct. 09, 2024	Radiation (03CH05-KS)
Bilog Antenna	TeseQ	CBL6111D	49922	30MHz~1GHz	Apr. 09, 2023	Nov. 23, 2023	Apr. 08, 2024	Radiation (03CH05-KS)
Double Ridge Horn Antenna	ETS-Lindgren	3117	00218642	1GHz~18GHz	Apr. 06, 2023	Nov. 23, 2023	Apr. 05, 2024	Radiation (03CH05-KS)
SHF-EHF Horn	Com-power	AH-840	101093	18GHz~40GHz	Jan. 08, 2023	Nov. 23, 2023	Jan. 07, 2024	Radiation (03CH05-KS)
Amplifier	SONOMA	310N	380826	9KHz-1GHz	Jul. 06, 2023	Nov. 23, 2023	Jul. 05, 2024	Radiation (03CH05-KS)
Amplifier	EM	EM18G40G A	060852	18~40GHz	Jan. 05, 2023	Nov. 23, 2023	Jan. 04, 2024	Radiation (03CH05-KS)
high gain Amplifier	EM	EM01G18G A	060839	1Ghz-18Ghz	Oct. 10, 2023	Nov. 23, 2023	Oct. 09, 2024	Radiation (03CH05-KS)
Amplifier	EM	EM01G18G A	060833	1Ghz-18Ghz	Jan. 05, 2023	Nov. 23, 2023	Jan. 04, 2024	Radiation (03CH05-KS)
AC Power Source	Chroma	61601	F104090004	N/A	NCR	Nov. 23, 2023	NCR	Radiation (03CH05-KS)
Turn Table	ChamPro	EM 1000-T	060762-T	0~360 degree	NCR	Nov. 23, 2023	NCR	Radiation (03CH05-KS)
Antenna Mast	ChamPro	EM 1000-A	060762-A	1 m~4 m	NCR	Nov. 23, 2023	NCR	Radiation (03CH05-KS)

NCR: No Calibration Required



6 Measurement Uncertainty

The measurement uncertainties shown below were calculated in accordance with the requirements of ANSI 63.26-2015. All the measurement uncertainty value were shown with a coverage K=2 to indicate 95% level of confidence. The measurement data show herein meets or exceeds the CISPR measurement uncertainty values specified in CISPR 16-4-2 and can be compared directly to specified limit to determine compliance.

Uncertainty of Conducted Measurement

Conducted Spurious Emission & Bandedge	±2.26 dB
Occupied Channel Bandwidth	±0.1%
Conducted Power	±0.46 dB
Peak to Average Ratio	±0.46 dB
Frequency Stability	±0.4 Hz

03CH05-KS

Uncertainty of Radiated Emission Measurement (9 KHz ~ 30 MHz)

Measuring Uncertainty for a Level of Confidence of 95% (U = 2Uc(y))	3.8 dB
---	--------

Uncertainty of Radiated Emission Measurement (30 MHz ~ 1000 MHz)

Measuring Uncertainty for a Level of Confidence of 95% (U = 2Uc(y))	3.5 dB
---	--------

Uncertainty of Radiated Emission Measurement (1 GHz ~ 40 GHz)

Measuring Uncertainty for a Level of Confidence of 95% (U = 2Uc(y))	3.4 dB
---	--------

03CH06-KS

Uncertainty of Radiated Emission Measurement (9 KHz ~ 30 MHz)

Measuring Uncertainty for a Level of Confidence of 95% (U = 2Uc(y))	3.8 dB
---	--------

Uncertainty of Radiated Emission Measurement (30 MHz ~ 1000 MHz)

Measuring Uncertainty for a Level of Confidence of 95% (U = 2Uc(y))	3.5 dB
---	--------

Uncertainty of Radiated Emission Measurement (1 GHz ~ 40 GHz)

Measuring Uncertainty for a Level of Confidence of 95% (U = 2Uc(y))	3.5 dB
---	--------



Appendix A. Test Results of Conducted Test

Test Engineer :	Smile Wang	Temperature :	22~23°C
		Relative Humidity :	40~42%

Conducted Output Power(Average power) and ERP/EIRP

GSM850 TX Channel	Burst Average Power (dBm)			ERP(W)		
	128	189	251	L	M	H
Frequency (MHz)	824.2	836.4	848.8			
GSM 1 Tx slot	32.69	32.71	32.55	0.5058	0.5082	0.4898
GPRS 1 Tx slot	32.60	32.66	32.48	0.4955	0.5023	0.4819
GPRS 2 Tx slots	31.07	31.10	30.95	0.3483	0.3508	0.3388
GPRS 3 Tx slots	28.87	28.92	28.81	0.2099	0.2123	0.2070
GPRS 4 Tx slots	26.91	26.96	26.73	0.1337	0.1352	0.1282
EDGE 1 Tx slot	26.62	26.45	26.66	0.1250	0.1202	0.1262
EDGE 2 Tx slots	24.65	24.65	24.55	0.0794	0.0794	0.0776
EDGE 3 Tx slots	22.61	22.88	22.59	0.0497	0.0528	0.0494
EDGE 4 Tx slots	20.55	20.67	20.56	0.0309	0.0318	0.0310

GSM1900 TX Channel	Burst Average Power (dBm)			EIRP(W)		
	512	661	810	L	M	H
Frequency (MHz)	1850.2	1880	1909.8			
GSM 1 Tx slot	29.48	29.88	29.90	0.7907	0.8670	0.8710
GPRS 1 Tx slot	29.71	29.76	29.82	0.8337	0.8433	0.8551
GPRS 2 Tx slots	28.22	28.42	28.11	0.5916	0.6194	0.5768
GPRS 3 Tx slots	25.82	25.88	25.71	0.3404	0.3451	0.3319
GPRS 4 Tx slots	23.74	23.95	23.93	0.2109	0.2213	0.2203
EDGE 1 Tx slot	25.88	26.01	25.97	0.3451	0.3556	0.3524
EDGE 2 Tx slots	23.77	24.11	24.02	0.2123	0.2296	0.2249
EDGE 3 Tx slots	21.75	22.03	22.09	0.1334	0.1422	0.1442
EDGE 4 Tx slots	19.88	19.95	19.62	0.0867	0.0881	0.0817



Band	WCDMA V			ERP(W)		
	TX Channel	4132	4182			
Rx Channel	4357	4407	4458			
Frequency (MHz)	826.4	836.4	846.6	L	M	H
AMR 12.2Kbps	22.91	22.95	22.94	0.0532	0.0537	0.0536
RMC 12.2Kbps	22.96	23.00	22.98	0.0538	0.0543	0.0541
HSDPA Subtest-1	21.83	21.96	21.97	0.0415	0.0428	0.0429
HSDPA Subtest-2	21.81	21.96	21.90	0.0413	0.0428	0.0422
HSDPA Subtest-3	21.35	21.38	21.25	0.0372	0.0374	0.0363
HSDPA Subtest-4	21.38	21.38	21.37	0.0374	0.0374	0.0373
DC-HSDPA Subtest-1	21.78	21.97	21.75	0.0410	0.0429	0.0407
DC-HSDPA Subtest-2	21.69	21.85	21.71	0.0402	0.0417	0.0404
DC-HSDPA Subtest-3	21.29	21.47	21.38	0.0366	0.0382	0.0374
DC-HSDPA Subtest-4	21.28	21.29	21.27	0.0366	0.0366	0.0365
HSUPA Subtest-1	21.77	21.92	21.79	0.0409	0.0424	0.0411
HSUPA Subtest-2	19.69	19.82	19.61	0.0254	0.0261	0.0249
HSUPA Subtest-3	20.96	20.98	20.85	0.0340	0.0341	0.0331
HSUPA Subtest-4	19.85	20.03	19.85	0.0263	0.0274	0.0263
HSUPA Subtest-5	21.78	21.88	21.80	0.0410	0.0420	0.0412
HSPA+ (16QAM) Subtest-1	19.33	19.39	19.14	0.0233	0.0237	0.0223

Band	WCDMA IV			EIRP(W)		
	TX Channel	1312	1413			
Rx Channel	1537	1638	1738			
Frequency (MHz)	1712.4	1732.6	1752.6	L	M	H
AMR 12.2Kbps	22.75	22.81	22.66	0.1641	0.1663	0.1607
RMC 12.2Kbps	22.77	22.85	22.70	0.1648	0.1679	0.1622
HSDPA Subtest-1	21.77	21.81	21.84	0.1309	0.1321	0.1330
HSDPA Subtest-2	21.76	21.83	21.78	0.1306	0.1327	0.1312
HSDPA Subtest-3	21.25	21.32	21.17	0.1161	0.1180	0.1140
HSDPA Subtest-4	21.29	21.30	21.23	0.1172	0.1175	0.1156
DC-HSDPA Subtest-1	21.65	21.81	21.70	0.1274	0.1321	0.1288
DC-HSDPA Subtest-2	21.55	21.78	21.61	0.1245	0.1312	0.1262
DC-HSDPA Subtest-3	21.19	21.37	21.24	0.1146	0.1194	0.1159
DC-HSDPA Subtest-4	21.23	21.22	21.20	0.1156	0.1153	0.1148
HSUPA Subtest-1	21.69	21.80	21.66	0.1285	0.1318	0.1276
HSUPA Subtest-2	19.61	19.76	19.57	0.0796	0.0824	0.0789
HSUPA Subtest-3	20.81	20.89	20.77	0.1050	0.1069	0.1040
HSUPA Subtest-4	19.75	19.88	19.78	0.0822	0.0847	0.0828
HSUPA Subtest-5	21.66	21.75	21.66	0.1276	0.1303	0.1276
HSPA+ (16QAM) Subtest-1	19.19	19.29	19.10	0.0723	0.0740	0.0708



Band	WCDMA II			EIRP(W)		
	TX Channel	9262	9400			
Rx Channel	9662	9800	9938			
Frequency (MHz)	1852.4	1880	1907.6	L	M	H
AMR 12.2Kbps	22.94	22.97	22.92	0.1754	0.1766	0.1746
RMC 12.2Kbps	22.99	23.01	22.96	0.1774	0.1782	0.1762
HSDPA Subtest-1	21.96	22.05	21.98	0.1400	0.1429	0.1406
HSDPA Subtest-2	21.92	22.02	21.94	0.1387	0.1419	0.1393
HSDPA Subtest-3	21.49	21.56	21.43	0.1256	0.1276	0.1239
HSDPA Subtest-4	21.43	21.51	21.40	0.1239	0.1262	0.1230
DC-HSDPA Subtest-1	21.88	21.99	21.91	0.1374	0.1409	0.1384
DC-HSDPA Subtest-2	21.81	21.94	21.85	0.1352	0.1393	0.1365
DC-HSDPA Subtest-3	21.37	21.52	21.45	0.1222	0.1265	0.1245
DC-HSDPA Subtest-4	21.43	21.47	21.42	0.1239	0.1250	0.1236
HSUPA Subtest-1	21.92	21.98	21.83	0.1387	0.1406	0.1358
HSUPA Subtest-2	19.85	19.92	19.83	0.0861	0.0875	0.0857
HSUPA Subtest-3	20.96	21.06	20.97	0.1112	0.1138	0.1114
HSUPA Subtest-4	19.93	20.03	19.95	0.0877	0.0897	0.0881
HSUPA Subtest-5	21.81	21.91	21.85	0.1352	0.1384	0.1365
HSPA+ (16QAM) Subtest-1	19.35	19.44	19.29	0.0767	0.0783	0.0757



A1. GSM

Peak-to-Average Ratio

Mode	GSM850		Limit: 13dB
Mod.	GSM	EDGE class 8	Result
Lowest CH	0.20	3.16	PASS
Middle CH	0.14	3.10	
Highest CH	0.17	3.33	

Mode	GSM1900		Limit: 13dB
Mod.	GSM	EDGE class 8	Result
Lowest CH	0.23	3.16	PASS
Middle CH	0.29	3.16	
Highest CH	0.38	3.01	



GSM850 (GSM)

Lowest Channel

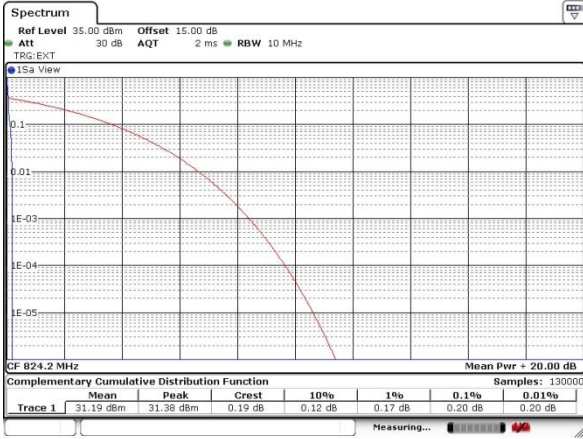

Date: 3.NOV.2023 16:43:57

GSM850 (EDGE class 8)

Lowest Channel

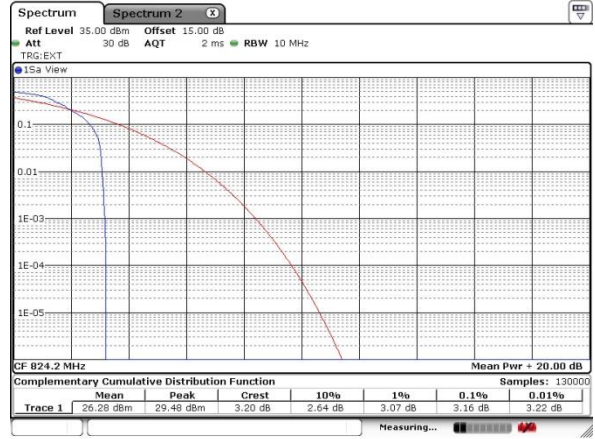

Date: 7.NOV.2023 15:27:35

Middle Channel

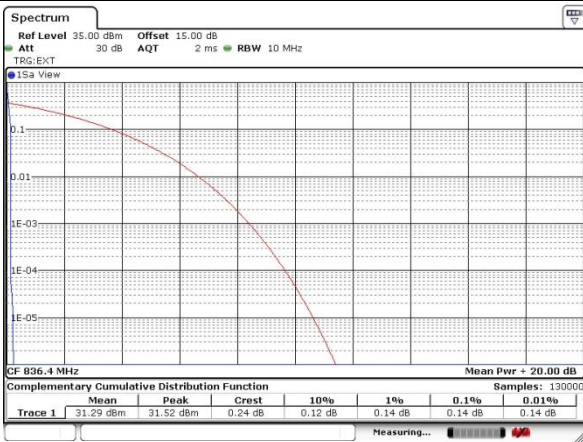

Date: 3.NOV.2023 16:44:12

Middle Channel

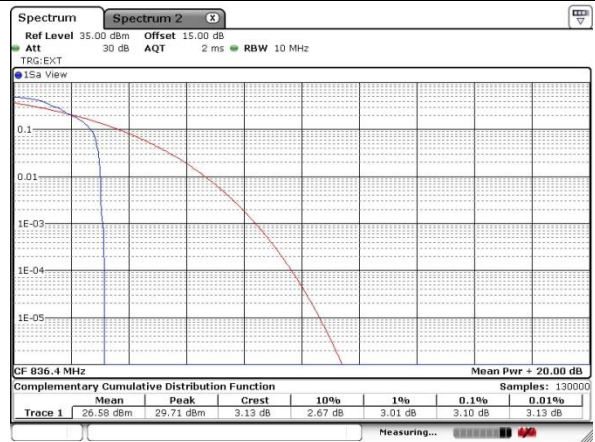

Date: 7.NOV.2023 15:27:48

Highest Channel

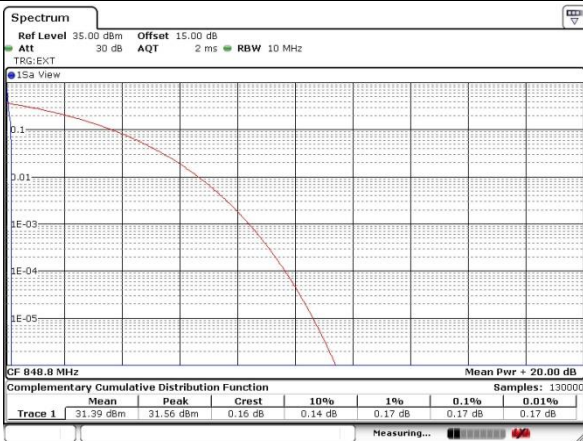

Date: 3.NOV.2023 16:44:31

Highest Channel

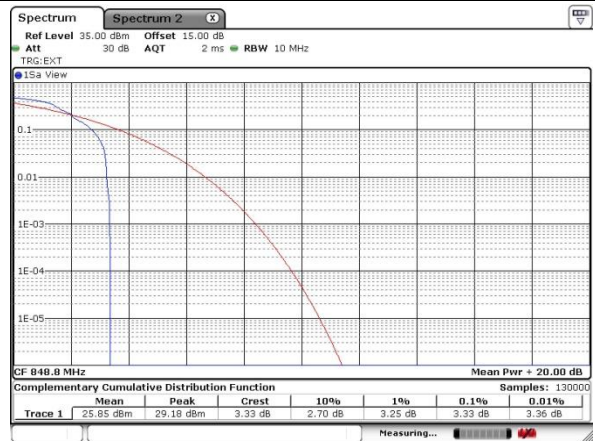

Date: 7.NOV.2023 15:28:00



GSM1900 (GSM)

Lowest Channel

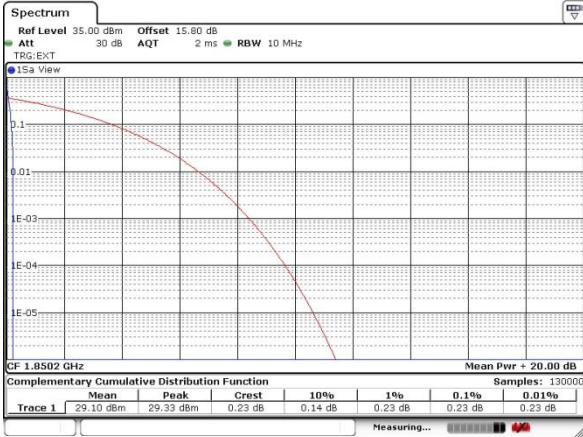

Date: 3.NOV.2023 17:24:11

GSM1900 (EDGE class 8)

Lowest Channel

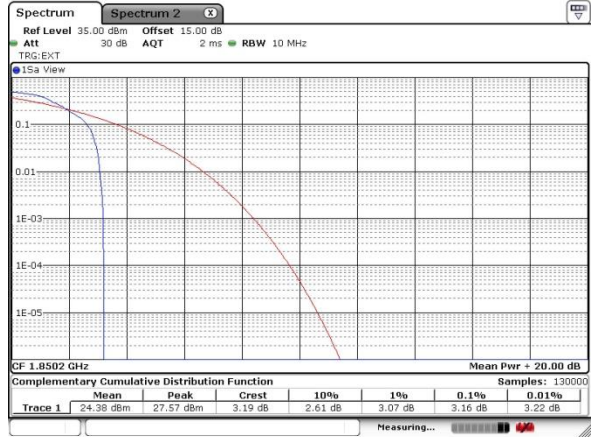

Date: 7.NOV.2023 15:07:14

Middle Channel

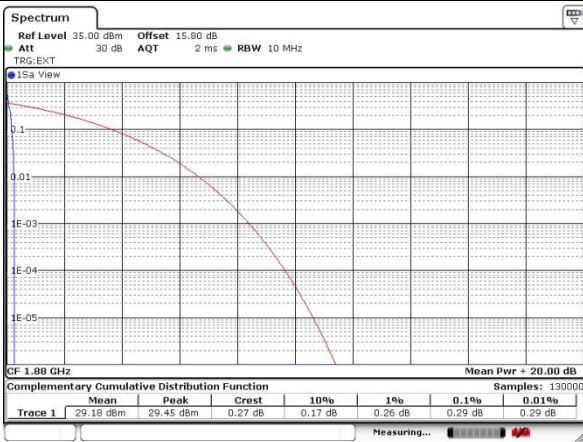

Date: 3.NOV.2023 17:24:25

Middle Channel



Date: 7.NOV.2023 15:07:40

Highest Channel

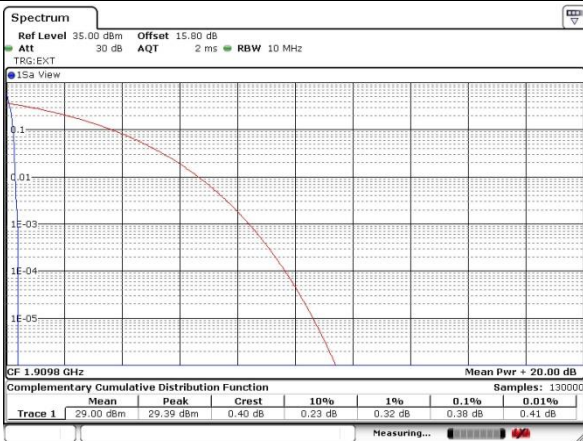

Date: 3.NOV.2023 17:24:36

Highest Channel

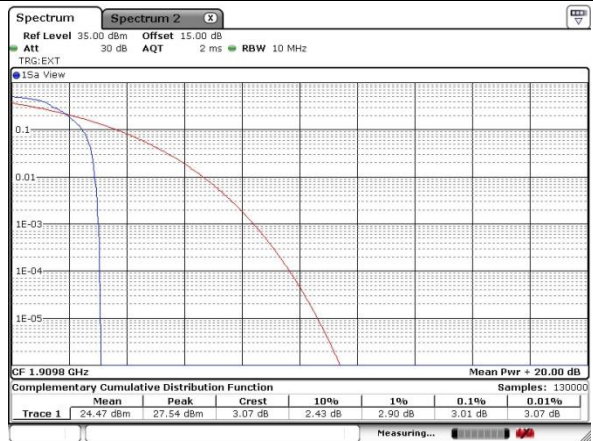

Date: 7.NOV.2023 15:09:22



26dB Bandwidth

Mode	GSM850	
Mod.	GSM	EDGE class 8
Lowest CH	0.312	0.314
Middle CH	0.315	0.314
Highest CH	0.315	0.313

Mode	GSM1900	
Mod.	GSM	EDGE class 8
Lowest CH	0.312	0.313
Middle CH	0.314	0.311
Highest CH	0.312	0.315



GSM850 (GSM)

Lowest Channel

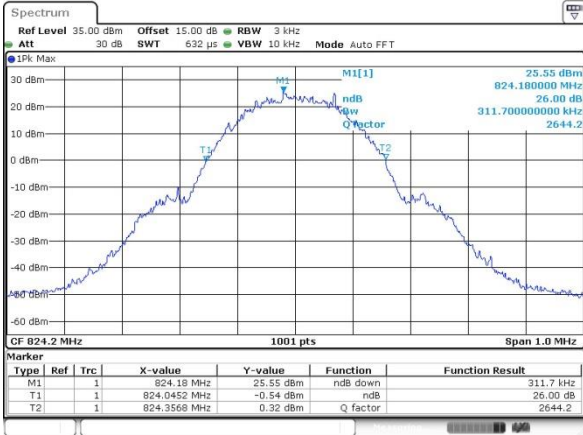

Date: 3.NOV.2023 16:40:57

GSM850 (EDGE class 8)

Lowest Channel

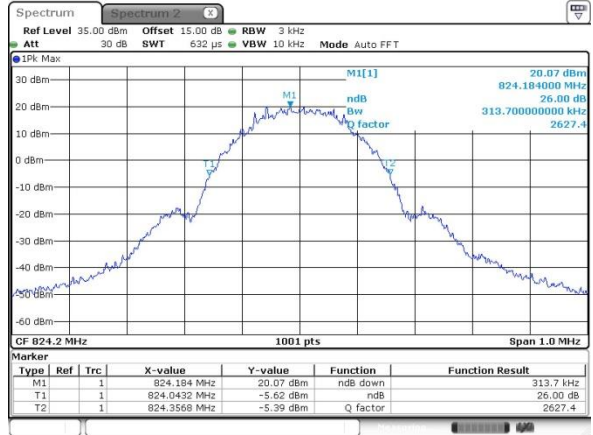

Date: 7.NOV.2023 15:21:00

Middle Channel

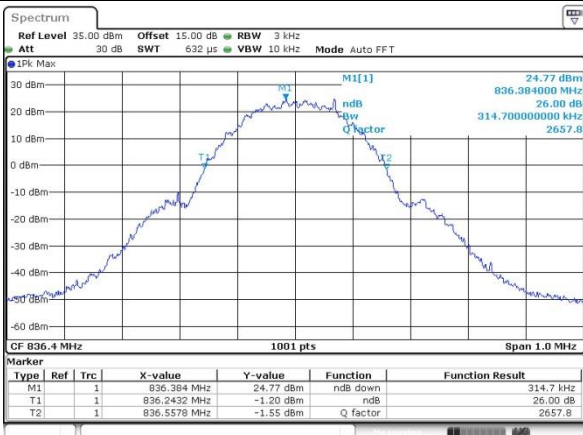

Date: 3.NOV.2023 16:41:22

Middle Channel

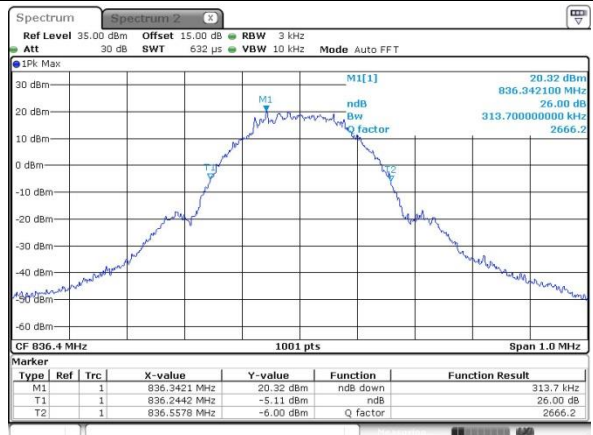

Date: 7.NOV.2023 15:21:21

Highest Channel

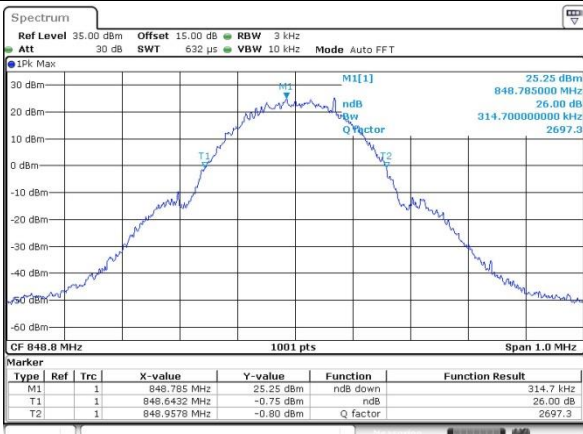

Date: 3.NOV.2023 16:41:47

Highest Channel

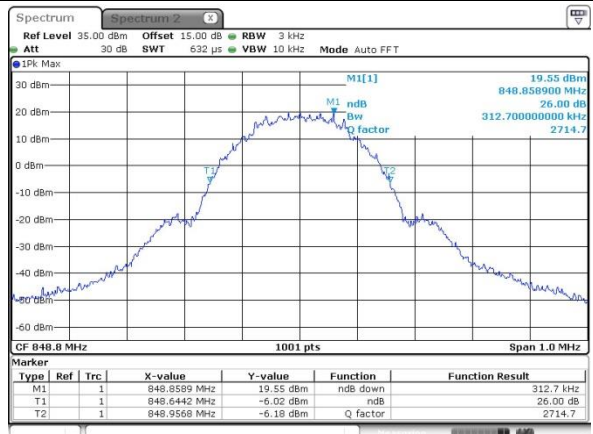

Date: 7.NOV.2023 15:21:43



GSM1900 (GSM)

Lowest Channel

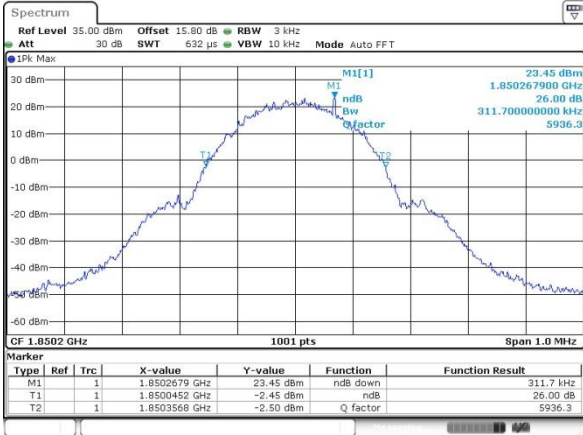

Date: 3.NOV.2023 17:05:55

GSM1900 (EDGE class 8)

Lowest Channel

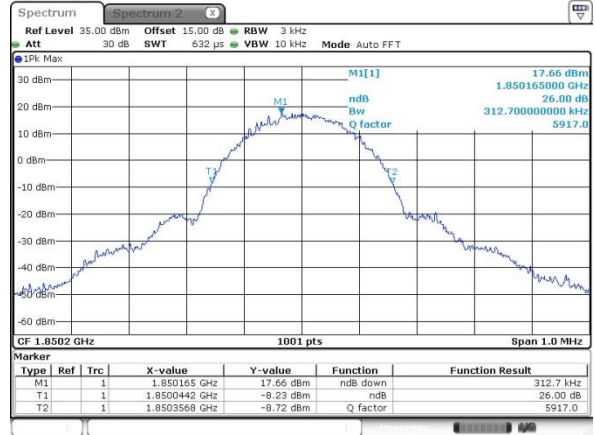

Date: 7.NOV.2023 14:59:52

Middle Channel

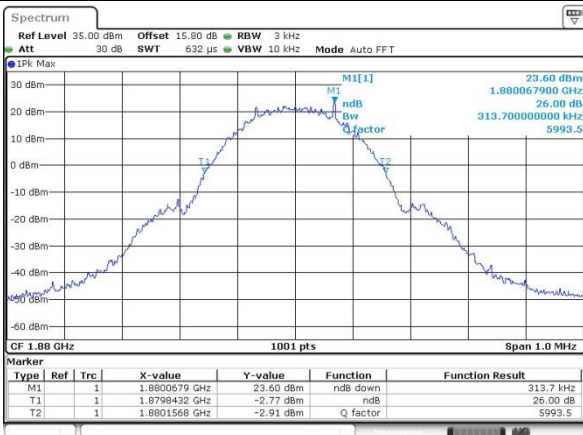

Date: 3.NOV.2023 17:06:28

Middle Channel

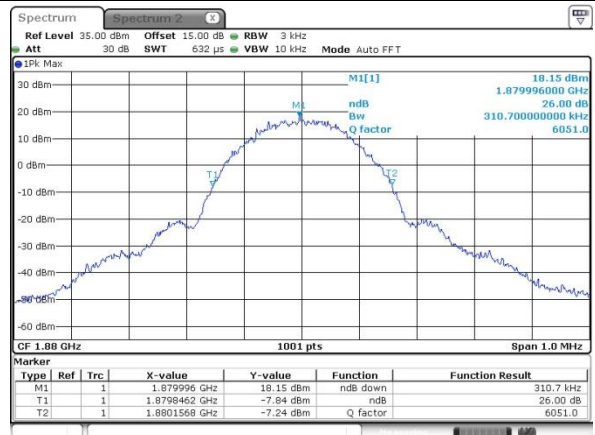

Date: 7.NOV.2023 15:00:13

Highest Channel

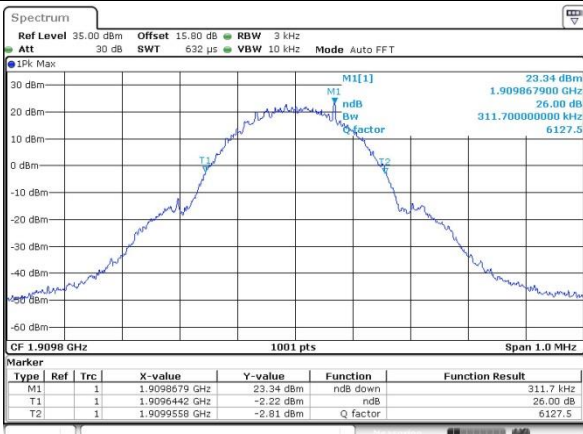

Date: 3.NOV.2023 17:06:50

Highest Channel



Date: 7.NOV.2023 15:00:36



Occupied Bandwidth

Mode	GSM850	
Mod.	GSM	EDGE class 8
Lowest CH	0.243	0.243
Middle CH	0.243	0.243
Highest CH	0.243	0.241

Mode	GSM1900	
Mod.	GSM	EDGE class 8
Lowest CH	0.240	0.248
Middle CH	0.242	0.244
Highest CH	0.241	0.251



GSM850 (GSM)

Lowest Channel



Date: 3.NOV.2023 16:42:19

GSM850 (EDGE class 8)

Lowest Channel



Date: 7.NOV.2023 15:22:37

Middle Channel

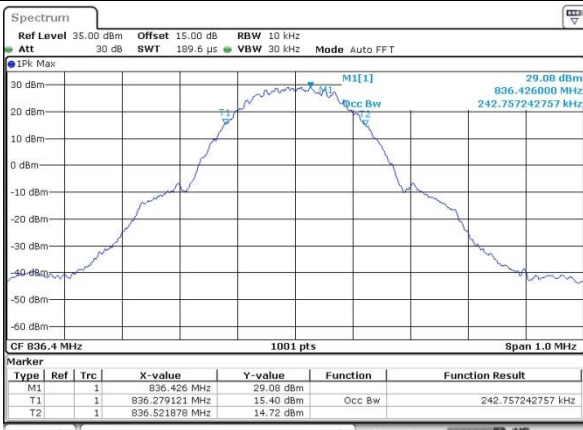

Date: 3.NOV.2023 16:42:42

Middle Channel

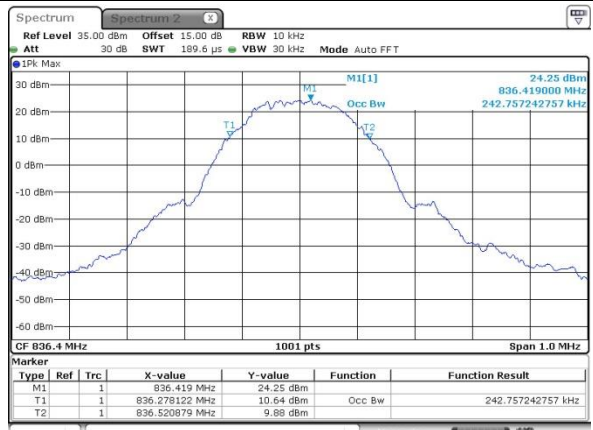

Date: 7.NOV.2023 15:22:59

Highest Channel

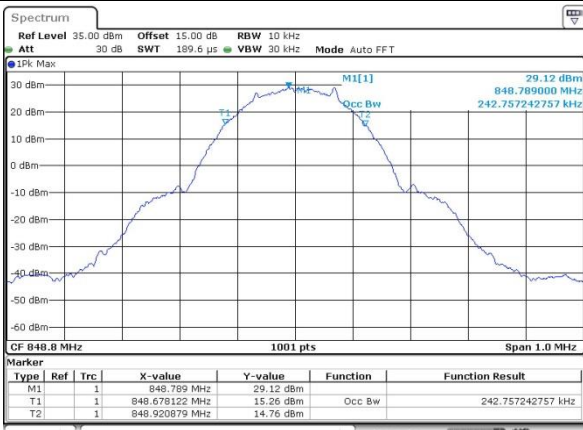

Date: 3.NOV.2023 16:43:03

Highest Channel

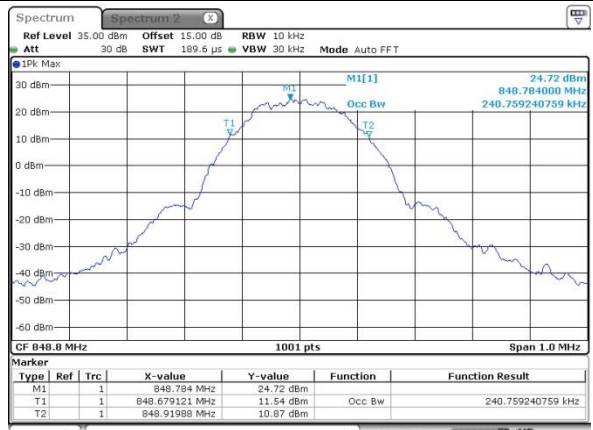

Date: 7.NOV.2023 15:23:20



GSM1900 (GSM)

Lowest Channel

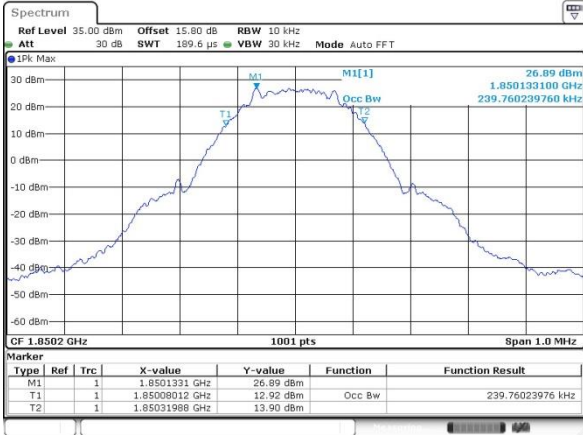

Date: 3.NOV.2023 17:07:15

GSM1900 (EDGE class 8)

Lowest Channel

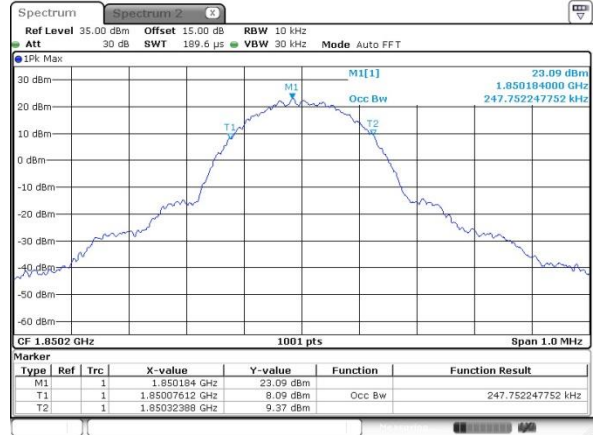

Date: 7.NOV.2023 15:01:02

Middle Channel

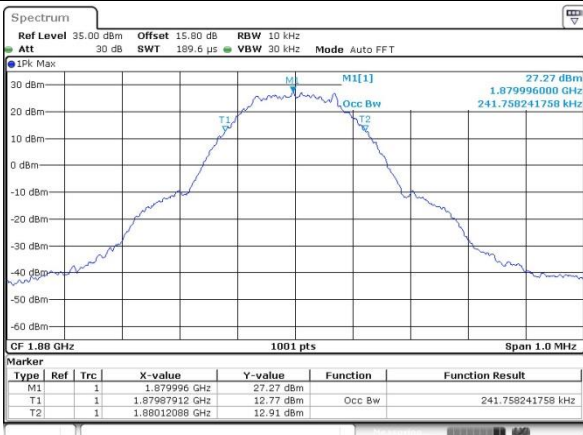

Date: 3.NOV.2023 17:35:05

Middle Channel

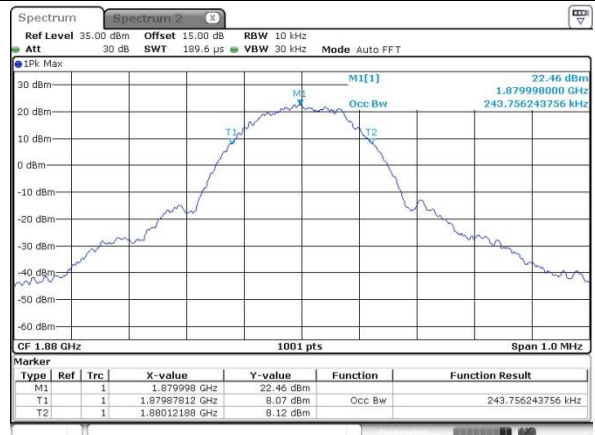

Date: 7.NOV.2023 15:01:24

Highest Channel



Date: 3.NOV.2023 17:07:57

Highest Channel



Date: 7.NOV.2023 15:01:47



Conducted Band Edge

GSM850 (GSM)

Lowest Band Edge

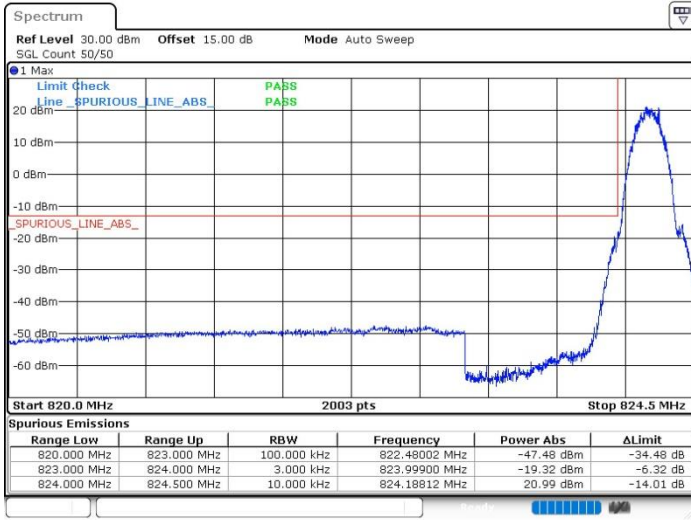

Date: 3.NOV.2023 16:47:57

Highest Band Edge

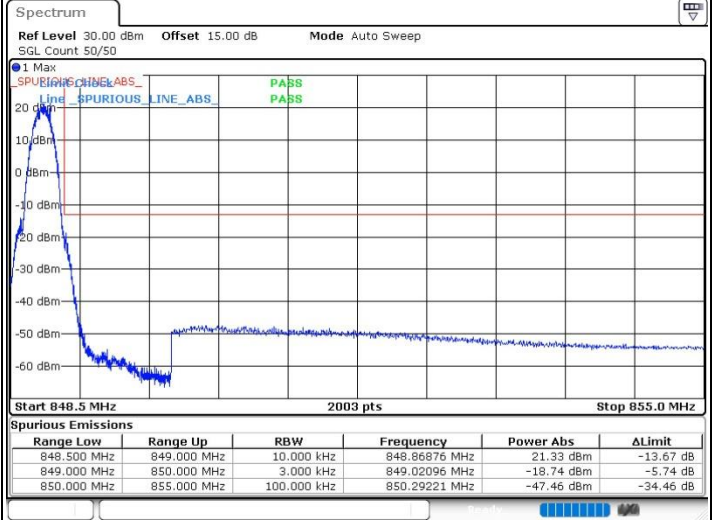

Date: 3.NOV.2023 16:49:24

GSM850 (EDGE class 8)

Lowest Band Edge

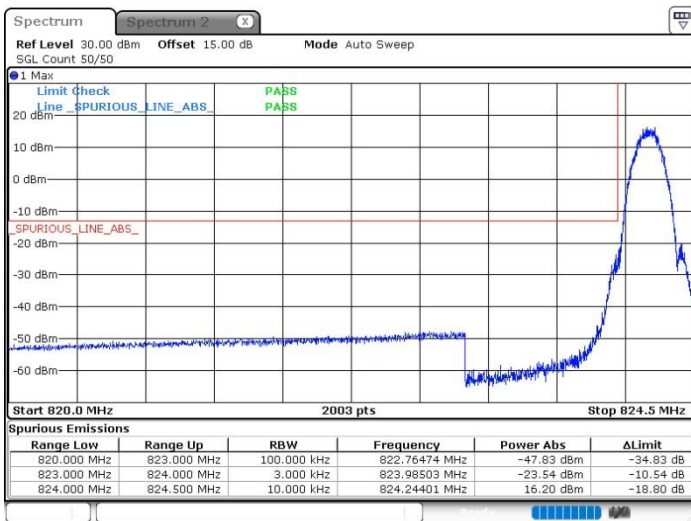

Date: 7.NOV.2023 15:25:03

Highest Band Edge

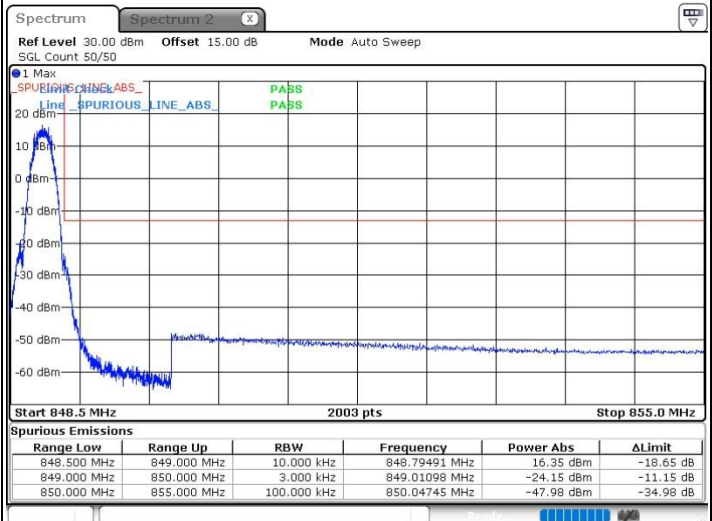

Date: 7.NOV.2023 15:26:56



GSM1900 (GSM)

Lowest Band Edge

Highest Band Edge

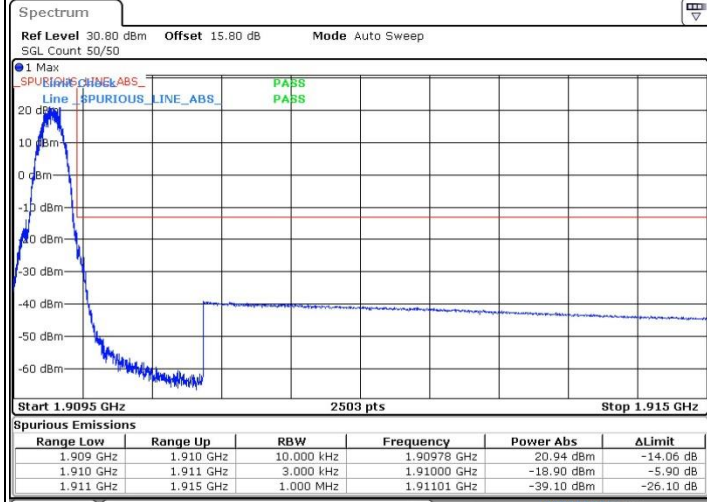
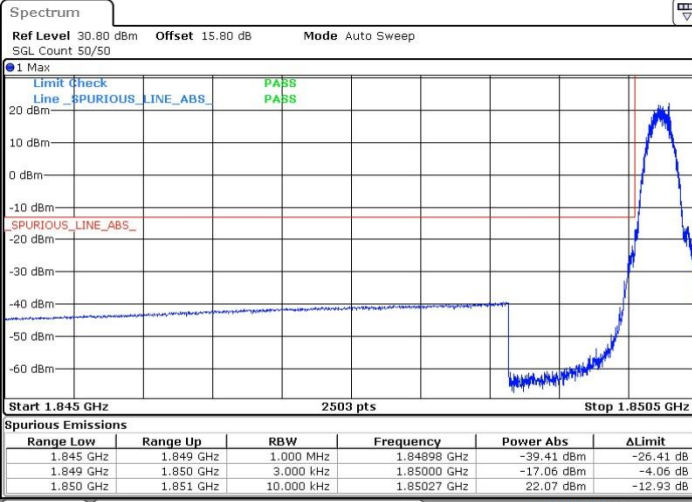

Date: 3.NOV.2023 17:17:27

Date: 3.NOV.2023 17:19:06

GSM1900 (EDGE class 8)

Lowest Band Edge

Highest Band Edge

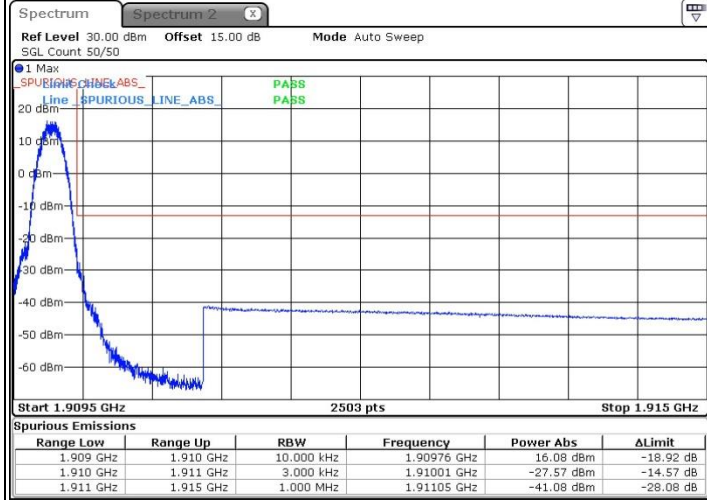
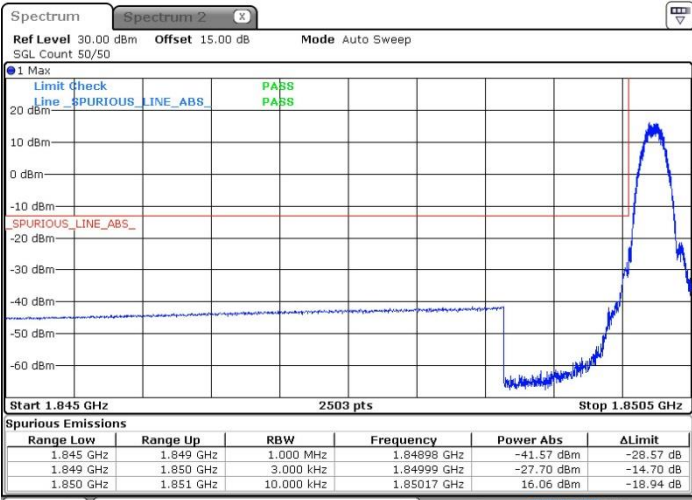

Date: 7.NOV.2023 15:03:30

Date: 7.NOV.2023 15:04:59



Conducted Spurious Emission

GSM850 (GSM)

Lowest Channel

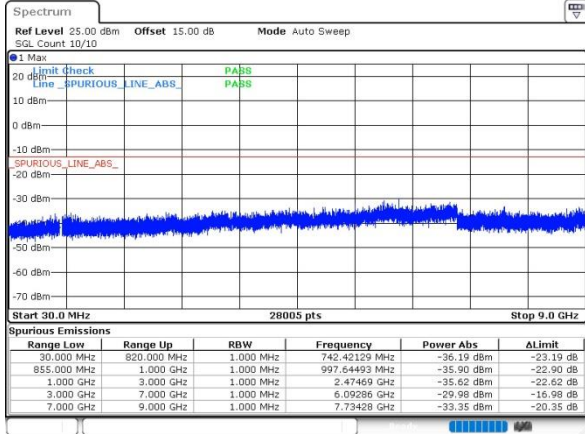

GSM850 (EDGE class 8)

Lowest Channel

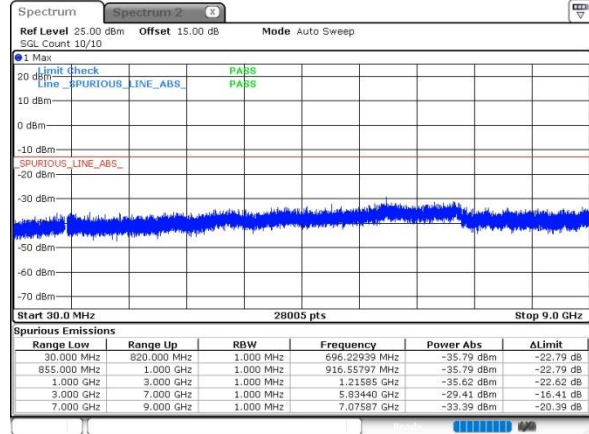

Middle Channel

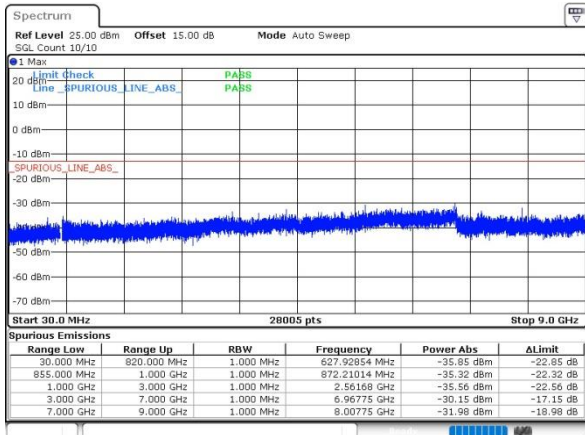

Date: 3.NOV.2023 16:50:54

Middle Channel

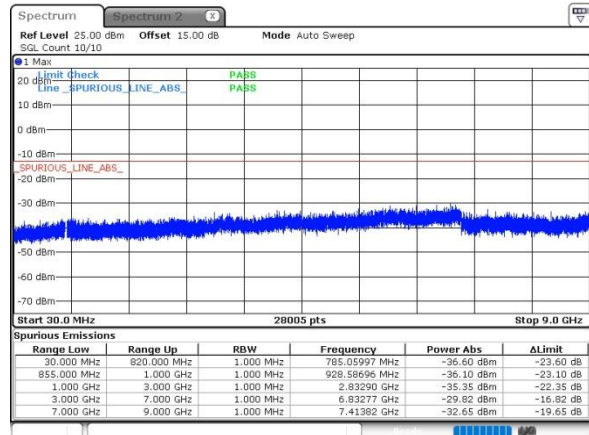

Date: 7.NOV.2023 15:29:03

Highest Channel

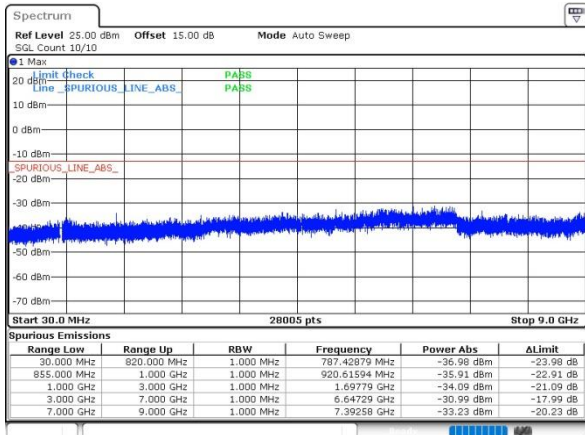

Date: 3.NOV.2023 16:51:14

Highest Channel

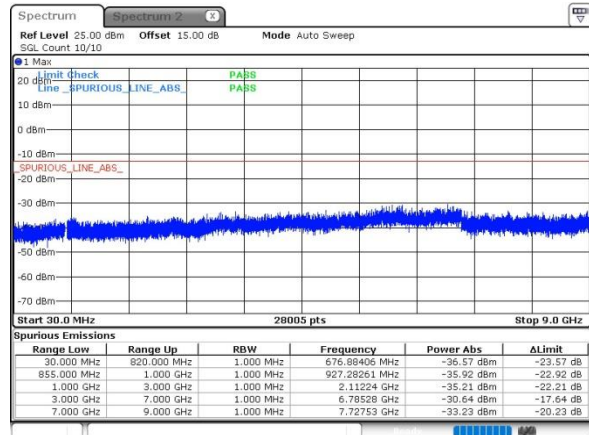

Date: 7.NOV.2023 15:29:28



GSM1900 (GSM)

Lowest Channel

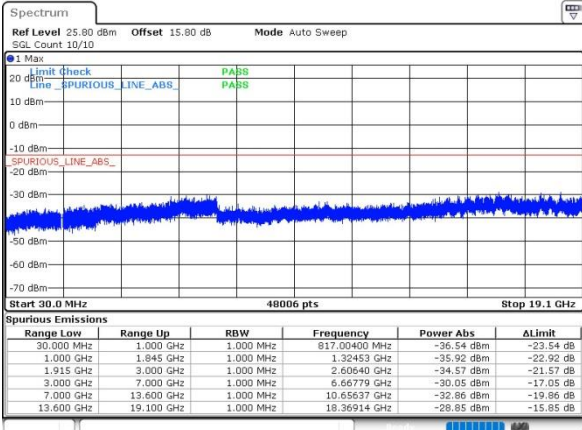

Date: 3.NOV.2023 17:25:14

GSM1900 (EDGE class 8)

Lowest Channel

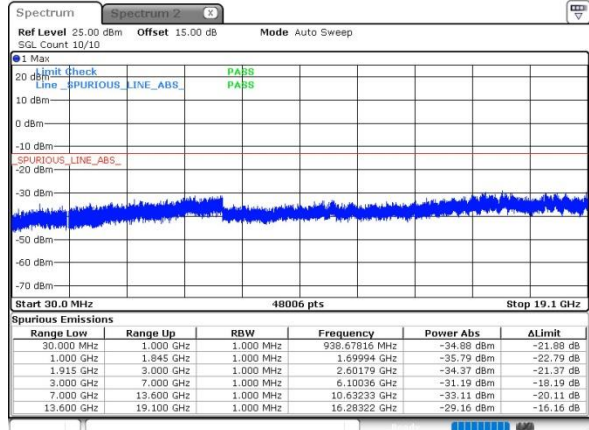

Date: 7.NOV.2023 15:10:01

Middle Channel

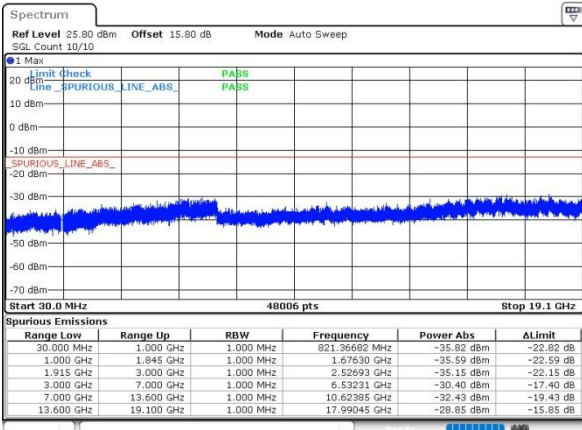

Date: 3.NOV.2023 17:25:24

Middle Channel

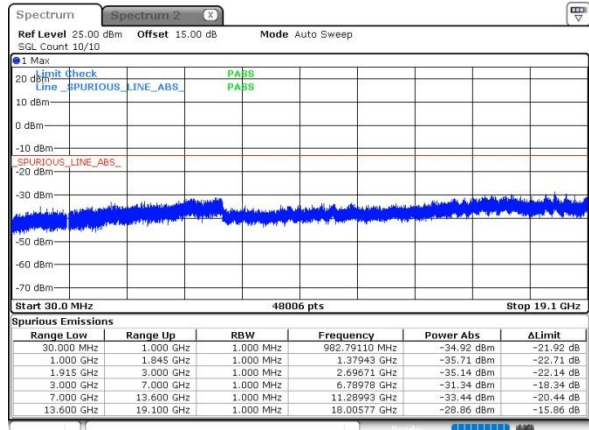

Date: 7.NOV.2023 15:10:25

Highest Channel

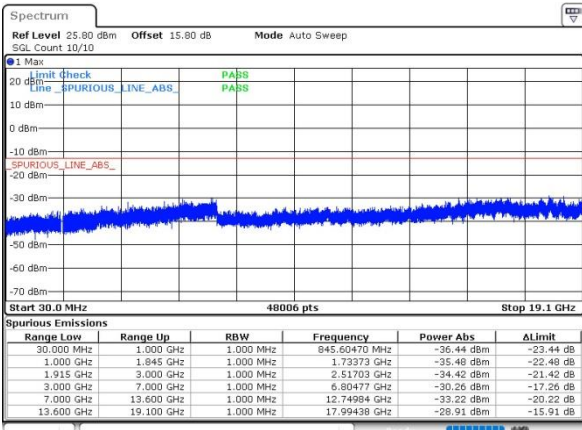

Date: 3.NOV.2023 17:25:38

Highest Channel

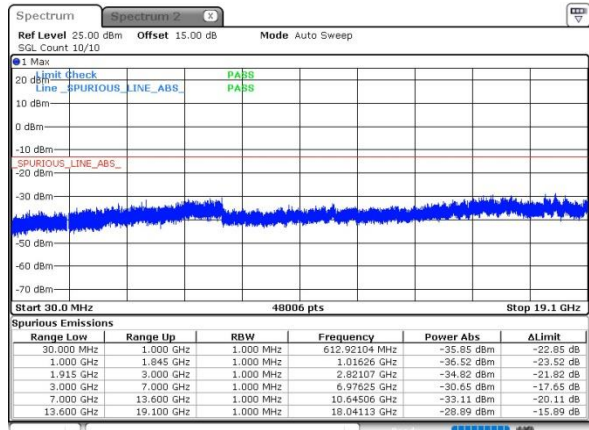

Date: 7.NOV.2023 15:10:55



Frequency Stability

Test Conditions	Middle Channel	GSM850 (GSM)	GSM850 (EDGE class 8)	Limit
Temperature (°C)	Voltage (Volt)	Deviation (ppm)		2.5ppm
50	Normal Voltage	0.0021	0.0047	PASS
40	Normal Voltage	0.0595	0.0169	
30	Normal Voltage	0.0048	0.0557	
20(Ref.)	Normal Voltage	0.0000	0.0000	
10	Normal Voltage	0.0249	0.0365	
0	Normal Voltage	0.0151	0.0624	
-10	Normal Voltage	0.0066	0.0485	
-20	Normal Voltage	0.0078	0.0157	
-30	Normal Voltage	0.0367	0.0449	
20	Maximum Voltage	0.0492	0.0526	
20	Normal Voltage	0.0124	0.0237	
20	Battery End Point	0.0368	0.0068	



Test Conditions	Middle Channel	GSM1900 (GSM)	GSM1900 (EDGE class 8)	Limit Note 2.
Temperature (°C)	Voltage (Volt)	Deviation (ppm)		Result
50	Normal Voltage	0.0015	0.0006	PASS
40	Normal Voltage	0.0279	0.0042	
30	Normal Voltage	0.0057	0.0138	
20(Ref.)	Normal Voltage	0.0000	0.0000	
10	Normal Voltage	0.0062	0.0246	
0	Normal Voltage	0.0138	0.0571	
-10	Normal Voltage	0.0247	0.0128	
-20	Normal Voltage	0.0365	0.0634	
-30	Normal Voltage	0.0012	0.0459	
20	Maximum Voltage	0.0036	0.0149	
20	Normal Voltage	0.0074	0.0087	
20	Battery End Point	0.0079	0.0352	

Note:

1. Normal Voltage = 3.91V ; Battery End Point (BEP) =3.4V. ; Maximum Voltage =4.5V
2. The frequency fundamental emissions stay within the authorized frequency block based on the frequency deviation measured is small.



A2. WCDMA

Peak-to-Average Ratio

Mode	WCDMA Band V	WCDMA Band II	WCDMA Band IV	Limit: 13dB
Mod.	RMC 12.2Kbps	RMC 12.2Kbps	RMC 12.2Kbps	Result
Lowest CH	3.10	3.30	3.33	PASS
Middle CH	3.07	3.28	3.33	
Highest CH	3.04	3.28	3.33	



WCDMA Band V (RMC 12.2Kbps)

Lowest Channel



Date: 3.NOV.2023 15:48:40

WCDMA Band II (RMC 12.2Kbps)

Lowest Channel



Date: 3.NOV.2023 15:00:46

Middle Channel

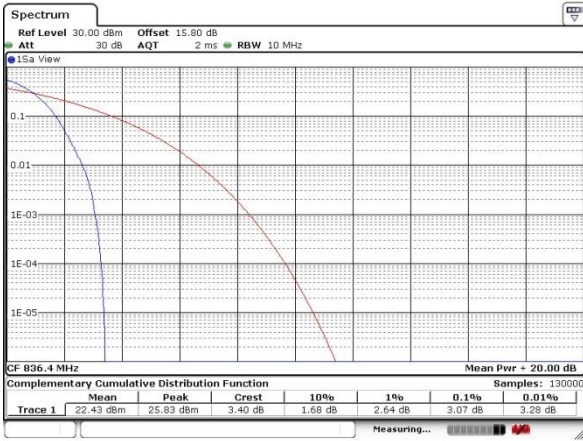

Date: 3.NOV.2023 15:48:59

Middle Channel

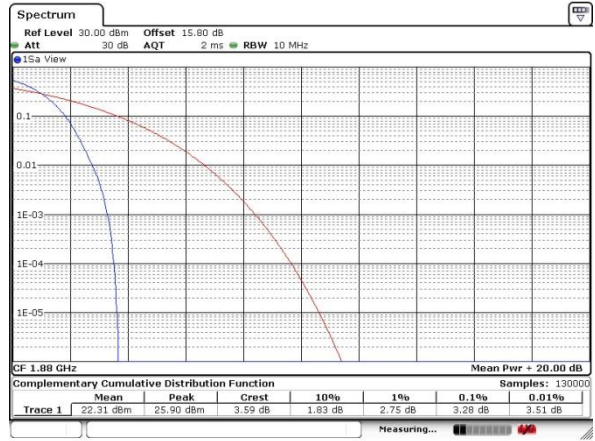

Date: 3.NOV.2023 15:01:06

Highest Channel

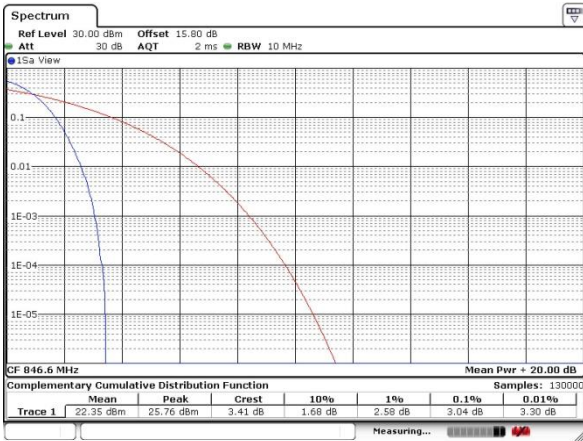

Date: 3.NOV.2023 15:49:22

Highest Channel

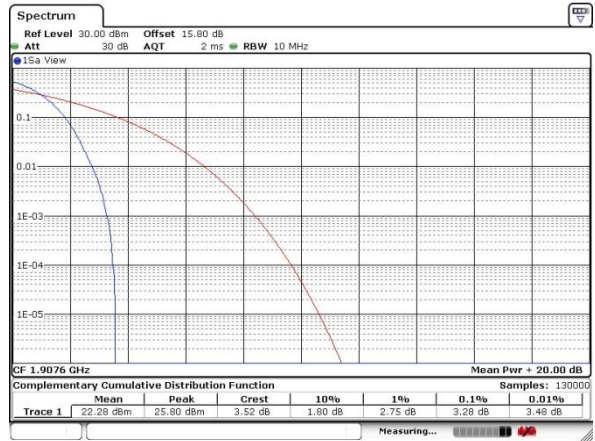

Date: 3.NOV.2023 15:01:25

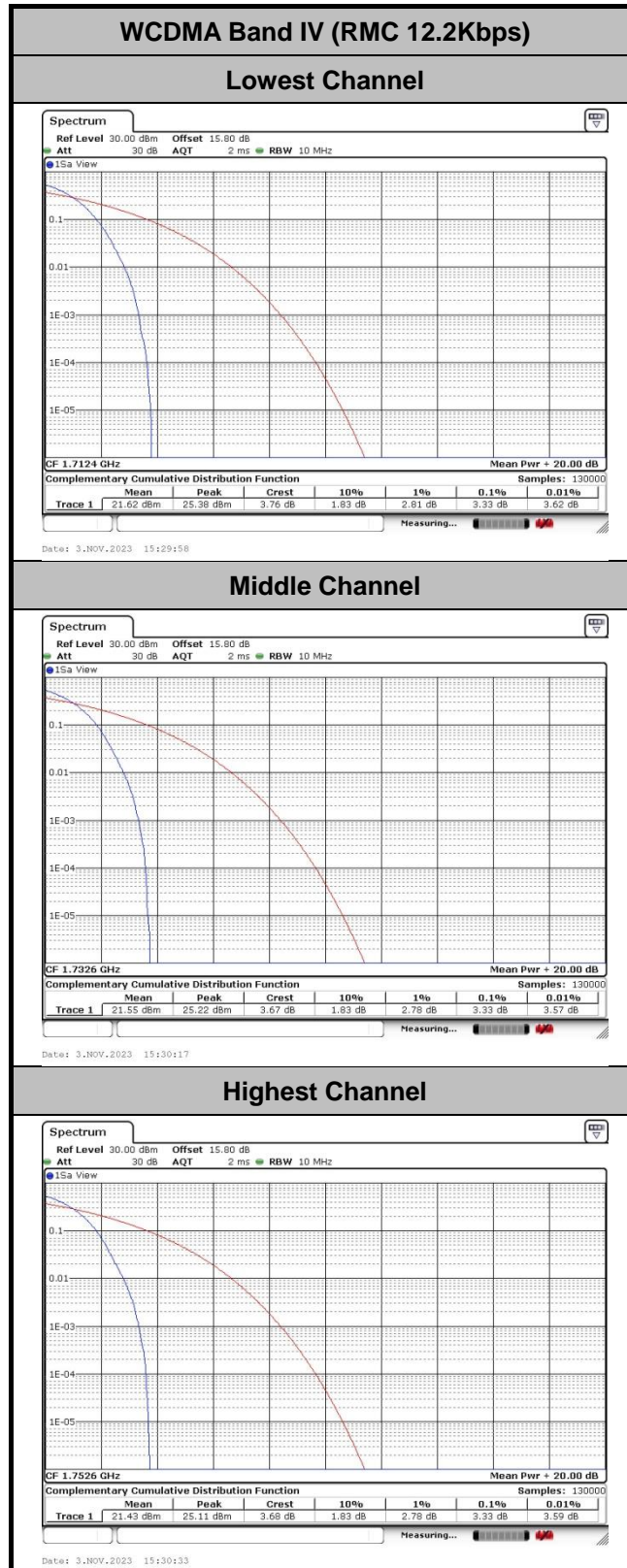



26dB Bandwidth

Mode	WCDMA Band V	WCDMA Band II	WCDMA Band IV
Mod.	RMC 12.2Kbps	RMC 12.2Kbps	RMC 12.2Kbps
Lowest CH	4.725	4.715	4.705
Middle CH	4.715	4.705	4.695
Highest CH	4.705	4.715	4.715