



FCC RF Test Report

APPLICANT : Motorola Mobility LLC
EQUIPMENT : Mobile Cellular Phone
BRAND NAME : Motorola
MODEL NAME : XT2363-2, XT2363-1
FCC ID : IHDT56AQ1
STANDARD : 47 CFR Part 2, Part 27 Subpart Q
CLASSIFICATION : PCS Licensed Transmitter Held to Ear (PCE)
TEST DATE(S) : Oct. 07, 2023 ~ Oct. 13, 2023

We, Sporton International Inc. (Kunshan), would like to declare that the tested sample has been evaluated in accordance with the procedures given in ANSI C63.26-2015 and shown compliance with the applicable technical standards.

The test results in this report apply exclusively to the tested model / sample. Without written approval of Sporton International Inc. (Kunshan), the test report shall not be reproduced except in full.

Jason Jia

Approved by: Jason Jia



Sporton International Inc. (Kunshan)

**No. 1098, Pengxi North Road, Kunshan Economic Development Zone Jiangsu Province 215300
People's Republic of China**



TABLE OF CONTENTS

REVISION HISTORY..... 3
SUMMARY OF TEST RESULT 4
1 GENERAL DESCRIPTION 5
1.1 Applicant 5
1.2 Manufacturer 5
1.3 Product Feature of Equipment Under Test 5
1.4 Product Specification of Equipment Under Test 5
1.5 Modification of EUT 5
1.6 Specification of Accessory 6
1.7 Maximum EIRP Power and Emission Designator 6
1.8 Testing Site 7
1.9 Test Software 7
1.10 Applied Standards 7
2 TEST CONFIGURATION OF EQUIPMENT UNDER TEST 8
2.1 Test Mode 8
2.2 Connection Diagram of Test System 9
2.3 Support Unit used in test configuration and system 9
2.4 Measurement Results Explanation Example 9
2.5 Frequency List of Low/Middle/High Channels 10
3 CONDUCTED TEST ITEMS 11
3.1 Measuring Instruments 11
3.2 Test Setup 11
3.3 Test Result of Conducted Test 11
3.4 Conducted Output Power Measurement 12
3.5 Peak-to-Average Ratio 13
3.6 EIRP 14
3.7 Occupied Bandwidth 15
3.8 Conducted Band Edge Measurement 16
3.9 Conducted Spurious Emission Measurement 17
3.10 Frequency Stability Measurement 18
4 RADIATED TEST ITEMS 19
4.1 Measuring Instruments 19
4.2 Test Setup 19
4.3 Test Result of Radiated Test 20
4.4 Radiated Spurious Emission Measurement 21
5 LIST OF MEASURING EQUIPMENT 22
6 MEASUREMENT UNCERTAINTY 23
APPENDIX A. TEST RESULTS OF CONDUCTED TEST
APPENDIX B. TEST RESULTS OF RADIATED TEST
APPENDIX C. TEST SETUP PHOTOGRAPHS



SUMMARY OF TEST RESULT

Report Section	FCC Rule	Description	Limit	Result	Remark
3.4	§2.1046	Conducted Output Power	—	Report Only	-
3.5	§27.50 (k)(4)	Peak-to-Average Ratio	<13dB	PASS	
3.6	§27.50 (k)(3)	EIRP	EIRP < 1W (30dBm)	PASS	-
3.7	§2.1049	Occupied Bandwidth	—	Report Only	-
3.8	§2.1051 §27.53 (n)(2)	Conducted Band Edge Measurement	-13dBm/MHz	PASS	-
3.9	§2.1051 §27.53 (n)(2)	Conducted Spurious Emission	-13dBm/MHz	PASS	-
3.10	§2.1055 §27.54	Frequency Stability Temperature & Voltage	Within the band	PASS	-
4.4	§2.1053 §27.53 (n)(2)	Radiated Spurious Emission	-13dBm/MHz	PASS	Under limit 43.38 dB at 6984.00 MHz

Conformity Assessment Condition:

- The test results (PASS/FAIL) with all measurement uncertainty excluded are presented against the regulation limits or in accordance with the requirements stipulated by the applicant/manufacturer who shall bear all the risks of non-compliance that may potentially occur if measurement uncertainty is taken into account.
- The measurement uncertainty please refer to each test result in the section "Measurement Uncertainty"

Disclaimer:

The product specifications of the EUT presented in the test report that may affect the test assessments are declared by the manufacturer who shall take full responsibility for the authenticity.



1 General Description

1.1 Applicant

Motorola Mobility LLC
222 W,Merchandise Mart Plaza, Chicago IL 60654 USA

1.2 Manufacturer

Motorola Mobility LLC
222 W,Merchandise Mart Plaza, Chicago IL 60654 USA

1.3 Product Feature of Equipment Under Test

Product Feature	
Equipment	Mobile Cellular Phone
Brand Name	Motorola
Model Name	XT2363-2, XT2363-1
FCC ID	IHDT56AQ1
IMEI Code	Conducted: 350735340022877/350735340022885 Radiation: 350735340018255/350735340018263
HW Version	DVT2
SW Version	UUG34.30
EUT Stage	Identical Prototype

Remark:

1. The above EUT's information was declared by manufacturer. Please refer to the specifications or user's manual for more detailed description.
2. The two model name is only for different market segment purpose.

1.4 Product Specification of Equipment Under Test

Product Feature	
Tx/Rx Frequency	LTE Band 42: 3450 MHz ~ 3550 MHz
Bandwidth	5MHz / 10MHz / 15MHz / 20MHz
Maximum Output Power to Antenna	LTE Band 42 : 22.86 dBm
Antenna Gain	LTE Band 42 : -1.2 dBi
Type of Modulation	QPSK / 16QAM / 64QAM / 256QAM

1.5 Modification of EUT

No modifications are made to the EUT during all test items.

1.6 Specification of Accessory

Specification of Accessory				
AC Adapter 1(US)	Brand Name	Motorola (Aohai)	Model Name	MC-201L
AC Adapter 1(EU)	Brand Name	Motorola (Aohai)	Model Name	MC-202L
AC Adapter 1(UK)	Brand Name	Motorola (Aohai)	Model Name	MC-203L
AC Adapter 1(AU)	Brand Name	Motorola (Aohai)	Model Name	MC-205L
AC Adapter 1(AR)	Brand Name	Motorola (Aohai)	Model Name	MC-206L
AC Adapter 1(IN)	Brand Name	Motorola (Aohai)	Model Name	MC 204
AC Adapter 2(US)	Brand Name	Motorola (Salcomp)	Model Name	MC 201L
AC Adapter 2(EU)	Brand Name	Motorola (Salcomp)	Model Name	MC 202L
AC Adapter 2(UK)	Brand Name	Motorola (Salcomp)	Model Name	MC-203L
AC Adapter 2(AU)	Brand Name	Motorola (Salcomp)	Model Name	MC-205L
AC Adapter 2(AR)	Brand Name	Motorola (Salcomp)	Model Name	MC-206L
AC Adapter 2(BR)	Brand Name	Motorola (Salcomp)	Model Name	MC-207L
AC Adapter 2(Chile)	Brand Name	Motorola (Salcomp)	Model Name	MC-209L
AC Adapter 3(BR)	Brand Name	Motorola (Chenyang)	Model Name	MC-207L
AC Adapter 4(BR local)	Brand Name	Motorola (Cliptech)	Model Name	MC 207L
AC Adapter 5(IN local)	Brand Name	Motorola (XIH)	Model Name	MC 204
Battery 1	Brand Name	Motorola (ATL)	Model Name	QF50
Battery 2	Brand Name	Motorola (SCUD)	Model Name	QF50
Battery 3	Brand Name	Motorola (Sunwoda)	Model Name	QF50
USB Cable 1	Brand Name	Motorola (Saibao)	Model Name	SZN-A026A
USB Cable 2	Brand Name	Motorola (Ju wei)	Model Name	JWUB1606-ZN01H
USB Cable 3	Brand Name	Motorola (Washin)	Model Name	HX-ZN-19

1.7 Maximum EIRP Power and Emission Designator

LTE Band 42		QPSK		16QAM/64QAM/256QAM	
BW (MHz)	Frequency Range (MHz)	Maximum EIRP(W)	Emission Designator (99%OBW)	Maximum EIRP(W)	Emission Designator (99%OBW)
5	3452.5 ~ 3547.5	0.1432	4M49G7D	0.1122	4M48W7D
10	3455 ~ 3545	0.1432	9M03G7D	0.1130	9M03W7D
15	3457.5 ~ 3542.5	0.1439	13M4G7D	0.1109	13M4W7D
20	3460 ~ 3540	0.1466	17M9G7D	0.1138	17M9W7D

1.8 Testing Site

Sporton International Inc. (Kunshan) is accredited to ISO/IEC 17025:2017 by American Association for Laboratory Accreditation with Certificate Number 5145.02.

Test Firm	Sporton International Inc. (Kunshan)		
Test Site Location	No. 1098, Pengxi North Road, Kunshan Economic Development Zone Jiangsu Province 215300 People's Republic of China TEL : +86-512-57900158		
Test Site No.	Sporton Site No.	FCC Designation No.	FCC Test Firm Registration No.
	03CH04-KS TH01-KS	CN1257	314309

1.9 Test Software

Item	Site	Manufacture	Name	Version
1.	TH01-KS	SPORTON	FCC LTE_Ver2.0 Auto_china_210503	2.0
2.	03CH04-KS	AUDIX	E3	210616

1.10 Applied Standards

According to the specifications of the manufacturer, the EUT must comply with the requirements of the following standards:

- ♦ 47 CFR Part 2, Part 27 Subpart Q
- ♦ ANSI C63.26-2015
- ♦ FCC KDB 971168 Power Meas License Digital Systems D01 v03r01
- ♦ FCC KDB 412172 D01 Determining ERP and EIRP v01r01

Remark:

1. All test items were verified and recorded according to the standards and without any deviation during the test.
2. This EUT has also been tested and complied with the requirements of FCC Part 15, Subpart B, recorded in a separate test report.

2 Test Configuration of Equipment Under Test

2.1 Test Mode

Antenna port conducted and radiated test items listed below are performed according to KDB 971168 D01 Power Meas. License Digital Systems v03r01 with maximum output power.

Radiated measurements are performed by rotating the EUT in three different orthogonal test planes to find the maximum emission. (Y Plane)

Test Cases	Band	Bandwidth (MHz)	Modulation	RB #	Test Channel
		eg. 5M, 10M, 15M, 20M	eg. QPSK, 16QAM, 64QAM, 256QAM	1RB, Partial RB, Full RB	L/M/H
Max. Output Power	LTE Band 42	5M, 10M, 15M, 20M	QPSK, 16QAM, 64QAM, 256QAM	1RB, Full RB	L, M, H
Peak-to-Average Ratio	LTE Band 42	20M	QPSK, 16QAM, 64QAM, 256QAM	Full RB	M
E.I.R.P	LTE Band 42	5M, 10M, 15M, 20M	QPSK, 16QAM, 64QAM, 256QAM	1RB, Full RB	L, M, H
26dB and 99% Bandwidth	LTE Band 42	5M, 10M, 15M, 20M	QPSK, 16QAM	Full RB	M
Conducted Band Edge	LTE Band 42	5M, 10M, 15M, 20M	QPSK, 16QAM, 64QAM, 256QAM	1RB, Full RB	L, H
Conducted Spurious Emission	LTE Band 42	5M, 10M, 15M, 20M	QPSK	1RB	L, M, H
Frequency Stability	LTE Band 42	5M	QPSK	1RB	M
Radiated Spurious Emission	LTE Band 42	Worst case from maximum power			M

Note:

The device is investigated from 30MHz to 10 times of fundamental signal for radiated spurious emission test under different RB size/offset and modulations in exploratory test. Subsequently, only the worst case emissions are reported.

2.2 Connection Diagram of Test System

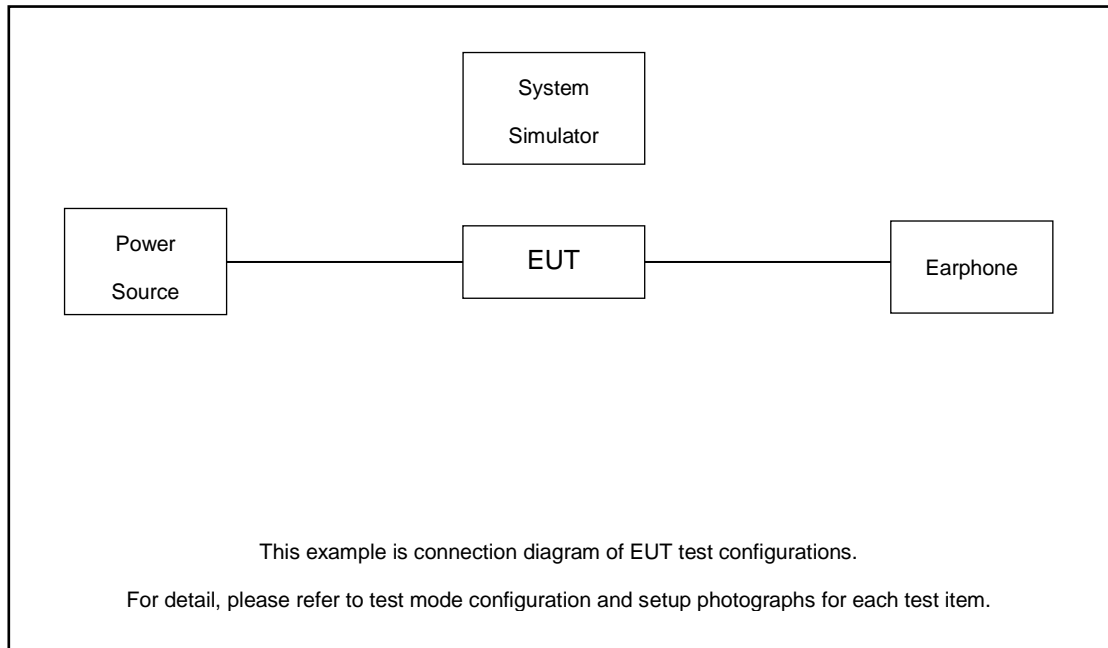

2.3 Support Unit used in test configuration and system

Item	Equipment	Trade Name	Model No.	FCC ID	Data Cable	Power Cord
1.	Power Supply	GWINSTEK	PSS-2002	N/A	N/A	Unshielded, 1.8 m
2.	LTE Base Station	Anritsu	MT8820C	N/A	N/A	Unshielded, 1.8 m
3.	Earphone	N/A	N/A	N/A	N/A	N/A

2.4 Measurement Results Explanation Example

For all conducted test items:

The offset level is set in the spectrum analyzer to compensate the RF cable loss between EUT conducted output port and spectrum analyzer. With the offset compensation, the spectrum analyzer reading level is exactly the EUT RF output level.

The spectrum analyzer offset is derived from RF cable loss.

Offset = RF cable loss.

Following shows an offset computation example with cable loss 6.5 dB.

Example :

$$\begin{aligned} \text{Offset(dB)} &= \text{RF cable loss(dB)}. \\ &= 6.5 \text{ (dB)} \end{aligned}$$



2.5 Frequency List of Low/Middle/High Channels

LTE Band 42 Channel and Frequency List				
BW [MHz]	Channel/Frequency(MHz)	Lowest	Middle	Highest
20	Channel	42190	42590	42990
	Frequency	3460	3500	3540
15	Channel	42165	42590	43015
	Frequency	3457.5	3500	3542.5
10	Channel	42140	42590	43040
	Frequency	3455	3500	3545
5	Channel	42115	42590	43065
	Frequency	3452.5	3500	3547.5

3 Conducted Test Items

3.1 Measuring Instruments

See list of measuring instruments of this test report.

3.2 Test Setup

3.2.1 Conducted Output Power



3.2.2 Peak-to-Average Ratio, Occupied / 26dB Bandwidth, Band-Edge and Conducted Spurious Emission

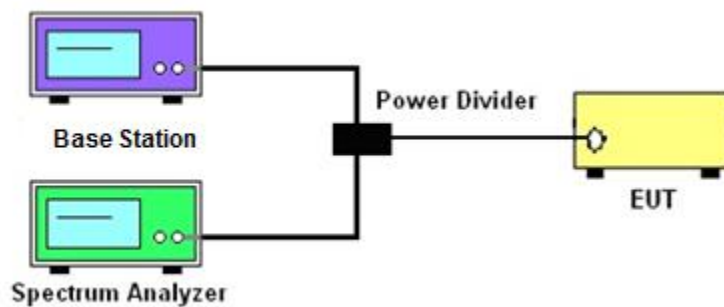

3.2.3 Frequency Stability

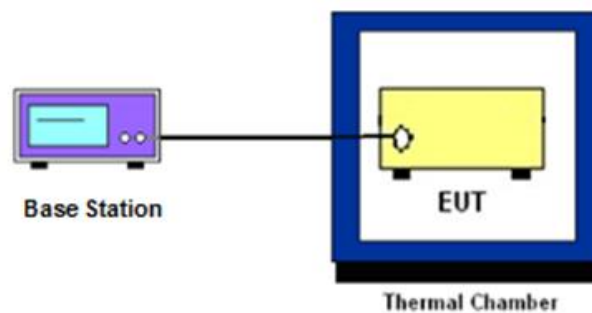

3.3 Test Result of Conducted Test

Please refer to Appendix A.



3.4 Conducted Output Power Measurement

3.4.1 Description of the Conducted Output Power Measurement

A base station simulator was used to establish communication with the EUT. Its parameters were set to transmit the maximum power on the EUT. The measured power in the radio frequency on the transmitter output terminals shall be reported.

3.4.2 Test Procedures

1. The testing follows ANSI C63.26 Section 5.2
2. The transmitter output port was connected to the system simulator.
3. Set EUT at maximum power through the system simulator.
4. Select lowest, middle, and highest channels for each band and different modulation.
5. Measure and record the power level from the system simulator.

3.5 Peak-to-Average Ratio

3.5.1 Description of the PAR Measurement

Power Complementary Cumulative Distribution Function (CCDF) curves provide a means for characterizing the power peaks of a digitally modulated signal on a statistical basis. A CCDF curve depicts the probability of the peak signal amplitude exceeding the average power level. Most contemporary measurement instrumentation include the capability to produce CCDF curves for an input signal provided that the instrument's resolution bandwidth can be set wide enough to accommodate the entire input signal bandwidth. In measuring transmissions in this band using an average power technique, the peak-to-average ratio (PAR) of the transmission may not exceed 13 dB.

3.5.2 Test Procedures

1. The testing follows ANSI C63.26 Section 5.2.3.4 (CCDF).
2. The EUT was connected to spectrum and system simulator via a power divider.
3. Set the CCDF (Complementary Cumulative Distribution Function) option in spectrum analyzer.
4. The highest RF powers were measured and recorded the maximum PAPR level associated with a probability of 0.1 %.
5. Record the deviation as Peak to Average Ratio.



3.6 EIRP

3.6.1 Description of EIRP Limit

§ 27.50 (k)(3)

Mobile devices are limited to 1Watt (30 dBm) EIRP. Mobile devices operating in these bands must employ a means for limiting power to the minimum necessary for successful communications

3.6.2 Test Procedures

1. According to KDB 412172 D01 Power Approach,
2. $EIRP = P_T + G_T - L_C$, $ERP = EIRP - 2.15$, where
 P_T = transmitter output power in dBm
 G_T = gain of the transmitting antenna in dBi
 L_C = signal attenuation in the connecting cable between the transmitter and antenna in dB

3.7 Occupied Bandwidth

3.7.1 Description of Occupied Bandwidth Measurement

The occupied bandwidth is the width of a frequency band such that, below the lower and above the upper frequency limits, the mean powers emitted are each equal to a specified percentage 0.5% of the total mean transmitted power.

The 26 dB emission bandwidth is defined as the frequency range between two points, one above and one below the carrier frequency, at which the spectral density of the emission is attenuated 26 dB below the maximum in-band spectral density of the modulated signal. Spectral density (power per unit bandwidth) is to be measured with a detector of resolution bandwidth equal to approximately 1.0% of the emission bandwidth.

3.7.2 Test Procedures

1. The testing follows ANSI C63.26 Section 5.4
2. The EUT was connected to spectrum analyzer and system simulator via a power divider.
3. The spectrum analyzer center frequency is set to the nominal EUT channel center frequency. The span range for the spectrum analyzer shall be between two and five times the anticipated OBW.
4. The nominal resolution bandwidth (RBW) shall be in the range of 1 to 5 % of the anticipated OBW, and the VBW shall be at least 3 times the RBW.
5. Set the detection mode to peak, and the trace mode to max hold.
6. Determine the reference value: Set the EUT to transmit a modulated signal. Allow the trace to stabilize. Set the spectrum analyzer marker to the highest level of the displayed trace.
(this is the reference value)
7. Determine the “-26 dB down amplitude” as equal to (Reference Value – X).
8. Place two markers, one at the lowest and the other at the highest frequency of the envelope of the spectral display such that each marker is at or slightly below the “-X dB down amplitude” determined in step 6. If a marker is below this “-X dB down amplitude” value it shall be placed as close as possible to this value. The OBW is the positive frequency difference between the two markers.
9. Use the 99 % power bandwidth function of the spectrum analyzer and report the measured bandwidth.

3.8 Conducted Band Edge Measurement

3.8.1 Description of Conducted Band Edge Measurement

§ 27.53 (n)(2)

For mobile operations in the 3450-3550 MHz band, the conducted power of any emission outside the licensee's authorized bandwidth shall not exceed -13 dBm/MHz.

Compliance with this paragraph is based on the use of measurement instrumentation employing a resolution bandwidth of 1 megahertz or greater. However, in the 1 megahertz bands immediately outside and adjacent to the licensee's frequency block, a resolution bandwidth of at least one percent of the emission bandwidth of the fundamental emission of the transmitter may be employed, but limited to a maximum of 200 kHz. In the bands between 1 and 5 MHz removed from the licensee's frequency block, the minimum resolution bandwidth for the measurement shall be 500 kHz.

3.8.2 Test Procedures

1. The testing follows ANSI C63.26 section 5.7
2. The EUT was connected to spectrum analyzer and system simulator via a power divider.
3. The band edges of low and high channels for the highest RF powers were measured.
4. Set RBW \geq 1% EBW but limited to a maximum of 200 kHz in the 1MHz band immediately outside and adjacent to the band edge.
5. Beyond the 1 MHz and 5 MHz removed from the band edge, set RBW \geq 500KHz.
6. Beyond the 5 MHz removed from the band edge, set RBW = 1MHz.
7. Set spectrum analyzer with RMS detector.
8. The RF fundamental frequency should be excluded against the limit line in the operating frequency band.
9. Checked that all the results comply with the emission limit line.

3.9 Conducted Spurious Emission Measurement

3.9.1 Description of Conducted Spurious Emission Measurement

The power of any emission outside of the authorized operating frequency ranges shall not exceed -13 dBm/MHz.

It is measured by means of a calibrated spectrum analyzer and scanned from 9 kHz up to a frequency including its 10th harmonic.

3.9.2 Test Procedures

1. The testing follows ANSI C63.26 section 5.7
2. The EUT was connected to spectrum analyzer and system simulator via a power divider.
3. The RF output of EUT was connected to the spectrum analyzer by RF cable and attenuator. The path loss was compensated to the results for each measurement.
4. The middle channel for the highest RF power within the transmitting frequency was measured.
5. The conducted spurious emission for the whole frequency range was taken.
6. Make the measurement with the spectrum analyzer's RBW = 1MHz, VBW = 3MHz.
7. Set spectrum analyzer with RMS detector.
8. Taking the record of maximum spurious emission.
9. The RF fundamental frequency should be excluded against the limit line in the operating frequency band.
10. Checked that all the results comply with the emission limit line.

3.10 Frequency Stability Measurement

3.10.1 Description of Frequency Stability Measurement

The frequency stability shall be measured by variation of ambient temperature and variation of primary supply voltage to ensure that the fundamental emission stays within the authorized frequency block.

3.10.2 Test Procedures for Temperature Variation

1. The testing follows ANSI C63.26 section 5.6.4
2. The EUT was set up in the thermal chamber and connected with the system simulator.
3. With power OFF, the temperature was decreased to -30°C and the EUT was stabilized before testing. Power was applied and the maximum change in frequency was recorded within one minute.
4. With power OFF, the temperature was raised in 10°C step up to 50°C . The EUT was stabilized at each step for at least half an hour. Power was applied and the maximum frequency change was recorded within one minute.

3.10.3 Test Procedures for Voltage Variation

1. The testing follows ANSI C63.26 section 5.6.5.
2. The EUT was placed in a temperature chamber at $20\pm 5^{\circ}\text{C}$ and connected with the system simulator.
3. The power supply voltage to the EUT was varied from 85% to 115% of the nominal value for other than hand carried battery equipment.
4. For hand carried, battery powered equipment, reduce the primary ac or dc supply voltage to the battery operating end point, which shall be specified by the manufacturer.
5. The variation in frequency was measured for the worst case.

4 Radiated Test Items

4.1 Measuring Instruments

See list of measuring instruments of this test report.

4.2 Test Setup

4.2.1 For radiated test below 30MHz



4.2.2 For radiated test from 30MHz to 1GHz

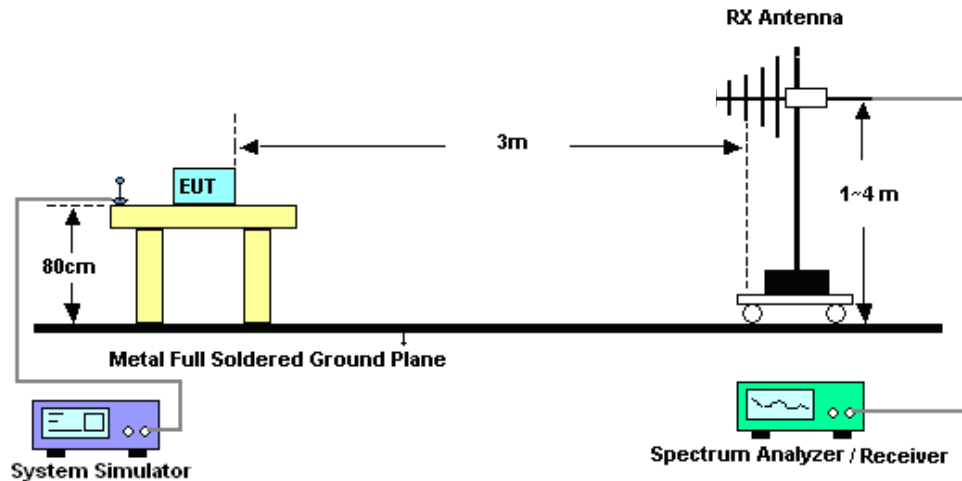

4.2.3 For radiated test above 1GHz



4.3 Test Result of Radiated Test

The low frequency, which started from 9 kHz to 30MHz, was pre-scanned and the result which was 20dB lower than the limit line was not reported.

Please refer to Appendix B.

4.4 Radiated Spurious Emission Measurement

4.4.1 Description of Radiated Spurious Emission

The radiated spurious emission was measured by substitution method according to ANSI/TIA-603-E. The power of any emission outside of the authorized operating frequency ranges shall not exceed -13 dBm/MHz.

The spectrum is scanned from 30 MHz up to a frequency including its 10th harmonic.

4.4.2 Test Procedures

1. The testing follows ANSI C63.26 Section 5.5
2. The EUT was placed on a turntable with 0.8 meter height for frequency below 1GHz and 1.5 meter height for frequency above 1GHz respectively above ground.
3. The EUT was set 3 meters from the receiving antenna mounted on the antenna tower.
4. The table was rotated 360 degrees to determine the position of the highest spurious emission.
5. The height of the receiving antenna is varied between 1m to 4m to search the maximum spurious emission for both horizontal and vertical polarizations.
6. During the measurement, the system simulator parameters were set to force the EUT transmitting at maximum output power.
7. Make the measurement with the spectrum analyzer's RBW = 1MHz, VBW = 3MHz, taking the record of maximum spurious emission.
8. A horn antenna was substituted in place of the EUT and was driven by a signal generator.
9. Tune the output power of signal generator to the same emission level with EUT maximum spurious emission.
$$\text{EIRP (dBm)} = \text{S.G. Power} - \text{Tx Cable Loss} + \text{Tx Antenna Gain}$$
$$\text{ERP (dBm)} = \text{EIRP} - 2.15$$
10. The RF fundamental frequency should be excluded against the limit line in the operating frequency band.



5 List of Measuring Equipment

Instrument	Manufacturer	Model No.	Serial No.	Characteristics	Calibration Date	Test Date	Due Date	Remark
Spectrum Analyzer	R&S	FSV40	101040	10Hz~40GHz	Oct. 11, 2023	Oct. 13, 2023	Oct. 10, 2024	Conducted (TH01-KS)
Power divider	STI	STI08-0055	-	0.5~40GHz	NCR	Oct. 13, 2023	NCR	Conducted (TH01-KS)
Temperature & humidity chamber	Hongzhan	LP-150U	H2014011440	-40~+150°C 20%~95%RH	Jul. 06, 2023	Oct. 13, 2023	Jul. 05, 2024	Conducted (TH01-KS)
EXA Spectrum Analyzer	Keysight	N9010B	MY57471079	10Hz-44G,MAX 30dB	Oct. 12, 2022	Oct. 07, 2023	Oct. 11, 2023	Radiation (03CH04-KS)
Loop Antenna	R&S	HFH2-Z2E	101125	9kHz~30MHz	Sep. 11 2023	Oct. 07, 2023	Sep. 10, 2024	Radiation (03CH04-KS)
Bilog Antenna	TeseQ	CBL6111D	49922	30MHz-1GHz	Apr. 09, 2023	Oct. 07, 2023	Apr. 08, 2024	Radiation (03CH04-KS)
Horn Antenna	Schwarzbeck	BBHA9120D	1284	1GHz~18GHz	Oct. 16, 2022	Oct. 07, 2023	Oct. 15, 2023	Radiation (03CH04-KS)
SHF-EHF Horn	Com-power	AH-840	101070	18GHz~40GHz	Jan. 08, 2023	Oct. 07, 2023	Jan. 07, 2024	Radiation (03CH04-KS)
Amplifier	SONOMA	310N	380827	9KHz-1GHz	Jul. 06, 2023	Oct. 07, 2023	Jul. 05, 2024	Radiation (03CH04-KS)
Amplifier	MITEQ	EM18G40G GA	060728	18~40GHz	Jan. 05, 2023	Oct. 07, 2023	Jan. 04, 2024	Radiation (03CH04-KS)
high gain Amplifier	EM	EM01G18G A	060840	1Ghz-18Ghz	Oct. 12, 2022	Oct. 07, 2023	Oct. 11, 2023	Radiation (03CH04-KS)
Amplifier	Agilent	8449B	3008A02370	1Ghz-18Ghz	Oct. 12, 2022	Oct. 07, 2023	Oct. 11, 2023	Radiation (03CH04-KS)
AC Power Source	Chroma	61601	F104090004	N/A	NCR	Oct. 07, 2023	NCR	Radiation (03CH04-KS)
Turn Table	ChamPro	EM 1000-T	060762-T	0~360 degree	NCR	Oct. 07, 2023	NCR	Radiation (03CH04-KS)
Antenna Mast	ChamPro	EM 1000-A	060762-A	1 m~4 m	NCR	Oct. 07, 2023	NCR	Radiation (03CH04-KS)

NCR: No Calibration Required

6 Measurement Uncertainty

The measurement uncertainties shown below were calculated in accordance with the requirements of ANSI 63.26-2015. All the measurement uncertainty value were shown with a coverage K=2 to indicate 95% level of confidence. The measurement data show herein meets or exceeds the CISPR measurement uncertainty values specified in CISPR 16-4-2 and can be compared directly to specified limit to determine compliance.

Uncertainty of Conducted Measurement

Test Item	Uncertainty
Conducted Power	±0.46 dB
Conducted Emissions	±2.26 dB
Occupied Channel Bandwidth	±0.1 %

Uncertainty of Radiated Emission Measurement (30 MHz ~ 1000 MHz)

Measuring Uncertainty for a Level of Confidence of 95% (U = 2Uc(y))	3.82dB
---	--------

Uncertainty of Radiated Emission Measurement (1 GHz ~ 18 GHz)

Measuring Uncertainty for a Level of Confidence of 95% (U = 2Uc(y))	3.56dB
---	--------

Uncertainty of Radiated Emission Measurement (18 GHz ~ 40 GHz)

Measuring Uncertainty for a Level of Confidence of 95% (U = 2Uc(y))	3.54dB
---	--------

----- THE END -----



Appendix A. Test Results of Conducted Test

Test Engineer :	Simle Wang	Temperature :	22~23°C
		Relative Humidity :	40~42%

Conducted Output Power(Average power) and EIRP

BW [MHz]	Modulation	RB Size	RB Offset	Power Low Ch. / Freq.	Power Middle Ch. / Freq.	Power High Ch. / Freq.	EIRP(W)		
Channel				42190	42590	42990	EIRP(W)		
Frequency (MHz)				3460	3500	3540	L	M	H
20	QPSK	1	0	22.81	22.86	22.84	0.1449	0.1466	0.1459
20	QPSK	1	99	22.63	22.81	22.69	0.1390	0.1449	0.1409
20	QPSK	100	0	21.73	21.80	21.77	0.1130	0.1148	0.1140
20	16QAM	1	0	21.70	21.76	21.61	0.1122	0.1138	0.1099
20	64QAM	1	0	20.66	20.75	20.52	0.0883	0.0902	0.0855
20	256QAM	1	0	17.79	17.96	17.91	0.0456	0.0474	0.0469
Channel				42165	42590	43015	EIRP(W)		
Frequency (MHz)				3457.5	3500	3542.5	L	M	H
15	QPSK	1	0	22.64	22.73	22.78	0.1393	0.1422	0.1439
15	16QAM	1	0	21.65	21.57	21.42	0.1109	0.1089	0.1052
Channel				42140	42590	43040	EIRP(W)		
Frequency (MHz)				3455	3500	3545	L	M	H
10	QPSK	1	0	22.76	22.68	22.75	0.1432	0.1406	0.1429
10	16QAM	1	0	21.54	21.73	21.48	0.1081	0.1130	0.1067
Channel				42115	42590	43065	EIRP(W)		
Frequency (MHz)				3452.5	3500	3547.5	L	M	H
5	QPSK	1	0	22.62	22.76	22.70	0.1387	0.1432	0.1413
5	16QAM	1	0	21.64	21.70	21.46	0.1107	0.1122	0.1062

Peak-to-Average Ratio

Mode	LTE Band 42 / 20MHz				
Mod.	QPSK	16QAM	64QAM	256QAM	Limit: 13dB
RB Size	Full RB				Result
Middle CH	6.35	8.20	8.41	8.87	PASS

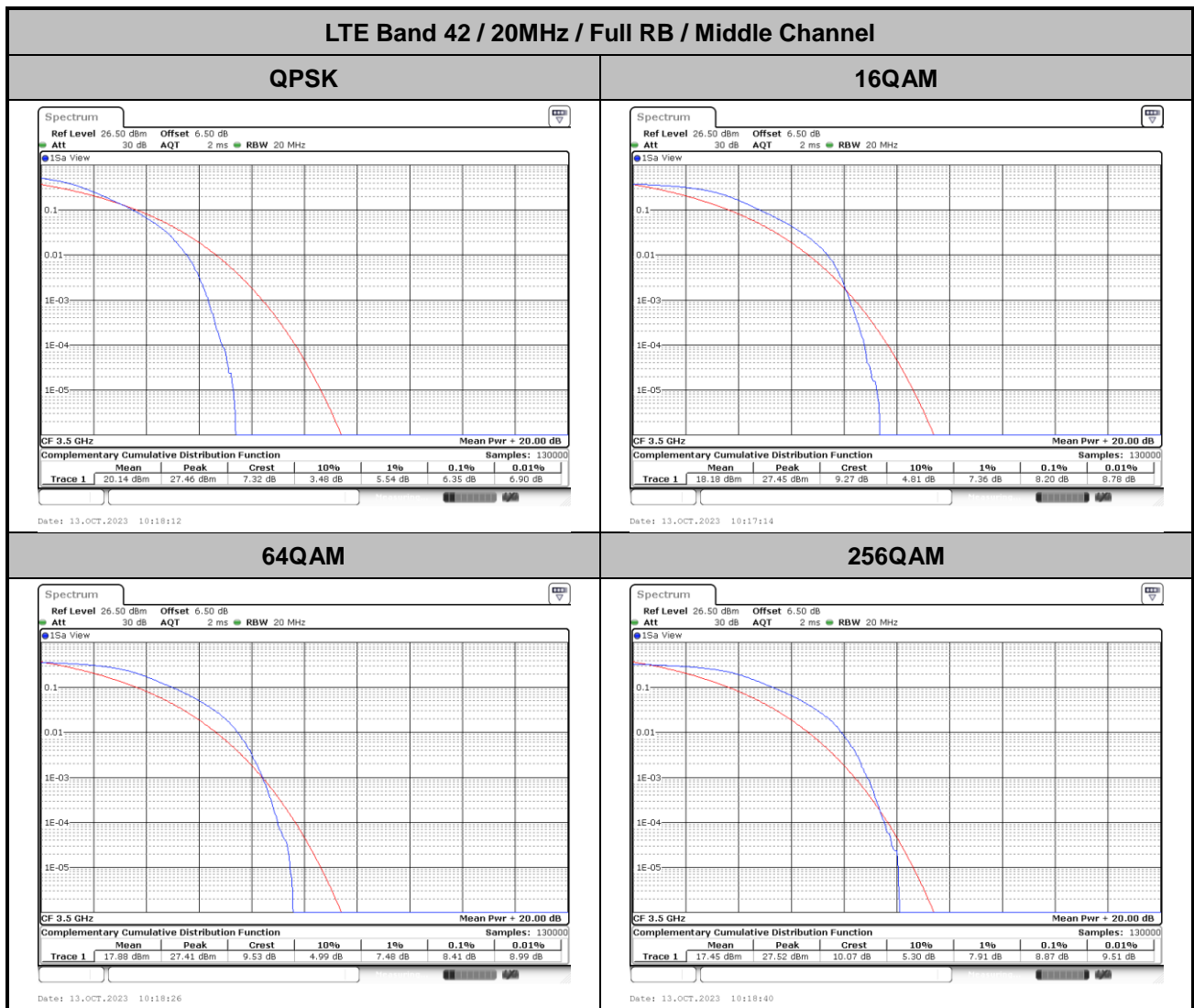



26dB Bandwidth

Mode	LTE Band 42 : 26dB BW(MHz)							
	5MHz		10MHz		15MHz		20MHz	
Mod.	QPSK	16QAM	QPSK	16QAM	QPSK	16QAM	QPSK	16QAM
Middle CH	4.95	4.85	9.75	9.69	14.27	14.30	19.18	19.18

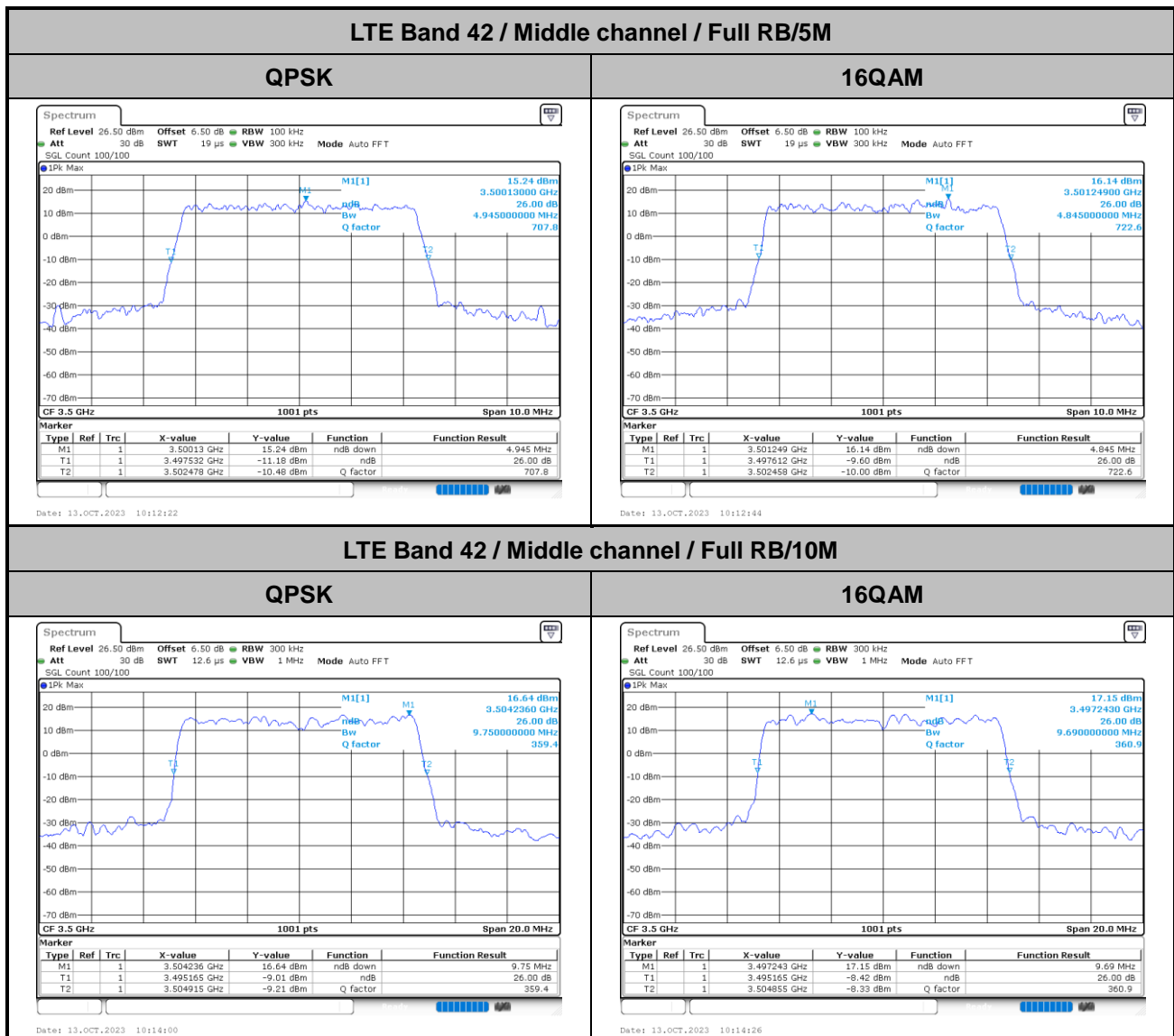



LTE Band 42 / Middle channel / Full RB/15M

QPSK

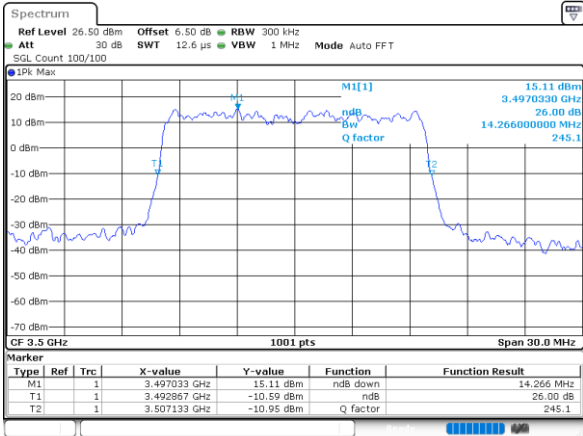

Date: 13.OCT.2023 10:15:16

16QAM

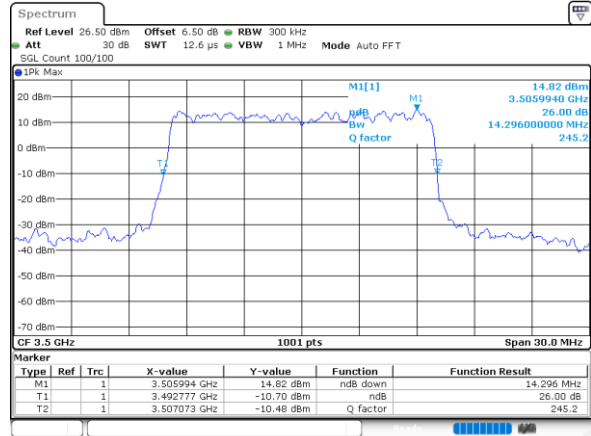

Date: 13.OCT.2023 10:15:43

LTE Band 42 / Middle channel / Full RB/20M

QPSK

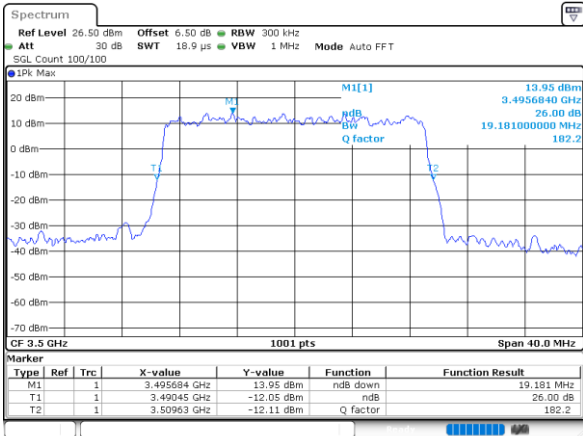

Date: 13.OCT.2023 10:17:00

16QAM

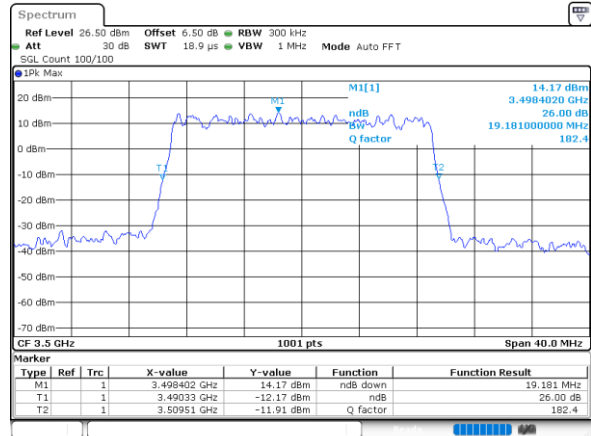

Date: 13.OCT.2023 10:17:36

Occupied Bandwidth

Mode	LTE Band 42 : 99%OBW(MHz)							
	5MHz		10MHz		15MHz		20MHz	
Mod.	QPSK	16QAM	QPSK	16QAM	QPSK	16QAM	QPSK	16QAM
Middle CH	.449	4.48	9.03	9.03	13.43	13.43	17.94	17.90

LTE Band 42 / Middle channel / Full RB/5M

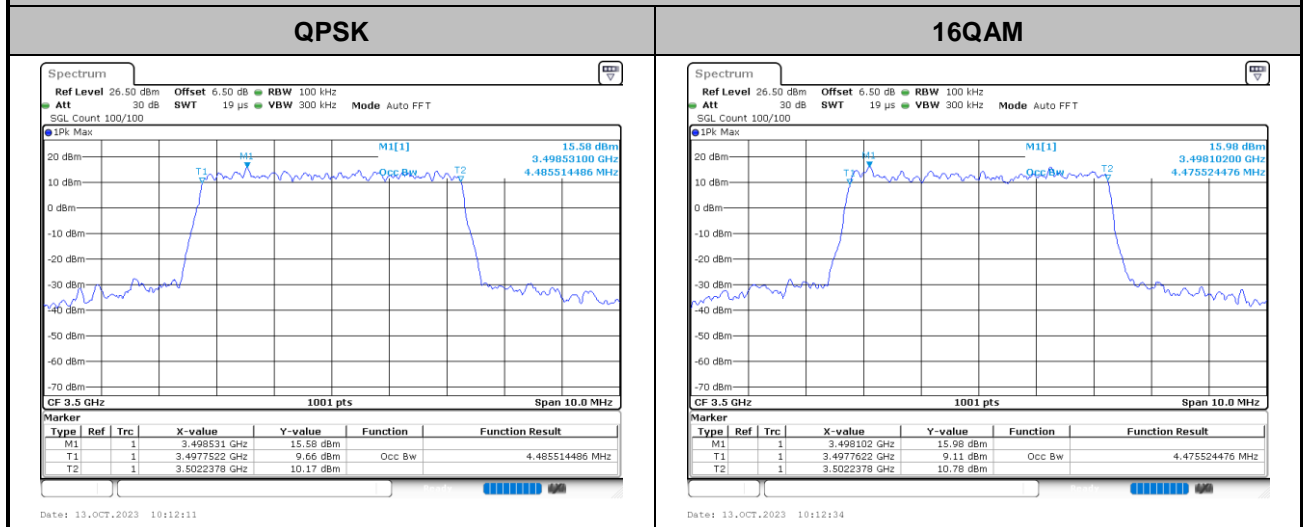

LTE Band 42 / Middle channel / Full RB/10M

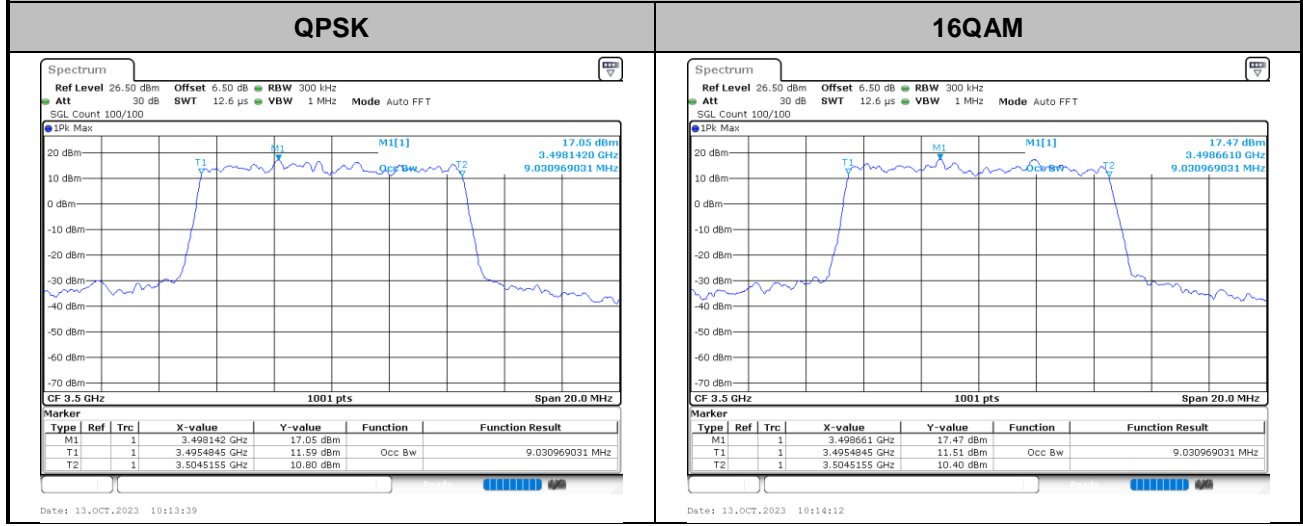



LTE Band 42 / Middle channel / Full RB/15M

QPSK

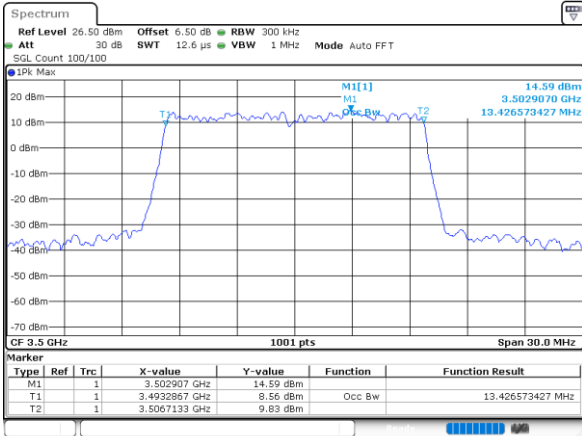

Date: 13.OCT.2023 10:15:04

16QAM

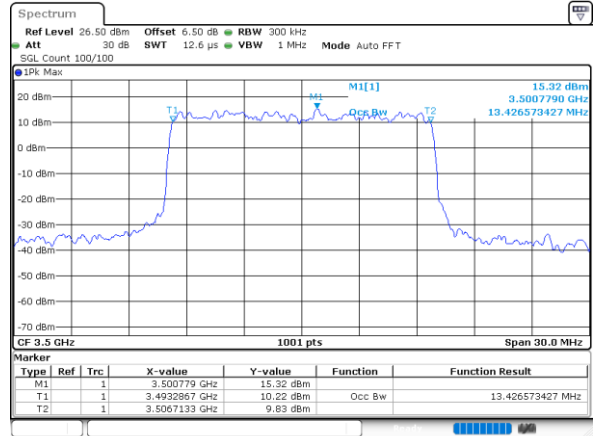

Date: 13.OCT.2023 10:15:33

LTE Band 42 / Middle channel / Full RB/20M

QPSK

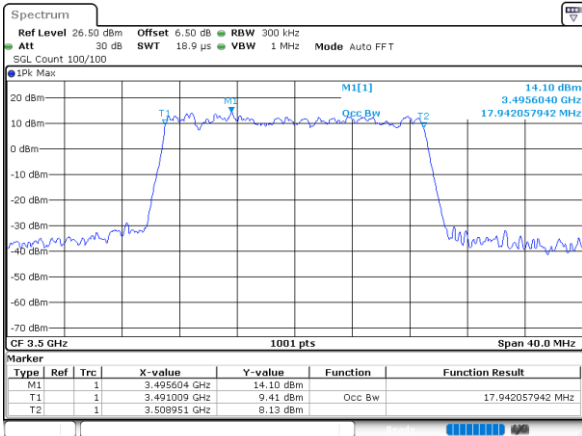

Date: 13.OCT.2023 10:16:50

16QAM

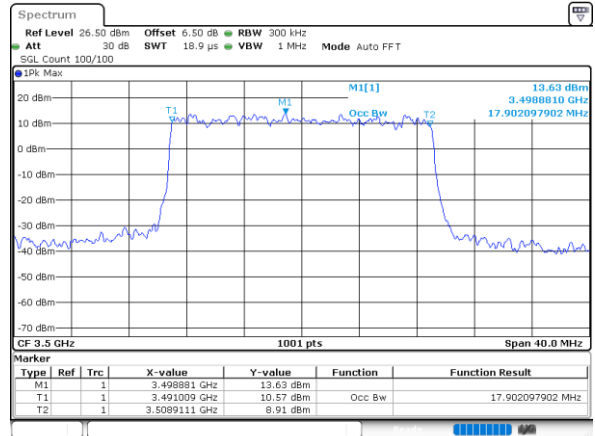

Date: 13.OCT.2023 10:16:14



Conducted Band Edge

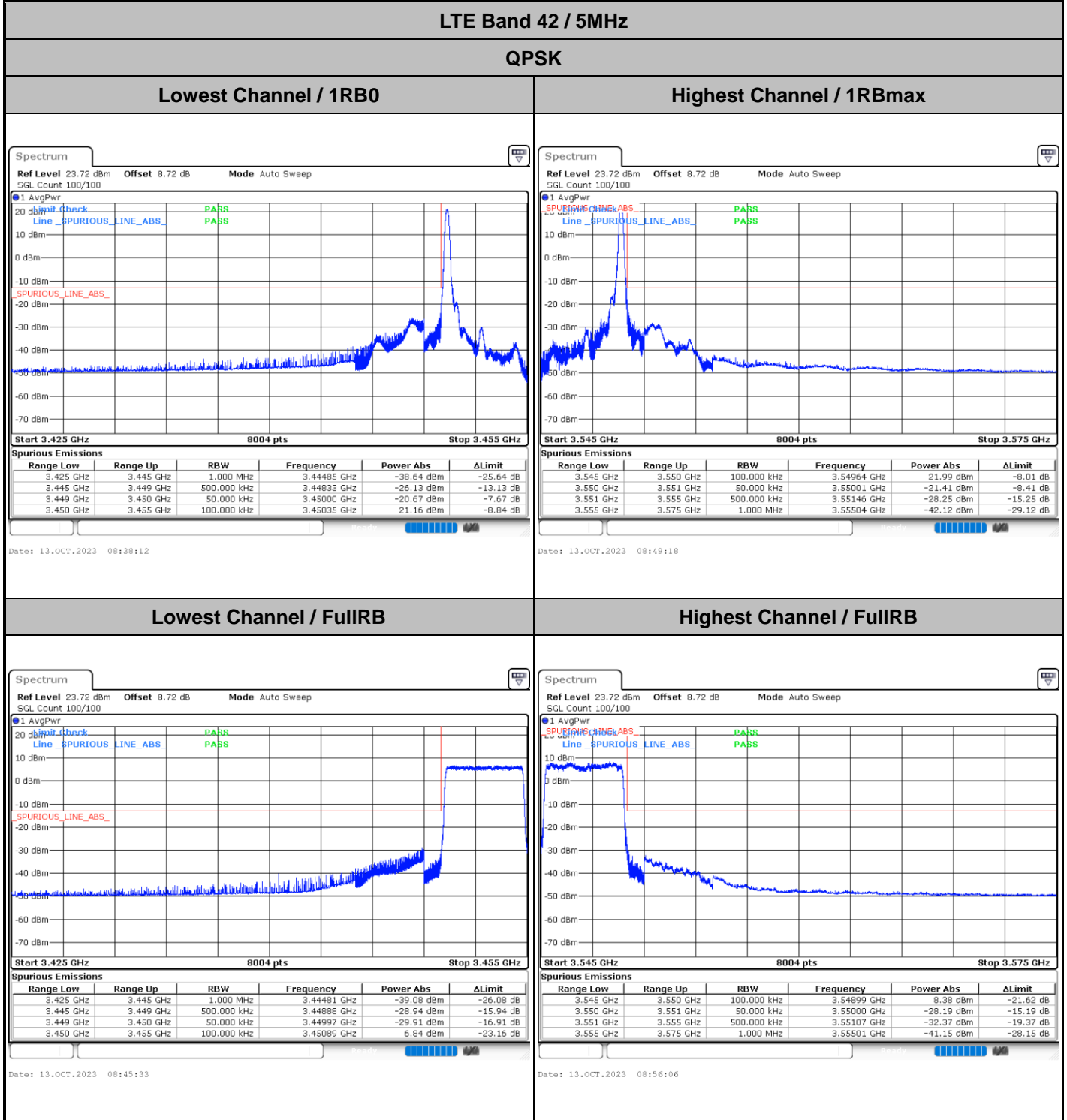



LTE Band 42 / 5MHz

16QAM

Lowest Channel / 1RB0

Highest Channel / 1RBmax

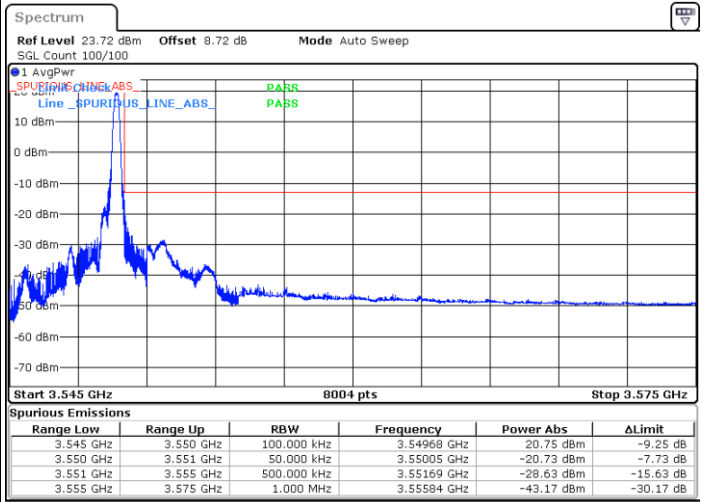
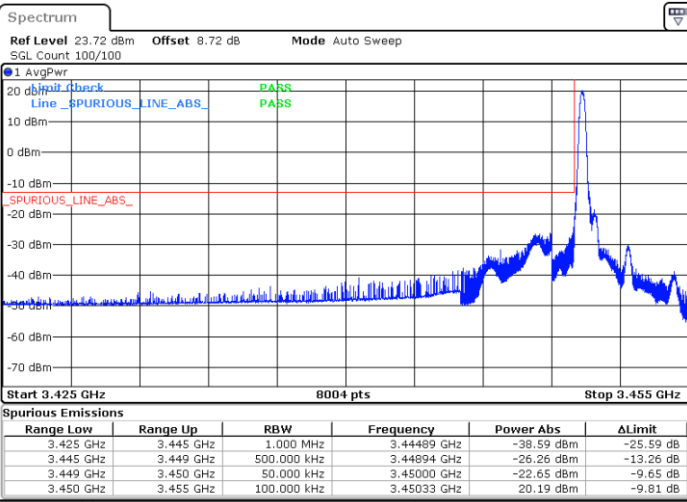

Date: 13.OCT.2023 08:39:08

Date: 13.OCT.2023 08:50:14

Lowest Channel / FullRB

Highest Channel / FullRB

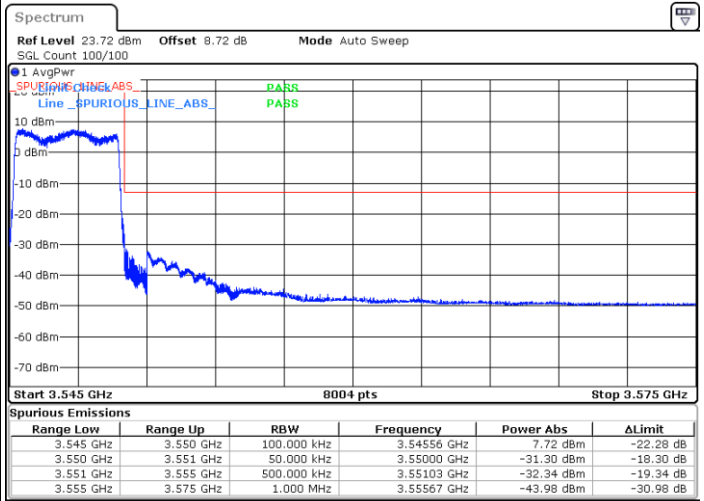
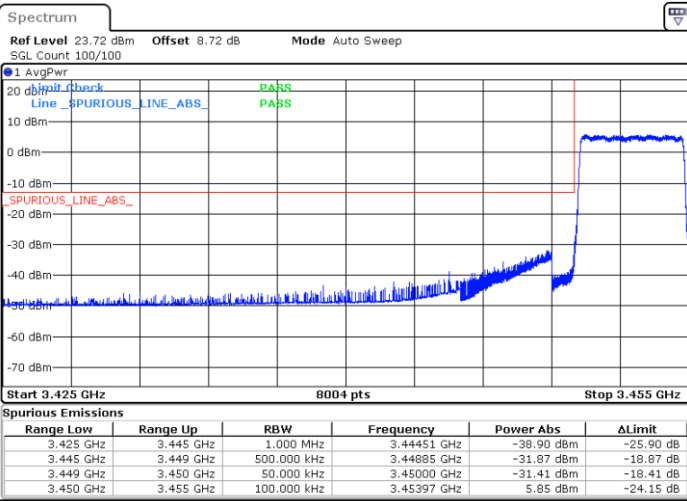

Date: 13.OCT.2023 08:44:38

Date: 13.OCT.2023 08:55:10



LTE Band 42 / 5MHz

64QAM

Lowest Channel / 1RB0

Highest Channel / 1RBmax

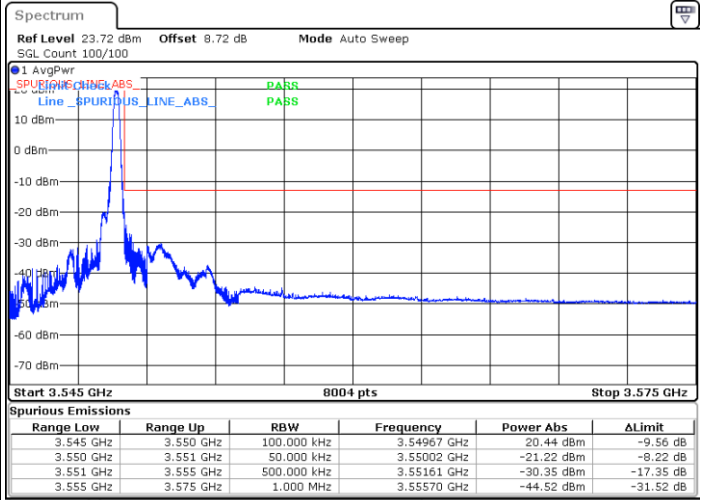
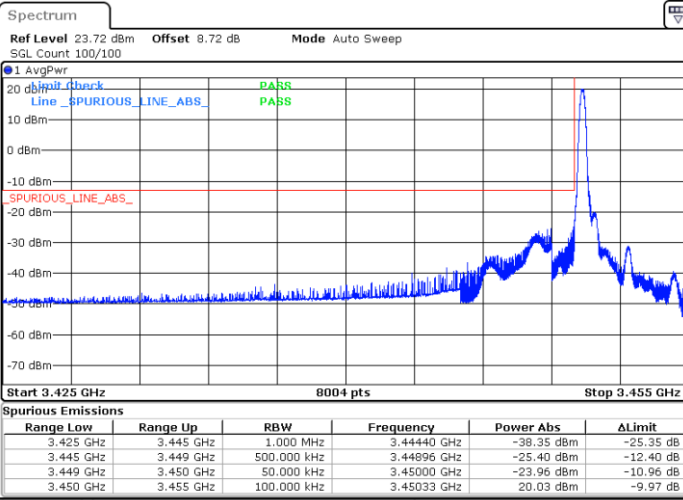

Date: 13.OCT.2023 08:40:03

Date: 13.OCT.2023 08:51:09

Lowest Channel / FullRB

Highest Channel / FullRB

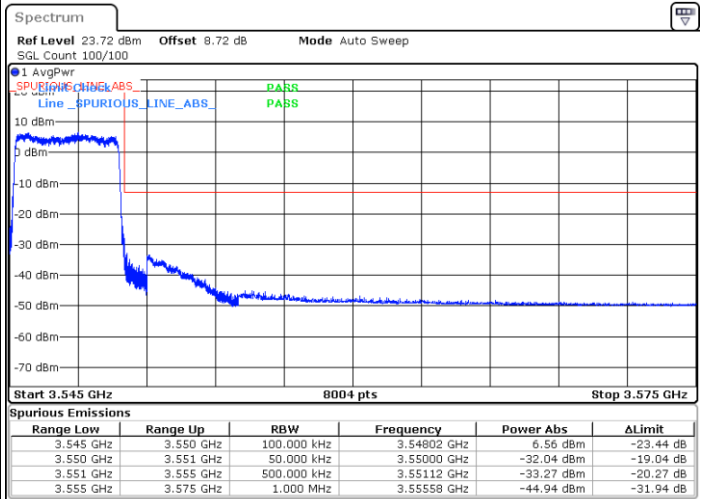
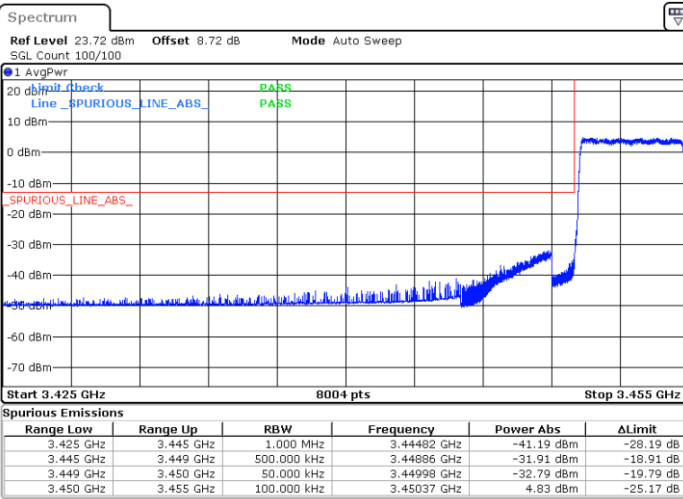

Date: 13.OCT.2023 08:43:42

Date: 13.OCT.2023 08:54:14



LTE Band 42 / 5MHz

256QAM

Lowest Channel / 1RB0

Highest Channel / 1RBmax

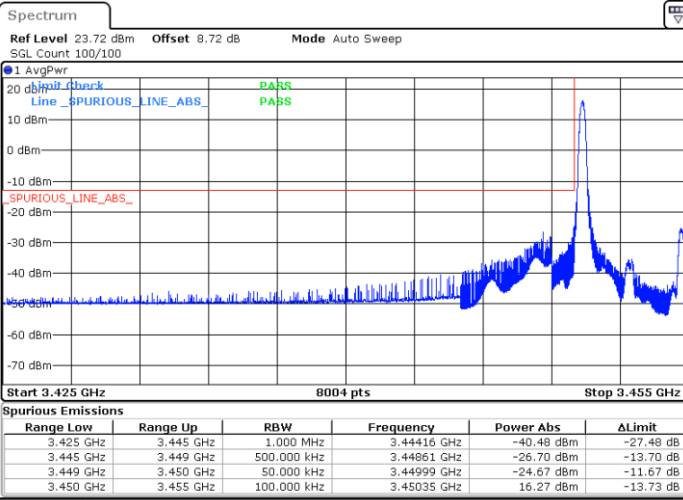

Date: 13.OCT.2023 08:40:59

Date: 13.OCT.2023 08:52:05

Lowest Channel / FullRB

Highest Channel / FullRB

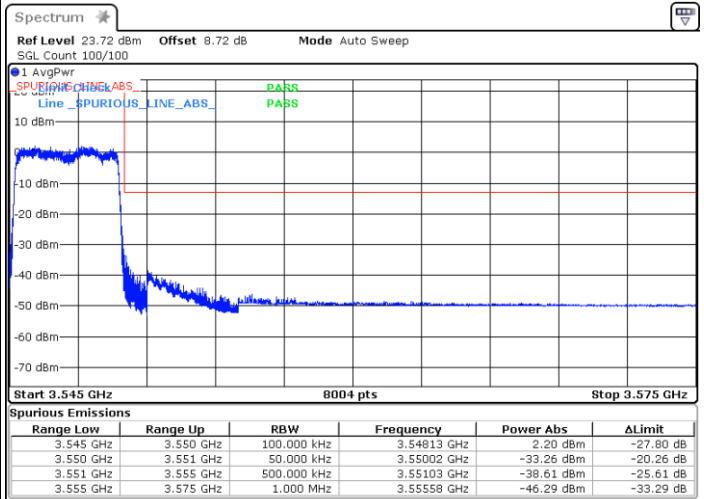
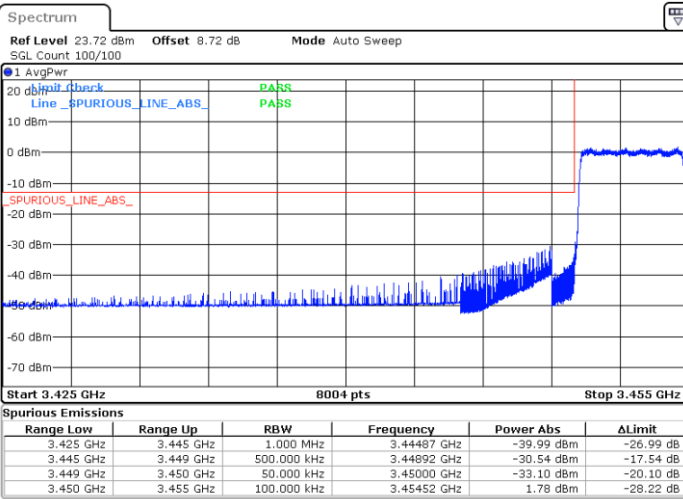

Date: 13.OCT.2023 08:42:47

Date: 13.OCT.2023 10:09:25



LTE Band 42 / 10MHz

QPSK

Lowest Channel / 1RB0

Highest Channel / 1RBmax

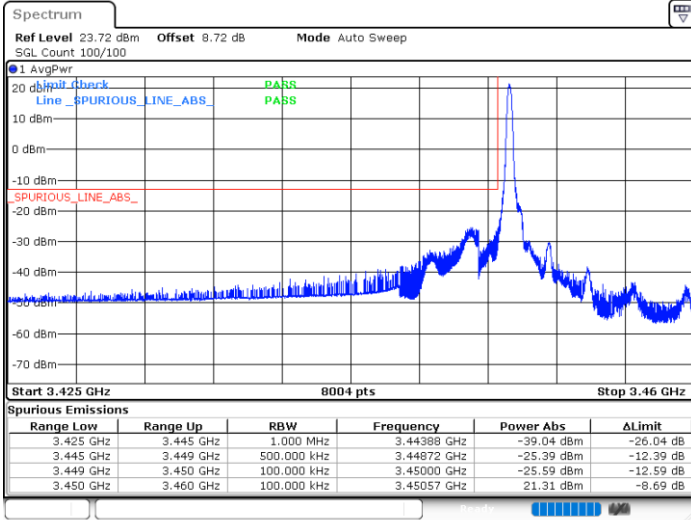

Date: 13.OCT.2023 08:58:27



Date: 13.OCT.2023 09:09:47

Lowest Channel / FullRB

Highest Channel / FullRB

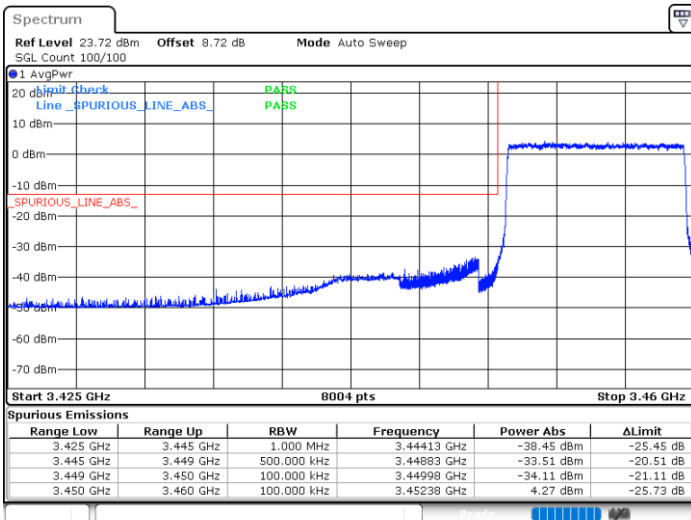

Date: 13.OCT.2023 09:06:02

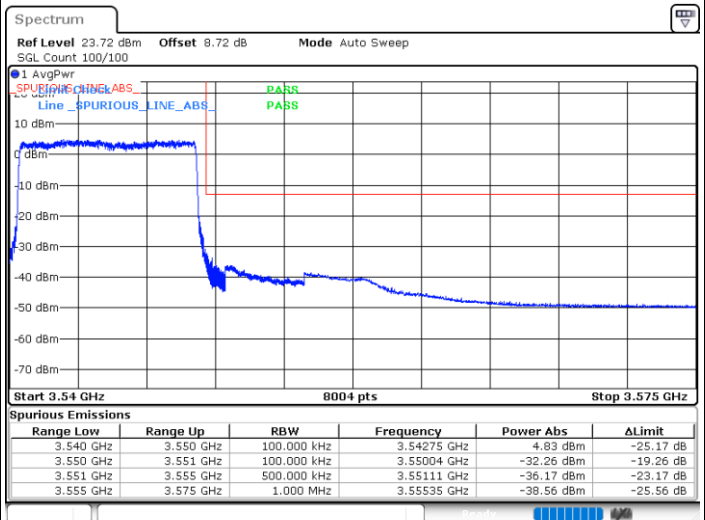

Date: 13.OCT.2023 09:16:53

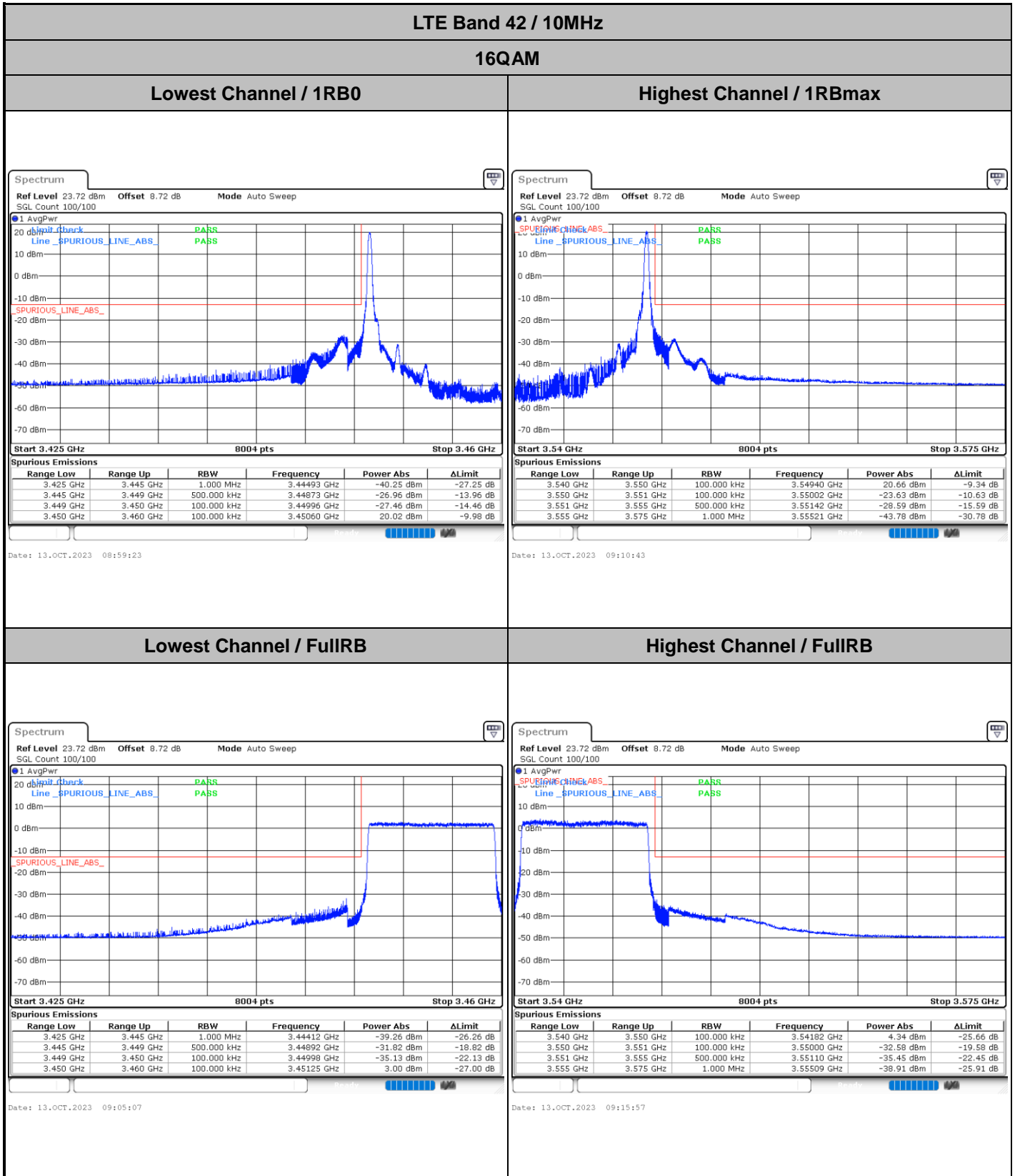



LTE Band 42 / 10MHz

64QAM

Lowest Channel / 1RB0

Highest Channel / 1RBmax

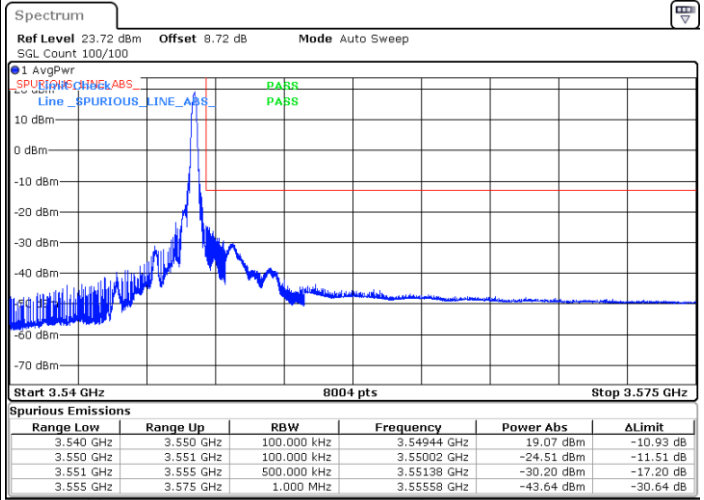
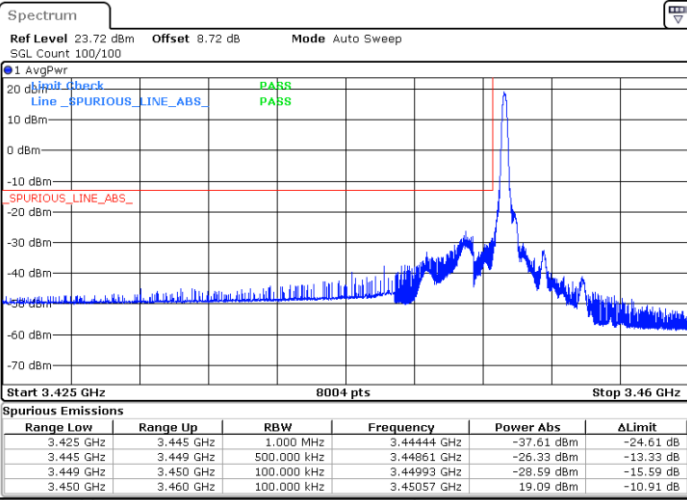

Date: 13.OCT.2023 09:00:18

Date: 13.OCT.2023 09:11:38

Lowest Channel / FullRB

Highest Channel / FullRB

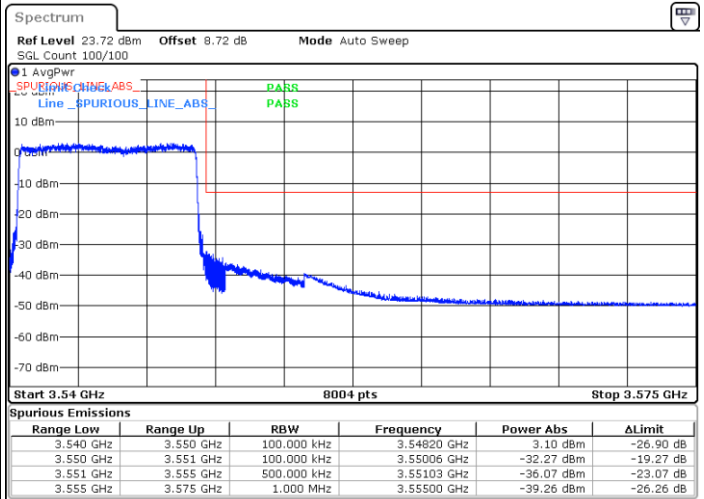
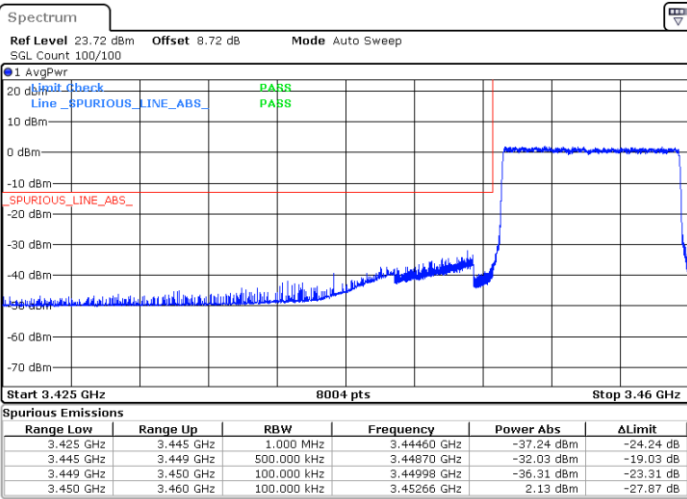

Date: 13.OCT.2023 09:04:11

Date: 13.OCT.2023 09:15:02

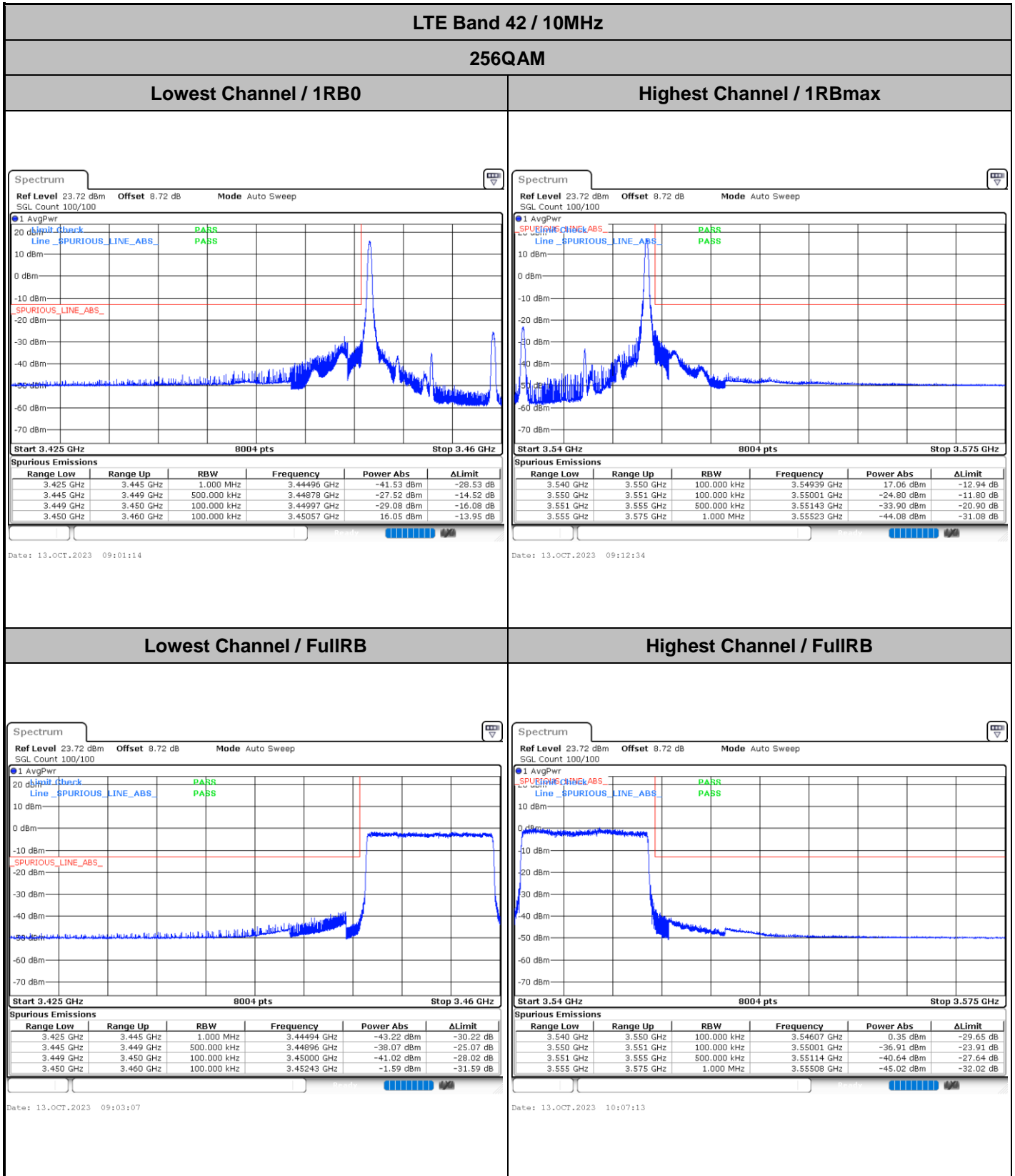



LTE Band 42 / 15MHz

QPSK

Lowest Channel / 1RB0

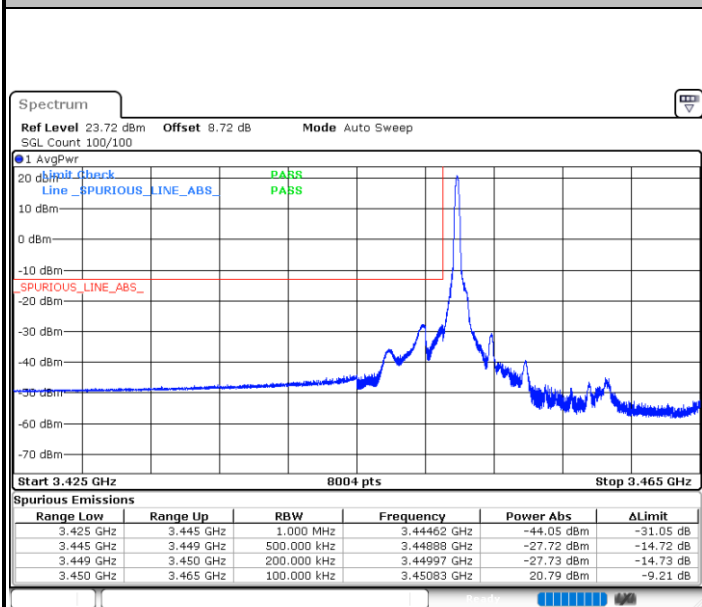

Date: 13.OCT.2023 09:19:14

Highest Channel / 1RBmax

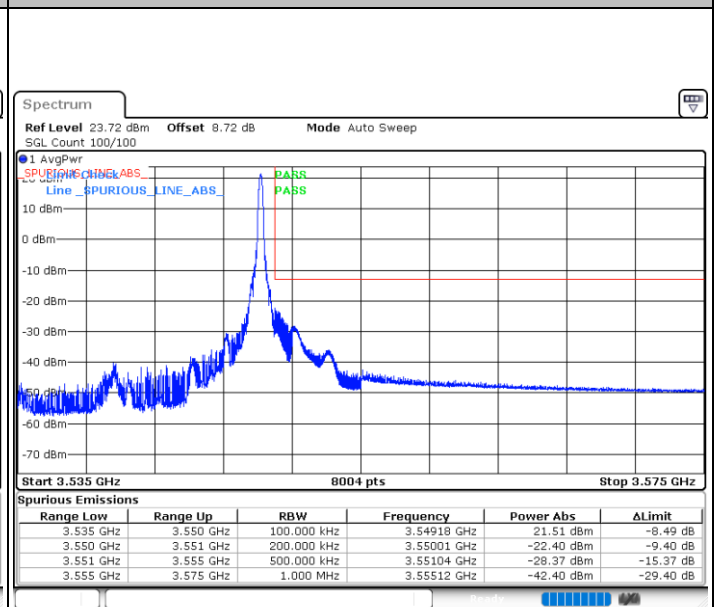

Date: 13.OCT.2023 09:29:46

Lowest Channel / FullIRB

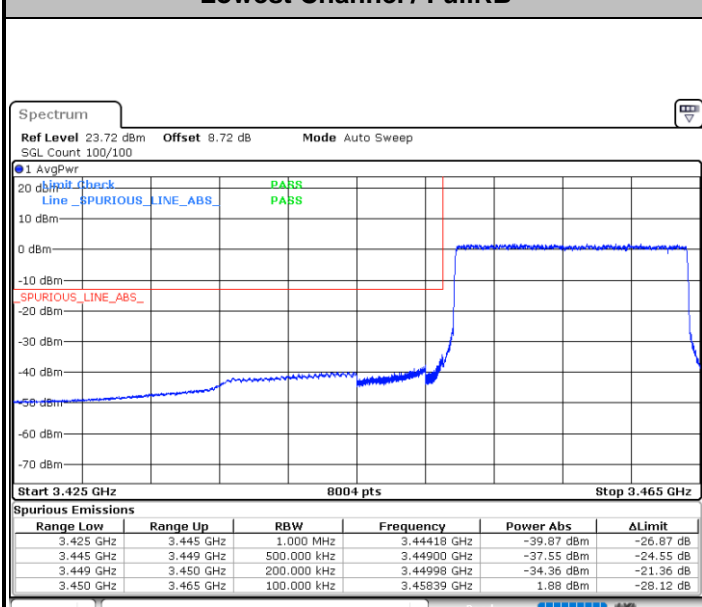

Date: 13.OCT.2023 09:26:00

Highest Channel / FullIRB

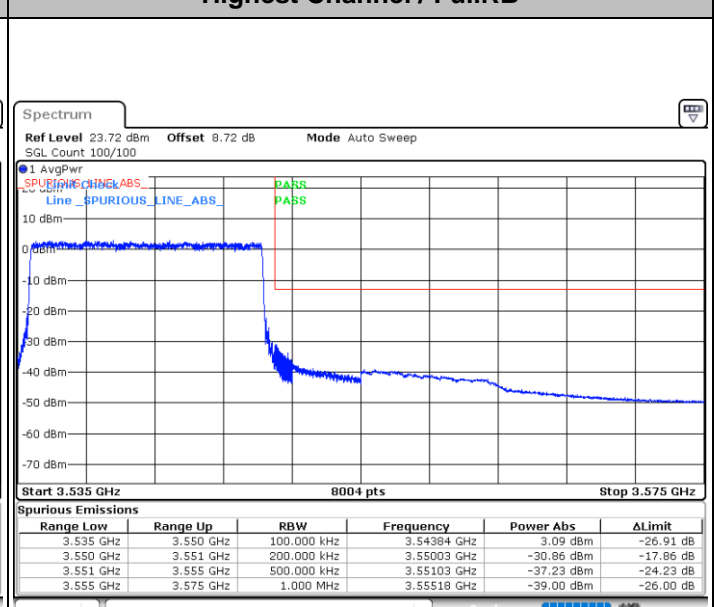

Date: 13.OCT.2023 09:39:50



LTE Band 42 / 15MHz

16QAM

Lowest Channel / 1RB0

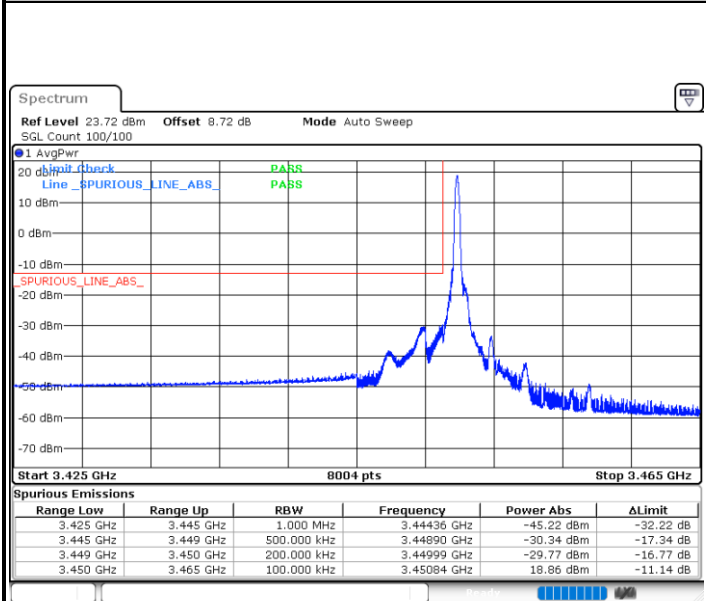

Date: 13.OCT.2023 09:21:05

Highest Channel / 1RBmax

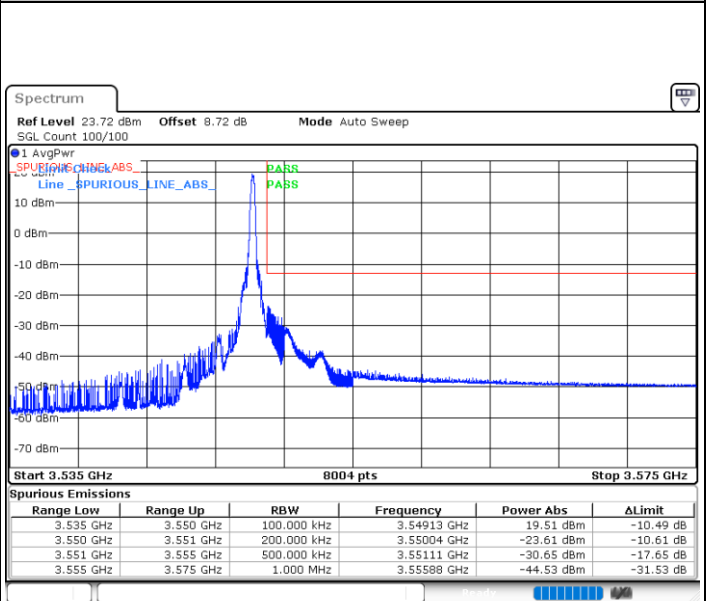

Date: 13.OCT.2023 09:31:37

Lowest Channel / FullRB

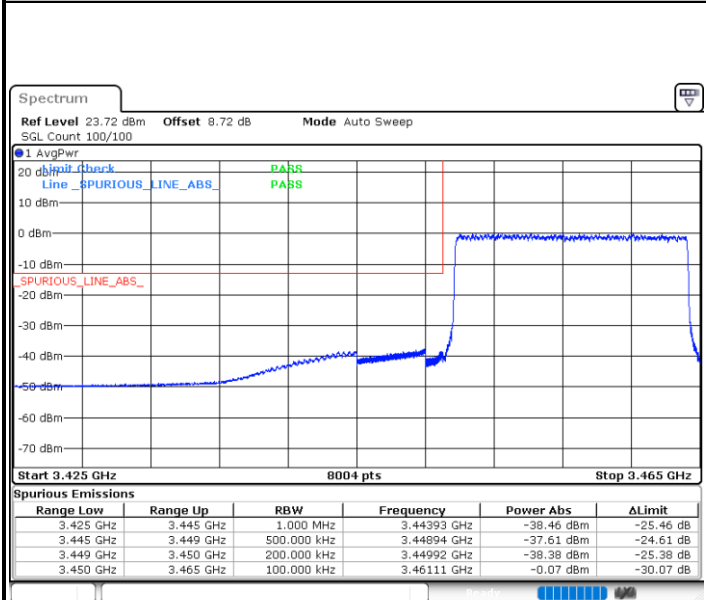

Date: 13.OCT.2023 09:24:10

Highest Channel / FullRB

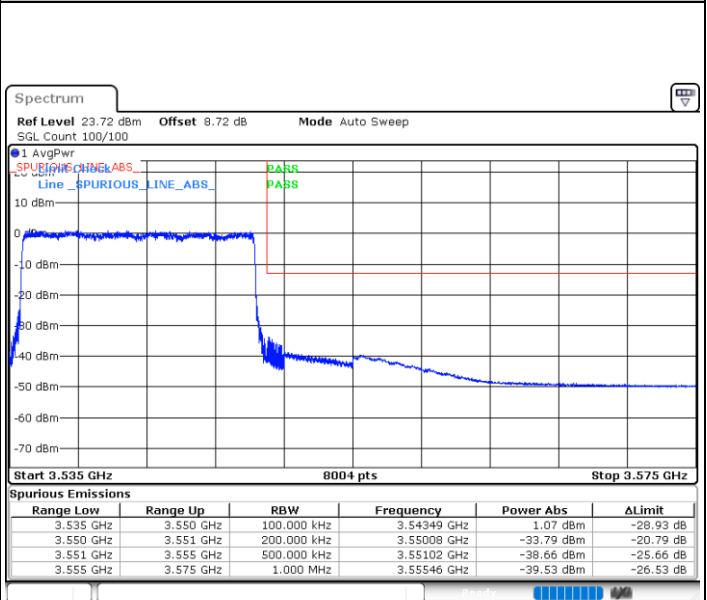

Date: 13.OCT.2023 09:37:59



LTE Band 42 / 15MHz

64QAM

Lowest Channel / 1RB0

Highest Channel / 1RBmax

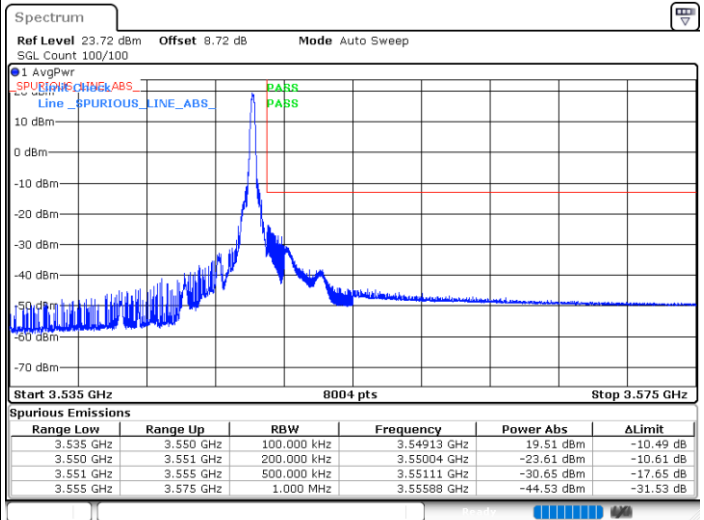
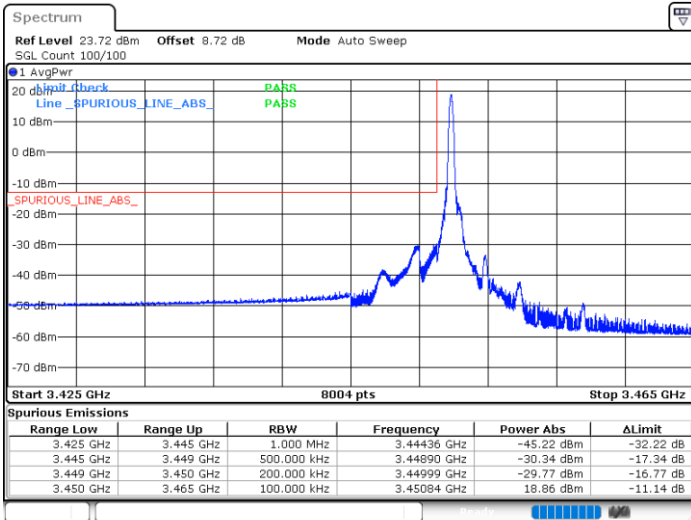

Date: 13.OCT.2023 09:21:05

Date: 13.OCT.2023 09:31:37

Lowest Channel / FullRB

Highest Channel / FullRB

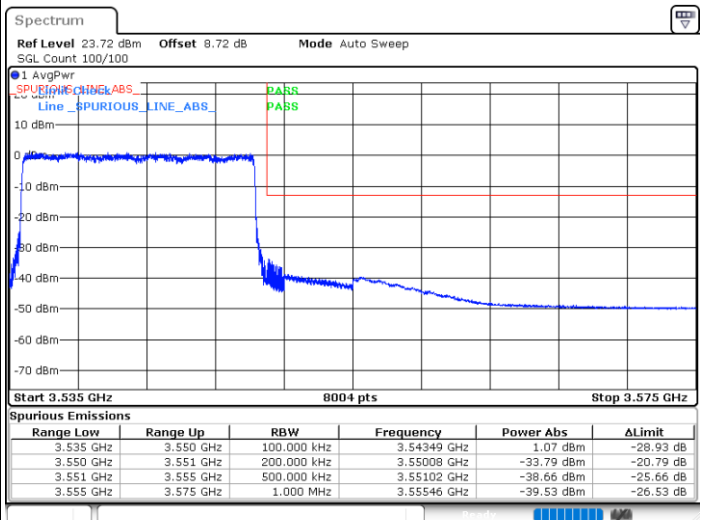
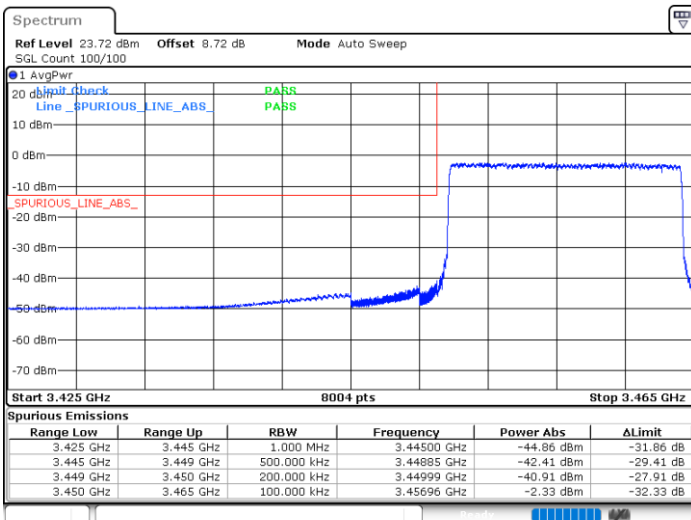

Date: 13.OCT.2023 10:03:23

Date: 13.OCT.2023 09:37:59

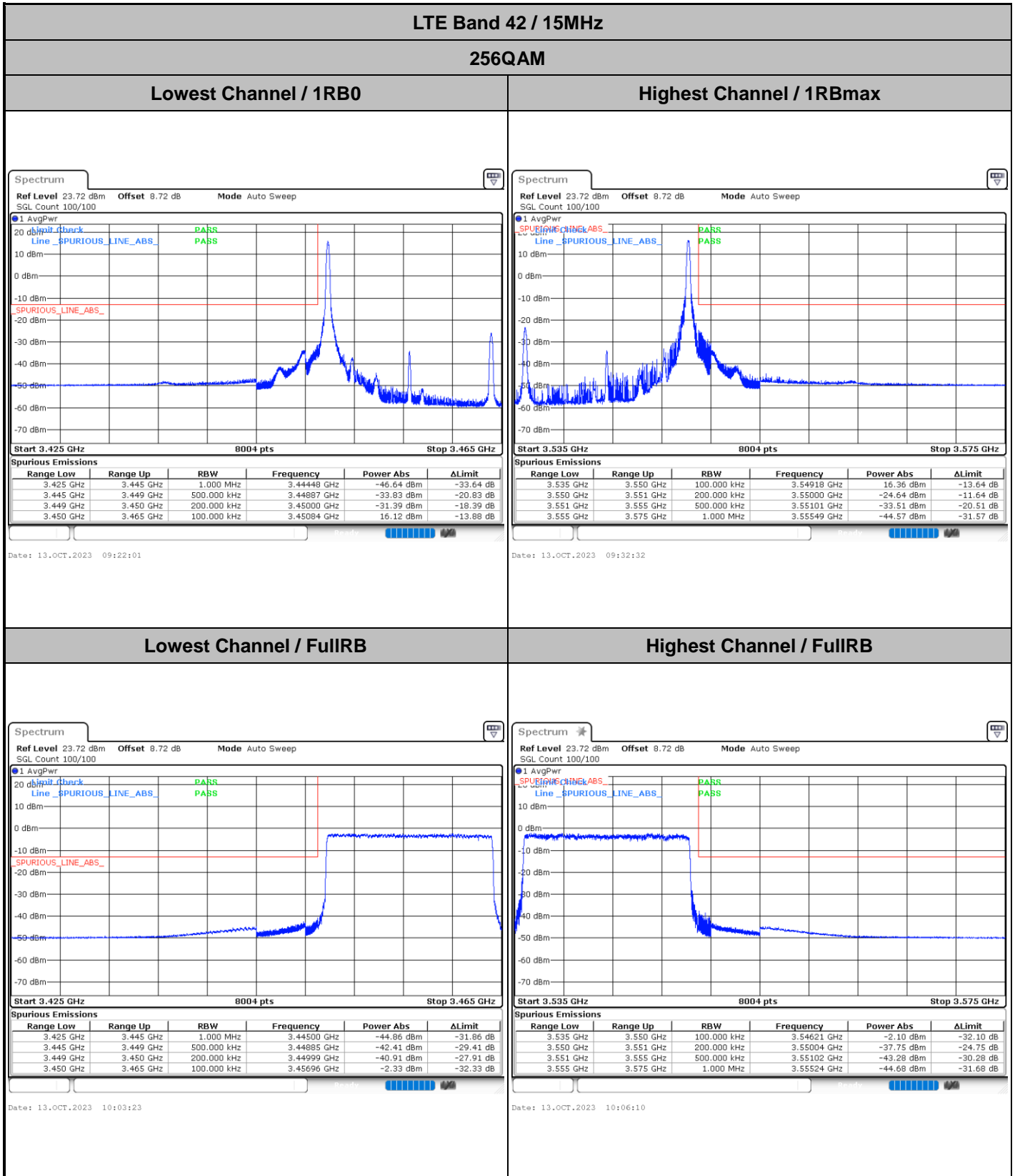



LTE Band 42 / 20MHz

QPSK

Lowest Channel / 1RB0

Highest Channel / 1RBmax

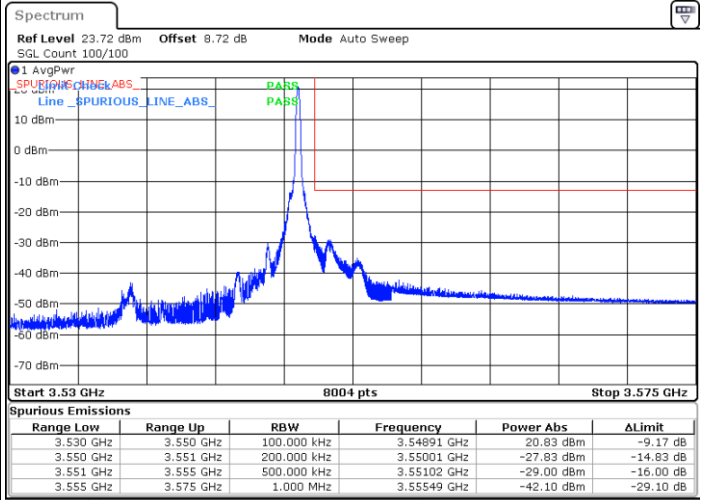
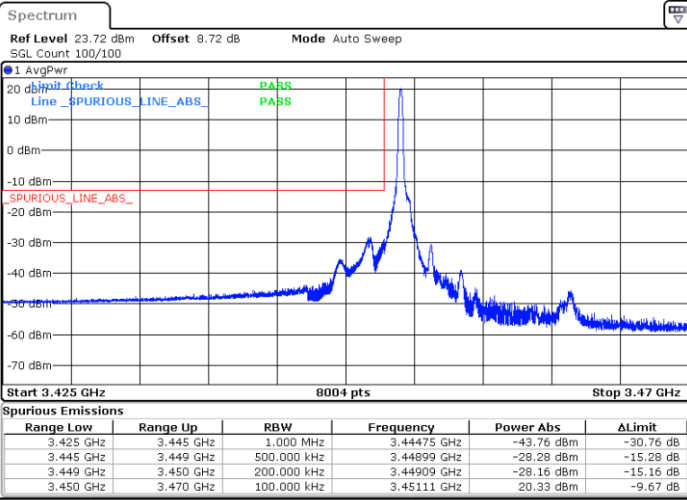

Date: 13.OCT.2023 09:42:11

Date: 13.OCT.2023 09:54:06

Lowest Channel / FullRB

Highest Channel / FullRB

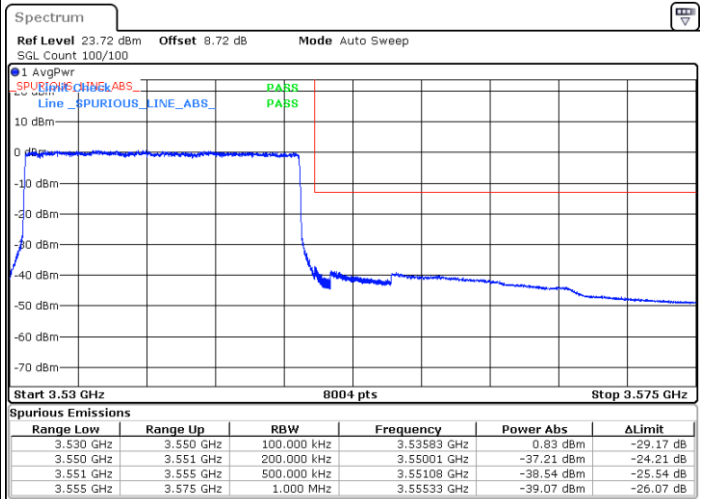
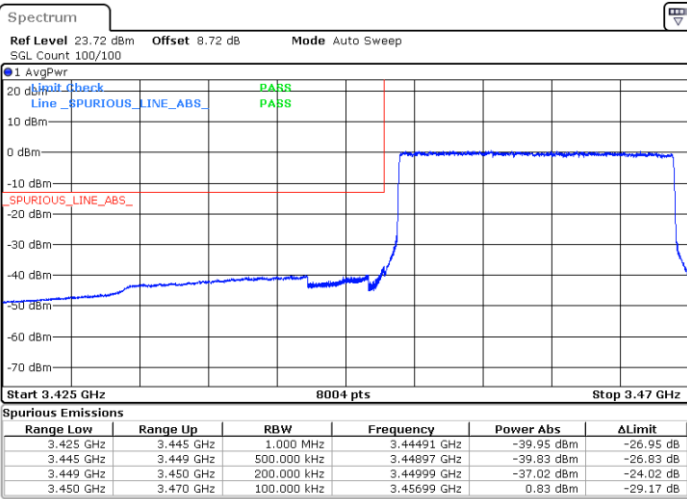

Date: 13.OCT.2023 09:49:27

Date: 13.OCT.2023 10:00:40



LTE Band 42 / 20MHz

16QAM

Lowest Channel / 1RB0

Highest Channel / 1RBmax

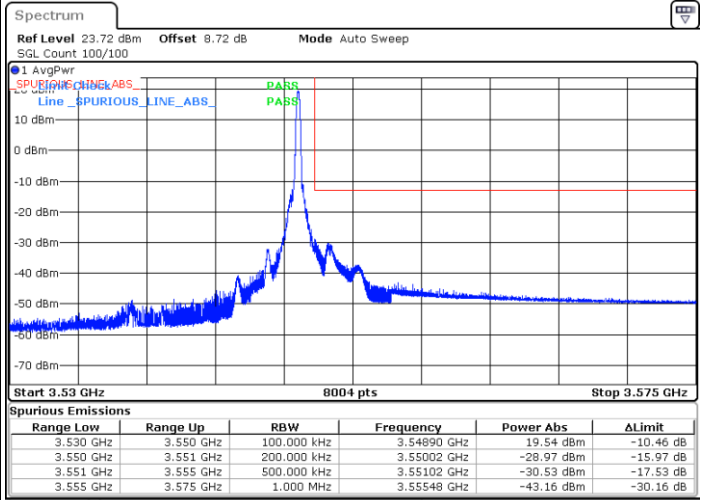
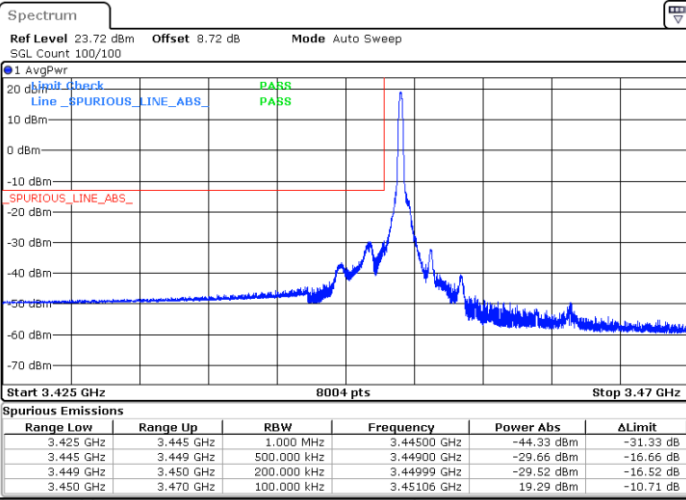

Date: 13.OCT.2023 09:43:06

Date: 13.OCT.2023 09:55:02

Lowest Channel / FullRB

Highest Channel / FullRB

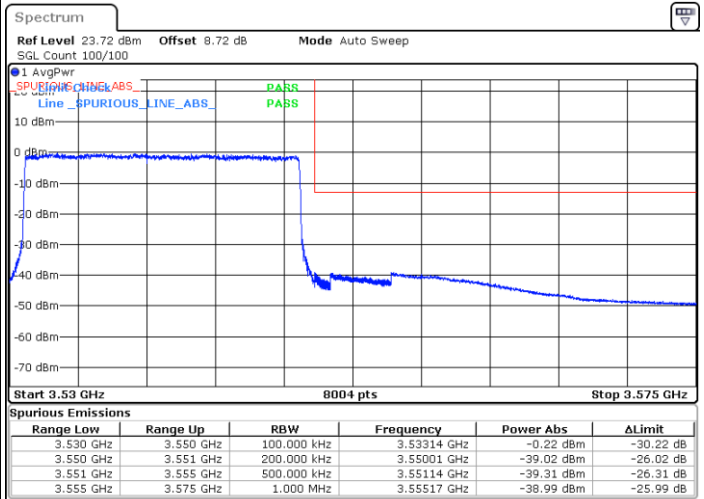
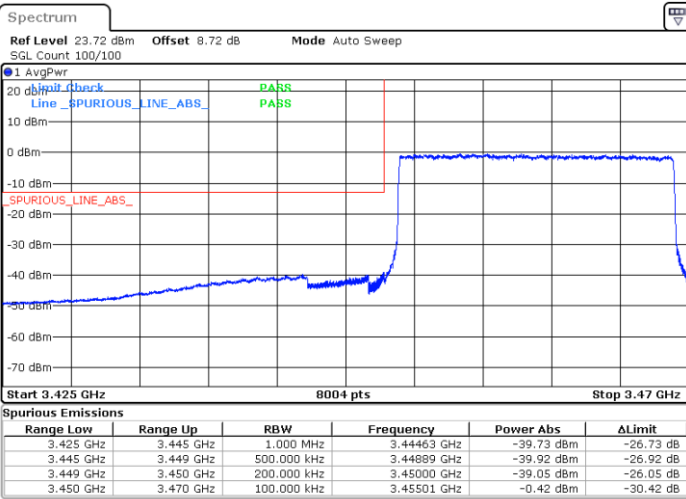

Date: 13.OCT.2023 09:48:32

Date: 13.OCT.2023 09:59:44



LTE Band 42 / 20MHz

64QAM

Lowest Channel / 1RB0

Highest Channel / 1RBmax

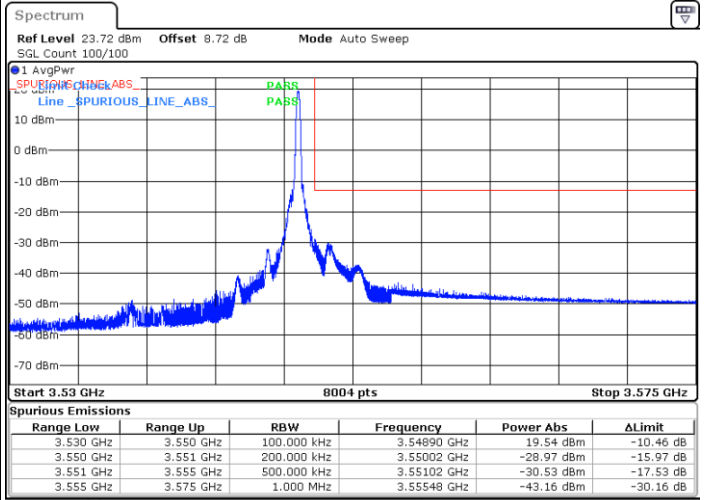
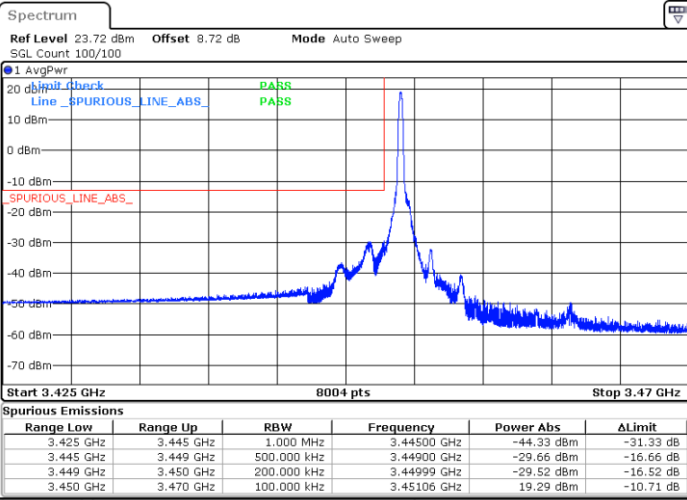

Date: 13.OCT.2023 09:43:06

Date: 13.OCT.2023 09:55:02

Lowest Channel / FullRB

Highest Channel / FullRB

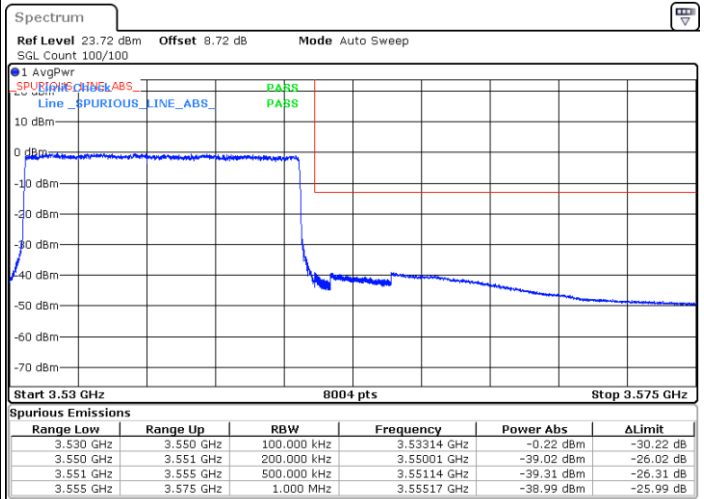
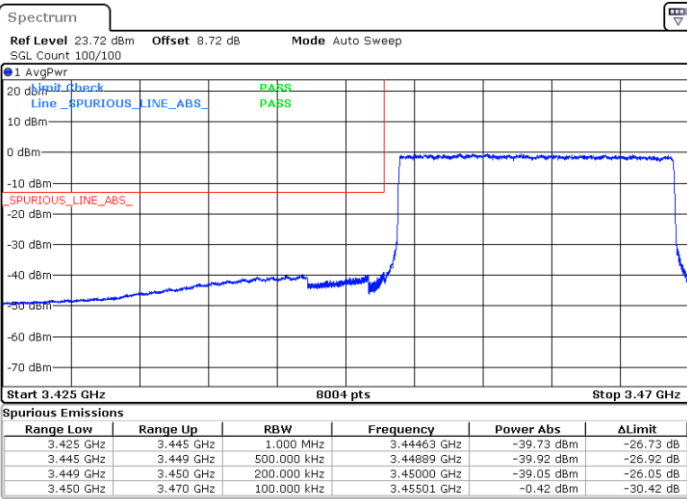

Date: 13.OCT.2023 09:48:32

Date: 13.OCT.2023 09:59:44



LTE Band 42 / 20MHz

256QAM

Lowest Channel / 1RB0

Highest Channel / 1RBmax

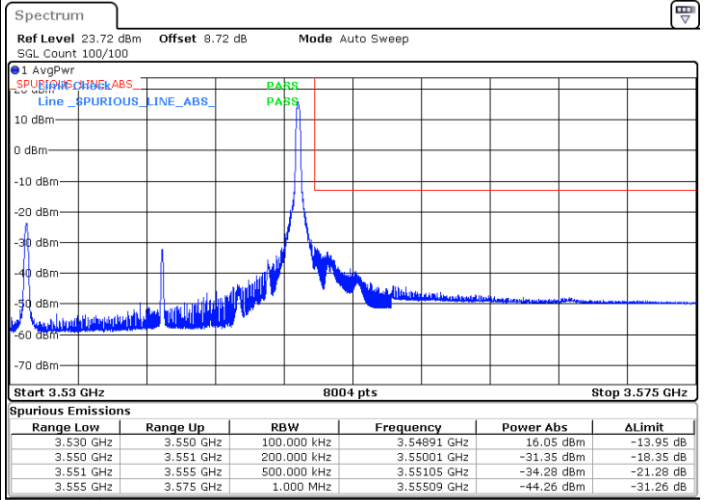
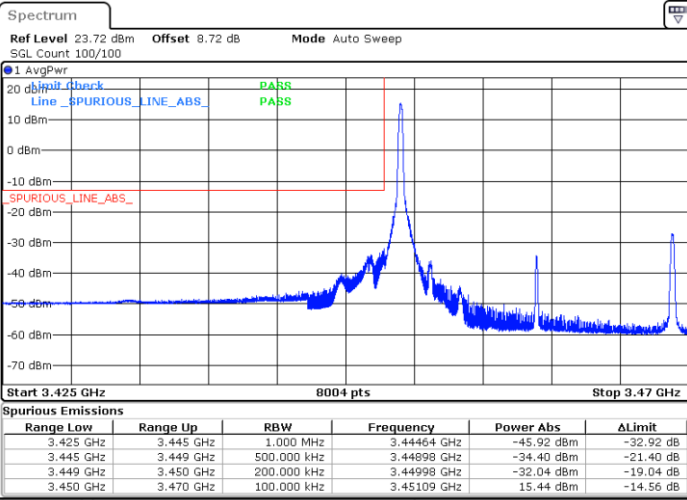

Date: 13.OCT.2023 09:44:58

Date: 13.OCT.2023 09:56:53

Lowest Channel / FullRB

Highest Channel / FullRB

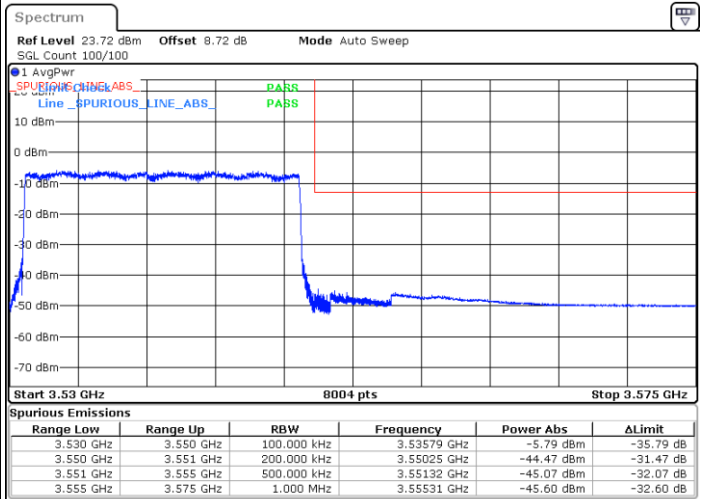
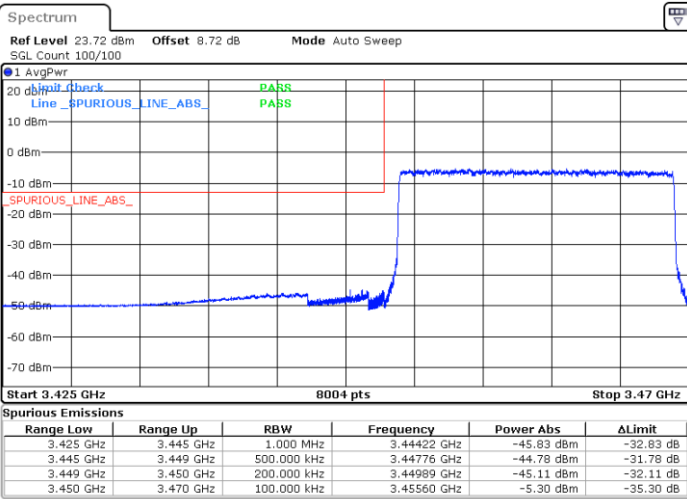

Date: 13.OCT.2023 09:46:18

Date: 13.OCT.2023 09:57:51



Conducted Spurious Emission

LTE Band 42/ 5MHz

QPSK / 1RB0

Lowest Channel

Middle Channel

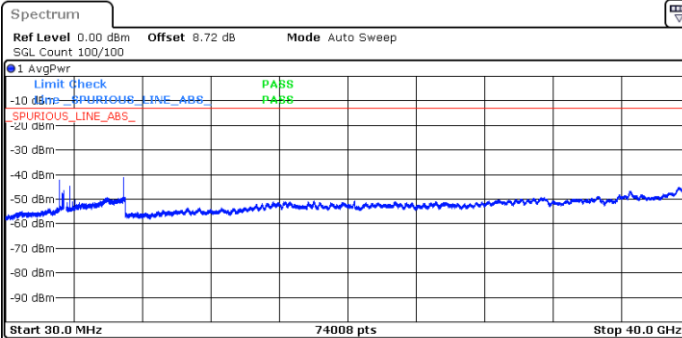

Range Low	Range Up	RBW	Frequency	Power Abs	ΔLimit
30.000 MHz	1.000 GHz	1.000 MHz	980.85207 MHz	-55.00 dBm	-42.00 dB
1.000 GHz	3.425 GHz	1.000 MHz	3.14347 GHz	-42.20 dBm	-29.20 dB
3.575 GHz	7.000 GHz	1.000 MHz	6.90090 GHz	-41.05 dBm	-28.05 dB
7.000 GHz	10.000 GHz	1.000 MHz	9.95069 GHz	-54.63 dBm	-41.63 dB
10.000 GHz	14.000 GHz	1.000 MHz	13.96725 GHz	-53.53 dBm	-40.53 dB
14.000 GHz	18.000 GHz	1.000 MHz	17.70429 GHz	-51.12 dBm	-38.12 dB
18.000 GHz	27.000 GHz	1.000 MHz	18.03075 GHz	-50.74 dBm	-37.74 dB
27.000 GHz	40.000 GHz	1.000 MHz	39.99603 GHz	-44.63 dBm	-31.63 dB

Date: 13.OCT.2023 08:37:17

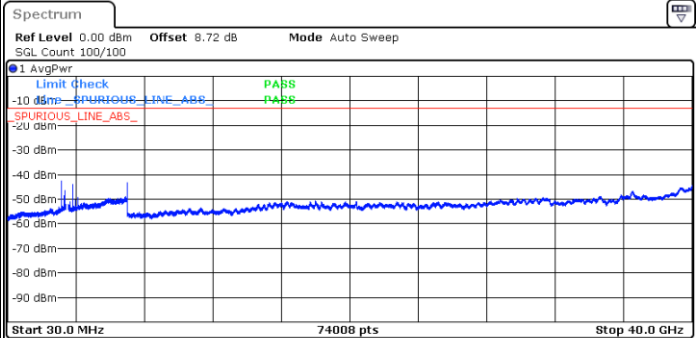

Range Low	Range Up	RBW	Frequency	Power Abs	ΔLimit
30.000 MHz	1.000 GHz	1.000 MHz	990.06247 MHz	-55.26 dBm	-42.26 dB
1.000 GHz	3.425 GHz	1.000 MHz	3.119074 GHz	-42.72 dBm	-29.72 dB
3.575 GHz	7.000 GHz	1.000 MHz	6.99593 GHz	-43.14 dBm	-30.14 dB
7.000 GHz	10.000 GHz	1.000 MHz	9.25816 GHz	-54.52 dBm	-41.52 dB
10.000 GHz	14.000 GHz	1.000 MHz	13.95876 GHz	-53.45 dBm	-40.45 dB
14.000 GHz	18.000 GHz	1.000 MHz	17.70679 GHz	-51.08 dBm	-38.08 dB
18.000 GHz	27.000 GHz	1.000 MHz	18.01625 GHz	-50.85 dBm	-37.85 dB
27.000 GHz	40.000 GHz	1.000 MHz	39.99531 GHz	-44.45 dBm	-31.45 dB

Date: 13.OCT.2023 08:46:58

Highest Channel

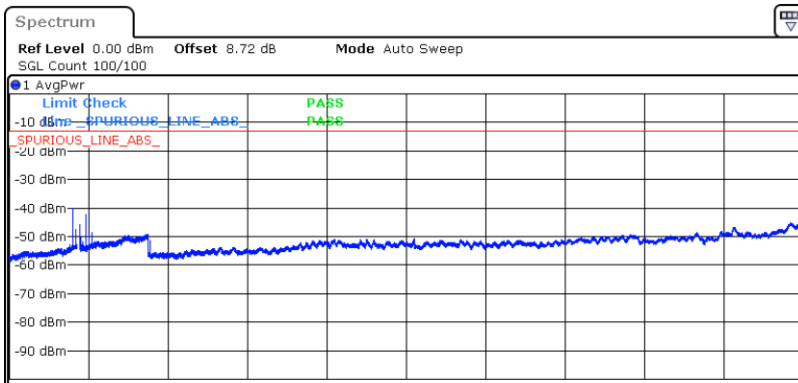

Range Low	Range Up	RBW	Frequency	Power Abs	ΔLimit
30.000 MHz	1.000 GHz	1.000 MHz	916.86407 MHz	-55.17 dBm	-42.17 dB
1.000 GHz	3.425 GHz	1.000 MHz	3.23862 GHz	-40.20 dBm	-27.20 dB
3.575 GHz	7.000 GHz	1.000 MHz	3.85260 GHz	-42.21 dBm	-29.21 dB
7.000 GHz	10.000 GHz	1.000 MHz	7.09093 GHz	-51.54 dBm	-38.54 dB
10.000 GHz	14.000 GHz	1.000 MHz	13.97525 GHz	-53.57 dBm	-40.57 dB
14.000 GHz	18.000 GHz	1.000 MHz	16.37645 GHz	-50.92 dBm	-37.92 dB
18.000 GHz	27.000 GHz	1.000 MHz	20.39812 GHz	-50.83 dBm	-37.83 dB
27.000 GHz	40.000 GHz	1.000 MHz	39.99747 GHz	-44.58 dBm	-31.58 dB

Date: 13.OCT.2023 08:48:23



LTE Band 42/ 10MHz

QPSK / 1RB0

Lowest Channel

Middle Channel

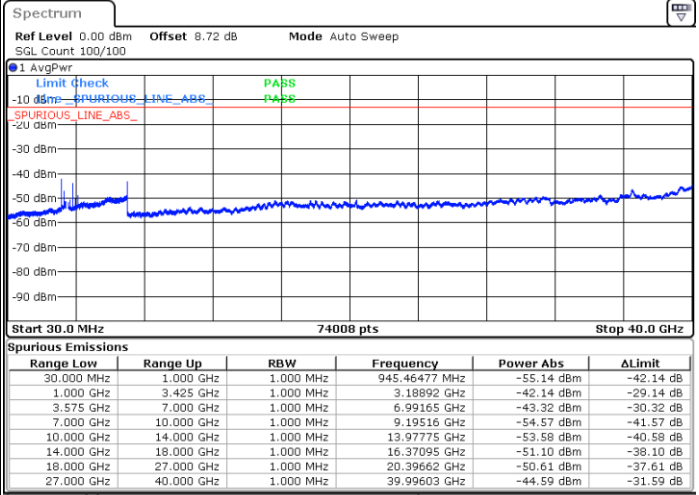
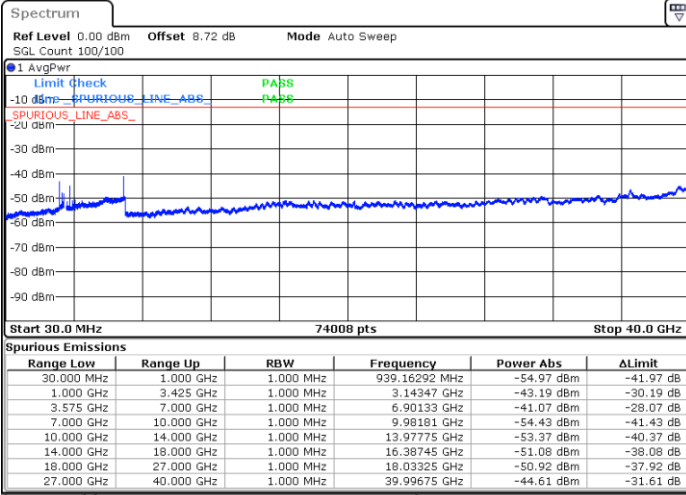

Date: 13.OCT.2023 08:57:31

Date: 13.OCT.2023 09:07:27

Highest Channel

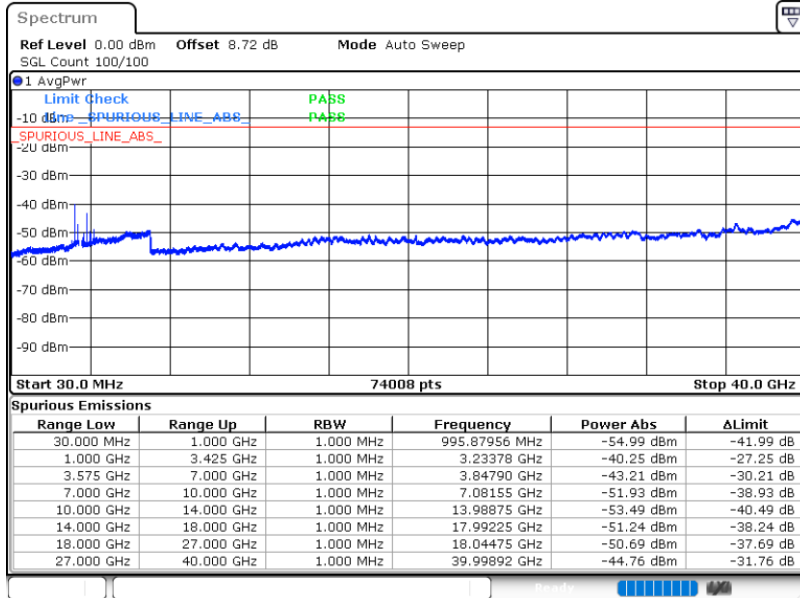

Date: 13.OCT.2023 09:08:52



LTE Band 42/ 15MHz

QPSK / 1RB0

Lowest Channel

Middle Channel

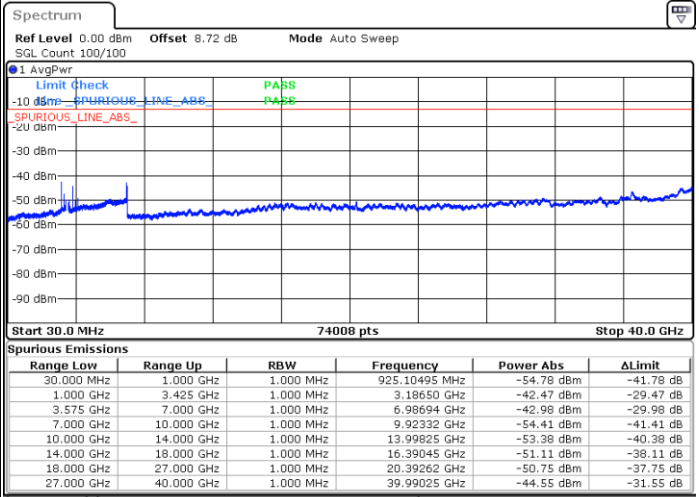
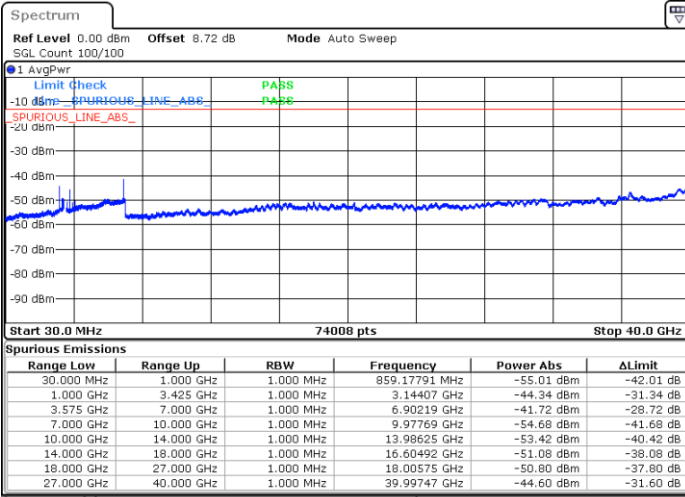

Date: 13.OCT.2023 09:18:18

Date: 13.OCT.2023 09:27:25

Highest Channel

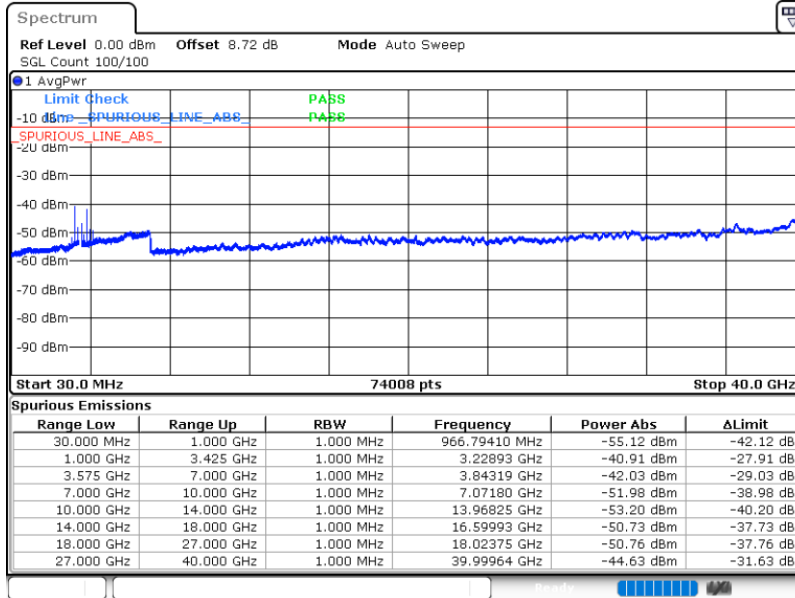

Date: 13.OCT.2023 09:28:50



LTE Band 42/ 20MHz

QPSK / 1RB0

Lowest Channel

Middle Channel

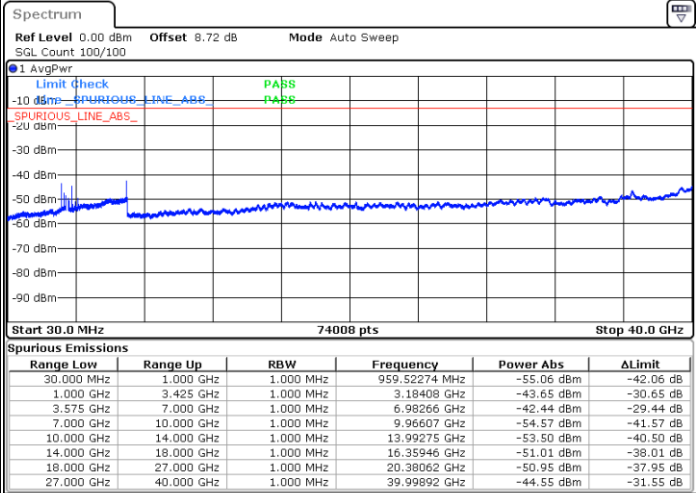
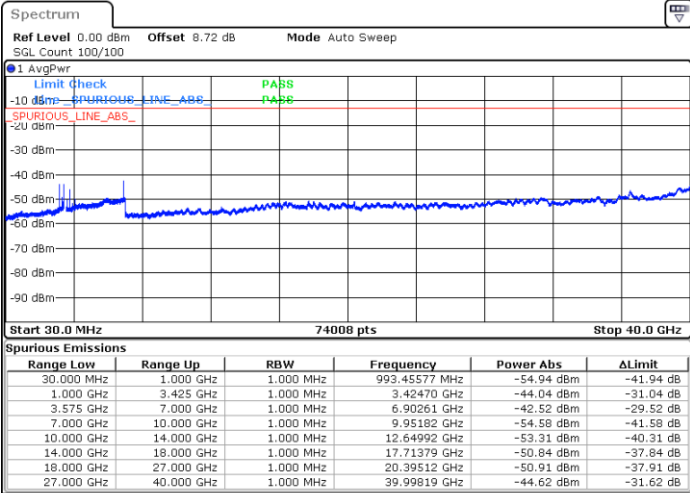

Date: 13.OCT.2023 09:41:15

Date: 13.OCT.2023 09:50:52

Highest Channel

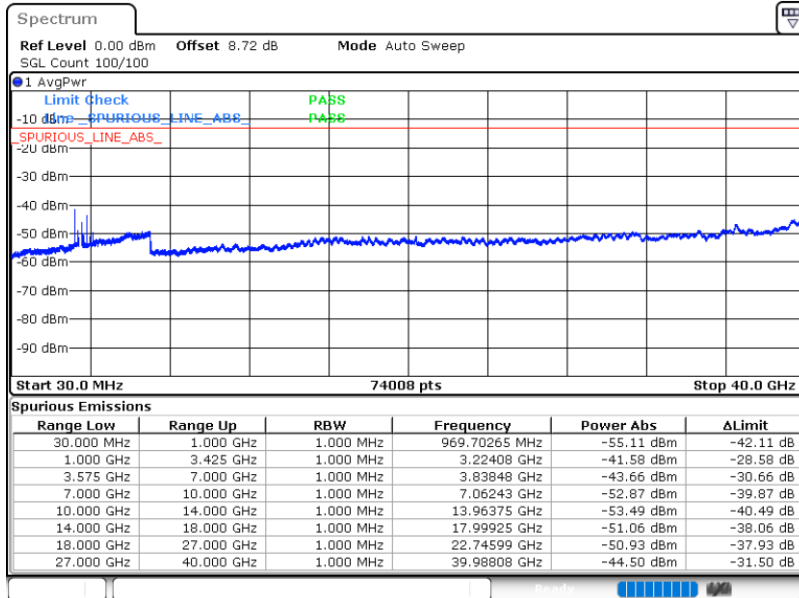

Date: 13.OCT.2023 09:53:11

Frequency Stability

Test Conditions		LTE Band 42 (QPSK) / Middle Channel	Limit
Temperature (°C)	Voltage (Volt)	BW 5MHz	Note 2.
		Deviation (ppm)	Result
50	Normal Voltage	0.0021	PASS
40	Normal Voltage	0.0035	
30	Normal Voltage	0.0012	
20(Ref.)	Normal Voltage	0.0000	
10	Normal Voltage	0.0019	
0	Normal Voltage	0.0005	
-10	Normal Voltage	0.0016	
-20	Normal Voltage	0.0023	
-30	Normal Voltage	0.0034	
20	Maximum Voltage	0.0022	
20	Normal Voltage	0.0005	
20	Battery End Point	0.0013	

Note:

1. Normal Voltage =3.91V ; Battery End Point (BEP) =3.6V ; Maximum Voltage =4.5V
2. Note: The frequency fundamental emissions stay within the authorized frequency block.



Appendix B. Test Results of Radiated Test

Radiated Spurious Emission

Test Engineer :	Chris Chen	Temperature :	23~25°C
		Relative Humidity :	41~42%

LTE Band 42 / 20MHz / QPSK / Ant. 5									
Channel	Frequency (MHz)	EIRP (dBm)	Limit (dBm)	Over Limit (dB)	SPA Reading (dBm)	S.G. Power (dBm)	TX Cable loss (dB)	TX Antenna Gain (dBi)	Polarization (H/V)
Middle	6984	-56.38	-13	-43.38	-66.59	3.03	13.24	6984	H
	10476	-56.86	-13	-43.86	-66.31	3.56	13.01	10476	H
	13968	-60.84	-13	-47.84	-70.36	3.92	13.44	13968	H
	6984	-56.46	-13	-43.46	-66.67	3.03	13.24	6984	V
	10476	-57.57	-13	-44.57	-67.02	3.56	13.01	10476	V
	13968	-60.96	-13	-47.96	-70.48	3.92	13.44	13968	V

Remark: Spurious emissions within 30-1000MHz were found more than 20dB below limit line.