



# FCC RF Test Report

**APPLICANT** : Motorola Mobility LLC  
**EQUIPMENT** : Mobile Cellular Phone  
**BRAND NAME** : Motorola  
**MODEL NAME** : XT2363-2, XT2363-1  
**FCC ID** : IHDT56AQ1  
**STANDARD** : FCC Part 15 Subpart C §15.225  
**CLASSIFICATION** : (DXX) Low Power Communication Device Transmitter  
**TEST DATE(S)** : Sep. 28, 2023 ~ Oct. 23, 2023

We, Sporton International Inc. (Kunshan), would like to declare that the tested sample has been evaluated in accordance with the test procedures and has been in compliance with the applicable technical standards.

The test results in this report apply exclusively to the tested model / sample. Without written approval of Sporton International Inc. (Kunshan), the test report shall not be reproduced except in full.

Jason Jia

Approved by: Jason Jia



**Sporton International Inc. (Kunshan)**

**No. 1098, Pengxi North Road, Kunshan Economic Development Zone Jiangsu Province 215300  
People's Republic of China**



# TABLE OF CONTENTS

**TABLE OF CONTENTS .....2**

**REVISION HISTORY .....3**

**SUMMARY OF THE TEST RESULT .....4**

**1. GENERAL DESCRIPTION .....5**

    1.1 Applicant..... 5

    1.2 Manufacturer ..... 5

    1.3 Product Feature of Equipment Under Test ..... 5

    1.4 Product Specification of Equipment Under Test ..... 5

    1.5 Modification of EUT ..... 6

    1.6 Specification of Accessory..... 6

    1.7 Testing Location ..... 7

    1.8 Test Software ..... 7

    1.9 Applicable Standards..... 7

**2. TEST CONFIGURATION OF EQUIPMENT UNDER TEST .....8**

    2.1 Descriptions of Test Mode ..... 8

    2.2 Connection Diagram of Test System ..... 9

    2.3 Table for Supporting Units ..... 10

    2.4 EUT Operation Test Setup ..... 10

**3. TEST RESULTS.....11**

    3.1 AC Power Line Conducted Emissions Measurement ..... 11

    3.2 20dB and 99% OBW Spectrum Bandwidth Measurement..... 13

    3.3 Frequency Stability Measurement ..... 14

    3.4 Field Strength of Fundamental Emissions and Mask Measurement..... 15

    3.5 Radiated Emissions Measurement ..... 17

    3.6 Antenna Requirements..... 20

**4. LIST OF MEASURING EQUIPMENT .....21**

**5. UNCERTAINTY OF EVALUATION .....22**

**APPENDIX A. TEST RESULTS OF CONDUCTED EMISSION TEST**

**APPENDIX B. TEST RESULTS OF CONDUCTED TEST ITEMS**

    B1. Test Result of 20dB Spectrum Bandwidth

    B2. Test Result of Frequency Stability

**APPENDIX C. TEST RESULTS OF RADIATED TEST ITEMS**

    C1. Test Result of Field Strength of Fundamental Emissions

    C2. Results of Radiated Emissions (9 kHz~30MHz)

    C3. Results of Radiated Emissions (30MHz~1GHz)

**APPENDIX D. SETUP PHOTOGRAPHS**



### REVISION HISTORY

REPORT NO.	VERSION	DESCRIPTION	ISSUED DATE
FR392114D	Rev. 01	Initial issue of report	Oct. 31, 2023



### SUMMARY OF THE TEST RESULT

Report Section	FCC Rule	Description of Test	Result	Remark
3.1	15.207	AC Power Line Conducted Emissions	Complies	Under limit 10.38 dB at 9.451 MHz
3.2	15.215(c)	20dB Spectrum Bandwidth	Complies	-
	-	99% OBW Spectrum Bandwidth	Complies	-
3.3	15.225(e)	Frequency Stability	Complies	-
3.4	15.225(a)(b)(c)	Field Strength of Fundamental Emissions	Complies	Max level 54.32 dB $\mu$ V/m at 13.56 MHz
3.5	15.225(d) & 15.209	Radiated Spurious Emissions	Complies	Under limit 8.53 dB at 46.49 MHz
3.6	15.203	Antenna Requirements	Complies	-

**Conformity Assessment Condition:**

1. The test results (PASS/FAIL) with all measurement uncertainty excluded are presented against the regulation limits or in accordance with the requirements stipulated by the applicant/manufacturer who shall bear all the risks of non-compliance that may potentially occur if measurement uncertainty is taken into account.
2. The measurement uncertainty please refer to each test result in the section "Measurement Uncertainty"

**Disclaimer:**

The product specifications of the EUT presented in the test report that may affect the test assessments are declared by the manufacturer who shall take full responsibility for the authenticity.



# 1. General Description

## 1.1 Applicant

Motorola Mobility LLC

222 W,Merchandise Mart Plaza, Chicago IL 60654 USA

## 1.2 Manufacturer

Motorola Mobility LLC

222 W,Merchandise Mart Plaza, Chicago IL 60654 USA

## 1.3 Product Feature of Equipment Under Test

Product Feature	
Equipment	Mobile Cellular Phone
Brand Name	Motorola
Model Name	XT2363-2, XT2363-1
FCC ID	IHDT56AQ1
IMEI Code	Conducted: 350735340018859/350735340018867 Conduction: 350735340031993/350735340032009 Radiation: 350735340018859/350735340018867
HW Version	DVT2
SW Version	UUG34.30
EUT Stage	Identical Prototype

**Remark:**

1. The above EUT's information was declared by manufacturer. Please refer to the specifications or user's manual for more detailed description.
2. The two model name is only for different market segment purpose.

## 1.4 Product Specification of Equipment Under Test

Standards-related Product Specification	
Tx/Rx Frequency Range	13.553 ~ 13.567MHz
Channel Number	1
20dBW	2.475 KHz
99%OBW	2.098 KHz
Antenna Type	wire coil Antenna
Type of Modulation	ASK

### 1.5 Modification of EUT

No modifications are made to the EUT during all test items.

### 1.6 Specification of Accessory

Specification of Accessory				
AC Adapter 1(US)	Brand Name	Motorola (Aohai)	Model Name	MC-201L
AC Adapter 1(EU)	Brand Name	Motorola (Aohai)	Model Name	MC-202L
AC Adapter 1(UK)	Brand Name	Motorola (Aohai)	Model Name	MC-203L
AC Adapter 1(AU)	Brand Name	Motorola (Aohai)	Model Name	MC-205L
AC Adapter 1(AR)	Brand Name	Motorola (Aohai)	Model Name	MC-206L
AC Adapter 1(IN)	Brand Name	Motorola (Aohai)	Model Name	MC-204
AC Adapter 2(US)	Brand Name	Motorola (Salcomp)	Model Name	MC-201L
AC Adapter 2(EU)	Brand Name	Motorola (Salcomp)	Model Name	MC-202L
AC Adapter 2(UK)	Brand Name	Motorola (Salcomp)	Model Name	MC-203L
AC Adapter 2(AU)	Brand Name	Motorola (Salcomp)	Model Name	MC-205L
AC Adapter 2(AR)	Brand Name	Motorola (Salcomp)	Model Name	MC-206L
AC Adapter 2(BR)	Brand Name	Motorola (Salcomp)	Model Name	MC-207L
AC Adapter 2(Chile)	Brand Name	Motorola (Salcomp)	Model Name	MC-209L
AC Adapter 3(BR)	Brand Name	Motorola (Chenyang)	Model Name	MC-207L
AC Adapter 4(BR local)	Brand Name	Motorola (Cliptech)	Model Name	MC-207L
AC Adapter 5(IN local)	Brand Name	Motorola (XIH)	Model Name	MC-204
Battery 1	Brand Name	Motorola (ATL)	Model Name	QF50
Battery 2	Brand Name	Motorola (SCUD)	Model Name	QF50
Battery 3	Brand Name	Motorola (Sunwoda)	Model Name	QF50
USB Cable 1	Brand Name	Motorola (Saibao)	Model Name	SZN-A026A
USB Cable 2	Brand Name	Motorola (Ju wei )	Model Name	JWUB1606-ZN01H
USB Cable 3	Brand Name	Motorola (Washin)	Model Name	HX-ZN-19



### 1.7 Testing Location

Sporton International Inc. (Kunshan) is accredited to ISO/IEC 17025:2017 by American Association for Laboratory Accreditation with Certificate Number 5145.02.

<b>Test Firm</b>	Sporton International Inc. (Kunshan)				
<b>Test Site Location</b>	No. 1098, Pengxi North Road, Kunshan Economic Development Zone Jiangsu Province 215300 People's Republic of China TEL : +86-512-57900158				
<b>Test Site No.</b>	<b>Sporton Site No.</b>			<b>FCC Designation No.</b>	<b>FCC Test Firm Registration No.</b>
	TH01-KS	03CH02-KS	CO01-KS	CN1257	314309
<b>Test Engineer</b>	Smile	Feng	Amos		
<b>Temperature</b>	22~25°C	21~22°C	25.3~26.2°C		
<b>Relative Humidity</b>	41~42%	41~42%	38~40%		

### 1.8 Test Software

Item	Site	Manufacturer	Name	Version
1.	03CH02-KS	AUDIX	E3	6.2009-8-24a1
2.	CO01-KS	AUDIX	E3	6.2009-8-24

### 1.9 Applicable Standards

According to the specifications of the manufacturer, the EUT must comply with the requirements of the following standards:

- ♦ 47 CFR Part 15 Subpart C §15.225
- ♦ ANSI C63.10-2013



## 2. Test Configuration of Equipment Under Test

### 2.1 Descriptions of Test Mode

Investigation has been done on all the possible configurations.

The following table is a list of the test modes shown in this test report.

Test Items	
AC Power Line Conducted Emissions	Field Strength of Fundamental Emissions
20dB Spectrum Bandwidth	Frequency Stability
Radiated Emissions 9kHz~30MHz	Radiated Emissions 30MHz~1GHz

The EUT pre-scanned in four NFC type, A, B, F, V. The worst type (type F) was recorded in this report. Pre-scanned tests, X, Y, Z in three orthogonal panels to determine the final configuration (Z plane as worst plane) from all possible combinations.

Test Cases	
<b>AC Conducted Emission</b>	Mode 1: GSM 850 Idle + Bluetooth Link + WLAN Link (2.4G) + NFC Tx + USB Cable1 + Adapter1 + Earphone
<b>Remark:</b> For Radiated Test Cases, The tests were performance with Adapter1 and USB Cable1	



## 2.2 Connection Diagram of Test System

<Radiated Emission >

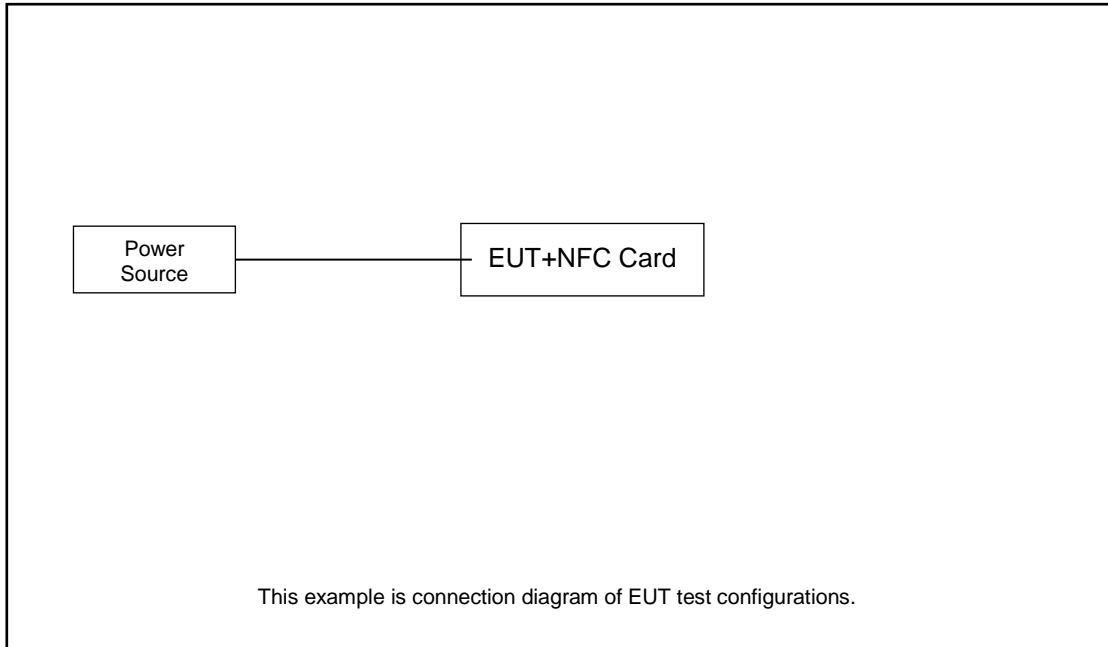

< AC Conducted Emission >

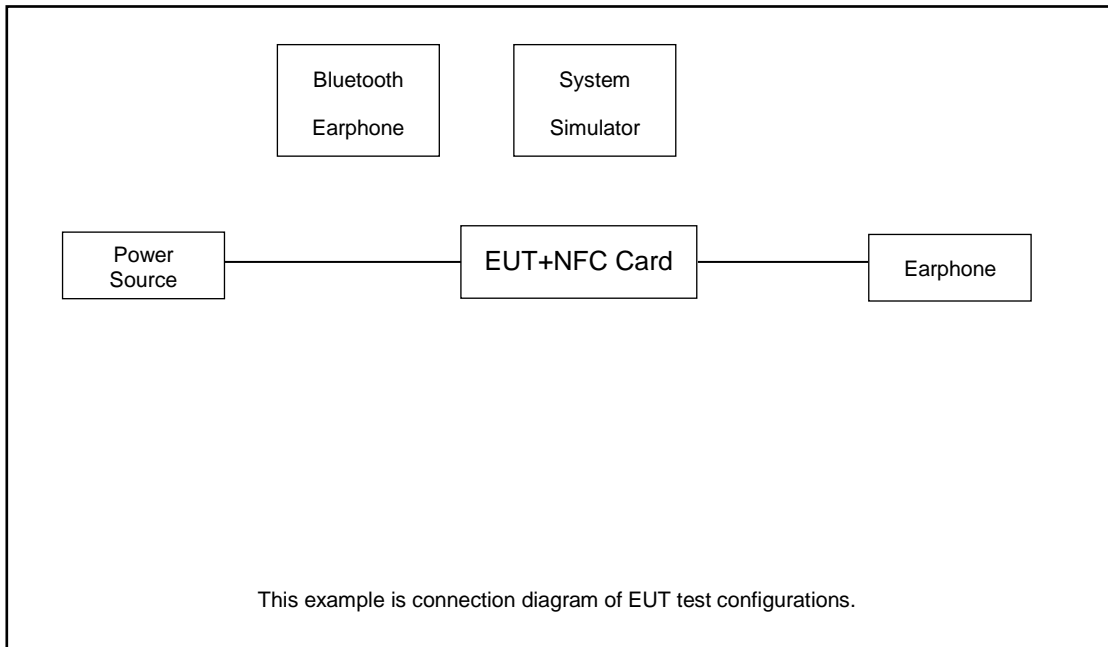

## 2.3 Table for Supporting Units

Item	Equipment	Trade Name	Model Name	FCC ID	Data Cable	Power Cord
1.	LTE Base Station	Anritus	MT8821C	N/A	N/A	Unshielded,1.8m
2.	Bluetooth Earphone	Lenovo	thinkplus-BH3	N/A	N/A	N/A
3.	Notebook	Lenovo	G480	QDS-BRCM1050I	N/A	shielded cable DC O/P 1.8m , Unshielded AC I/P cable 1.8m
4.	WLAN AP	D-link	DIR-655	KA21R655B1	N/A	Unshielded,1.8m
5.	SD Card	Kingston	8GB	N/A	N/A	N/A

## 2.4 EUT Operation Test Setup

The EUT was programmed to be in continuously transmitting mode.

The ancillary equipment, NFC card, is used to make the EUT (NFC) continuously transmit at 13.56MHz and is placed around 0 cm gap to the EUT.

### 3. Test Results

#### 3.1 AC Power Line Conducted Emissions Measurement

##### 3.1.1 Limit of AC Conducted Emission

For equipment that is designed to be connected to the public utility (AC) power line, the radio frequency voltage that is conducted back onto the AC power line on any frequency or frequencies within the band 150 kHz to 30 MHz shall not exceed the limits in the following table.

Frequency of Emission (MHz)	Conducted Limit (dB $\mu$ V)	
	Quasi-Peak	Average
0.15-0.5	66 to 56*	56 to 46*
0.5-5	56	46
5-30	60	50

\*Decreases with the logarithm of the frequency.

##### 3.1.2 Measuring Instruments

See list of measuring instruments of this test report.

##### 3.1.3 Test Procedures

1. The EUT was placed 0.4 meter from the conducting wall of the shielding room, and it was kept at least 80 centimeters from any other grounded conducting surface.
2. Connect EUT to the power mains through a line impedance stabilization network (LISN).
3. All the support units are connecting to the other LISN.
4. The LISN provides 50 ohm coupling impedance for the measuring instrument.
5. The FCC states that a 50 ohm, 50 microhenry LISN should be used.
6. Both sides of AC line were checked for maximum conducted interference.
7. The frequency range from 150 kHz to 30 MHz was searched.
8. Set the test-receiver system to Peak Detect Function and specified bandwidth (IF Bandwidth = 9kHz) with Maximum Hold Mode. Then measurement is also conducted by Average Detector and Quasi-Peak Detector Function respectively.

### 3.1.4 Test setup

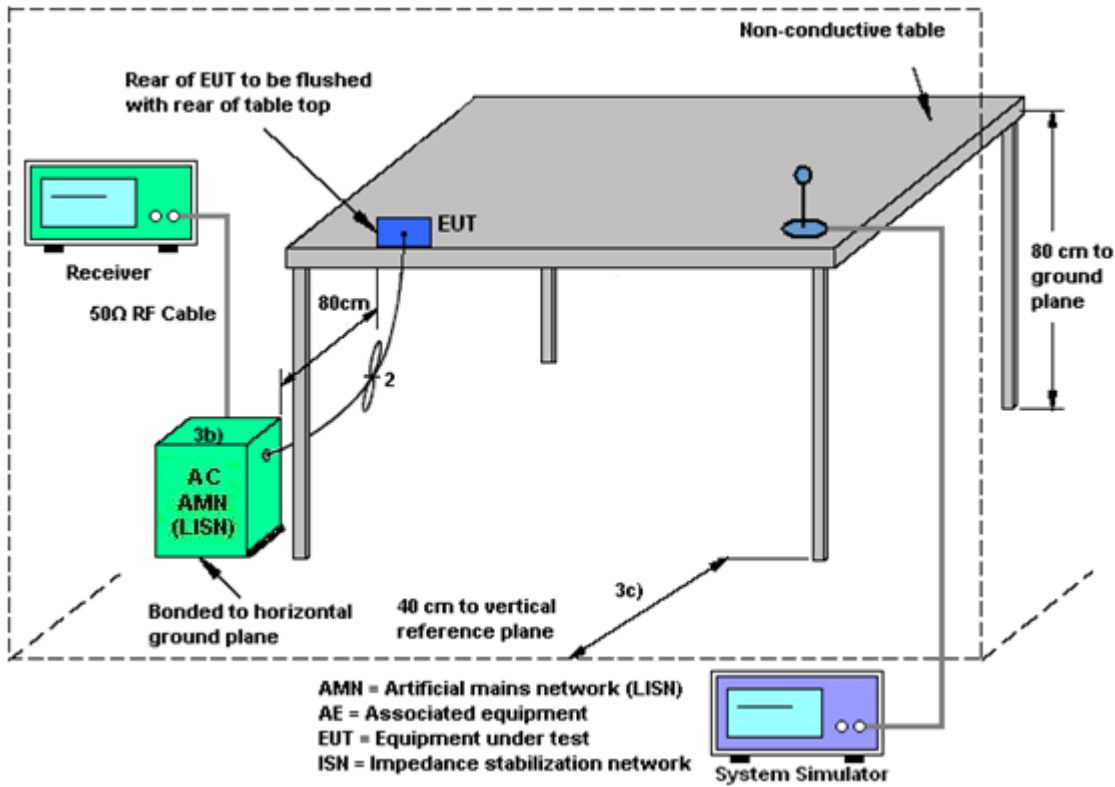

### 3.1.5 Test Result of AC Conducted Emission

Please refer to Appendix A.

## 3.2 20dB and 99% OBW Spectrum Bandwidth Measurement

### 3.2.1 Limit

Intentional radiators must be designed to ensure that the 20dB and 99% emission bandwidth in the specific band 13.553~13.567MHz.

### 3.2.2 Measuring Instruments

See list of measuring instruments of this test report.

### 3.2.3 Test Procedures

1. The spectrum analyzer connected via a receive antenna placed near the EUT in peak Max hold mode.
2. The resolution bandwidth of 1 kHz and the video bandwidth of 3 kHz were used.
3. Measured the spectrum width with power higher than 20dB below carrier.
4. Measured the 99% OBW.

### 3.2.4 Test Setup

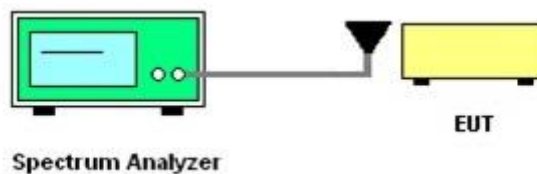

### 3.2.5 Test Result of Conducted Test Items

Please refer to Appendix B.

### 3.3 Frequency Stability Measurement

#### 3.3.1 Limit

The frequency tolerance of the carrier signal shall be maintained within +/- 0.01% (100ppm) of the operating frequency over a temperature variation of -20 degrees to +50 degrees C at normal supply voltage, and for a variation in the primary supply voltage from 85% to 115% of the rated supply voltage at a temperature of 20 degrees C. For battery operated equipment, the equipment tests shall be performed using a new battery.

#### 3.3.2 Measuring Instruments

See list of measuring instruments of this test report.

#### 3.3.3 Test Procedures

1. The spectrum analyzer connected via a receive antenna placed near the EUT.
2. EUT have transmitted signal and fixed channelize.
3. Set the spectrum analyzer span to view the entire emissions bandwidth.
4. Set RBW = 1 kHz, VBW = 3 kHz with peak detector and maxhold settings.
5. The  $f_c$  is declaring of channel frequency. Then the frequency error formula is  $(f_c - f) / f_c \times 10^6$  ppm and the limit is less than  $\pm 100$ ppm.
6. Extreme temperature rule is -20°C~50°C.

#### 3.3.4 Test Setup

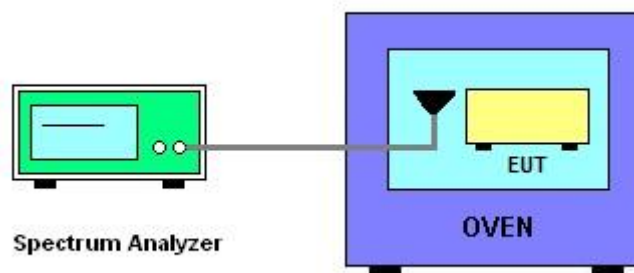

#### 3.3.5 Test Result of Conducted Test Items

Please refer to Appendix B.



### 3.4 Field Strength of Fundamental Emissions and Mask Measurement

#### 3.4.1 Limit

Rules and specifications	FCC CFR 47 Part 15 section 15.225			
Description	Compliance with the spectrum mask is tested with RBW set to 9kHz.			
Freq. of Emission (MHz)	Field Strength ( $\mu\text{V/m}$ ) at 30m	Field Strength ( $\text{dB}\mu\text{V/m}$ ) at 30m	Field Strength ( $\text{dB}\mu\text{V/m}$ ) at 10m	Field Strength ( $\text{dB}\mu\text{V/m}$ ) at 3m
1.705~13.110	30	29.5	48.58	69.5
13.110~13.410	106	40.5	59.58	80.5
13.410~13.553	334	50.5	69.58	90.5
13.553~13.567	15848	84.0	103.08	124.0
13.567~13.710	334	50.5	69.58	90.5
13.710~14.010	106	40.5	59.58	80.5
14.010~30.000	30	29.5	48.58	69.5

#### 3.4.2 Measuring Instruments

See list of measuring instruments of this test report.

### 3.4.3 Test Procedures

1. Configure the EUT according to ANSI C63.10. The EUT was placed on the top of the turntable 0.8 meter above ground. The phase center of the loop receiving antenna mounted antenna tower was placed 3 meters far away from the turntable.
2. Power on the EUT and all the supporting units. The turntable was rotated by 360 degrees to determine the position of the highest radiation.
3. The height of the receiving antenna was fixed at one meter above ground to find the maximum emissions field strength.
4. For Fundamental emissions, use the receiver to measure QP reading.
5. When the radiated emissions limits are expressed in terms of the average value of the emissions, and pulsed operation is employed, the measurement field strength shall be determined by averaging over one complete pulse train, including blanking intervals, as long as the pulse train does not exceed 0.1 seconds. As an alternative (provided the transmitter operates for longer than 0.1 seconds) or in cases where the pulse train exceeds 0.1 seconds, the measured field strength shall be determined from the average absolute voltage during a 0.1 second interval during which the field strength is at its maximum value.
6. Compliance with the spectrum mask is tested with RBW set to 9kHz.

Note: Emission level (dB $\mu$ V/m) = 20 log Emission level ( $\mu$ V/m).

### 3.4.4 Test Setup

For radiated emissions below 30MHz

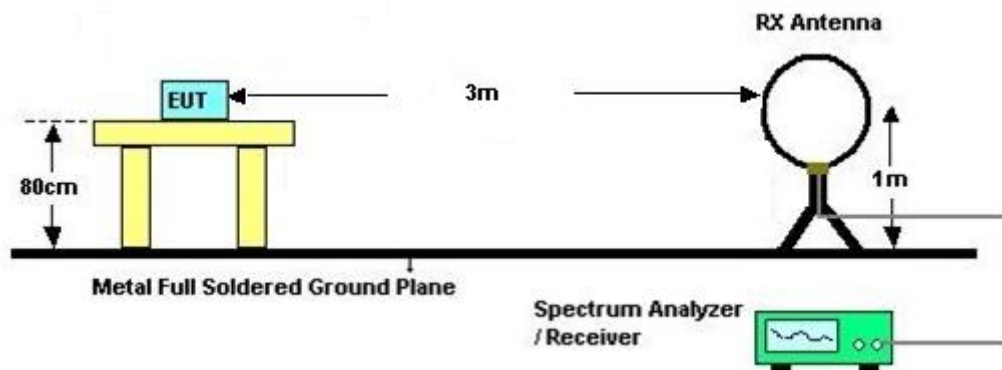

### 3.4.5 Test Result of Field Strength of Fundamental Emissions and Mask

Please refer to Appendix C.



## 3.5 Radiated Emissions Measurement

### 3.5.1 Limit

The field strength of any emissions which appear outside of 13.110 ~14.010MHz band shall not exceed the general radiated emissions limits.

Frequencies (MHz)	Field Strength ( $\mu\text{V/m}$ )	Measurement Distance (meters)
0.009~0.490	2400/F(kHz)	300
0.490~1.705	24000/F(kHz)	30
1.705~30.0	30	30
30~88	100	3
88~216	150	3
216~960	200	3
Above 960	500	3

### 3.5.2 Measuring Instruments

See list of measuring instruments of this test report.

### 3.5.3 Measuring Instrument Setting

The following table is the setting of receiver.

Receiver Parameter	Setting
Attenuation	Auto
Frequency Range: 9kHz~150kHz	RBW 200Hz for QP
Frequency Range: 150kHz~30MHz	RBW 9kHz for QP
Frequency Range: 30MHz~1000MHz	RBW 120kHz for Peak

**Note:** The emission limits shown in the above table are based on measurements employing a CISPR quasi-peak detector except for the frequency bands 9-90 kHz, 110-490 kHz. Radiated emission limits in these two bands are based on measurements employing an average detector.

### 3.5.4 Test Procedures

1. Configure the EUT according to ANSI C63.10. The EUT was placed on the top of the turntable 0.8 meter above ground. The phase center of the receiving antenna mounted on the top of a height-variable antenna tower was placed 3 meters far away from the turntable.
2. Power on the EUT and all the supporting units. The turntable was rotated by 360 degrees to determine the position of the highest radiation.
3. The height of the broadband receiving antenna was varied between one meter and four meters above ground to find the maximum emissions field strength of both horizontal and vertical polarization.
4. For each suspected emissions, the antenna tower was scan (from 1 M to 4 M) and then the turntable was rotated (from 0 degree to 360 degrees) to find the maximum reading.
5. Set the test-receiver system to Peak or CISPR quasi-peak Detect Function with specified bandwidth under Maximum Hold Mode.
6. When the radiated emissions limits are expressed in terms of the average value of the emissions, and pulsed operation is employed, the measurement field strength shall be determined by averaging over one complete pulse train, including blanking intervals, as long as the pulse train does not exceed 0.1 seconds. As an alternative (provided the transmitter operates for longer than 0.1 seconds) or in cases where the pulse train exceeds 0.1 seconds, the measured field strength shall be determined from the average absolute voltage during a 0.1 second interval during which the field strength is at its maximum value.
7. In case the emission is lower than 30MHz, loop antenna has to be used for measurement and the recorded data should be QP measured by receiver. Antenna Requirements

### 3.5.5 Test Setup

For radiated emissions below 30MHz

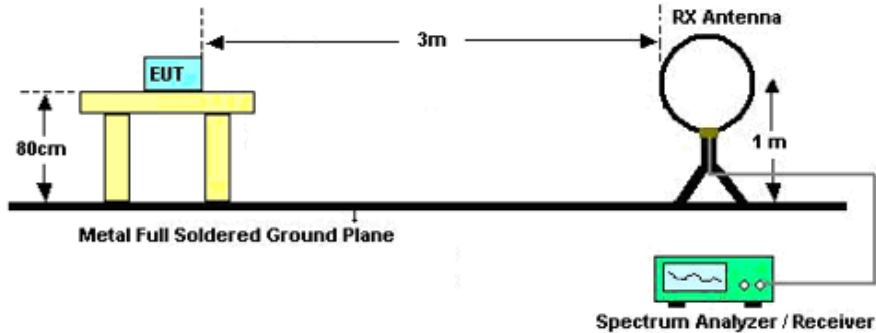

For radiated emissions above 30MHz

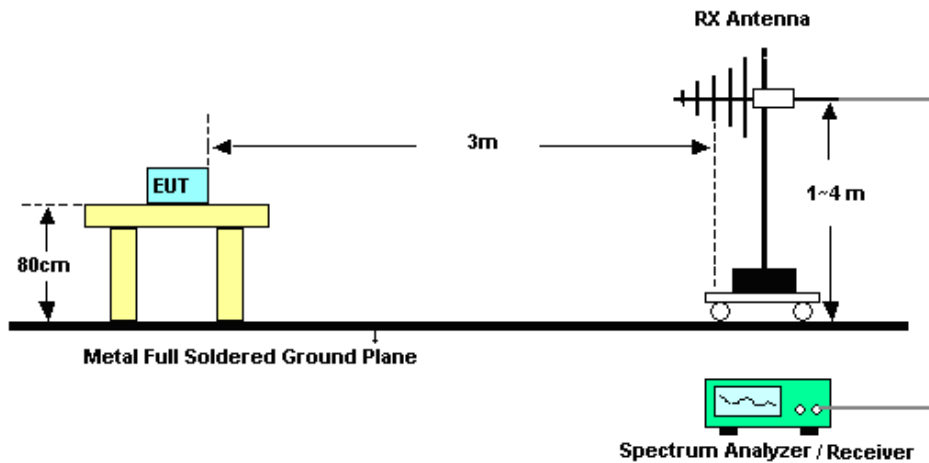

### 3.5.6 Test Result of Radiated Emissions Measurement

Please refer to Appendix C.

**Remark:**

1. There is a comparison data of both open-field test site and semi-Anechoic chamber, and the result came out very similar.
2. Tested for radiated below 30 MHz using a loop antenna in accordance with C63.10, the antenna was positioned in three antenna orientations: parallel, perpendicular, and ground-parallel. Pre-scanned the three antenna orientations, the worst case is parallel & perpendicular polarization, and test data of two mode was reported. (Parallel: The loop antenna is placed vertical axis and aligned along the site axis; Perpendicular: The loop antenna is placed vertical axis and orthogonal to the axis; ground-parallel: The loop antenna is placed horizontal axis and parallel with the ground)



## **3.6 Antenna Requirements**

### **3.6.1 Standard Applicable**

Except for special regulations, the Low-power Radio-frequency Devices must not be equipped with any jacket for installing an antenna with extension cable. An intentional radiator shall be designed to ensure that no antenna other than that furnished by the responsible party shall be used with the device. The use of a permanently attached antenna or of an antenna that uses a unique coupling to the intentional radiator shall be considered sufficient to comply with the provisions of this Section. The manufacturer may design the unit so that the user can replace a broken antenna, but the use of a standard antenna jack or electrical connector is prohibited.

The use of a permanently attached antenna or of an antenna that uses a unique coupling to the intentional radiator shall be considered sufficient to comply with the rule.

### **3.6.2 Antenna Anti-Replacement Construction**

An embedded-in antenna design is used.



## 4. List of Measuring Equipment

Instrument	Manufacturer	Model No.	Serial No.	Characteristics	Calibration Date	Test Date	Due Date	Remark
EMI Test Receiver	R&S	ESR7	101403	9kHz~7GHz;Ma x 30dBm	Oct. 12, 2022	Sep. 28, 2023	Oct. 11, 2023	Radiation (03CH02-KS)
Loop Antenna	R&S	HFH2-Z2E	101125	9kHz~30MHz	Oct.. 16. 2022	Sep. 28, 2023	Oct.. 15, 2023	Radiation (03CH02-KS)
Bilog Antenna	TeseQ	CBL6111D	44483	30MHz-1GHz	Dec. 23, 2022	Sep. 28, 2023	Dec. 22, 2023	Radiation (03CH02-KS)
Amplifier	SONOMA	310N	380826	9KHz-1GHz	Jul 06, 2023	Sep. 28, 2023	Jul 05, 2024	Radiation (03CH02-KS)
AC Power Source	Chroma	61601	616010002473	N/A	NCR	Sep. 28, 2023	NCR	Radiation (03CH02-KS)
Turn Table	MF	MF7802	N/A	0~360 degree	NCR	Sep. 28, 2023	NCR	Radiation (03CH02-KS)
Antenna Mast	MF	MF7802	N/A	1 m~4 m	NCR	Sep. 28, 2023	NCR	Radiation (03CH02-KS)
EMI Receiver	R&S	ESC17	100768	9kHz~7GHz;	May 16, 2023	Oct. 23, 2023	May 15, 2024	Conduction (CO01-KS)
AC LISN (for auxiliary equipment)	MessTec	AN3016	060103	9kHz~30MHz	Oct. 11, 2023	Oct. 23, 2023	Oct. 10, 2024	Conduction (CO01-KS)
AC LISN	MessTec	AN3016	060105	9kHz~30MHz	May 16, 2023	Oct. 23, 2023	May 15, 2024	Conduction (CO01-KS)
AC Power Source	Chroma	61602	ABP00000811	AC 0V~300V, 45Hz~1000Hz	Oct. 11, 2023	Oct. 23, 2023	Oct. 10, 2024	Conduction (CO01-KS)
Spectrum Analyzer	R&S	FSV40	101040	10Hz~40GHz	Oct. 12, 2022	Oct. 09, 2023	Oct. 11, 2023	Conducted (TH01-KS)
DC Power Supply	GW INSTEK	PLR36-10	GET220683	Max 20A, 36V	Jan. 05, 2023	Oct. 09, 2023	Jan. 04, 2024	Conducted (TH01-KS)
Temperature & humidity chamber	Hongzhan	LP-150U	H2014011440	-40~+150°C 20%~95%RH	Jul. 06, 2023	Oct. 09, 2023	Jul. 05, 2024	Conducted (TH01-KS)

NCR: No Calibration Required



### 5. Uncertainty of Evaluation

The measurement uncertainties shown below were calculated in accordance with the requirements of ANSI 63.10-2013. All the measurement uncertainty value were shown with a coverage K=2 to indicate 95% level of confidence. The measurement data show herein meets or exceeds the CISPR measurement uncertainty values specified in CISPR 16-4-2 and can be compared directly to specified limit to determine compliance.

**Uncertainty of Conducted Measurement**

Test Item	Uncertainty
Occupied Channel Bandwidth	±0.1 %

**Uncertainty of Conducted Emission Measurement (150 kHz ~ 30 MHz)**

Measuring Uncertainty for a Level of Confidence of 95% (U = 2Uc(y))	2.94 dB
---------------------------------------------------------------------	---------

**Uncertainty of Radiated Emission Measurement (9 kHz ~ 30 MHz)**

Measuring Uncertainty for a Level of Confidence of 95% (U = 2Uc(y))	3.30 dB
---------------------------------------------------------------------	---------

**Uncertainty of Radiated Emission Measurement (30 MHz ~ 1000 MHz)**

Measuring Uncertainty for a Level of Confidence of 95% (U = 2Uc(y))	6.04 dB
---------------------------------------------------------------------	---------

----- THE END -----



## Appendix A. Test Results of Conducted Emission Test

Test Engineer :	Amos	Temperature :	25.3~26.2°C
		Relative Humidity :	38~40%
Test Voltage :	120Vac / 60Hz	Phase :	Line
Remark :	All emissions not reported here are more than 10 dB below the prescribed limit.		

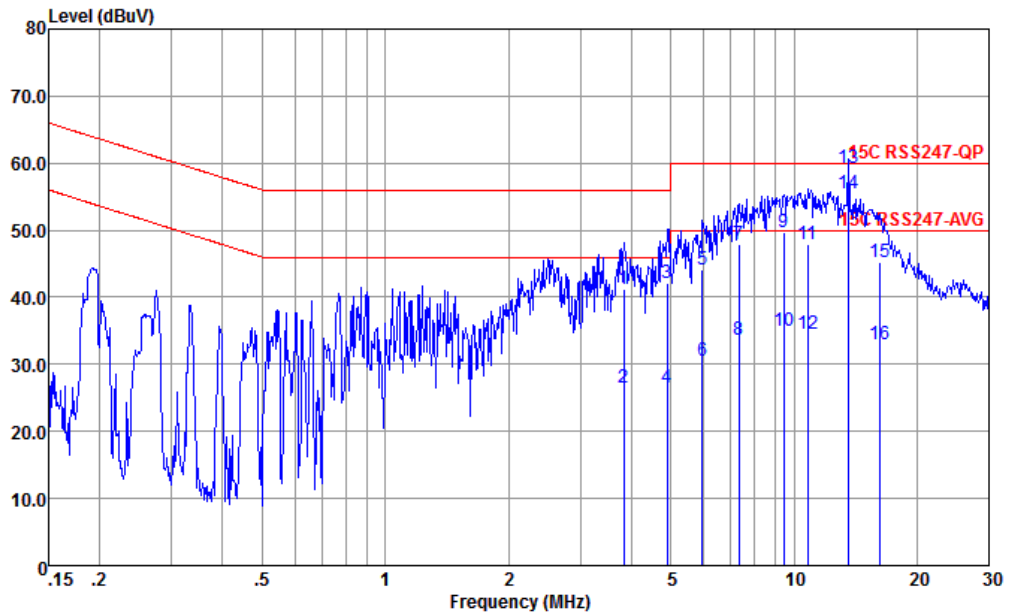

Site : CO01-KS  
 Condition : 15C RSS247-QP LISN-060105-L 2023 LINE

	Freq	Level	Over	Limit	Read	LISN	Cable	Remark
	MHz	dBuV	Limit	Line	Level	Factor	Loss	
			dB	dBuV	dBuV	dB	dB	
1	3.840	41.15	-14.85	56.00	31.20	-0.11	10.06	QP
2	3.840	26.55	-19.45	46.00	16.60	-0.11	10.06	Average
3	4.900	42.12	-13.88	56.00	32.20	-0.14	10.06	QP
4	4.900	26.52	-19.48	46.00	16.60	-0.14	10.06	Average
5	5.961	44.14	-15.86	60.00	34.20	-0.14	10.08	QP
6	5.961	30.54	-19.46	50.00	20.60	-0.14	10.08	Average
7	7.329	47.96	-12.04	60.00	37.80	-0.14	10.30	QP
8	7.329	33.76	-16.24	50.00	23.60	-0.14	10.30	Average
9	9.451	49.62	-10.38	60.00	39.20	-0.16	10.58	QP
10	9.451	34.92	-15.08	50.00	24.50	-0.16	10.58	Average
11	10.790	47.83	-12.17	60.00	37.20	-0.15	10.78	QP
12	10.790	34.53	-15.47	50.00	23.90	-0.15	10.78	Average
13	13.560	59.19			48.20	-0.13	11.12	QP
14 *	13.560	55.39			44.40	-0.13	11.12	Average
15	16.226	45.27	-14.73	60.00	34.19	-0.18	11.26	QP
16	16.226	32.97	-17.03	50.00	21.89	-0.18	11.26	Average

(1) with antenna

Remark: 13.560MHz is the NFC RF fundamental signal.



Test Engineer :	Amos	Temperature :	25.3~26.2°C
		Relative Humidity :	38~40%
Test Voltage :	120Vac / 60Hz	Phase :	Neutral
Remark :	All emissions not reported here are more than 10 dB below the prescribed limit.		

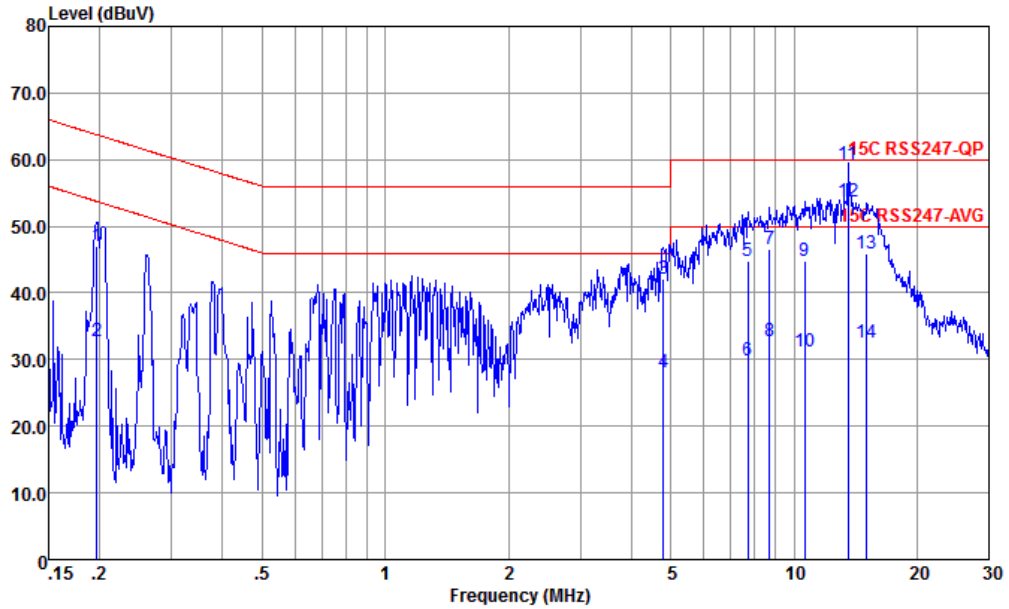

Site : CO01-KS  
 Condition : 15C RSS247-QP LISN-060105-N 2023 NEUTRAL

	Freq	Level	Over	Limit	Read	LISN	Cable	Remark
	MHz	dBuV	dB	dBuV	dBuV	dB	dB	
1	0.197	47.07	-16.69	63.76	36.60	0.05	10.42	QP
2	0.197	32.77	-20.99	53.76	22.30	0.05	10.42	Average
3	4.797	42.13	-13.87	56.00	32.20	-0.13	10.06	QP
4	4.797	28.13	-17.87	46.00	18.20	-0.13	10.06	Average
5	7.728	44.73	-15.27	60.00	34.50	-0.13	10.36	QP
6	7.728	29.83	-20.17	50.00	19.60	-0.13	10.36	Average
7	8.729	46.53	-13.47	60.00	36.20	-0.16	10.49	QP
8	8.729	32.83	-17.17	50.00	22.50	-0.16	10.49	Average
9	10.620	44.77	-15.23	60.00	34.20	-0.19	10.76	QP
10	10.620	31.17	-18.83	50.00	20.60	-0.19	10.76	Average
11	13.560	59.29			48.30	-0.13	11.12	QP
12 *	13.560	53.79			42.80	-0.13	11.12	Average
13	15.066	45.93	-14.07	60.00	34.80	-0.10	11.23	QP
14	15.066	32.63	-17.37	50.00	21.50	-0.10	11.23	Average

(1) with antenna

Remark: 13.560MHz is the NFC RF fundamental signal.





Test Engineer :	Amos	Temperature :	25.3~26.2°C
		Relative Humidity :	38~40%
Test Voltage :	120Vac / 60Hz	Phase :	Line
Remark :	All emissions not reported here are more than 10 dB below the prescribed limit.		

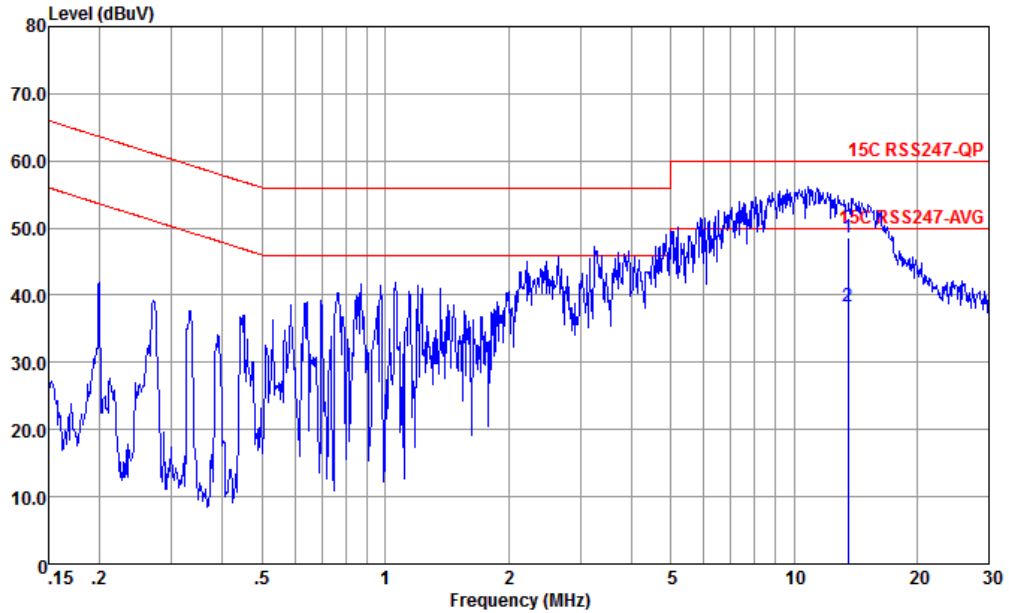

Site : CO01-KS  
Condition : 15C RSS247-QP LISN-060105-L 2023 LINE

	Freq	Level	Over	Limit	Read	LISN	Cable	Remark
	MHz	dBuV	Limit	Line	Level	Factor	Loss	
			dB	dBuV	dBuV	dB	dB	
1 *	13.560	48.59	-11.41	60.00	37.60	-0.13	11.12	QP
2	13.560	38.31	-11.69	50.00	27.32	-0.13	11.12	Average

(2) With dummy load

Remark: Only the fundamental NFC signal needs to be retested per KDB 174176.



Test Engineer :	Amos	Temperature :	25.3~26.2°C
		Relative Humidity :	38~40%
Test Voltage :	120Vac / 60Hz	Phase :	Neutral
Remark :	All emissions not reported here are more than 10 dB below the prescribed limit.		

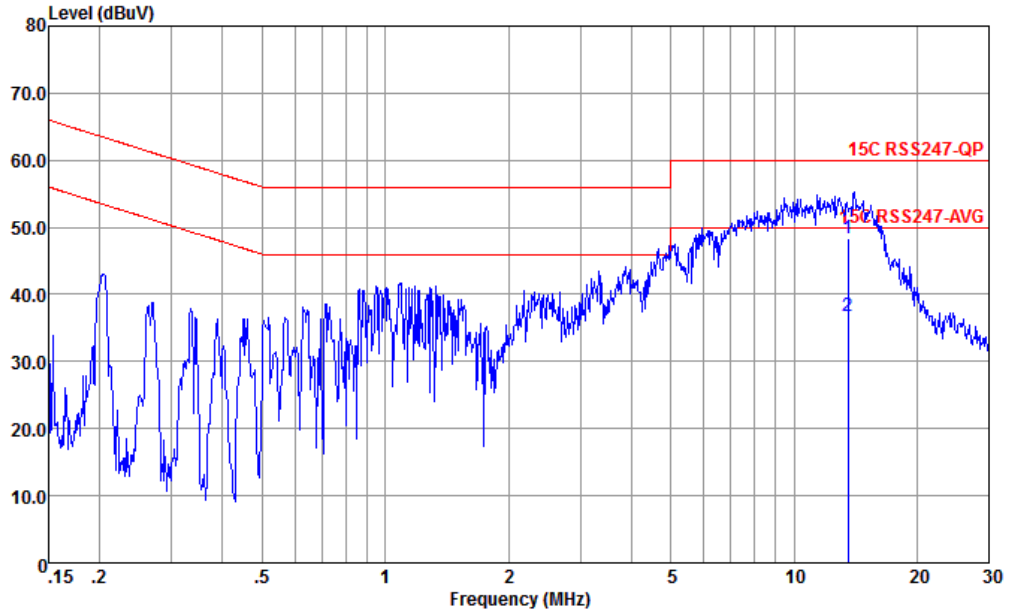

Site : CO01-KS  
 Condition : 15C RSS247-QP LISN-060105-N 2023 NEUTRAL

	Freq	Level	Over	Limit	Read	LISN	Cable	Remark
	MHz	dBuV	Limit	Line	Level	Factor	Loss	
			dB	dBuV	dBuV	dB	dB	
1 *	13.560	48.29	-11.71	60.00	37.30	-0.13	11.12	QP
2	13.560	36.79	-13.21	50.00	25.80	-0.13	11.12	Average

(2) With dummy load

Remark: Only the fundamental NFC signal needs to be retested per KDB 174176.

Note:

- Level(dBμV) = Read Level(dBμV) + LISN Factor(dB) + Cable Loss(dB)
- Over Limit(dB) = Level(dBμV) – Limit Line(dBμV)



# Appendix B. Test Results of Conducted Test Items

## B1. Test Result of 20dB Spectrum Bandwidth

Test mode	NFC Tx	Test Frequency (MHz)	13.56
<b>20dB Bandwidth (kHz)</b>	2.475	<b>99% OccupiedBW(kHz)</b>	2.098
<b>Frequency range (MHz)</b>	$f_L > 13.553$	13.55877	<b>Test Result</b>
	$f_H < 13.567$	13.561245	<b>Complies</b>

**Remark:** Because the measured signal is CW adjusting the RBW per C63.10 would not be practical since measured bandwidth will always follow the RBW and the result will be approximately twice the RBW.



B2. Test Result of Frequency Stability

Startup:

Voltage vs. Frequency Stability		Temperature vs. Frequency Stability	
Voltage (V)	Measurement Frequency (MHz)	Temperature (°C)	Measurement Frequency (MHz)
3.91 V	13.560008	-20	13.560008
3.6 V	13.560008	-10	13.560008
4.5 V	13.560000	0	13.560008
		10	13.560008
		20	13.560008
		30	13.560008
		40	13.560008
		50	13.560008
<b>Max.Deviation (MHz)</b>	0.000008	<b>Max.Deviation (MHz)</b>	0.000008
<b>Max.Deviation (ppm)</b>	0.5531	<b>Max.Deviation (ppm)</b>	0.5531
<b>Limit</b>	<b>FS &lt; ±100 ppm</b>	<b>Limit</b>	<b>FS &lt; ±100 ppm</b>
<b>Test Result</b>	<b>PASS</b>	<b>Test Result</b>	<b>PASS</b>

2MIN:

Voltage vs. Frequency Stability		Temperature vs. Frequency Stability	
Voltage (V)	Measurement Frequency (MHz)	Temperature (°C)	Measurement Frequency (MHz)
3.91 V	13.560000	-20	13.560000
3.6 V	13.560000	-10	13.560000
4.5 V	13.560000	0	13.560008
		10	13.560000
		20	13.560000
		30	13.560000
		40	13.560000
		50	13.560000
<b>Max.Deviation (MHz)</b>	0.000000	<b>Max.Deviation (MHz)</b>	0.000008
<b>Max.Deviation (ppm)</b>	0.0000	<b>Max.Deviation (ppm)</b>	0.5531
<b>Limit</b>	<b>FS &lt; ±100 ppm</b>	<b>Limit</b>	<b>FS &lt; ±100 ppm</b>
<b>Test Result</b>	<b>PASS</b>	<b>Test Result</b>	<b>PASS</b>



5MIN:

Voltage vs. Frequency Stability		Temperature vs. Frequency Stability	
Voltage (V)	Measurement Frequency (MHz)	Temperature (°C)	Measurement Frequency (MHz)
3.91 V	13.560000	-20	13.560000
3.6 V	13.560000	-10	13.560000
4.5 V	13.560000	0	13.560000
		10	13.560000
		20	13.560000
		30	13.560000
		40	13.560008
		50	13.560000
<b>Max.Deviation (MHz)</b>	0.000000	<b>Max.Deviation (MHz)</b>	0.000008
<b>Max.Deviation (ppm)</b>	0.0000	<b>Max.Deviation (ppm)</b>	0.5531
<b>Limit</b>	<b>FS &lt; ±100 ppm</b>	<b>Limit</b>	<b>FS &lt; ±100 ppm</b>
<b>Test Result</b>	<b>PASS</b>	<b>Test Result</b>	<b>PASS</b>

10MIN:

Voltage vs. Frequency Stability		Temperature vs. Frequency Stability	
Voltage (V)	Measurement Frequency (MHz)	Temperature (°C)	Measurement Frequency (MHz)
3.91 V	13.560008	-20	13.560008
3.6 V	13.560008	-10	13.560008
4.5 V	13.560008	0	13.560008
		10	13.560008
		20	13.560008
		30	13.560008
		40	13.560008
		50	13.560008
<b>Max.Deviation (MHz)</b>	0.000008	<b>Max.Deviation (MHz)</b>	0.000008
<b>Max.Deviation (ppm)</b>	0.5531	<b>Max.Deviation (ppm)</b>	0.5531
<b>Limit</b>	<b>FS &lt; ±100 ppm</b>	<b>Limit</b>	<b>FS &lt; ±100 ppm</b>
<b>Test Result</b>	<b>PASS</b>	<b>Test Result</b>	<b>PASS</b>



## Appendix C. Test Results of Radiated Test Items

### C1. Test Result of Field Strength of Fundamental Emissions

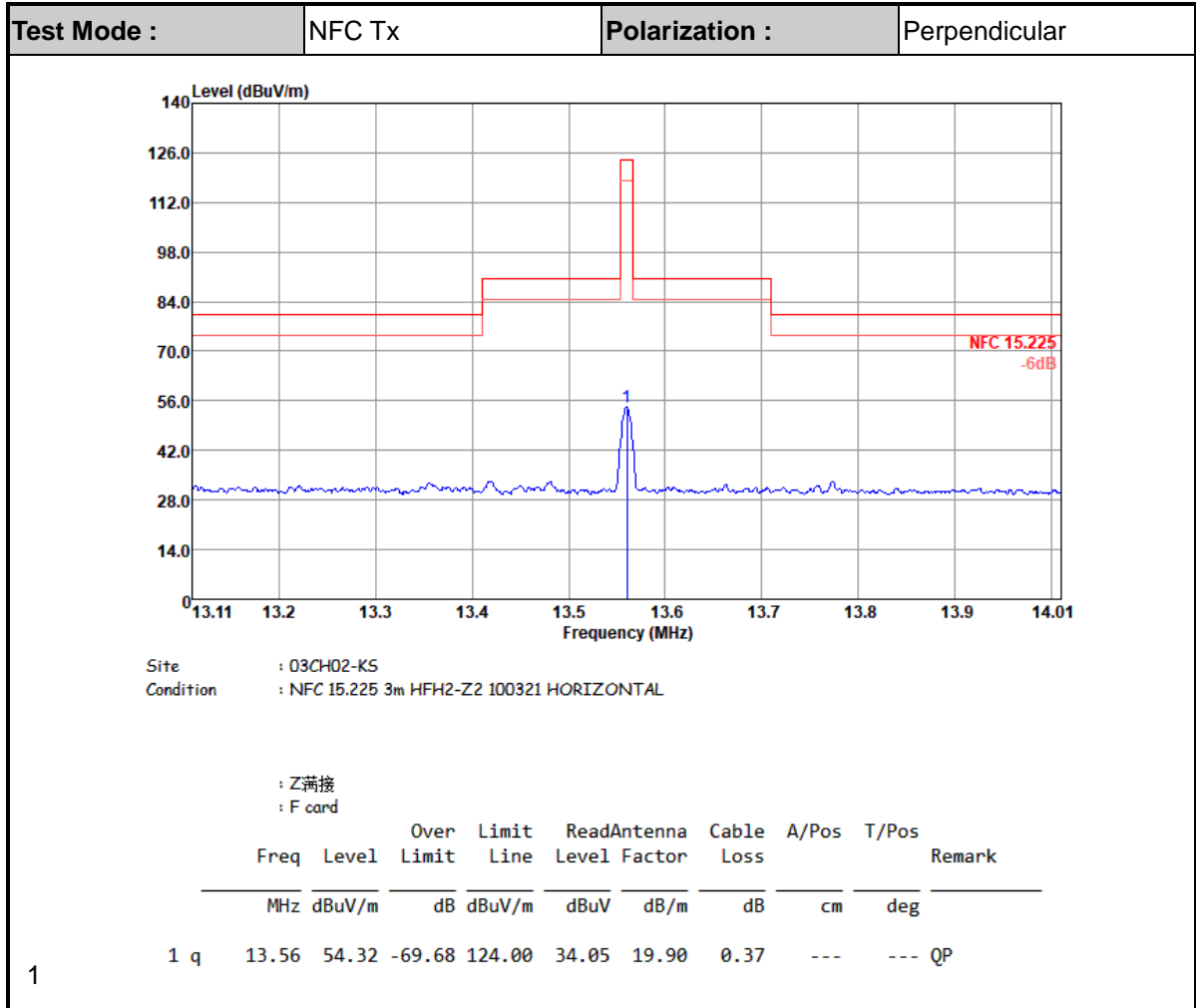

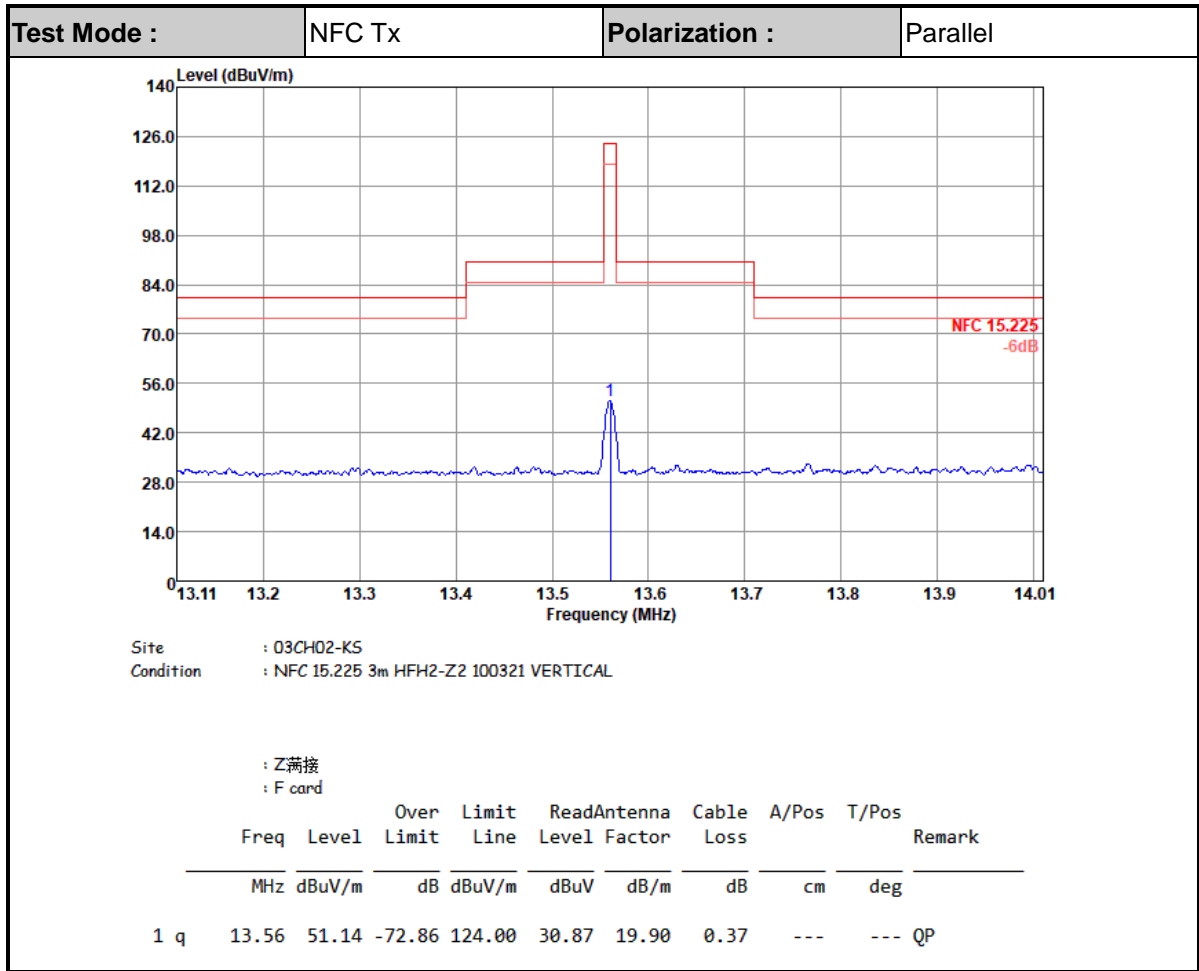

Note:

1. Level(dBμV/m) = Read Level(dBμV) + Antenna Factor(dB/m) + Cable Loss(dB)
2. Over Limit(dB) = Level(dBμV/m) – Limit Line(dBμV/m)



C2. Results of Radiated Spurious Emissions (9 kHz~30MHz)

Test Mode :		NFC Tx			Polarization :		Perpendicular		
Frequency ( MHz )	Level ( dBµV/m )	Over Limit ( dB )	Limit Line ( dBµV/m )	Read Level (dBµV)	Antenna Factor ( dB )	Cable Loss ( dB )	Ant Pos ( cm )	Table Pos ( deg )	Remark
0.08	46.92	-63.03	109.95	26.65	20.25	0.02	-	-	Average
0.11	41.96	-65.06	107.02	21.74	20.2	0.02	-	-	Average
1.12	53.27	-13.36	66.63	33.16	20.06	0.05	-	-	QP
2.37	46.81	-22.73	69.54	26.31	20.42	0.08	-	-	QP
9.94	39.07	-30.47	69.54	18.49	20.29	0.29	-	-	QP
26.55	32	-37.54	69.54	11.56	19.76	0.68	-	-	QP

Test Mode :		NFC Tx			Polarization :		Parallel		
Frequency ( MHz )	Level ( dBµV/m )	Over Limit ( dB )	Limit Line ( dBµV/m )	Read Level (dBµV)	Antenna Factor ( dB )	Cable Loss ( dB )	Ant Pos ( cm )	Table Pos ( deg )	Remark
0.06	44.26	-66.75	111.01	23.99	20.25	0.02	-	-	Average
0.07	43.31	-66.92	110.23	23.04	20.25	0.02	-	-	Average
1.63	49.68	-13.68	63.36	29.3	20.32	0.06	-	-	QP
2.37	48.17	-21.37	69.54	27.67	20.42	0.08	-	-	QP
16.23	45.31	-24.23	69.54	25.32	19.55	0.44	-	-	QP
27.34	31.51	-38.03	69.54	11.02	19.79	0.7	-	-	QP

Note:

1. The amplitude of spurious emissions which are attenuated by more than 20dB below the permissible value has no need to be reported.
2. Distance extrapolation factor = 40 log (specific distance / test distance) (dB);
3. Limit line = specific limits (dBµV) + distance extrapolation factor.





C3. Results of Radiated Spurious Emissions (30MHz~1GHz)

Test Mode :		NFC Tx				Polarization :		Horizontal			
Frequency ( MHz )	Level ( dBμV/m )	Over Limit ( dB )	Limit Line ( dBμV/m )	Read Level ( dBμV )	Antenna Factor ( dB )	Cable Loss ( dB )	Preamp Factor ( dB )	Ant Pos ( cm )	Table Pos ( deg )	Remark	
30.97	21.99	-18.01	40	29.99	24.2	0.76	32.96	-	-	Peak	
173.56	25.68	-17.82	43.5	41.35	15.16	1.92	32.75	-	-	Peak	
296.75	22.84	-23.16	46	34.03	19.11	2.53	32.83	-	-	Peak	
607.15	27.04	-18.96	46	31.29	25.62	3.65	33.52	-	-	Peak	
761.38	29.61	-16.39	46	30.72	28.07	4.1	33.28	-	-	Peak	
961.2	32.51	-21.49	54	28.67	31.02	4.61	31.79	-	-	Peak	

Test Mode :		NFC Tx				Polarization :		Vertical			
Frequency ( MHz )	Level ( dBμV/m )	Over Limit ( dB )	Limit Line ( dBμV/m )	Read Level ( dBμV )	Antenna Factor ( dB )	Cable Loss ( dB )	Preamp Factor ( dB )	Ant Pos ( cm )	Table Pos ( deg )	Remark	
46.49	31.47	-8.53	40	47.53	15.93	0.96	32.95	-	-	Peak	
178.41	25.89	-17.61	43.5	41.79	14.92	1.95	32.77	-	-	Peak	
321.97	20.79	-25.21	46	31.63	19.42	2.64	32.9	-	-	Peak	
515	24.5	-21.5	46	30.75	24.03	3.15	33.43	-	-	Peak	
741.01	28.96	-17.04	46	30.03	28.21	4.05	33.33	-	-	Peak	
965.08	32.71	-21.29	54	28.8	31.03	4.62	31.74	-	-	Peak	

Note:

1. The amplitude of spurious emissions which are attenuated by more than 20dB below the permissible value has no need to be reported.
2. Emission level (dBμV/m) = 20 log Emission level (μV/m).
3. Corrected Reading: Antenna Factor + Cable Loss + Read Level - Preamp Factor= Level.