

System Check_750MHz

DUT: D750V3-SN:1099

Communication System: UID 0, CW (0); Frequency: 750 MHz; Duty Cycle: 1:1

Medium: HSL_750_231022 Medium parameters used: $f = 750 \text{ MHz}$; $\sigma = 0.883 \text{ S/m}$; $\epsilon_r = 40.81$; $\rho = 1000 \text{ kg/m}^3$

Ambient Temperature : 23.1 °C; Liquid Temperature : 22.1 °C

DASY5 Configuration:

- Probe: EX3DV4 - SN3975; ConvF(9.6, 10.16, 9.47); Calibrated: 2023/6/22
- Sensor-Surface: 1.4mm (Mechanical Surface Detection)
- Electronics: DAE4 Sn715; Calibrated: 2023/1/23
- Phantom: Twin-SAM1(P1aP2a20); Type: QD 000 P40 CD; Serial: TP:1670
- Measurement SW: DASY52, Version 52.10 (3); SEMCAD X Version 14.6.13 (7474)

Pin=250mW/Area Scan (61x61x1): Interpolated grid: $dx=1.500 \text{ mm}$, $dy=1.500 \text{ mm}$
Maximum value of SAR (interpolated) = 2.63 W/kg

Pin=250mW/Zoom Scan (5x5x7)/Cube 0: Measurement grid: $dx=8\text{mm}$, $dy=8\text{mm}$, $dz=5\text{mm}$

Reference Value = 56.04 V/m; Power Drift = 0.03 dB

Peak SAR (extrapolated) = 2.94 W/kg

SAR(1 g) = 2.02 W/kg; SAR(10 g) = 1.35 W/kg

Maximum value of SAR (measured) = 2.65 W/kg

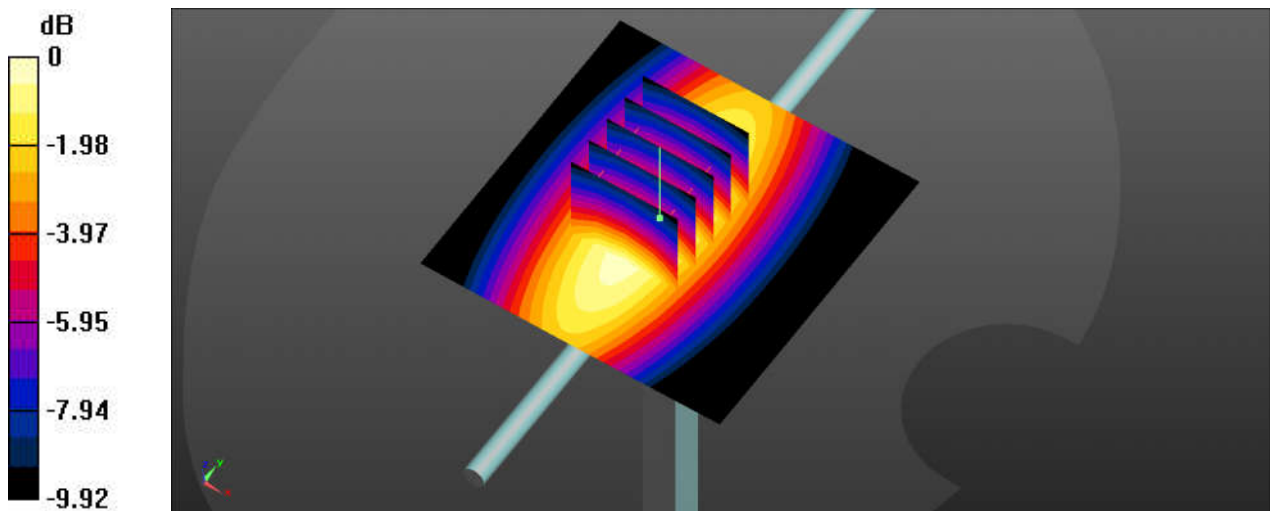

0 dB = 2.65 W/kg

System Check_750MHz

DUT: D750V3-SN:1099

Communication System: UID 0, CW (0); Frequency: 750 MHz; Duty Cycle: 1:1

Medium: HSL_750_231031 Medium parameters used: $f = 750 \text{ MHz}$; $\sigma = 0.911 \text{ S/m}$; $\epsilon_r = 42.879$; $\rho = 1000 \text{ kg/m}^3$

Ambient Temperature : 23.4 °C; Liquid Temperature : 22.3 °C

DASY5 Configuration:

- Probe: EX3DV4 - SN7577; ConvF(9.79, 9.79, 9.79); Calibrated: 2022/11/23
- Sensor-Surface: 1.4mm (Mechanical Surface Detection)
- Electronics: DAE3 Sn360; Calibrated: 2022/12/28
- Phantom: SAM (Front) with CRP v5.0; Type: QD000P40CD; Serial: TP:1795
- Measurement SW: DASY52, Version 52.10 (3); SEMCAD X Version 14.6.13 (7474)

Pin=250mW/Area Scan (61x61x1): Interpolated grid: $dx=1.500 \text{ mm}$, $dy=1.500 \text{ mm}$
Maximum value of SAR (interpolated) = 2.02 W/kg

Pin=250mW/Zoom Scan (5x5x7)/Cube 0: Measurement grid: $dx=8\text{mm}$, $dy=8\text{mm}$, $dz=5\text{mm}$
Reference Value = 48.04 V/m; Power Drift = 0.04 dB
Peak SAR (extrapolated) = 2.35 W/kg
SAR(1 g) = 2.13 W/kg; SAR(10 g) = 1.36 W/kg
Maximum value of SAR (measured) = 2.03 W/kg

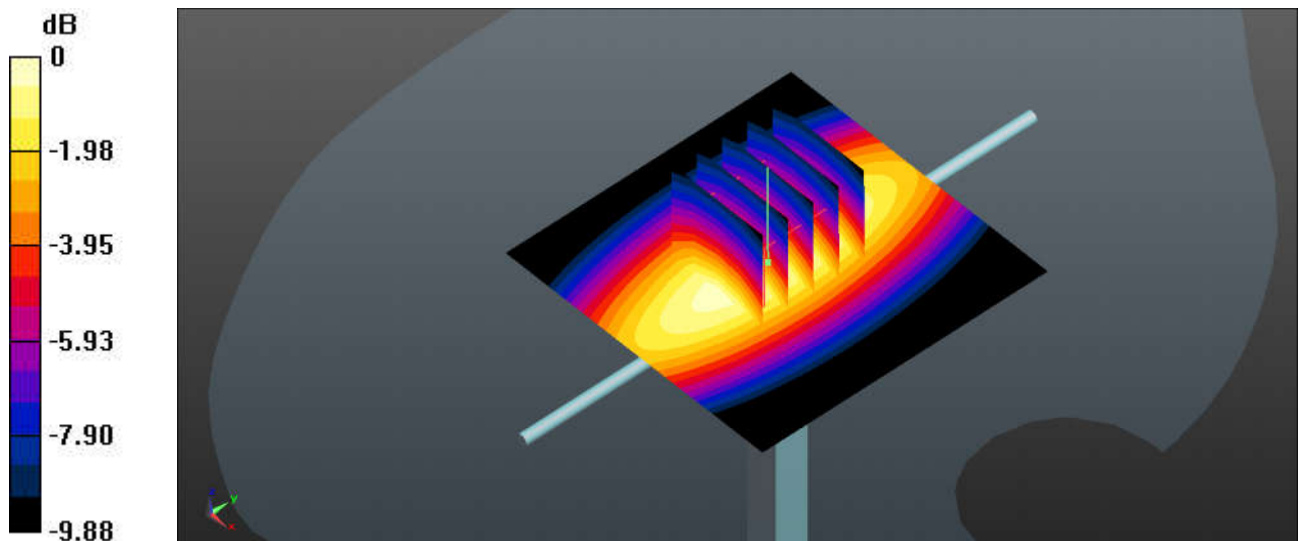

0 dB = 2.03 W/kg

System Check_835MHz

DUT: D835V2-SN:4d162

Communication System: UID 0, CW; Frequency: 835 MHz; Duty Cycle: 1:1

Medium: HSL_835_231031 Medium parameters used: $f = 835 \text{ MHz}$; $\sigma = 0.93 \text{ S/m}$; $\epsilon_r = 42.77$; $\rho = 1000 \text{ kg/m}^3$

Ambient Temperature : 23.4 °C; Liquid Temperature : 22.5 °C

DASY5 Configuration:

- Probe: EX3DV4 - SN3975; ConvF(9.41, 9.96, 9.54); Calibrated: 2023/6/22
- Sensor-Surface: 1.4mm (Mechanical Surface Detection)
- Electronics: DAE4 Sn715; Calibrated: 2023/1/23
- Phantom: Twin-SAM1(P1aP2a20); Type: QD 000 P40 CD; Serial: TP:1670
- Measurement SW: DASY52, Version 52.10 (3); SEMCAD X Version 14.6.13 (7474)

Pin=250mW/Area Scan (61x61x1): Interpolated grid: $dx=1.500 \text{ mm}$, $dy=1.500 \text{ mm}$
Maximum value of SAR (interpolated) = 3.39 W/kg

Pin=250mW/Zoom Scan (5x5x7)/Cube 0: Measurement grid: $dx=8\text{mm}$, $dy=8\text{mm}$, $dz=5\text{mm}$

Reference Value = 60.19 V/m; Power Drift = 0.04 dB

Peak SAR (extrapolated) = 3.75 W/kg

SAR(1 g) = 2.51 W/kg; SAR(10 g) = 1.66 W/kg

Maximum value of SAR (measured) = 3.34 W/kg

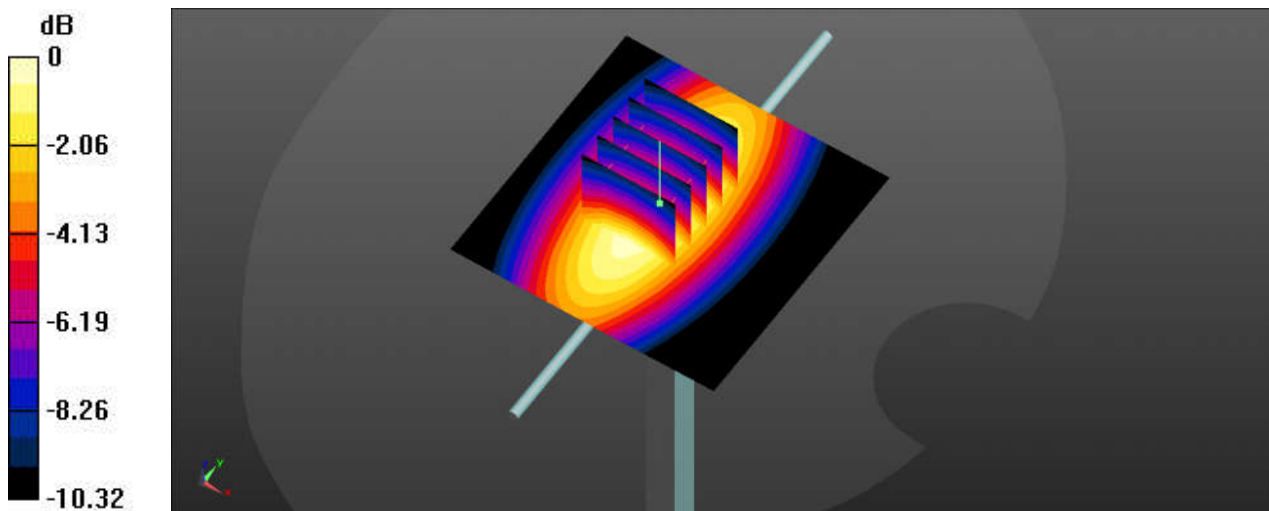

0 dB = 3.34 W/kg

System Check_835MHz

DUT: D835V2-SN:4d162

Communication System: UID 0, CW (0); Frequency: 835 MHz; Duty Cycle: 1:1

Medium: HSL_835_231101 Medium parameters used: $f = 835$ MHz; $\sigma = 0.904$ S/m; $\epsilon_r = 42.08$; $\rho = 1000$ kg/m³

Ambient Temperature : 23.5 °C; Liquid Temperature : 22.5 °C

DASY5 Configuration:

- Probe: EX3DV4 - SN7577; ConvF(9.53, 9.53, 9.53); Calibrated: 2022/11/23
- Sensor-Surface: 1.4mm (Mechanical Surface Detection)
- Electronics: DAE3 Sn360; Calibrated: 2022/12/28
- Phantom: SAM (Front) with CRP v5.0; Type: QD000P40CD; Serial: TP:1795
- Measurement SW: DASY52, Version 52.10 (3); SEMCAD X Version 14.6.13 (7474)

Pin=250mW/Area Scan (61x61x1): Interpolated grid: dx=1.500 mm, dy=1.500 mm
Maximum value of SAR (interpolated) = 2.24 W/kg

Pin=250mW/Zoom Scan (5x5x7)/Cube 0: Measurement grid: dx=8mm, dy=8mm, dz=5mm
Reference Value = 49.04 V/m; Power Drift = 0.06 dB
Peak SAR (extrapolated) = 2.64 W/kg
SAR(1 g) = 2.29 W/kg; SAR(10 g) = 1.51 W/kg
Maximum value of SAR (measured) = 2.27 W/kg

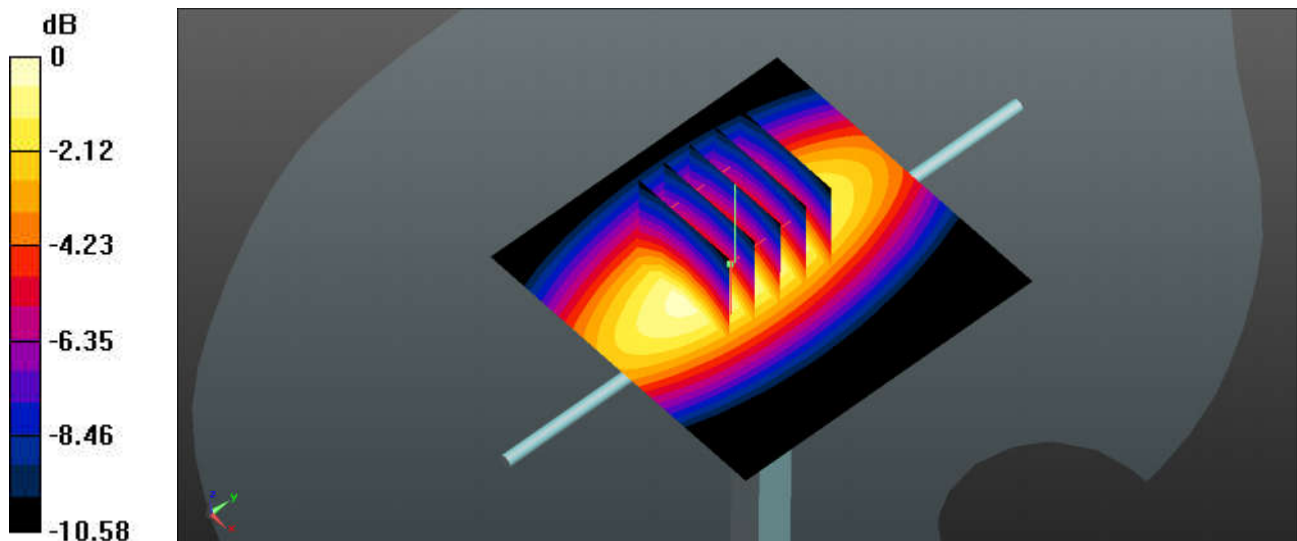

0 dB = 2.27 W/kg

System Check_835MHz

DUT: D835V2-SN:4d162

Communication System: UID 0, CW (0); Frequency: 835 MHz; Duty Cycle: 1:1

Medium: HSL_835_231103 Medium parameters used: $f = 835$ MHz; $\sigma = 0.915$ S/m; $\epsilon_r = 41.98$; $\rho = 1000$ kg/m³

Ambient Temperature : 23.4 °C; Liquid Temperature : 22.6 °C

DASY5 Configuration:

- Probe: EX3DV4 - SN7641; ConvF(10.31, 10.21, 10.13); Calibrated: 2023/04/24
- Sensor-Surface: 1.4mm (Mechanical Surface Detection)
- Electronics: DAE4 Sn1664; Calibrated: 2023/06/06
- Phantom: Twin-SAM V8.0 (Right); Type: QD 000 P41 AA; Serial: 2033
- Measurement SW: DASY52, Version 52.10 (4); SEMCAD X Version 14.6.14 (7483)

Pin=250mW/Area Scan (61x61x1): Interpolated grid: dx=1.500 mm, dy=1.500 mm

Maximum value of SAR (interpolated) = 6.25 W/kg

Pin=250mW/Zoom Scan (5x5x7)/Cube 0: Measurement grid: dx=8mm, dy=8mm, dz=5mm

Reference Value = 68.43 V/m; Power Drift = -0.13 dB

Peak SAR (extrapolated) = 2.04 W/kg

SAR(1 g) = 2.43 W/kg; SAR(10 g) = 1.55 W/kg

Maximum value of SAR (measured) = 6.84 W/kg

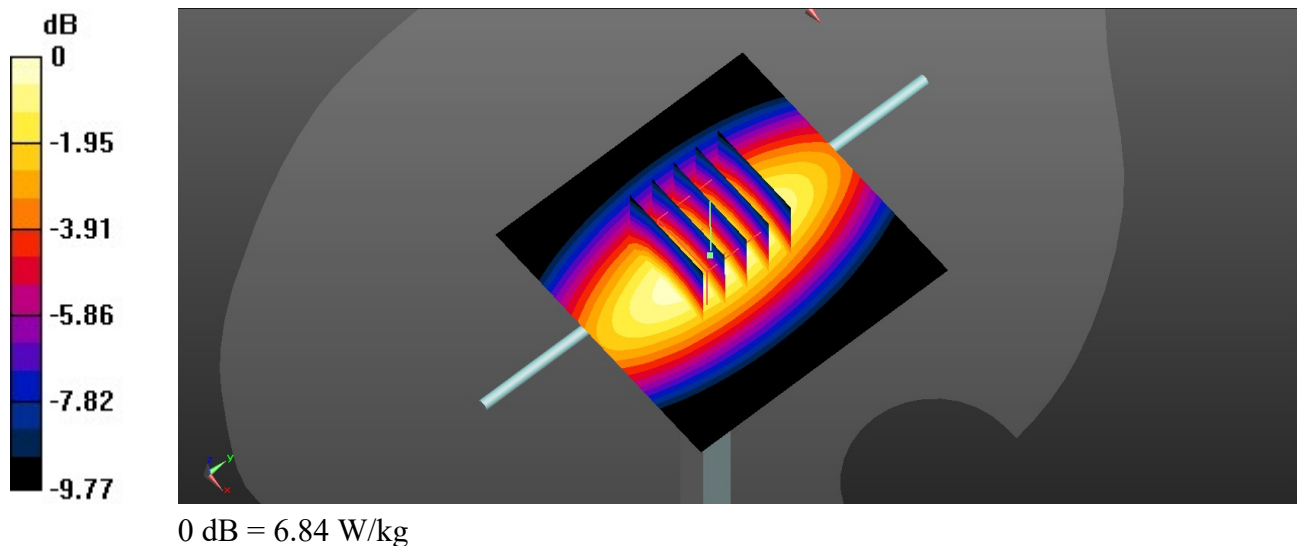

System Check_1750MHz

DUT: D1750V2-SN:1090

Communication System: UID 0, CW; Frequency: 1750 MHz; Duty Cycle: 1:1

Medium: HSL_1750_231027 Medium parameters used: $f = 1750$ MHz; $\sigma = 1.356$ S/m; $\epsilon_r = 40.425$;
 $\rho = 1000$ kg/m³

Ambient Temperature : 23.2 °C; Liquid Temperature : 22.7 °C

DASY5 Configuration:

- Probe: EX3DV4 - SN3975; ConvF(8.12, 8.45, 8.16); Calibrated: 2023/6/22
- Sensor-Surface: 1.4mm (Mechanical Surface Detection)
- Electronics: DAE4 Sn715; Calibrated: 2023/1/23
- Phantom: Twin-SAM1(P1aP2a20); Type: QD 000 P40 CD; Serial: TP:1670
- Measurement SW: DASY52, Version 52.10 (3); SEMCAD X Version 14.6.13 (7474)

Pin=250mW/Area Scan (61x71x1): Interpolated grid: dx=1.500 mm, dy=1.500 mm
Maximum value of SAR (interpolated) = 13.8 W/kg

Pin=250mW/Zoom Scan (5x5x7)/Cube 0: Measurement grid: dx=8mm, dy=8mm, dz=5mm

Reference Value = 99.36 V/m; Power Drift = -0.14 dB

Peak SAR (extrapolated) = 15.1 W/kg

SAR(1 g) = 8.66 W/kg; SAR(10 g) = 4.72 W/kg

Maximum value of SAR (measured) = 12.9 W/kg

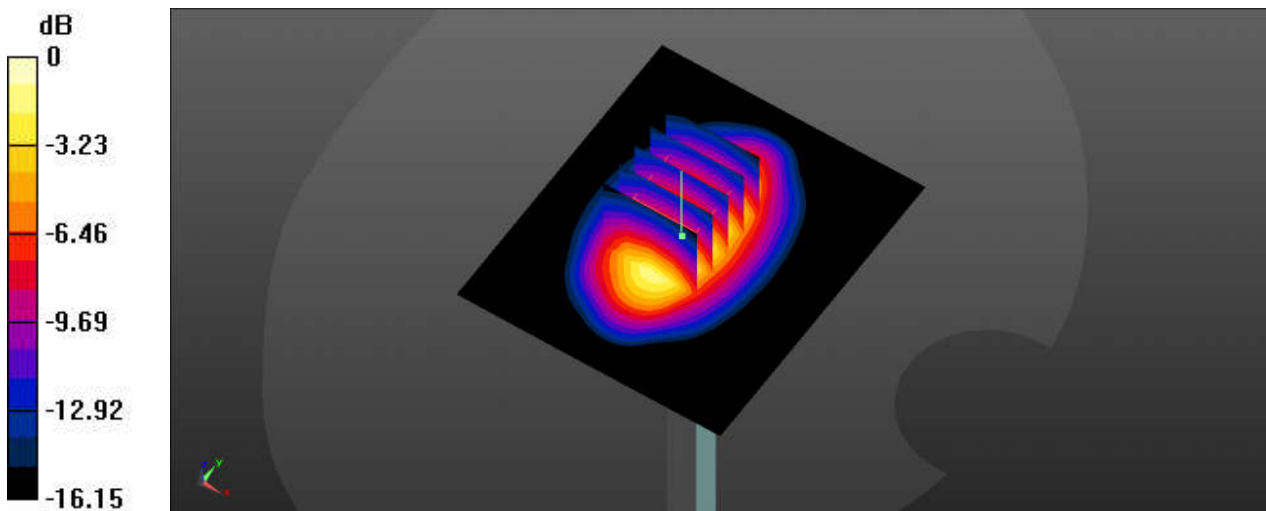

0 dB = 12.9 W/kg

System Check_1750MHz

DUT: D1750V2-SN:1090

Communication System: UID 0, CW; Frequency: 1750 MHz; Duty Cycle: 1:1

Medium: HSL_1750_231102 Medium parameters used: $f = 1750$ MHz; $\sigma = 1.363$ S/m; $\epsilon_r = 41.115$; $\rho = 1000$ kg/m³

Ambient Temperature : 23.6 °C; Liquid Temperature : 22.5 °C

DASY5 Configuration:

- Probe: EX3DV4 - SN7577; ConvF(8.46, 8.46, 8.46); Calibrated: 2022/11/23
- Sensor-Surface: 1.4mm (Mechanical Surface Detection)
- Electronics: DAE3 Sn360; Calibrated: 2022/12/28
- Phantom: SAM (Front) with CRP v5.0; Type: QD000P40CD; Serial: TP:1795
- Measurement SW: DASY52, Version 52.10 (3); SEMCAD X Version 14.6.13 (7474)

Pin=250mW/Area Scan (61x71x1): Interpolated grid: dx=1.500 mm, dy=1.500 mm
Maximum value of SAR (interpolated) = 9.23 W/kg

Pin=250mW/Zoom Scan (5x5x7)/Cube 0: Measurement grid: dx=8mm, dy=8mm, dz=5mm
Reference Value = 79.36 V/m; Power Drift = 0.13 dB
Peak SAR (extrapolated) = 10.9 W/kg
SAR(1 g) = 8.72 W/kg; SAR(10 g) = 4.75 W/kg
Maximum value of SAR (measured) = 9.65 W/kg

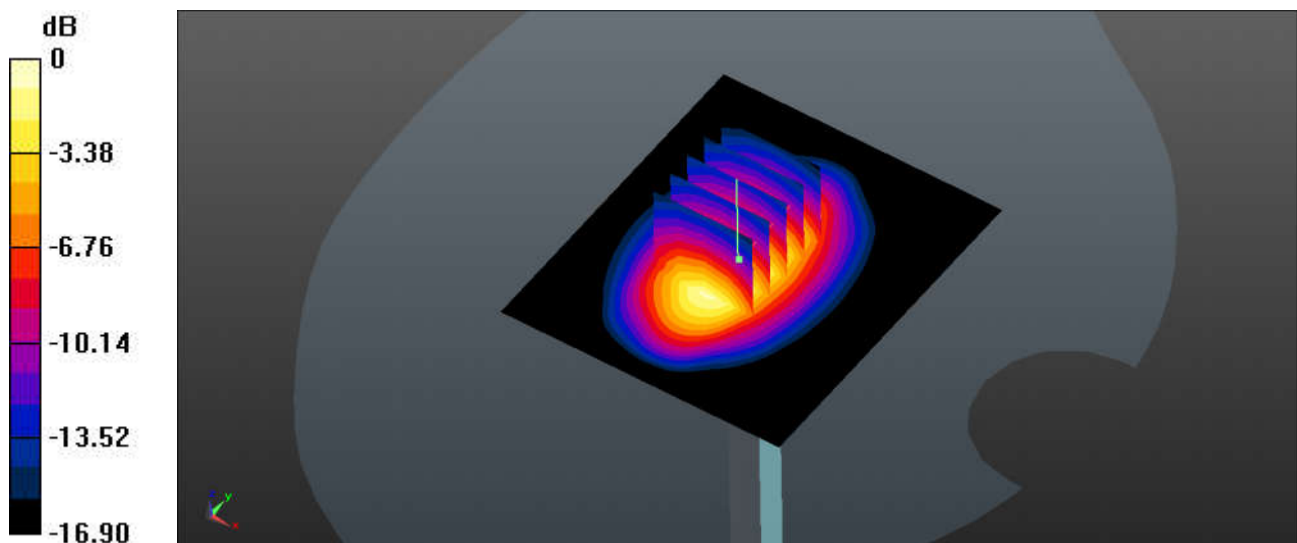

0 dB = 9.65 W/kg

System Check_1900MHz

DUT: D1900V2-SN:5d182

Communication System: UID 0, CW; Frequency: 1900 MHz; Duty Cycle: 1:1

Medium: HSL_1900_231026 Medium parameters used: $f = 1900$ MHz; $\sigma = 1.417$ S/m; $\epsilon_r = 40.994$;
 $\rho = 1000$ kg/m³

Ambient Temperature : 23.5 °C; Liquid Temperature : 22.4 °C

DASY5 Configuration:

- Probe: EX3DV4 - SN3975; ConvF(7.76, 8.13, 7.91); Calibrated: 2023/6/22
- Sensor-Surface: 1.4mm (Mechanical Surface Detection)
- Electronics: DAE4 Sn715; Calibrated: 2023/1/23
- Phantom: Twin-SAM1(P1aP2a20); Type: QD 000 P40 CD; Serial: TP:1670
- Measurement SW: DASY52, Version 52.10 (3); SEMCAD X Version 14.6.13 (7474)

Pin=250mW/Area Scan (61x61x1): Interpolated grid: dx=1.500 mm, dy=1.500 mm
Maximum value of SAR (interpolated) = 15.0 W/kg

Pin=250mW/Zoom Scan (5x5x7)/Cube 0: Measurement grid: dx=8mm, dy=8mm, dz=5mm

Reference Value = 98.94 V/m; Power Drift = 0.08 dB

Peak SAR (extrapolated) = 17.6 W/kg

SAR(1 g) = 9.78 W/kg; SAR(10 g) = 5.17 W/kg

Maximum value of SAR (measured) = 14.9 W/kg

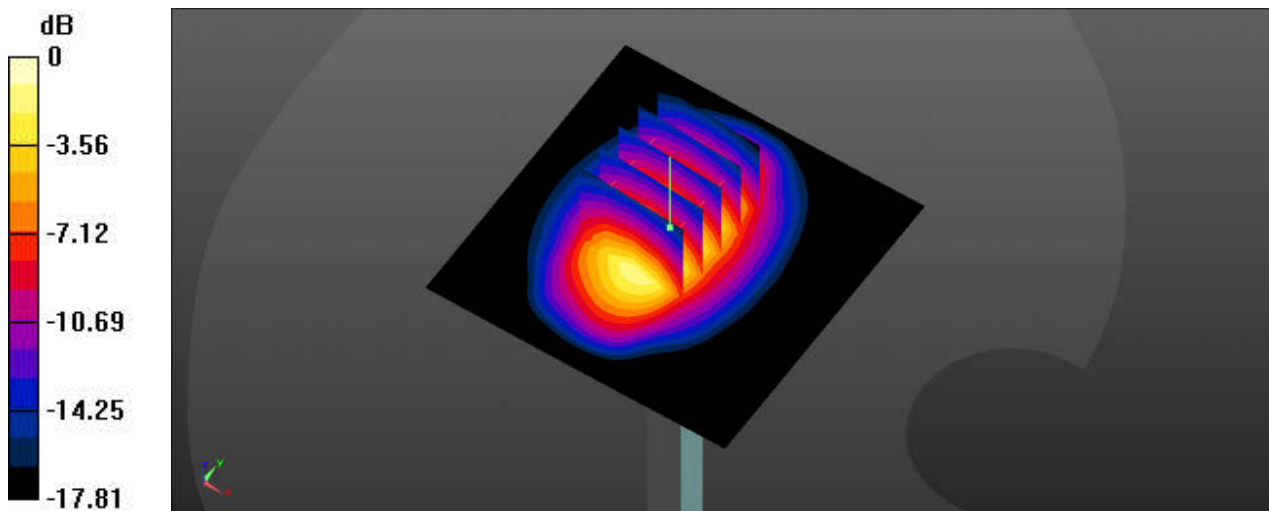

0 dB = 14.9 W/kg

System Check_1900MHz

DUT: D1900V2-SN:5d182

Communication System: UID 0, CW; Frequency: 1900 MHz; Duty Cycle: 1:1

Medium: HSL_1900_231103 Medium parameters used: $f = 1900$ MHz; $\sigma = 1.436$ S/m; $\epsilon_r = 38.697$; $\rho = 1000$ kg/m³

Ambient Temperature : 23.3 °C; Liquid Temperature : 22.3 °C

DASY5 Configuration:

- Probe: EX3DV4 - SN7577; ConvF(8.19, 8.19, 8.19); Calibrated: 2022/11/23
- Sensor-Surface: 1.4mm (Mechanical Surface Detection)
- Electronics: DAE3 Sn360; Calibrated: 2022/12/28
- Phantom: SAM (Front) with CRP v5.0; Type: QD000P40CD; Serial: TP:1795
- Measurement SW: DASY52, Version 52.10 (3); SEMCAD X Version 14.6.13 (7474)

Pin=250mW/Area Scan (61x61x1): Interpolated grid: dx=1.500 mm, dy=1.500 mm
Maximum value of SAR (interpolated) = 10.1 W/kg

Pin=250mW/Zoom Scan (5x5x7)/Cube 0: Measurement grid: dx=8mm, dy=8mm, dz=5mm
Reference Value = 82.04 V/m; Power Drift = 0.14 dB
Peak SAR (extrapolated) = 12.7 W/kg
SAR(1 g) = 9.23 W/kg; SAR(10 g) = 4.78 W/kg
Maximum value of SAR (measured) = 12.0 W/kg

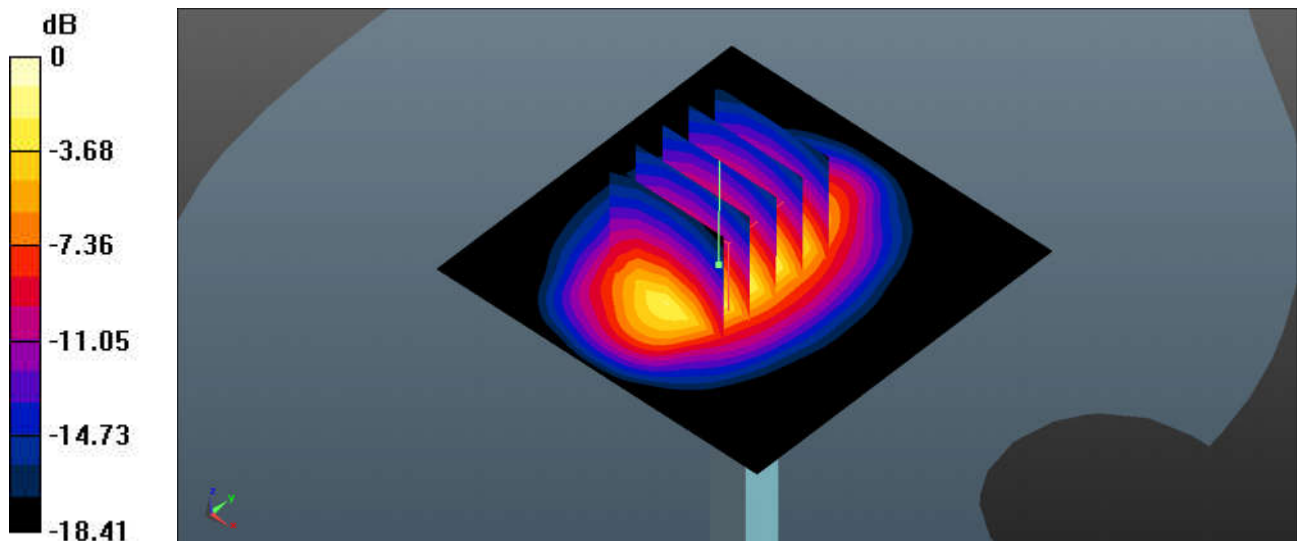

0 dB = 12.0 W/kg

System Check_1900MHz

DUT: D1900V2-SN:5d182

Communication System: UID 0, CW; Frequency: 1900 MHz; Duty Cycle: 1:1

Medium: HSL_1900_231106 Medium parameters used: $f = 1900$ MHz; $\sigma = 1.427$ S/m; $\epsilon_r = 41.191$; $\rho = 1000$ kg/m³

Ambient Temperature : 23.3 °C; Liquid Temperature : 22.7 °C

DASY5 Configuration:

- Probe: EX3DV4 - SN7641; ConvF(8.65, 8.36, 8.37); Calibrated: 2023/04/24
- Sensor-Surface: 1.4mm (Mechanical Surface Detection)
- Electronics: DAE4 Sn1664; Calibrated: 2023/06/06
- Phantom: Twin-SAM V8.0 (Right); Type: QD 000 P41 AA; Serial: 2033
- Measurement SW: DASY52, Version 52.10 (4); SEMCAD X Version 14.6.14 (7483)

Pin=250mW/Area Scan (61x61x1): Interpolated grid: dx=1.500 mm, dy=1.500 mm
Maximum value of SAR (interpolated) = 12.8 W/kg

Pin=250mW/Zoom Scan (5x5x7)/Cube 0: Measurement grid: dx=8mm, dy=8mm, dz=5mm
Reference Value = 100.3 V/m; Power Drift = -0.15 dB
Peak SAR (extrapolated) = 14.9 W/kg
SAR(1 g) = 9.37 W/kg; SAR(10 g) = 4.85 W/kg
Maximum value of SAR (measured) = 12.8 W/kg

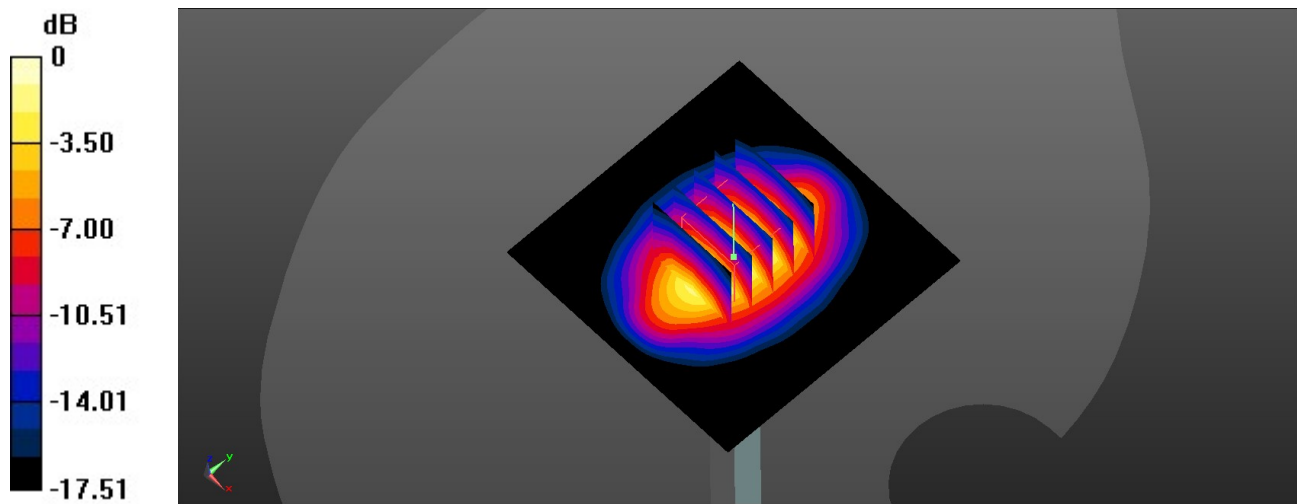

0 dB = 12.8 W/kg

System Check_2450MHz

DUT: D2450V2-SN:1040

Communication System: UID 0, CW; Frequency: 2450 MHz; Duty Cycle: 1:1

Medium: HSL_2450_231101 Medium parameters used: $f = 2450$ MHz; $\sigma = 1.825$ S/m; $\epsilon_r = 39.664$; $\rho = 1000$ kg/m³

Ambient Temperature : 23.5 °C; Liquid Temperature : 22.4 °C

DASY5 Configuration:

- Probe: EX3DV4 - SN7641; ConvF(7.99, 7.84, 7.88); Calibrated: 2023/04/24
- Sensor-Surface: 1.4mm (Mechanical Surface Detection)
- Electronics: DAE4 Sn1664; Calibrated: 2023/06/06
- Phantom: Twin-SAM V8.0 (Right); Type: QD 000 P41 AA; Serial: 2033
- Measurement SW: DASY52, Version 52.10 (4); SEMCAD X Version 14.6.14 (7483)

Pin=250mW/Area Scan (81x81x1): Interpolated grid: dx=1.200 mm, dy=1.200 mm
Maximum value of SAR (interpolated) = 21.3 W/kg

Pin=250mW/Zoom Scan (7x7x7)/Cube 0: Measurement grid: dx=5mm, dy=5mm, dz=5mm
Reference Value = 112.5 V/m; Power Drift = 0.00 dB
Peak SAR (extrapolated) = 26.6 W/kg
SAR(1 g) = 12.3 W/kg; SAR(10 g) = 5.7 W/kg
Maximum value of SAR (measured) = 21.2 W/kg

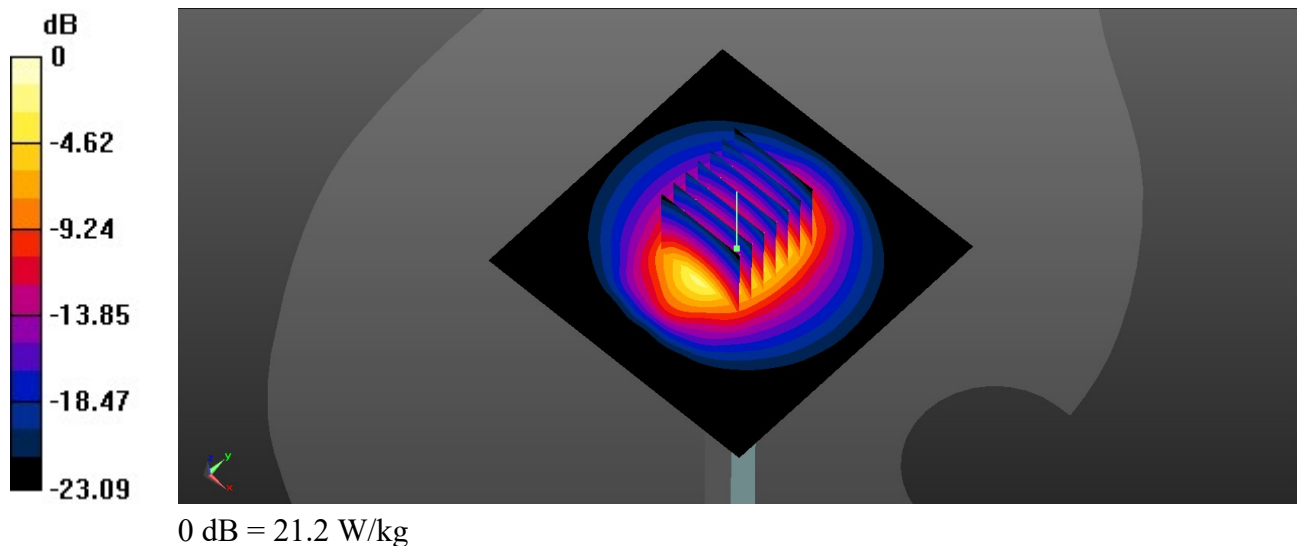

System Check_2450MHz

DUT: D2450V2-SN:1040

Communication System: UID 0, CW; Frequency: 2450 MHz; Duty Cycle: 1:1

Medium: HSL_2450_231105 Medium parameters used: $f = 2450$ MHz; $\sigma = 1.843$ S/m; $\epsilon_r = 40.377$; $\rho = 1000$ kg/m³

Ambient Temperature : 23.3 °C; Liquid Temperature : 22.4 °C

DASY5 Configuration:

- Probe: EX3DV4 - SN7577; ConvF(7.94, 7.94, 7.94); Calibrated: 2022/11/23
- Sensor-Surface: 1.4mm (Mechanical Surface Detection)
- Electronics: DAE3 Sn360; Calibrated: 2022/12/28
- Phantom: SAM (Front) with CRP v5.0; Type: QD000P40CD; Serial: TP:1795
- Measurement SW: DASY52, Version 52.10 (3); SEMCAD X Version 14.6.13 (7474)

Pin=250mW/Area Scan (81x81x1): Interpolated grid: dx=1.200 mm, dy=1.200 mm
Maximum value of SAR (interpolated) = 13.6 W/kg

Pin=250mW/Zoom Scan (7x7x7)/Cube 0: Measurement grid: dx=5mm, dy=5mm, dz=5mm
Reference Value = 73.82 V/m; Power Drift = -0.11 dB
Peak SAR (extrapolated) = 18.2 W/kg
SAR(1 g) = 12.7 W/kg; SAR(10 g) = 5.89 W/kg
Maximum value of SAR (measured) = 17.3 W/kg

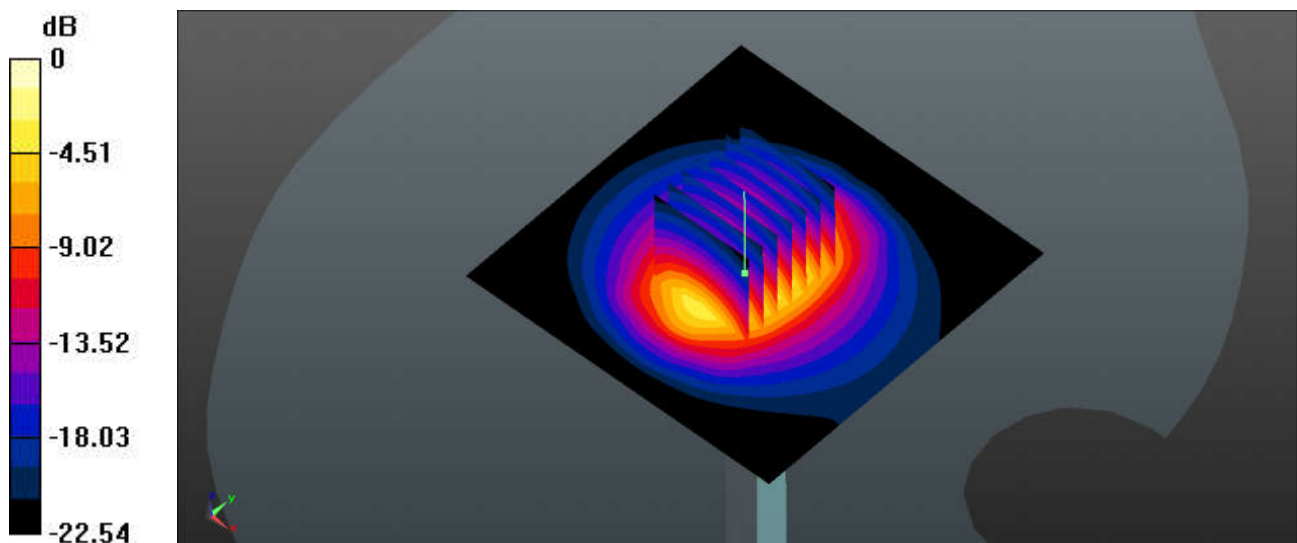

0 dB = 17.3 W/kg

System Check_2450MHz

DUT: D2450V2-SN:1040

Communication System: UID 0, CW; Frequency: 2450 MHz; Duty Cycle: 1:1

Medium: HSL_2450_231106 Medium parameters used: $f = 2450$ MHz; $\sigma = 1.878$ S/m; $\epsilon_r = 40.464$;
 $\rho = 1000$ kg/m³

Ambient Temperature : 23.1 °C; Liquid Temperature : 22.2 °C

DASY5 Configuration:

- Probe: EX3DV4 - SN3975; ConvF(7.28, 7.63, 7.38); Calibrated: 2023/6/22
- Sensor-Surface: 1.4mm (Mechanical Surface Detection)
- Electronics: DAE4 Sn715; Calibrated: 2023/1/23
- Phantom: Twin-SAM1(P1aP2a20); Type: QD 000 P40 CD; Serial: TP:1670
- Measurement SW: DASY52, Version 52.10 (3); SEMCAD X Version 14.6.13 (7474)

Pin=250mW/Area Scan (71x81x1): Interpolated grid: dx=1.200 mm, dy=1.200 mm
 Maximum value of SAR (interpolated) = 22.8 W/kg

Pin=250mW/Zoom Scan (7x7x7)/Cube 0: Measurement grid: dx=5mm, dy=5mm, dz=5mm

Reference Value = 108.0 V/m; Power Drift = -0.14 dB

Peak SAR (extrapolated) = 26.3 W/kg

SAR(1 g) = 13.5 W/kg; SAR(10 g) = 6.41 W/kg

Maximum value of SAR (measured) = 21.6 W/kg

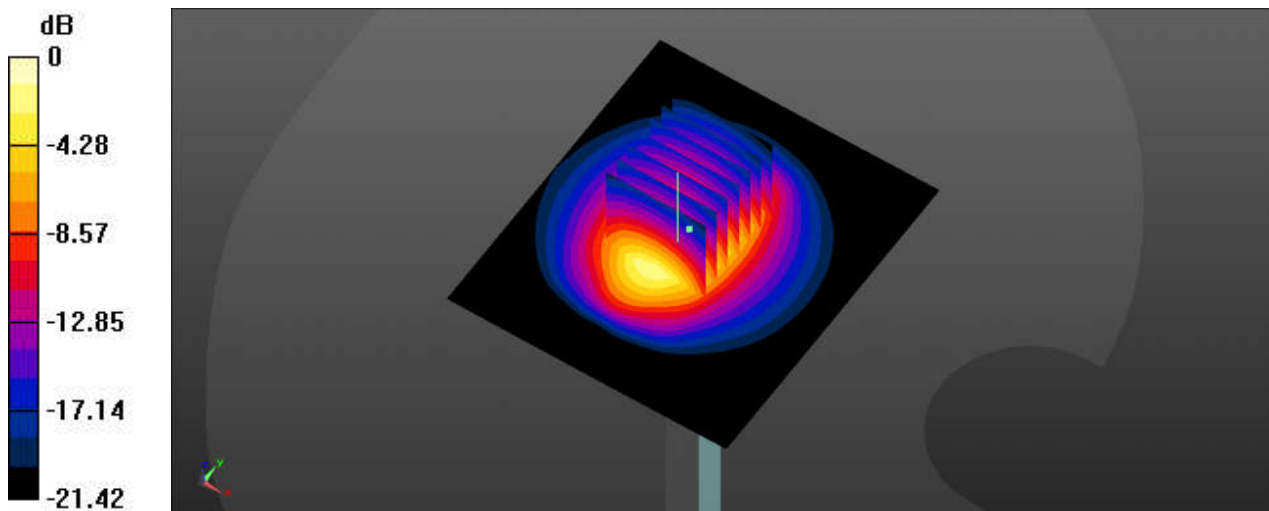

0 dB = 21.6 W/kg

System Check_2600MHz

DUT: D2600V2-SN:1070

Communication System: UID 0, CW (0); Frequency: 2600 MHz;Duty Cycle: 1:1

Medium: HSL_2600_2301102 Medium parameters used: $f = 2600$ MHz; $\sigma = 1.912$ S/m; $\epsilon_r = 38.499$; $\rho = 1000$ kg/m³

Ambient Temperature : 23.4 °C; Liquid Temperature : 22.3 °C

DASY5 Configuration:

- Probe: EX3DV4 - SN3975; ConvF(7.18, 7.6, 7.37); Calibrated: 2023/6/22
- Sensor-Surface: 1.4mm (Mechanical Surface Detection)
- Electronics: DAE4 Sn715; Calibrated: 2023/1/23
- Phantom: Twin-SAM1(P1aP2a20); Type: QD 000 P40 CD; Serial: TP:1670
- Measurement SW: DASY52, Version 52.10 (3); SEMCAD X Version 14.6.13 (7474)

Pin=250mW/Area Scan (71x81x1): Interpolated grid: dx=1.200 mm, dy=1.200 mm

Maximum value of SAR (interpolated) = 26.2 W/kg

Pin=250mW/Zoom Scan (7x7x7)/Cube 0: Measurement grid: dx=5mm, dy=5mm, dz=5mm

Reference Value = 115.8 V/m; Power Drift = 0.11 dB

Peak SAR (extrapolated) = 34.5 W/kg

SAR(1 g) = 14.2 W/kg; SAR(10 g) = 6.07 W/kg

Maximum value of SAR (measured) = 26.1 W/kg

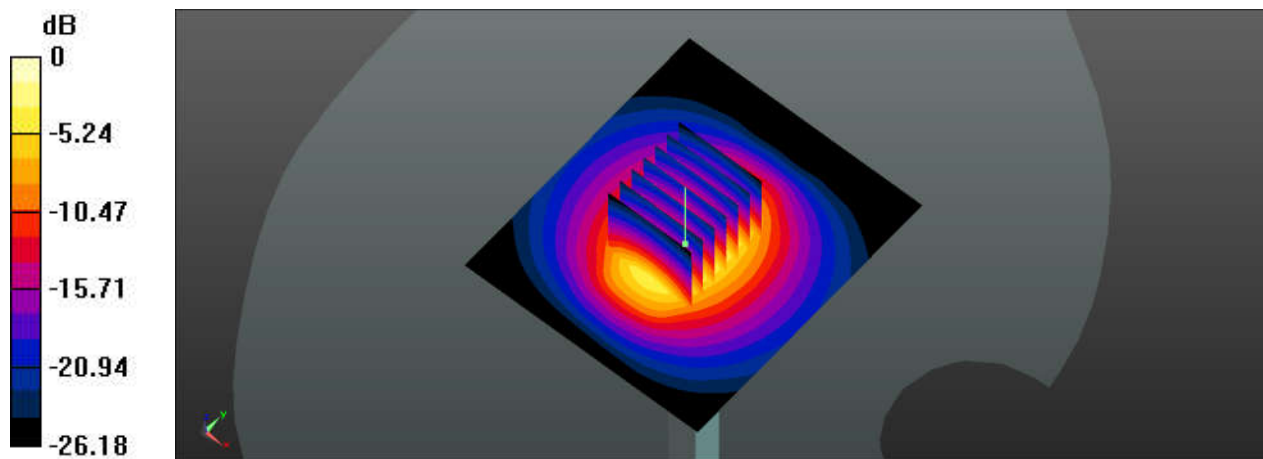

0 dB = 26.1 W/kg

System Check_2600MHz

DUT: D2600V2-SN:1070

Communication System: UID 0, CW (0); Frequency: 2600 MHz; Duty Cycle: 1:1

Medium: HSL_2600_231104 Medium parameters used: $f = 2600$ MHz; $\sigma = 1.904$ S/m; $\epsilon_r = 38.499$; $\rho = 1000$ kg/m³

Ambient Temperature : 23.4 °C; Liquid Temperature : 22.2 °C

DASY5 Configuration:

- Probe: EX3DV4 - SN7577; ConvF(7.55, 7.55, 7.55); Calibrated: 2022/11/23
- Sensor-Surface: 1.4mm (Mechanical Surface Detection)
- Electronics: DAE3 Sn360; Calibrated: 2022/12/28
- Phantom: SAM (Front) with CRP v5.0; Type: QD000P40CD; Serial: TP:1795
- Measurement SW: DASY52, Version 52.10 (3); SEMCAD X Version 14.6.13 (7474)

Pin=250mW/Area Scan (71x81x1): Interpolated grid: dx=1.200 mm, dy=1.200 mm
Maximum value of SAR (interpolated) = 14.8 W/kg

Pin=250mW/Zoom Scan (7x7x7)/Cube 0: Measurement grid: dx=5mm, dy=5mm, dz=5mm
Reference Value = 87.98 V/m; Power Drift = 0.08 dB
Peak SAR (extrapolated) = 20.1 W/kg
SAR(1 g) = 13.3 W/kg; SAR(10 g) = 6.09 W/kg
Maximum value of SAR (measured) = 18.3 W/kg

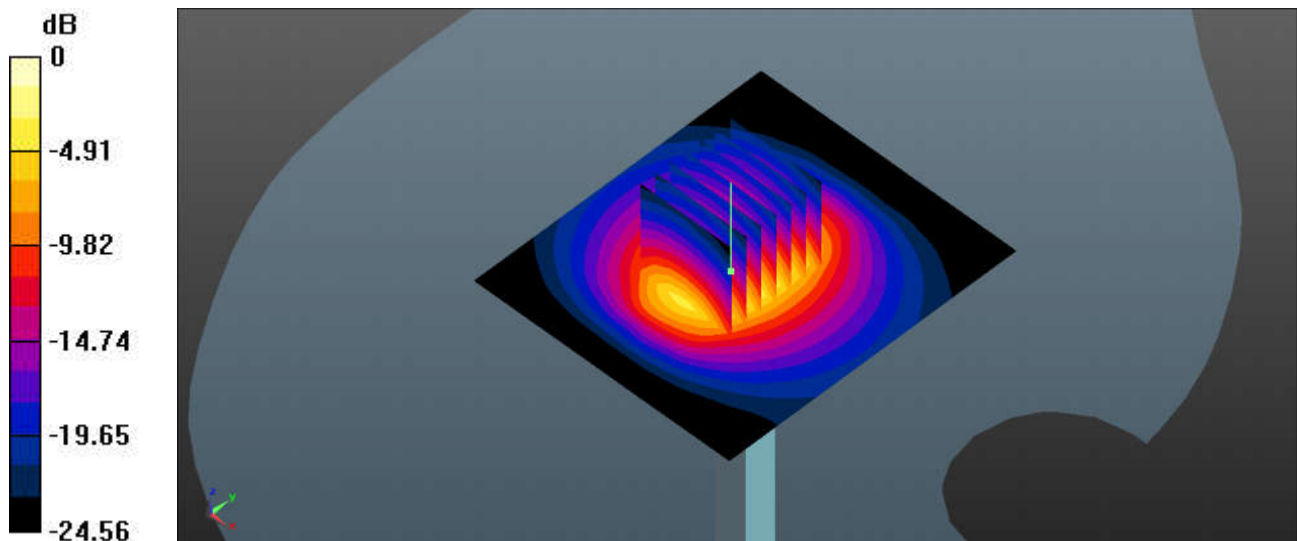

0 dB = 18.3 W/kg

System Check_2600MHz

DUT: D2600V2-SN:1070

Communication System: UID 0, CW (0); Frequency: 2600 MHz; Duty Cycle: 1:1

Medium: HSL_2600_231108 Medium parameters used: $f = 2600$ MHz; $\sigma = 2.056$ S/m; $\epsilon_r = 37.284$; $\rho = 1000$ kg/m³

Ambient Temperature : 23.4 °C; Liquid Temperature : 22.2 °C

DASY5 Configuration:

- Probe: EX3DV4 - SN7641; ConvF(7.83, 7.68, 7.74); Calibrated: 2023/04/24
- Sensor-Surface: 1.4mm (Mechanical Surface Detection)
- Electronics: DAE4 Sn1664; Calibrated: 2023/06/06
- Phantom: Twin-SAM V8.0 (Right); Type: QD 000 P41 AA; Serial: 2033
- Measurement SW: DASY52, Version 52.10 (4); SEMCAD X Version 14.6.14 (7483)

Pin=250mW/Area Scan (71x81x1): Interpolated grid: dx=1.200 mm, dy=1.200 mm
Maximum value of SAR (interpolated) = 25.2 W/kg

Pin=250mW/Zoom Scan (7x7x7)/Cube 0: Measurement grid: dx=5mm, dy=5mm, dz=5mm
Reference Value = 114.6 V/m; Power Drift = 0.02 dB
Peak SAR (extrapolated) = 32.2 W/kg
SAR(1 g) = 14.1 W/kg; SAR(10 g) = 6.12 W/kg
Maximum value of SAR (measured) = 25.0 W/kg

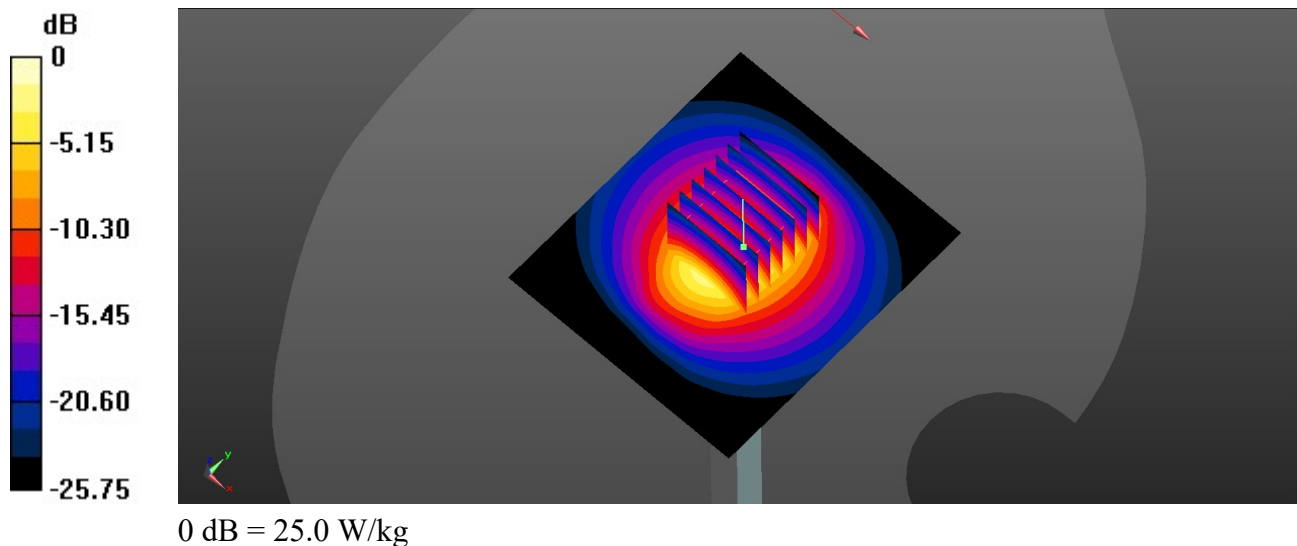

System Check_5250MHz

DUT: D5GHzV2-SN:1341

Communication System: UID 0, CW (0); Frequency: 5250 MHz; Duty Cycle: 1:1
Medium: HSL_5250_231028 Medium parameters used: $f = 5250$ MHz; $\sigma = 4.803$ S/m; $\epsilon_r = 37.045$;
 $\rho = 1000$ kg/m³
Ambient Temperature : 23.6 °C; Liquid Temperature : 22.3 °C

DASY5 Configuration:

- Probe: EX3DV4 - SN3975; ConvF(5.61, 5.97, 5.91); Calibrated: 2023/6/22
- Sensor-Surface: 1.4mm (Mechanical Surface Detection)
- Electronics: DAE4 Sn715; Calibrated: 2023/1/23
- Phantom: Twin-SAM1(P1aP2a20); Type: QD 000 P40 CD; Serial: TP:1670
- Measurement SW: DASY52, Version 52.10 (3); SEMCAD X Version 14.6.13 (7474)

Pin=100mW/Area Scan (71x71x1): Interpolated grid: dx=1.000 mm, dy=1.000 mm
Maximum value of SAR (interpolated) = 12.77 W/kg

Pin=100mW/Zoom Scan (7x7x7)/Cube 0: Measurement grid: dx=4mm, dy=4mm, dz=1.4mm
Reference Value = 34.34 V/m; Power Drift = 0.04 dB
Peak SAR (extrapolated) = 10.0 W/kg
SAR(1 g) = 7.55 W/kg; SAR(10 g) = 2.23 W/kg
Maximum value of SAR (measured) = 12.85 W/kg

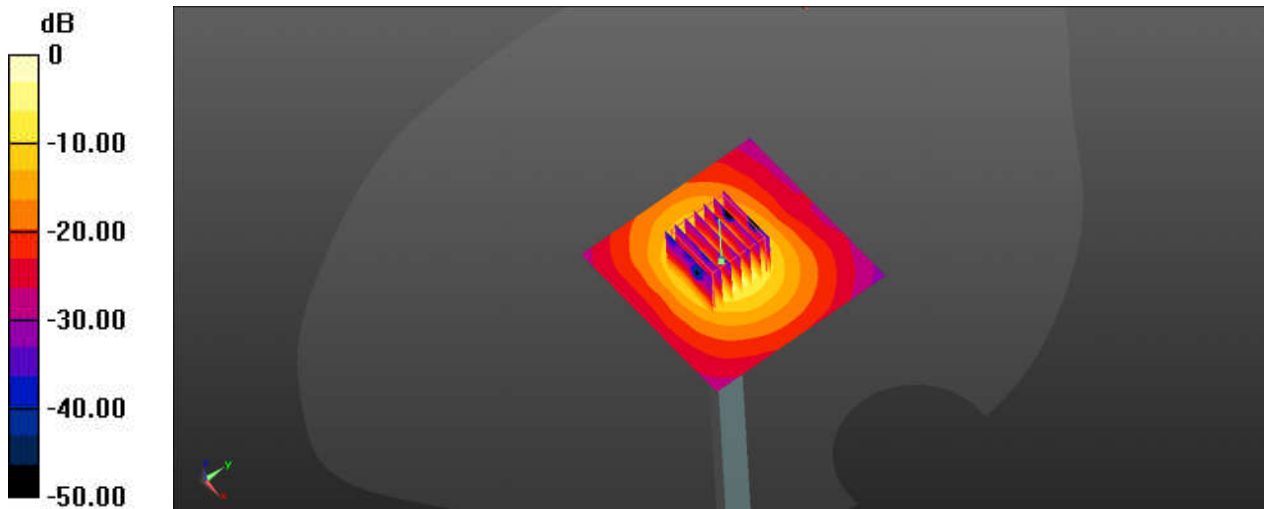

0 dB = 12.85 W/kg

System Check_5250MHz

DUT: D5GHzV2-SN:1341

Communication System: UID 0, CW (0); Frequency: 5250 MHz; Duty Cycle: 1:1

Medium: HSL_5250_231106 Medium parameters used: $f = 5250$ MHz; $\sigma = 4.617$ S/m; $\epsilon_r = 35.683$; $\rho = 1000$ kg/m³

Ambient Temperature : 23.5 °C; Liquid Temperature : 22.5 °C

DASY5 Configuration:

- Probe: EX3DV4 - SN7577; ConvF(5.43, 5.43, 5.43); Calibrated: 2022/11/23
- Sensor-Surface: 1.4mm (Mechanical Surface Detection)
- Electronics: DAE3 Sn360; Calibrated: 2022/12/28
- Phantom: SAM (Front) with CRP v5.0; Type: QD000P40CD; Serial: TP:1795
- Measurement SW: DASY52, Version 52.10 (3); SEMCAD X Version 14.6.13 (7474)

Pin=100mW/Area Scan (71x81x1): Interpolated grid: dx=1.000 mm, dy=1.000 mm
Maximum value of SAR (interpolated) = 12.5 W/kg

Pin=100mW/Zoom Scan (8x8x7)/Cube 0: Measurement grid: dx=4mm, dy=4mm, dz=1.4mm
Reference Value = 41.77 V/m; Power Drift = 0.18 dB
Peak SAR (extrapolated) = 19.8 W/kg
SAR(1 g) = 7.87 W/kg; SAR(10 g) = 2.4 W/kg
Maximum value of SAR (measured) = 12.1 W/kg

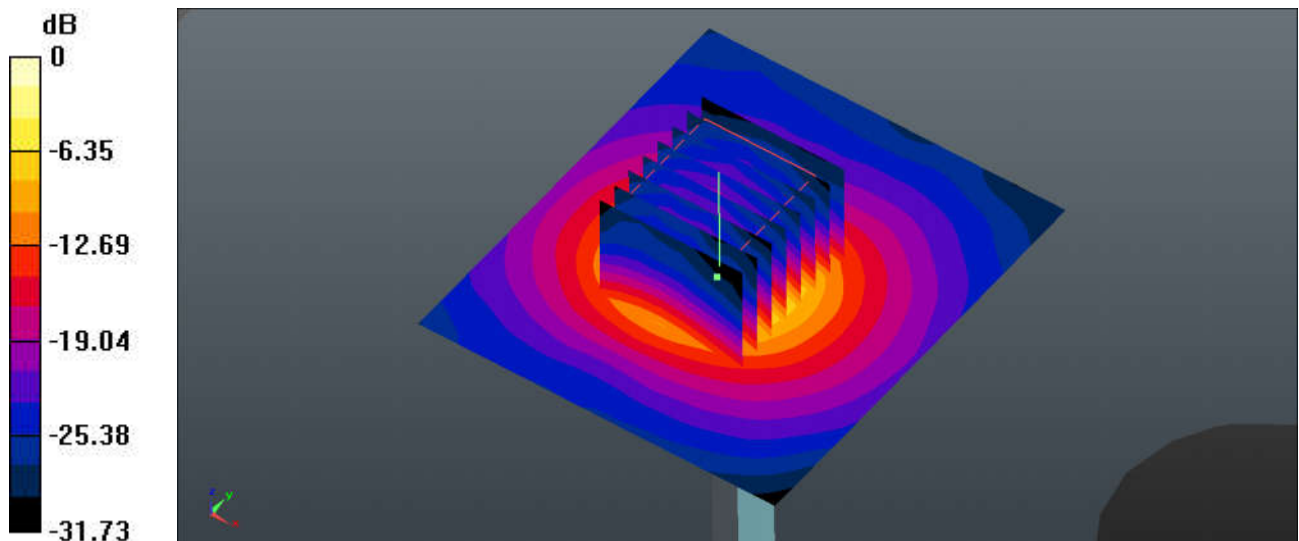

0 dB = 12.1 W/kg

System Check_5250MHz

DUT: D5GHzV2-SN:1341

Communication System: UID 0, CW; Frequency: 5250 MHz; Duty Cycle: 1:1

Medium: HSL_5250_231107 Medium parameters used: $f = 5250$ MHz; $\sigma = 4.595$ S/m; $\epsilon_r = 36.652$; $\rho = 1000$ kg/m³

Ambient Temperature : 23.3 °C; Liquid Temperature : 22.5 °C

DASY5 Configuration:

- Probe: EX3DV4 - SN7641; ConvF(5.89, 5.79, 5.89); Calibrated: 2023/04/24
- Sensor-Surface: 1.4mm (Mechanical Surface Detection)
- Electronics: DAE4 Sn1664; Calibrated: 2023/06/06
- Phantom: Twin-SAM V8.0 (Right); Type: QD 000 P41 AA; Serial: 2033
- Measurement SW: DASY52, Version 52.10 (4); SEMCAD X Version 14.6.14 (7483)

Pin=100mW/Area Scan (71x71x1): Interpolated grid: dx=1.000 mm, dy=1.000 mm

Maximum value of SAR (interpolated) = 18.6 W/kg

Pin=100mW/Zoom Scan (7x7x7)/Cube 0: Measurement grid: dx=4mm, dy=4mm, dz=1.4mm

Reference Value = 69.21 V/m; Power Drift = -0.12 dB

Peak SAR (extrapolated) = 32.7 W/kg

SAR(1 g) = 7.51 W/kg; SAR(10 g) = 2.15 W/kg

Maximum value of SAR (measured) = 18.7 W/kg

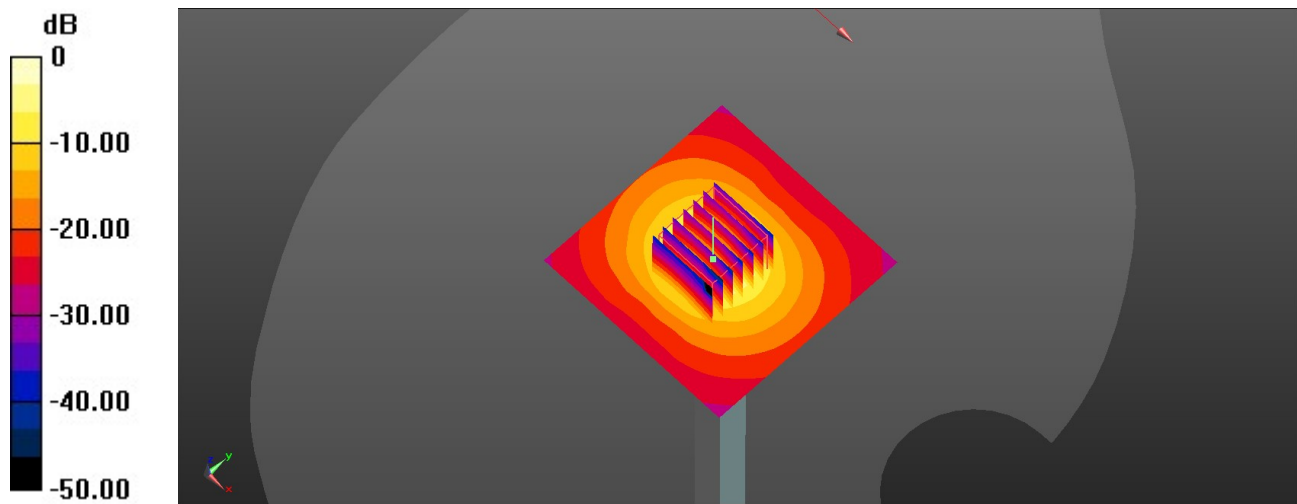

0 dB = 18.7 W/kg

System Check_5600MHz

DUT: D5GHzV2-SN:1341

Communication System: UID 0, CW (0); Frequency: 5600 MHz; Duty Cycle: 1:1
Medium: HSL_5600_231029 Medium parameters used: $f = 5600$ MHz; $\sigma = 5.238$ S/m; $\epsilon_r = 36.275$;
 $\rho = 1000$ kg/m³
Ambient Temperature : 23.4 °C; Liquid Temperature : 22.2 °C

DASY5 Configuration:

- Probe: EX3DV4 - SN3975; ConvF(4.57, 4.92, 4.88); Calibrated: 2023/6/22
- Sensor-Surface: 1.4mm (Mechanical Surface Detection)
- Electronics: DAE4 Sn715; Calibrated: 2023/1/23
- Phantom: Twin-SAM1(P1aP2a20); Type: QD 000 P40 CD; Serial: TP:1670
- Measurement SW: DASY52, Version 52.10 (3); SEMCAD X Version 14.6.13 (7474)

Pin=100mW/Area Scan (71x71x1): Interpolated grid: dx=1.000 mm, dy=1.000 mm
Maximum value of SAR (interpolated) = 13.79 W/kg

Pin=100mW/Zoom Scan (7x7x7)/Cube 0: Measurement grid: dx=4mm, dy=4mm, dz=1.4mm
Reference Value = 38.69 V/m; Power Drift = 0.05 dB
Peak SAR (extrapolated) = 12.6 W/kg
SAR(1 g) = 7.95 W/kg; SAR(10 g) = 2.26 W/kg
Maximum value of SAR (measured) = 14.08 W/kg

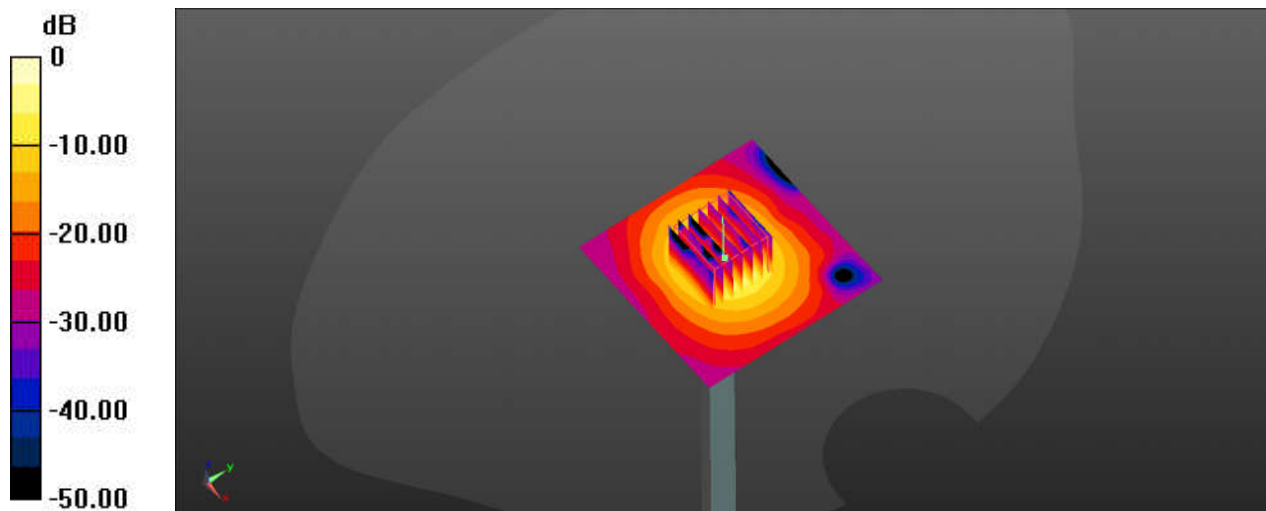

0 dB = 14.08 W/kg

System Check_5600MHz

DUT: D5GHzV2-SN:1341

Communication System: UID 0, CW (0); Frequency: 5600 MHz; Duty Cycle: 1:1

Medium: HSL_5600_231107 Medium parameters used: $f = 5600$ MHz; $\sigma = 4.97$ S/m; $\epsilon_r = 35.188$; $\rho = 1000$ kg/m³

Ambient Temperature : 23.5 °C; Liquid Temperature : 22.3 °C

DASY5 Configuration:

- Probe: EX3DV4 - SN7577; ConvF(4.81, 4.81, 4.81); Calibrated: 2022/11/23
- Sensor-Surface: 1.4mm (Mechanical Surface Detection)
- Electronics: DAE3 Sn360; Calibrated: 2022/12/28
- Phantom: SAM (Front) with CRP v5.0; Type: QD000P40CD; Serial: TP:1795
- Measurement SW: DASY52, Version 52.10 (3); SEMCAD X Version 14.6.13 (7474)

Pin=100mW/Area Scan (71x81x1): Interpolated grid: dx=1.000 mm, dy=1.000 mm

Maximum value of SAR (interpolated) = 13.8 W/kg

Pin=100mW/Zoom Scan (8x8x7)/Cube 0: Measurement grid: dx=4mm, dy=4mm, dz=1.4mm

Reference Value = 40.94 V/m; Power Drift = 0.15 dB

Peak SAR (extrapolated) = 22.6 W/kg

SAR(1 g) = 8.15 W/kg; SAR(10 g) = 2.47 W/kg

Maximum value of SAR (measured) = 13.0 W/kg

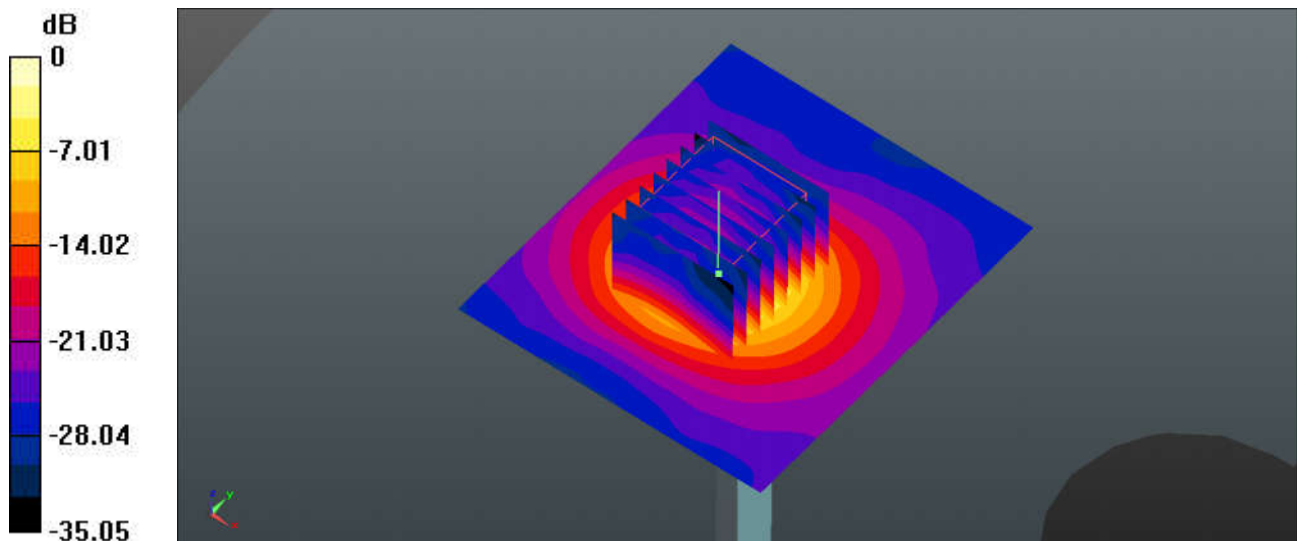

0 dB = 13.0 W/kg

System Check_5600MHz

DUT: D5GHzV2-SN:1341

Communication System: UID 0, CW; Frequency: 5600 MHz; Duty Cycle: 1:1

Medium: HSL_5600_231108 Medium parameters used: $f = 5600$ MHz; $\sigma = 5.125$ S/m; $\epsilon_r = 35.435$; $\rho = 1000$ kg/m³

Ambient Temperature : 23.4 °C; Liquid Temperature : 22.8 °C

DASY5 Configuration:

- Probe: EX3DV4 - SN7641; ConvF(5.17, 5.05, 5.16); Calibrated: 2023/04/24
- Sensor-Surface: 1.4mm (Mechanical Surface Detection)
- Electronics: DAE4 Sn1664; Calibrated: 2023/06/06
- Phantom: Twin-SAM V8.0 (Right); Type: QD 000 P41 AA; Serial: 2033
- Measurement SW: DASY52, Version 52.10 (4); SEMCAD X Version 14.6.14 (7483)

Pin=100mW/Area Scan (71x71x1): Interpolated grid: dx=1.000 mm, dy=1.000 mm

Maximum value of SAR (interpolated) = 19.0 W/kg

Pin=100mW/Zoom Scan (7x7x7)/Cube 0: Measurement grid: dx=4mm, dy=4mm, dz=1.4mm

Reference Value = 64.55 V/m; Power Drift = -0.12 dB

Peak SAR (extrapolated) = 33.2 W/kg

SAR(1 g) = 7.89 W/kg; SAR(10 g) = 2.25 W/kg

Maximum value of SAR (measured) = 18.6 W/kg

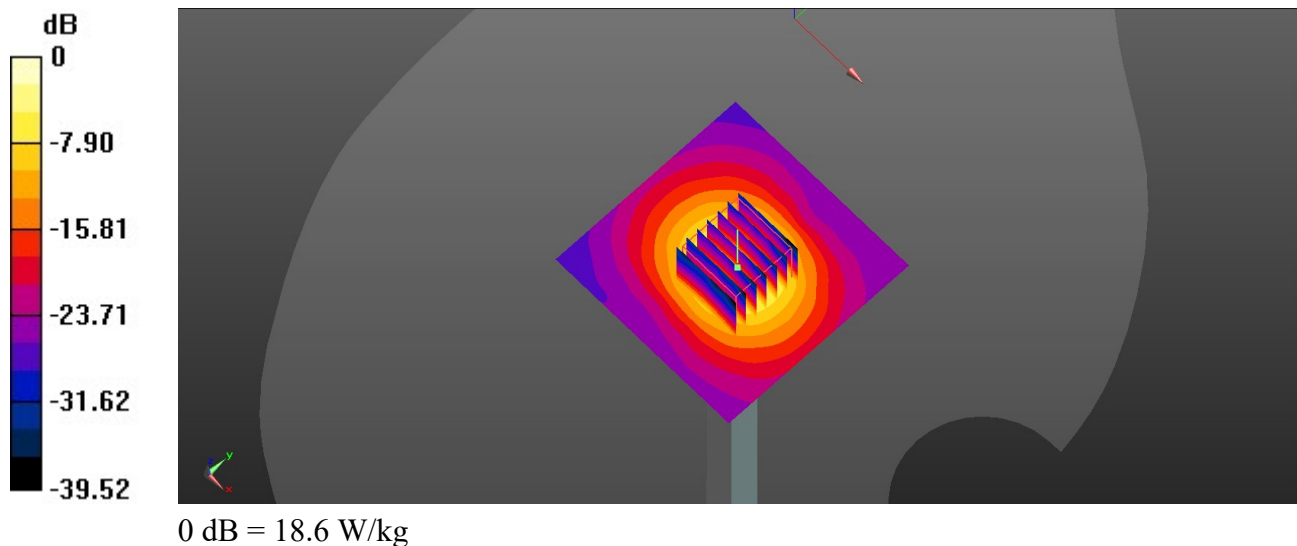

System Check_5750MHz

DUT: D5GHzV2-SN:1341

Communication System: UID 0, CW (0); Frequency: 5750 MHz; Duty Cycle: 1:1
Medium: HSL_5750_231029 Medium parameters used: $f = 5750$ MHz; $\sigma = 5.413$ S/m; $\epsilon_r = 35.968$;
 $\rho = 1000$ kg/m³
Ambient Temperature : 23.4 °C; Liquid Temperature : 22.5 °C

DASY5 Configuration:

- Probe: EX3DV4 - SN3975; ConvF(4.73, 4.9, 4.91); Calibrated: 2023/6/22
- Sensor-Surface: 1.4mm (Mechanical Surface Detection)
- Electronics: DAE4 Sn715; Calibrated: 2023/1/23
- Phantom: Twin-SAM1(P1aP2a20); Type: QD 000 P40 CD; Serial: TP:1670
- Measurement SW: DASY52, Version 52.10 (3); SEMCAD X Version 14.6.13 (7474)

Pin=100mW/Area Scan (71x71x1): Interpolated grid: dx=1.000 mm, dy=1.000 mm
Maximum value of SAR (interpolated) = 15.71 W/kg

Pin=100mW/Zoom Scan (7x7x7)/Cube 0: Measurement grid: dx=4mm, dy=4mm, dz=1.4mm
Reference Value = 34.27 V/m; Power Drift = 0.08 dB
Peak SAR (extrapolated) = 10.6 W/kg
SAR(1 g) = 7.95 W/kg; SAR(10 g) = 2.36 W/kg
Maximum value of SAR (measured) = 15.87 W/kg

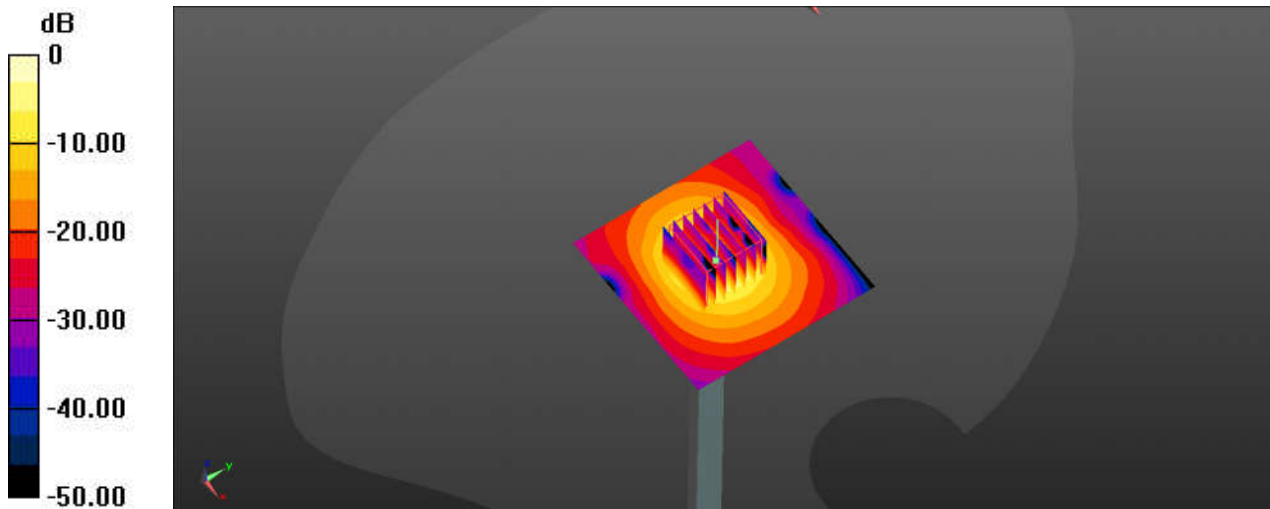

0 dB = 15.87 W/kg

System Check_5750MHz

DUT: D5GHzV2-SN:1341

Communication System: UID 0, CW; Frequency: 5750 MHz; Duty Cycle: 1:1

Medium: HSL_5750_231107 Medium parameters used: $f = 5750$ MHz; $\sigma = 5.009$ S/m; $\epsilon_r = 36.365$; $\rho = 1000$ kg/m³

Ambient Temperature : 23.6 °C; Liquid Temperature : 22.7 °C

DASY5 Configuration:

- Probe: EX3DV4 - SN7641; ConvF(5.39, 5.22, 5.38); Calibrated: 2023/04/24
- Sensor-Surface: 1.4mm (Mechanical Surface Detection)
- Electronics: DAE4 Sn1664; Calibrated: 2023/06/06
- Phantom: Twin-SAM V8.0 (Right); Type: QD 000 P41 AA; Serial: 2033
- Measurement SW: DASY52, Version 52.10 (4); SEMCAD X Version 14.6.14 (7483)

Pin=100mW/Area Scan (71x71x1): Interpolated grid: dx=1.000 mm, dy=1.000 mm

Maximum value of SAR (interpolated) = 18.4 W/kg

Pin=100mW/Zoom Scan (7x7x7)/Cube 0: Measurement grid: dx=4mm, dy=4mm, dz=1.4mm

Reference Value = 65.88 V/m; Power Drift = -0.01 dB

Peak SAR (extrapolated) = 35.6 W/kg

SAR(1 g) = 7.41 W/kg; SAR(10 g) = 2.12 W/kg

Maximum value of SAR (measured) = 19.3 W/kg

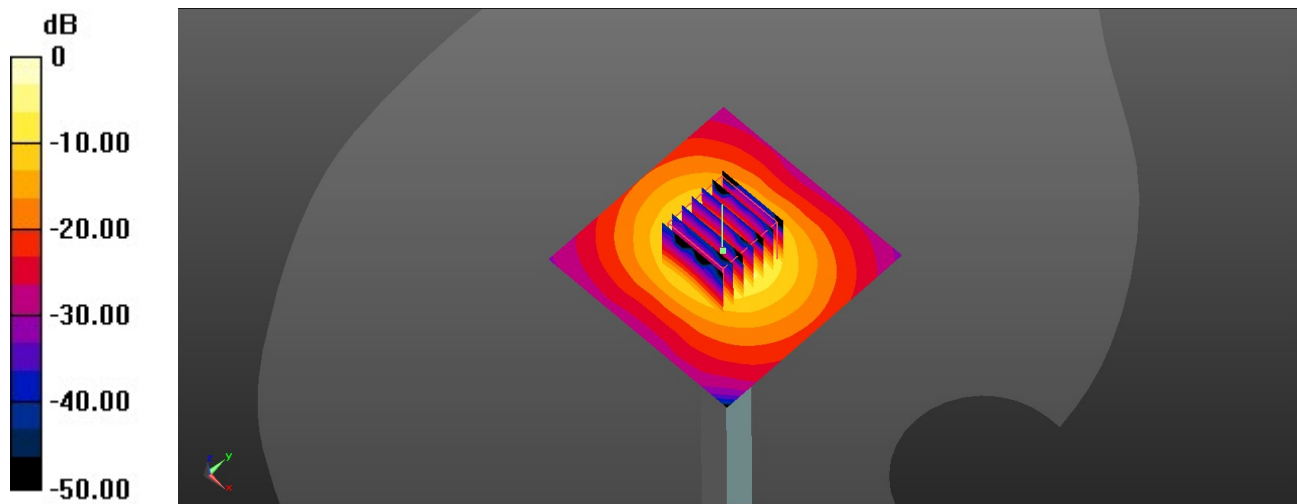

0 dB = 19.3 W/kg

System Check_5750MHz

DUT: D5GHzV2-SN:1341

Communication System: UID 0, CW (0); Frequency: 5750 MHz; Duty Cycle: 1:1

Medium: HSL_5750_231109 Medium parameters used: $f = 5750$ MHz; $\sigma = 5.127$ S/m; $\epsilon_r = 34.965$; $\rho = 1000$ kg/m³

Ambient Temperature : 23.5 °C; Liquid Temperature : 22.6 °C

DASY5 Configuration:

- Probe: EX3DV4 - SN7577; ConvF(5.05, 5.05, 5.05); Calibrated: 2022/11/23
- Sensor-Surface: 1.4mm (Mechanical Surface Detection)
- Electronics: DAE3 Sn360; Calibrated: 2022/12/28
- Phantom: SAM (Front) with CRP v5.0; Type: QD000P40CD; Serial: TP:1795
- Measurement SW: DASY52, Version 52.10 (3); SEMCAD X Version 14.6.13 (7474)

Pin=100mW/Area Scan (71x81x1): Interpolated grid: dx=1.000 mm, dy=1.000 mm

Maximum value of SAR (interpolated) = 13.0 W/kg

Pin=100mW/Zoom Scan (8x8x7)/Cube 0: Measurement grid: dx=4mm, dy=4mm, dz=1.4mm

Reference Value = 38.28 V/m; Power Drift = 0.03 dB

Peak SAR (extrapolated) = 21.5 W/kg

SAR(1 g) = 7.76 W/kg; SAR(10 g) = 2.35 W/kg

Maximum value of SAR (measured) = 12.2 W/kg

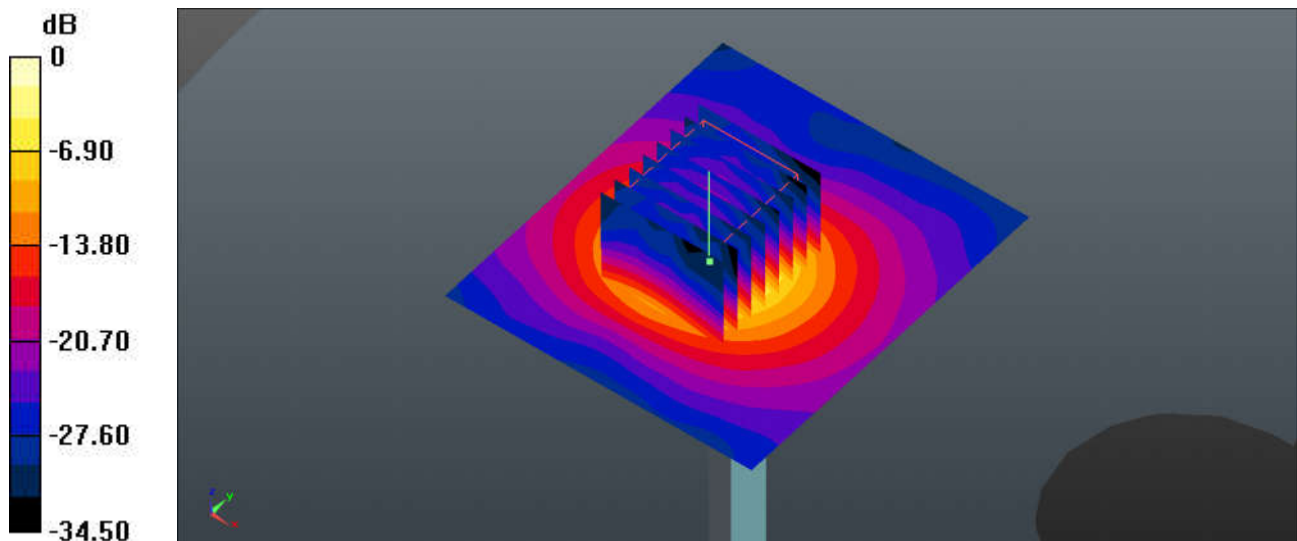

0 dB = 12.2 W/kg