



FCC RF Test Report

APPLICANT : Motorola Mobility LLC
EQUIPMENT : Mobile Cellular Phone
BRAND NAME : Motorola
MODEL NAME : XT2405-1, XT2405V
FCC ID : IHDT56AN6
STANDARD : 47 CFR Part 2, 22, 24, 27
CLASSIFICATION : PCS Licensed Transmitter Held to Ear (PCE)
TEST DATE(S) : Feb. 03, 2024 ~ Mar. 02, 2024

We, Sporton International Inc. (ShenZhen), would like to declare that the tested sample has been evaluated in accordance with the procedures given in ANSI C63.26-2015 and shown compliance with the applicable technical standards.

The test results in this report apply exclusively to the tested model / sample. Without written approval of Sporton International Inc. (ShenZhen), the test report shall not be reproduced except in full.

Jason Jia



Approved by: Jason Jia

Sporton International Inc. (ShenZhen)

1/F, 2/F, Bldg 5, Shiling Industrial Zone, Xinwei Village, Xili, Nanshan, Shenzhen, 518055

People's Republic of China



TABLE OF CONTENTS

REVISION HISTORY...3
SUMMARY OF TEST RESULT...4
1 GENERAL DESCRIPTION...5
1.1 Applicant...5
1.2 Manufacturer...5
1.3 Product Feature of Equipment Under Test...5
1.4 Product Specification of Equipment Under Test...5
1.5 Modification of EUT...6
1.6 Specification of Accessory...6
1.7 Maximum ERP/EIRP and Emission Designator...7
1.8 Testing Location...9
1.9 Test Software...9
1.10 Applicable Standards...9
2 TEST CONFIGURATION OF EQUIPMENT UNDER TEST...10
2.1 Test Mode...10
2.2 Connection Diagram of Test System...12
2.3 Support Unit used in test configuration and system...12
2.4 Measurement Results Explanation Example...12
2.5 Frequency List of Low/Middle/High Channels...13
3 CONDUCTED TEST ITEMS...16
3.1 Measuring Instruments...16
3.2 Test Setup...16
3.3 Test Result of Conducted Test...16
3.4 Conducted Output Power and ERP/EIRP...17
3.5 Peak-to-Average Ratio...18
3.6 Occupied Bandwidth...19
3.7 Conducted Band Edge...20
3.8 Conducted Spurious Emission...22
3.9 Frequency Stability...23
4 RADIATED TEST ITEMS...24
4.1 Measuring Instruments...24
4.2 Test Setup...24
4.3 Test Result of Radiated Test...25
4.4 Radiated Spurious Emission...26
5 LIST OF MEASURING EQUIPMENT...27
6 MEASUREMENT UNCERTAINTY...28
APPENDIX A. TEST RESULTS OF CONDUCTED TEST
APPENDIX B. TEST RESULTS OF RADIATED TEST
APPENDIX C. TEST SETUP PHOTOGRAPHS



REVISION HISTORY

REPORT NO.	VERSION	DESCRIPTION	ISSUED DATE
FG411619J	Rev. 01	Initial issue of report	Mar. 22, 2024



SUMMARY OF TEST RESULT

Report Section	FCC Rule	Description	Limit	Result	Remark
3.4	§2.1046	Conducted Output Power	Reporting Only	PASS	-
	§22.913(a)(5)	Effective Radiated Power (5G NR n5, n26)	ERP < 7 Watt		
	§27.50(b)(10) §27.50(c)(10)	Effective Radiated Power (5G NR n12, n71)	ERP < 3 Watt		
	§24.232(c) §27.50(h)(2)	Equivalent Isotropic Radiated Power (5G NR n2, n25)	EIRP < 2Watt		
3.5	§24.232(d)	Peak-to-Average Ratio	<13 dB	PASS	-
3.6	§2.1049	Occupied Bandwidth	Reporting Only	PASS	-
3.7	§2.1051 §22.917(a) §24.238(a) §27.53(g)	Conducted Band Edge Measurement (5G NR n5, n26) (5G NR n2, n25) (5G NR n12, n71)	< 43+10log ₁₀ (P[Watts])	PASS	-
3.8	§2.1051 §22.917(a) §24.238(a) §27.53(g)	Conducted Spurious Emission (5G NR n5, n26) (5G NR n2, n25) (5G NR n12, n71)	< 43+10log ₁₀ (P[Watts])	PASS	-
3.9	§2.1055 §22.355	Frequency Stability Temperature & Voltage	< 2.5 ppm for Part 22	PASS	-
	§24.235 §27.54		Within Authorized Band		
4.4	§2.1053 §22.917(a) §24.238(a) §27.53(g)	Radiated Spurious Emission (5G NR n5, n26) (5G NR n2, n25) (5G NR n12, n71)	< 43+10log ₁₀ (P[Watts])	PASS	Under limit 10.50 dB at 14464.00 MHz

Conformity Assessment Condition:

- The test results (PASS/FAIL) with all measurement uncertainty excluded are presented against the regulation limits or in accordance with the requirements stipulated by the applicant/manufacturer who shall bear all the risks of non-compliance that may potentially occur if measurement uncertainty is taken into account.
- The measurement uncertainty please refer to each test result in the section "Measurement Uncertainty"

Disclaimer:

The product specifications of the EUT presented in the test report that may affect the test assessments are declared by the manufacturer who shall take full responsibility for the authenticity.



1 General Description

1.1 Applicant

Motorola Mobility LLC
222 W, Merchandise Mart Plaza, Chicago IL 60654 USA

1.2 Manufacturer

Motorola Mobility LLC
222 W, Merchandise Mart Plaza, Chicago IL 60654 USA

1.3 Product Feature of Equipment Under Test

Product Feature	
Equipment	Mobile Cellular Phone
Brand Name	Motorola
Model Name	XT2405-1, XT2405V
FCC ID	IHDT56AN6
IMEI Code	Conducted : 353533390038357/353533390038365 Radiation : 353533390042094/353533390042102
HW Version	DVT2
SW Version	U2UAN34.50
EUT Stage	Identical Prototype

Note: The two model names are only for market segment, no other difference

1.4 Product Specification of Equipment Under Test

Standards-related Product Specification	
Tx Frequency	5G NR n2 : 1850 MHz ~ 1910 MHz 5G NR n5 : 824 MHz ~ 849 MHz 5G NR n12 : 699 MHz ~ 716 MHz 5G NR n25 : 1850 MHz ~ 1915 MHz 5G NR n26 : 824 MHz ~ 849 MHz 5G NR n71: 663 MHz ~ 698 MHz
Rx Frequency	5G NR n2 : 1930 MHz ~ 1990 MHz 5G NR n5 : 869 MHz ~ 894 MHz 5G NR n12 : 729 MHz ~ 746 MHz 5G NR n25 : 1930 MHz ~ 1995 MHz 5G NR n26 : 869 MHz ~ 894 MHz 5G NR n71: 617 MHz ~ 652 MHz
Bandwidth	n2, n5, n26: 5MHz / 10MHz / 15MHz / 20MHz n12: 5MHz / 10MHz / 15MHz n25: 5MHz / 10MHz / 15MHz / 20MHz / 25MHz / 30MHz / 35MHz / 40MHz n71: 5MHz / 10MHz / 15MHz / 20MHz / 25MHz / 30MHz
SCS	15kHz



Antenna Gain	<Ant. 0>: n2: -1.5 dBi n5: -4.0 dBi n12: -4.2 dBi n25: -1.5 dBi n26: -4.0 dBi n71: -5.5 dBi <Ant. 1>: n2: -2.1 dBi n5: -4.8 dBi n12: -5.5 dBi n25: -2.1 dBi n26: -4.8 dBi n71: -6.0 dBi
Type of Modulation	CP-OFDM: QPSK / 16QAM / 64QAM / 256QAM DFT-s-OFDM: PI/2 BPSK / QPSK / 16QAM / 64QAM / 256QAM

Remark:

1. The maximum ERP/EIRP is calculated from max output power and max antenna gain, only the maximum ERP/EIRP of Ant. 0 for 5G NR n2/n5/n12/n25/n26/n71 are shown in the report.
2. All the supported ENDC combinations are verified conducted power, only the ENDC combination with highest power are shown in the report.
3. 5G NR n2/n5/n12/n25/n26/n71 support SA mode and NSA mode. According to the maximum power between SA and NSA mode, SA covers NSA mode.
4. The device supports two PAs for 5G NR n2/n25 (main PA for SA mode and other PA for NSA mode), the maximum power of main PA is higher than the other PA, therefore, we chose higher power PA to calculate the EIRP and show in the report.
5. The EN-DC mode combination could be referred to the product spec.

1.5 Modification of EUT

No modifications are made to the EUT during all test items.

1.6 Specification of Accessory

Specification of Accessory				
AC Adapter 1	Brand Name	Motorola(Chenyang)	Model Name	MC-681N
AC Adapter 2	Brand Name	Motorola (Acbel)	Model Name	MC-681N
Battery	Brand Name	Motorola (NVT)	Model Name	QC50
USB Cable 1	Brand Name	Motorola (Saibao)	Model Name	SC18D71644
USB Cable 2	Brand Name	Motorola (Saibao)	Model Name	SC18D86731
USB Cable 3	Brand Name	Motorola (Luxshare)	Model Name	SC18E08104
USB Cable 4	Brand Name	Motorola (Luxshare)	Model Name	SC18E08103
Wireless Earphones	Brand Name	Motorola	Model Name	XT2441-1



1.7 Maximum ERP/EIRP and Emission Designator

5G NR n2		PI/2 BPSK / QPSK		16QAM / 64QAM / 256QAM	
BW (MHz)	Frequency Range (MHz)	Maximum EIRP(W)	Emission Designator (99%OBW)	Maximum EIRP(W)	Emission Designator (99%OBW)
5	1852.5 ~ 1907.5	0.1442	4M47G7D	0.1343	4M49W7D
10	1855.0 ~ 1905.0	0.1455	9M28G7D	0.1355	9M31W7D
15	1857.5 ~ 1902.5	0.1500	14M1G7D	0.1343	14M1W7D
20	1860.0 ~ 1900.0	0.1503	18M9G7D	0.1371	19M0W7D

5G NR n25		PI/2 BPSK / QPSK		16QAM / 64QAM / 256QAM	
BW (MHz)	Frequency Range (MHz)	Maximum EIRP(W)	Emission Designator (99%OBW)	Maximum EIRP(W)	Emission Designator (99%OBW)
5	1852.5 ~ 1912.5	0.1514	4M48G7D	0.1429	4M49W7D
10	1855.0 ~ 1910.0	0.1479	9M28G7D	0.1406	9M31W7D
15	1857.5 ~ 1907.5	0.1545	14M1G7D	0.1449	14M1W7D
20	1860.0 ~ 1905.0	0.1483	18M9G7D	0.1419	19M0W7D
25	1862.5 ~ 1902.5	0.1528	23M8G7D	0.1432	23M8W7D
30	1865.0 ~ 1900.0	0.1521	28M6G7D	0.1432	28M6W7D
35	1867.5 ~ 1897.5	0.1476	33M6G7D	0.1390	33M6W7D
40	1870.0 ~ 1895.0	0.1626	38M5G7D	0.1479	38M6W7D

5G NR n5		PI/2 BPSK / QPSK		16QAM / 64QAM / 256QAM	
BW (MHz)	Frequency Range (MHz)	Maximum ERP(W)	Emission Designator (99%OBW)	Maximum ERP(W)	Emission Designator (99%OBW)
5	826.5 ~ 846.5	0.0524	4M47G7D	0.0484	4M50W7D
10	829.0 ~ 844.0	0.0491	9M28G7D	0.0458	9M27W7D
15	831.5 ~ 841.5	0.0512	14M1G7D	0.0470	14M1W7D
20	834.0 ~ 839.0	0.0533	18M9G7D	0.0486	18M9W7D

5G NR n26		PI/2 BPSK / QPSK		16QAM / 64QAM / 256QAM	
BW (MHz)	Frequency Range (MHz)	Maximum ERP(W)	Emission Designator (99%OBW)	Maximum ERP(W)	Emission Designator (99%OBW)
5	826.5 ~ 846.5	0.0518	4M47G7D	0.0473	4M50W7D
10	829.0 ~ 844.0	0.0505	9M28G7D	0.0474	9M27W7D
15	831.5 ~ 841.5	0.0497	14M1G7D	0.0463	14M1W7D
20	834.0 ~ 839.0	0.0537	18M9G7D	0.0490	18M9W7D



5G NR n12		PI/2 BPSK / QPSK		16QAM / 64QAM / 256QAM	
BW (MHz)	Frequency Range (MHz)	Maximum ERP(W)	Emission Designator (99%OBW)	Maximum ERP(W)	Emission Designator (99%OBW)
5	701.5 ~ 713.5	0.0556	4M47G7D	0.0508	4M48W7D
10	704.0~ 711.0	0.0553	9M27G7D	0.0515	9M28W7D
15	706.5 ~ 708.5	0.0578	14M1G7D	0.0526	14M1W7D

5G NR n71		PI/2 BPSK / QPSK		16QAM / 64QAM / 256QAM	
BW (MHz)	Frequency Range (MHz)	Maximum ERP(W)	Emission Designator (99%OBW)	Maximum ERP(W)	Emission Designator (99%OBW)
5	665.5 ~ 695.5	0.0421	4M47G7D	0.0403	4M49W7D
10	668.0 ~ 693.0	0.0417	9M28G7D	0.0394	9M30W7D
15	670.5 ~ 690.5	0.0397	14M1G7D	0.0375	14M1W7D
20	673.0 ~ 688.0	0.0369	18M9G7D	0.0356	18M9W7D
25	675.5 ~ 685.5	0.0358	23M7G7D	0.0334	23M7W7D
30	678.0 ~ 683.0	0.0425	28M5G7D	0.0406	28M6W7D

Note:

1. 5G NR n26 overlaps the entire frequency range of 5G NR n5. Therefore, the test results provided in this report covers 5G NR n5 and the portion of 5G NR n26 subject to Part 22.
2. 5G NR n25 overlaps the entire frequency range of 5G NR n2. Therefore, the test results provided in this report covers 5G NR n25 as well as 5G NR n2.
3. All modulations have been tested, only the worst test results of PSK & QAM are shown in the report.



1.8 Testing Location

Sporton International Inc. (ShenZhen) is accredited to ISO/IEC 17025:2017 by American Association for Laboratory Accreditation with Certificate Number 5145.01.

Test Firm	Sporton International Inc. (ShenZhen)		
Test Site Location	1/F, 2/F, Bldg 5, Shiling Industrial Zone, Xinwei Village, Xili, Nanshan, Shenzhen, 518055 People’s Republic of China TEL: +86-755-86379589 FAX: +86-755-86379595		
Test Site No.	Sporton Site No.	FCC Designation No.	FCC Test Firm Registration No.
	TH01-SZ	CN1256	421272

Test Firm	Sporton International Inc. (ShenZhen)		
Test Site Location	101, 1st Floor, Block B, Building 1, No. 2, Tengfeng 4th Road, Fenghuang Community, Fuyong Street, Baoan District, Shenzhen City, Guangdong Province 518103 People’s Republic of China TEL: +86-755-86066985		
Test Site No.	Sporton Site No.	FCC Designation No.	FCC Test Firm Registration No.
	03CH03-SZ	CN1256	421272

1.9 Test Software

Item	Site	Manufacture	Name	Version
1.	03CH03-SZ	AUDIX	E3	6.2009-8-24

1.10 Applicable Standards

According to the specifications of the manufacturer, the EUT must comply with the requirements of the following standards:

- ♦ 47 CFR Part 2, 22, 24, 27
- ♦ ANSI C63.26-2015
- ♦ FCC KDB 971168 D01 Power Meas License Digital Systems v03r01
- ♦ FCC KDB 412172 D01 Determining ERP and EIRP v01r01

Remark: All test items were verified and recorded according to the standards and without any deviation during the test.



2 Test Configuration of Equipment Under Test

2.1 Test Mode

Antenna port conducted and radiated test items are performed according to KDB 971168 D01 Power Meas License Digital Systems v03r01 with maximum output power.

For radiated measurement, pre-scanned in three orthogonal panels, X, Y, Z. The worst cases (X plane) were recorded in this report.

The device is investigated from 30MHz to 10 times of fundamental signal for radiated spurious emission test under different RB size/offset and modulations in exploratory test. Subsequently, only the worst case emissions are reported.

Orthogonal Planes of EUT	X Plane	Y Plane	Z Plane
			

Test Items	5G NR	Bandwidth (MHz)														Modulation				RB #		Test Channel						
		5	10	15	20	25	30	35	40	50	60	70	80	90	100	PI/2 BPSK	QPSK	16 QAM	64 QAM	256 QAM	1	Full	L	M	H			
Max. Output Power	n2	v	v	v	v	-	-	-	-	-	-	-	-	-	-	v	v	v	v	v	v	v	v	v	v	v	v	
	n5	v	v	v	v	-	-	-	-	-	-	-	-	-	-	v	v	v	v	v	v	v	v	v	v	v	v	v
	n12	v	v	v	-	-	-	-	-	-	-	-	-	-	-	v	v	v	v	v	v	v	v	v	v	v	v	v
	n25	v	v	v	v	v	v	v	v	-	-	-	-	-	-	v	v	v	v	v	v	v	v	v	v	v	v	v
	n26	v	v	v	v	-	-	-	-	-	-	-	-	-	-	v	v	v	v	v	v	v	v	v	v	v	v	v
	n71	v	v	v	v	v	v	-	-	-	-	-	-	-	-	v	v	v	v	v	v	v	v	v	v	v	v	v
Peak-to-Average Ratio	n12		v		-	-	-	-	-	-	-	-	-	-	v	v					v		v					
	n25				v					-	-	-	-	-	v	v					v		v					
	n26				v	-	-	-	-	-	-	-	-	-	v	v					v		v					
	n71				v			-	-	-	-	-	-	-	v	v					v		v					
26dB and 99% Bandwidth	n12	v	v	v	-	-	-	-	-	-	-	-	-	-		v	v	v	v		v		v					
	n25	v	v	v	v	v	v	v	v	-	-	-	-	-		v	v	v	v		v		v					
	n26	v	v	v	v	-	-	-	-	-	-	-	-	-		v	v	v	v		v		v					
	n71	v	v	v	v	v	v	-	-	-	-	-	-	-		v	v	v	v		v		v					
Conducted Band Edge	n12	v	v	v	-	-	-	-	-	-	-	-	-	-	v	v				v	v	v					v	
	n25	v			v				v	-	-	-	-	-	v	v				v	v	v					v	
	n26	v	v		v	-	-	-	-	-	-	-	-	-	v	v				v	v	v					v	
	n71	v			v		v	-	-	-	-	-	-	-	v	v				v	v	v					v	



Test Items	5G NR	Bandwidth (MHz)														Modulation					RB #		Test Channel		
		5	10	15	20	25	30	35	40	50	60	70	80	90	100	PI/2 BPSK	QPSK	16 QAM	64 QAM	256 QAM	1	Full	L	M	H
Conducted Spurious Emission	n12	v	v	v	-	-	-	-	-	-	-	-	-	-	-	v	v				v		v	v	v
	n25	v			v				v	-	-	-	-	-	-	v	v				v		v	v	v
	n26	v	v		v	-	-	-	-	-	-	-	-	-	-	v	v				v		v	v	v
	n71	v			v		v	-	-	-	-	-	-	-	-	v	v				v		v	v	v
Frequency Stability	n12		v		-	-	-	-	-	-	-	-	-	-	-		v					v			v
	n25				v					-	-	-	-	-	-		v					v			v
	n26				v	-	-	-	-	-	-	-	-	-	-		v					v			v
	n71				v			-	-	-	-	-	-	-	-		v					v			v
E.R.P / E.I.R.P	n2	v	v	v	v	-	-	-	-	-	-	-	-	-	-	v	v	v	v	v	v	v	v	v	v
	n5	v	v	v	v	-	-	-	-	-	-	-	-	-	-	v	v	v	v	v	v	v	v	v	v
	n12	v	v	v	-	-	-	-	-	-	-	-	-	-	-	v	v	v	v	v	v	v	v	v	v
	n25	v	v	v	v	v	v	v	v	-	-	-	-	-	-	v	v	v	v	v	v	v	v	v	v
	n26	v	v	v	v	-	-	-	-	-	-	-	-	-	-	v	v	v	v	v	v	v	v	v	v
	n71	v	v	v	v	v	v	-	-	-	-	-	-	-	-	v	v	v	v	v	v	v	v	v	v
Radiated Spurious Emission	n12	Worst Case																			v	v	v		
	n25	Worst Case																			v	v	v		
	n26	Worst Case																			v	v	v		
	n71	Worst Case																			v	v	v		
Note	1. The mark "v" means that this configuration is chosen for testing 2. The mark "-" means that this bandwidth is not supported. 3. The device is investigated from 30MHz to 10 times of fundamental signal for radiated spurious emission test under different RB size/offset and modulations in exploratory test. Subsequently, only the worst case emissions are reported. 4. Frequency Stability : Normal Voltage = 3.91V ; Low Voltage =3.40V. ; High Voltage =4.50V																								

2.2 Connection Diagram of Test System

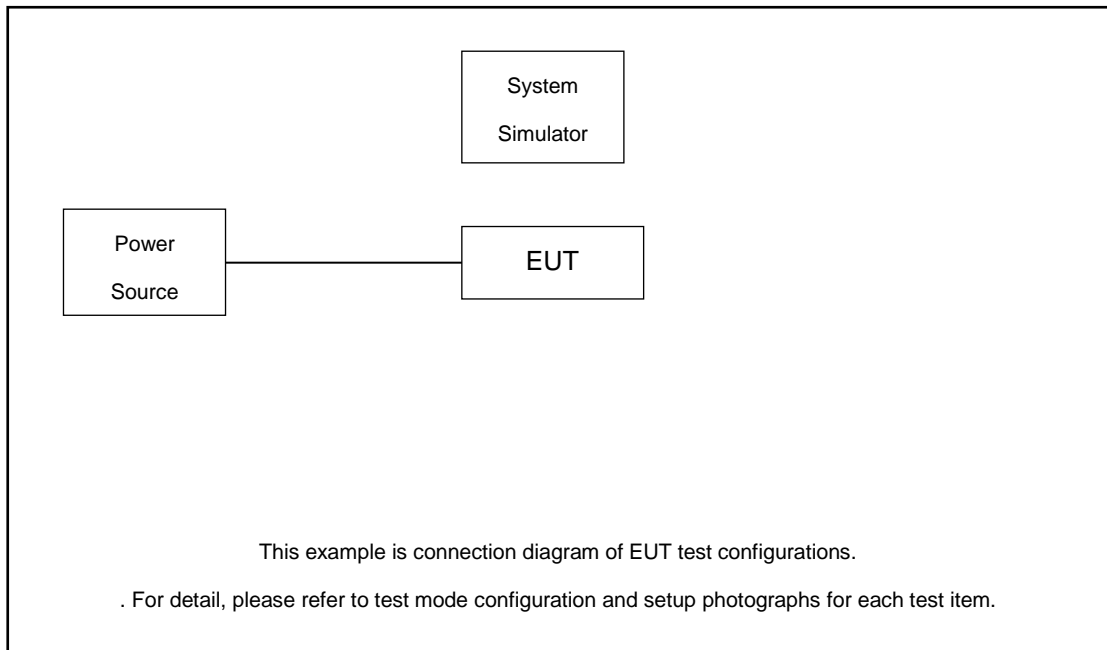

The EUT has been configuration operated in a manner tended to maximize its emission characteristics in a typical application.

2.3 Support Unit used in test configuration and system

Item	Equipment	Trade Name	Model No.	FCC ID	Data Cable	Power Cord
1.	DC Power Supply	GW	GPS-3030D	N/A	N/A	Unshielded, 1.8 m
2.	LTE Base Station	Anritsu	MT8821C	N/A	N/A	Unshielded, 1.8 m
3.	NR Base Station	Anritsu	MT8000A	N/A	N/A	Unshielded, 1.8 m

2.4 Measurement Results Explanation Example

For all conducted test items:

The offset level is set in the spectrum analyzer to compensate the RF cable loss between EUT conducted output port and spectrum analyzer. With the offset compensation, the spectrum analyzer reading level is exactly the EUT RF output level.

The spectrum analyzer offset is derived from RF cable loss.

Offset = RF cable loss.

Following shows an offset computation example with cable loss 7.5 dB.

Example :

$$\text{Offset(dB)} = \text{RF cable loss(dB)} \\ = 7.5 \text{ (dB)}$$



2.5 Frequency List of Low/Middle/High Channels

5G NR n2 Channel and Frequency List				
BW [MHz]	Channel/Frequency(MHz)	Lowest	Middle	Highest
20	Channel	372000	376000	380000
	Frequency	1860	1880	1900
15	Channel	371500	376000	380500
	Frequency	1857.5	1880	1902.5
10	Channel	371000	376000	381000
	Frequency	1855	1880	1905
5	Channel	370500	376000	381500
	Frequency	1852.5	1880	1907.5

5G NR n5 Channel and Frequency List				
BW [MHz]	Channel/Frequency(MHz)	Lowest	Middle	Highest
20	Channel	166800	167300	167800
	Frequency	834	836.5	839
15	Channel	166300	167300	168300
	Frequency	831.5	836.5	841.5
10	Channel	165800	167300	168800
	Frequency	829	836.5	844
5	Channel	165300	167300	169300
	Frequency	826.5	836.5	846.5

5G NR n12 Channel and Frequency List				
BW [MHz]	Channel/Frequency(MHz)	Lowest	Middle	Highest
15	Channel	141300	141500	141700
	Frequency	706.5	707.5	708.5
10	Channel	140800	141500	142200
	Frequency	704	707.5	711
5	Channel	140300	141500	142700
	Frequency	701.5	707.5	713.5



5G NR n25 Channel and Frequency List				
BW [MHz]	Channel/Frequency(MHz)	Lowest	Middle	Highest
40	Channel	390000	392500	395000
	Frequency	1870	1882.5	1895
35	Channel	373500	392500	379500
	Frequency	1867.5	1882.5	1897.5
30	Channel	389000	392500	396000
	Frequency	1865	1882.5	1900
25	Channel	388500	392500	396500
	Frequency	1862.5	1882.5	1902.5
20	Channel	372000	376500	381000
	Frequency	1860	1882.5	1905
15	Channel	371500	376500	381500
	Frequency	1857.5	1882.5	1907.5
10	Channel	371000	376500	382000
	Frequency	1855	1882.5	1910
5	Channel	370500	376500	382500
	Frequency	1852.5	1882.5	1912.5

5G NR n26 Channel and Frequency List				
BW [MHz]	Channel/Frequency(MHz)	Lowest	Middle	Highest
20	Channel	166800	167300	167800
	Frequency	834	836.5	839
15	Channel	166300	167300	168300
	Frequency	831.5	836.5	841.5
10	Channel	165800	167300	168800
	Frequency	829	836.5	844
5	Channel	165300	167300	169300
	Frequency	826.5	836.5	846.5



5G NR n71 Channel and Frequency List				
BW [MHz]	Channel/Frequency(MHz)	Lowest	Middle	Highest
30	Channel	135600	136100	136600
	Frequency	678	680.5	683
25	Channel	135100	136100	137100
	Frequency	675.5	680.5	685.5
20	Channel	134600	136100	137600
	Frequency	673	680.5	688
15	Channel	134100	136100	138100
	Frequency	670.5	680.5	690.5
10	Channel	133600	136100	138600
	Frequency	668	680.5	693
5	Channel	133100	136100	139100
	Frequency	665.5	680.5	695.5

3 Conducted Test Items

3.1 Measuring Instruments

See list of measuring instruments of this test report.

3.2 Test Setup

3.2.1 Conducted Output Power



3.2.2 Peak-to-Average Ratio, Occupied Bandwidth ,Conducted Band-Edge and Conducted Spurious Emission



3.2.3 Frequency Stability

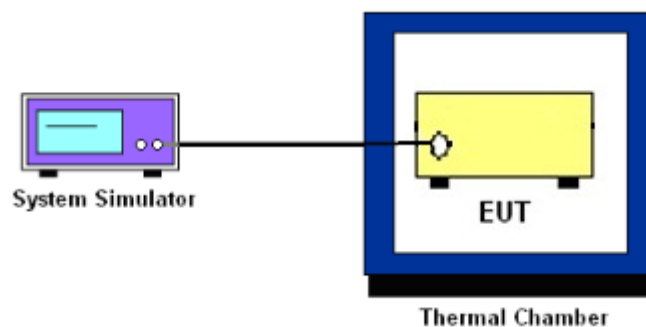

3.3 Test Result of Conducted Test

Please refer to Appendix A.



3.4 Conducted Output Power and ERP/EIRP

3.4.1 Description of the Conducted Output Power Measurement and ERP/EIRP Measurement

A system simulator was used to establish communication with the EUT. Its parameters were set to force the EUT transmitting at maximum output power. The measured power in the radio frequency on the transmitter output terminals shall be reported.

The ERP of mobile transmitters must not exceed 7 Watts for 5G NR n5, n26.

The ERP of mobile transmitters must not exceed 3 Watts for 5G NR n12, n71.

The EIRP of mobile transmitters must not exceed 2 Watts for 5G NR n2, n25.

According to KDB 412172 D01 Power Approach,

$EIRP = P_T + G_T - L_C$, $ERP = EIRP - 2.15$, where

P_T = transmitter output power in dBm

G_T = gain of the transmitting antenna in dBi

L_C = signal attenuation in the connecting cable between the transmitter and antenna in dB

3.4.2 Test Procedures

1. The testing follows ANSI C63.26 Section 5.2
2. The transmitter output port was connected to the system simulator.
3. Set EUT at maximum power through the system simulator.
4. Select lowest, middle, and highest channels for each band and different modulation.
5. Measure and record the power level from the system simulator.



3.5 Peak-to-Average Ratio

3.5.1 Description of the PAR Measurement

Power Complementary Cumulative Distribution Function (CCDF) curves provide a means for characterizing the power peaks of a digitally modulated signal on a statistical basis. A CCDF curve depicts the probability of the peak signal amplitude exceeding the average power level. Most contemporary measurement instrumentation include the capability to produce CCDF curves for an input signal provided that the instrument's resolution bandwidth can be set wide enough to accommodate the entire input signal bandwidth. In measuring transmissions in this band using an average power technique, the peak-to-average ratio (PAR) of the transmission may not exceed 13 dB.

3.5.2 Test Procedures

1. The testing follows ANSI C63.26 Section 5.2.3.4 (CCDF).
2. The EUT was connected to spectrum and system simulator via a power divider.
3. Set the CCDF (Complementary Cumulative Distribution Function) option in spectrum analyzer.
4. The highest RF powers were measured and recorded the maximum PAPR level associated with a probability of 0.1 %.
5. Record the deviation as Peak to Average Ratio.



3.6 Occupied Bandwidth

3.6.1 Description of Occupied Bandwidth Measurement

The occupied bandwidth is the width of a frequency band such that, below the lower and above the upper frequency limits, the mean powers emitted are each equal to a specified percentage 0.5% of the total mean transmitted power.

The 26 dB emission bandwidth is defined as the frequency range between two points, one above and one below the carrier frequency, at which the spectral density of the emission is attenuated 26 dB below the maximum in-band spectral density of the modulated signal. Spectral density (power per unit bandwidth) is to be measured with a detector of resolution bandwidth equal to approximately 1.0% of the emission bandwidth.

3.6.2 Test Procedures

1. The testing follows ANSI C63.26 Section 5.4
2. The EUT was connected to spectrum analyzer and system simulator via a power divider.
3. The spectrum analyzer center frequency is set to the nominal EUT channel center frequency. The span range for the spectrum analyzer shall be between two and five times the anticipated OBW.
4. The nominal resolution bandwidth (RBW) shall be in the range of 1 to 5 % of the anticipated OBW, and the VBW shall be at least 3 times the RBW.
5. Set the detection mode to peak, and the trace mode to max hold.
6. Determine the reference value: Set the EUT to transmit a modulated signal. Allow the trace to stabilize. Set the spectrum analyzer marker to the highest level of the displayed trace.
(this is the reference value)
7. Determine the “-26 dB down amplitude” as equal to (Reference Value – X).
8. Place two markers, one at the lowest and the other at the highest frequency of the envelope of the spectral display such that each marker is at or slightly below the “-X dB down amplitude” determined in step 6. If a marker is below this “-X dB down amplitude” value it shall be placed as close as possible to this value. The OBW is the positive frequency difference between the two markers.
9. Use the 99 % power bandwidth function of the spectrum analyzer and report the measured bandwidth.



3.7 Conducted Band Edge

3.7.1 Description of Conducted Band Edge Measurement

22.917(a)

For operations in the 824 – 849 MHz band, the FCC limit is $43 + 10\log_{10}(P[\text{Watts}])$ dB below the transmitter power $P(\text{Watts})$ in a 100kHz bandwidth. However, in the 1MHz bands immediately outside and adjacent to the licensee's frequency block, a resolution bandwidth of at least one percent of the emission bandwidth of the fundamental emission of the transmitter may be employed.

24.238 (a)

For operations in the 1850-1910 and 1930-1990 MHz band, the FCC limit is $43 + 10\log_{10}(P[\text{Watts}])$ dB below the transmitter power $P(\text{Watts})$ in a 1MHz bandwidth. However, in the 1 MHz bands immediately outside and adjacent to the frequency block a resolution bandwidth of at least one percent of the emission bandwidth of the fundamental emission of the transmitter may be employed.

27.53 (g)

For operations in the 600MHz band and 698 -746 MHz band, the FCC limit is $43 + 10\log_{10}(P[\text{Watts}])$ dB below the transmitter power $P(\text{Watts})$ in a 100 kHz bandwidth. However, in the 100 kilohertz bands immediately outside and adjacent to a licensee's frequency block, a resolution bandwidth of at least 30 kHz may be employed.



3.7.2 Test Procedures

1. The testing follows ANSI C63.26 section 5.7
2. The EUT was connected to spectrum analyzer and system simulator via a power divider.
3. The band edges of low and high channels for the highest RF powers were measured.
4. Set RBW \geq 1% EBW in the 1MHz band immediately outside and adjacent to the band edge.
5. Beyond the 1 MHz band from the band edge, RBW=1MHz was used or a narrower RBW was used (generally limited to no less than 1% of the OBW) and the measured power was integrated over the full required measurement bandwidth.
6. Set spectrum analyzer with RMS detector.
7. The RF fundamental frequency should be excluded against the limit line in the operating frequency band.
8. Checked that all the results comply with the emission limit line.

Example:

The limit line is derived from $43 + 10\log(P)$ dB below the transmitter power P(Watts)

$$= P(W) - [43 + 10\log(P)] \text{ (dB)}$$

$$= [30 + 10\log(P)] \text{ (dBm)} - [43 + 10\log(P)] \text{ (dB)} = -13\text{dBm}.$$

9. When using the integration method, the starting frequency of the integration shall be centered at one-half of the RBW away from the band edge.



3.8 Conducted Spurious Emission

3.8.1 Description of Conducted Spurious Emission Measurement

The power of any emission outside of the authorized operating frequency ranges must be lower than the transmitter power (P) by a factor of at least $43 + 10 \log (P)$ dB.

It is measured by means of a calibrated spectrum analyzer and scanned from 30 MHz up to a frequency including its 10th harmonic.

3.8.2 Test Procedures

1. The testing follows ANSI C63.26 section 5.7
2. The EUT was connected to spectrum analyzer and system simulator via a power divider.
3. The RF output of EUT was connected to the spectrum analyzer by RF cable and attenuator. The path loss was compensated to the results for each measurement.
4. The middle channel for the highest RF power within the transmitting frequency was measured.
5. The conducted spurious emission for the whole frequency range was taken.
6. Make the measurement with the spectrum analyzer's RBW = 1MHz, VBW = 3MHz.
7. Set spectrum analyzer with RMS detector.
8. Taking the record of maximum spurious emission.
9. The RF fundamental frequency should be excluded against the limit line in the operating frequency band.
10. The limit line is derived from $43 + 10\log(P)$ dB below the transmitter power P(Watts)
= P(W)- [43 + 10log(P)] (dB)
= [30 + 10log(P)] (dBm) - [43 + 10log(P)] (dB)
= -13dBm.



3.9 Frequency Stability

3.9.1 Description of Frequency Stability Measurement

The frequency stability shall be measured by variation of ambient temperature and variation of primary supply voltage to ensure that the fundamental emission stays within the authorized frequency block. The frequency stability of the transmitter shall be maintained within $\pm 0.00025\%$ ($\pm 2.5\text{ppm}$) of the center frequency.

3.9.2 Test Procedures for Temperature Variation

1. The testing follows ANSI C63.26 section 5.6.4
2. The EUT was set up in the thermal chamber and connected with the system simulator.
3. With power OFF, the temperature was decreased to -30°C and the EUT was stabilized before testing. Power was applied and the maximum change in frequency was recorded within one minute.
4. With power OFF, the temperature was raised in 10°C step up to 50°C . The EUT was stabilized at each step for at least half an hour. Power was applied and the maximum frequency change was recorded within one minute.

3.9.3 Test Procedures for Voltage Variation

1. The testing follows ANSI C63.26 section 5.6.5
2. The EUT was placed in a temperature chamber at $20\pm 5^{\circ}\text{C}$ and connected with the system simulator.
3. The power supply voltage to the EUT was varied from 85% to 115% of the nominal value for other than hand carried battery equipment.
4. For hand carried, battery powered equipment, reduce the primary ac or dc supply voltage to the battery operating end point, which shall be specified by the manufacturer.
5. The variation in frequency was measured for the worst case.

4 Radiated Test Items

4.1 Measuring Instruments

See list of measuring instruments of this test report.

4.2 Test Setup

4.2.1 For radiated test below 30MHz

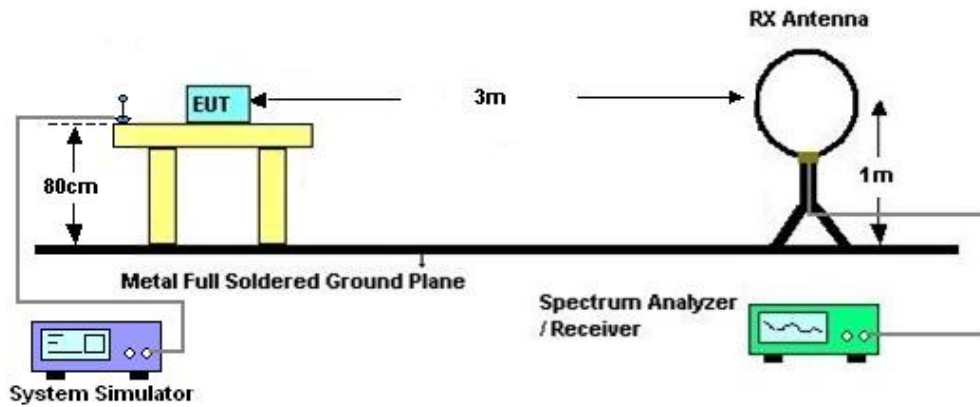

4.2.2 For radiated test from 30MHz to 1GHz

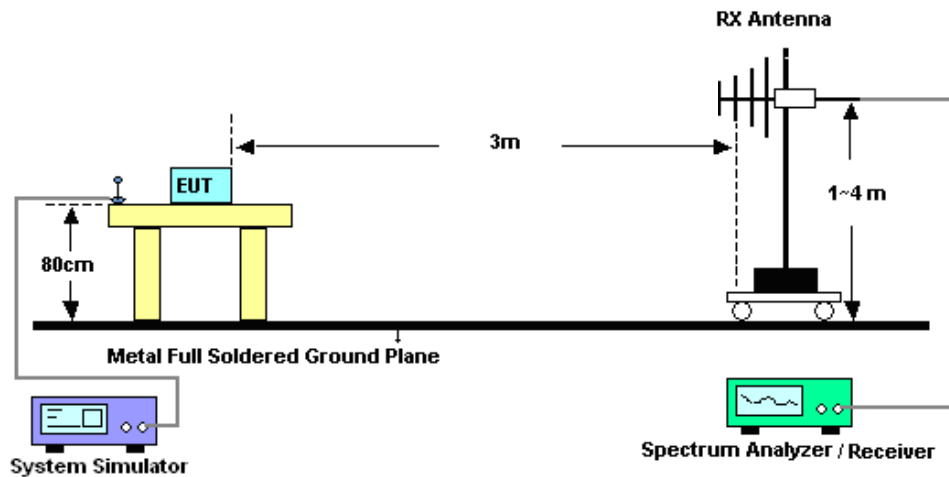

4.2.3 For radiated test above 1GHz

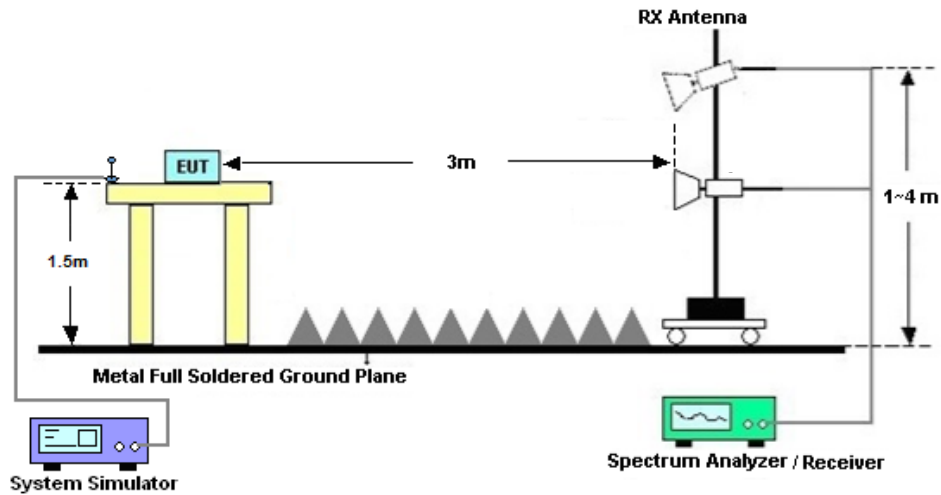

4.3 Test Result of Radiated Test

The low frequency, which started from 9 kHz to 30MHz, was pre-scanned and the result which was 20dB lower than the limit line was not reported.

Please refer to Appendix B.



4.4 Radiated Spurious Emission

4.4.1 Description of Radiated Spurious Emission

The radiated spurious emission was measured by substitution method according to ANSI C63.26. The power of any emission outside of the authorized operating frequency ranges must be attenuated below the transmitter power (P) by a factor of at least $43 + 10 \log (P)$ dB.

The spectrum is scanned from 30 MHz up to a frequency including its 10th harmonic.

4.4.2 Test Procedures

1. The testing follows ANSI C63.26 Section 5.5
2. The EUT was placed on a turntable with 0.8 meter height for frequency below 1GHz and 1.5 meter height for frequency above 1GHz respectively above ground.
3. The EUT was set 3 meters from the receiving antenna mounted on the antenna tower.
4. The table was rotated 360 degrees to determine the position of the highest spurious emission.
5. The height of the receiving antenna is varied between 1m to 4m to search the maximum spurious emission for both horizontal and vertical polarizations.
6. During the measurement, the system simulator parameters were set to force the EUT transmitting at maximum output power.
7. Make the measurement with the spectrum analyzer's RBW = 1MHz, VBW = 3MHz, taking the record of maximum spurious emission.
8. A horn antenna was substituted in place of the EUT and was driven by a signal generator.
9. Tune the output power of signal generator to the same emission level with EUT maximum spurious emission.
10. $EIRP (dBm) = S.G. Power - Tx Cable Loss + Tx Antenna Gain$
11. $ERP (dBm) = EIRP - 2.15$
12. The RF fundamental frequency should be excluded against the limit line in the operating frequency band.

The limit line is derived from $43 + 10\log(P)$ dB below the transmitter power P(Watts)
 $= P(W) - [43 + 10\log(P)] (dB)$
 $= [30 + 10\log(P)] (dBm) - [43 + 10\log(P)] (dB)$
 $= -13dBm.$



5 List of Measuring Equipment

Instrument	Manufacturer	Model No.	Serial No.	Characteristics	Calibration Date	Test Date	Due Date	Remark
Spectrum Analyzer	R&S	FSV40	101078	10Hz~40GHz	Apr. 06, 2023	Feb. 03, 2024~ Feb. 22, 2024	Apr. 05, 2024	Conducted (TH01-SZ)
DC Power Supply	TTI	PL330P	290070	Max 32V , 3A	Oct. 16, 2023	Feb. 03, 2024~ Feb. 22, 2024	Oct. 15, 2024	Conducted (TH01-SZ)
Power Divider	TOJOIN	PS-2SM-04 265	60.06.020.007 7	0.4GHz~26.5GHz	Dec. 25, 2023	Feb. 03, 2024~ Feb. 22, 2024	Dec. 24, 2024	Conducted (TH01-SZ)
Thermal Chamber	Ten Billion Hongzhangroup	LP-150U	H2014081803	-40~+150°C	Jul. 05, 2023	Feb. 03, 2024~ Feb. 22, 2024	Jul. 04, 2024	Conducted (TH01-SZ)
EMI Test Receiver&SA	KEYSIGHT	N9038A	MY54450083	20Hz~8.4GHz	Apr. 04, 2023	Feb. 29, 2024~ Mar. 02, 2024	Apr. 03, 2024	Radiation (03CH03-SZ)
EXA Spectrum Analyzer	KEYSIGHT	N9010A	MY55150246	10Hz~44GHz;	Apr. 04, 2023	Feb. 29, 2024~ Mar. 02, 2024	Apr. 03, 2024	Radiation (03CH03-SZ)
Loop Antenna	R&S	HFH2-Z2	100354	9kHz~30MHz	Jun. 28, 2022	Feb. 29, 2024~ Mar. 02, 2024	Jun. 27, 2024	Radiation (03CH03-SZ)
Bilog Antenna	TeseQ	CBL6112D	35408	30MHz-2GHz	Aug. 20, 2023	Feb. 29, 2024~ Mar. 02, 2024	Aug. 19, 2025	Radiation (03CH03-SZ)
Double Ridge Horn Antenna	SCHWARZBECK	BBHA9120D	9120D-1355	1GHz~18GHz	Apr. 08, 2023	Feb. 29, 2024~ Mar. 02, 2024	Apr. 07, 2024	Radiation (03CH03-SZ)
SHF-EHF Horn	com-power	AH-840	101071	18Ghz-40GHz	Apr. 08, 2023	Feb. 29, 2024~ Mar. 02, 2024	Apr. 07, 2024	Radiation (03CH03-SZ)
Amplifier	Burgeon	BPA-530	102211	0.01Hz ~3000MHz	Oct. 18, 2023	Feb. 29, 2024~ Mar. 02, 2024	Oct. 17, 2024	Radiation (03CH03-SZ)
HF Amplifier	MITEQ	TTA1840-35 -HG	1871923	18GHz~40GHz	Jul. 07, 2023	Feb. 29, 2024~ Mar. 02, 2024	Jul. 06, 2024	Radiation (03CH03-SZ)
Amplifier	Agilent Technologies	83017A	MY39501302	500MHz~26.5GHz	Dec. 27, 2023	Feb. 29, 2024~ Mar. 02, 2024	Dec. 26, 2024	Radiation (03CH03-SZ)
AC Power Source	Chroma	61601	616010002729	N/A	Oct. 18, 2023	Feb. 29, 2024~ Mar. 02, 2024	Oct. 17, 2024	Radiation (03CH03-SZ)
Turn Table	EM	EM1000	N/A	0~360 degree	NCR	Feb. 29, 2024~ Mar. 02, 2024	NCR	Radiation (03CH03-SZ)
Antenna Mast	EM	EM1000	N/A	1 m~4 m	NCR	Feb. 29, 2024~ Mar. 02, 2024	NCR	Radiation (03CH03-SZ)

NCR: No Calibration Required



6 Measurement Uncertainty

The measurement uncertainties shown below were calculated in accordance with the requirements of ANSI 63.26-2015. All the measurement uncertainty value were shown with a coverage K=2 to indicate 95% level of confidence. The measurement data show herein meets or exceeds the CISPR measurement uncertainty values specified in CISPR 16-4-2 and can be compared directly to specified limit to determine compliance.

Uncertainty of Conducted Measurement

Test Item	Uncertainty
Conducted Spurious Emission & Bandedge	±1.34 dB
Occupied Channel Bandwidth	±0.012 MHz
Conducted Power	±1.34 dB
Peak to Average Ratio	±1.34 dB
Frequency Stability	±1.3 Hz

Uncertainty of Radiated Emission Measurement (30 MHz ~ 1000 MHz)

Measuring Uncertainty for a Level of Confidence of 95% (U = 2Uc(y))	3.0dB
---	-------

Uncertainty of Radiated Emission Measurement (1 GHz ~ 18 GHz)

Measuring Uncertainty for a Level of Confidence of 95% (U = 2Uc(y))	3.6dB
---	-------

Uncertainty of Radiated Emission Measurement (18 GHz ~ 40 GHz)

Measuring Uncertainty for a Level of Confidence of 95% (U = 2Uc(y))	3.8dB
---	-------

----- THE END -----



Appendix A. Test Results of Conducted Test

Test Engineer :	Jung Guo	Temperature :	22~23°C
		Relative Humidity :	40~42%

FR1 N2_ANT 0

Transmitter Conducted Output Power And EIRP, (G_T - L_C)=-1.5dB

NR Band	SCS (kHz)	Bandwidth (MHz)	Arfcn	Freq (MHz)	Modulation	RB	Conducted Power(dBm)	EIRP (dBm)	EIRP (W)
2	15	5	370500	1852.5	DFT-s-OFDM QPSK	1@1	23.09	21.59	0.1442
2	15	5	370500	1852.5	DFT-s-OFDM 16 QAM	1@1	22.78	21.28	0.1343
2	15	5	376000	1880	DFT-s-OFDM QPSK	1@1	22.69	21.19	0.1315
2	15	5	376000	1880	DFT-s-OFDM 16 QAM	1@1	22.45	20.95	0.1245
2	15	5	381500	1907.5	DFT-s-OFDM QPSK	1@1	22.92	21.42	0.1387
2	15	5	381500	1907.5	DFT-s-OFDM 16 QAM	1@1	22.59	21.09	0.1285
2	15	10	371000	1855	DFT-s-OFDM QPSK	1@1	23.13	21.63	0.1455
2	15	10	371000	1855	DFT-s-OFDM 16 QAM	1@1	22.82	21.32	0.1355
2	15	10	376000	1880	DFT-s-OFDM QPSK	1@1	22.78	21.28	0.1343
2	15	10	376000	1880	DFT-s-OFDM 16 QAM	1@1	22.41	20.91	0.1233
2	15	10	381000	1905	DFT-s-OFDM QPSK	1@1	22.81	21.31	0.1352
2	15	10	381000	1905	DFT-s-OFDM 16 QAM	1@1	22.5	21	0.1259
2	15	15	371500	1857.5	DFT-s-OFDM QPSK	1@1	23.26	21.76	0.1500
2	15	15	371500	1857.5	DFT-s-OFDM 16 QAM	1@1	22.78	21.28	0.1343
2	15	15	376000	1880	DFT-s-OFDM QPSK	1@1	22.84	21.34	0.1361
2	15	15	376000	1880	DFT-s-OFDM 16 QAM	1@1	22.56	21.06	0.1276
2	15	15	380500	1902.5	DFT-s-OFDM QPSK	1@1	22.78	21.28	0.1343
2	15	15	380500	1902.5	DFT-s-OFDM 16 QAM	1@1	22.39	20.89	0.1227
2	15	20	372000	1860	DFT-s-OFDM PI/2 BPSK	50@25	22.95	21.45	0.1396
2	15	20	372000	1860	DFT-s-OFDM PI/2 BPSK	1@1	23.15	21.65	0.1462
2	15	20	372000	1860	DFT-s-OFDM PI/2 BPSK	1@104	22.84	21.34	0.1361
2	15	20	372000	1860	DFT-s-OFDM QPSK	50@25	22.95	21.45	0.1396
2	15	20	372000	1860	DFT-s-OFDM QPSK	1@1	23.27	21.77	0.1503
2	15	20	372000	1860	DFT-s-OFDM QPSK	1@104	22.9	21.4	0.1380
2	15	20	372000	1860	DFT-s-OFDM 16 QAM	50@25	22.5	21	0.1259
2	15	20	372000	1860	DFT-s-OFDM 16 QAM	1@1	22.87	21.37	0.1371
2	15	20	372000	1860	DFT-s-OFDM 16 QAM	1@104	22.61	21.11	0.1291
2	15	20	372000	1860	DFT-s-OFDM 64 QAM	50@25	21.7	20.2	0.1047
2	15	20	372000	1860	DFT-s-OFDM 64 QAM	1@1	21.9	20.4	0.1096

2	15	20	372000	1860	DFT-s-OFDM 64 QAM	1@104	21.81	20.31	0.1074
2	15	20	372000	1860	DFT-s-OFDM 256 QAM	50@25	19.59	18.09	0.0644
2	15	20	372000	1860	DFT-s-OFDM 256 QAM	1@1	19.62	18.12	0.0649
2	15	20	372000	1860	DFT-s-OFDM 256 QAM	1@104	19.29	17.79	0.0601
2	15	20	372000	1860	CP-OFDM QPSK	53@26	22.68	21.18	0.1312
2	15	20	372000	1860	CP-OFDM QPSK	1@1	22.78	21.28	0.1343
2	15	20	372000	1860	CP-OFDM QPSK	1@104	22.3	20.8	0.1202
2	15	20	376000	1880	DFT-s-OFDM PI/2 BPSK	50@25	22.82	21.32	0.1355
2	15	20	376000	1880	DFT-s-OFDM PI/2 BPSK	1@1	22.73	21.23	0.1327
2	15	20	376000	1880	DFT-s-OFDM PI/2 BPSK	1@104	22.68	21.18	0.1312
2	15	20	376000	1880	DFT-s-OFDM QPSK	50@25	22.84	21.34	0.1361
2	15	20	376000	1880	DFT-s-OFDM QPSK	1@1	22.85	21.35	0.1365
2	15	20	376000	1880	DFT-s-OFDM QPSK	1@104	22.91	21.41	0.1384
2	15	20	376000	1880	DFT-s-OFDM 16 QAM	50@25	22.37	20.87	0.1222
2	15	20	376000	1880	DFT-s-OFDM 16 QAM	1@1	22.55	21.05	0.1274
2	15	20	376000	1880	DFT-s-OFDM 16 QAM	1@104	22.47	20.97	0.1250
2	15	20	376000	1880	DFT-s-OFDM 64 QAM	50@25	21.52	20.02	0.1005
2	15	20	376000	1880	DFT-s-OFDM 64 QAM	1@1	21.78	20.28	0.1067
2	15	20	376000	1880	DFT-s-OFDM 64 QAM	1@104	21.69	20.19	0.1045
2	15	20	376000	1880	DFT-s-OFDM 256 QAM	50@25	19.43	17.93	0.0621
2	15	20	376000	1880	DFT-s-OFDM 256 QAM	1@1	19.26	17.76	0.0597
2	15	20	376000	1880	DFT-s-OFDM 256 QAM	1@104	19.18	17.68	0.0586
2	15	20	376000	1880	CP-OFDM QPSK	53@26	22.56	21.06	0.1276
2	15	20	376000	1880	CP-OFDM QPSK	1@1	22.2	20.7	0.1175
2	15	20	376000	1880	CP-OFDM QPSK	1@104	22.22	20.72	0.1180
2	15	20	380000	1900	DFT-s-OFDM PI/2 BPSK	50@25	22.73	21.23	0.1327
2	15	20	380000	1900	DFT-s-OFDM PI/2 BPSK	1@1	22.67	21.17	0.1309
2	15	20	380000	1900	DFT-s-OFDM PI/2 BPSK	1@104	23	21.5	0.1413
2	15	20	380000	1900	DFT-s-OFDM QPSK	50@25	22.78	21.28	0.1343
2	15	20	380000	1900	DFT-s-OFDM QPSK	1@1	22.85	21.35	0.1365
2	15	20	380000	1900	DFT-s-OFDM QPSK	1@104	23.06	21.56	0.1432
2	15	20	380000	1900	DFT-s-OFDM 16 QAM	50@25	22.4	20.9	0.1230
2	15	20	380000	1900	DFT-s-OFDM 16 QAM	1@1	22.42	20.92	0.1236
2	15	20	380000	1900	DFT-s-OFDM 16 QAM	1@104	22.66	21.16	0.1306
2	15	20	380000	1900	DFT-s-OFDM 64 QAM	50@25	21.52	20.02	0.1005

2	15	20	380000	1900	DFT-s-OFDM 64 QAM	1@1	21.66	20.16	0.1038
2	15	20	380000	1900	DFT-s-OFDM 64 QAM	1@104	21.78	20.28	0.1067
2	15	20	380000	1900	DFT-s-OFDM 256 QAM	50@25	19.46	17.96	0.0625
2	15	20	380000	1900	DFT-s-OFDM 256 QAM	1@1	19.18	17.68	0.0586
2	15	20	380000	1900	DFT-s-OFDM 256 QAM	1@104	19.42	17.92	0.0619
2	15	20	380000	1900	CP-OFDM QPSK	53@26	22.49	20.99	0.1256
2	15	20	380000	1900	CP-OFDM QPSK	1@1	22.53	21.03	0.1268
2	15	20	380000	1900	CP-OFDM QPSK	1@104	22.33	20.83	0.1211

FR1 N5_ANT 0

Transmitter Conducted Output Power And ERP, (G_T - L_C)=-4dB

NR Band	SCS (kHz)	Bandwidth (MHz)	Arfcn	Freq (MHz)	Modulation	RB	Conducted Power(dBm)	ERP (dBm)	ERP (W)
5	15	5	165300	826.5	DFT-s-OFDM QPSK	1@1	22.55	16.4	0.0437
5	15	5	165300	826.5	DFT-s-OFDM 16 QAM	1@1	22.16	16.01	0.0399
5	15	5	167300	836.5	DFT-s-OFDM QPSK	1@1	23	16.85	0.0484
5	15	5	167300	836.5	DFT-s-OFDM 16 QAM	1@1	22.74	16.59	0.0456
5	15	5	169300	846.5	DFT-s-OFDM QPSK	1@1	23.34	17.19	0.0524
5	15	5	169300	846.5	DFT-s-OFDM 16 QAM	1@1	23	16.85	0.0484
5	15	10	165800	829	DFT-s-OFDM QPSK	1@1	22.4	16.25	0.0422
5	15	10	165800	829	DFT-s-OFDM 16 QAM	1@1	22.16	16.01	0.0399
5	15	10	167300	836.5	DFT-s-OFDM QPSK	1@1	22.84	16.69	0.0467
5	15	10	167300	836.5	DFT-s-OFDM 16 QAM	1@1	22.64	16.49	0.0446
5	15	10	168800	844	DFT-s-OFDM QPSK	1@1	23.06	16.91	0.0491
5	15	10	168800	844	DFT-s-OFDM 16 QAM	1@1	22.76	16.61	0.0458
5	15	15	166300	831.5	DFT-s-OFDM QPSK	1@1	22.69	16.54	0.0451
5	15	15	166300	831.5	DFT-s-OFDM 16 QAM	1@1	22.32	16.17	0.0414
5	15	15	167300	836.5	DFT-s-OFDM QPSK	1@1	22.9	16.75	0.0473
5	15	15	167300	836.5	DFT-s-OFDM 16 QAM	1@1	22.62	16.47	0.0444
5	15	15	168300	841.5	DFT-s-OFDM QPSK	1@1	23.24	17.09	0.0512
5	15	15	168300	841.5	DFT-s-OFDM 16 QAM	1@1	22.87	16.72	0.0470
5	15	20	166800	834	DFT-s-OFDM PI/2 BPSK	50@25	23.17	17.02	0.0504
5	15	20	166800	834	DFT-s-OFDM PI/2 BPSK	1@1	22.56	16.41	0.0438
5	15	20	166800	834	DFT-s-OFDM PI/2 BPSK	1@104	23.1	16.95	0.0495
5	15	20	166800	834	DFT-s-OFDM QPSK	50@25	23.14	16.99	0.0500
5	15	20	166800	834	DFT-s-OFDM QPSK	1@1	22.66	16.51	0.0448
5	15	20	166800	834	DFT-s-OFDM QPSK	1@104	23.21	17.06	0.0508
5	15	20	166800	834	DFT-s-OFDM 16 QAM	50@25	22.75	16.6	0.0457
5	15	20	166800	834	DFT-s-OFDM 16 QAM	1@1	22.35	16.2	0.0417
5	15	20	166800	834	DFT-s-OFDM 16 QAM	1@104	22.91	16.76	0.0474
5	15	20	166800	834	DFT-s-OFDM 64 QAM	50@25	22.38	16.23	0.0420
5	15	20	166800	834	DFT-s-OFDM 64 QAM	1@1	21.79	15.64	0.0366

5	15	20	166800	834	DFT-s-OFDM 64 QAM	1@104	22.57	16.42	0.0439
5	15	20	166800	834	DFT-s-OFDM 256 QAM	50@25	20.27	14.12	0.0258
5	15	20	166800	834	DFT-s-OFDM 256 QAM	1@1	19.64	13.49	0.0223
5	15	20	166800	834	DFT-s-OFDM 256 QAM	1@104	20.28	14.13	0.0259
5	15	20	166800	834	CP-OFDM QPSK	53@26	23.16	17.01	0.0502
5	15	20	166800	834	CP-OFDM QPSK	1@1	22.68	16.53	0.0450
5	15	20	166800	834	CP-OFDM QPSK	1@104	23.24	17.09	0.0512
5	15	20	167300	836.5	DFT-s-OFDM PI/2 BPSK	50@25	23.17	17.02	0.0504
5	15	20	167300	836.5	DFT-s-OFDM PI/2 BPSK	1@1	22.69	16.54	0.0451
5	15	20	167300	836.5	DFT-s-OFDM PI/2 BPSK	1@104	23.17	17.02	0.0504
5	15	20	167300	836.5	DFT-s-OFDM QPSK	50@25	23.17	17.02	0.0504
5	15	20	167300	836.5	DFT-s-OFDM QPSK	1@1	22.64	16.49	0.0446
5	15	20	167300	836.5	DFT-s-OFDM QPSK	1@104	23.42	17.27	0.0533
5	15	20	167300	836.5	DFT-s-OFDM 16 QAM	50@25	22.78	16.63	0.0460
5	15	20	167300	836.5	DFT-s-OFDM 16 QAM	1@1	22.43	16.28	0.0425
5	15	20	167300	836.5	DFT-s-OFDM 16 QAM	1@104	23.02	16.87	0.0486
5	15	20	167300	836.5	DFT-s-OFDM 64 QAM	50@25	22.46	16.31	0.0428
5	15	20	167300	836.5	DFT-s-OFDM 64 QAM	1@1	21.81	15.66	0.0368
5	15	20	167300	836.5	DFT-s-OFDM 64 QAM	1@104	22.66	16.51	0.0448
5	15	20	167300	836.5	DFT-s-OFDM 256 QAM	50@25	20.37	14.22	0.0264
5	15	20	167300	836.5	DFT-s-OFDM 256 QAM	1@1	19.71	13.56	0.0227
5	15	20	167300	836.5	DFT-s-OFDM 256 QAM	1@104	20.32	14.17	0.0261
5	15	20	167300	836.5	CP-OFDM QPSK	53@26	23.21	17.06	0.0508
5	15	20	167300	836.5	CP-OFDM QPSK	1@1	22.75	16.6	0.0457
5	15	20	167300	836.5	CP-OFDM QPSK	1@104	22.87	16.72	0.0470
5	15	20	167800	839	DFT-s-OFDM PI/2 BPSK	50@25	23.21	17.06	0.0508
5	15	20	167800	839	DFT-s-OFDM PI/2 BPSK	1@1	22.88	16.73	0.0471
5	15	20	167800	839	DFT-s-OFDM PI/2 BPSK	1@104	23.13	16.98	0.0499
5	15	20	167800	839	DFT-s-OFDM QPSK	50@25	23.25	17.1	0.0513
5	15	20	167800	839	DFT-s-OFDM QPSK	1@1	22.96	16.81	0.0480
5	15	20	167800	839	DFT-s-OFDM QPSK	1@104	23.26	17.11	0.0514
5	15	20	167800	839	DFT-s-OFDM 16 QAM	50@25	22.76	16.61	0.0458
5	15	20	167800	839	DFT-s-OFDM 16 QAM	1@1	22.66	16.51	0.0448
5	15	20	167800	839	DFT-s-OFDM 16 QAM	1@104	22.9	16.75	0.0473
5	15	20	167800	839	DFT-s-OFDM 64 QAM	50@25	22.5	16.35	0.0432

5	15	20	167800	839	DFT-s-OFDM 64 QAM	1@1	22.22	16.07	0.0405
5	15	20	167800	839	DFT-s-OFDM 64 QAM	1@104	22.54	16.39	0.0436
5	15	20	167800	839	DFT-s-OFDM 256 QAM	50@25	20.39	14.24	0.0265
5	15	20	167800	839	DFT-s-OFDM 256 QAM	1@1	19.88	13.73	0.0236
5	15	20	167800	839	DFT-s-OFDM 256 QAM	1@104	20.27	14.12	0.0258
5	15	20	167800	839	CP-OFDM QPSK	53@26	23.23	17.08	0.0511
5	15	20	167800	839	CP-OFDM QPSK	1@1	22.91	16.76	0.0474
5	15	20	167800	839	CP-OFDM QPSK	1@104	23.16	17.01	0.0502

FR1 N12_ANT 0

Transmitter Conducted Output Power And ERP, (G_T - L_C)=-4.2dB

NR Band	SCS (kHz)	Bandwidth (MHz)	Arfcn	Freq (MHz)	Modulation	RB	Conducted Power(dBm)	ERP (dBm)	ERP (W)
12	15	5	140300	701.5	DFT-s-OFDM QPSK	1@1	23.8	17.45	0.0556
12	15	5	140300	701.5	DFT-s-OFDM 16 QAM	1@1	23.41	17.06	0.0508
12	15	5	141500	707.5	DFT-s-OFDM QPSK	1@1	23.6	17.25	0.0531
12	15	5	141500	707.5	DFT-s-OFDM 16 QAM	1@1	23.31	16.96	0.0497
12	15	5	142700	713.5	DFT-s-OFDM QPSK	1@1	23.3	16.95	0.0495
12	15	5	142700	713.5	DFT-s-OFDM 16 QAM	1@1	22.91	16.56	0.0453
12	15	10	140800	704	DFT-s-OFDM QPSK	1@1	23.78	17.43	0.0553
12	15	10	140800	704	DFT-s-OFDM 16 QAM	1@1	23.47	17.12	0.0515
12	15	10	141500	707.5	DFT-s-OFDM QPSK	1@1	23.75	17.4	0.0550
12	15	10	141500	707.5	DFT-s-OFDM 16 QAM	1@1	23.42	17.07	0.0509
12	15	10	142200	711	DFT-s-OFDM QPSK	1@1	23.56	17.21	0.0526
12	15	10	142200	711	DFT-s-OFDM 16 QAM	1@1	23.24	16.89	0.0489
12	15	15	141300	706.5	DFT-s-OFDM PI/2 BPSK	36@18	23.63	17.28	0.0535
12	15	15	141300	706.5	DFT-s-OFDM PI/2 BPSK	1@1	23.8	17.45	0.0556
12	15	15	141300	706.5	DFT-s-OFDM PI/2 BPSK	1@77	23.08	16.73	0.0471
12	15	15	141300	706.5	DFT-s-OFDM QPSK	36@18	23.73	17.38	0.0547
12	15	15	141300	706.5	DFT-s-OFDM QPSK	1@1	23.97	17.62	0.0578
12	15	15	141300	706.5	DFT-s-OFDM QPSK	1@77	23.19	16.84	0.0483
12	15	15	141300	706.5	DFT-s-OFDM 16 QAM	36@18	23.29	16.94	0.0494
12	15	15	141300	706.5	DFT-s-OFDM 16 QAM	1@1	23.52	17.17	0.0521
12	15	15	141300	706.5	DFT-s-OFDM 16 QAM	1@77	22.91	16.56	0.0453
12	15	15	141300	706.5	DFT-s-OFDM 64 QAM	36@18	22.74	16.39	0.0436
12	15	15	141300	706.5	DFT-s-OFDM 64 QAM	1@1	22.97	16.62	0.0459
12	15	15	141300	706.5	DFT-s-OFDM 64 QAM	1@77	22.31	15.96	0.0394
12	15	15	141300	706.5	DFT-s-OFDM 256 QAM	36@18	20.67	14.32	0.0270
12	15	15	141300	706.5	DFT-s-OFDM 256 QAM	1@1	20.64	14.29	0.0269
12	15	15	141300	706.5	DFT-s-OFDM 256 QAM	1@77	19.91	13.56	0.0227
12	15	15	141300	706.5	CP-OFDM QPSK	39@19	23.69	17.34	0.0542
12	15	15	141300	706.5	CP-OFDM QPSK	1@1	23.88	17.53	0.0566

12	15	15	141300	706.5	CP-OFDM QPSK	1@77	23.21	16.86	0.0485
12	15	15	141500	707.5	DFT-s-OFDM PI/2 BPSK	36@18	23.69	17.34	0.0542
12	15	15	141500	707.5	DFT-s-OFDM PI/2 BPSK	1@1	23.84	17.49	0.0561
12	15	15	141500	707.5	DFT-s-OFDM PI/2 BPSK	1@77	22.98	16.63	0.0460
12	15	15	141500	707.5	DFT-s-OFDM QPSK	36@18	23.72	17.37	0.0546
12	15	15	141500	707.5	DFT-s-OFDM QPSK	1@1	23.91	17.56	0.0570
12	15	15	141500	707.5	DFT-s-OFDM QPSK	1@77	23	16.65	0.0462
12	15	15	141500	707.5	DFT-s-OFDM 16 QAM	36@18	23.37	17.02	0.0504
12	15	15	141500	707.5	DFT-s-OFDM 16 QAM	1@1	23.56	17.21	0.0526
12	15	15	141500	707.5	DFT-s-OFDM 16 QAM	1@77	22.8	16.45	0.0442
12	15	15	141500	707.5	DFT-s-OFDM 64 QAM	36@18	22.79	16.44	0.0441
12	15	15	141500	707.5	DFT-s-OFDM 64 QAM	1@1	23	16.65	0.0462
12	15	15	141500	707.5	DFT-s-OFDM 64 QAM	1@77	22.22	15.87	0.0386
12	15	15	141500	707.5	DFT-s-OFDM 256 QAM	36@18	20.65	14.3	0.0269
12	15	15	141500	707.5	DFT-s-OFDM 256 QAM	1@1	20.67	14.32	0.0270
12	15	15	141500	707.5	DFT-s-OFDM 256 QAM	1@77	19.79	13.44	0.0221
12	15	15	141500	707.5	CP-OFDM QPSK	39@19	23.73	17.38	0.0547
12	15	15	141500	707.5	CP-OFDM QPSK	1@1	23.85	17.5	0.0562
12	15	15	141500	707.5	CP-OFDM QPSK	1@77	23.06	16.71	0.0469
12	15	15	141700	708.5	DFT-s-OFDM PI/2 BPSK	36@18	23.6	17.25	0.0531
12	15	15	141700	708.5	DFT-s-OFDM PI/2 BPSK	1@1	23.79	17.44	0.0555
12	15	15	141700	708.5	DFT-s-OFDM PI/2 BPSK	1@77	22.92	16.57	0.0454
12	15	15	141700	708.5	DFT-s-OFDM QPSK	36@18	23.67	17.32	0.0540
12	15	15	141700	708.5	DFT-s-OFDM QPSK	1@1	23.89	17.54	0.0568
12	15	15	141700	708.5	DFT-s-OFDM QPSK	1@77	23.02	16.67	0.0465
12	15	15	141700	708.5	DFT-s-OFDM 16 QAM	36@18	23.24	16.89	0.0489
12	15	15	141700	708.5	DFT-s-OFDM 16 QAM	1@1	23.47	17.12	0.0515
12	15	15	141700	708.5	DFT-s-OFDM 16 QAM	1@77	22.69	16.34	0.0431
12	15	15	141700	708.5	DFT-s-OFDM 64 QAM	36@18	22.63	16.28	0.0425
12	15	15	141700	708.5	DFT-s-OFDM 64 QAM	1@1	22.91	16.56	0.0453
12	15	15	141700	708.5	DFT-s-OFDM 64 QAM	1@77	22.07	15.72	0.0373
12	15	15	141700	708.5	DFT-s-OFDM 256 QAM	36@18	20.56	14.21	0.0264
12	15	15	141700	708.5	DFT-s-OFDM 256 QAM	1@1	20.66	14.31	0.0270
12	15	15	141700	708.5	DFT-s-OFDM 256 QAM	1@77	19.7	13.35	0.0216
12	15	15	141700	708.5	CP-OFDM QPSK	39@19	23.6	17.25	0.0531

12	15	15	141700	708.5	CP-OFDM QPSK	1@1	23.91	17.56	0.0570
12	15	15	141700	708.5	CP-OFDM QPSK	1@77	22.93	16.58	0.0455

Frequency Stability

NR Band	SCS (kHz)	Bandwidth (MHz)	Arfcn	Freq (MHz)	Modulation	RB	Deviation (ppm)	Verdict	Environment
12	15	10	141500	707.5	DFT-s-OFDM QPSK	50@0	0.0023	PASS	NV
12	15	10	141500	707.5	DFT-s-OFDM QPSK	50@0	0.0045	PASS	LV
12	15	10	141500	707.5	DFT-s-OFDM QPSK	50@0	0.0040	PASS	HV
12	15	10	141500	707.5	DFT-s-OFDM QPSK	50@0	0.0063	PASS	-30°C
12	15	10	141500	707.5	DFT-s-OFDM QPSK	50@0	0.0025	PASS	-20°C
12	15	10	141500	707.5	DFT-s-OFDM QPSK	50@0	0.0030	PASS	-10°C
12	15	10	141500	707.5	DFT-s-OFDM QPSK	50@0	0.0040	PASS	0°C
12	15	10	141500	707.5	DFT-s-OFDM QPSK	50@0	0.0034	PASS	10°C
12	15	10	141500	707.5	DFT-s-OFDM QPSK	50@0	0.0023	PASS	20°C
12	15	10	141500	707.5	DFT-s-OFDM QPSK	50@0	0.0025	PASS	30°C
12	15	10	141500	707.5	DFT-s-OFDM QPSK	50@0	0.0066	PASS	40°C
12	15	10	141500	707.5	DFT-s-OFDM QPSK	50@0	0.0051	PASS	50°C

Peak to Average Ratio

NR Band	SCS (kHz)	Bandwidth (MHz)	Arfcn	Freq (MHz)	Modulation	RB	Result (dB)	Limit (dB)	Verdict
12	15	10	141500	707.5	DFT-s-OFDM PI/2 BPSK	50@0	3.78	13	PASS
12	15	10	141500	707.5	DFT-s-OFDM QPSK	50@0	5.21	13	PASS

N12(10M)_DFT-s-OFDM_PI_2-BPSK_Outer_Full_Mid_CH

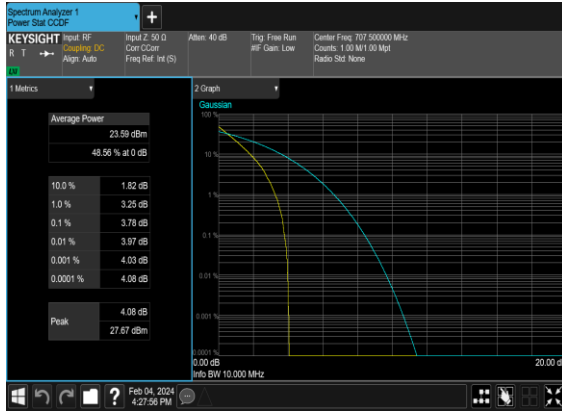

N12(10M)_DFT-s-OFDM_QPSK_Outer_Full_Mid_CH

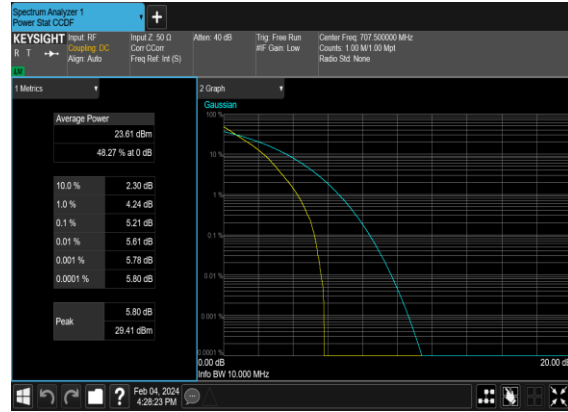

Occupied Bandwidth

NR Band	SCS (kHz)	Bandwidth (MHz)	Arfcn	Freq (MHz)	Modulation	RB	OBW (MHz)	26dB BW (MHz)
12	15	5	141500	707.5	CP-OFDM QPSK	25@0	4.4723	5.07
12	15	5	141500	707.5	CP-OFDM 16 QAM	25@0	4.4806	5.153
12	15	5	141500	707.5	CP-OFDM 64 QAM	25@0	4.4662	4.952
12	15	5	141500	707.5	CP-OFDM 256 QAM	25@0	4.4759	5.003
12	15	10	141500	707.5	CP-OFDM QPSK	52@0	9.2693	10.11
12	15	10	141500	707.5	CP-OFDM 16 QAM	52@0	9.2821	9.988
12	15	10	141500	707.5	CP-OFDM 64 QAM	52@0	9.2751	9.842
12	15	10	141500	707.5	CP-OFDM 256 QAM	52@0	9.2756	9.917
12	15	15	141500	707.5	CP-OFDM QPSK	79@0	14.067	14.94
12	15	15	141500	707.5	CP-OFDM 16 QAM	79@0	14.084	15.02
12	15	15	141500	707.5	CP-OFDM 64 QAM	79@0	14.094	14.83
12	15	15	141500	707.5	CP-OFDM 256 QAM	79@0	14.041	14.96

N12(5M)_CP-OFDM_QPSK_Outer_Full_Mid_CH

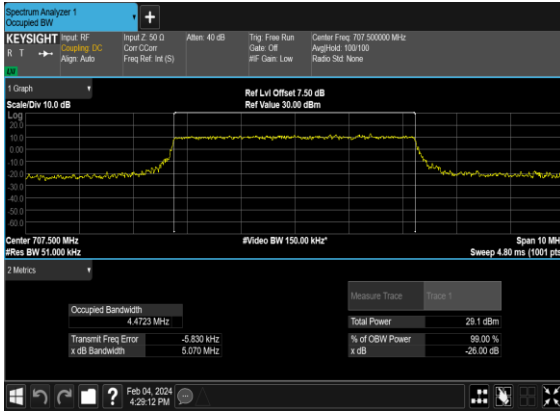

N12(5M)_CP-OFDM_16QAM_Outer_Full_Mid_CH

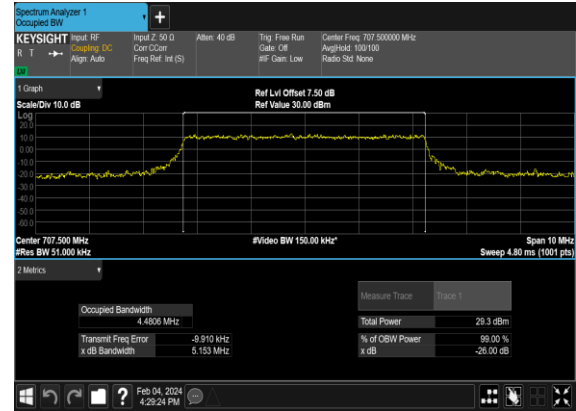

N12(5M)_CP-OFDM_64QAM_Outer_Full_Mid_CH

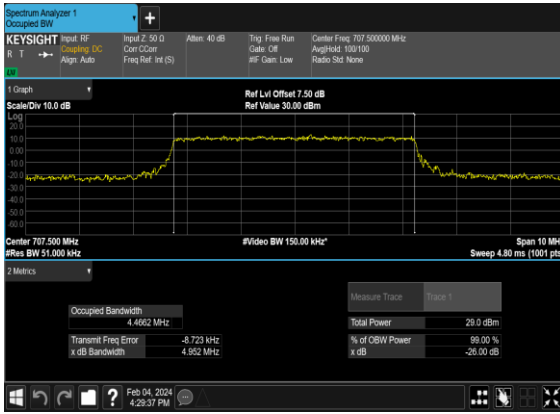

N12(5M)_CP-OFDM_256QAM_Outer_Full_Mid_CH

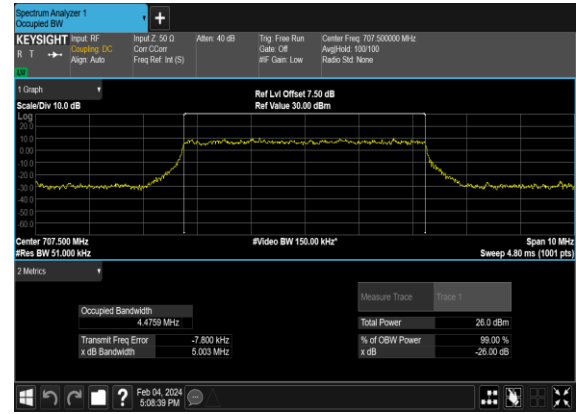

N12(10M)_CP-OFDM_QPSK_Outer_Full_Mid_CH

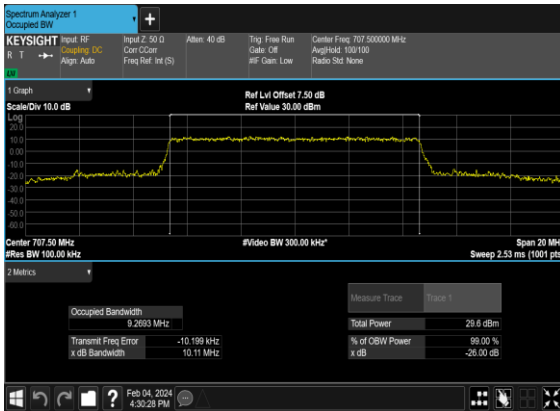

N12(10M)_CP-OFDM_16QAM_Outer_Full_Mid_CH

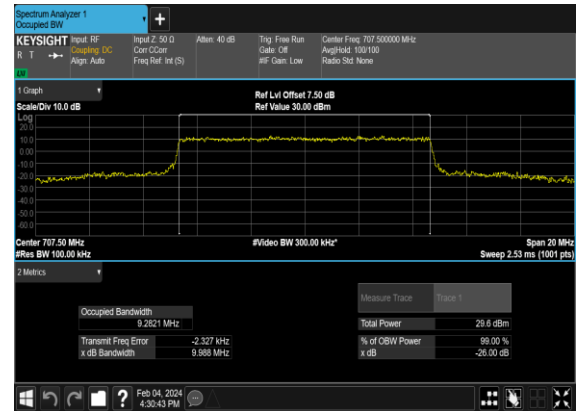

N12(10M)_CP-OFDM_64 QAM_Outer_Full_Mid_CH

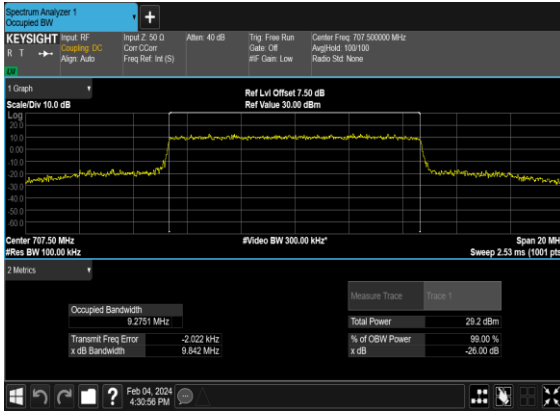

N12(10M)_CP-OFDM_256 QAM_Outer_Full_Mid_CH

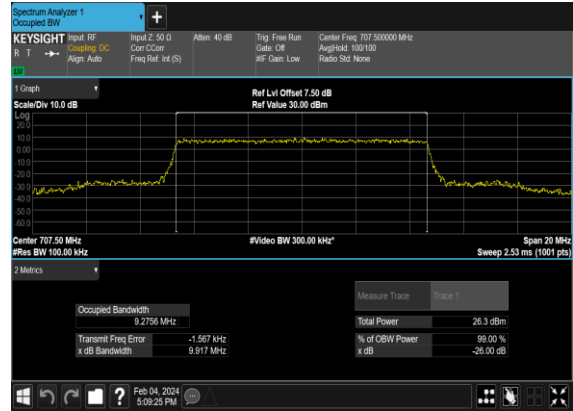

N12(15M)_CP- OFDM_QPSK_Outer_Full_Mid_CH

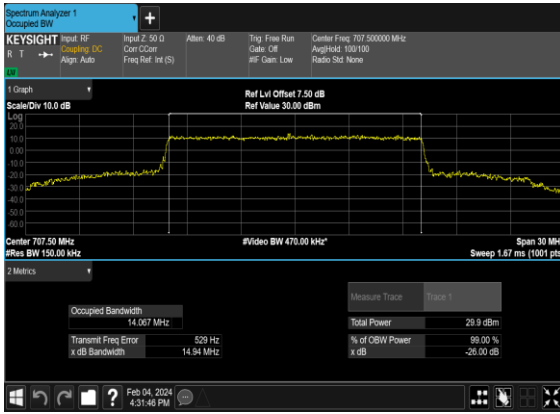

N12(15M)_CP-OFDM_16 QAM_Outer_Full_Mid_CH

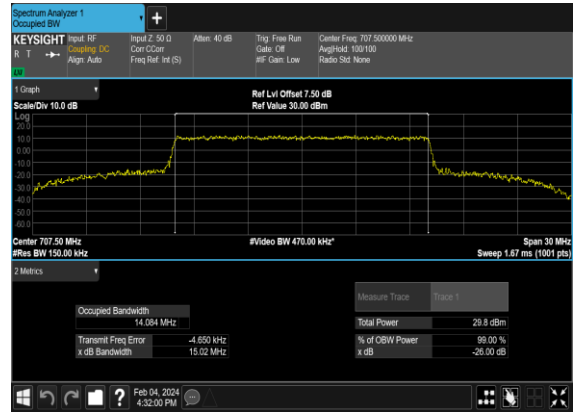

N12(15M)_CP-OFDM_64 QAM_Outer_Full_Mid_CH

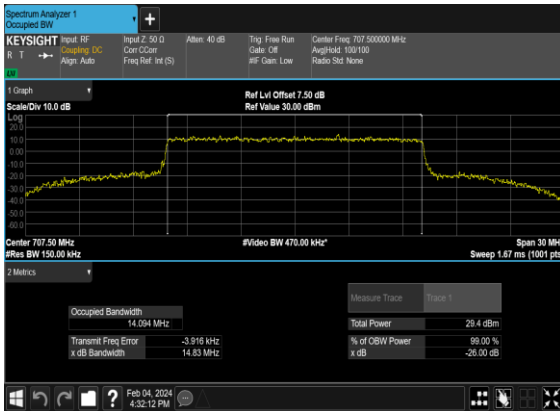

N12(15M)_CP-OFDM_256 QAM_Outer_Full_Mid_CH

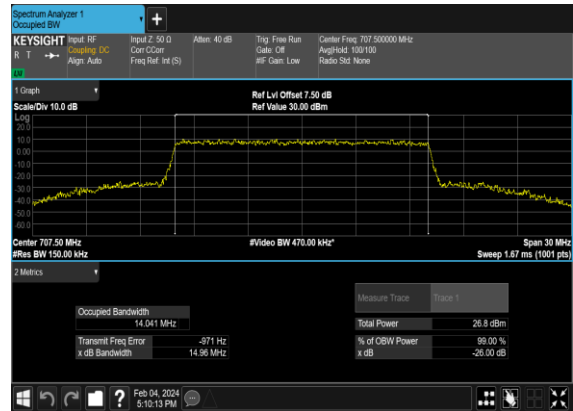

Conducted Spurious Emissions

NR Band	SCS (kHz)	Bandwidth (MHz)	Arfcn	Freq (MHz)	Modulation	RB	Result	Verdict
12	15	5	140300	701.5	DFT-s-OFDM BPSK	1@0	see graph	---
12	15	5	140300	701.5	DFT-s-OFDM BPSK	1@0	see graph	PASS
12	15	5	140300	701.5	DFT-s-OFDM QPSK	1@0	see graph	---
12	15	5	140300	701.5	DFT-s-OFDM QPSK	1@0	see graph	PASS
12	15	5	141500	707.5	DFT-s-OFDM BPSK	1@0	see graph	---
12	15	5	141500	707.5	DFT-s-OFDM BPSK	1@0	see graph	PASS
12	15	5	141500	707.5	DFT-s-OFDM QPSK	1@0	see graph	---
12	15	5	141500	707.5	DFT-s-OFDM QPSK	1@0	see graph	PASS
12	15	5	142700	713.5	DFT-s-OFDM BPSK	1@0	see graph	---
12	15	5	142700	713.5	DFT-s-OFDM BPSK	1@0	see graph	PASS
12	15	5	142700	713.5	DFT-s-OFDM QPSK	1@0	see graph	---
12	15	5	142700	713.5	DFT-s-OFDM QPSK	1@0	see graph	PASS
12	15	10	140800	704.0	DFT-s-OFDM BPSK	1@0	see graph	---
12	15	10	140800	704.0	DFT-s-OFDM BPSK	1@0	see graph	PASS
12	15	10	140800	704.0	DFT-s-OFDM QPSK	1@0	see graph	---
12	15	10	140800	704.0	DFT-s-OFDM QPSK	1@0	see graph	PASS
12	15	10	141500	707.5	DFT-s-OFDM BPSK	1@0	see graph	---
12	15	10	141500	707.5	DFT-s-OFDM BPSK	1@0	see graph	PASS
12	15	10	141500	707.5	DFT-s-OFDM QPSK	1@0	see graph	---
12	15	10	141500	707.5	DFT-s-OFDM QPSK	1@0	see graph	PASS
12	15	10	142200	711.0	DFT-s-OFDM BPSK	1@0	see graph	---
12	15	10	142200	711.0	DFT-s-OFDM BPSK	1@0	see graph	PASS

12	15	10	142200	711.0	DFT-s-OFDM QPSK	1@0	see graph	---
12	15	10	142200	711.0	DFT-s-OFDM QPSK	1@0	see graph	PASS
12	15	15	141300	706.5	DFT-s-OFDM BPSK	1@0	see graph	---
12	15	15	141300	706.5	DFT-s-OFDM BPSK	1@0	see graph	PASS
12	15	15	141300	706.5	DFT-s-OFDM QPSK	1@0	see graph	---
12	15	15	141300	706.5	DFT-s-OFDM QPSK	1@0	see graph	PASS
12	15	15	141500	707.5	DFT-s-OFDM BPSK	1@0	see graph	---
12	15	15	141500	707.5	DFT-s-OFDM BPSK	1@0	see graph	PASS
12	15	15	141500	707.5	DFT-s-OFDM QPSK	1@0	see graph	---
12	15	15	141500	707.5	DFT-s-OFDM QPSK	1@0	see graph	PASS
12	15	15	141700	708.5	DFT-s-OFDM BPSK	1@0	see graph	---
12	15	15	141700	708.5	DFT-s-OFDM BPSK	1@0	see graph	PASS
12	15	15	141700	708.5	DFT-s-OFDM QPSK	1@0	see graph	---
12	15	15	141700	708.5	DFT-s-OFDM QPSK	1@0	see graph	PASS

N12(5M)_DFT-s-OFDM_BPSK_Edge_1RB_Left_Low_CH

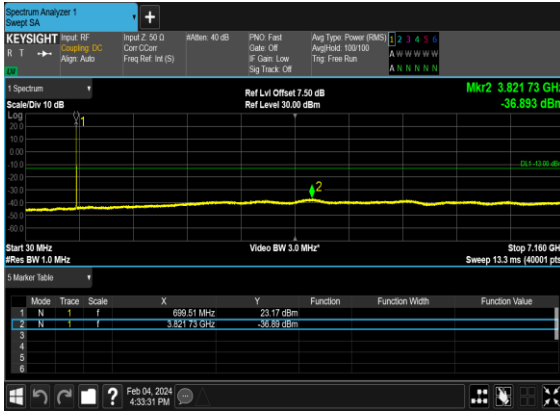

N12(5M)_DFT-s-OFDM_QPSK_Edge_1RB_Left_Low_CH

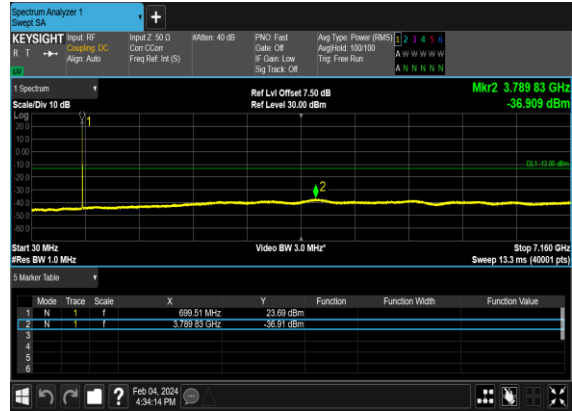

N12(5M)_DFT-s-OFDM_BPSK_Edge_1RB_Left_Mid_CH

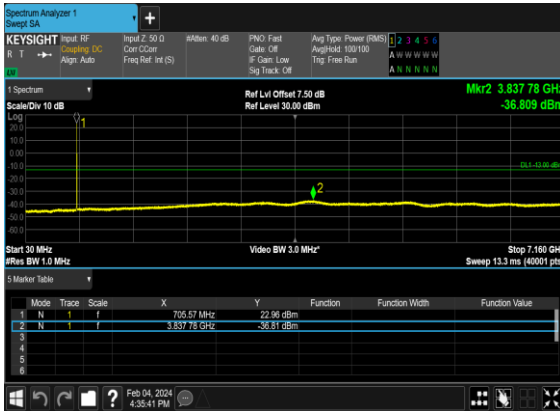

N12(5M)_DFT-s-OFDM_QPSK_Edge_1RB_Left_Mid_CH



N12(5M)_DFT-s-OFDM_BPSK_Edge_1RB_Left_High_CH



N12(5M)_DFT-s-OFDM_QPSK_Edge_1RB_Left_High_CH

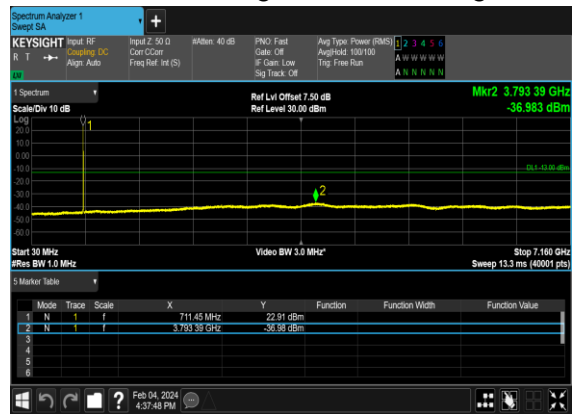

N12(10M)_DFT-s-OFDM_BPSK_Edge_1RB_Left_Low_CH



N12(10M)_DFT-s-OFDM_QPSK_Edge_1RB_Left_Low_CH



N12(10M)_DFT-s-OFDM_BPSK_Edge_1RB_Left_Mid_CH



N12(10M)_DFT-s-OFDM_QPSK_Edge_1RB_Left_Mid_CH



N12(10M)_DFT-s-OFDM_BPSK_Edge_1RB_Left_High_CH

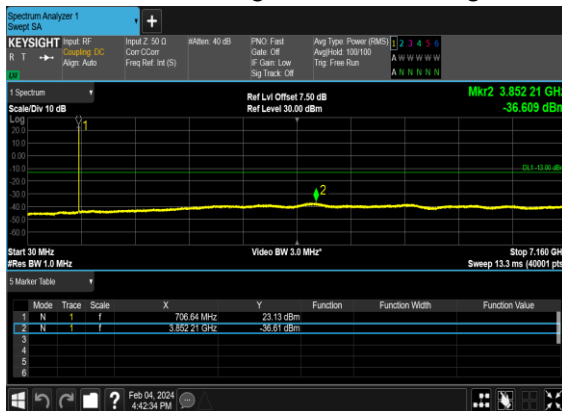

N12(10M)_DFT-s-OFDM_QPSK_Edge_1RB_Left_High_CH

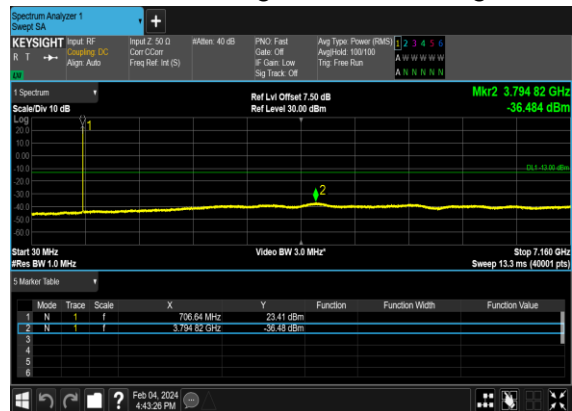

N12(15M)_DFT-s-OFDM_BPSK_Edge_1RB_Left_Low_CH



N12(15M)_DFT-s-OFDM_QPSK_Edge_1RB_Left_Low_CH

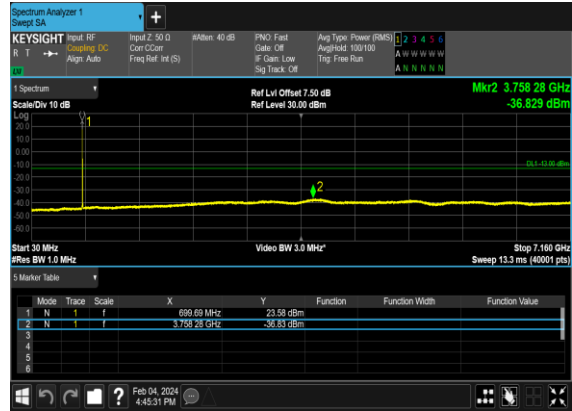

N12(15M)_DFT-s-OFDM_BPSK_Edge_1RB_Left_Mid_CH

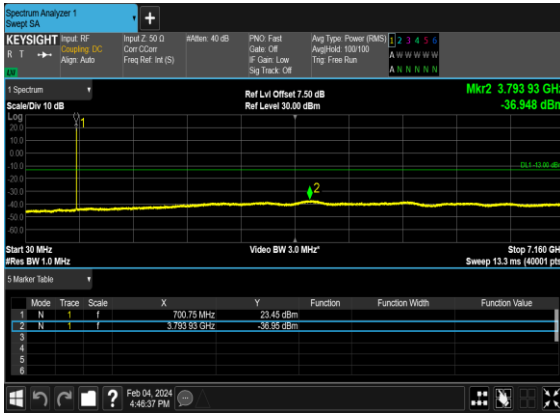

N12(15M)_DFT-s-OFDM_QPSK_Edge_1RB_Left_Mid_CH



N12(15M)_DFT-s-OFDM_BPSK_Edge_1RB_Left_High_CH

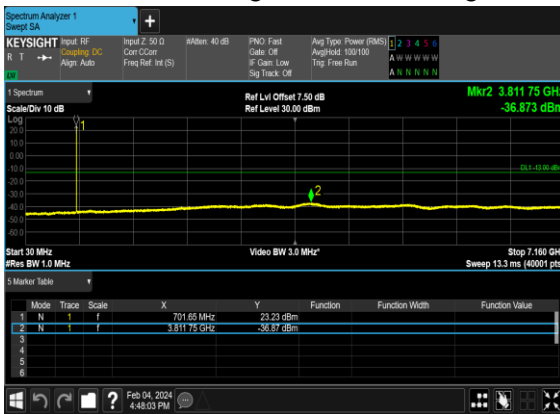

N12(15M)_DFT-s-OFDM_QPSK_Edge_1RB_Left_High_CH

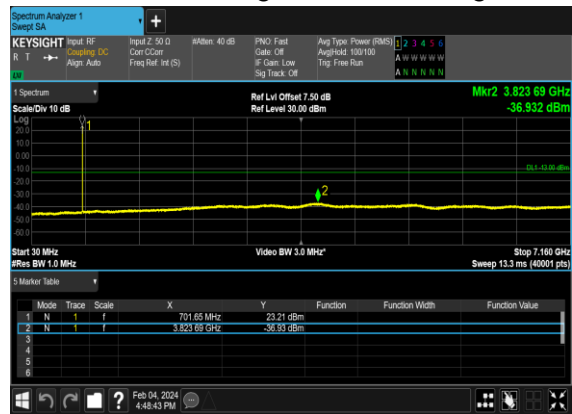

Conducted Band Edge

NR Band	SCS (kHz)	Bandwidth (MHz)	Arfcn	Freq (MHz)	Modulation	RB	Result	Verdict
12	15	5	140300	701.5	DFT-s-OFDM BPSK	1@0	see graph	PASS
12	15	5	140300	701.5	DFT-s-OFDM QPSK	1@0	see graph	PASS
12	15	5	140300	701.5	DFT-s-OFDM BPSK	25@0	see graph	PASS
12	15	5	140300	701.5	DFT-s-OFDM QPSK	25@0	see graph	PASS
12	15	5	142700	713.5	DFT-s-OFDM BPSK	1@24	see graph	PASS
12	15	5	142700	713.5	DFT-s-OFDM QPSK	1@24	see graph	PASS
12	15	5	142700	713.5	DFT-s-OFDM BPSK	25@0	see graph	PASS
12	15	5	142700	713.5	DFT-s-OFDM QPSK	25@0	see graph	PASS
12	15	10	140800	704.0	DFT-s-OFDM BPSK	1@0	see graph	PASS
12	15	10	140800	704.0	DFT-s-OFDM QPSK	1@0	see graph	PASS
12	15	10	140800	704.0	DFT-s-OFDM BPSK	50@0	see graph	PASS
12	15	10	140800	704.0	DFT-s-OFDM QPSK	50@0	see graph	PASS
12	15	10	142200	711.0	DFT-s-OFDM BPSK	1@51	see graph	PASS
12	15	10	142200	711.0	DFT-s-OFDM QPSK	1@51	see graph	PASS
12	15	10	142200	711.0	DFT-s-OFDM BPSK	50@0	see graph	PASS
12	15	10	142200	711.0	DFT-s-OFDM QPSK	50@0	see graph	PASS
12	15	15	141300	706.5	DFT-s-OFDM BPSK	1@0	see graph	PASS
12	15	15	141300	706.5	DFT-s-OFDM QPSK	1@0	see graph	PASS
12	15	15	141300	706.5	DFT-s-OFDM BPSK	75@0	see graph	PASS
12	15	15	141300	706.5	DFT-s-OFDM QPSK	75@0	see graph	PASS
12	15	15	141700	708.5	DFT-s-OFDM BPSK	1@78	see graph	PASS
12	15	15	141700	708.5	DFT-s-OFDM QPSK	1@78	see graph	PASS
12	15	15	141700	708.5	DFT-s-OFDM BPSK	75@0	see graph	PASS
12	15	15	141700	708.5	DFT-s-OFDM QPSK	75@0	see graph	PASS

N12(5M)_DFT-s-
OFDM_BPSK_Edge_1RB_Left_Low_CH

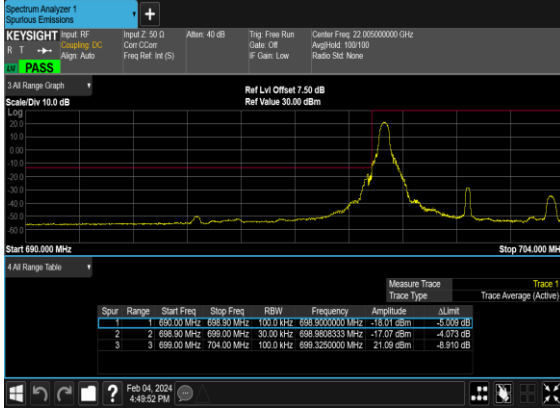

N12(5M)_DFT-s-
OFDM_QPSK_Edge_1RB_Left_Low_CH

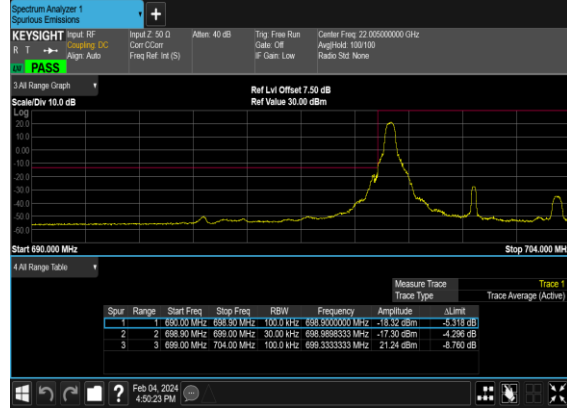

N12(5M)_DFT-s-
OFDM_BPSK_Outer_Full_Low_CH



N12(5M)_DFT-s-
OFDM_QPSK_Outer_Full_Low_CH

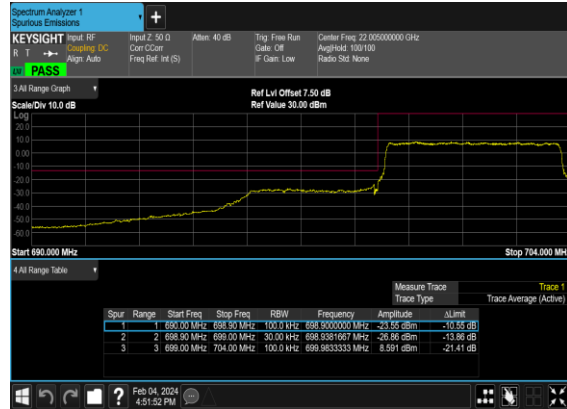

N12(5M)_DFT-s-
OFDM_BPSK_Edge_1RB_Right_High_CH

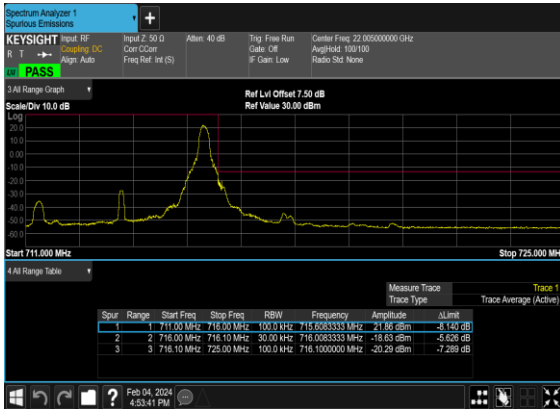

N12(5M)_DFT-s-
OFDM_QPSK_Edge_1RB_Right_High_CH

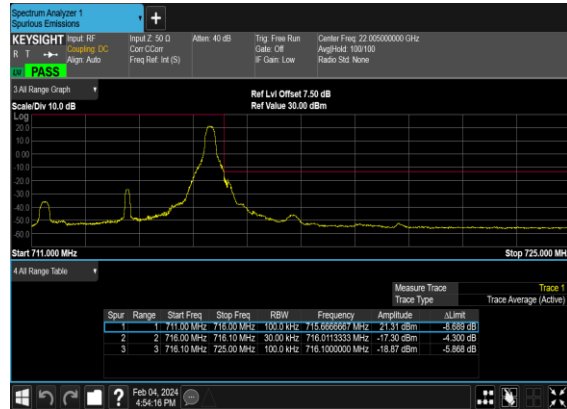

N12(5M)_DFT-s-OFDM_BPSK_Outer_Full_High_CH

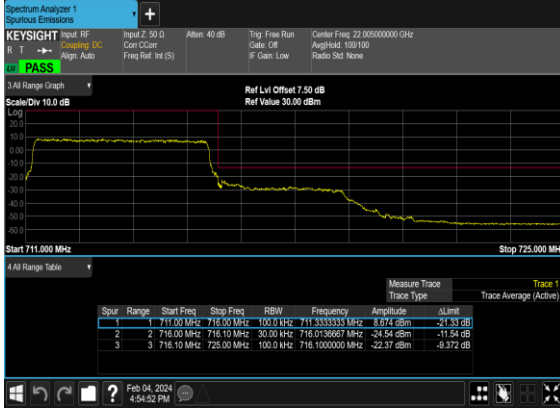

N12(5M)_DFT-s-OFDM_QPSK_Outer_Full_High_CH



N12(10M)_DFT-s-OFDM_BPSK_Edge_1RB_Left_Low_CH

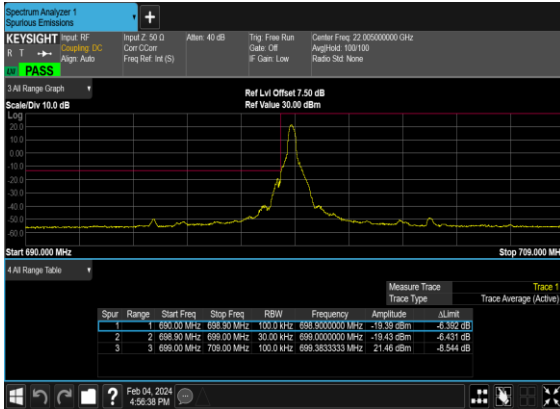

N12(10M)_DFT-s-OFDM_QPSK_Edge_1RB_Left_Low_CH

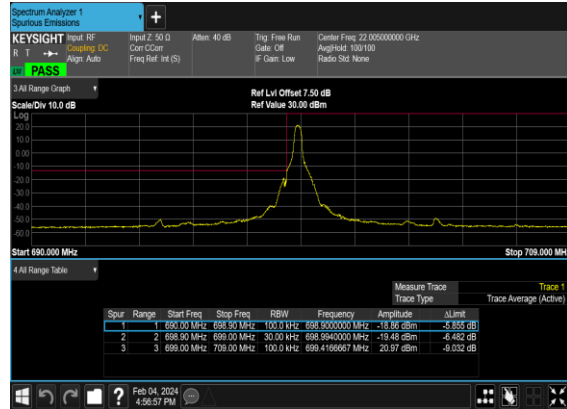

N12(10M)_DFT-s-OFDM_BPSK_Outer_Full_Low_CH

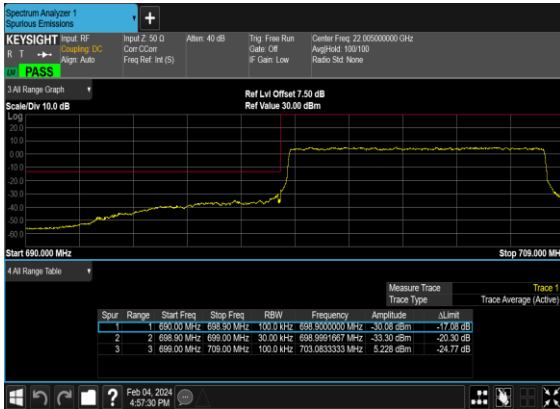

N12(10M)_DFT-s-OFDM_QPSK_Outer_Full_Low_CH

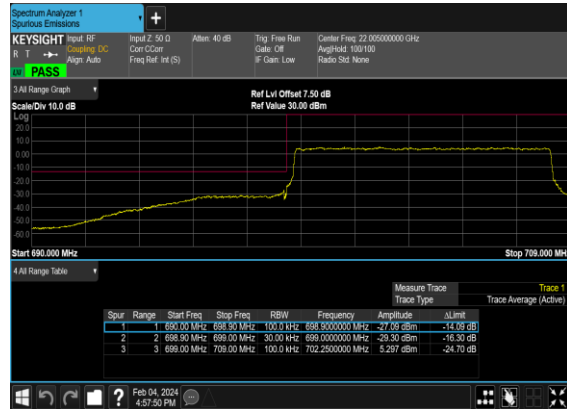

N12(10M)_DFT-s-
OFDM_BPSK_Edge_1RB_Right_High_CH

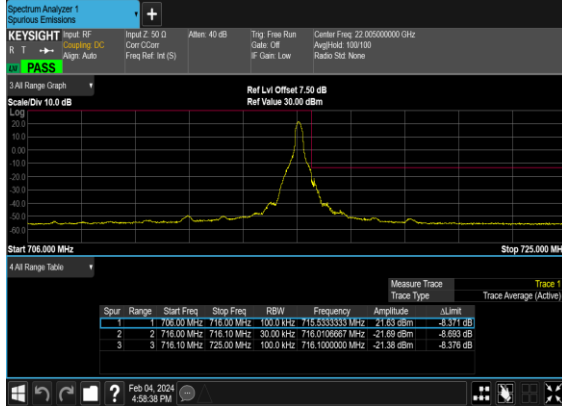

N12(10M)_DFT-s-
OFDM_QPSK_Edge_1RB_Right_High_CH

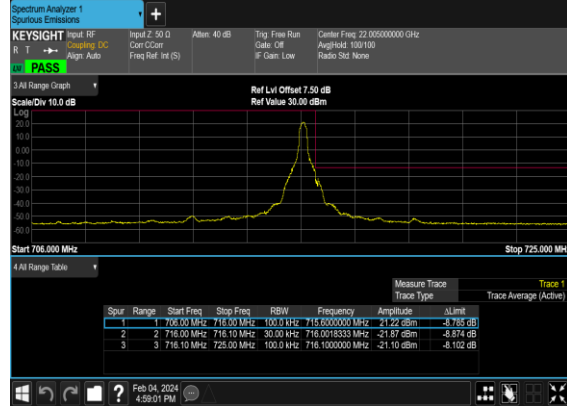

N12(10M)_DFT-s-
OFDM_BPSK_Outer_Full_High_CH



N12(10M)_DFT-s-
OFDM_QPSK_Outer_Full_High_CH



N12(15M)_DFT-s-
OFDM_BPSK_Edge_1RB_Left_Low_CH

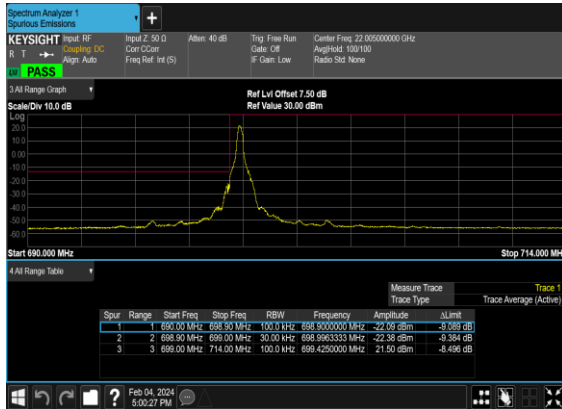

N12(15M)_DFT-s-
OFDM_QPSK_Edge_1RB_Left_Low_CH

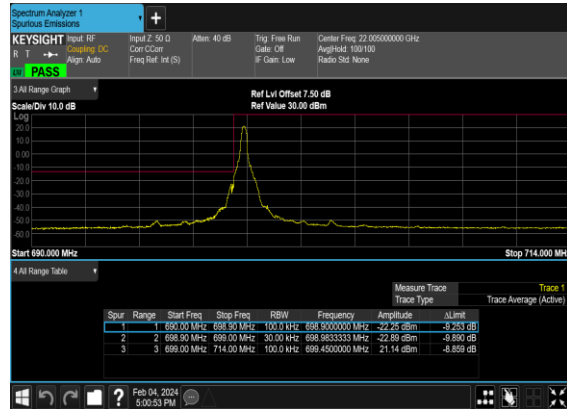

N12(15M)_DFT-s-OFDM_BPSK_Outer_Full_Low_CH



N12(15M)_DFT-s-OFDM_QPSK_Outer_Full_Low_CH



N12(15M)_DFT-s-OFDM_BPSK_Edge_1RB_Right_High_CH

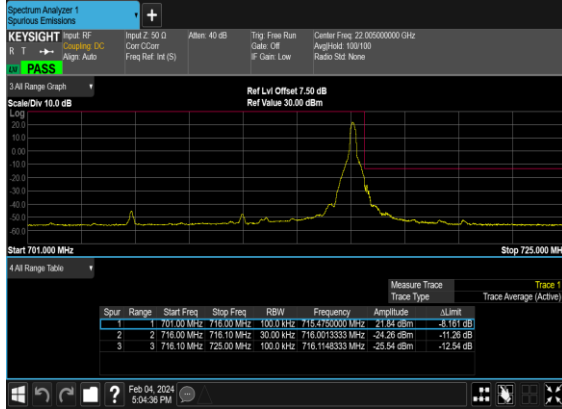

N12(15M)_DFT-s-OFDM_QPSK_Edge_1RB_Right_High_CH

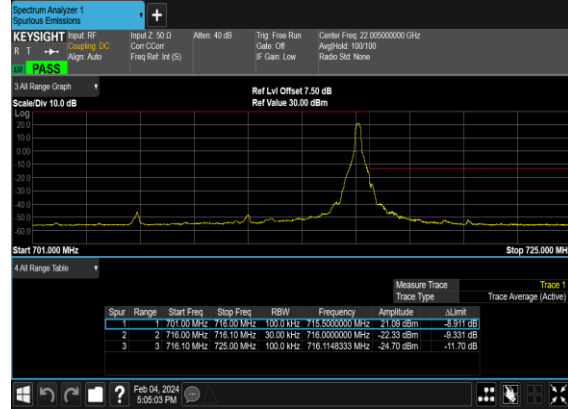

N12(15M)_DFT-s-OFDM_BPSK_Outer_Full_High_CH



N12(15M)_DFT-s-OFDM_QPSK_Outer_Full_High_CH



FR1 N25_ANT 0 (Main PA)

Transmitter Conducted Output Power And EIRP, (G_T - L_C)=-1.5dB

NR Band	SCS (kHz)	Bandwidth (MHz)	Arfcn	Freq (MHz)	Modulation	RB	Conducted Power(dBm)	EIRP (dBm)	EIRP (W)
25	15	5	370500	1852.5	DFT-s-OFDM QPSK	1@1	23.23	21.73	0.1489
25	15	5	370500	1852.5	DFT-s-OFDM 16 QAM	1@1	22.85	21.35	0.1365
25	15	5	376500	1882.5	DFT-s-OFDM QPSK	1@1	23.13	21.63	0.1455
25	15	5	376500	1882.5	DFT-s-OFDM 16 QAM	1@1	22.81	21.31	0.1352
25	15	5	382500	1912.5	DFT-s-OFDM QPSK	1@1	23.3	21.8	0.1514
25	15	5	382500	1912.5	DFT-s-OFDM 16 QAM	1@1	23.05	21.55	0.1429
25	15	10	371000	1855	DFT-s-OFDM QPSK	1@1	23.1	21.6	0.1445
25	15	10	371000	1855	DFT-s-OFDM 16 QAM	1@1	22.84	21.34	0.1361
25	15	10	376500	1882.5	DFT-s-OFDM QPSK	1@1	23.06	21.56	0.1432
25	15	10	376500	1882.5	DFT-s-OFDM 16 QAM	1@1	22.71	21.21	0.1321
25	15	10	382000	1910	DFT-s-OFDM QPSK	1@1	23.2	21.7	0.1479
25	15	10	382000	1910	DFT-s-OFDM 16 QAM	1@1	22.98	21.48	0.1406
25	15	15	371500	1857.5	DFT-s-OFDM QPSK	1@1	23.39	21.89	0.1545
25	15	15	371500	1857.5	DFT-s-OFDM 16 QAM	1@1	23.11	21.61	0.1449
25	15	15	376500	1882.5	DFT-s-OFDM QPSK	1@1	23.2	21.7	0.1479
25	15	15	376500	1882.5	DFT-s-OFDM 16 QAM	1@1	22.95	21.45	0.1396
25	15	15	381500	1907.5	DFT-s-OFDM QPSK	1@1	23.21	21.71	0.1483
25	15	15	381500	1907.5	DFT-s-OFDM 16 QAM	1@1	23	21.5	0.1413
25	15	20	372000	1860	DFT-s-OFDM QPSK	1@1	23.18	21.68	0.1472
25	15	20	372000	1860	DFT-s-OFDM 16 QAM	1@1	23.02	21.52	0.1419
25	15	20	376500	1882.5	DFT-s-OFDM QPSK	1@1	23.13	21.63	0.1455
25	15	20	376500	1882.5	DFT-s-OFDM 16 QAM	1@1	22.88	21.38	0.1374
25	15	20	381000	1905	DFT-s-OFDM QPSK	1@1	23.21	21.71	0.1483
25	15	20	381000	1905	DFT-s-OFDM 16 QAM	1@1	22.85	21.35	0.1365
25	15	25	372500	1862.5	DFT-s-OFDM QPSK	1@1	23.34	21.84	0.1528
25	15	25	372500	1862.5	DFT-s-OFDM 16 QAM	1@1	23.06	21.56	0.1432
25	15	25	376500	1882.5	DFT-s-OFDM QPSK	1@1	23.15	21.65	0.1462
25	15	25	376500	1882.5	DFT-s-OFDM 16 QAM	1@1	22.9	21.4	0.1380
25	15	25	380500	1902.5	DFT-s-OFDM QPSK	1@1	23.2	21.7	0.1479

25	15	25	380500	1902.5	DFT-s-OFDM 16 QAM	1@1	22.94	21.44	0.1393
25	15	30	373000	1865	DFT-s-OFDM QPSK	1@1	23.23	21.73	0.1489
25	15	30	373000	1865	DFT-s-OFDM 16 QAM	1@1	23.06	21.56	0.1432
25	15	30	376500	1882.5	DFT-s-OFDM QPSK	1@1	23.17	21.67	0.1469
25	15	30	376500	1882.5	DFT-s-OFDM 16 QAM	1@1	22.94	21.44	0.1393
25	15	30	380000	1900	DFT-s-OFDM QPSK	1@1	23.32	21.82	0.1521
25	15	30	380000	1900	DFT-s-OFDM 16 QAM	1@1	22.94	21.44	0.1393
25	15	35	373500	1867.5	DFT-s-OFDM QPSK	1@1	23.19	21.69	0.1476
25	15	35	373500	1867.5	DFT-s-OFDM 16 QAM	1@1	22.93	21.43	0.1390
25	15	35	376500	1882.5	DFT-s-OFDM QPSK	1@1	23.14	21.64	0.1459
25	15	35	376500	1882.5	DFT-s-OFDM 16 QAM	1@1	22.87	21.37	0.1371
25	15	35	379500	1897.5	DFT-s-OFDM QPSK	1@1	23.13	21.63	0.1455
25	15	35	379500	1897.5	DFT-s-OFDM 16 QAM	1@1	22.86	21.36	0.1368
25	15	40	374000	1870	DFT-s-OFDM PI/2 BPSK	108@54	23.2	21.7	0.1479
25	15	40	374000	1870	DFT-s-OFDM PI/2 BPSK	1@1	23.12	21.62	0.1452
25	15	40	374000	1870	DFT-s-OFDM PI/2 BPSK	1@214	23.12	21.62	0.1452
25	15	40	374000	1870	DFT-s-OFDM QPSK	108@54	23.22	21.72	0.1486
25	15	40	374000	1870	DFT-s-OFDM QPSK	1@1	23.3	21.8	0.1514
25	15	40	374000	1870	DFT-s-OFDM QPSK	1@214	23.33	21.83	0.1524
25	15	40	374000	1870	DFT-s-OFDM 16 QAM	108@54	22.77	21.27	0.1340
25	15	40	374000	1870	DFT-s-OFDM 16 QAM	1@1	22.79	21.29	0.1346
25	15	40	374000	1870	DFT-s-OFDM 16 QAM	1@214	22.83	21.33	0.1358
25	15	40	374000	1870	DFT-s-OFDM 64 QAM	108@54	21.39	19.89	0.0975
25	15	40	374000	1870	DFT-s-OFDM 64 QAM	1@1	21.63	20.13	0.1030
25	15	40	374000	1870	DFT-s-OFDM 64 QAM	1@214	21.54	20.04	0.1009
25	15	40	374000	1870	DFT-s-OFDM 256 QAM	108@54	19.45	17.95	0.0624
25	15	40	374000	1870	DFT-s-OFDM 256 QAM	1@1	19.23	17.73	0.0593
25	15	40	374000	1870	DFT-s-OFDM 256 QAM	1@214	19.31	17.81	0.0604
25	15	40	374000	1870	CP-OFDM QPSK	108@54	22.4	20.9	0.1230
25	15	40	374000	1870	CP-OFDM QPSK	1@1	22.16	20.66	0.1164
25	15	40	374000	1870	CP-OFDM QPSK	1@214	22.21	20.71	0.1178
25	15	40	376500	1882.5	DFT-s-OFDM PI/2 BPSK	108@54	23.17	21.67	0.1469
25	15	40	376500	1882.5	DFT-s-OFDM PI/2 BPSK	1@1	23.04	21.54	0.1426
25	15	40	376500	1882.5	DFT-s-OFDM PI/2 BPSK	1@214	23.25	21.75	0.1496
25	15	40	376500	1882.5	DFT-s-OFDM QPSK	108@54	23.21	21.71	0.1483

25	15	40	376500	1882.5	DFT-s-OFDM QPSK	1@1	23.15	21.65	0.1462
25	15	40	376500	1882.5	DFT-s-OFDM QPSK	1@214	23.38	21.88	0.1542
25	15	40	376500	1882.5	DFT-s-OFDM 16 QAM	108@54	22.75	21.25	0.1334
25	15	40	376500	1882.5	DFT-s-OFDM 16 QAM	1@1	22.74	21.24	0.1330
25	15	40	376500	1882.5	DFT-s-OFDM 16 QAM	1@214	22.99	21.49	0.1409
25	15	40	376500	1882.5	DFT-s-OFDM 64 QAM	108@54	21.44	19.94	0.0986
25	15	40	376500	1882.5	DFT-s-OFDM 64 QAM	1@1	21.55	20.05	0.1012
25	15	40	376500	1882.5	DFT-s-OFDM 64 QAM	1@214	21.67	20.17	0.1040
25	15	40	376500	1882.5	DFT-s-OFDM 256 QAM	108@54	19.39	17.89	0.0615
25	15	40	376500	1882.5	DFT-s-OFDM 256 QAM	1@1	19.14	17.64	0.0581
25	15	40	376500	1882.5	DFT-s-OFDM 256 QAM	1@214	19.39	17.89	0.0615
25	15	40	376500	1882.5	CP-OFDM QPSK	108@54	22.43	20.93	0.1239
25	15	40	376500	1882.5	CP-OFDM QPSK	1@1	22.03	20.53	0.1130
25	15	40	376500	1882.5	CP-OFDM QPSK	1@214	22.29	20.79	0.1199
25	15	40	379000	1895	DFT-s-OFDM PI/2 BPSK	108@54	23.34	21.84	0.1528
25	15	40	379000	1895	DFT-s-OFDM PI/2 BPSK	1@1	23.04	21.54	0.1426
25	15	40	379000	1895	DFT-s-OFDM PI/2 BPSK	1@214	23.59	22.09	0.1618
25	15	40	379000	1895	DFT-s-OFDM QPSK	108@54	23.29	21.79	0.1510
25	15	40	379000	1895	DFT-s-OFDM QPSK	1@1	23.07	21.57	0.1435
25	15	40	379000	1895	DFT-s-OFDM QPSK	1@214	23.61	22.11	0.1626
25	15	40	379000	1895	DFT-s-OFDM 16 QAM	108@54	22.96	21.46	0.1400
25	15	40	379000	1895	DFT-s-OFDM 16 QAM	1@1	22.74	21.24	0.1330
25	15	40	379000	1895	DFT-s-OFDM 16 QAM	1@214	23.2	21.7	0.1479
25	15	40	379000	1895	DFT-s-OFDM 64 QAM	108@54	21.51	20.01	0.1002
25	15	40	379000	1895	DFT-s-OFDM 64 QAM	1@1	21.49	19.99	0.0998
25	15	40	379000	1895	DFT-s-OFDM 64 QAM	1@214	22.05	20.55	0.1135
25	15	40	379000	1895	DFT-s-OFDM 256 QAM	108@54	19.41	17.91	0.0618
25	15	40	379000	1895	DFT-s-OFDM 256 QAM	1@1	19.19	17.69	0.0587
25	15	40	379000	1895	DFT-s-OFDM 256 QAM	1@214	19.74	18.24	0.0667
25	15	40	379000	1895	CP-OFDM QPSK	108@54	22.41	20.91	0.1233
25	15	40	379000	1895	CP-OFDM QPSK	1@1	22.44	20.94	0.1242
25	15	40	379000	1895	CP-OFDM QPSK	1@214	22.57	21.07	0.1279

Frequency Stability

NR Band	SCS (kHz)	Bandwidth (MHz)	Arfcn	Freq (MHz)	Modulation	RB	Deviation (ppm)	Verdict	Environment
25	15	20	376500	1882.5	DFT-s-OFDM QPSK	100@0	0.0044	PASS	NV
25	15	20	376500	1882.5	DFT-s-OFDM QPSK	100@0	0.0034	PASS	LV
25	15	20	376500	1882.5	DFT-s-OFDM QPSK	100@0	0.0068	PASS	HV
25	15	20	376500	1882.5	DFT-s-OFDM QPSK	100@0	0.0047	PASS	-30°C
25	15	20	376500	1882.5	DFT-s-OFDM QPSK	100@0	0.0038	PASS	-20°C
25	15	20	376500	1882.5	DFT-s-OFDM QPSK	100@0	0.0049	PASS	-10°C
25	15	20	376500	1882.5	DFT-s-OFDM QPSK	100@0	0.0064	PASS	0°C
25	15	20	376500	1882.5	DFT-s-OFDM QPSK	100@0	0.0055	PASS	10°C
25	15	20	376500	1882.5	DFT-s-OFDM QPSK	100@0	0.0044	PASS	20°C
25	15	20	376500	1882.5	DFT-s-OFDM QPSK	100@0	0.0036	PASS	30°C
25	15	20	376500	1882.5	DFT-s-OFDM QPSK	100@0	0.0055	PASS	40°C
25	15	20	376500	1882.5	DFT-s-OFDM QPSK	100@0	0.0067	PASS	50°C

Peak to Average Ratio

NR Band	SCS (kHz)	Bandwidth (MHz)	Arfcn	Freq (MHz)	Modulation	RB	Result (dB)	Limit (dB)	Verdict
25	15	20	376500	1882.5	DFT-s-OFDM PI/2 BPSK	100@0	4.24	13	PASS
25	15	20	376500	1882.5	DFT-s-OFDM QPSK	100@0	5.41	13	PASS

N25(20M)_DFT-s-OFDM_PI_2-BPSK_Outer_Full_Mid_CH

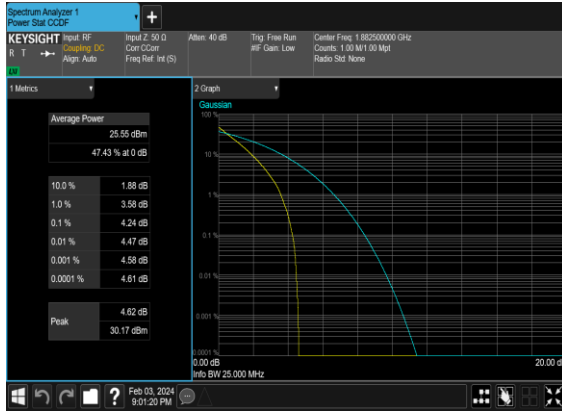

N25(20M)_DFT-s-OFDM_QPSK_Outer_Full_Mid_CH

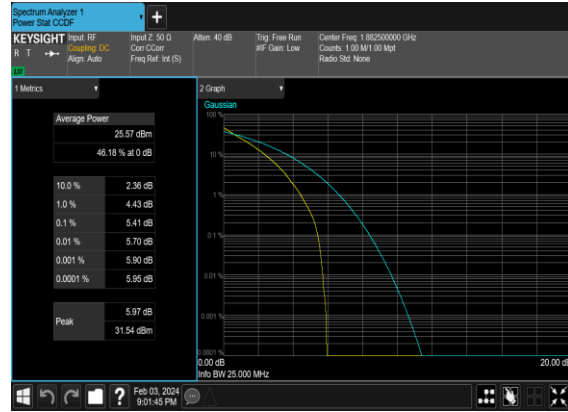

Occupied Bandwidth

NR Band	SCS (kHz)	Bandwidth (MHz)	Arfcn	Freq (MHz)	Modulation	RB	OBW (MHz)	26dB BW (MHz)
25	15	5	376500	1882.5	CP-OFDM QPSK	25@0	4.4719	5.082
25	15	5	376500	1882.5	CP-OFDM 16 QAM	25@0	4.4711	5.086
25	15	5	376500	1882.5	CP-OFDM 64 QAM	25@0	4.4737	5.09
25	15	5	376500	1882.5	CP-OFDM 256 QAM	25@0	4.4867	5.026
25	15	10	376500	1882.5	CP-OFDM QPSK	52@0	9.2827	10.11
25	15	10	376500	1882.5	CP-OFDM 16 QAM	52@0	9.3059	10.07
25	15	10	376500	1882.5	CP-OFDM 64 QAM	52@0	9.2593	9.898
25	15	10	376500	1882.5	CP-OFDM 256 QAM	52@0	9.2861	9.886
25	15	15	376500	1882.5	CP-OFDM QPSK	79@0	14.104	14.84
25	15	15	376500	1882.5	CP-OFDM 16 QAM	79@0	14.086	14.94
25	15	15	376500	1882.5	CP-OFDM 64 QAM	79@0	14.112	14.86
25	15	15	376500	1882.5	CP-OFDM 256 QAM	79@0	14.097	14.97
25	15	20	376500	1882.5	CP-OFDM QPSK	106@0	18.928	19.9
25	15	20	376500	1882.5	CP-OFDM 16 QAM	106@0	18.948	19.9
25	15	20	376500	1882.5	CP-OFDM 64 QAM	106@0	18.953	19.84
25	15	20	376500	1882.5	CP-OFDM 256 QAM	106@0	18.91	19.87
25	15	25	376500	1882.5	CP-OFDM QPSK	133@0	23.755	24.8
25	15	25	376500	1882.5	CP-OFDM 16 QAM	133@0	23.72	24.79
25	15	25	376500	1882.5	CP-OFDM 64 QAM	133@0	23.811	24.99
25	15	25	376500	1882.5	CP-OFDM 256 QAM	133@0	23.806	24.77
25	15	30	376500	1882.5	CP-OFDM QPSK	160@0	28.586	29.72
25	15	30	376500	1882.5	CP-OFDM 16 QAM	160@0	28.574	29.57
25	15	30	376500	1882.5	CP-OFDM 64 QAM	160@0	28.561	29.74
25	15	30	376500	1882.5	CP-OFDM 256 QAM	160@0	28.512	29.62
25	15	35	376500	1882.5	CP-OFDM QPSK	188@0	33.581	34.76

25	15	35	376500	1882.5	CP-OFDM 16 QAM	188@0	33.537	34.76
25	15	35	376500	1882.5	CP-OFDM 64 QAM	188@0	33.527	34.78
25	15	35	376500	1882.5	CP-OFDM 256 QAM	188@0	33.567	34.85
25	15	40	376500	1882.5	CP-OFDM QPSK	216@0	38.524	40.0
25	15	40	376500	1882.5	CP-OFDM 16 QAM	216@0	38.606	39.92
25	15	40	376500	1882.5	CP-OFDM 64 QAM	216@0	38.616	39.87
25	15	40	376500	1882.5	CP-OFDM 256 QAM	216@0	38.599	39.83

N25(5M)_CP-OFDM_QPSK_Outer_Full_Mid_CH

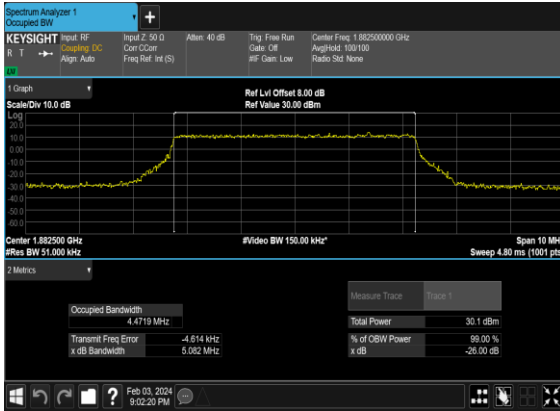

N25(5M)_CP-OFDM_16QAM_Outer_Full_Mid_CH

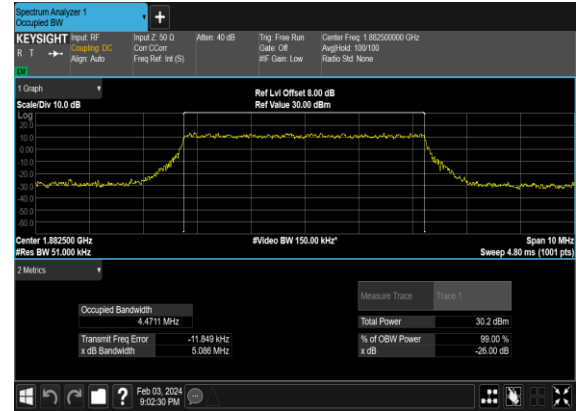

N25(5M)_CP-OFDM_64QAM_Outer_Full_Mid_CH



N25(5M)_CP-OFDM_256QAM_Outer_Full_Mid_CH



N25(10M)_CP-OFDM_QPSK_Outer_Full_Mid_CH

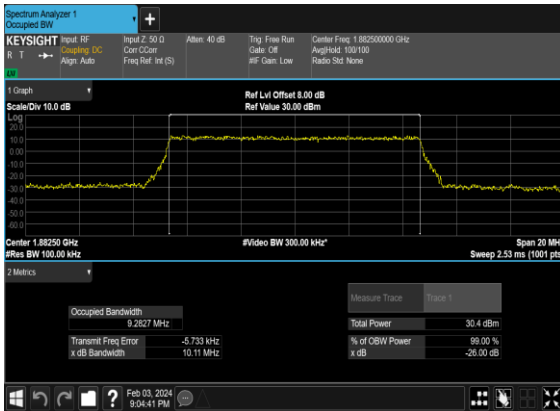

N25(10M)_CP-OFDM_16QAM_Outer_Full_Mid_CH

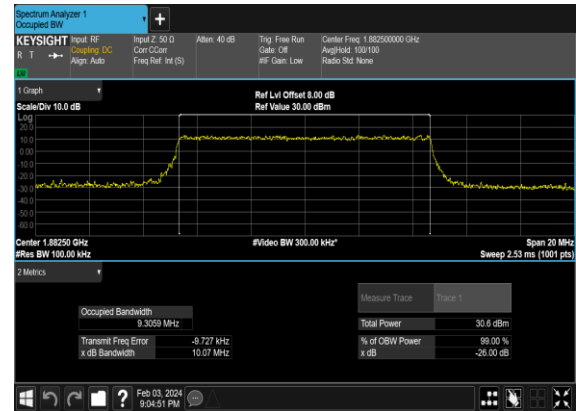

N25(10M)_CP-OFDM_64 QAM_Outer_Full_Mid_CH

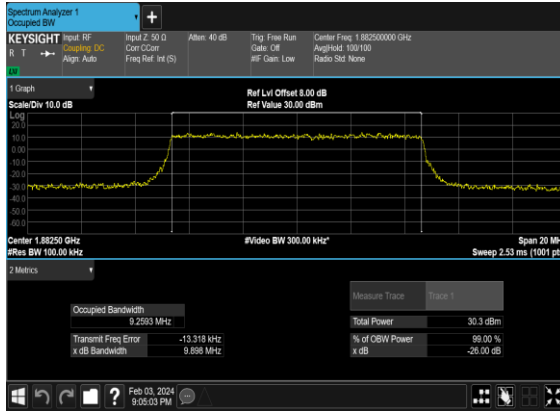

N25(10M)_CP-OFDM_256 QAM_Outer_Full_Mid_CH

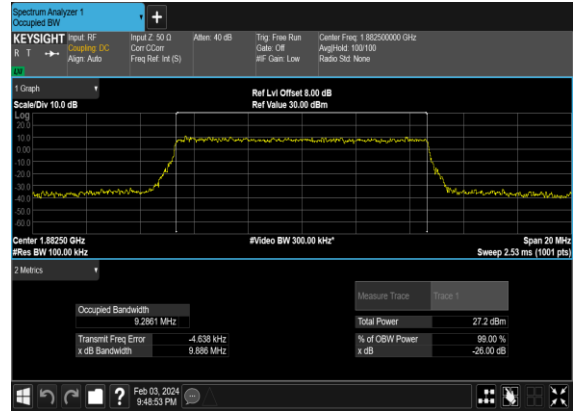

N25(15M)_CP- OFDM_QPSK_Outer_Full_Mid_CH

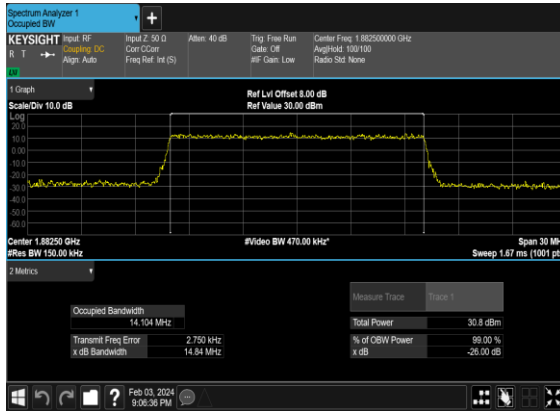

N25(15M)_CP-OFDM_16 QAM_Outer_Full_Mid_CH

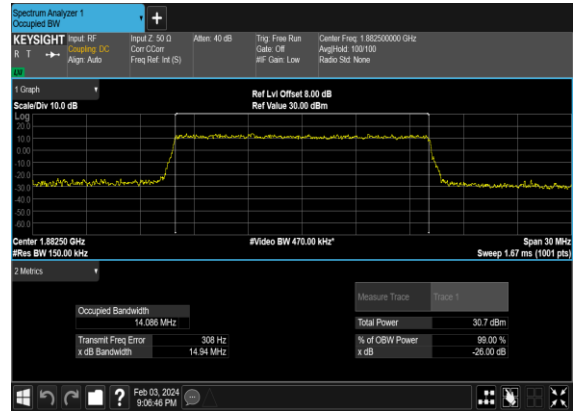

N25(15M)_CP-OFDM_64 QAM_Outer_Full_Mid_CH

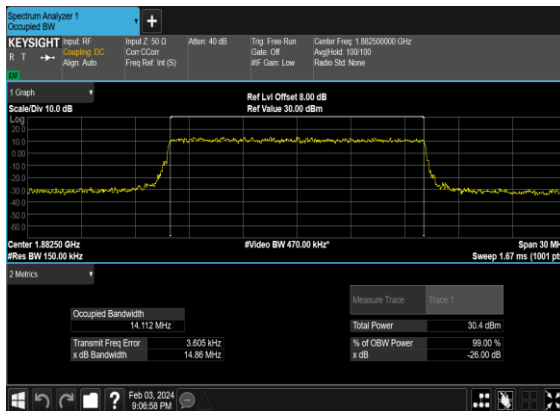

N25(15M)_CP-OFDM_256 QAM_Outer_Full_Mid_CH

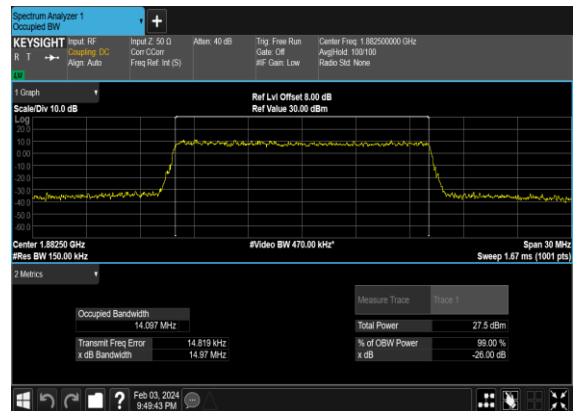

N25(20M)_CP-OFDM_QPSK_Outer_Full_Mid_CH

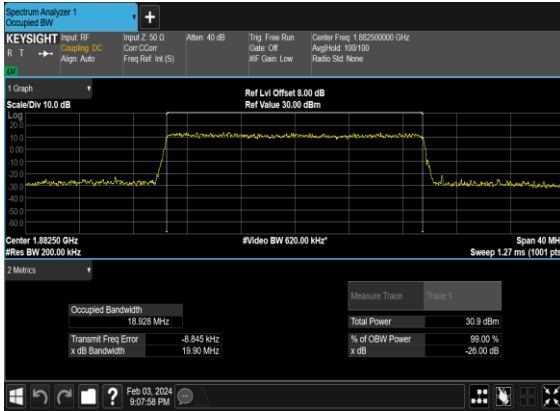

N25(20M)_CP-OFDM_16QAM_Outer_Full_Mid_CH

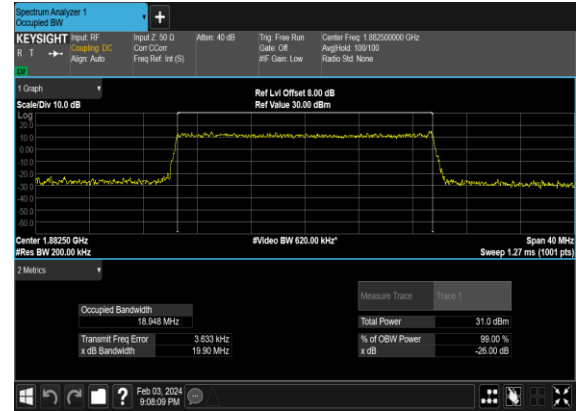

N25(20M)_CP-OFDM_64QAM_Outer_Full_Mid_CH



N25(20M)_CP-OFDM_256QAM_Outer_Full_Mid_CH

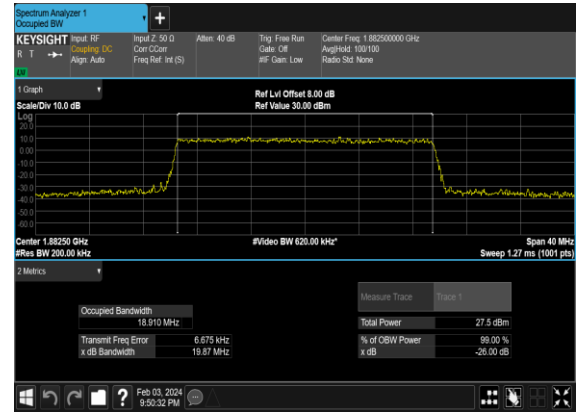

N25(25M)_CP-OFDM_QPSK_Outer_Full_Mid_CH

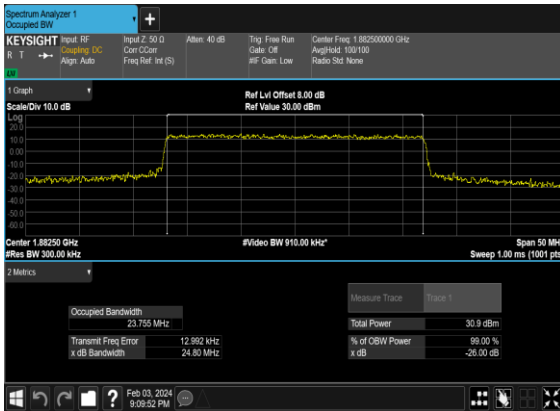

N25(25M)_CP-OFDM_16QAM_Outer_Full_Mid_CH

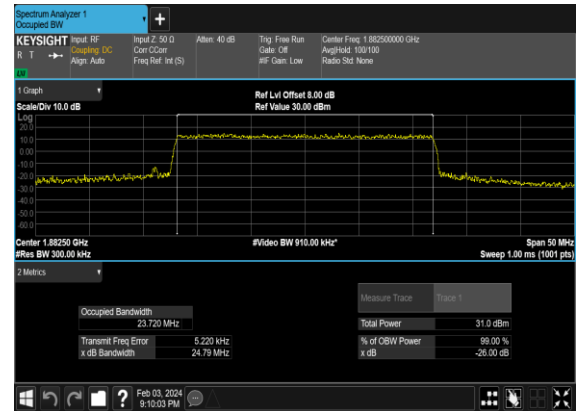

N25(25M)_CP-OFDM_64 QAM_Outer_Full_Mid_CH

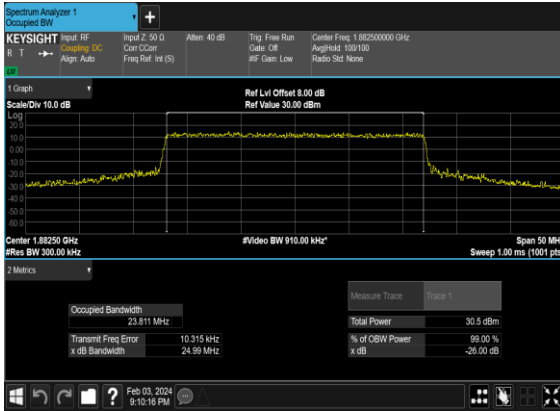

N25(25M)_CP-OFDM_256 QAM_Outer_Full_Mid_CH

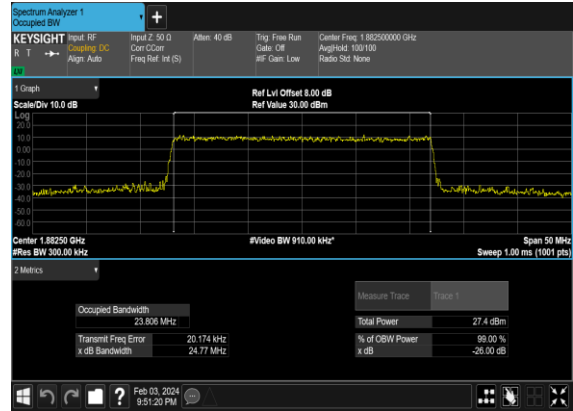

N25(30M)_CP- OFDM_QPSK_Outer_Full_Mid_CH

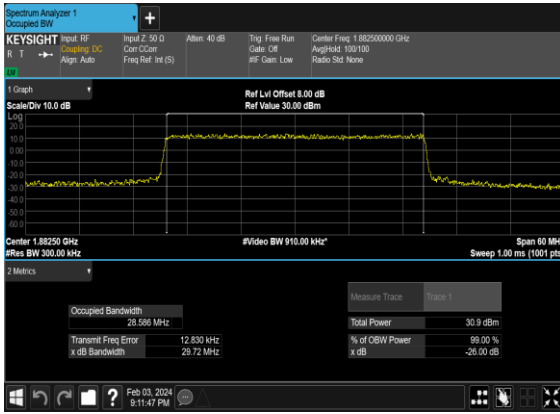

N25(30M)_CP-OFDM_16 QAM_Outer_Full_Mid_CH

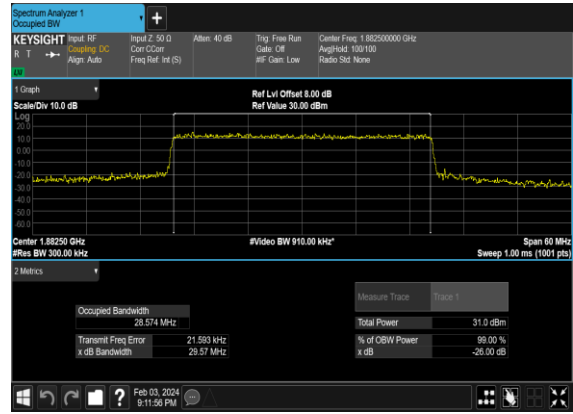

N25(30M)_CP-OFDM_64 QAM_Outer_Full_Mid_CH

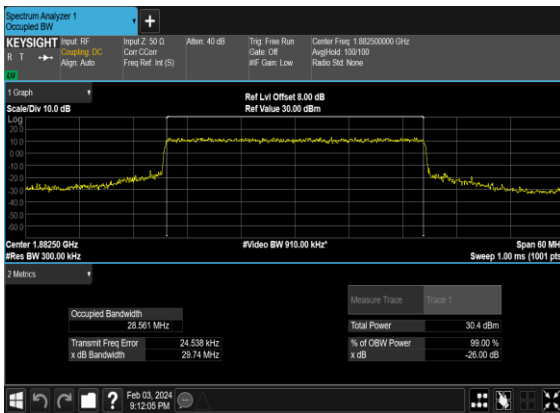

N25(30M)_CP-OFDM_256 QAM_Outer_Full_Mid_CH

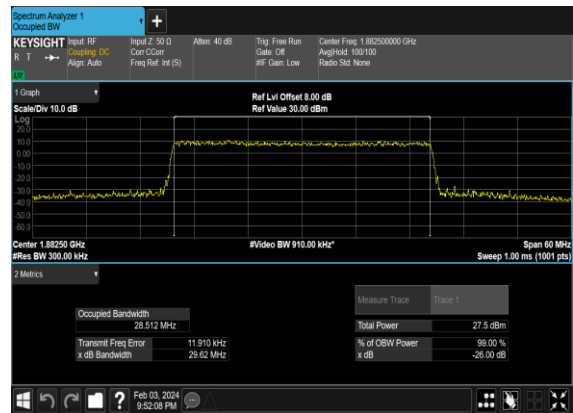

N25(35M)_CP-OFDM_QPSK_Outer_Full_Mid_CH

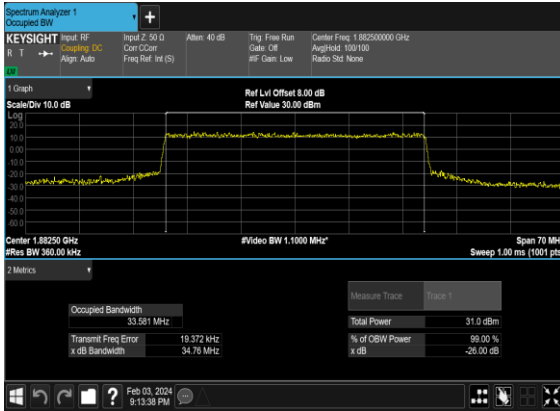

N25(35M)_CP-OFDM_16QAM_Outer_Full_Mid_CH

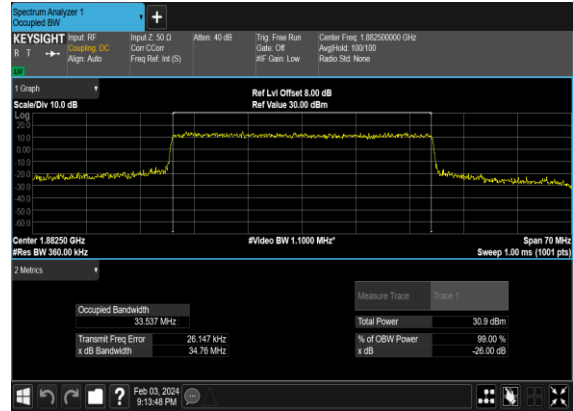

N25(35M)_CP-OFDM_64QAM_Outer_Full_Mid_CH



N25(35M)_CP-OFDM_256QAM_Outer_Full_Mid_CH

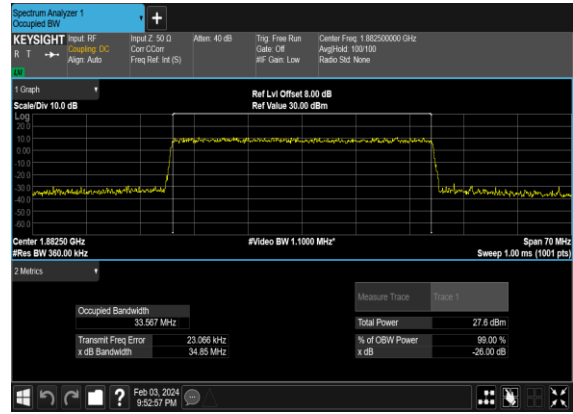

N25(40M)_CP-OFDM_QPSK_Outer_Full_Mid_CH

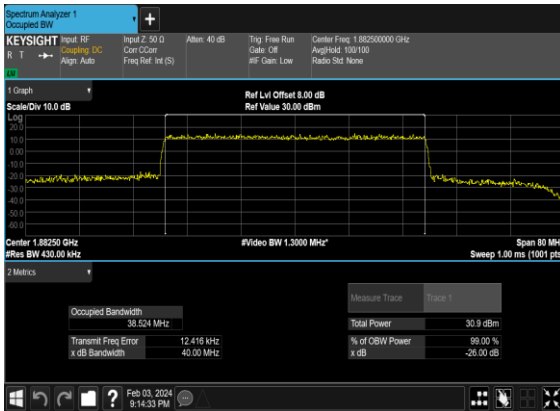

N25(40M)_CP-OFDM_16QAM_Outer_Full_Mid_CH

