



FCC RF Test Report

APPLICANT : Motorola Mobility LLC
EQUIPMENT : Mobile Cellular Phone
BRAND NAME : Motorola
MODEL NAME : XT2405-1, XT2405V
FCC ID : IHDT56AN6
STANDARD : 47 CFR Part 2, 96
CLASSIFICATION : Citizens Band End User Devices (CBE)
EQUIPMENT TYPE : End User Equipment
TEST DATE(S) : Feb. 01, 2024 ~ Mar. 18, 2024

We, Sporton International Inc. (ShenZhen), would like to declare that the tested sample has been evaluated in accordance with the procedures given in ANSI C63.26 and shown compliance with the applicable technical standards.

The test results in this report apply exclusively to the tested model / sample. Without written approval of Sporton International Inc. (ShenZhen), the test report shall not be reproduced except in full.

Jason Jia



Approved by: Jason Jia

Sporton International Inc. (ShenZhen)

1/F, 2/F, Bldg 5, Shiling Industrial Zone, Xinwei Village, Xili, Nanshan, Shenzhen, 518055

People's Republic of China



Table of Contents

History of this test report..... 3

Summary of Test Result..... 4

1 General Description 5

 1.1 Applicant..... 5

 1.2 Manufacturer 5

 1.3 Feature of Equipment Under Test..... 5

 1.4 Modification of EUT 5

 1.5 Specification of Accessory 6

 1.6 Maximum EIRP Power and Emission Designator 6

 1.7 Testing Site..... 7

 1.8 Test Software 7

 1.9 Applied Standards 8

2 Test Configuration of Equipment Under Test 9

 2.1 Test Mode..... 9

 2.2 Connection Diagram of Test System 10

 2.3 Support Unit used in test configuration 10

 2.4 Measurement Results Explanation Example 10

 2.5 Frequency List of Low/Middle/High Channels..... 11

3 Conducted Test Items..... 12

 3.1 Measuring Instruments..... 12

 3.2 Conducted Output Power 13

 3.3 EIRP 14

 3.4 Occupied Bandwidth 15

 3.5 Conducted Band Edge 16

 3.6 Conducted Spurious Emission 17

 3.7 Frequency Stability..... 18

4 Radiated Test Items 19

 4.1 Measuring Instruments..... 19

 4.2 Test Setup 19

 4.3 Test Result of Radiated Test..... 20

 4.4 Radiated Spurious Emission 21

5 List of Measuring Equipment..... 22

6 Measurement Uncertainty 23

Appendix A. Test Results of Conducted Test

Appendix B. Test Results of Radiated Test

Appendix C. Test Setup Photographs



Summary of Test Result

Report Clause	Ref Std. Clause	Test Items	Result (PASS/FAIL)	Remark
3.2	§2.1046	Conducted Output Power	Reporting only	-
-	§96.41	Peak-to-Average Ratio	Not Applicable	Not applicable for End User Devices
3.3	§96.41	Maximum E.I.R.P	Pass	-
		Maximum Power Spectral Density	Not Applicable	Not applicable for End User Devices
3.4	§2.1049 §96.41	Occupied Bandwidth	Reporting only	-
3.5	§2.1051 §96.41	Conducted Band Edge Measurement Adjacent Channel Leakage Ratio	Pass	-
3.6	§2.1051 §96.41	Conducted Spurious Emission	Pass	
3.7	§2.1055	Frequency Stability for Temperature & Voltage	Pass	-
4.4	§2.1051 §96.41	Radiated Spurious Emission	Pass	Under limit 10.16 dB at 14425.60 MHz

Conformity Assessment Condition:

1. The test results (PASS/FAIL) with all measurement uncertainty excluded are presented against the regulation limits or in accordance with the requirements stipulated by the applicant/manufacture who shall bear all the risks of non-compliance that may potentially occur if measurement uncertainty is taken into account.
2. The measurement uncertainty please refer to each test result in the section "Measurement Uncertainty"

Disclaimer:

The product specifications of the EUT presented in the test report that may affect the test assessments are declared by the manufacturer who shall take full responsibility for the authenticity.



1 General Description

1.1 Applicant

Motorola Mobility LLC
222 W,Merchandise Mart Plaza, Chicago IL 60654 USA

1.2 Manufacturer

Motorola Mobility LLC
222 W,Merchandise Mart Plaza, Chicago IL 60654 USA

1.3 Feature of Equipment Under Test

Product Feature	
Equipment	Mobile Cellular Phone
Brand Name	Motorola
Model Name	XT2405-1, XT2405V
FCC ID	IHDT56AN6
Tx Frequency	5G NR n48: 3550 MHz ~ 3700 MHz
Rx Frequency	5G NR n48: 3550 MHz ~ 3700 MHz
SCS	30kHz
Bandwidth	10MHz / 20MHz / 30MHz / 40MHz
Antenna Gain	<Ant. 4>: -3.0 dBi <Ant. 7>: -1.5 dBi <Ant. 8>: -4.0 dBi <Ant. 10>: -7.0 dBi
Type of Modulation	DFT-s-OFDM (PI/2 BPSK / QPSK / 16QAM / 64QAM / 256QAM) CP-OFDM (QPSK / 16QAM / 64QAM / 256QAM)
IMEI Code	Conducted: 353533390038357/353533390038365 Radiation: 353533390041054/353533390041062
HW Version	DVT2
SW Version	U2UAN34.50
EUT Stage	Identical Prototype

Remark:

1. The two models XT2405-1, XT2405V is only for market segment purpose, no other difference.
2. 5G NR n48 supports UL MIMO mode, the two antennas are completely uncorrelated, the conducted BE/Spurious are tested at single antenna port and add $10 \cdot \log(N_{ANT})$ according to KDB 662911 D01.
3. The maximum EIRP is calculated from max output power and max antenna gain, only the maximum EIRP of Ant. 7 for n48 SISO mode, and Ant.(4+7) for n48 UL_MIMO for are shown in the report.
4. 5G NR n48 supports SA mode only.

1.4 Modification of EUT

No modifications are made to the EUT during all test items.



1.5 Specification of Accessory

Specification of Accessory				
AC Adapter 1(US)	Brand Name	Motorola (Chenyang)	Model Name	MC-681N
AC Adapter 2(US)	Brand Name	Motorola (Acbel)	Model Name	MC-681N
Battery	Brand Name	Motorola (NVT)	Model Name	QC50
USB Cable 1	Brand Name	Motorola (Saibao)	Model Name	SC18D71644
USB Cable 2	Brand Name	Motorola (Saibao)	Model Name	SC18D86731
USB Cable 3	Brand Name	Motorola (Luxshare)	Model Name	SC18E08104
USB Cable 4	Brand Name	Motorola (Luxshare)	Model Name	SC18E08103
Wireless Earphones	Brand Name	Motorola	Model Name	XT2441-1

1.6 Maximum EIRP Power and Emission Designator

5G NR n48		PI/2 BPSK / QPSK		16QAM/64QAM/256QAM	
BW (MHz)	Frequency Range (MHz)	Maximum EIRP(W)	Emission Designator (99%OBW)	Maximum EIRP(W)	Emission Designator (99%OBW)
10	3555.00~3694.98	0.1191	8M57G7D	0.1164	8M59W7D
20	3560.01~3690.00	0.1132	18M2G7D	0.0904	18M3W7D
30	3564.99~3684.99	0.0745	27M8G7D	0.0752	27M9W7D
40	3570.00~3679.98	0.1377	37M8G7D	0.0959	37M9W7D

5G NR n48_UL MIMO		PI/2 BPSK / QPSK		16QAM/64QAM/256QAM	
BW (MHz)	Frequency Range (MHz)	Maximum EIRP(W)	Emission Designator (99%OBW)	Maximum EIRP(W)	Emission Designator (99%OBW)
10	3555.00~3694.98	0.1390	8M58G7D	0.1387	8M59W7D
20	3560.01~3690.00	0.1396	18M2G7D	0.1380	18M2W7D
30	3564.99~3684.99	0.1067	27M9G7D	0.1045	27M9W7D
40	3570.00~3679.98	0.1403	37M8G7D	0.1380	37M9W7D



1.7 Testing Site

Sporton International Inc. (ShenZhen) is accredited to ISO/IEC 17025:2017 by American Association for Laboratory Accreditation with Certificate Number 5145.01.

Test Firm	Sporton International Inc. (ShenZhen)		
Test Site Location	1/F, 2/F, Bldg 5, Shiling Industrial Zone, Xinwei Village, Xili, Nanshan, Shenzhen, 518055 People’s Republic of China TEL: +86-755-86379589 FAX: +86-755-86379595		
Test Site No.	Sporton Site No.	FCC Designation No.	FCC Test Firm Registration No.
	TH01-SZ	CN1256	421272

Test Firm	Sporton International Inc. (ShenZhen)		
Test Site Location	101, 1st Floor, Block B, Building 1, No. 2, Tengfeng 4th Road, Fenghuang Community, Fuyong Street, Baoan District, Shenzhen City, Guangdong Province 518103 People’s Republic of China TEL: +86-755-86066985		
Test Site No.	Sporton Site No.	FCC Designation No.	FCC Test Firm Registration No.
	03CH03-SZ	CN1256	421272

1.8 Test Software

Item	Site	Manufacture	Name	Version
1.	03CH03-SZ	AUDIX	E3	6.2009-8-24



1.9 Applied Standards

According to the specifications of the manufacturer, the EUT must comply with the requirements of the following standards:

- ♦ ANSI C63.26-2015
- ♦ 47 CFR Part 2, 96
- ♦ FCC KDB 971168 D01 Power Meas. License Digital Systems v03r01
- ♦ FCC KDB 940660 D01 Part 96 CBRS v03
- ♦ FCC KDB 412172 D01 Determining ERP and EIRP v01r01

Remark:

1. All test items were verified and recorded according to the standards and without any deviation during the test.
2. This EUT has also been tested and complied with the requirements of FCC Part 15, Subpart B, recorded in a separate test report.



2 Test Configuration of Equipment Under Test

2.1 Test Mode

Antenna port conducted and radiated test items listed below are performed according to KDB 971168 D01 Power Meas. License Digital Systems v03r01 with maximum output power.

For radiated measurement, pre-scanned in three orthogonal panels, X, Y, Z. The worst cases (X plane) were recorded in this report.

Test Items	Band	Bandwidth (MHz)						Modulation					RB #		Test Channel			
		5	10	15	20	30	40	PI/2 BPSK	QPSK	16QAM	64QAM	256 QAM	1	Full	L	M	H	
Max. Output Power	n48	-	v	-	v	v	v	v	v	v	v	v	v	v	v	v	v	v
26dB and 99% Bandwidth	n48	-	v	-	v	v-	v		v	v	v	v		v			v	
Adjacent Channel Leakage Ratio	n48	-	v	-	v		v	v	v				v	v	v	v	v	
Conducted Band Edge	n48	-	v	-	v		v	v	v				v	v	v	v	v	
Conducted Spurious Emission	n48	-	v	-	v		v	v	v				v	v	v	v	v	
E.R.P / E.I.R.P	n48	-	v	-	v	v	v	v	v	v	v	v	v	v	v	v	v	
Frequency Stability	n48	-		-	v				v					v			v	
Radiated Spurious Emission	n48	Worst Case															v	
Remark	<ol style="list-style-type: none"> The mark "v" means that this configuration is chosen for testing The mark "- " means that this bandwidth is not supported. The device is investigated from 30MHz to 10 times of fundamental signal for radiated spurious emission test under different RB size/offset and modulations in exploratory test. Subsequently, only the worst case emissions are reported. All test items are based on engineering evaluation. Frequency Stability: Normal Voltage = 3.91V ; Low Voltage =4.50V; High Voltage =3.40V 																	

2.2 Connection Diagram of Test System

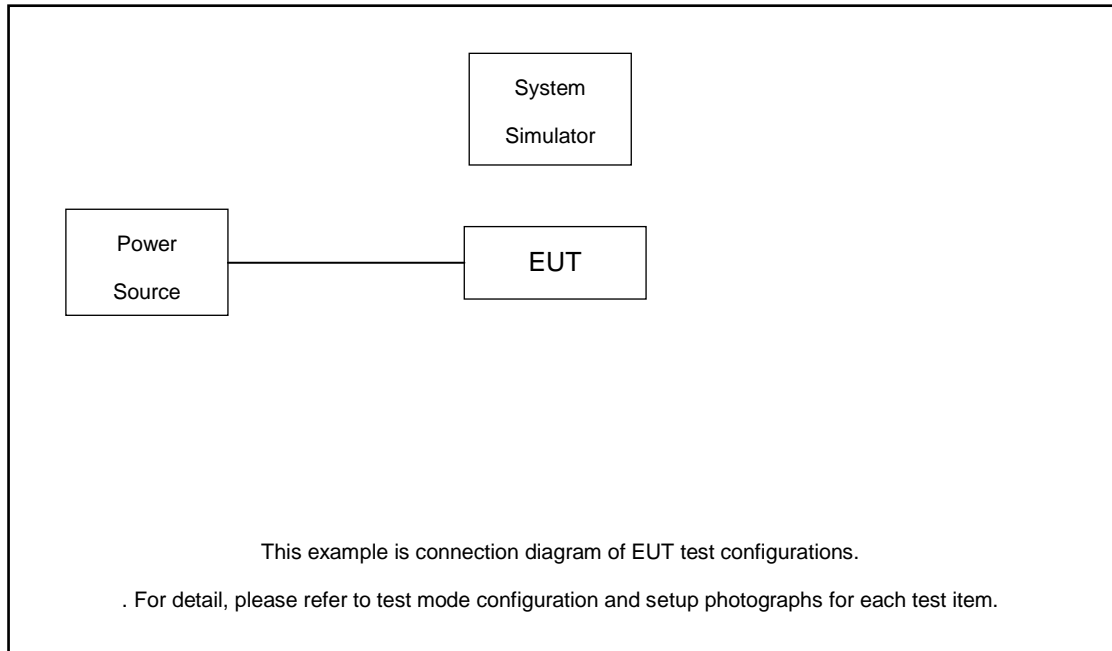

2.3 Support Unit used in test configuration

Item	Equipment	Trade Name	Model No.	FCC ID	Data Cable	Power Cord
1.	Power Supply	GWINSTEK	PSS-2002	N/A	N/A	Unshielded, 1.8 m
2.	Base Station	Anritsu	MT8000A	N/A	Fcc DoC	N/A

2.4 Measurement Results Explanation Example

For all conducted test items:

The offset level is set in the spectrum analyzer to compensate the RF cable loss and attenuator factor between EUT conducted output port and spectrum analyzer. With the offset compensation, the spectrum analyzer reading level is exactly the EUT RF output level.

The spectrum analyzer offset is derived from RF cable loss and attenuator factor.

$$\text{Offset} = \text{RF cable loss} + \text{attenuator factor}.$$

Following shows an offset computation example with cable loss 4.2 dB and 10dB attenuator.

Example :

$$\begin{aligned} \text{Offset(dB)} &= \text{RF cable loss(dB)} + \text{attenuator factor(dB)}. \\ &= 1.9 + 10 = 11.9 \text{ (dB)} \end{aligned}$$



2.5 Frequency List of Low/Middle/High Channels

5G NR n48 Channel and Frequency List				
BW [MHz]	Channel/Frequency(MHz)	Lowest	Middle	Highest
40	Channel	638000	641666	645332
	Frequency	3570	3624.99	3679.98
30	Channel	637666	641666	645666
	Frequency	3564.99	3624.99	3684.99
20	Channel	637334	641666	646000
	Frequency	3560.01	3624.99	3690
10	Channel	637000	641666	646332
	Frequency	3555	3624.99	3694.98

3 Conducted Test Items

3.1 Measuring Instruments

See list of measuring instruments of this test report.

3.1.1 Test Setup

3.1.2 Conducted Output Power



3.1.3 Occupied Bandwidth, Conducted Band-Edge and Conducted Spurious Emission

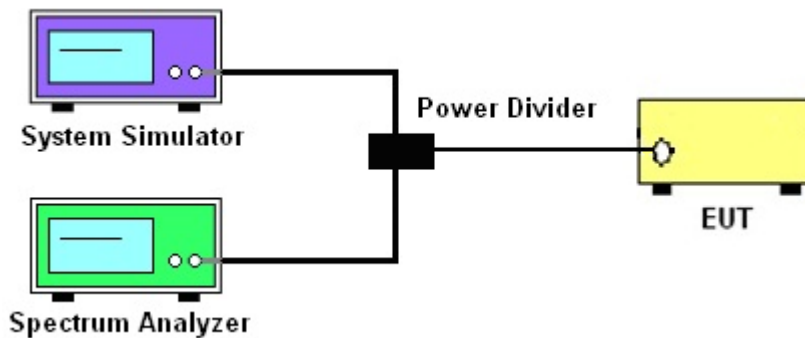

3.1.4 Frequency Stability

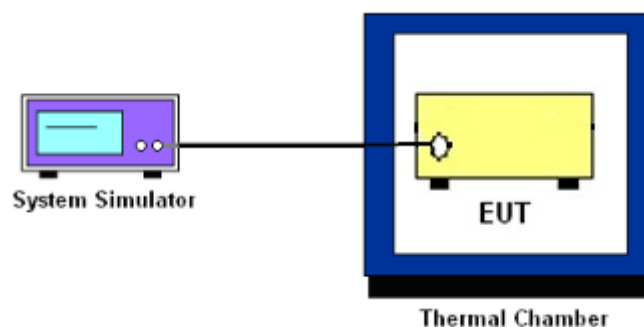

3.1.5 Test Result of Conducted Test

Please refer to Appendix A.



3.2 Conducted Output Power

3.2.1 Description of the Conducted Output Power Measurement

A system simulator was used to establish communication with the EUT. Its parameters were set to force the EUT transmitting at maximum output power. The measured power in the radio frequency on the transmitter output terminals shall be reported.

3.2.2 Test Procedures

1. The transmitter output port was connected to the system simulator.
2. Set EUT at maximum power through the system simulator.
3. Select lowest, middle, and highest channels for each band and different modulation.
4. Measure and record the power level from the system simulator.

3.3 EIRP

3.3.1 Description of the EIRP Measurement

EIRP limits for CBRS equipment as below table:

Device		Maximum EIRP (dBm/10 MHz)	Maximum PSD (dBm/MHz)
Applied	End User Device	23	N/A
<input type="checkbox"/>	Category A CBSD	30	20
<input type="checkbox"/>	Category B CBSD	47	37

Remark: The worst case EIRP shown in this section is found with LTE operating only using 1RB. As such, the EIRP/10MHz and full channel EIRP values will be identical since 1RB is fully contained within all available channel bandwidths for LTE Band 48 (i.e. 5, 10, 15, 20MHz)

3.3.2 Test Procedures for EIRP

1. Establishing a communications link with the call box (Base station) to measure the Maximum conducted power, the parameters were set to force the EUT transmitting at maximum output power level. Use the average power measurement function to measure total channel power of each channel bandwidth (per ANSI C63.26-2015 Section 5.2.1)
2. Determining ERP and/or EIRP from conducted RF output power measurements (Per ANSI C63.26-2015 Section 5.2.5.5)
 - EIRP = $P_T + G_T - L_C$, ERP = EIRP -2.15, where
 - P_T = transmitter output power in dBm
 - G_T = gain of the transmitting antenna in dBi
 - L_C = signal attenuation in the connecting cable between the transmitter and antenna in dB



3.4 Occupied Bandwidth

3.4.1 Description of Occupied Bandwidth Measurement

The occupied bandwidth is the width of a frequency band such that, below the lower and above the upper frequency limits, the mean powers emitted are each equal to a specified percentage 0.5% of the total mean transmitted power.

The 26 dB emission bandwidth is defined as the frequency range between two points, one above and one below the carrier frequency, at which the spectral density of the emission is attenuated 26 dB below the maximum in-band spectral density of the modulated signal. Spectral density (power per unit bandwidth) is to be measured with a detector of resolution bandwidth equal to approximately 1.0% of the emission bandwidth.

3.4.2 Test Procedures

The testing follows ANSI C63.26-2015 Section 5.4.3 (26dB) and Section 5.4.4 (99OB)

1. The EUT was connected to spectrum analyzer and system simulator via a power divider.
2. The spectrum analyzer center frequency is set to the nominal EUT channel center frequency. The span range for the spectrum analyzer shall be between two and five times the anticipated OBW.
3. The nominal resolution bandwidth (RBW) shall be in the range of 1 to 5 % of the anticipated OBW, and the VBW shall be at least 3 times the RBW.
4. Set the detection mode to peak, and the trace mode to max hold.
5. Determine the reference value: Set the EUT to transmit a modulated signal. Allow the trace to stabilize. Set the spectrum analyzer marker to the highest level of the displayed trace.
(this is the reference value)
6. Determine the “-26 dB down amplitude” as equal to (Reference Value – X).
7. Place two markers, one at the lowest and the other at the highest frequency of the envelope of the spectral display such that each marker is at or slightly below the “-X dB down amplitude” determined in step 6. If a marker is below this “-X dB down amplitude” value it shall be placed as close as possible to this value. The OBW is the positive frequency difference between the two markers.
8. Use the 99 % power bandwidth function of the spectrum analyzer and report the measured bandwidth.

3.5 Conducted Band Edge

3.5.1 Description of Conducted Band Edge Measurement

Part 96.41 (e) (1) (ii)

For End User Devices the emission limits outside the fundamental are as follows:

Within 0 MHz to B MHz above and below the assigned channel ≤ -13 dBm/MHz

Greater than B MHz above and below the assigned channel ≤ -25 dBm/MHz

where B is the bandwidth in megahertz of the assigned channel or multiple contiguous channels of the End User Device.

Notwithstanding the emission limits in this paragraph, the Adjacent Channel Leakage Ratio for End User Devices shall be at least 30 dB.

Part 96.41 (e) (2)

For CBSDs and End User Devices, the conducted power of emissions below 3540 MHz or above 3710 MHz shall not exceed -25 dBm/MHz, and the conducted power of emissions below 3530 MHz or above 3720 MHz shall not exceed -40 dBm/MHz

3.5.2 Test Procedures

The testing follows FCC KDB 971168 D01 v03r01 Section 6.1.

1. The EUT was connected to spectrum analyzer and system simulator via a power divider.
2. The band edges of low and high channels for the highest RF powers were measured.
3. Set RBW $\geq 1\%$ EBW in the 1MHz band immediately outside and adjacent to the band edge.
4. Beyond the 1 MHz band from the band edge, RBW=1MHz was used
5. Offset has included the duty factor for LTE Band 48. Duty factor $=10 \log (1/x)$, where x is the measured duty cycle.
6. Set spectrum analyzer with RMS detector.
7. The RF fundamental frequency should be excluded against the limit line in the operating frequency band.



3.6 Conducted Spurious Emission

3.6.1 Description of Conducted Spurious Emission Measurement

96.41 (e)(2)

The conducted power of any emissions below 3530 MHz or above 3720 MHz shall not exceed -40dBm/MHz.

3.6.2 Test Procedures

The testing follows FCC KDB 971168 D01 v03r01 Section 6.1.

1. The EUT was connected to spectrum analyzer and system simulator via a power divider.
2. The RF output of EUT was connected to the spectrum analyzer by RF cable and attenuator. The path loss was compensated to the results for each measurement.
3. The middle channel for the highest RF power within the transmitting frequency was measured.
4. The conducted spurious emission for the whole frequency range was taken.
5. Make the measurement with the spectrum analyzer's RBW = 1MHz, VBW = 3MHz.
6. Set spectrum analyzer with RMS detector.
7. Taking the record of maximum spurious emission.
8. The RF fundamental frequency should be excluded against the limit line in the operating frequency band.
9. The limit line is -40dBm/MHz.



3.7 Frequency Stability

3.7.1 Description of Frequency Stability Measurement

The frequency stability shall be measured by variation of ambient temperature and variation of primary supply voltage to ensure that the fundamental emission stays within the authorized frequency block. The frequency stability of the transmitter shall be maintained within $\pm 0.00025\%$ ($\pm 2.5\text{ppm}$) of the center frequency

3.7.2 Test Procedures for Temperature Variation

The testing follows FCC KDB 971168 D01 v03r01 Section 9.0.

1. The EUT was set up in the thermal chamber and connected with the system simulator.
2. With power OFF, the temperature was decreased to -30°C and the EUT was stabilized before testing. Power was applied and the maximum change in frequency was recorded within one minute.
3. With power OFF, the temperature was raised in 10°C step up to 50°C . The EUT was stabilized at each step for at least half an hour. Power was applied and the maximum frequency change was recorded within one minute.

3.7.3 Test Procedures for Voltage Variation

The testing follows FCC KDB 971168 D01 v03r01 Section 9.0.

1. The EUT was placed in a temperature chamber at $25\pm 5^{\circ}\text{C}$ and connected with the system simulator.
2. The power supply voltage to the EUT was varied from 85% to 115% of the nominal value measured at the input to the EUT.
3. The variation in frequency was measured for the worst case.

4 Radiated Test Items

4.1 Measuring Instruments

See list of measuring instruments of this test report.

4.2 Test Setup

4.2.1 For radiated test below 30MHz

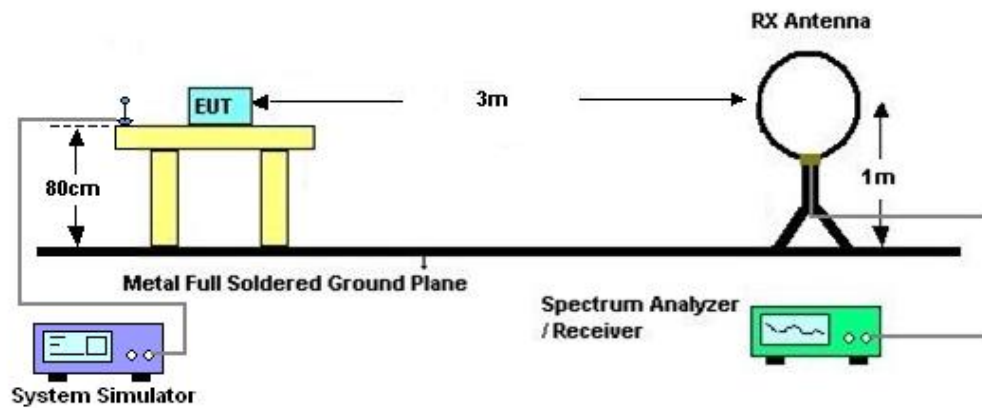

4.2.2 For radiated test from 30MHz to 1GHz

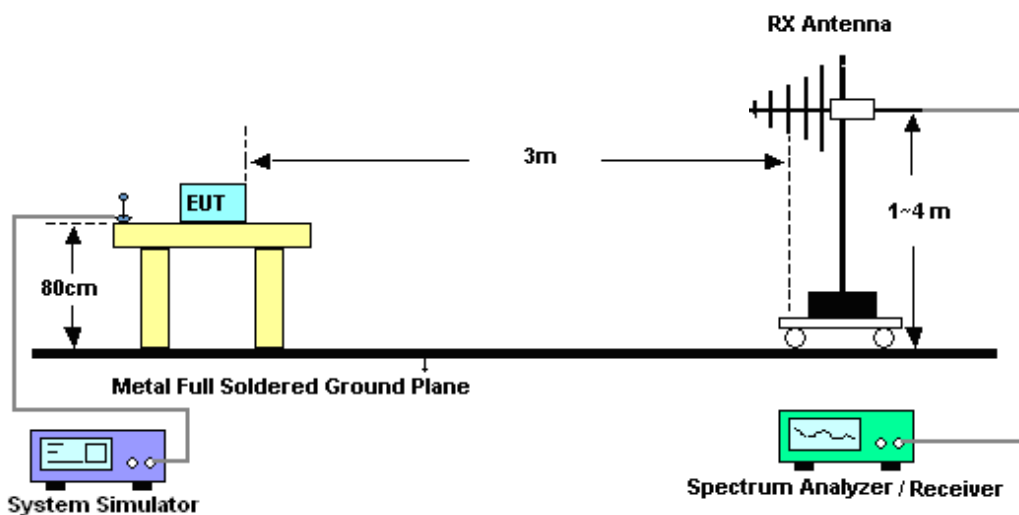

4.2.3 For radiated test above 1GHz

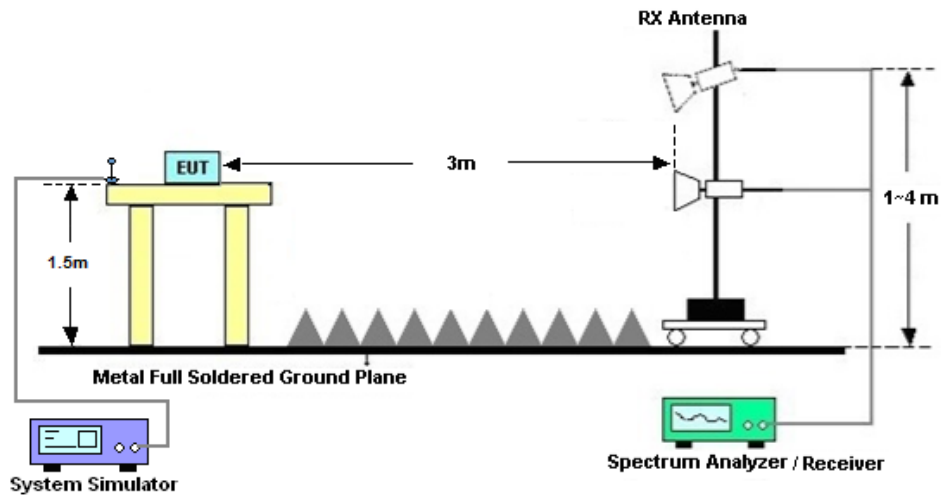

4.3 Test Result of Radiated Test

The low frequency, which started from 9 kHz to 30MHz, was pre-scanned and the result which was 20dB lower than the limit line was not reported.

Please refer to Appendix B.



4.4 Radiated Spurious Emission

4.4.1 Description of Radiated Spurious Emission Measurement

The radiated spurious emission was measured by substitution method according to ANSI C63.26. The power of any emission outside of the authorized operating frequency ranges must be attenuated below the transmitter power (P) by a factor of at least -40dBm / MHz.

The spectrum is scanned from 30 MHz up to a frequency including its 10th harmonic.

4.4.2 Test Procedures

1. The EUT was placed on a turntable with 0.8 meter height for frequency below 1GHz and 1.5 meter height for frequency above 1GHz respectively above ground.
2. The EUT was set 3 meters from the receiving antenna mounted on the antenna tower.
3. The table was rotated 360 degrees to determine the position of the highest spurious emission.
4. The height of the receiving antenna is varied between 1m to 4m to search the maximum spurious emission for both horizontal and vertical polarizations.
5. During the measurement, the system simulator parameters were set to force the EUT transmitting at maximum output power.
6. Make the measurement with the spectrum analyzer's RBW = 1MHz, VBW = 3MHz, taking the record of maximum spurious emission.
7. A horn antenna was substituted in place of the EUT and was driven by a signal generator. Tune the output power of signal generator to the same emission level with EUT maximum spurious emission.
 $EIRP \text{ (dBm)} = S.G. \text{ Power} - Tx \text{ Cable Loss} + Tx \text{ Antenna Gain}$
 $ERP \text{ (dBm)} = EIRP - 2.15$
8. The RF fundamental frequency should be excluded against the limit line in the operating frequency band.
The limit line is -40dBm/MHz



5 List of Measuring Equipment

Instrument	Manufacturer	Model No.	Serial No.	Characteristics	Calibration Date	Test Date	Due Date	Remark
Spectrum Analyzer	R&S	FSV40	101078	10Hz~40GHz	Apr. 06, 2023	Feb.01,2024~ Mar.18, 2024	Apr. 05, 2024	Conducted (TH01-SZ)
DC Power Supply	TTI	PL330P	290070	Max 32V , 3A	Oct. 16, 2023	Feb.01,2024~ Mar.18, 2024	Oct. 15, 2024	Conducted (TH01-SZ)
Power Divider	TOJOIN	PS-2SM-0426 5	60.06.020. 0077	0.4GHz~26.5G Hz	Dec. 25, 2023	Feb.01,2024~ Mar.18, 2024	Dec. 24, 2024	Conducted (TH01-SZ)
Thermal Chamber	Ten Billion Hongzhangrou p	LP-150U	H2014081 803	-40~+150°C	Jul. 05, 2023	Feb.01,2024~ Mar.18, 2024	Jul. 04, 2024	Conducted (TH01-SZ)
EMI Test Receiver&SA	KEYSIGHT	N9038A	MY544500 83	20Hz~8.4GHz	Apr. 04, 2023	Feb. 26,2024	Apr. 03, 2024	Radiation (03CH03-SZ)
EXA Spectrum Anaiyzer	KEYSIGHT	N9010A	MY551502 46	10Hz~44GHz;	Apr. 04, 2023	Feb. 26,2024	Apr. 03, 2024	Radiation (03CH03-SZ)
Loop Antenna	R&S	HFH2-Z2	100354	9kHz~30MHz	Jun. 28, 2022	Feb. 26,2024	Jun. 27, 2024	Radiation (03CH03-SZ)
Bilog Antenna	TeseQ	CBL6112D	35408	30MHz-2GHz	Aug. 20, 2023	Feb. 26,2024	Aug. 19, 2025	Radiation (03CH03-SZ)
Double Ridge Horn Antenna	SCHWARZBE CK	BBHA9120D	9120D-135 5	1GHz~18GHz	Apr. 08, 2023	Feb. 26,2024	Apr. 07, 2024	Radiation (03CH03-SZ)
SHF-EHF Horn	com-power	AH-840	101071	18Ghz~40GHz	Apr. 08, 2023	Feb. 26,2024	Apr. 07, 2024	Radiation (03CH03-SZ)
Amplifier	Burgeon	BPA-530	102211	0.01Hz ~3000MHz	Oct. 18, 2023	Feb. 26,2024	Oct. 17, 2024	Radiation (03CH03-SZ)
HF Amplifier	MITEQ	TTA1840-35- HG	1871923	18GHz~40GHz	Jul. 07, 2023	Feb. 26,2024	Jul.06, 2024	Radiation (03CH03-SZ)
Amplifier	Agilent Technologies	83017A	MY395013 02	500MHz~26.5G Hz	Dec. 27, 2023	Feb. 26,2024	Dec. 26, 2024	Radiation (03CH03-SZ)
AC Power Source	Chroma	61601	616010002 729	N/A	Oct. 18, 2023	Feb. 26,2024	Oct. 17, 2024	Radiation (03CH03-SZ)
Turn Table	EM	EM1000	N/A	0~360 degree	NCR	Feb. 26,2024	NCR	Radiation (03CH03-SZ)
Antenna Mast	EM	EM1000	N/A	1 m~4 m	NCR	Feb. 26,2024	NCR	Radiation (03CH03-SZ)

NCR: No Calibration Required

6 Measurement Uncertainty

Uncertainty of Conducted Measurement

Test Item	Uncertainty
Conducted Spurious Emission & Bandedge	±1.34 dB
Occupied Channel Bandwidth	±0.012 MHz
Conducted Power	±1.34 dB
Conducted Power Density	±1.32 dB
Peak to Average Ratio	±1.34 dB
Frequency Stability	±1.3 Hz

Uncertainty of Radiated Emission Measurement (9 KHz ~ 30 MHz)

Measuring Uncertainty for a Level of Confidence of 95% (U = 2Uc(y))	3.0
---	-----

Uncertainty of Radiated Emission Measurement (30 MHz ~ 1000 MHz)

Measuring Uncertainty for a Level of Confidence of 95% (U = 2Uc(y))	3.6
---	-----

Uncertainty of Radiated Emission Measurement (1 GHz ~ 40 GHz)

Measuring Uncertainty for a Level of Confidence of 95% (U = 2Uc(y))	3.8
---	-----

----- THE END -----



Appendix A. Test Results of Conducted Test

Test Engineer :	Khan Zhen	Temperature :	22~23°C
		Relative Humidity :	40~42%

FR1 N48 SISO_Ant.7

Transmitter Conducted Output Power And EIRP, $(G_T - L_C) = -1.5\text{dB}$

NR Band	SCS (kHz)	Bandwidth (MHz)	Arfcn	Freq (MHz)	Modulation	RB	Conducted Power(dBm)	EIRP (dBm)	EIRP (W)
48	30	10	637000	3555	DFT-s-OFDM QPSK	1@1	22.21	20.71	0.1178
48	30	10	637000	3555	DFT-s-OFDM 16 QAM	1@1	22.16	20.66	0.1164
48	30	10	641666	3624.99	DFT-s-OFDM QPSK	1@1	22.26	20.76	0.1191
48	30	10	641666	3624.99	DFT-s-OFDM 16 QAM	1@1	21.37	19.87	0.0971
48	30	10	646332	3694.98	DFT-s-OFDM QPSK	1@1	22.07	20.57	0.1140
48	30	10	646332	3694.98	DFT-s-OFDM 16 QAM	1@1	21.15	19.65	0.0923
48	30	20	637334	3560.01	DFT-s-OFDM QPSK	1@1	19.82	18.32	0.0679
48	30	20	637334	3560.01	DFT-s-OFDM 16 QAM	1@1	18.98	17.48	0.0560
48	30	20	641666	3624.99	DFT-s-OFDM QPSK	1@1	22.04	20.54	0.1132
48	30	20	641666	3624.99	DFT-s-OFDM 16 QAM	1@1	21.06	19.56	0.0904
48	30	20	646000	3690	DFT-s-OFDM QPSK	1@1	21.54	20.04	0.1009
48	30	20	646000	3690	DFT-s-OFDM 16 QAM	1@1	20.59	19.09	0.0811
48	30	30	637668	3565.02	DFT-s-OFDM QPSK	1@1	13.3	11.8	0.0151
48	30	30	637668	3565.02	DFT-s-OFDM 16 QAM	1@1	12.84	11.34	0.0136
48	30	30	641666	3624.99	DFT-s-OFDM QPSK	1@1	20.22	18.72	0.0745
48	30	30	641666	3624.99	DFT-s-OFDM 16 QAM	1@1	20.26	18.76	0.0752
48	30	30	645666	3684.99	DFT-s-OFDM QPSK	1@1	13.45	11.95	0.0157
48	30	30	645666	3684.99	DFT-s-OFDM 16 QAM	1@1	13.03	11.53	0.0142
48	30	40	638000	3570	DFT-s-OFDM PI/2 BPSK	50@25	13.3	11.8	0.0151
48	30	40	638000	3570	DFT-s-OFDM PI/2 BPSK	1@1	13.38	11.88	0.0154
48	30	40	638000	3570	DFT-s-OFDM PI/2 BPSK	1@104	13.46	11.96	0.0157
48	30	40	638000	3570	DFT-s-OFDM QPSK	50@25	13.27	11.77	0.0150
48	30	40	638000	3570	DFT-s-OFDM QPSK	1@1	13.38	11.88	0.0154
48	30	40	638000	3570	DFT-s-OFDM QPSK	1@104	13.49	11.99	0.0158
48	30	40	638000	3570	DFT-s-OFDM 16 QAM	50@25	12.81	11.31	0.0135
48	30	40	638000	3570	DFT-s-OFDM 16 QAM	1@1	12.97	11.47	0.0140
48	30	40	638000	3570	DFT-s-OFDM 16 QAM	1@104	13	11.5	0.0141
48	30	40	638000	3570	DFT-s-OFDM 64 QAM	50@25	12.82	11.32	0.0136
48	30	40	638000	3570	DFT-s-OFDM 64 QAM	1@1	12.85	11.35	0.0136
48	30	40	638000	3570	DFT-s-OFDM 64 QAM	1@104	12.91	11.41	0.0138
48	30	40	638000	3570	DFT-s-OFDM 256 QAM	50@25	12.75	11.25	0.0133
48	30	40	638000	3570	DFT-s-OFDM 256 QAM	1@1	12.74	11.24	0.0133
48	30	40	638000	3570	DFT-s-OFDM 256 QAM	1@104	12.8	11.3	0.0135
48	30	40	638000	3570	CP-OFDM QPSK	53@26	12.34	10.84	0.0121
48	30	40	638000	3570	CP-OFDM QPSK	1@1	12.42	10.92	0.0124
48	30	40	638000	3570	CP-OFDM QPSK	1@104	12.51	11.01	0.0126
48	30	40	641666	3624.99	DFT-s-OFDM PI/2 BPSK	50@25	22.89	21.39	0.1377

48	30	40	641666	3624.99	DFT-s-OFDM PI/2 BPSK	1@1	20.14	18.64	0.0731
48	30	40	641666	3624.99	DFT-s-OFDM PI/2 BPSK	1@104	20.06	18.56	0.0718
48	30	40	641666	3624.99	DFT-s-OFDM QPSK	50@25	22.31	20.81	0.1205
48	30	40	641666	3624.99	DFT-s-OFDM QPSK	1@1	20.11	18.61	0.0726
48	30	40	641666	3624.99	DFT-s-OFDM QPSK	1@104	20.08	18.58	0.0721
48	30	40	641666	3624.99	DFT-s-OFDM 16 QAM	50@25	21.32	19.82	0.0959
48	30	40	641666	3624.99	DFT-s-OFDM 16 QAM	1@1	20.18	18.68	0.0738
48	30	40	641666	3624.99	DFT-s-OFDM 16 QAM	1@104	20.14	18.64	0.0731
48	30	40	641666	3624.99	DFT-s-OFDM 64 QAM	50@25	19.8	18.3	0.0676
48	30	40	641666	3624.99	DFT-s-OFDM 64 QAM	1@1	19.86	18.36	0.0685
48	30	40	641666	3624.99	DFT-s-OFDM 64 QAM	1@104	19.15	17.65	0.0582
48	30	40	641666	3624.99	DFT-s-OFDM 256 QAM	50@25	18.16	16.66	0.0463
48	30	40	641666	3624.99	DFT-s-OFDM 256 QAM	1@1	18.14	16.64	0.0461
48	30	40	641666	3624.99	DFT-s-OFDM 256 QAM	1@104	17.39	15.89	0.0388
48	30	40	641666	3624.99	CP-OFDM QPSK	53@26	20.6	19.1	0.0813
48	30	40	641666	3624.99	CP-OFDM QPSK	1@1	20.05	18.55	0.0716
48	30	40	641666	3624.99	CP-OFDM QPSK	1@104	19.96	18.46	0.0701
48	30	40	645332	3679.98	DFT-s-OFDM PI/2 BPSK	50@25	13.33	11.83	0.0152
48	30	40	645332	3679.98	DFT-s-OFDM PI/2 BPSK	1@1	13.34	11.84	0.0153
48	30	40	645332	3679.98	DFT-s-OFDM PI/2 BPSK	1@104	13.59	12.09	0.0162
48	30	40	645332	3679.98	DFT-s-OFDM QPSK	50@25	13.32	11.82	0.0152
48	30	40	645332	3679.98	DFT-s-OFDM QPSK	1@1	13.33	11.83	0.0152
48	30	40	645332	3679.98	DFT-s-OFDM QPSK	1@104	13.57	12.07	0.0161
48	30	40	645332	3679.98	DFT-s-OFDM 16 QAM	50@25	12.81	11.31	0.0135
48	30	40	645332	3679.98	DFT-s-OFDM 16 QAM	1@1	12.89	11.39	0.0138
48	30	40	645332	3679.98	DFT-s-OFDM 16 QAM	1@104	13.12	11.62	0.0145
48	30	40	645332	3679.98	DFT-s-OFDM 64 QAM	50@25	12.8	11.3	0.0135
48	30	40	645332	3679.98	DFT-s-OFDM 64 QAM	1@1	12.79	11.29	0.0135
48	30	40	645332	3679.98	DFT-s-OFDM 64 QAM	1@104	13.09	11.59	0.0144
48	30	40	645332	3679.98	DFT-s-OFDM 256 QAM	50@25	12.73	11.23	0.0133
48	30	40	645332	3679.98	DFT-s-OFDM 256 QAM	1@1	12.73	11.23	0.0133
48	30	40	645332	3679.98	DFT-s-OFDM 256 QAM	1@104	12.97	11.47	0.0140
48	30	40	645332	3679.98	CP-OFDM QPSK	53@26	12.33	10.83	0.0121
48	30	40	645332	3679.98	CP-OFDM QPSK	1@1	12.27	10.77	0.0119
48	30	40	645332	3679.98	CP-OFDM QPSK	1@104	12.5	11	0.0126

Frequency Stability

NR Band	SCS (kHz)	Bandwidth (MHz)	Arfcn	Freq (MHz)	Modulation	RB	Deviation (ppm)	Verdict	Environment
48	30	20	641666	3624.99	DFT-s-OFDM QPSK	50@0	0.0061	PASS	NV
48	30	20	641666	3624.99	DFT-s-OFDM QPSK	50@0	0.0047	PASS	LV
48	30	20	641666	3624.99	DFT-s-OFDM QPSK	50@0	0.0050	PASS	HV
48	30	20	641666	3624.99	DFT-s-OFDM QPSK	50@0	0.0049	PASS	-30°C
48	30	20	641666	3624.99	DFT-s-OFDM QPSK	50@0	0.0034	PASS	-20°C
48	30	20	641666	3624.99	DFT-s-OFDM QPSK	50@0	0.0067	PASS	-10°C
48	30	20	641666	3624.99	DFT-s-OFDM QPSK	50@0	0.0032	PASS	0°C
48	30	20	641666	3624.99	DFT-s-OFDM QPSK	50@0	0.0036	PASS	10°C
48	30	20	641666	3624.99	DFT-s-OFDM QPSK	50@0	0.0061	PASS	20°C
48	30	20	641666	3624.99	DFT-s-OFDM QPSK	50@0	0.0064	PASS	30°C
48	30	20	641666	3624.99	DFT-s-OFDM QPSK	50@0	0.0059	PASS	40°C
48	30	20	641666	3624.99	DFT-s-OFDM QPSK	50@0	0.0047	PASS	50°C

Occupied Bandwidth

NR Band	SCS (kHz)	Bandwidth (MHz)	Arfcn	Freq (MHz)	Modulation	RB	OBW (MHz)	26dB BW (MHz)
48	30	10	641666	3624.99	CP-OFDM QPSK	24@0	8.5722	9.483
48	30	10	641666	3624.99	CP-OFDM 16 QAM	24@0	8.5855	9.614
48	30	10	641666	3624.99	CP-OFDM 64 QAM	24@0	8.5615	9.586
48	30	10	641666	3624.99	CP-OFDM 256 QAM	24@0	8.5758	9.227
48	30	20	641666	3624.99	CP-OFDM QPSK	51@0	18.214	19.4
48	30	20	641666	3624.99	CP-OFDM 16 QAM	51@0	18.143	19.42
48	30	20	641666	3624.99	CP-OFDM 64 QAM	51@0	18.259	19.67
48	30	20	641666	3624.99	CP-OFDM 256 QAM	51@0	18.184	19.49
48	30	30	641666	3624.99	CP-OFDM QPSK	78@0	27.784	29.24
48	30	30	641666	3624.99	CP-OFDM 16 QAM	78@0	27.876	29.49
48	30	30	641666	3624.99	CP-OFDM 64 QAM	78@0	27.821	29.16
48	30	30	641666	3624.99	CP-OFDM 256 QAM	78@0	27.828	28.75
48	30	40	641666	3624.99	CP-OFDM QPSK	106@0	37.84	39.21
48	30	40	641666	3624.99	CP-OFDM 16 QAM	106@0	37.755	39.48
48	30	40	641666	3624.99	CP-OFDM 64 QAM	106@0	37.868	39.22
48	30	40	641666	3624.99	CP-OFDM 256 QAM	106@0	37.841	39.47

N48(10M)_CP-OFDM_QPSK_Outer_Full_Mid_CH



N48(10M)_CP-OFDM_16QAM_Outer_Full_Mid_CH

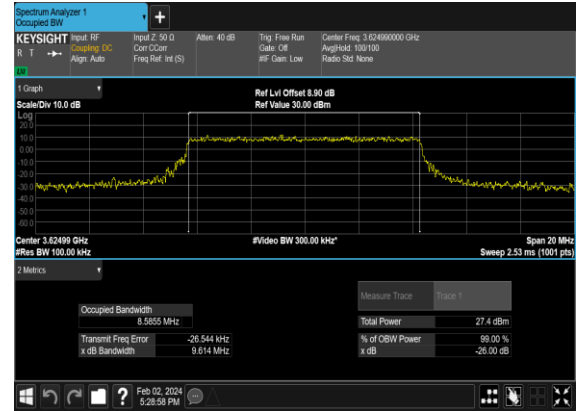

N48(10M)_CP-OFDM_64QAM_Outer_Full_Mid_CH



N48(10M)_CP-OFDM_256QAM_Outer_Full_Mid_CH



N48(20M)_CP-OFDM_QPSK_Outer_Full_Mid_CH

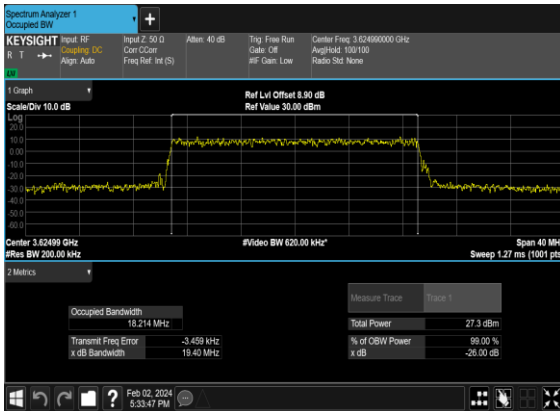

N48(20M)_CP-OFDM_16QAM_Outer_Full_Mid_CH

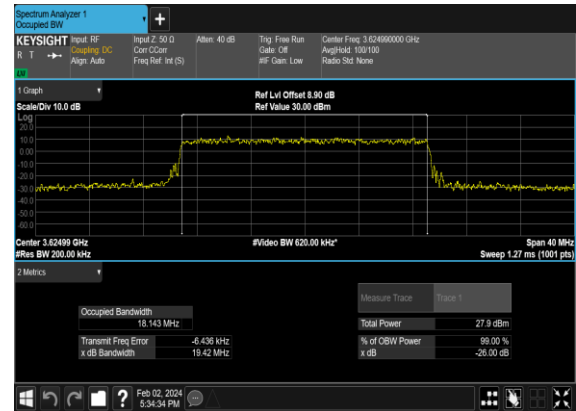

N48(20M)_CP-OFDM_64 QAM_Outer_Full_Mid_CH

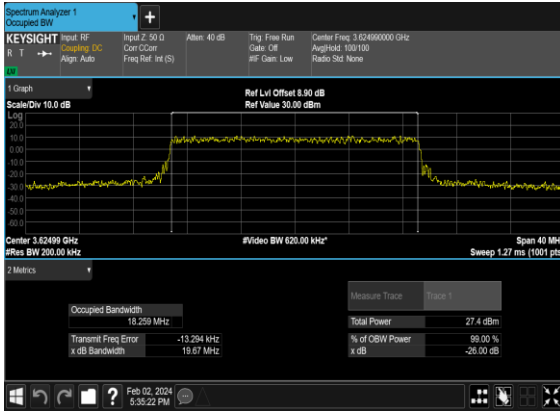

N48(20M)_CP-OFDM_256 QAM_Outer_Full_Mid_CH

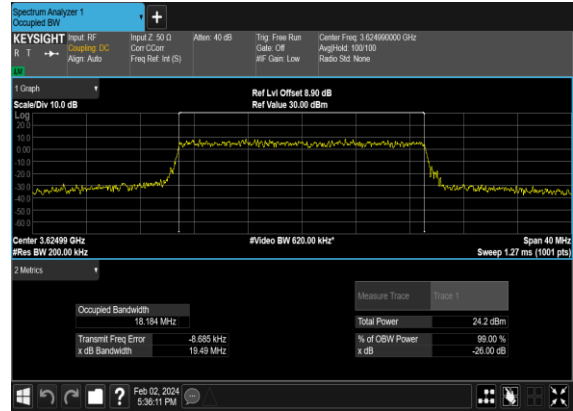

N48(30M)_CP- OFDM_QPSK_Outer_Full_Mid_CH

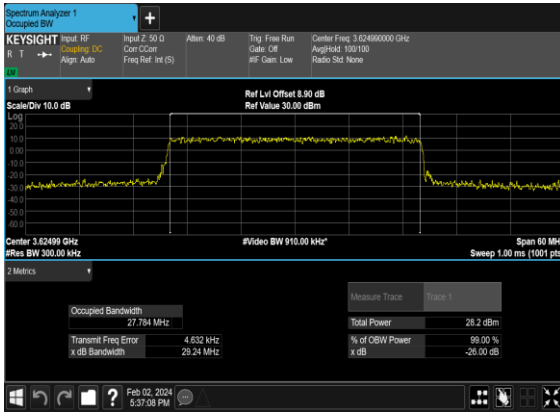

N48(30M)_CP-OFDM_16 QAM_Outer_Full_Mid_CH



N48(30M)_CP-OFDM_64 QAM_Outer_Full_Mid_CH

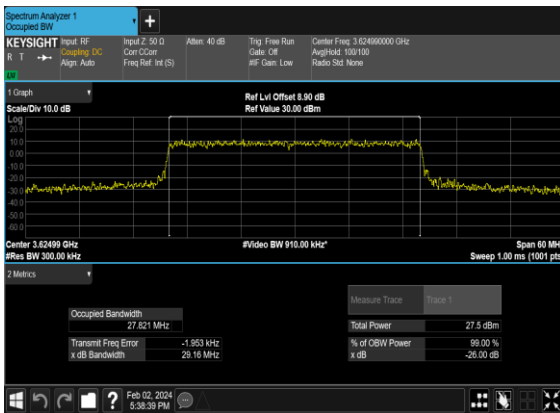

N48(30M)_CP-OFDM_256 QAM_Outer_Full_Mid_CH

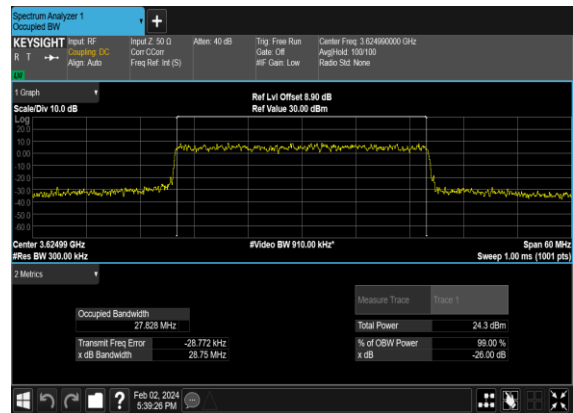

N48(40M)_CP-OFDM_QPSK_Outer_Full_Mid_CH

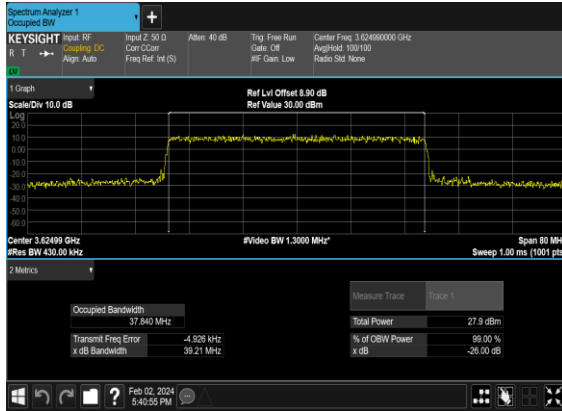

N48(40M)_CP-OFDM_16QAM_Outer_Full_Mid_CH

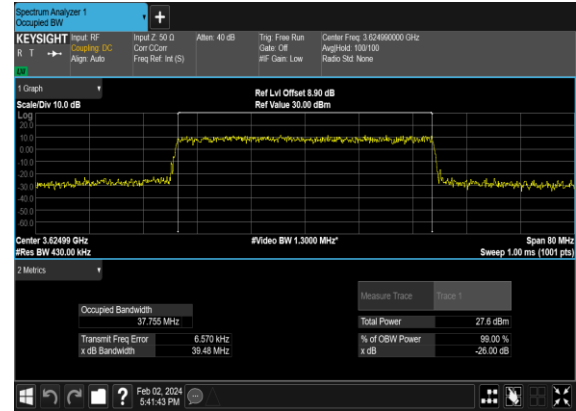

N48(40M)_CP-OFDM_64QAM_Outer_Full_Mid_CH



N48(40M)_CP-OFDM_256QAM_Outer_Full_Mid_CH

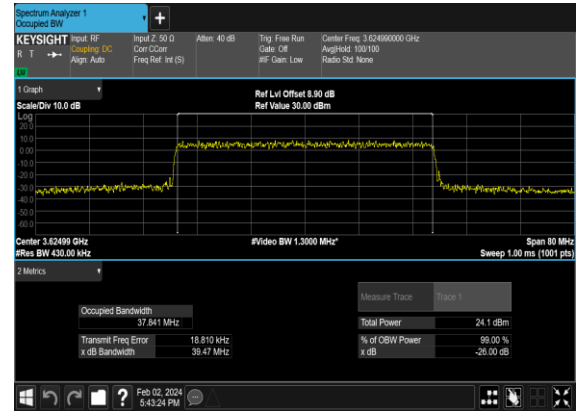

Adjacent Channel Leakage Ratio

NR Band	SCS (kHz)	Bandwidth (MHz)	Arfcn	Freq (MHz)	Modulation	RB	Lower Margin	Upper Margin	Result	Verdict
48	30	10	637000	3555.0	DFT-s-OFDM PI/2 BPSK	24@0	-11.17	-11.43	see graph	PASS
48	30	10	637000	3555.0	DFT-s-OFDM PI/2 BPSK	1@0	-11.74	-26.98	see graph	PASS
48	30	10	637000	3555.0	DFT-s-OFDM PI/2 BPSK	1@23	-26.93	-12.72	see graph	PASS
48	30	10	637000	3555.0	DFT-s-OFDM QPSK	24@0	-9.07	-9.58	see graph	PASS
48	30	10	637000	3555.0	DFT-s-OFDM QPSK	1@0	-11.92	-27.3	see graph	PASS
48	30	10	637000	3555.0	DFT-s-OFDM QPSK	1@23	-27.11	-11.77	see graph	PASS
48	30	10	641666	3624.99	DFT-s-OFDM PI/2 BPSK	24@0	-11.31	-11.86	see graph	PASS
48	30	10	641666	3624.99	DFT-s-OFDM PI/2 BPSK	1@0	-14.87	-25.61	see graph	PASS
48	30	10	641666	3624.99	DFT-s-OFDM PI/2 BPSK	1@23	-25.11	-15.4	see graph	PASS
48	30	10	641666	3624.99	DFT-s-OFDM QPSK	24@0	-8.95	-11.2	see graph	PASS
48	30	10	641666	3624.99	DFT-s-OFDM QPSK	1@0	-14.36	-25.78	see graph	PASS
48	30	10	641666	3624.99	DFT-s-OFDM QPSK	1@23	-24.37	-13.02	see graph	PASS
48	30	10	646332	3694.98	DFT-s-OFDM PI/2 BPSK	24@0	-12.22	-12.22	see graph	PASS
48	30	10	646332	3694.98	DFT-s-OFDM PI/2 BPSK	1@0	-11.26	-23.85	see graph	PASS
48	30	10	646332	3694.98	DFT-s-OFDM PI/2 BPSK	1@23	-23.9	-12.7	see graph	PASS
48	30	10	646332	3694.98	DFT-s-OFDM QPSK	24@0	-10.36	-11.16	see graph	PASS
48	30	10	646332	3694.98	DFT-s-OFDM QPSK	1@0	-11.72	-24.36	see graph	PASS
48	30	10	646332	3694.98	DFT-s-OFDM QPSK	1@23	-23.48	-10.91	see graph	PASS
48	30	20	637334	3560.01	DFT-s-OFDM PI/2 BPSK	50@0	-12.79	-13.7	see graph	PASS
48	30	20	637334	3560.01	DFT-s-OFDM PI/2 BPSK	1@0	-11.65	-23.18	see graph	PASS
48	30	20	637334	3560.01	DFT-s-OFDM PI/2 BPSK	1@50	-25.24	-14.12	see graph	PASS
48	30	20	637334	3560.01	DFT-s-OFDM QPSK	50@0	-10.07	-10.73	see graph	PASS
48	30	20	637334	3560.01	DFT-s-OFDM QPSK	1@0	-13.33	-22.48	see graph	PASS
48	30	20	637334	3560.01	DFT-s-OFDM QPSK	1@50	-24.82	-13.91	see graph	PASS
48	30	20	641666	3624.99	DFT-s-OFDM PI/2 BPSK	50@0	-11.49	-13.42	see graph	PASS
48	30	20	641666	3624.99	DFT-s-OFDM PI/2 BPSK	1@0	-12.21	-23.4	see graph	PASS
48	30	20	641666	3624.99	DFT-s-OFDM PI/2 BPSK	1@50	-21.65	-13.17	see graph	PASS
48	30	20	641666	3624.99	DFT-s-OFDM QPSK	50@0	-10.08	-11.92	see graph	PASS
48	30	20	641666	3624.99	DFT-s-OFDM QPSK	1@0	-12.13	-22.18	see graph	PASS
48	30	20	641666	3624.99	DFT-s-OFDM QPSK	1@50	-20.61	-12.6	see graph	PASS
48	30	20	646000	3690.0	DFT-s-OFDM PI/2 BPSK	50@0	-12.45	-13.97	see graph	PASS
48	30	20	646000	3690.0	DFT-s-OFDM PI/2 BPSK	1@0	-12.35	-21.28	see graph	PASS
48	30	20	646000	3690.0	DFT-s-OFDM PI/2 BPSK	1@50	-21.13	-14.22	see graph	PASS

48	30	20	646000	3690.0	DFT-s-OFDM QPSK	50@0	-10.36	-11.95	see graph	PASS
48	30	20	646000	3690.0	DFT-s-OFDM QPSK	1@0	-12.31	-21.28	see graph	PASS
48	30	20	646000	3690.0	DFT-s-OFDM QPSK	1@50	-20.32	-13.23	see graph	PASS
48	30	40	638000	3570.0	DFT-s-OFDM PI/2 BPSK	100@0	-11.24	-10.99	see graph	PASS
48	30	40	638000	3570.0	DFT-s-OFDM PI/2 BPSK	1@0	-10.88	-11.88	see graph	PASS
48	30	40	638000	3570.0	DFT-s-OFDM PI/2 BPSK	1@105	-12.56	-11.04	see graph	PASS
48	30	40	638000	3570.0	DFT-s-OFDM QPSK	100@0	-9.95	-10.15	see graph	PASS
48	30	40	638000	3570.0	DFT-s-OFDM QPSK	1@0	-9.67	-10.13	see graph	PASS
48	30	40	638000	3570.0	DFT-s-OFDM QPSK	1@105	-13.17	-11.62	see graph	PASS
48	30	40	641666	3624.99	DFT-s-OFDM PI/2 BPSK	100@0	-11.76	-13.96	see graph	PASS
48	30	40	641666	3624.99	DFT-s-OFDM PI/2 BPSK	1@0	-14.6	-18.58	see graph	PASS
48	30	40	641666	3624.99	DFT-s-OFDM PI/2 BPSK	1@105	-16.87	-14.77	see graph	PASS
48	30	40	641666	3624.99	DFT-s-OFDM QPSK	100@0	-9.33	-12.27	see graph	PASS
48	30	40	641666	3624.99	DFT-s-OFDM QPSK	1@0	-14.22	-17.19	see graph	PASS
48	30	40	641666	3624.99	DFT-s-OFDM QPSK	1@105	-18.96	-15.68	see graph	PASS
48	30	40	645332	3679.98	DFT-s-OFDM PI/2 BPSK	100@0	-10.54	-10.16	see graph	PASS
48	30	40	645332	3679.98	DFT-s-OFDM PI/2 BPSK	1@0	-10.05	-10.58	see graph	PASS
48	30	40	645332	3679.98	DFT-s-OFDM PI/2 BPSK	1@105	-11.94	-10.48	see graph	PASS
48	30	40	645332	3679.98	DFT-s-OFDM QPSK	100@0	-9.48	-9.61	see graph	PASS
48	30	40	645332	3679.98	DFT-s-OFDM QPSK	1@0	-10.53	-10.52	see graph	PASS
48	30	40	645332	3679.98	DFT-s-OFDM QPSK	1@105	-10.25	-8.66	see graph	PASS

N48(10M)_DFT-s-OFDM_PI_2-BPSK_Outer_Full_Low_CH

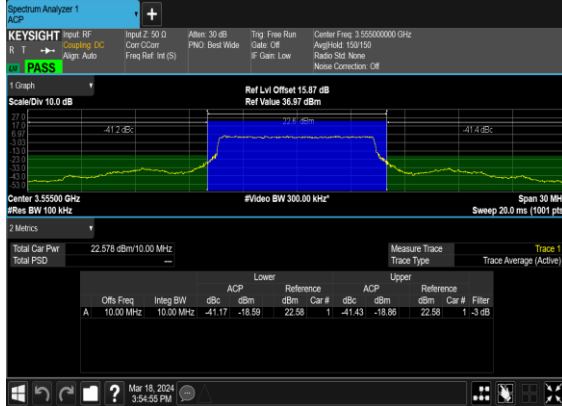

N48(10M)_DFT-s-OFDM_PI_2-BPSK_Edge_1RB_Left_Low_CH

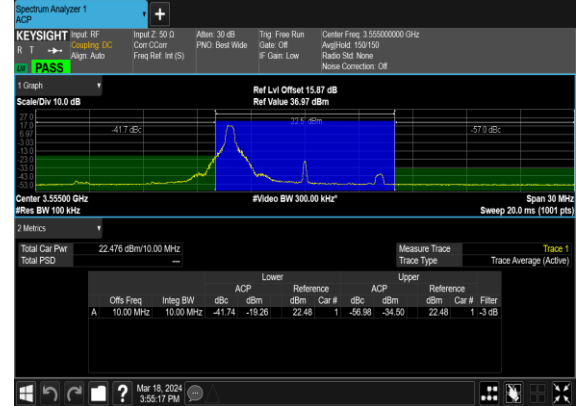

N48(10M)_DFT-s-OFDM_PI_2-BPSK_Edge_1RB_Right_Low_CH

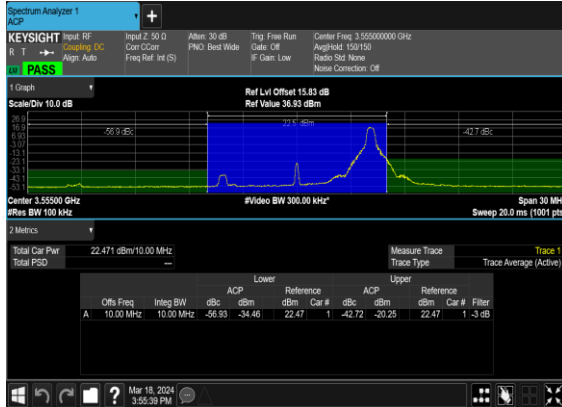

N48(10M)_DFT-s-OFDM_QPSK_Outer_Full_Low_CH

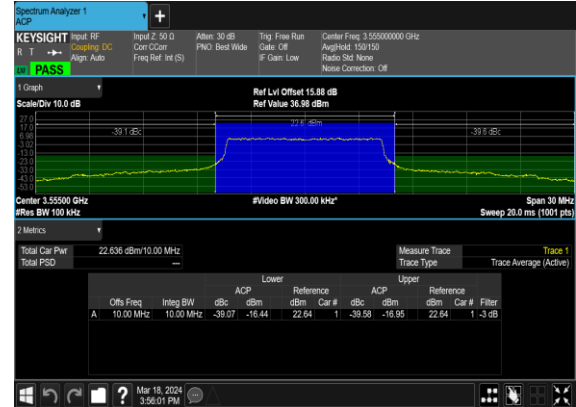

N48(10M)_DFT-s-OFDM_QPSK_Edge_1RB_Left_Low_CH

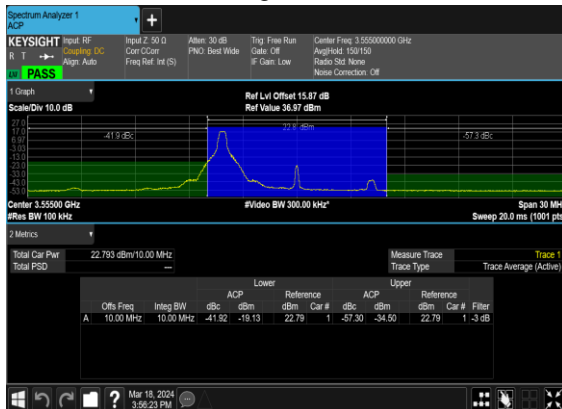

N48(10M)_DFT-s-OFDM_QPSK_Edge_1RB_Right_Low_CH

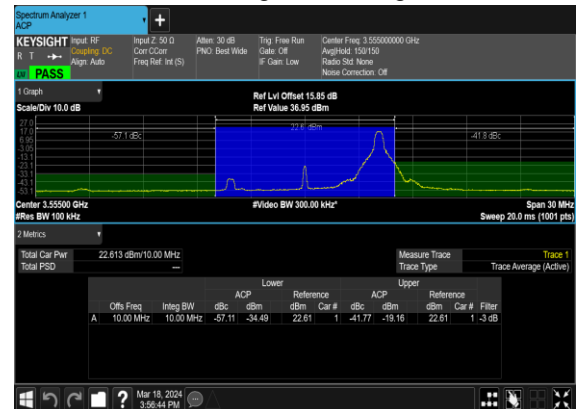

N48(10M)_DFT-s-OFDM_PI_2-BPSK_Outer_Full_Mid_CH



N48(10M)_DFT-s-OFDM_PI_2-BPSK_Edge_1RB_Left_Mid_CH

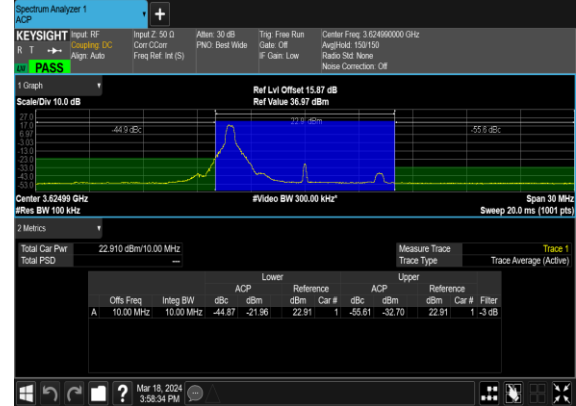

N48(10M)_DFT-s-OFDM_PI_2-BPSK_Edge_1RB_Right_Mid_CH



N48(10M)_DFT-s-OFDM_QPSK_Outer_Full_Mid_CH

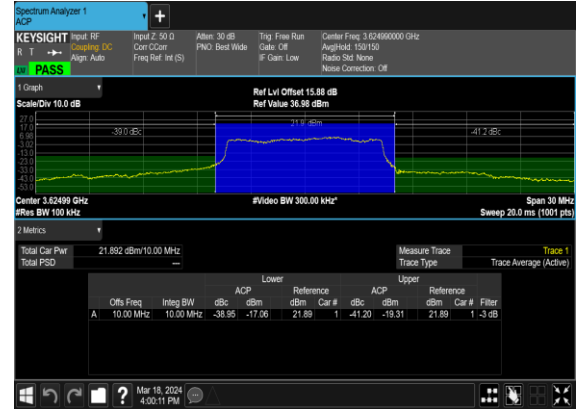

N48(10M)_DFT-s-OFDM_QPSK_Edge_1RB_Left_Mid_CH

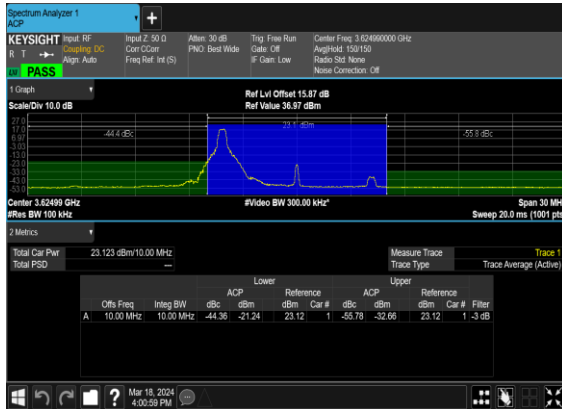

N48(10M)_DFT-s-OFDM_QPSK_Edge_1RB_Right_Mid_CH

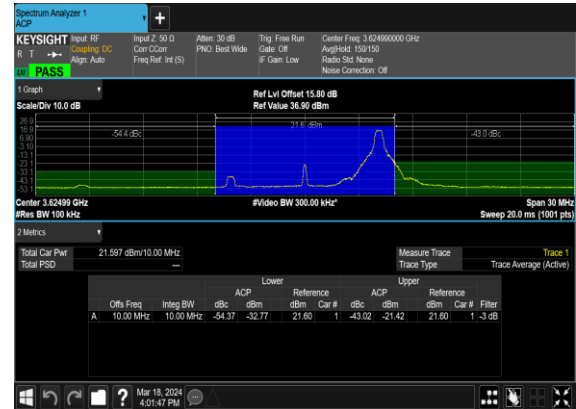

N48(10M)_DFT-s-OFDM_PI_2-BPSK_Outer_Full_High_CH

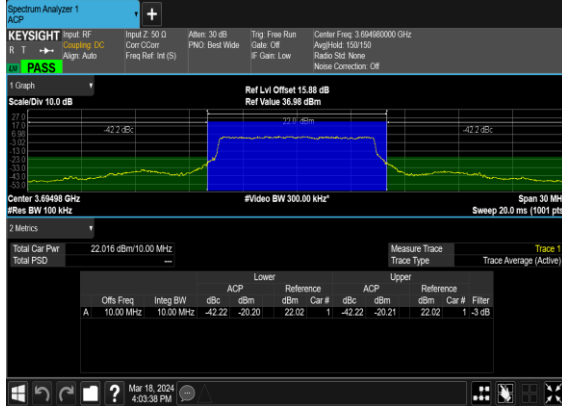

N48(10M)_DFT-s-OFDM_PI_2-BPSK_Edge_1RB_Left_High_CH

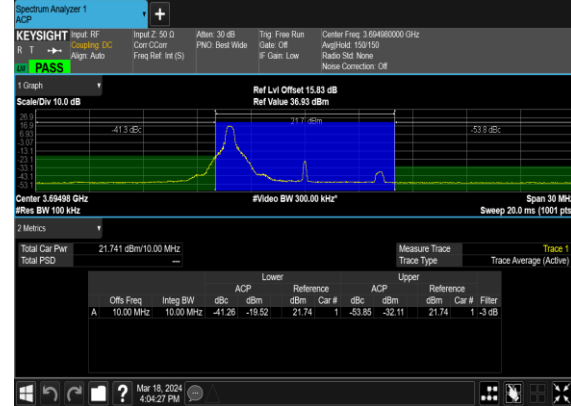

N48(10M)_DFT-s-OFDM_PI_2-BPSK_Edge_1RB_Right_High_CH

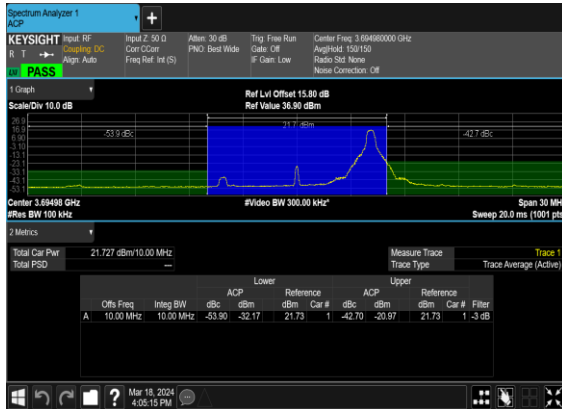

N48(10M)_DFT-s-OFDM_QPSK_Outer_Full_High_CH

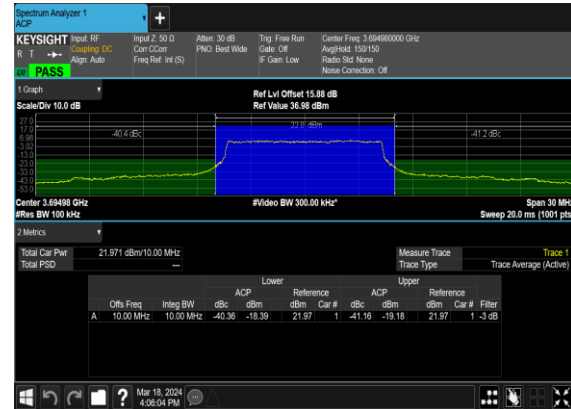

N48(10M)_DFT-s-OFDM_QPSK_Edge_1RB_Left_High_CH

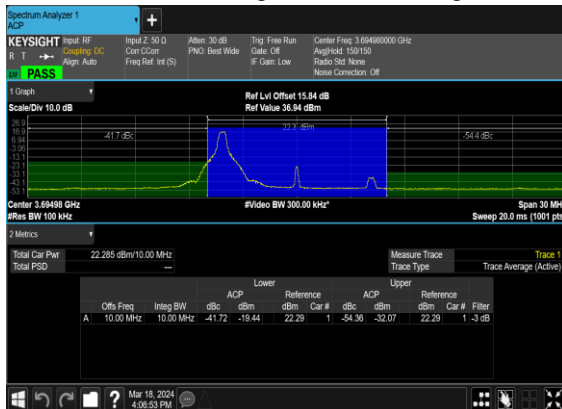

N48(10M)_DFT-s-OFDM_QPSK_Edge_1RB_Right_High_CH

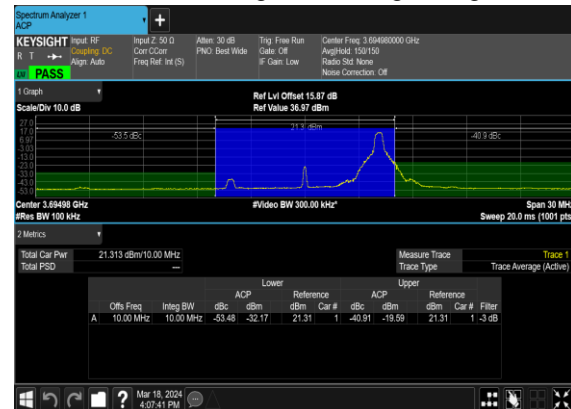

N48(20M)_DFT-s-OFDM_PI_2-BPSK_Outer_Full_Low_CH

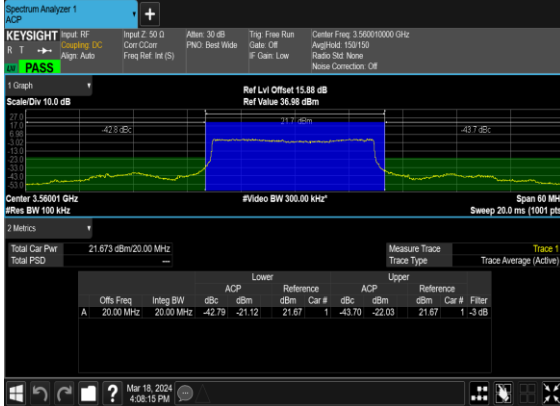

N48(20M)_DFT-s-OFDM_PI_2-BPSK_Edge_1RB_Left_Low_CH

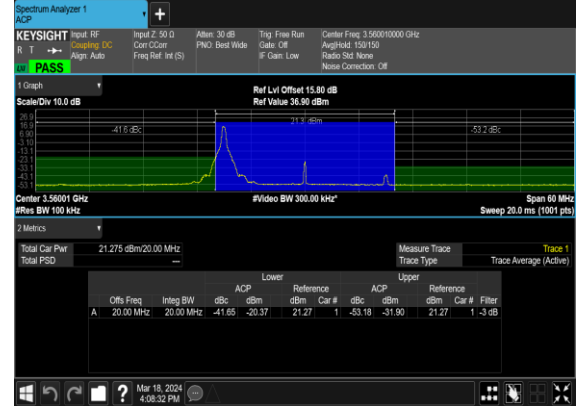

N48(20M)_DFT-s-OFDM_PI_2-BPSK_Edge_1RB_Right_Low_CH

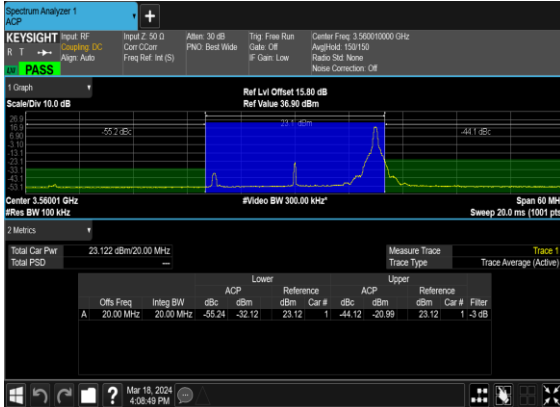

N48(20M)_DFT-s-OFDM_QPSK_Outer_Full_Low_CH

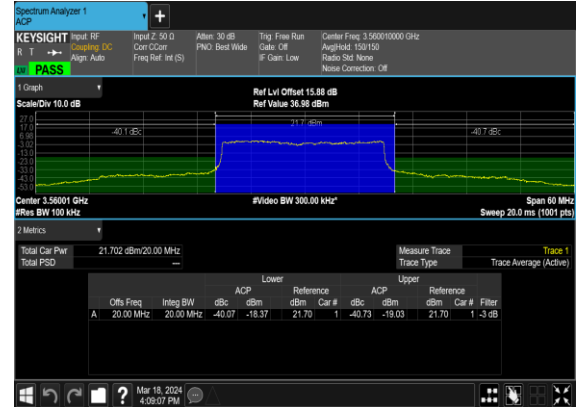

N48(20M)_DFT-s-OFDM_QPSK_Edge_1RB_Left_Low_CH

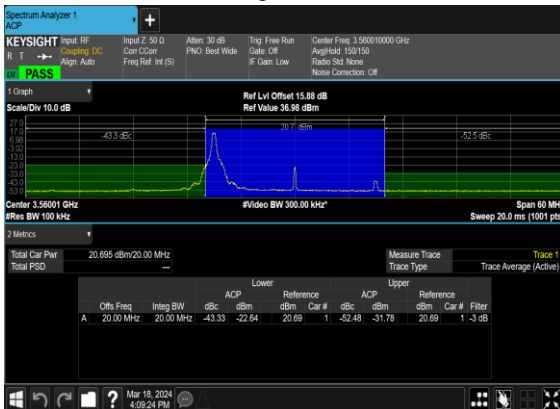

N48(20M)_DFT-s-OFDM_QPSK_Edge_1RB_Right_Low_CH

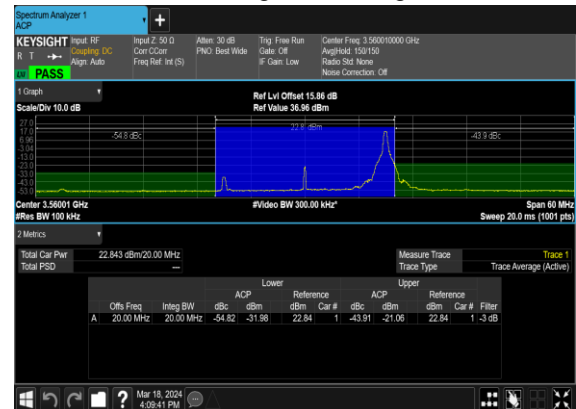

N48(20M)_DFT-s-OFDM_PI_2-BPSK_Outer_Full_Mid_CH

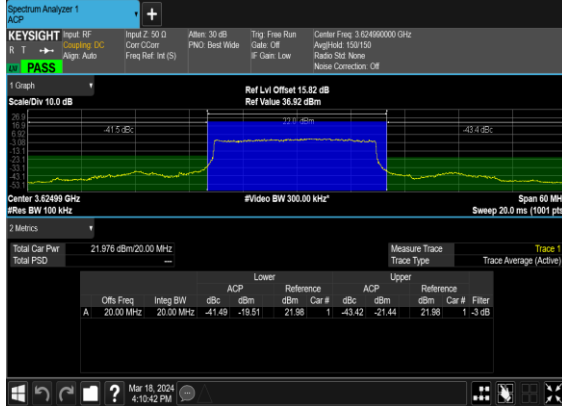

N48(20M)_DFT-s-OFDM_PI_2-BPSK_Edge_1RB_Left_Mid_CH

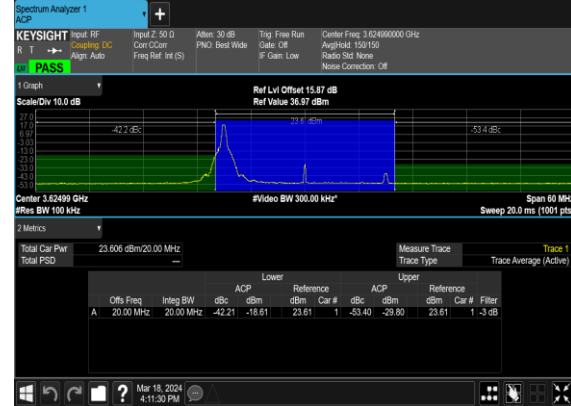

N48(20M)_DFT-s-OFDM_PI_2-BPSK_Edge_1RB_Right_Mid_CH

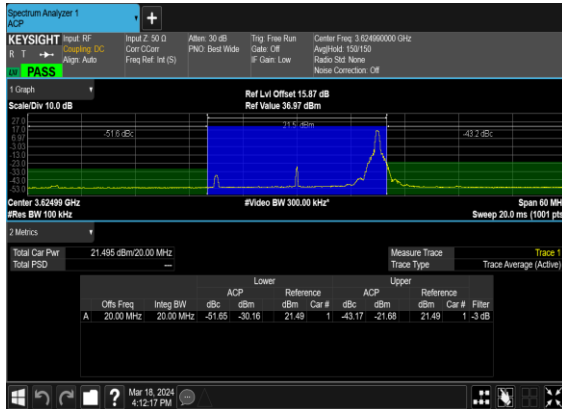

N48(20M)_DFT-s-OFDM_QPSK_Outer_Full_Mid_CH

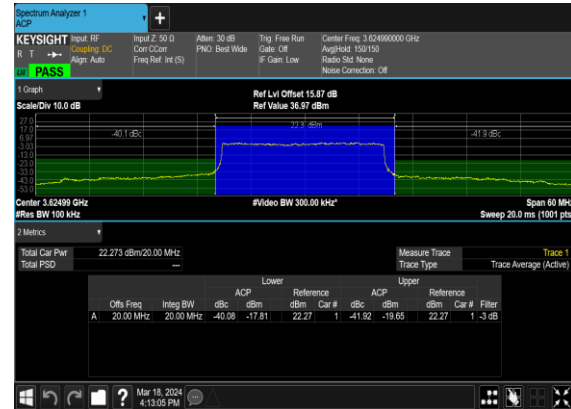

N48(20M)_DFT-s-OFDM_QPSK_Edge_1RB_Left_Mid_CH

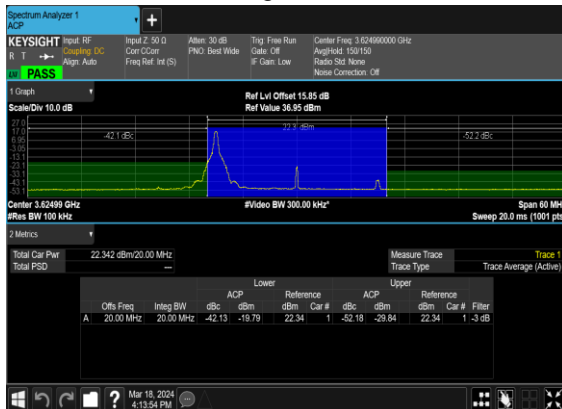

N48(20M)_DFT-s-OFDM_QPSK_Edge_1RB_Right_Mid_CH

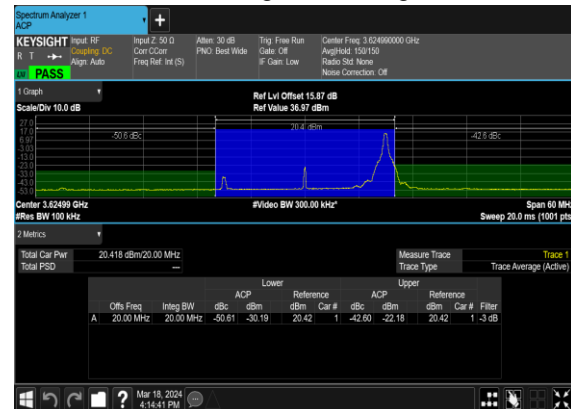

N48(20M)_DFT-s-OFDM_PI_2-BPSK_Outer_Full_High_CH

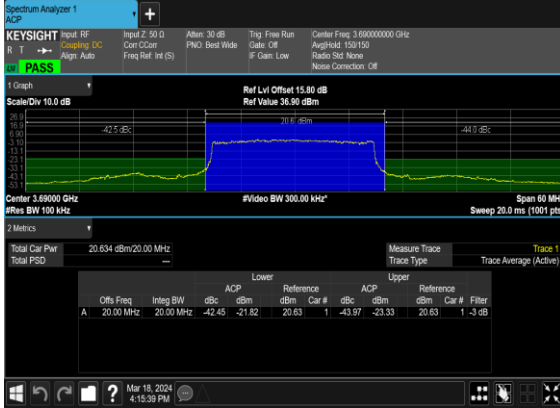

N48(20M)_DFT-s-OFDM_PI_2-BPSK_Edge_1RB_Left_High_CH

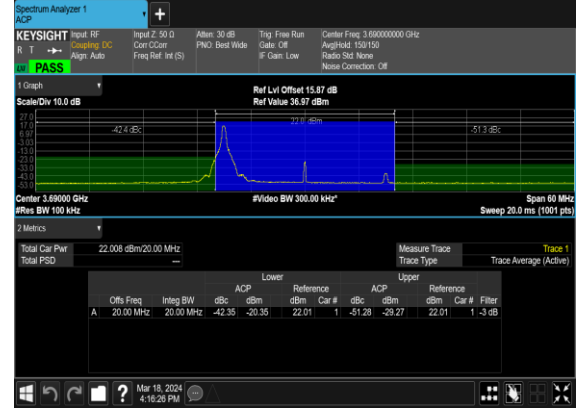

N48(20M)_DFT-s-OFDM_PI_2-BPSK_Edge_1RB_Right_High_CH

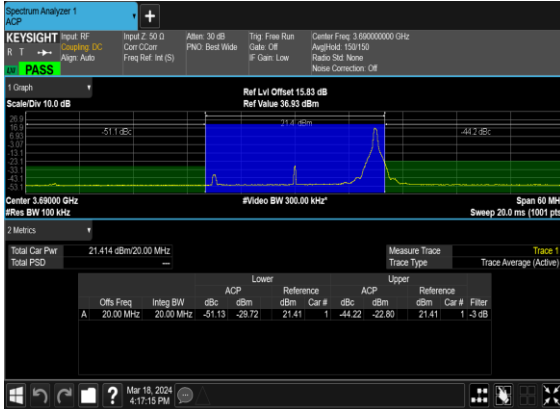

N48(20M)_DFT-s-OFDM_QPSK_Outer_Full_High_CH

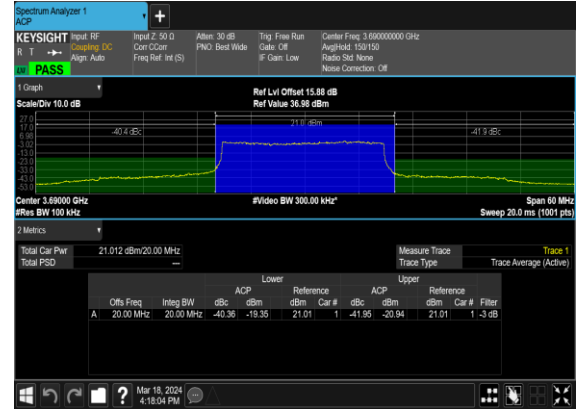

N48(20M)_DFT-s-OFDM_QPSK_Edge_1RB_Left_High_CH

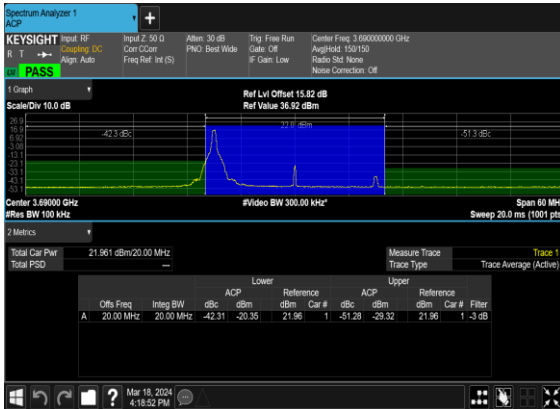

N48(20M)_DFT-s-OFDM_QPSK_Edge_1RB_Right_High_CH

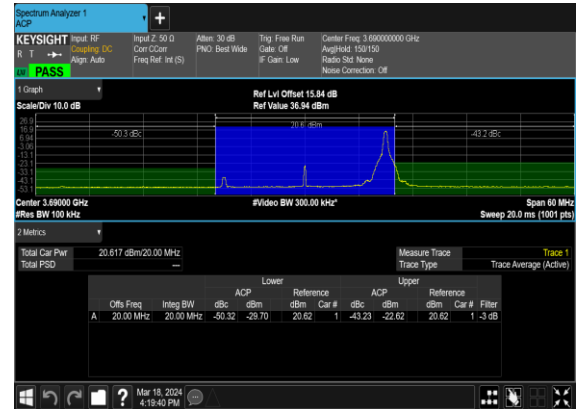

N48(40M)_DFT-s-OFDM_PI_2-BPSK_Outer_Full_Low_CH

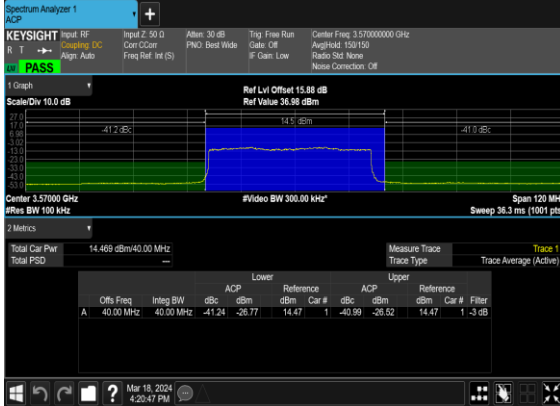

N48(40M)_DFT-s-OFDM_PI_2-BPSK_Edge_1RB_Left_Low_CH

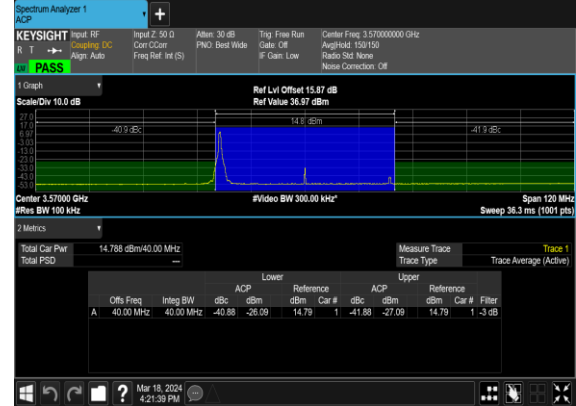

N48(40M)_DFT-s-OFDM_PI_2-BPSK_Edge_1RB_Right_Low_CH

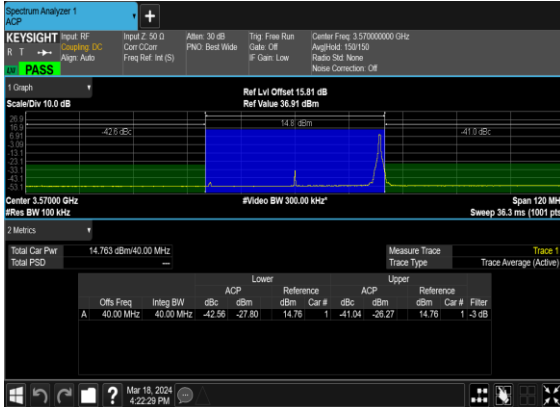

N48(40M)_DFT-s-OFDM_QPSK_Outer_Full_Low_CH

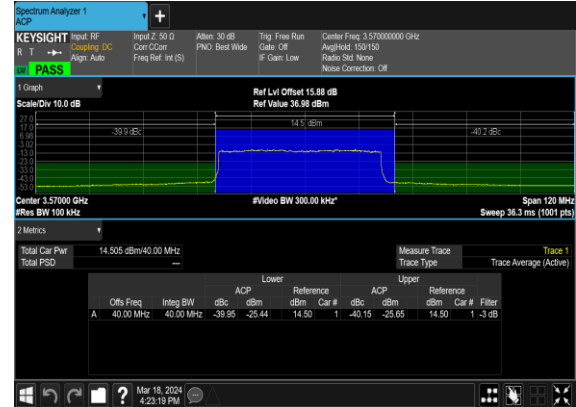

N48(40M)_DFT-s-OFDM_QPSK_Edge_1RB_Left_Low_CH

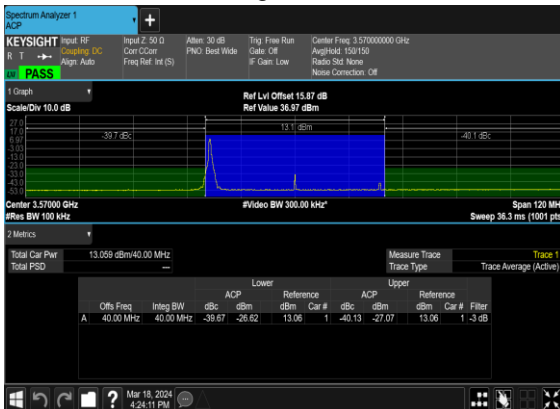

N48(40M)_DFT-s-OFDM_QPSK_Edge_1RB_Right_Low_CH

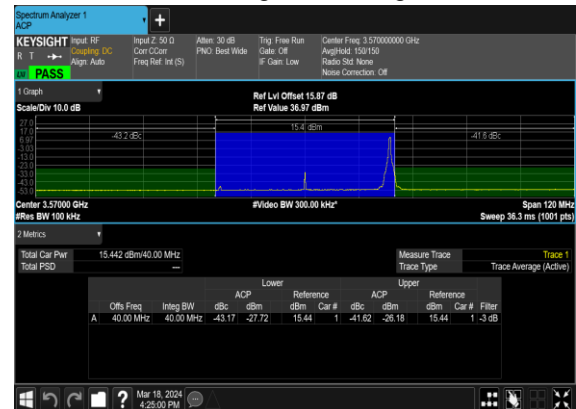

N48(40M)_DFT-s-OFDM_PI_2-
BPSK_Outer_Full_Mid_CH

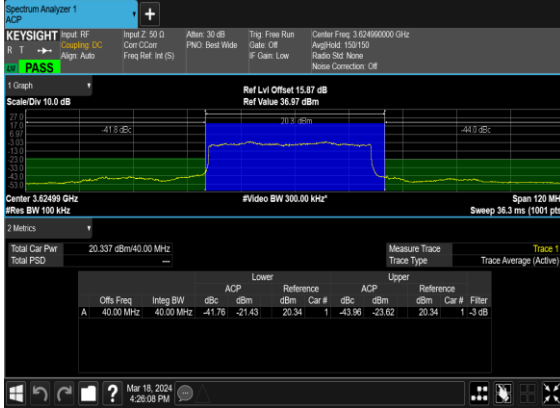

N48(40M)_DFT-s-OFDM_PI_2-
BPSK_Edge_1RB_Left_Mid_CH

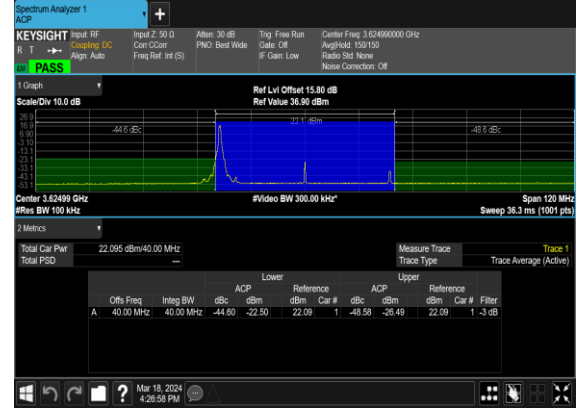

N48(40M)_DFT-s-OFDM_PI_2-
BPSK_Edge_1RB_Right_Mid_CH



N48(40M)_DFT-s-OFDM_QPSK_Outer_Full_Mid_CH

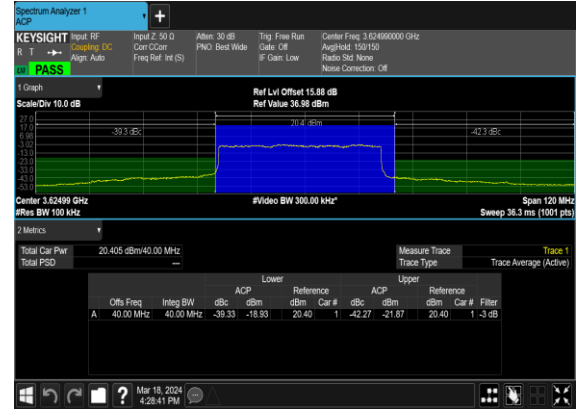

N48(40M)_DFT-s-OFDM_QPSK_Edge_1RB_Left_Mid_CH

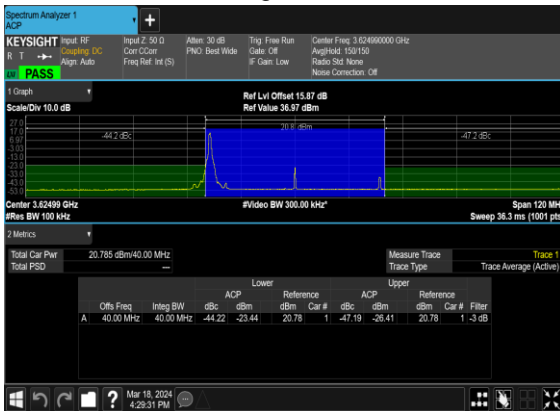

N48(40M)_DFT-s-OFDM_QPSK_Edge_1RB_Right_Mid_CH

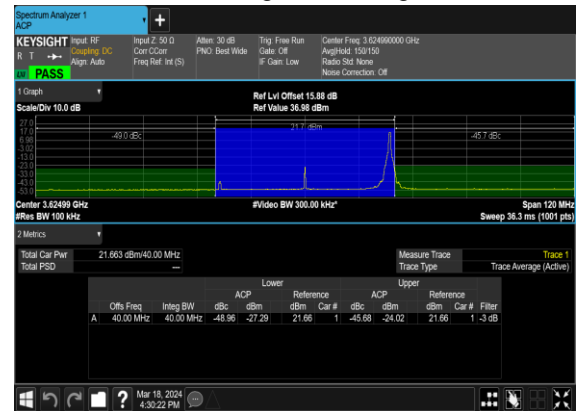

N48(40M)_DFT-s-OFDM_PI_2-BPSK_Outer_Full_High_CH

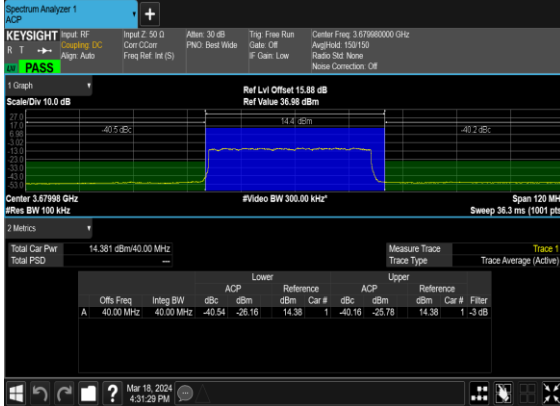

N48(40M)_DFT-s-OFDM_PI_2-BPSK_Edge_1RB_Left_High_CH

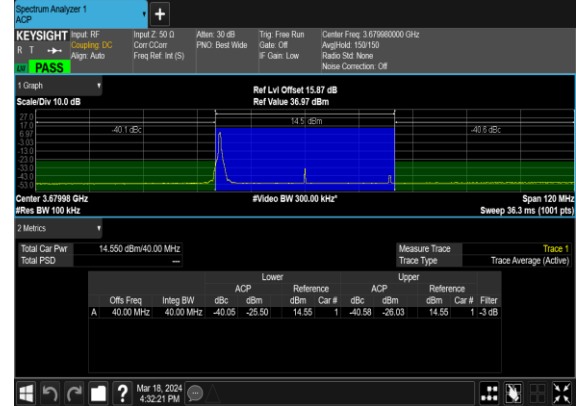

N48(40M)_DFT-s-OFDM_PI_2-BPSK_Edge_1RB_Right_High_CH



N48(40M)_DFT-s-OFDM_QPSK_Outer_Full_High_CH

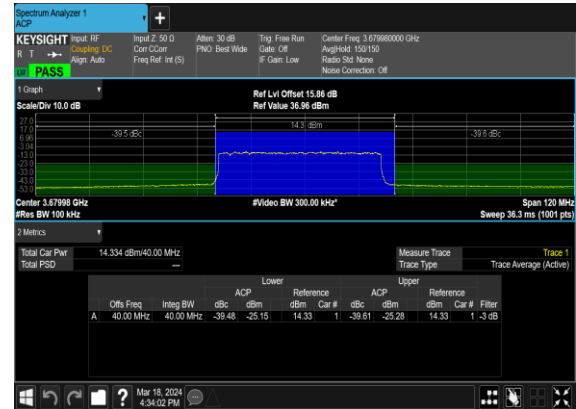

N48(40M)_DFT-s-OFDM_QPSK_Edge_1RB_Left_High_CH

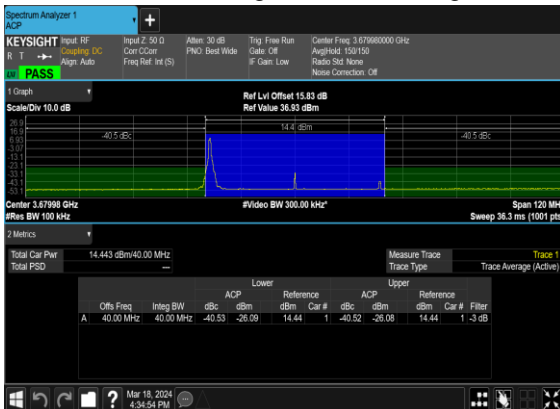

N48(40M)_DFT-s-OFDM_QPSK_Edge_1RB_Right_High_CH

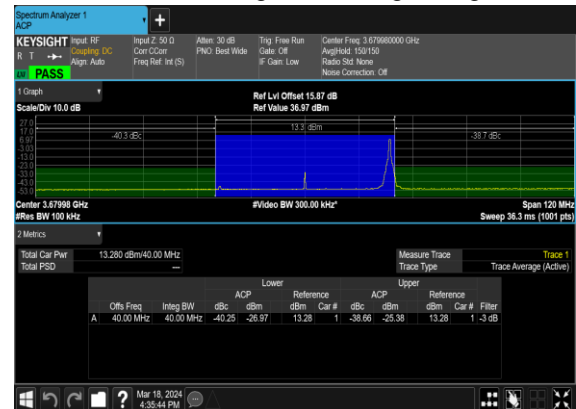

Conducted Spurious Emissions

NR Band	SCS (kHz)	Bandwidth (MHz)	Arfcn	Freq (MHz)	Modulation	RB	Result	Verdict
48	30	10	637000	3555.0	DFT-s-OFDM BPSK	1@0	see graph	---
48	30	10	637000	3555.0	DFT-s-OFDM BPSK	1@0	see graph	PASS
48	30	10	637000	3555.0	DFT-s-OFDM BPSK	1@0	see graph	PASS
48	30	10	637000	3555.0	DFT-s-OFDM QPSK	1@0	see graph	---
48	30	10	637000	3555.0	DFT-s-OFDM QPSK	1@0	see graph	PASS
48	30	10	637000	3555.0	DFT-s-OFDM QPSK	1@0	see graph	PASS
48	30	10	641666	3624.99	DFT-s-OFDM BPSK	1@0	see graph	---
48	30	10	641666	3624.99	DFT-s-OFDM BPSK	1@0	see graph	PASS
48	30	10	641666	3624.99	DFT-s-OFDM BPSK	1@0	see graph	PASS
48	30	10	641666	3624.99	DFT-s-OFDM QPSK	1@0	see graph	---
48	30	10	641666	3624.99	DFT-s-OFDM QPSK	1@0	see graph	PASS
48	30	10	641666	3624.99	DFT-s-OFDM QPSK	1@0	see graph	PASS
48	30	10	646332	3694.98	DFT-s-OFDM BPSK	1@0	see graph	---
48	30	10	646332	3694.98	DFT-s-OFDM BPSK	1@0	see graph	PASS
48	30	10	646332	3694.98	DFT-s-OFDM BPSK	1@0	see graph	PASS
48	30	10	646332	3694.98	DFT-s-OFDM QPSK	1@0	see graph	---
48	30	10	646332	3694.98	DFT-s-OFDM QPSK	1@0	see graph	PASS
48	30	10	646332	3694.98	DFT-s-OFDM QPSK	1@0	see graph	PASS
48	30	20	637334	3560.01	DFT-s-OFDM BPSK	1@0	see graph	---
48	30	20	637334	3560.01	DFT-s-OFDM BPSK	1@0	see graph	PASS
48	30	20	637334	3560.01	DFT-s-OFDM BPSK	1@0	see graph	PASS
48	30	20	637334	3560.01	DFT-s-OFDM QPSK	1@0	see graph	---
48	30	20	637334	3560.01	DFT-s-OFDM QPSK	1@0	see graph	PASS
48	30	20	637334	3560.01	DFT-s-OFDM QPSK	1@0	see graph	PASS
48	30	20	641666	3624.99	DFT-s-OFDM BPSK	1@0	see graph	---
48	30	20	641666	3624.99	DFT-s-OFDM BPSK	1@0	see graph	PASS
48	30	20	641666	3624.99	DFT-s-OFDM BPSK	1@0	see graph	PASS
48	30	20	641666	3624.99	DFT-s-OFDM QPSK	1@0	see graph	---
48	30	20	641666	3624.99	DFT-s-OFDM QPSK	1@0	see graph	PASS
48	30	20	641666	3624.99	DFT-s-OFDM QPSK	1@0	see graph	PASS
48	30	20	646000	3690.0	DFT-s-OFDM BPSK	1@0	see graph	---
48	30	20	646000	3690.0	DFT-s-OFDM BPSK	1@0	see graph	PASS
48	30	20	646000	3690.0	DFT-s-OFDM BPSK	1@0	see graph	PASS

48	30	20	646000	3690.0	DFT-s-OFDM QPSK	1@0	see graph	---
48	30	20	646000	3690.0	DFT-s-OFDM QPSK	1@0	see graph	PASS
48	30	20	646000	3690.0	DFT-s-OFDM QPSK	1@0	see graph	PASS
48	30	40	638000	3570.0	DFT-s-OFDM BPSK	1@0	see graph	---
48	30	40	638000	3570.0	DFT-s-OFDM BPSK	1@0	see graph	PASS
48	30	40	638000	3570.0	DFT-s-OFDM BPSK	1@0	see graph	PASS
48	30	40	638000	3570.0	DFT-s-OFDM QPSK	1@0	see graph	---
48	30	40	638000	3570.0	DFT-s-OFDM QPSK	1@0	see graph	PASS
48	30	40	638000	3570.0	DFT-s-OFDM QPSK	1@0	see graph	PASS
48	30	40	641666	3624.99	DFT-s-OFDM BPSK	1@0	see graph	---
48	30	40	641666	3624.99	DFT-s-OFDM BPSK	1@0	see graph	PASS
48	30	40	641666	3624.99	DFT-s-OFDM BPSK	1@0	see graph	PASS
48	30	40	641666	3624.99	DFT-s-OFDM QPSK	1@0	see graph	---
48	30	40	641666	3624.99	DFT-s-OFDM QPSK	1@0	see graph	PASS
48	30	40	641666	3624.99	DFT-s-OFDM QPSK	1@0	see graph	PASS
48	30	40	645332	3679.98	DFT-s-OFDM BPSK	1@0	see graph	---
48	30	40	645332	3679.98	DFT-s-OFDM BPSK	1@0	see graph	PASS
48	30	40	645332	3679.98	DFT-s-OFDM BPSK	1@0	see graph	PASS
48	30	40	645332	3679.98	DFT-s-OFDM QPSK	1@0	see graph	---
48	30	40	645332	3679.98	DFT-s-OFDM QPSK	1@0	see graph	PASS
48	30	40	645332	3679.98	DFT-s-OFDM QPSK	1@0	see graph	PASS

N48(20M)_DFT-s-OFDM_BPSK_Edge_1RB_Left_Low_CH

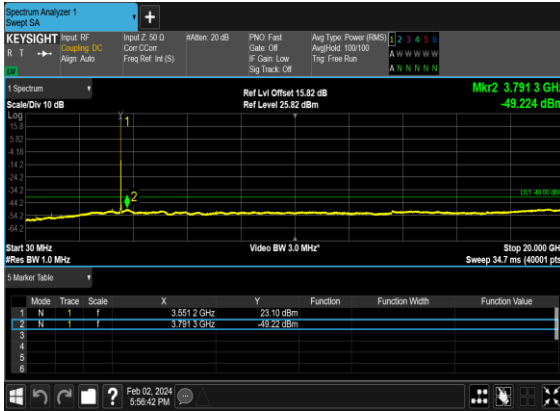

N48(20M)_DFT-s-OFDM_BPSK_Edge_1RB_Left_Low_CH

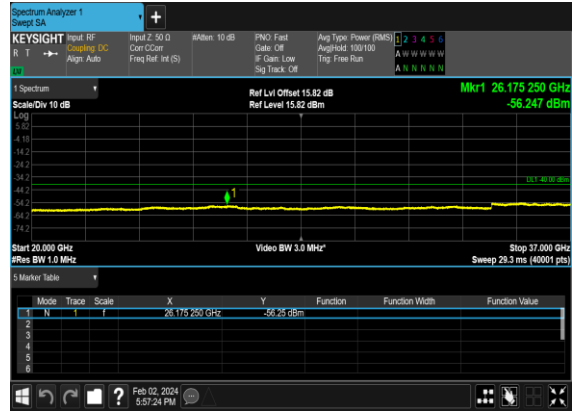

N48(20M)_DFT-s-OFDM_QPSK_Edge_1RB_Left_Low_CH

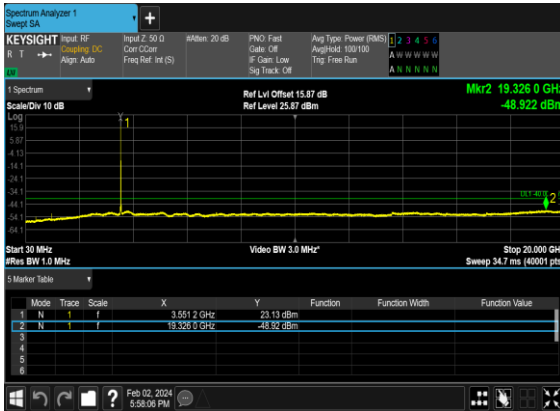

N48(20M)_DFT-s-OFDM_QPSK_Edge_1RB_Left_Low_CH

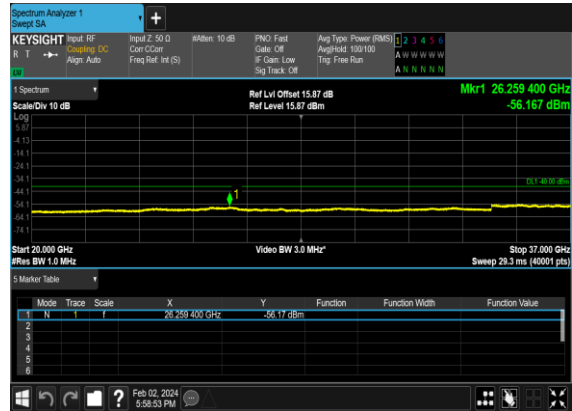

N48(20M)_DFT-s-OFDM_BPSK_Edge_1RB_Left_Mid_CH

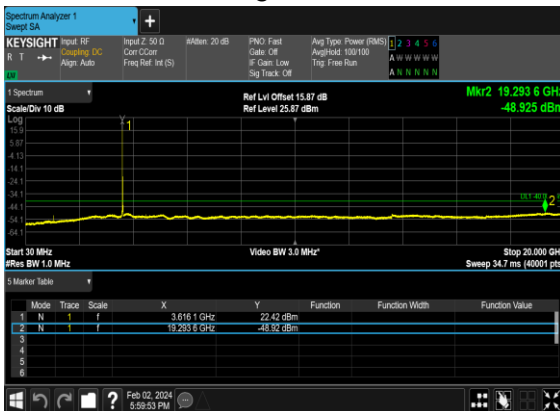

N48(20M)_DFT-s-OFDM_BPSK_Edge_1RB_Left_Mid_CH

