



# FCC RF Test Report

APPLICANT : Motorola Mobility LLC  
EQUIPMENT : Mobile Cellular Phone  
BRAND NAME : Motorola  
MODEL NAME : XT2415-1, XT2415-3, XT2415-5, XT2415V  
FCC ID : IHDT56AN5  
STANDARD : 47 CFR Part 2, 90(R)  
CLASSIFICATION : PCS Licensed Transmitter Held to Ear (PCE)  
TEST DATE(S) : Sep. 23, 2023 ~ Oct. 18, 2023

We, Sporton International Inc. (Kunshan), would like to declare that the tested sample has been evaluated in accordance with the procedures given in ANSI C63.26 and shown compliance with the applicable technical standards.

This report contains data that were produced under subcontract by Sporton International Inc. (ShenZhen)

The test results in this report apply exclusively to the tested model / sample. Without written approval of Sporton International Inc. (Kunshan), the test report shall not be reproduced except in full.

Jason Jia



Approved by: Jason Jia

**Sporton International Inc. (Kunshan)**

No. 1098, Pengxi North Road, Kunshan Economic Development Zone Jiangsu Province 215300  
People's Republic of China



TABLE OF CONTENTS

REVISION HISTORY... 3
SUMMARY OF TEST RESULT ... 4
1 GENERAL DESCRIPTION ... 5
1.1 Applicant ... 5
1.2 Manufacturer ... 5
1.3 Feature of Equipment Under Test ... 5
1.4 Maximum ERP Power, and Emission Designator ... 6
1.5 Specification of Accessory ... 6
1.6 Testing Site ... 6
1.7 Test Software ... 7
1.8 Applied Standards ... 7
2 TEST CONFIGURATION OF EQUIPMENT UNDER TEST ... 8
2.1 Test Mode ... 8
2.2 Connection Diagram of Test System ... 9
2.3 Support Unit used in test configuration and system ... 9
2.4 Measurement Results Explanation Example ... 10
2.5 Frequency List of Low/Middle/High Channels ... 10
3 CONDUCTED TEST ITEMS ... 11
3.1 Measuring Instruments ... 11
3.2 Conducted Output Power and ERP ... 12
3.3 Peak-to-Average Ratio ... 13
3.4 Occupied Bandwidth ... 14
3.5 Conducted Band Edge Measurement ... 15
3.6 Emission Mask ... 16
3.7 Conducted Spurious Emission Measurement ... 17
3.8 Frequency Stability Measurement ... 18
4 RADIATED TEST ITEMS ... 19
4.1 Measuring Instruments ... 19
4.2 Test Setup ... 19
4.3 Test Result of Radiated Test ... 20
4.4 Radiated Spurious Emission Measurement ... 21
5 LIST OF MEASURING EQUIPMENT ... 22
6 MEASUREMENT UNCERTAINTY ... 23
APPENDIX A. TEST RESULTS OF CONDUCTED TEST
APPENDIX B. TEST RESULTS OF RADIATED TEST
APPENDIX C. TEST SETUP PHOTOGRAPHS



## REVISION HISTORY

REPORT NO.	VERSION	DESCRIPTION	ISSUED DATE
FG391202D	Rev. 01	Initial issue of report	Oct. 25, 2023



### SUMMARY OF TEST RESULT

Report Section	FCC Rule	Description	Limit	Result	Remark
3.2	§2.1046	Conducted Output Power	—	Reporting only	-
	§90.542 (a)(7)	Effective Radiated Power	ERP < 3Watt	PASS	-
3.3	-	Peak-to-Average Ratio	—	Reporting only	-
3.4	§2.1049	Occupied Bandwidth	—	Reporting only	-
3.5	§2.1053	Conducted Band Edge Measurement	Refer standard	PASS	-
	§90.543 (e)(2)(3)				
3.6	§2.1051	Emission Mask	Mask B	PASS	-
	§90.210(n)				
3.7	§2.1053	Conducted Spurious Emission	< 43+10log <sub>10</sub> (P[Watts])	PASS	-
	§90.543 (e)(3)				
3.8	§2.1055	Frequency Stability Temperature & Voltage	< ±1.25 ppm	PASS	-
	§90.539 (e)				
4.4	§2.1053 §90.543 (e)(3) §90.543 (f)	Radiated Spurious Emission	< 43+10log <sub>10</sub> (P[Watts])	PASS	Under limit 21.73 dB at 1576.500 MHz

**Conformity Assessment Condition:**

- The test results (PASS/FAIL) with all measurement uncertainty excluded are presented against the regulation limits or in accordance with the requirements stipulated by the applicant/manufacturer who shall bear all the risks of non-compliance that may potentially occur if measurement uncertainty is taken into account.
- The measurement uncertainty please refer to each test result in the section "Measurement Uncertainty"

**Disclaimer:**

The product specifications of the EUT presented in the test report that may affect the test assessments are declared by the manufacturer who shall take full responsibility for the authenticity.



# 1 General Description

## 1.1 Applicant

Motorola Mobility LLC  
222 W,Merchandise Mart Plaza, Chicago IL 60654 USA

## 1.2 Manufacturer

Motorola Mobility LLC  
222 W,Merchandise Mart Plaza, Chicago IL 60654 USA

## 1.3 Feature of Equipment Under Test

Product Feature	
Equipment	Mobile Cellular Phone
Brand Name	Motorola
Model Name	XT2415-1, XT2415-3, XT2415-5, XT2415V
FCC ID	IHDT56AN5
Tx Frequency	LTE Band 14: 788 MHz ~ 798 MHz
Rx Frequency	LTE Band 14: 758 MHz ~ 768 MHz
Bandwidth	5MHz / 10MHz
Maximum Output Power to Antenna	Ant.0 : 22.77dBm Ant.4 : 22.29dBm
Antenna Gain	Ant.0 : FPC_IFA Antenna -4.90 dBi Ant.4 : FPC_IFA Antenna -6.80 dBi
Type of Modulation	QPSK / 16QAM / 64QAM
IMEI Code	Conducted: 357534480029799/357534480029807 Radiation: 357534480040630/357534480040648
HW Version	DVT2
SW Version	UUD34.38
EUT Stage	Identical Prototype

**Remark:**

1. The above EUT's information was declared by manufacturer. Please refer to the specifications or user's manual for more detailed description.
2. The four model names are only for market segment purpose, there is no other difference.
3. The maximum ERP of Antenna 0 is shown in the report.

### 1.4 Maximum ERP Power, and Emission Designator

LTE Band 14		QPSK		16QAM/64QAM	
BW (MHz)	Frequency Range (MHz)	Maximum ERP(W)	Emission Designator (99%OBW)	Maximum ERP(W)	Emission Designator (99%OBW)
5	790.5~795.5	0.0368	4M50G7D	0.0312	4M48W7D
10	793	0.0373	9M03G7D	0.0316	8M99W7D

### 1.5 Specification of Accessory

Accessories Information				
AC Adapter 1	Brand Name	Motorola(Salcomp)	Model Name	MC-101
AC Adapter 2	Brand Name	Motorola(Chenyang)	Model Name	MC-101
AC Adapter 3	Brand Name	Motorola(AOHAI)	Model Name	MC-101
Battery 1	Brand Name	Motorola (ATL)	Model Name	QA50
USB Cable 1	Brand Name	WASHIN	Model Name	S928D98335
USB Cable 2	Brand Name	Saibao	Model Name	S928D98333
USB Cable 3	Brand Name	Saibao	Model Name	S928D98334

### 1.6 Testing Site

Sporton International Inc. (Kunshan) is accredited to ISO/IEC 17025:2017 by American Association for Laboratory Accreditation with Certificate Number 5145.02.

Test Firm	Sporton International Inc. (Kunshan)		
Test Site Location	No. 1098, Pengxi North Road, Kunshan Economic Development Zone Jiangsu Province 215300 People's Republic of China TEL : +86-512-57900158		
Test Site No.	Sporton Site No.	FCC Designation No.	FCC Test Firm Registration No.
	TH01-KS	CN1257	314309

Sporton International Inc. (ShenZhen) is accredited to ISO/IEC 17025:2017 by American Association for Laboratory Accreditation with Certificate Number 5145.01.

<b>Test Firm</b>	Sporton International Inc. (ShenZhen)		
<b>Test Site Location</b>	101, 1st Floor, Block B, Building 1, No. 2, Tengfeng 4th Road, Fenghuang Community, Fuyong Street, Baoan District, Shenzhen City, Guangdong Province 518103 People's Republic of China TEL: +86-755-86066985		
<b>Test Site No.</b>	<b>Sporton Site No.</b>	<b>FCC Designation No.</b>	<b>FCC Test Firm Registration No.</b>
	03CH01-SZ	CN1256	421272

Test data subcontracted: Radiated Spurious Emission test case in section 4.4 of this report.

### 1.7 Test Software

Item	Site	Manufacture	Name	Version
1.	TH01-KS	SPORTON	FCC LTE_Ver2.0 Auto_china_210503	2.0
2.	03CH01-SZ	AUDIX	E3	6.2009-8-24

### 1.8 Applied Standards

According to the specifications of the manufacturer, the EUT must comply with the requirements of the following standards:

- 47 CFR Part 2, Part 90(R)
- ANSI C63.26
- KDB 971168 D01 Power Meas License Digital Systems v03r01
- KDB 412172 D01 Determining ERP and EIRP v01r01

**Remark:**

1. All test items were verified and recorded according to the standards and without any deviation during the test.
2. This EUT has also been tested and complied with the requirements of FCC Part 15, Subpart B, recorded in a separate test report.



## 2 Test Configuration of Equipment Under Test

### 2.1 Test Mode

Antenna port conducted and radiated test items listed below are performed according to KDB 971168 D01 Power Meas License Digital Systems v03r01 with maximum output power.

Radiated measurements are performed by rotating the EUT in three different orthogonal test planes to find the maximum emission.

Conducted Test Cases	Band	Bandwidth (MHz)						Modulation			RB #			Test Channel		
		1.4	3	5	10	15	20	QPSK	16QAM	64QAM	1	Half	Full	L	M	H
Max. Output Power	14	-	-	V	-	-	-	V	V	V	V	V	V	V	V	V
	14	-	-		V	-	-	V	V	V	V	V		V		
Peak-to-Average Ratio 26dB and 99% Bandwidth	14	-	-		V	-	-	V	V	V			V		V	
	14	-	-		V	-	-	V	V				V		V	
Conducted Band Edge	14	-	-	V		-	-	V	V	V	V		V	V		V
	14	-	-		V	-	-	V	V	V	V		V	V		V
Emission Mask	14	-	-	V		-	-	V	V	V	V		V	V	V	V
	14	-	-		V	-	-	V	V	V	V		V		V	
Conducted Spurious Emission	14	-	-	V		-	-	V				V		V	V	V
	14	-	-		V	-	-	V				V			V	
Frequency Stability	14	-	-	V	V	-	-	V					V		V	
E.R.P	14	-	-	V		-	-	V	V	V	V	V	V	V	V	V
	14	-	-		V	-	-	V	V	V	V	V	V		V	
Radiated Spurious Emission	14	Worst Case											V	V	V	
Note	<ol style="list-style-type: none"> <li>The mark "v " means that this configuration is chosen for testing</li> <li>The mark "-" means that this bandwidth is not supported.</li> <li>The device is investigated from 30MHz to 10 times of fundamental signal for radiated spurious emission test under different RB size/offset and modulations in exploratory test. Subsequently, only the worst case emissions are reported.</li> </ol>															



## 2.2 Connection Diagram of Test System

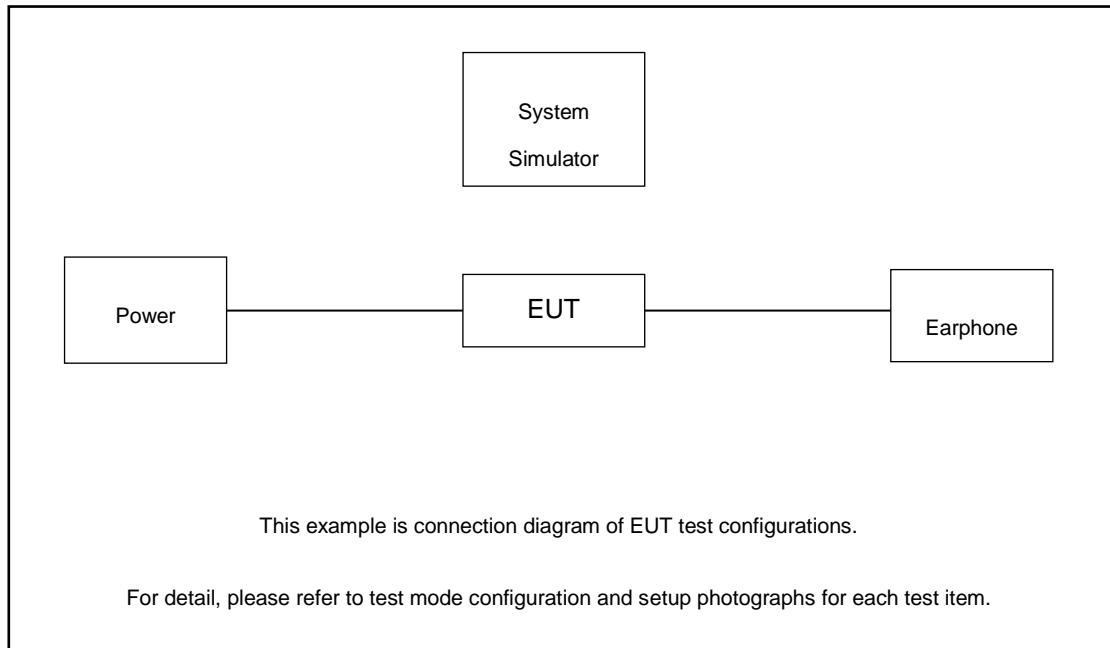

## 2.3 Support Unit used in test configuration and system

Item	Equipment	Trade Name	Model No.	FCC ID	Data Cable	Power Cord
1.	LTE Base Station	Anritsu	MT8820C	N/A	N/A	Unshielded, 1.8 m
2.	DC Power Supply	GW INSTEK	GPS-3030D	N/A	N/A	Unshielded, 1.8 m
3.	Earphone	N/A	N/A	N/A	N/A	N/A

## 2.4 Measurement Results Explanation Example

**For all conducted test items:**

The offset level is set in the spectrum analyzer to compensate the RF cable loss and attenuator factor between EUT conducted output port and spectrum analyzer. With the offset compensation, the spectrum analyzer reading level is exactly the EUT RF output level.

The spectrum analyzer offset is derived from RF cable loss and attenuator factor.

*Offset = RF cable loss + attenuator factor.*

Following shows an offset computation example with cable loss 4.60 dB

Example :

$$\begin{aligned} \text{Offset(dB)} &= \text{RF cable loss(dB)} \\ &= 4.60 \text{ (dB)} \end{aligned}$$

## 2.5 Frequency List of Low/Middle/High Channels

LTE Band 14 Channel and Frequency List				
BW [MHz]	Channel/Frequency(MHz)	Lowest	Middle	Highest
10	Channel	-	23330	-
	Frequency	-	793	-
5	Channel	23305	23330	23355
	Frequency	790.5	793	795.5

### 3 Conducted Test Items

#### 3.1 Measuring Instruments

See list of measuring instruments of this test report.

##### 3.1.1 Test Setup

##### 3.1.2 Conducted Output Power

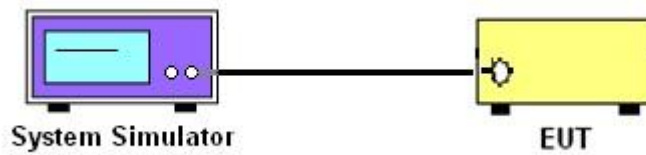

##### 3.1.3 Peak-to-Average Ratio, Occupied Bandwidth, Conducted Band-Edge, Emission Mask, and Conducted Spurious Emission



##### 3.1.4 Frequency Stability

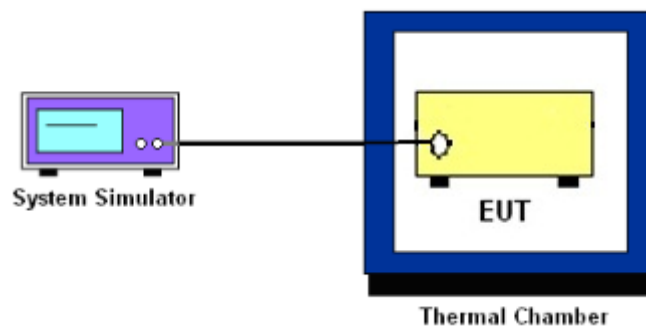

##### 3.1.5 Test Result of Conducted Test

Please refer to Appendix A.

## 3.2 Conducted Output Power and ERP

### 3.2.1 Description of the Conducted Output Power Measurement and ERP

A base station simulator was used to establish communication with the EUT. Its parameters were set to transmit the maximum power on the EUT. The measured power in the radio frequency on the transmitter output terminals shall be reported.

The ERP of mobile transmitters must not exceed 3 Watts for LTE Band 14.

According to KDB 412172 D01 Power Approach,

$EIRP = P_T + G_T - L_C$ ,  $ERP = EIRP - 2.15$ , where

$P_T$  = transmitter output power in dBm

$G_T$  = gain of the transmitting antenna in dBi

$L_C$  = signal attenuation in the connecting cable between the transmitter and antenna in dB

### 3.2.2 Test Procedures

1. The testing follows ANSI C63.26 Section 5.2
2. The transmitter output port was connected to the system simulator.
3. Set EUT at maximum power through the system simulator.
4. Select lowest, middle, and highest channels for each band and different modulation.
5. Measure and record the power level from the system simulator.

### **3.3 Peak-to-Average Ratio**

#### **3.3.1 Description of the PAR Measurement**

Power Complementary Cumulative Distribution Function (CCDF) curves provide a means for characterizing the power peaks of a digitally modulated signal on a statistical basis. A CCDF curve depicts the probability of the peak signal amplitude exceeding the average power level. Most contemporary measurement instrumentation include the capability to produce CCDF curves for an input signal provided that the instrument's resolution bandwidth can be set wide enough to accommodate the entire input signal bandwidth. In measuring transmissions in this band using an average power technique, the peak-to-average ratio (PAR) of the transmission may not exceed 13 dB.

#### **3.3.2 Test Procedures**

1. The EUT was connected to spectrum and system simulator via a power divider.
2. Set the CCDF (Complementary Cumulative Distribution Function) option in spectrum analyzer.
3. The highest RF powers were measured and recorded the maximum PAPR level associated with a probability of 0.1 %.
4. Record the deviation as Peak to Average Ratio.

## 3.4 Occupied Bandwidth

### 3.4.1 Description of Occupied Bandwidth Measurement

The occupied bandwidth is the width of a frequency band such that, below the lower and above the upper frequency limits, the mean powers emitted are each equal to a specified percentage 0.5% of the total mean transmitted power.

The 26 dB emission bandwidth is defined as the frequency range between two points, one above and one below the carrier frequency, at which the spectral density of the emission is attenuated 26 dB below the maximum in-band spectral density of the modulated signal. Spectral density (power per unit bandwidth) is to be measured with a detector of resolution bandwidth equal to approximately 1.0% of the emission bandwidth.

### 3.4.2 Test Procedures

1. The testing follows ANSI C63.26 Section 5.4
2. The EUT was connected to spectrum analyzer and system simulator via a power divider.
3. The spectrum analyzer center frequency is set to the nominal EUT channel center frequency. The span range for the spectrum analyzer shall be between two and five times the anticipated OBW.
4. The nominal resolution bandwidth (RBW) shall be in the range of 1 to 5 % of the anticipated OBW, and the VBW shall be at least 3 times the RBW.
5. Set the detection mode to peak, and the trace mode to max hold.
6. Determine the reference value: Set the EUT to transmit a modulated signal. Allow the trace to stabilize. Set the spectrum analyzer marker to the highest level of the displayed trace.  
(this is the reference value)
7. Determine the “-26 dB down amplitude” as equal to (Reference Value – X).
8. Place two markers, one at the lowest and the other at the highest frequency of the envelope of the spectral display such that each marker is at or slightly below the “-X dB down amplitude” determined in step 6. If a marker is below this “-X dB down amplitude” value it shall be placed as close as possible to this value. The OBW is the positive frequency difference between the two markers.
9. Use the 99 % power bandwidth function of the spectrum analyzer and report the measured bandwidth.

## 3.5 Conducted Band Edge Measurement

### 3.5.1 Description of Conducted Band Edge Measurement

For operations in the 758-768 MHz and the 788-798 MHz bands

- (1) On all frequencies between 769-775 MHz and 799-805 MHz, by a factor not less than  $76 + 10 \log (P)$  dB in a 6.25 kHz band segment, for base and fixed stations.
- (2) On all frequencies between 769-775 MHz and 799-805 MHz, by a factor not less than  $65 + 10 \log (P)$  dB in a 6.25 kHz band segment, for mobile and portable stations.
- (3) On any frequency between 775-788 MHz, above 805 MHz, and below 758 MHz, by at least  $43 + 10 \log (P)$  dB.

### 3.5.2 Test Procedures

1. The testing follows ANSI C63.26 section 5.7
2. The EUT was connected to spectrum analyzer and system simulator via a power divider.
3. The band edges of low and high channels for the highest RF powers were measured.
4. Set spectrum analyzer with RMS detector.
5. The RF fundamental frequency should be excluded against the limit line in the operating frequency band.
6. Checked that all the results comply with the emission limit line.

Example:

$$\begin{aligned} & \text{The limit line is derived from } 43 + 10\log(P)\text{dB below the transmitter power P(Watts)} \\ & = P(W) - [43 + 10\log(P)] \text{ (dB)} \\ & = [30 + 10\log(P)] \text{ (dBm)} - [43 + 10\log(P)] \text{ (dB)} = -13\text{dBm}. \end{aligned}$$

## 3.6 Emission Mask

### 3.6.1 Description of Emission Mask

<Emission Mask B>.

For transmitters that are equipped with an audio low-pass filter, the power of any emission must be attenuated below the unmodulated carrier power (P) as follows:

- (1) On any frequency removed from the assigned frequency by more than 50 percent, but not more than 100 percent of the authorized bandwidth: At least 25 dB.
- (2) On any frequency removed from the assigned frequency by more than 100 percent, but not more than 250 percent of the authorized bandwidth: At least 35 dB.
- (3) On any frequency removed from the assigned frequency by more than 250 percent of the authorized bandwidth: At least  $43 + 10 \log (P)$  dB.

### 3.6.2 Test Procedures

1. The testing follows ANSI C63.26 section 5.7
2. The EUT was connected to spectrum analyzer and system simulator via a power divider.
3. The RF output of EUT was connected to the spectrum analyzer by RF cable and attenuator. The path loss was compensated to the results for each measurement.
4. Make the measurement with the spectrum analyzer's RBW = 1MHz, VBW = 3MHz.
5. Set spectrum analyzer with RMS detector.
6. Taking the record of maximum spurious emission.
7. The RF fundamental frequency should be excluded against the limit line in the operating frequency band.
8. The limit line is derived from  $43 + 10\log(P)$ dB below the transmitter power P(Watts)  
=  $P(W) - [43 + 10\log(P)]$  (dB)  
=  $[30 + 10\log(P)]$  (dBm) -  $[43 + 10\log(P)]$  (dB)  
= -13dBm.



## 3.7 Conducted Spurious Emission Measurement

### 3.7.1 Description of Conducted Spurious Emission Measurement

The power of any emission outside of the authorized operating frequency ranges must be lower than the transmitter power (P) by a factor of at least  $43 + 10 \log (P)$  dB.

It is measured by means of a calibrated spectrum analyzer and scanned from 30MHz up to a frequency including its 10<sup>th</sup> harmonic.

### 3.7.2 Test Procedures

1. The testing follows ANSI C63.26 section 5.7
2. The EUT was connected to spectrum analyzer and base station via power divider.
3. The RF output of EUT was connected to the spectrum analyzer by RF cable and attenuator. The path loss was compensated to the results for each measurement.
4. The middle channel for the highest RF power within the transmitting frequency was measured.
5. The conducted spurious emission for the whole frequency range was taken.
6. Make the measurement with the spectrum analyzer's, for under 1GHz RBW = 100kHz, VBW = 300kHz and for above 1GHz RBW = 1MHz, VBW = 3MHz, taking the record of maximum spurious emission.
7. Set spectrum analyzer with RMS detector.
8. The RF fundamental frequency should be excluded against the limit line in the operating frequency band.
9. The limit line is derived from  $43 + 10\log(P)$ dB below the transmitter power P(Watts)  
= P(W)- [43 + 10log(P)] (dB)  
= [30 + 10log(P)] (dBm) - [43 + 10log(P)] (dB)  
= -13dBm.

## 3.8 Frequency Stability Measurement

### 3.8.1 Description of Frequency Stability Measurement

The frequency stability shall be measured by variation of ambient temperature and variation of primary supply voltage to ensure that the fundamental emission stays within the authorized frequency block. The frequency stability of the transmitter shall be maintained within  $\pm 1.25$  ppm of the center frequency.

### 3.8.2 Test Procedures for Temperature Variation

1. The testing follows ANSI C63.26 section 5.6.4
2. The EUT was set up in the thermal chamber and connected with the system simulator.
3. With power OFF, the temperature was decreased to  $-30^{\circ}\text{C}$  and the EUT was stabilized before testing. Power was applied and the maximum change in frequency was recorded within one minute.
4. With power OFF, the temperature was raised in  $10^{\circ}\text{C}$  step up to  $50^{\circ}\text{C}$ . The EUT was stabilized at each step for at least half an hour. Power was applied and the maximum frequency change was recorded within one minute.

### 3.8.3 Test Procedures for Voltage Variation

1. The testing follows ANSI C63.26 section 5.6.5.
2. The EUT was placed in a temperature chamber at  $20\pm 5^{\circ}\text{C}$  and connected with the system simulator.
3. The power supply voltage to the EUT was varied from 85% to 115% of the nominal value for other than hand carried battery equipment.
4. For hand carried, battery powered equipment, reduce the primary ac or dc supply voltage to the battery operating end point, which shall be specified by the manufacturer.
5. The variation in frequency was measured for the worst case.

## 4 Radiated Test Items

### 4.1 Measuring Instruments

See list of measuring instruments of this test report.

### 4.2 Test Setup

#### 4.2.1 For radiated test below 30MHz



#### 4.2.2 For radiated test from 30MHz to 1GHz

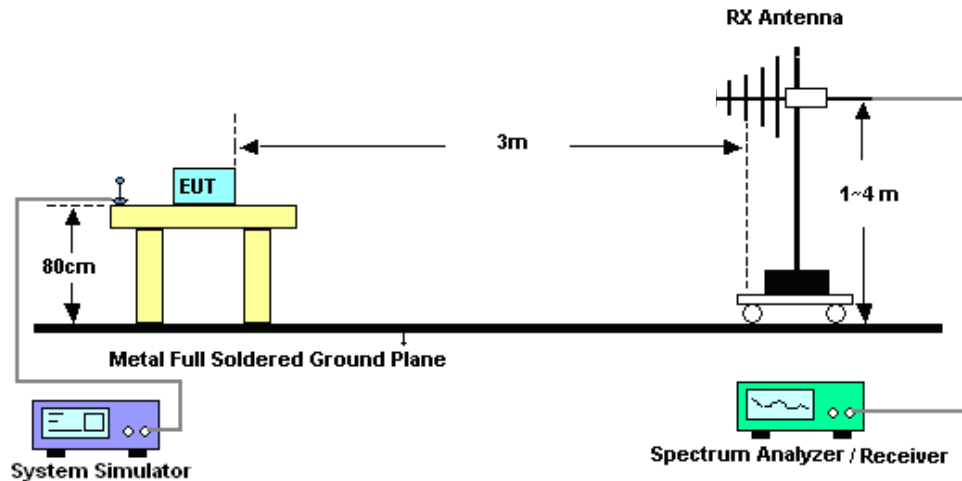

### 4.2.3 For radiated test above 1GHz



### 4.3 Test Result of Radiated Test

The low frequency, which started from 9 kHz to 30MHz, was pre-scanned and the result which was 20dB lower than the limit line was not reported.

Please refer to Appendix B.

## 4.4 Radiated Spurious Emission Measurement

### 4.4.1 Description of Radiated Spurious Emission

The radiated spurious emission was measured by substitution method according to ANSI C63.26.

The power of any emission outside of the authorized operating frequency ranges must be attenuated below the transmitter power (P) by a factor of at least  $43 + 10 \log (P)$  dB.

For operations in the 758-775 MHz and 788-805 MHz bands, all emissions including harmonics in the band 1559–1610 MHz shall be limited to -70 dBW/MHz equivalent isotropically radiated power (EIRP) for wideband signals, and -80 dBW EIRP for discrete emissions of less than 700 Hz bandwidth. For the purpose of equipment authorization, a transmitter shall be tested with an antenna that is representative of the type that will be used with the equipment in normal operation.

### 4.4.2 Test Procedures

1. The testing follows ANSI C63.26 Section 5.5
2. The EUT was placed on a turntable with 0.8 meter height for frequency below 1GHz and 1.5 meter height for frequency above 1GHz respectively above ground.
3. The EUT was set 3 meters from the receiving antenna mounted on the antenna tower.
4. The table was rotated 360 degrees to determine the position of the highest spurious emission.
5. The height of the receiving antenna is varied between 1m to 4m to search the maximum spurious emission for both horizontal and vertical polarizations.
6. During the measurement, the system simulator parameters were set to force the EUT transmitting at maximum output power.
7. Make the measurement with the spectrum analyzer's RBW = 1MHz, VBW = 3MHz, taking the record of maximum spurious emission.
8. A horn antenna was substituted in place of the EUT and was driven by a signal generator.
9. Tune the output power of signal generator to the same emission level with EUT maximum spurious emission.
10.  $EIRP (dBm) = S.G. Power - Tx Cable Loss + Tx Antenna Gain$
11.  $ERP (dBm) = EIRP - 2.15$
12. The RF fundamental frequency should be excluded against the limit line in the operating frequency band.

The limit line is derived from  $43 + 10\log(P)$ dB below the transmitter power P(Watts)  
=  $P(W) - [43 + 10\log(P)] (dB)$   
=  $[30 + 10\log(P)] (dBm) - [43 + 10\log(P)] (dB)$   
= -13dBm.



## 5 List of Measuring Equipment

Instrument	Manufacturer	Model No.	Serial No.	Characteristics	Calibration Date	Test Date	Due Date	Remark
Spectrum Analyzer	R&S	FSV30	101338	10Hz~30GHz	May 16, 2023	Oct. 08, 2023 ~Oct. 11, 2023	May 15, 2024	Conducted (TH01-KS)
Spectrum Analyzer	R&S	FSV40	101040	10Hz~40GHz	Oct. 12, 2022	Oct. 08, 2023 ~Oct. 11, 2023	Oct. 11, 2023	Conducted (TH01-KS)
Power divider	STI	STI08-0055	-	0.5~40GHz	NCR	Oct. 08, 2023 ~Oct. 11, 2023	NCR	Conducted (TH01-KS)
EMI Test Receiver&SA	Agilent	N9038A	MY5226018 5	20Hz~26.5GHz	Dec. 26, 2022	Sep. 23, 2023 ~Oct. 18, 2023	Dec. 25, 2023	Radiation (03CH01-SZ)
Loop Antenna	R&S	HFH2-Z2	100354	9kHz~30MHz	Jul. 28, 2022	Sep. 23, 2023 ~Oct. 18, 2023	Jul. 27, 2024	Radiation (03CH01-SZ)
HF Amplifier	KEYSIGHT	83017A	MY5327010 5	0.5GHz~26.5Ghz	Oct. 19, 2022	Sep. 23, 2023 ~Oct. 18, 2023	Oct. 18, 2023	Radiation (03CH01-SZ)
Bilog Antenna	TeseQ	CBL6112D	35407	30MHz-2GHz	Sep. 28, 2021	Sep. 23, 2023 ~Oct. 18, 2023	Sep. 27, 2023	Radiation (03CH01-SZ)
Double Ridge Horn Antenna	ETS-Lindgren	3117	00119436	1GHz~18GHz	Jul. 08, 2023	Sep. 23, 2023 ~Oct. 18, 2023	Jul. 07, 2024	Radiation (03CH01-SZ)
SHF-EHF Horn	com-power	AH-840	101071	18Ghz-40GHz	Apr. 08, 2023	Sep. 23, 2023 ~Oct. 18, 2023	Apr. 07, 2024	Radiation (03CH01-SZ)
LF Amplifier	Burgeon	BPA-530	102209	0.01~3000Mhz	Apr. 04, 2023	Sep. 23, 2023 ~Oct. 18, 2023	Apr. 03, 2024	Radiation (03CH01-SZ)
HF Amplifier	MITEQ	AMF-7D-001 01800-30-10	1943528	1GHz~18GHz	Oct. 19, 2022	Sep. 23, 2023 ~Oct. 18, 2023	Oct. 18, 2023	Radiation (03CH01-SZ)
HF Amplifier	MITEQ	TTA1840-35- HG	1871923	18GHz~40GHz	Jul. 07, 2023	Sep. 23, 2023 ~Oct. 18, 2023	Jul. 06, 2024	Radiation (03CH01-SZ)
AC Power Source	Chroma	61601	6160100019 85	N/A	Nov. 10, 2022	Sep. 23, 2023 ~Oct. 18, 2023	Nov. 09, 2023	Radiation (03CH01-SZ)
Turn Table	EM	EM1000	N/A	0~360 degree	NCR	Sep. 23, 2023 ~Oct. 18, 2023	NCR	Radiation (03CH01-SZ)
Antenna Mast	EM	EM1000	N/A	1 m~4 m	NCR	Sep. 23, 2023 ~Oct. 18, 2023	NCR	Radiation (03CH01-SZ)

NCR: No Calibration Required

## 6 Measurement Uncertainty

The measurement uncertainties shown below were calculated in accordance with the requirements of ANSI 63.26-2015. All the measurement uncertainty value were shown with a coverage K=2 to indicate 95% level of confidence. The measurement data show herein meets or exceeds the CISPR measurement uncertainty values specified in CISPR 16-4-2 and can be compared directly to specified limit to determine compliance.

### Uncertainty of Conducted Measurement

Test Item	Uncertainty
Conducted Power	±0.46 dB
Conducted Emissions	±0.48 dB
Occupied Channel Bandwidth	±0.1 %

### Uncertainty of Radiated Emission Measurement (30 MHz ~ 1000 MHz)

Measuring Uncertainty for a Level of Confidence of 95% (U = 2Uc(y))	2.48dB
---	--------

### Uncertainty of Radiated Emission Measurement (1 GHz ~ 18 GHz)

Measuring Uncertainty for a Level of Confidence of 95% (U = 2Uc(y))	3.53dB
---	--------

### Uncertainty of Radiated Emission Measurement (18 GHz ~ 40 GHz)

Measuring Uncertainty for a Level of Confidence of 95% (U = 2Uc(y))	4.02dB
---	--------

----- THE END -----



## Appendix A. Test Results of Conducted Test

Test Engineer :	Simle Wang	Temperature :	22~23°C
		Relative Humidity :	40~42%

### Conducted Output Power(Average power)

Ant.0:

BW [MHz]	Modulation	RB Size	RB Offset	Power Low Ch. / Freq.	Power Middle Ch. / Freq.	Power High Ch. / Freq.
Channel				23330		
Frequency (MHz)				793		
10	QPSK	1	0		22.77	
10	QPSK	1	25		22.75	
10	QPSK	1	49		22.70	
10	QPSK	25	0		21.80	
10	QPSK	25	12		21.68	
10	QPSK	25	25		21.65	
10	QPSK	50	0		21.78	
10	16QAM	1	0		22.04	
10	16QAM	1	25		21.90	
10	16QAM	1	49		21.87	
10	16QAM	25	0		20.78	
10	16QAM	25	12		20.57	
10	16QAM	25	25		20.65	
10	16QAM	50	0		20.76	
10	64QAM	1	0		20.92	
10	64QAM	1	25		20.92	
10	64QAM	1	49		20.89	
10	64QAM	25	0		19.76	
10	64QAM	25	12		19.48	
10	64QAM	25	25		19.55	
10	64QAM	50	0		19.76	
Channel				23305	23330	23355
Frequency (MHz)				790.5	793	795.5
5	QPSK	1	0	22.59	22.71	22.69
5	QPSK	1	12	22.67	22.58	22.58
5	QPSK	1	24	22.63	22.58	22.50
5	QPSK	12	0	21.71	21.65	21.75
5	QPSK	12	7	21.48	21.65	21.61
5	QPSK	12	13	21.48	21.64	21.65
5	QPSK	25	0	21.76	21.67	21.72
5	16QAM	1	0	21.88	21.99	21.95
5	16QAM	1	12	21.89	21.84	21.78





5	16QAM	1	24	21.67	21.88	21.83
5	16QAM	12	0	20.60	20.77	20.63
5	16QAM	12	7	20.56	20.48	20.56
5	16QAM	12	13	20.66	20.45	20.54
5	16QAM	25	0	20.58	20.66	20.64
5	64QAM	1	0	20.75	20.94	20.93
5	64QAM	1	12	20.84	20.88	20.73
5	64QAM	1	24	20.71	20.79	20.80
5	64QAM	12	0	19.70	19.66	19.75
5	64QAM	12	7	19.27	19.29	19.46
5	64QAM	12	13	19.42	19.51	19.54
5	64QAM	25	0	19.75	19.61	19.70

**Ant.4:**

BW [MHz]	Modulation	RB Size	RB Offset	Power Low Ch. / Freq.	Power Middle Ch. / Freq.	Power High Ch. / Freq.
Channel				23330		
Frequency (MHz)				793		
10	QPSK	1	0		22.29	
10	QPSK	1	25		22.28	
10	QPSK	1	49		22.22	
10	QPSK	25	0		21.18	
10	QPSK	25	12		21.14	
10	QPSK	25	25		21.12	
10	QPSK	50	0		21.29	
10	16QAM	1	0		21.58	
10	16QAM	1	25		21.52	
10	16QAM	1	49		21.50	
10	16QAM	25	0		20.23	
10	16QAM	25	12		20.23	
10	16QAM	25	25		20.21	
10	16QAM	50	0		20.29	
10	64QAM	1	0		20.41	
10	64QAM	1	25		20.39	
10	64QAM	1	49		20.35	
10	64QAM	25	0		19.27	
10	64QAM	25	12		19.25	
10	64QAM	25	25		19.17	
10	64QAM	50	0		19.30	
Channel				23305	23330	23355
Frequency (MHz)				790.5	793	795.5
5	QPSK	1	0	22.22	22.28	22.23
5	QPSK	1	12	22.16	22.21	22.24
5	QPSK	1	24	22.11	22.22	22.05



5	QPSK	12	0	21.14	21.02	21.01
5	QPSK	12	7	21.13	20.96	21.05
5	QPSK	12	13	20.94	21.12	20.98
5	QPSK	25	0	21.25	21.23	21.17
5	16QAM	1	0	21.58	21.57	21.45
5	16QAM	1	12	21.41	21.41	21.37
5	16QAM	1	24	21.29	21.40	21.33
5	16QAM	12	0	20.21	20.14	20.20
5	16QAM	12	7	20.17	20.18	20.23
5	16QAM	12	13	20.20	20.13	20.11
5	16QAM	25	0	20.27	20.13	20.27
5	64QAM	1	0	20.25	20.19	20.20
5	64QAM	1	12	20.18	20.27	20.19
5	64QAM	1	24	20.18	20.37	20.29
5	64QAM	12	0	19.18	19.14	19.06
5	64QAM	12	7	19.07	19.25	19.13
5	64QAM	12	13	19.12	19.10	18.97
5	64QAM	25	0	19.18	19.09	19.31



## LTE Band 14

### Peak-to-Average Ratio

Mode	LTE Band 14 / 5MHz			
Mod.	QPSK	16QAM	64QAM	Limit: 13dB
RB Size	Full RB	Full RB	Full RB	Result
Middle CH	5.36	6.20	6.35	<b>PASS</b>

**LTE Band 14 / 5MHz**

**Middle Channel / Full RB/ QPSK**

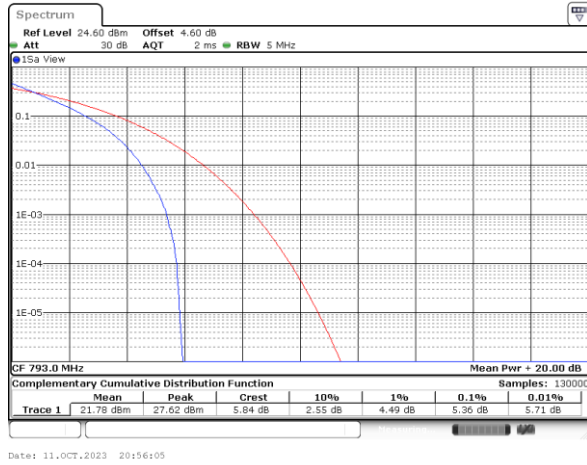

Date: 11.OCT.2023 20:56:05

**Middle Channel / Full RB/ 16QAM**

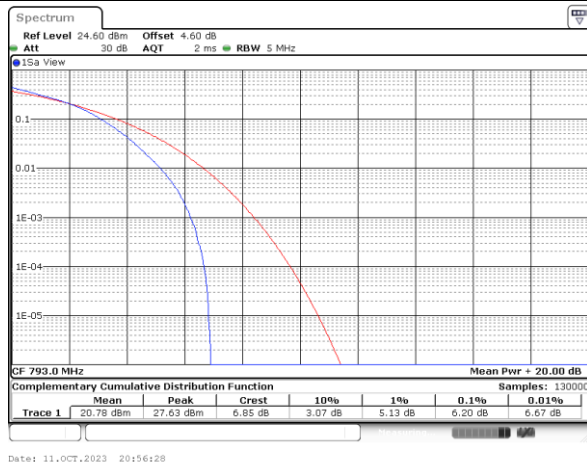

Date: 11.OCT.2023 20:56:28

**Middle Channel / Full RB/ 64QAM**

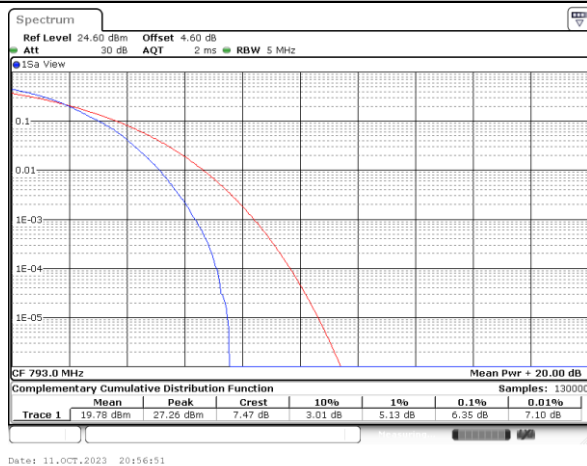

Date: 11.OCT.2023 20:56:51



**Peak-to-Average Ratio**

Mode	LTE Band 14 / 10MHz			
Mod.	QPSK	16QAM	64QAM	Limit: 13dB
RB Size	Full RB	Full RB	Full RB	Result
Middle CH	5.36	6.14	6.38	<b>PASS</b>

**LTE Band 14 / 10MHz**

**Middle Channel / Full RB/ QPSK**

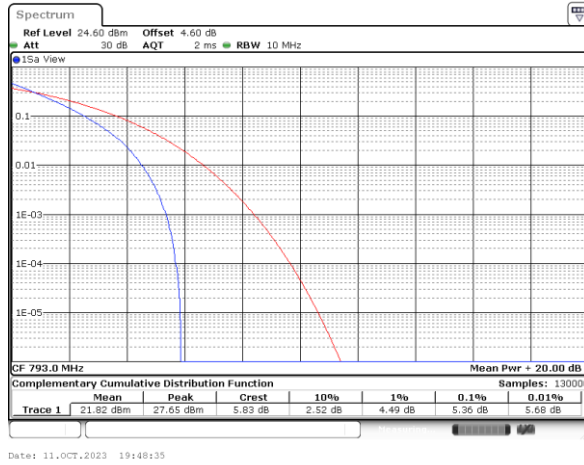

Date: 11.OCT.2023 19:48:35

**Middle Channel / Full RB/ 16QAM**

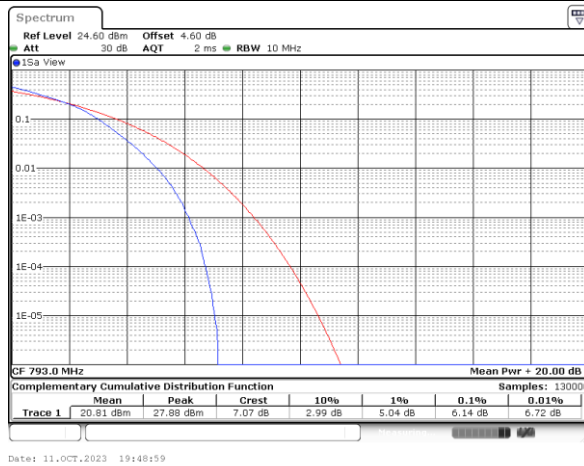

Date: 11.OCT.2023 19:48:59

**Middle Channel / Full RB/ 64QAM**

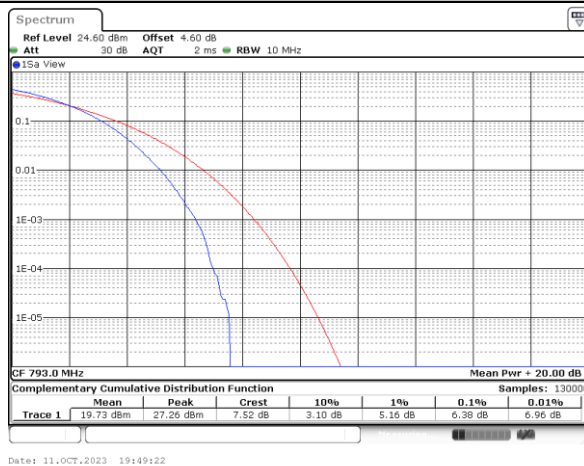

Date: 11.OCT.2023 19:49:22



## 26dB Bandwidth

<b>Mode</b>	<b>LTE Band 14 : 26dB BW(MHz)</b>	
<b>BW</b>	<b>5MHz</b>	
<b>Mod.</b>	<b>QPSK</b>	<b>16QAM</b>
<b>Middle CH</b>	4.95	4.85
<b>Mode</b>	<b>LTE Band 14 : 26dB BW(MHz)</b>	
<b>BW</b>	<b>10MHz</b>	
<b>Mod.</b>	<b>QPSK</b>	<b>16QAM</b>
<b>Middle CH</b>	9.75	9.85

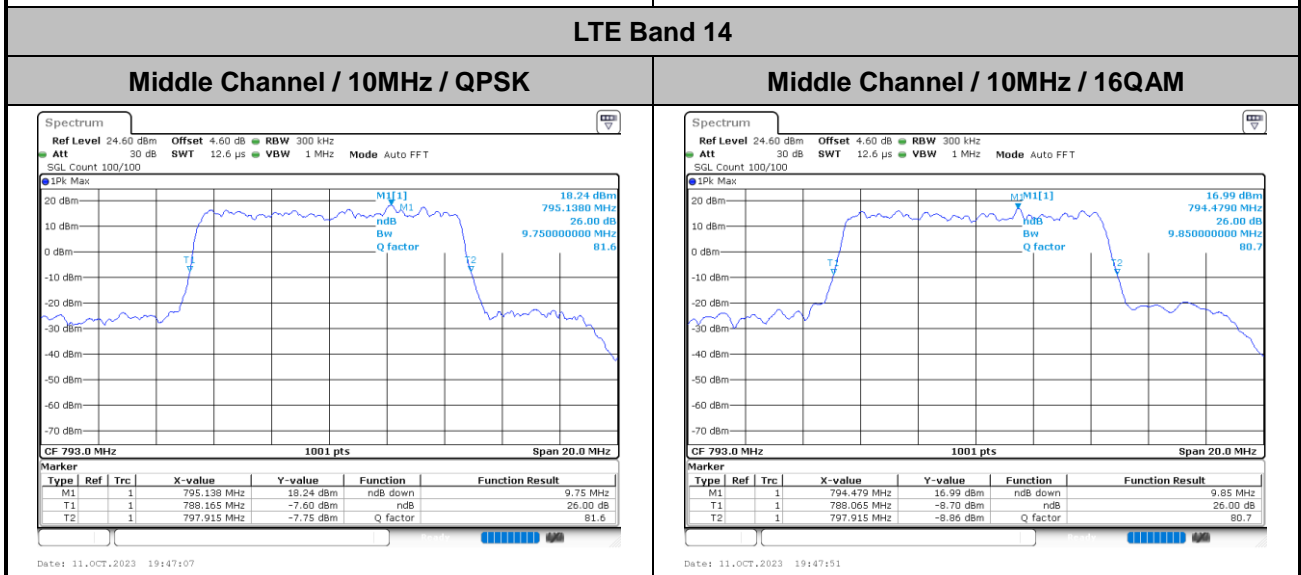
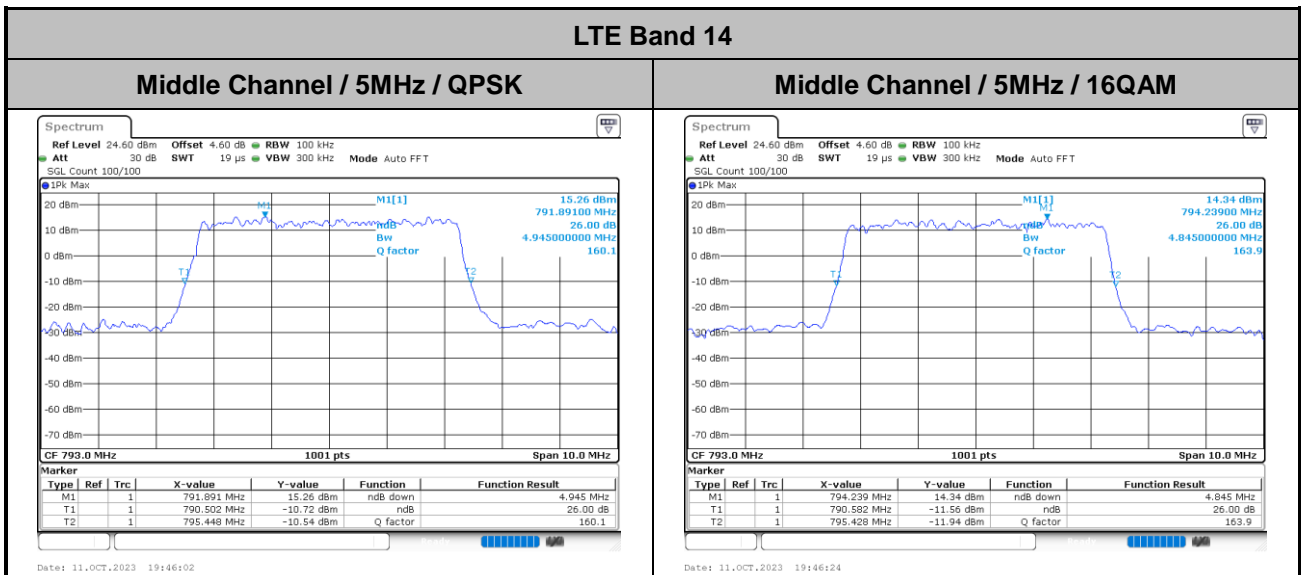

# Occupied Bandwidth

Mode	LTE Band 14 : 99%OBW(MHz)	
BW	10MHz	
Mod.	QPSK	16QAM
Middle CH	4.50	4.48
Mode	LTE Band 14 : 99%OBW(MHz)	
BW	10MHz	
Mod.	QPSK	16QAM
Middle CH	9.03	8.99

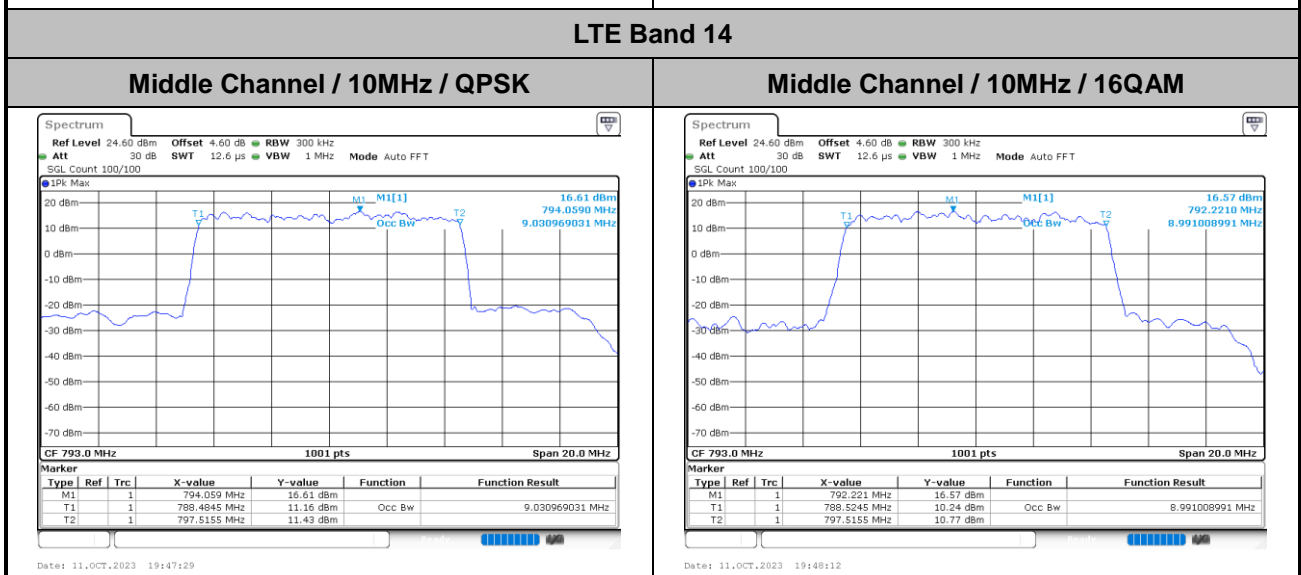
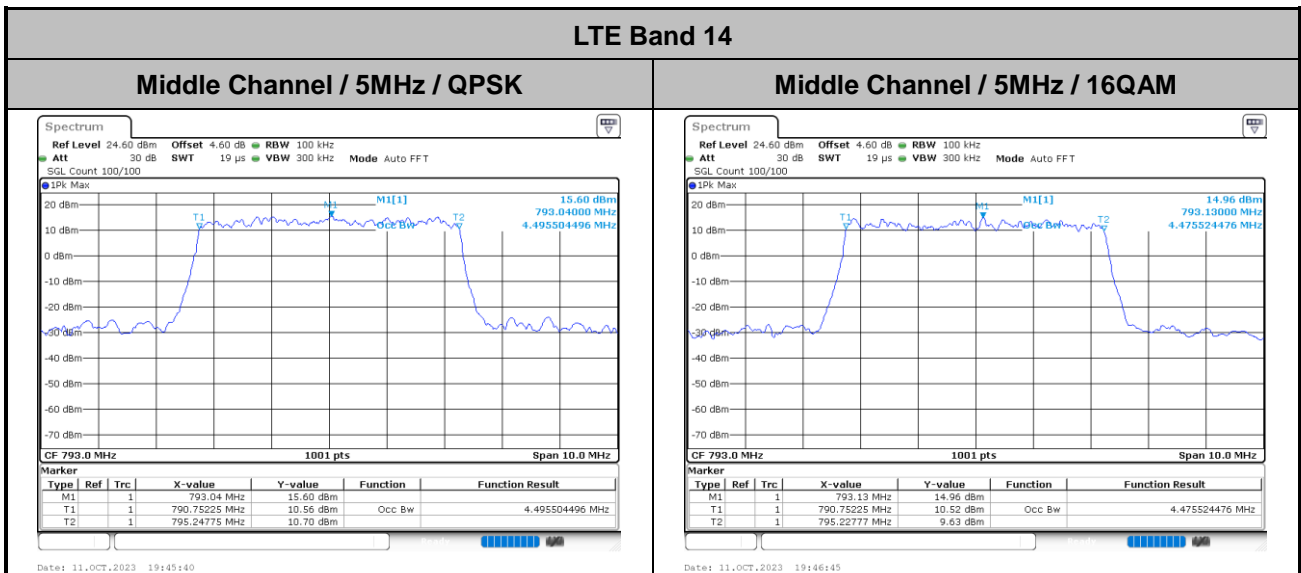





# Conducted Band Edge

## LTE Band 14 / 5MHz / QPSK

### Lowest Band Edge / 1 RB

### Highest Band Edge / 1 RB

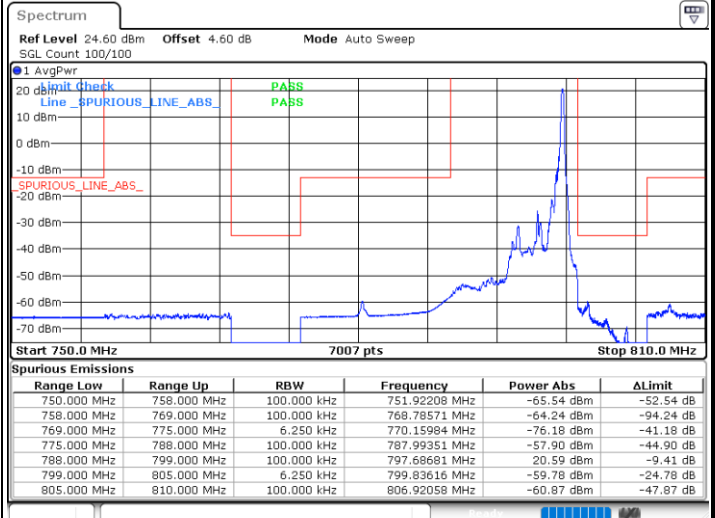
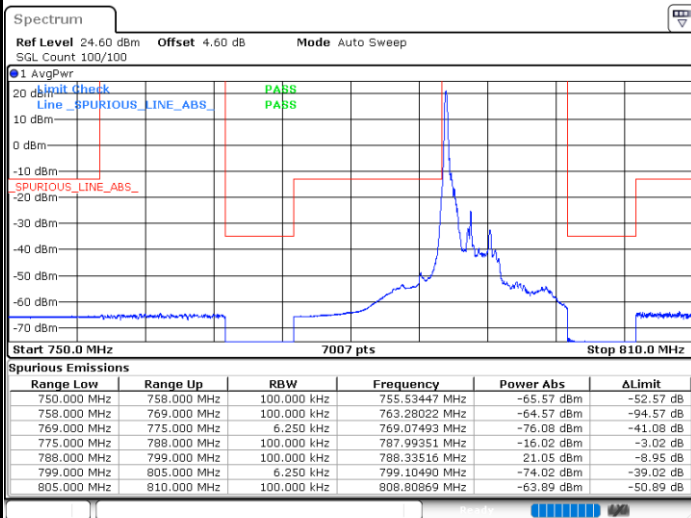

Date: 11.OCT.2023 18:31:49

Date: 11.OCT.2023 18:42:53

### Lowest Band Edge / Full RB

### Highest Band Edge / Full RB

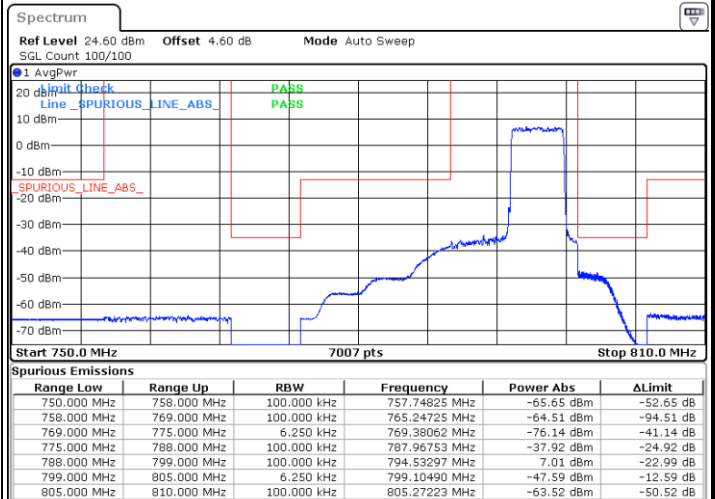
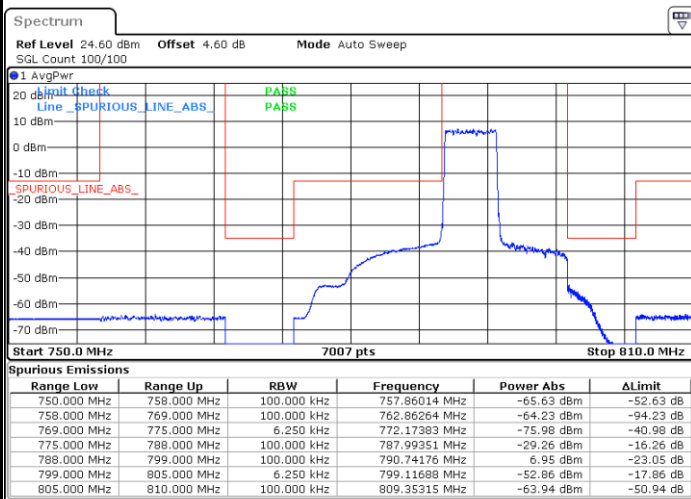

Date: 11.OCT.2023 18:37:55

Date: 11.OCT.2023 18:48:58



LTE Band 14 / 5MHz / 16QAM

Lowest Band Edge /1 RB

Highest Band Edge / 1 RB

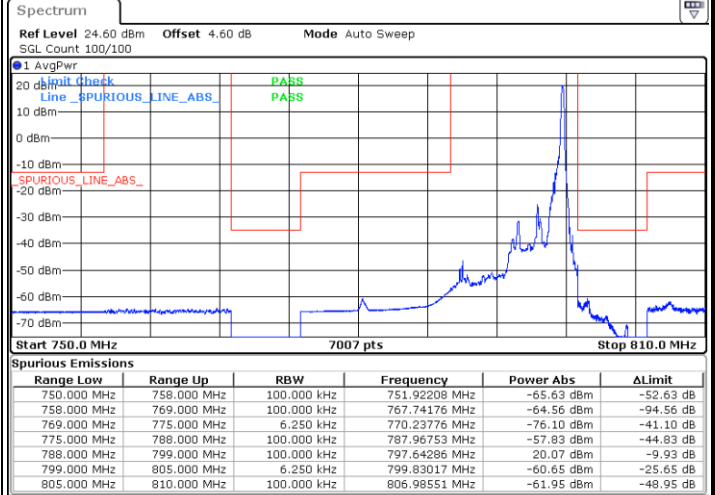
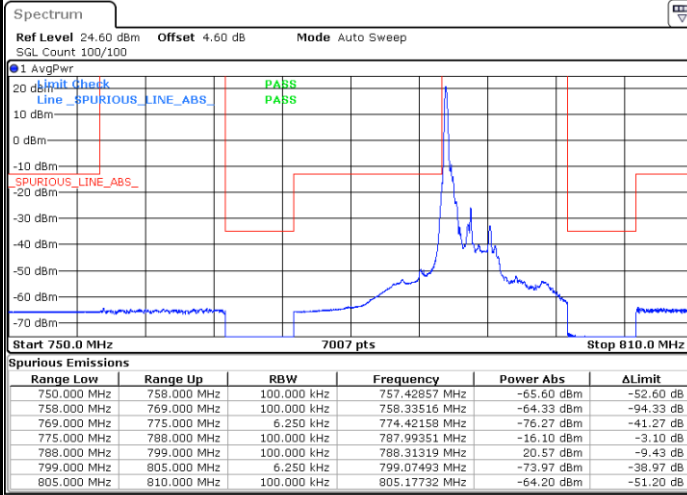

Date: 11.OCT.2023 18:33:02

Date: 11.OCT.2023 18:44:06

Lowest Band Edge / Full RB

Highest Band Edge / Full RB

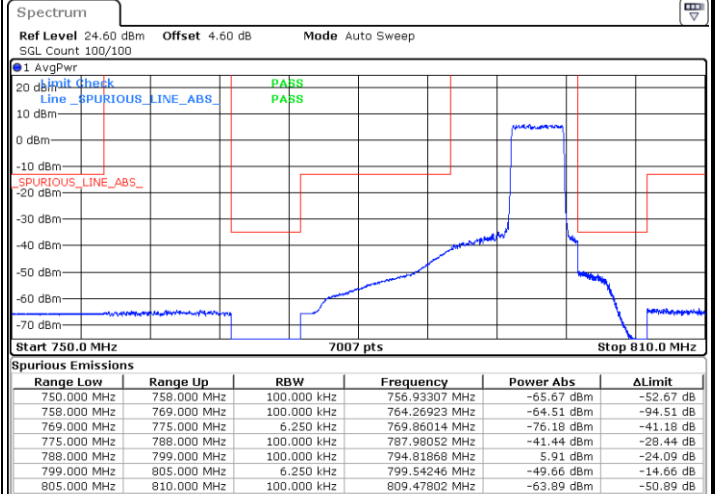
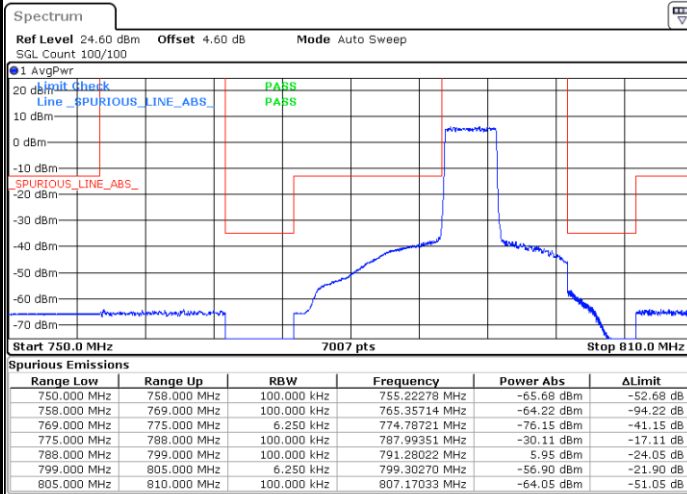

Date: 11.OCT.2023 18:36:42

Date: 11.OCT.2023 18:47:45



LTE Band 14 / 5MHz / 64QAM

Lowest Band Edge / 1 RB

Highest Band Edge / 1 RB

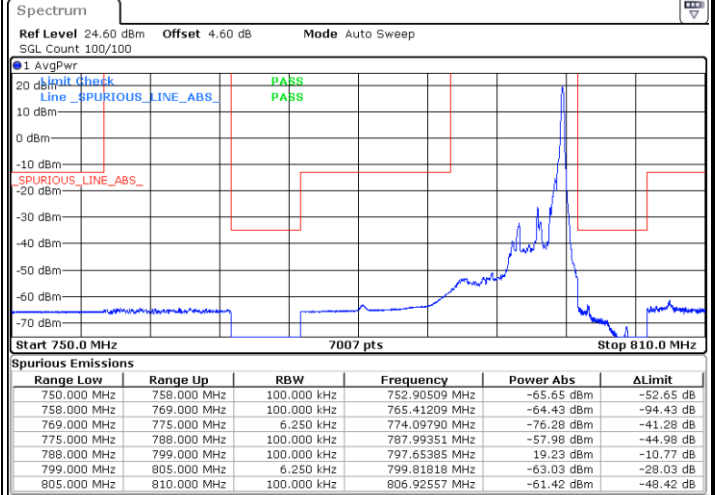
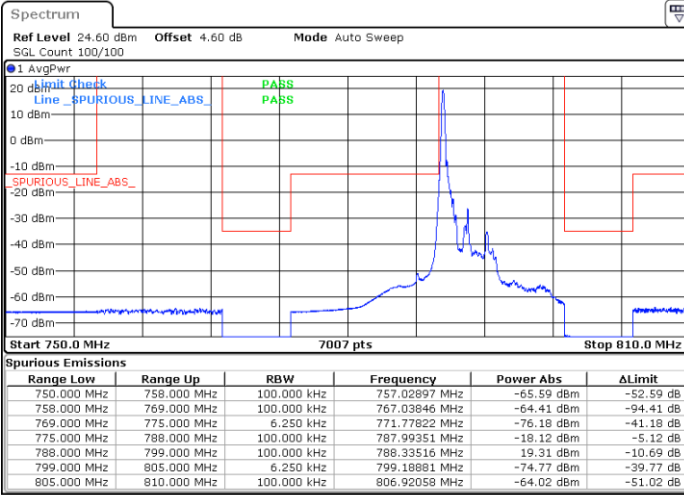

Date: 11.OCT.2023 18:34:15

Date: 11.OCT.2023 18:45:19

Lowest Band Edge / Full RB

Highest Band Edge / Full RB

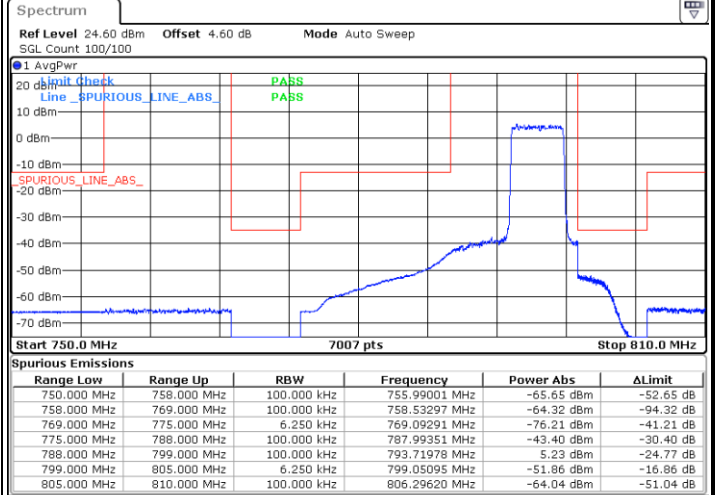
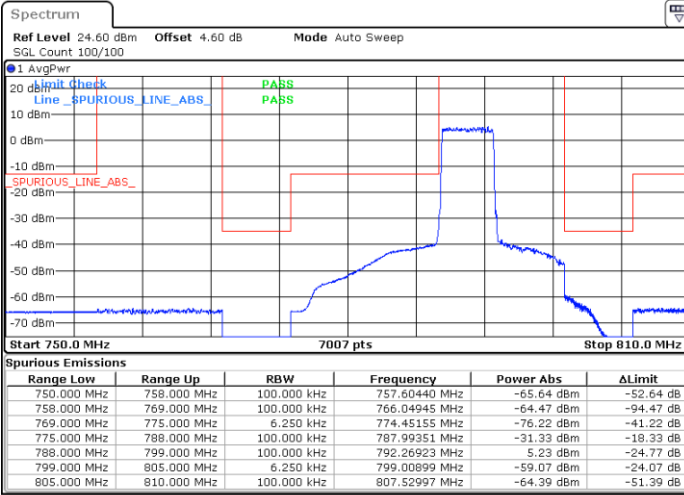

Date: 11.OCT.2023 18:35:29

Date: 11.OCT.2023 18:46:32



LTE Band 14 / 10MHz / QPSK

Lowest Band Edge / 1 RB

Highest Band Edge / 1 RB

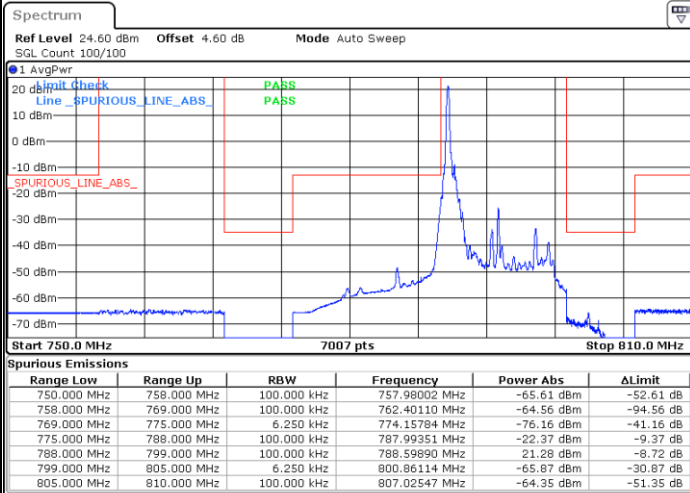

Date: 11.OCT.2023 18:51:26

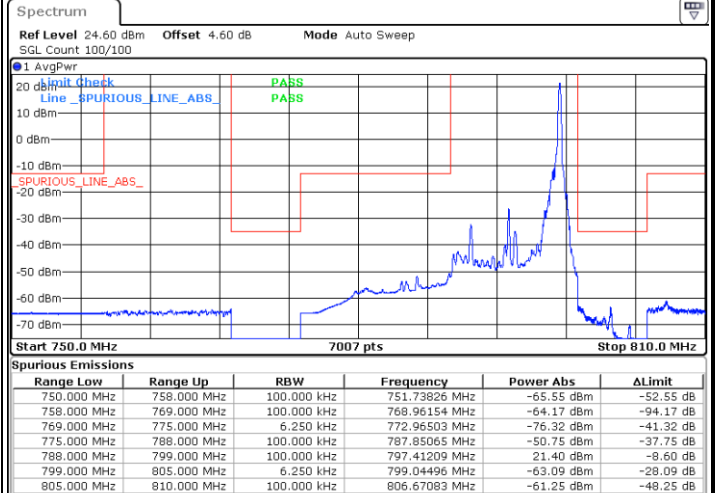

Date: 11.OCT.2023 18:57:30

Band Edge / Full RB

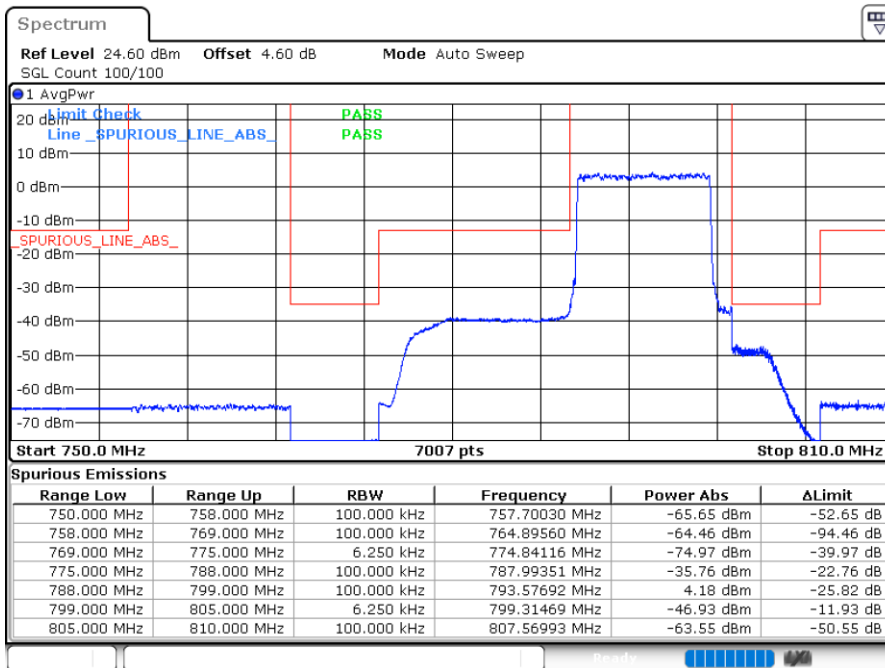

Date: 11.OCT.2023 18:58:54



LTE Band 14 / 10MHz / 16QAM

Lowest Band Edge / 1 RB

Highest Band Edge / 1 RB

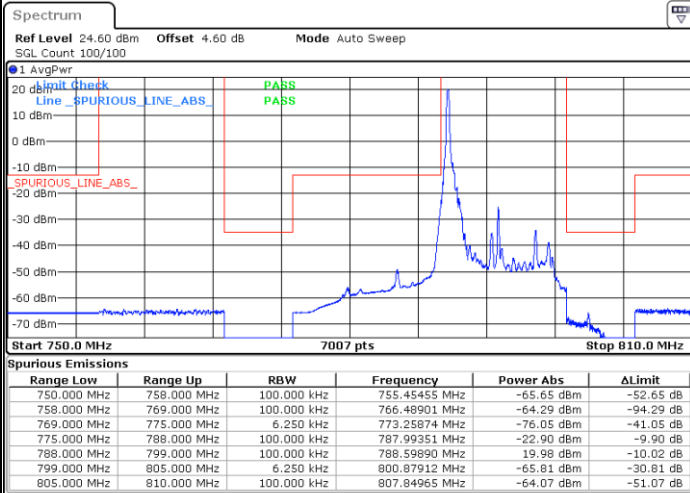

Date: 11.OCT.2023 18:52:39

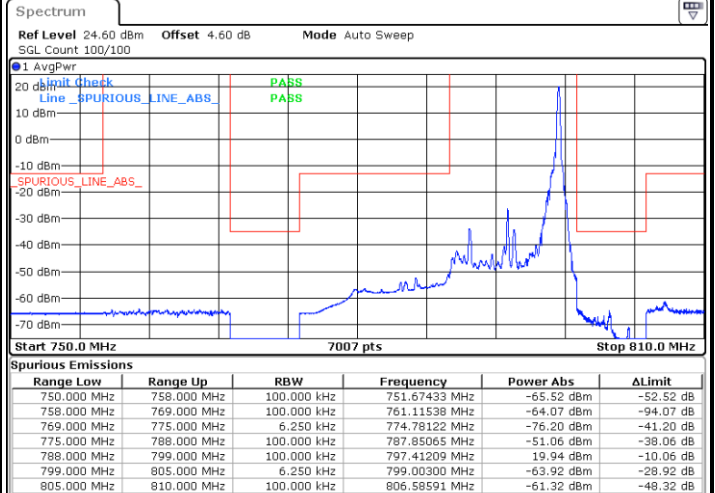

Date: 11.OCT.2023 18:56:17

Band Edge / Full RB

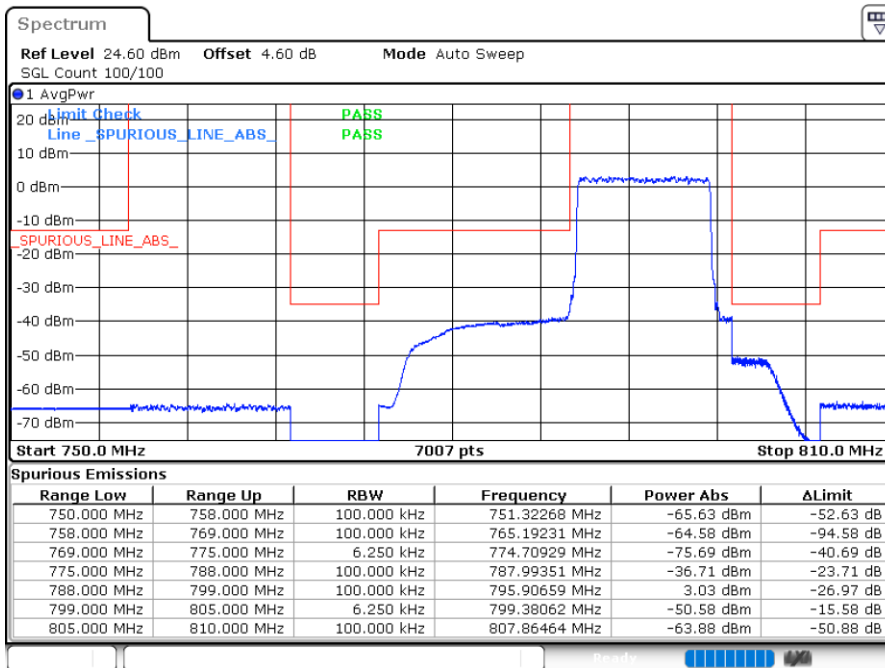

Date: 11.OCT.2023 19:00:06



LTE Band 14 / 10MHz / 64QAM

Lowest Band Edge / 1 RB

Highest Band Edge / 1 RB

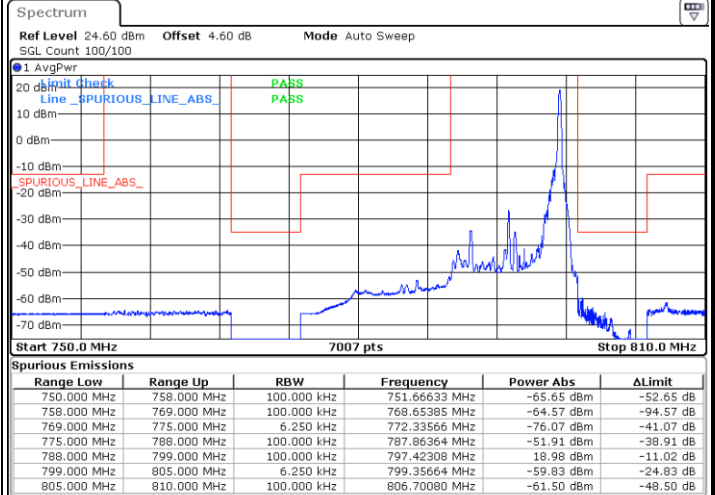
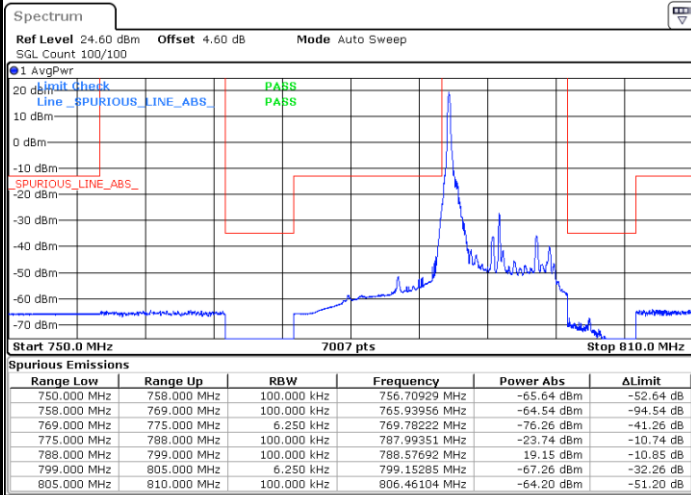

Date: 11.OCT.2023 18:53:52

Date: 11.OCT.2023 18:55:05

Band Edge / Full RB

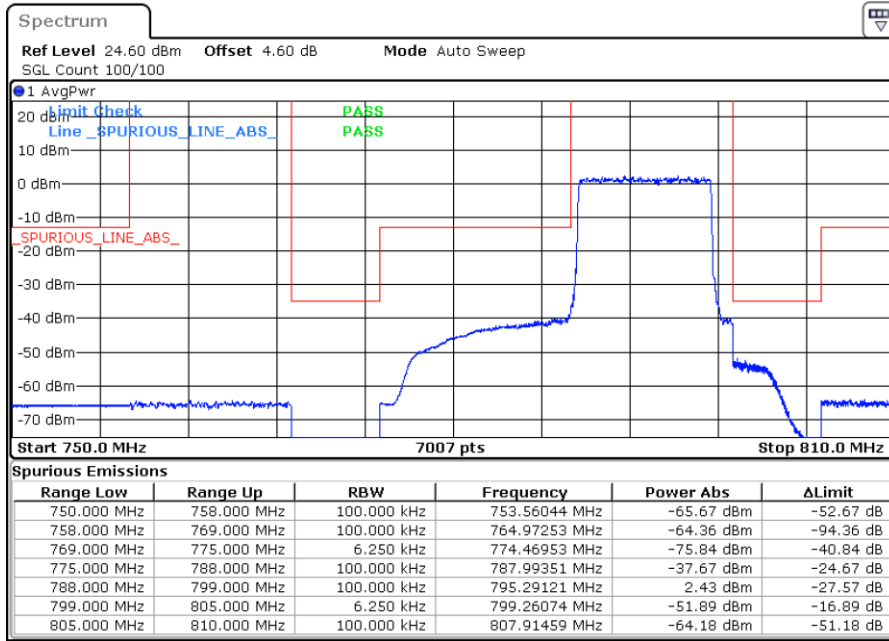

Date: 11.OCT.2023 19:01:19



# Conducted Spurious Emission

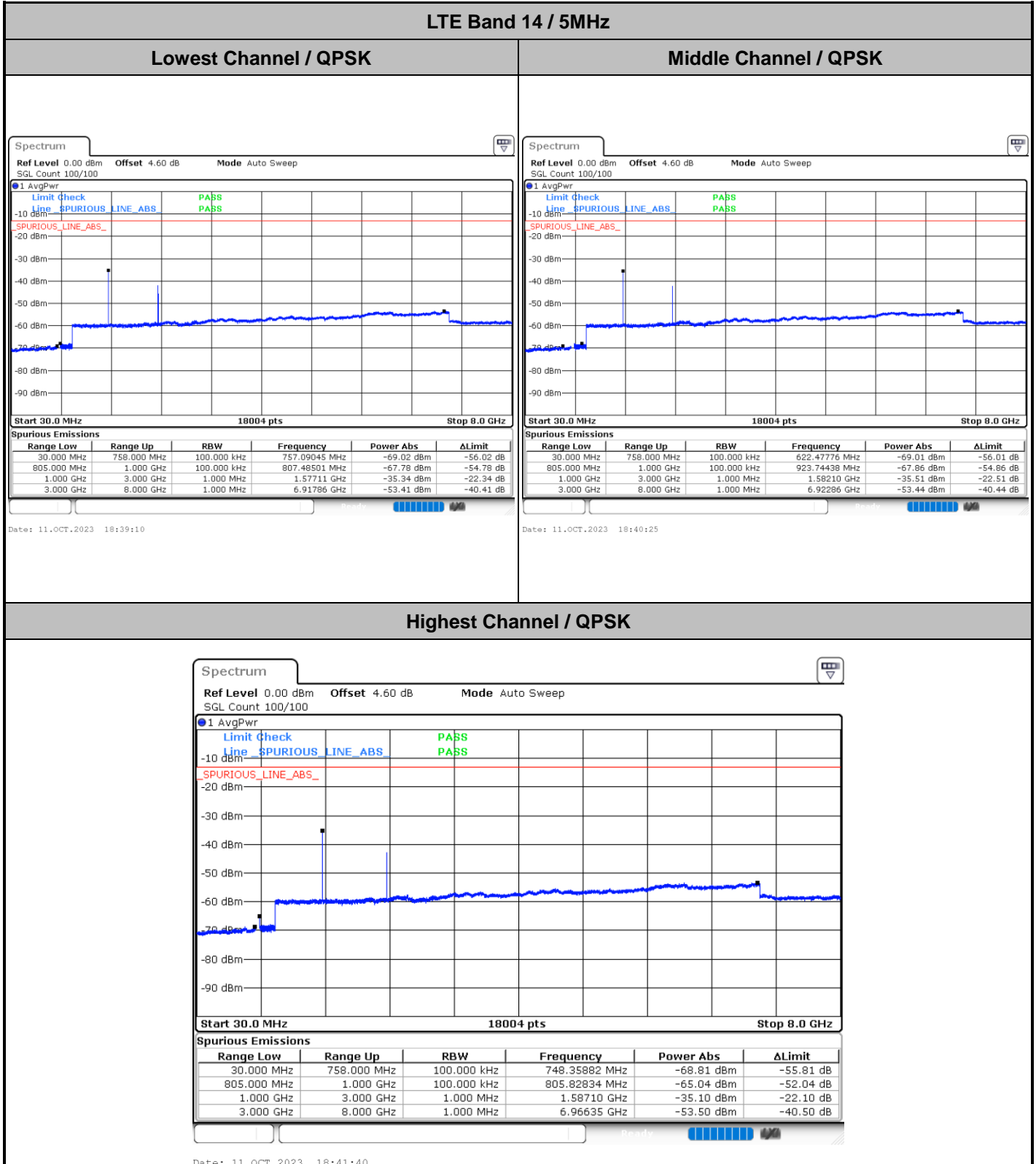



LTE Band 14 / 10MHz

Middle Channel / QPSK

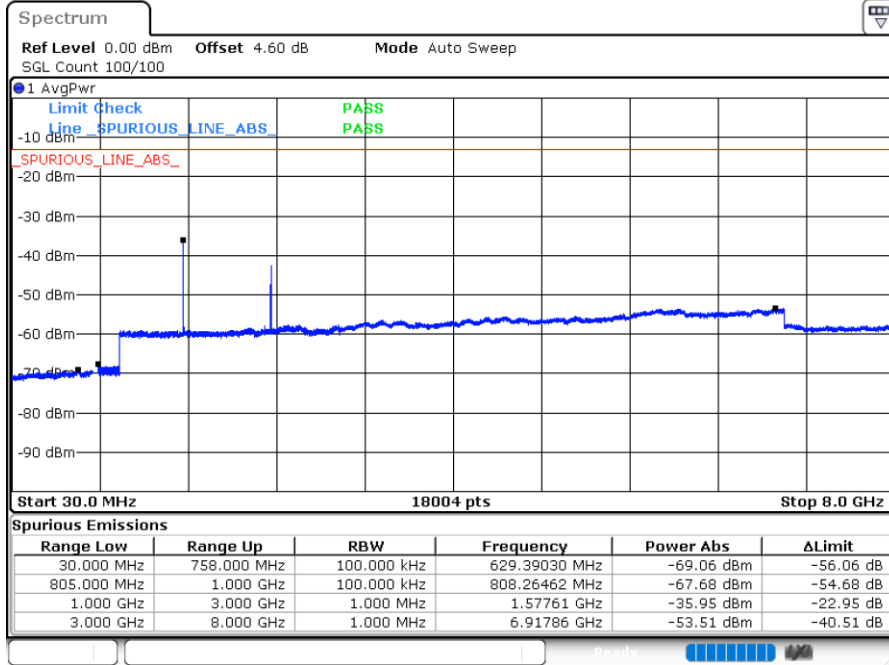

Date: 11.OCT.2023 18:50:14



**MASK**

**LTE Band 14 / 5MHz / QPSK**

**Lowest Channel / 1RB**

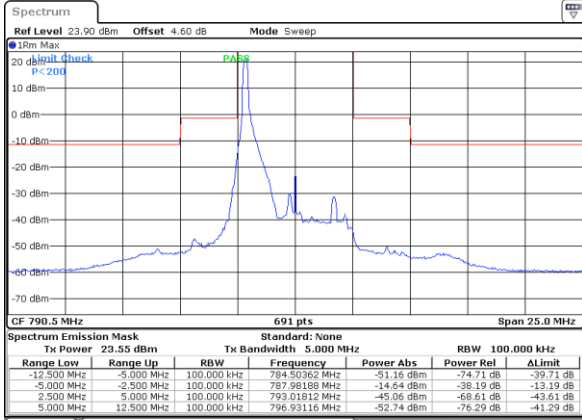

Date: 11.OCT.2023 19:44:33

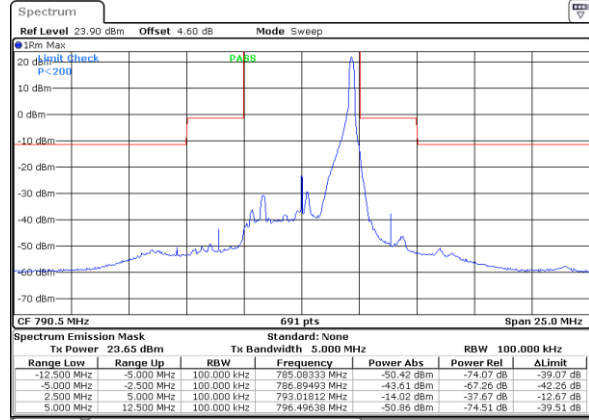

Date: 11.OCT.2023 19:25:40

**Lowest Channel / Full RB**

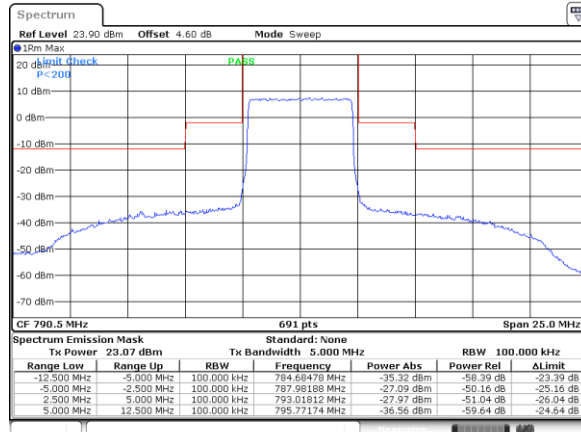

Date: 11.OCT.2023 19:25:03

**LTE Band 14 / 5MHz / 16QAM**

**Lowest Channel / 1RB**

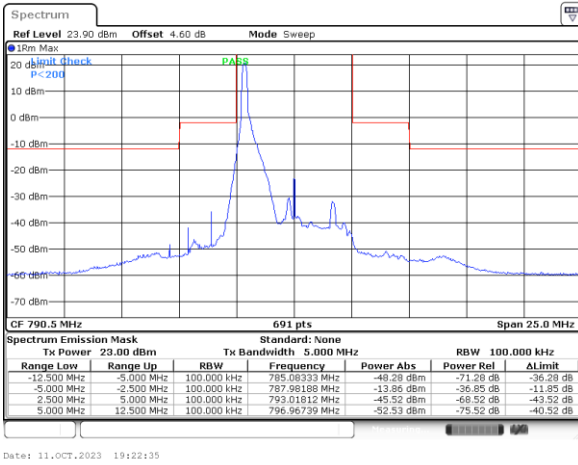

Date: 11.OCT.2023 19:22:35

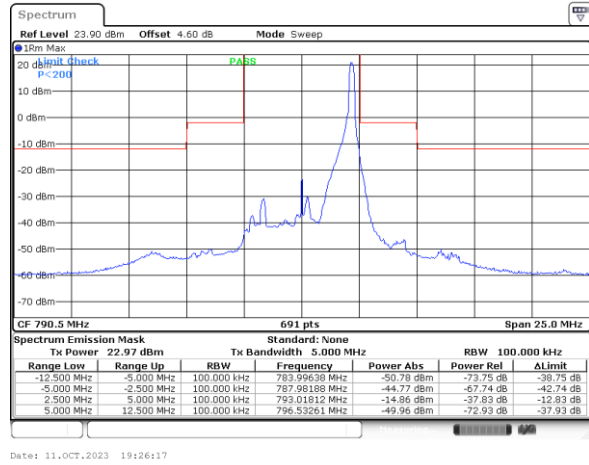

Date: 11.OCT.2023 19:26:17

**Lowest Channel / Full RB**

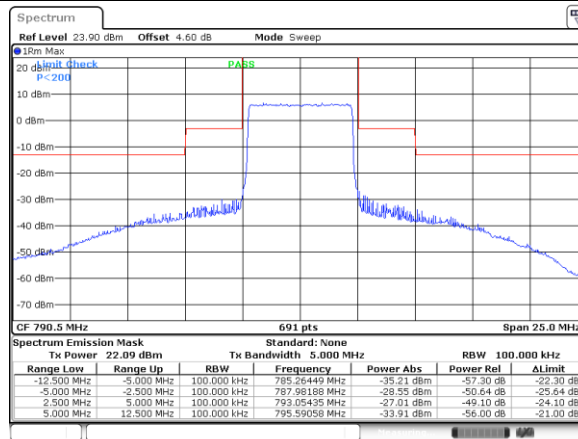

Date: 11.OCT.2023 19:24:26



LTE Band 14 / 5MHz / 64QAM

Lowest Channel / 1RB

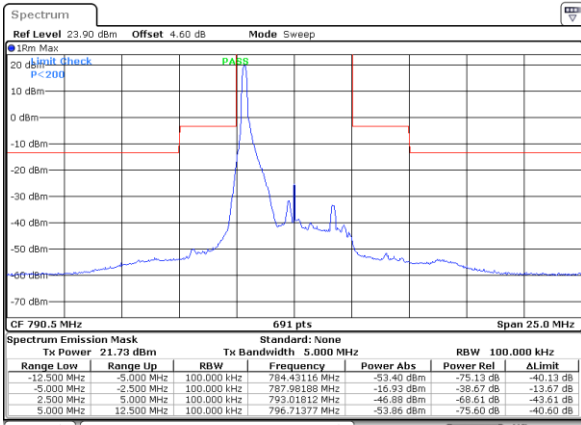

Date: 11.OCT.2023 19:23:12

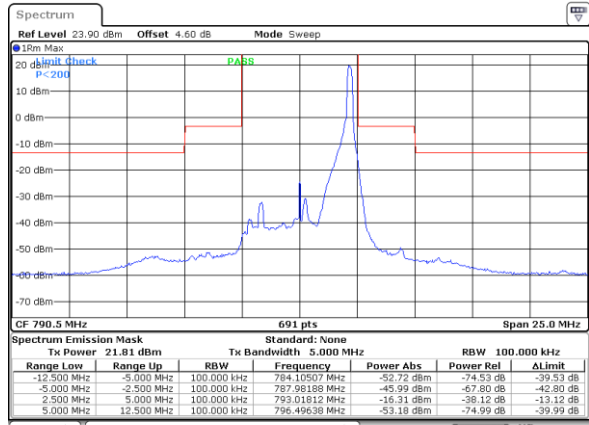

Date: 11.OCT.2023 19:26:54

Lowest Channel / Full RB

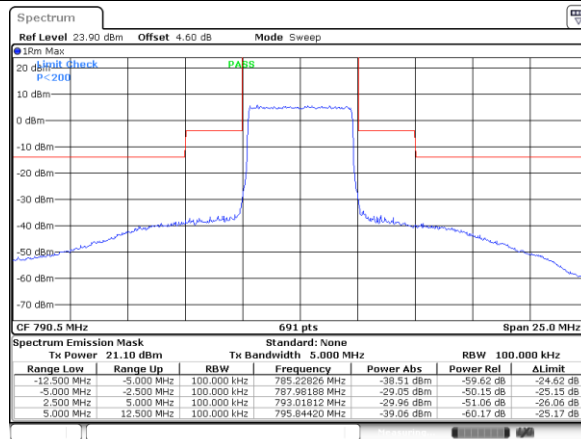

Date: 11.OCT.2023 19:23:49

**LTE Band 14 / 5MHz / QPSK**

**Middle Channel / 1RB**

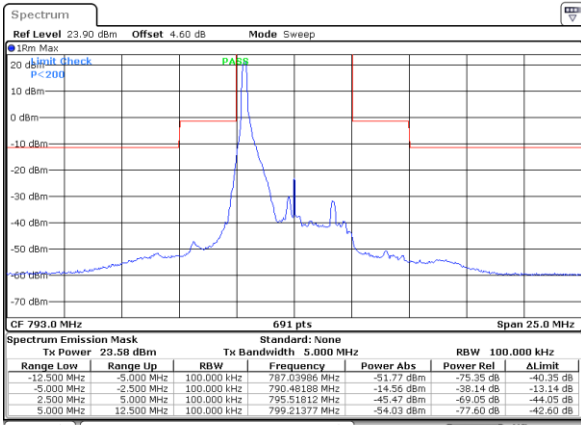

Date: 11.OCT.2023 19:27:30

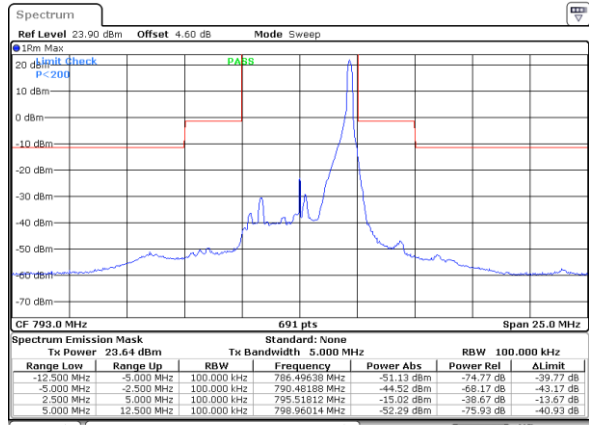

Date: 11.OCT.2023 19:30:32

**Middle Channel / Full RB**

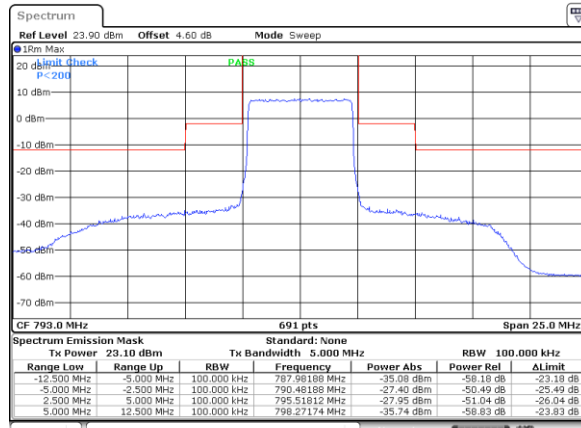

Date: 11.OCT.2023 19:31:09

**LTE Band 14 / 5MHz / 16QAM**

**Middle Channel / 1RB**

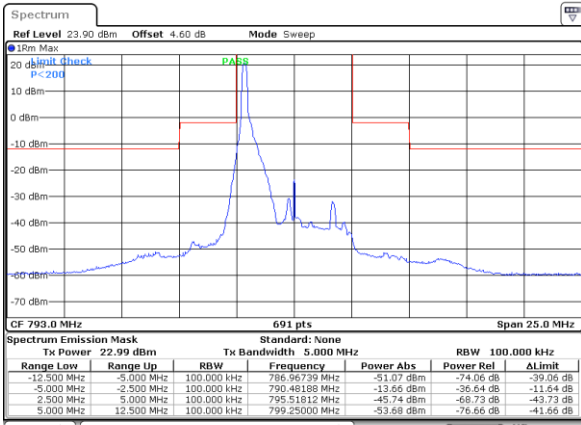

Date: 11.OCT.2023 19:28:07

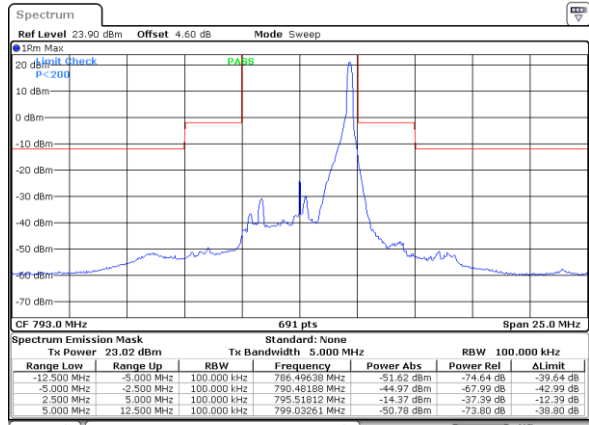

Date: 11.OCT.2023 19:29:56

**Middle Channel / Full RB**

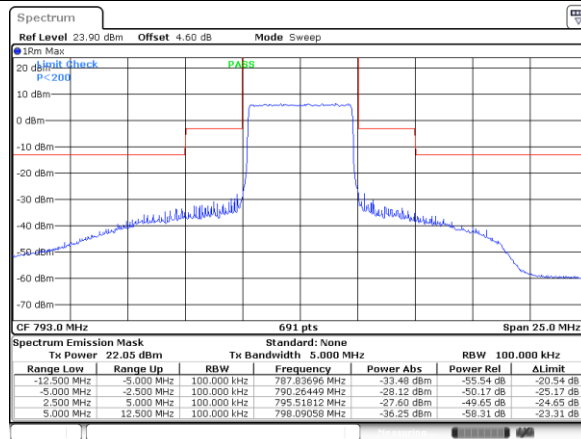

Date: 11.OCT.2023 19:31:45

**LTE Band 14 / 5MHz / 64QAM**

**Middle Channel / 1RB**

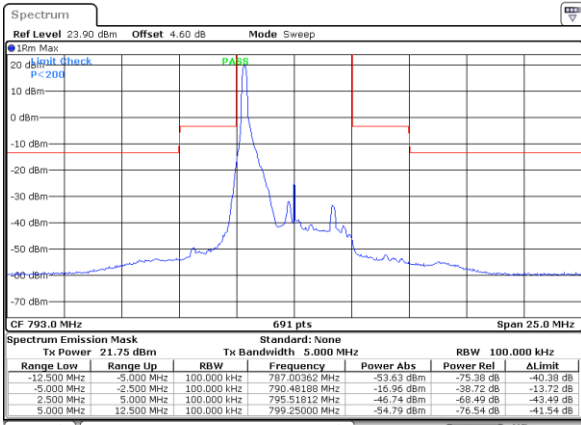

Date: 11.OCT.2023 19:28:43

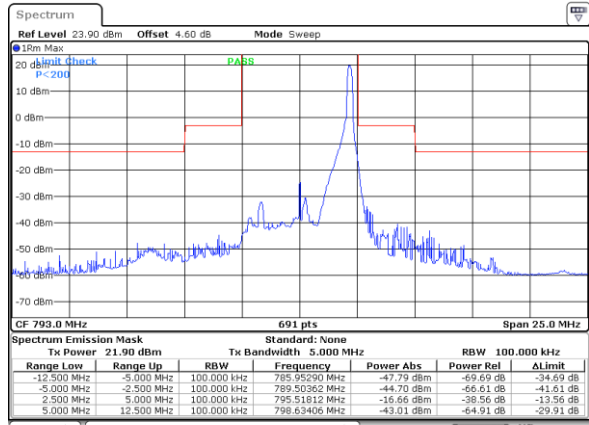

Date: 11.OCT.2023 19:29:20

**Middle Channel / Full RB**

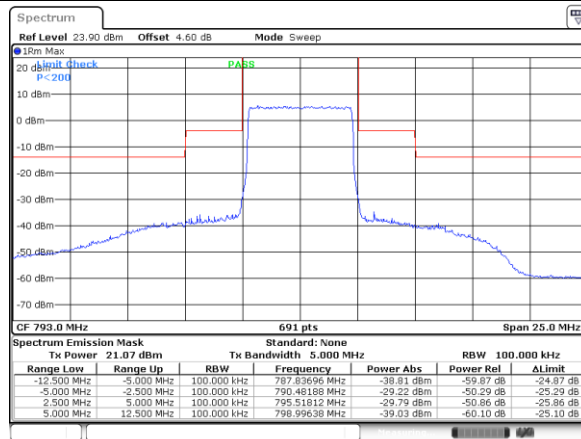

Date: 11.OCT.2023 19:32:22

**LTE Band 14 / 5MHz / QPSK**

**Highest Channel / 1RB**

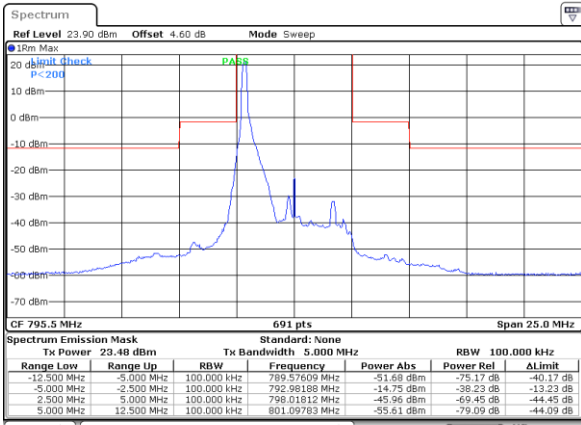

Date: 11.OCT.2023 19:32:58

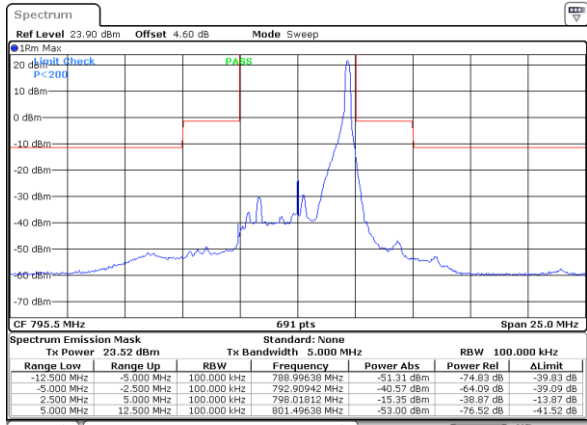

Date: 11.OCT.2023 19:34:49

**Highest Channel / Full RB**

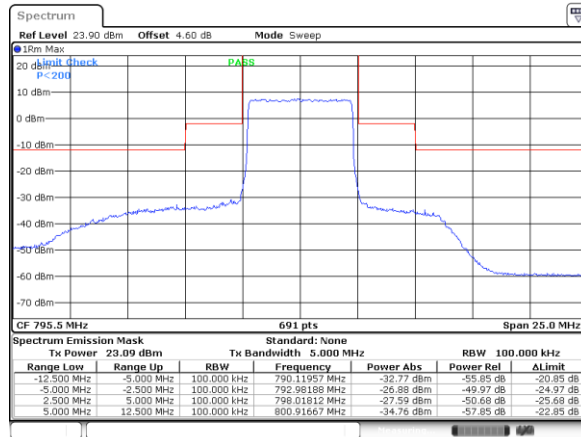

Date: 11.OCT.2023 19:37:53

**LTE Band 14 / 5MHz / 16QAM**

**Highest Channel / 1RB**

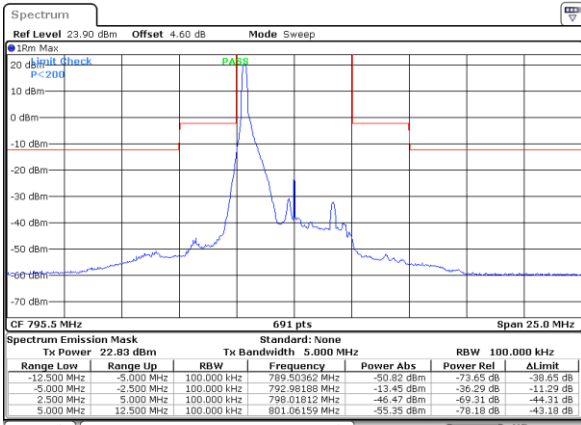

Date: 11.OCT.2023 19:33:35

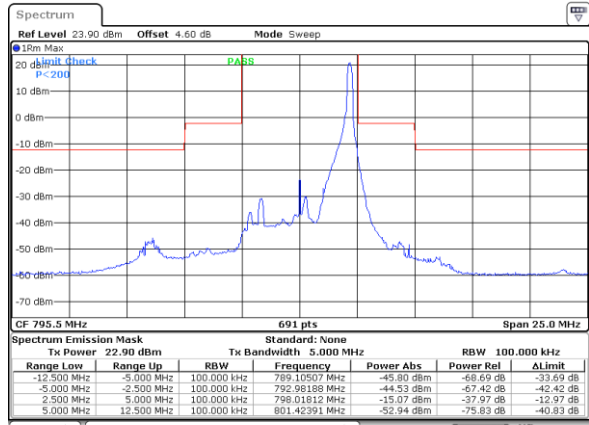

Date: 11.OCT.2023 19:35:26

**Highest Channel / Full RB**

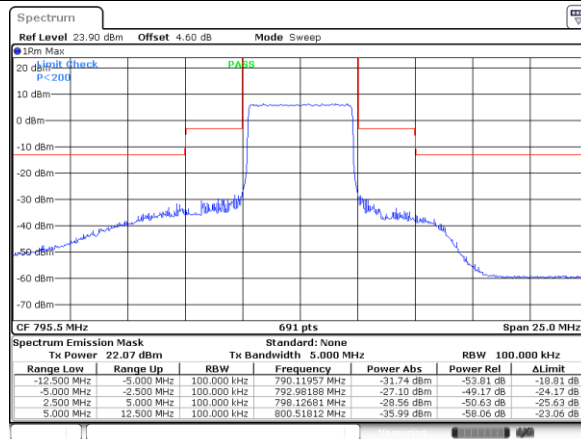

Date: 11.OCT.2023 19:37:17



LTE Band 14 / 5MHz / 64QAM

Highest Channel / 1RB

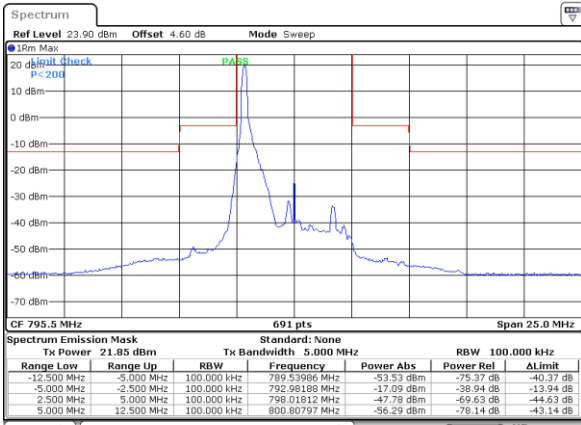

Date: 11.OCT.2023 19:134:12

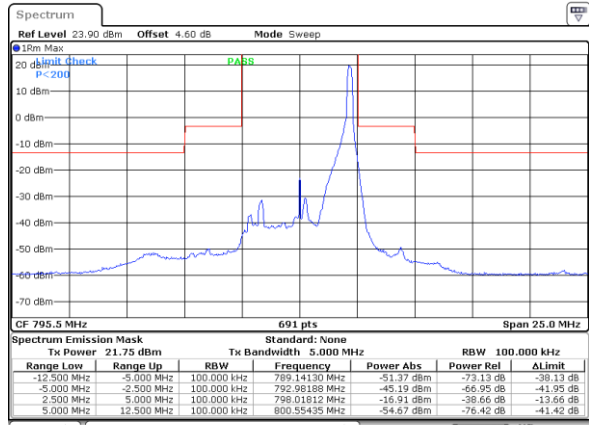

Date: 11.OCT.2023 19:136:03

Highest Channel / Full RB

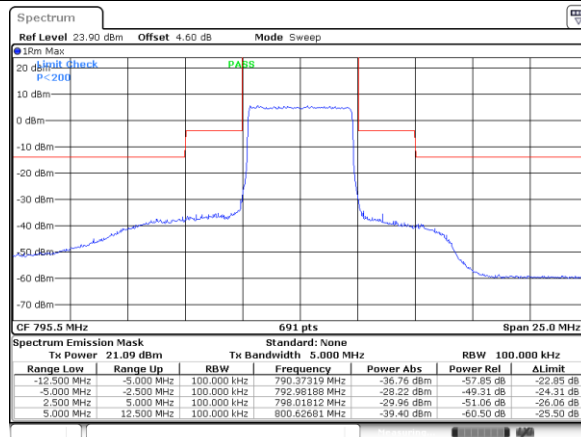

Date: 11.OCT.2023 19:136:40

**LTE Band 14 / 10MHz / QPSK**

**Middle Channel / 1RB**

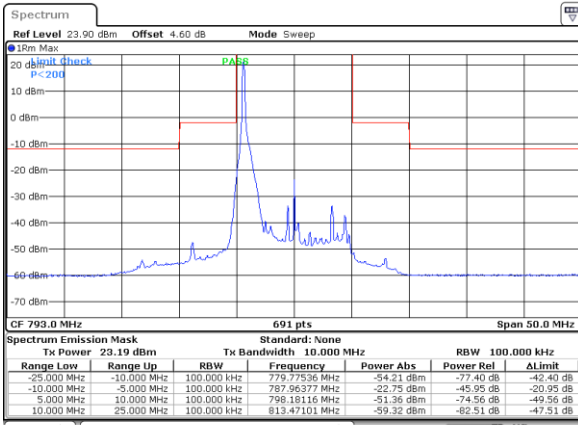

Date: 11.OCT.2023 19:38:31

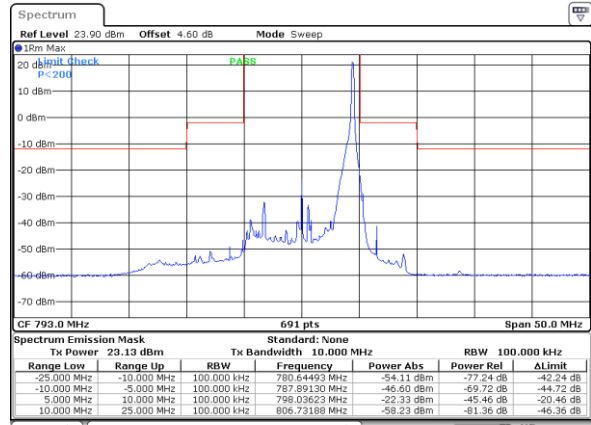

Date: 11.OCT.2023 19:41:33

**Middle Channel / Full RB**

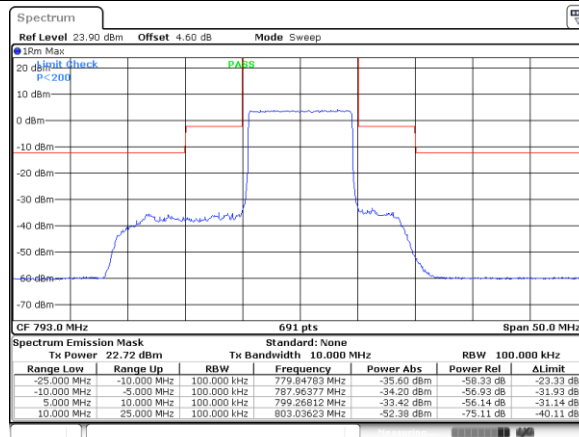

Date: 11.OCT.2023 19:42:09

**LTE Band 14 / 10MHz / 16QAM**

**Middle Channel / 1RB**

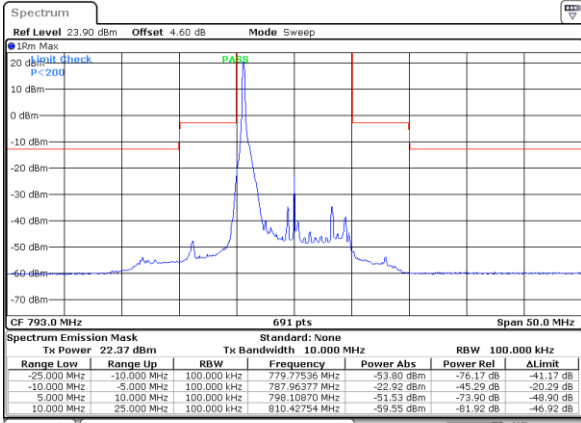

Date: 11.OCT.2023 19:39:07

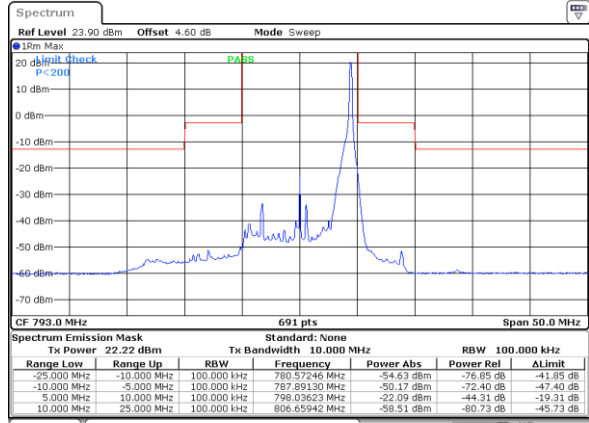

Date: 11.OCT.2023 19:40:56

**Middle Channel / Full RB**

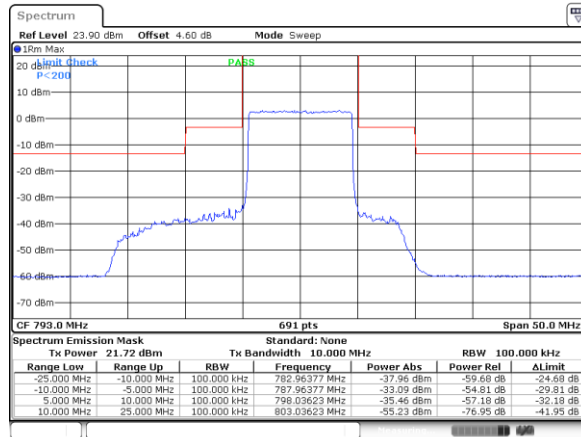

Date: 11.OCT.2023 19:42:46

**LTE Band 14 / 10MHz / 64QAM**

**Middle Channel / 1RB**

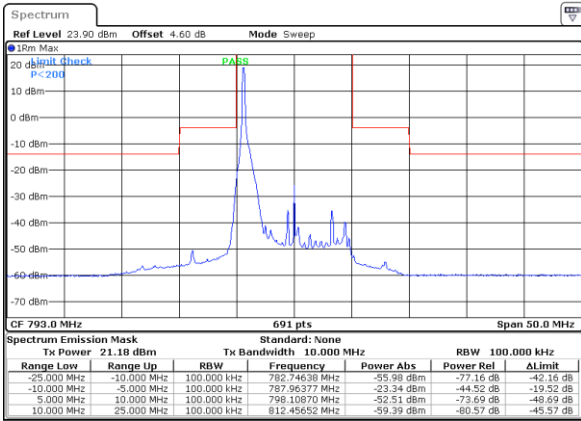

Date: 11.OCT.2023 19:39:43

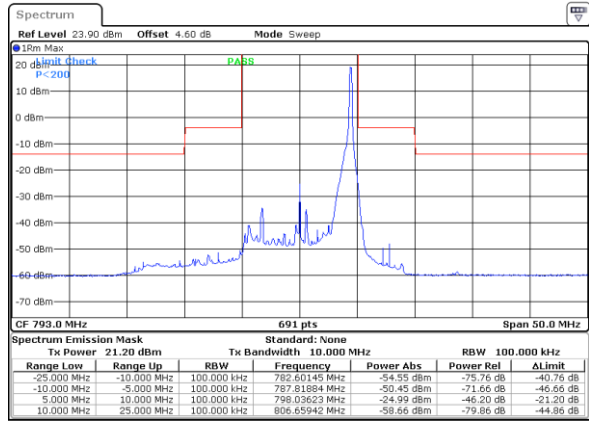

Date: 11.OCT.2023 19:40:20

**Middle Channel / Full RB**

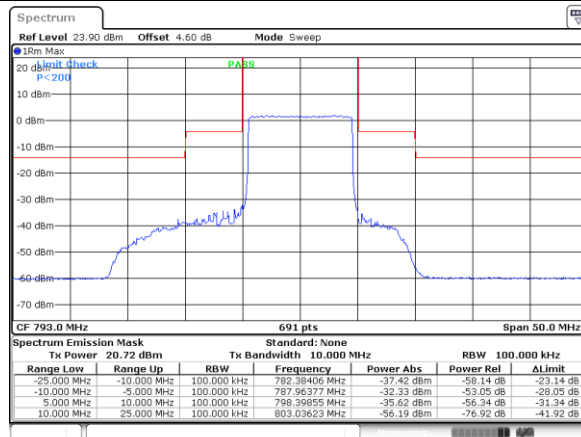

Date: 11.OCT.2023 19:43:22



### Frequency Stability

Test Conditions		LTE Band 14 (QPSK) / Middle Channel	Limit
Temperature (°C)	Voltage (Volt)	BW 5MHz	1.25 ppm
		Deviation (ppm)	Result
50	Normal Voltage	0.0017	PASS
40	Normal Voltage	0.0030	
30	Normal Voltage	0.0015	
20(Ref.)	Normal Voltage	0.0000	
10	Normal Voltage	0.0021	
0	Normal Voltage	0.0036	
-10	Normal Voltage	0.0025	
-20	Normal Voltage	0.0011	
-30	Normal Voltage	0.0028	
20	Maximum Voltage	0.0031	
20	Normal Voltage	0.0013	
20	Battery End Point	0.0026	



Test Conditions		LTE Band 14 (QPSK) / Middle Channel	Limit
Temperature (°C)	Voltage (Volt)	BW 10MHz	1.25 ppm
		Deviation (ppm)	Result
50	Normal Voltage	0.0023	PASS
40	Normal Voltage	0.0018	
30	Normal Voltage	0.0034	
20(Ref.)	Normal Voltage	0.0000	
10	Normal Voltage	0.0012	
0	Normal Voltage	0.0025	
-10	Normal Voltage	0.0033	
-20	Normal Voltage	0.0021	
-30	Normal Voltage	0.0017	
20	Maximum Voltage	0.0033	
20	Normal Voltage	0.0045	
20	Battery End Point	0.0022	

Note:

- 1. Normal Voltage =3.91 V. ; Battery End Point (BEP) =3.6 V. ; Maximum Voltage =4.45 V.
- 2. Note: The frequency fundamental emissions stay within the authorized frequency block.

**ERP**

LTE Band 14 ( $G_T - L_C = -4.90$ dBi) QPSK For Ant.0						
Bandwidth	5M			10M		
Channel	23305	23330	23355		23330	
	(Low)	(Mid)	(High)		(Mid)	
Frequency (MHz)	790.5	793	795.5		793	
Conducted Power (dBm)	22.59	22.71	22.69		22.77	
Conducted Power (Watts)	0.1816	0.1866	0.1858		0.1892	
ERP(dBm)	15.54	15.66	15.64		15.72	
ERP(Watts)	0.0358	0.0368	0.0366		0.0373	

LTE Band 14 ( $G_T - L_C = -4.90$ dBi) 16QAM For Ant.0						
Bandwidth	5M			10M		
Channel	23305	23330	23355		23330	
	(Low)	(Mid)	(High)		(Mid)	
Frequency (MHz)	790.5	793	795.5		793	
Conducted Power (dBm)	21.88	21.99	21.95		22.04	
Conducted Power (Watts)	0.1542	0.1581	0.1567		0.1600	
ERP(dBm)	14.83	14.94	14.90		14.99	
ERP(Watts)	0.0304	0.0312	0.0309		0.0316	



LTE Band 14 ( $G_T - L_C = -4.90$ dBi) 64QAM For Ant.0						
Bandwidth	5M			10M		
Channel	23305	23330	23355		23330	
	(Low)	(Mid)	(High)		(Mid)	
Frequency	790.5	793	795.5		793	
(MHz)						
Conducted Power (dBm)	20.75	20.94	20.93		20.92	
Conducted Power (Watts)	0.1189	0.1242	0.1239		0.1236	
ERP(dBm)	13.70	13.89	13.88		13.87	
ERP(Watts)	0.0234	0.0245	0.0244		0.0244	



## Appendix B. Test Results of Radiated Test

### Field Strength of Spurious Radiated

Test Engineer :	HuaCong Liang	Temperature :	22~25°C
		Relative Humidity :	48~52%

Pre-scanned harmonic for the different antennas, we choose the worst antenna mode to perform final test and record in the report.

LTE Band 14 / 5MHz / QPSK ANT0									
Channel	Frequency ( MHz )	ERP ( dBm )	Limit ( dBm )	Over Limit ( dB )	SPA Reading (dBm)	S.G. Power ( dBm )	TX Cable loss ( dB )	TX Antenna Gain (dBi)	Polarization (H/V)
Lowest	1576.5	-63.88	-42.15	-21.73	-70.31	-67.11	3.98	9.36	H
	2364.75	-50.68	-13	-37.68	-61.25	-54.23	4.85	10.55	H
	3153	-63.18	-13	-50.18	-75.99	-68.11	5.50	12.58	H
	1576.5	-65.55	-42.15	-23.40	-72.21	-68.78	3.98	9.36	V
	2364.75	-51.96	-13	-38.96	-62.94	-55.51	4.85	10.55	V
	3153	-62.91	-13	-49.91	-76.28	-67.84	5.50	12.58	V
Middle	1581.5	-65.86	-42.15	-23.71	-72.27	-69.11	4.00	9.40	H
	2372.25	-50.80	-13	-37.80	-61.34	-54.37	4.88	10.60	H
	3163	-63.23	-13	-50.23	-76.08	-68.16	5.52	12.60	H
	1581.5	-65.22	-42.15	-23.07	-71.87	-68.47	4.00	9.40	V
	2372.25	-52.10	-13	-39.10	-63.04	-55.67	4.88	10.60	V
	3163	-62.57	-13	-49.57	-75.99	-67.50	5.52	12.60	V
Highest	1586.5	-66.84	-42.15	-24.69	-73.20	-70.01	4.10	9.42	H
	2379.75	-49.94	-13	-36.94	-60.44	-53.52	4.90	10.63	H
	3173	-63.15	-13	-50.15	-76.05	-68.07	5.55	12.62	H
	1586.5	-66.44	-42.15	-24.29	-73.03	-69.61	4.10	9.42	V
	2379.75	-51.31	-13	-38.31	-62.22	-54.89	4.90	10.63	V
	3173	-62.75	-13	-49.75	-76.23	-67.67	5.55	12.62	V

Remark: Spurious emissions within 30-1000MHz were found more than 20dB below limit line.

LTE Band 14 / 10MHz / QPSK ANT0									
Channel	Frequency ( MHz )	ERP ( dBm )	Limit ( dBm )	Over Limit ( dB )	SPA Reading (dBm)	S.G. Power ( dBm )	TX Cable loss ( dB )	TX Antenna Gain (dBi)	Polarization (H/V)
Middle	1577	-64.87	-42.15	-22.72	-71.30	-68.12	4.00	9.40	H
	2365.5	-51.67	-13	-38.67	-62.24	-55.24	4.88	10.60	H
	3154	-63.49	-13	-50.49	-76.31	-68.42	5.52	12.60	H
	1577	-65.54	-42.15	-23.39	-72.19	-68.79	4.00	9.40	V
	2365.5	-51.44	-13	-38.44	-62.41	-55.01	4.88	10.60	V
	3154	-62.96	-13	-49.96	-76.33	-67.89	5.52	12.60	V