



FCC RF Test Report

APPLICANT : Motorola Mobility LLC
EQUIPMENT : Mobile Cellular Phone
BRAND NAME : Motorola
MODEL NAME : XT2415-1, XT2415-3, XT2415-5, XT2415V
FCC ID : IHDT56AN5
STANDARD : 47 CFR Part 2, 27
CLASSIFICATION : PCS Licensed Transmitter Held to Ear (PCE)
TEST DATE(S) : Sep. 25, 2023 ~ Oct. 16, 2023

We, Sporton International Inc. (ShenZhen), would like to declare that the tested sample has been evaluated in accordance with the procedures given in ANSI C63.26-2015 and shown compliance with the applicable technical standards.

The test results in this report apply exclusively to the tested model / sample. Without written approval of Sporton International Inc. (ShenZhen), the test report shall not be reproduced except in full.

Jason Jia

Approved by: Jason Jia



Sporton International Inc. (ShenZhen)

1/F, 2/F, Bldg 5, Shiling Industrial Zone, Xinwei Village, Xili, Nanshan, Shenzhen, 518055

People's Republic of China



TABLE OF CONTENTS

REVISION HISTORY...3
SUMMARY OF TEST RESULT...4
1 GENERAL DESCRIPTION...5
1.1 Applicant...5
1.2 Manufacturer...5
1.3 Product Feature of Equipment Under Test...5
1.4 Product Specification of Equipment Under Test...5
1.5 Modification of EUT...6
1.6 Specification of Accessory...7
1.7 Maximum EIRP and Emission Designator...7
1.8 Testing Location...8
1.9 Test Software...9
1.10 Applicable Standards...9
2 TEST CONFIGURATION OF EQUIPMENT UNDER TEST...10
2.1 Test Mode...10
2.2 Connection Diagram of Test System...12
2.3 Support Unit used in test configuration and system...12
2.4 Measurement Results Explanation Example...13
2.5 Frequency List of Low/Middle/High Channels...13
3 CONDUCTED TEST ITEMS...16
3.1 Measuring Instruments...16
3.2 Test Setup...16
3.3 Test Result of Conducted Test...16
3.4 Conducted Output Power and EIRP...17
3.5 Peak-to-Average Ratio...18
3.6 Occupied Bandwidth...19
3.7 Conducted Band Edge...20
3.8 Conducted Spurious Emission...22
3.9 Frequency Stability...23
4 RADIATED TEST ITEMS...24
4.1 Measuring Instruments...24
4.2 Test Setup...24
4.3 Test Result of Radiated Test...25
4.4 Radiated Spurious Emission...26
5 LIST OF MEASURING EQUIPMENT...27
6 MEASUREMENT UNCERTAINTY...28
APPENDIX A. TEST RESULTS OF CONDUCTED TEST
APPENDIX B. TEST RESULTS OF RADIATED TEST
APPENDIX C. TEST SETUP PHOTOGRAPHS



REVISION HISTORY

REPORT NO.	VERSION	DESCRIPTION	ISSUED DATE
FG391202K	Rev. 01	Initial issue of report	Oct. 25, 2023



SUMMARY OF TEST RESULT

Report Section	FCC Rule	Description	Limit	Result	Remark
3.4	§2.1046	Conducted Output Power	Reporting Only	PASS	-
	§27.50(h)(2)	Equivalent Isotropic Radiated Power (5G NR n7, n41)	EIRP < 2Watt		
	§27.50(d)(4)	Equivalent Isotropic Radiated Power (5G NR n66, n70)	EIRP < 1Watt		
3.5	N/A	Peak-to-Average Ratio	<13 dB	PASS	-
3.6	§2.1049	Occupied Bandwidth	Reporting Only	PASS	-
3.7	§2.1051 §27.53(h)	Conducted Band Edge Measurement (5G NR n66, n70)	< 43+10log ₁₀ (P[Watts])	PASS	-
	§27.53(m)(4)	Conducted Band Edge Measurement (5G NR n7, n41)	§27.53(m)(4)		
3.8	§2.1051 §27.53(h)	Conducted Spurious Emission (5G NR n66, n70)	< 43+10log ₁₀ (P[Watts])	PASS	-
	§2.1051 §27.53(m)(4)	Conducted Spurious Emission (5G NR n7, n41)	< 55+10log ₁₀ (P[Watts])		
3.9	§2.1055 §27.54	Frequency Stability Temperature & Voltage	Within Authorized Band	PASS	-
4.4	§2.1053 §27.53(h)	Radiated Spurious Emission (5G NR n66, n70)	< 43+10log ₁₀ (P[Watts])	PASS	Under limit 15.95 dB at 9222.00 MHz
	§2.1053 §27.53(m)(4)	Radiated Spurious Emission (5G NR n7, n41)	< 55+10log ₁₀ (P[Watts])		

Conformity Assessment Condition:

- The test results (PASS/FAIL) with all measurement uncertainty excluded are presented against the regulation limits or in accordance with the requirements stipulated by the applicant/manufacturer who shall bear all the risks of non-compliance that may potentially occur if measurement uncertainty is taken into account.
- The measurement uncertainty please refer to each test result in the section "Measurement Uncertainty"

Disclaimer:

The product specifications of the EUT presented in the test report that may affect the test assessments are declared by the manufacturer who shall take full responsibility for the authenticity.



1 General Description

1.1 Applicant

Motorola Mobility LLC
222 W,Merchandise Mart Plaza, Chicago IL 60654 USA

1.2 Manufacturer

Motorola Mobility LLC
222 W,Merchandise Mart Plaza, Chicago IL 60654 USA

1.3 Product Feature of Equipment Under Test

Product Feature	
Equipment	Mobile Cellular Phone
Brand Name	Motorola
Model Name	XT2415-1, XT2415-3, XT2415-5, XT2415V
FCC ID	IHDT56AN5
IMEI Code	Conducted: 357534480030391/357534480030409 Radiation: 357534480040630/357534480040648
HW Version	DVT2
SW Version	UUD34.38
EUT Stage	Identical Prototype

Remark:

1. The above EUT's information was declared by manufacturer. Please refer to the specifications or user's manual for more detailed description.
2. The four model names are only for market segment purpose, there is no other difference.

1.4 Product Specification of Equipment Under Test

Standards-related Product Specification	
Tx Frequency	5G NR n7 : 2500 MHz ~ 2570 MHz 5G NR n41 : 2496 MHz ~ 2690 MHz 5G NR n66 : 1710 MHz ~ 1780 MHz 5G NR n70 : 1695 MHz ~ 1710 MHz
Rx Frequency	5G NR n7 : 2620 MHz ~ 2690 MHz 5G NR n41 : 2496 MHz ~ 2690 MHz 5G NR n66 : 2110 MHz~ 2200 MHz 5G NR n70 : 1995 MHz ~ 2020 MHz
Bandwidth	n7 : 5MHz / 10MHz / 15MHz / 20MHz / 25MHz / 30MHz / 40MHz / 50MHz n41 : 10MHz / 15MHz / 20MHz / 30MHz / 40MHz / 50MHz / 60MHz / 70MHz / 80MHz / 90MHz / 100MHz n66: 5MHz / 10MHz / 15MHz / 20MHz / 25MHz / 30MHz / 35MHz / 40MHz / 45MHz



	n70: 5MHz / 10MHz / 15MHz (20MHz / 25MHz Downlink only)
SCS	n7, n66, n70 for 15kHz n41 for 30kHz
Antenna Gain	<p><Ant.0> n66 : -1.2 dBi n70 : -1.2 dBi</p> <p><Ant. 1> n7 : -0.4 dBi n41 : -0.4 dBi</p> <p><Ant. 2> n41 : -4.5 dBi</p> <p><Ant. 4> n41 : -0.5 dBi n66 : -1.5 dBi n70 : -1.5 dBi</p> <p><Ant. 7> n41 : -3.8 dBi</p>
Type of Modulation	CP-OFDM: QPSK / 16QAM / 64QAM / 256QAM DFT-s-OFDM: PI/2 BPSK / QPSK / 16QAM / 64QAM / 256QAM

Remark:

1. The maximum EIRP is calculated from max output power and max antenna gain, only the maximum EIRP are shown in the report, 5G NR n7/n41 for Ant. 1 and n66/n70 for Ant. 0.
2. 5G NR support SA (n7/n41/n66/n70) mode and NSA(n7/n41/n66) mode. According to the maximum power between SA and NSA mode, SA covers NSA mode.
3. 5G NR n41 supports HPUE mode.
4. The device supports n41(1T4R) SRS resources on ant.1/2/4/7, only the test data of worst ant.1 is showed in the report according to the maximum power.
5. The device supports two PAs for 5G NR n66 (main PA and other PA), the maximum power of main PA is higher than the other PA, therefore, we chose higher power of main PA to calculate the EIRP and show in section 1.7.
6. All the supported ENDC combinations are verified conducted power, only the ENDC combination with highest power are shown in the report.
7. The EN-DC mode combination could be referred to the product spec.

1.5 Modification of EUT

No modifications are made to the EUT during all test items.



1.6 Specification of Accessory

Accessories Information				
AC Adapter 1	Brand Name	Motorola(Salcomp)	Model Name	MC-101
AC Adapter 2	Brand Name	Motorola(Chenyang)	Model Name	MC-101
AC Adapter 3	Brand Name	Motorola(AOHAI)	Model Name	MC-101
Battery 1	Brand Name	Motorola (ATL)	Model Name	QA50
USB Cable 1	Brand Name	WASHIN	Model Name	S928D98335
USB Cable 2	Brand Name	Saibao	Model Name	S928D98333
USB Cable 3	Brand Name	Saibao	Model Name	S928D98334

1.7 Maximum EIRP and Emission Designator

5G NR n7		PI/2 BPSK / QPSK		16QAM / 64QAM / 256QAM	
BW (MHz)	Frequency Range (MHz)	Maximum EIRP(W)	Emission Designator (99%OBW)	Maximum EIRP(W)	Emission Designator (99%OBW)
5	2502.5 ~ 2567.5	0.1791	4M45G7D	0.1500	4M46W7D
10	2505.0 ~ 2565.0	0.1799	9M27G7D	0.1406	9M28W7D
15	2507.5 ~ 2562.5	0.1871	14M1G7D	0.1466	14M1W7D
20	2510.0 ~ 2560.0	0.1845	18M9G7D	0.1449	18M9W7D
25	2512.5 ~ 2557.5	0.1799	23M7G7D	0.1429	23M8W7D
30	2515.0 ~ 2555.0	0.1754	28M6G7D	0.1371	28M5W7D
40	2520.0 ~ 2550.0	0.1656	38M6G7D	0.1306	38M6W7D
50	2525.0 ~ 2545.0	0.1941	48M1G7D	0.1514	48M2W7D

5G NR n41		PI/2 BPSK / QPSK		16QAM / 64QAM / 256QAM	
BW (MHz)	Frequency Range (MHz)	Maximum EIRP(W)	Emission Designator (99%OBW)	Maximum EIRP(W)	Emission Designator (99%OBW)
10	2501.01 ~ 2685.00	0.3793	8M58G7D	0.3112	8M57W7D
15	2503.50 ~ 2682.48	0.3819	13M6G7D	0.3112	13M6W7D
20	2506.02 ~ 2679.99	0.3733	18M2G7D	0.3069	18M2W7D
30	2511.00 ~ 2674.98	0.3614	27M8G7D	0.2965	27M9W7D
40	2516.01 ~ 2670.00	0.3436	37M8G7D	0.2818	37M8W7D
50	2521.02 ~ 2664.99	0.3648	47M5G7D	0.2972	47M5W7D
60	2526.00 ~ 2659.98	0.3516	57M7G7D	0.2871	57M9W7D
70	2531.01 ~ 2655.00	0.3365	67M5G7D	0.2877	67M5W7D
80	2536.02 ~ 2649.99	0.3221	77M4G7D	0.2698	77M5W7D
90	2541.00 ~ 2644.98	0.3133	87M5G7D	0.2588	87M5W7D
100	2546.01 ~ 2640.00	0.3837	97M4G7D	0.3097	97M4W7D



5G NR n66		PI/2 BPSK / QPSK		16QAM / 64QAM / 256QAM	
BW (MHz)	Frequency Range (MHz)	Maximum EIRP(W)	Emission Designator (99%OBW)	Maximum EIRP(W)	Emission Designator (99%OBW)
5	1712.5 ~ 1777.5	0.1542	4M48G7D	0.1236	4M47W7D
10	1715.0 ~ 1775.0	0.1483	9M27G7D	0.1183	9M31W7D
15	1717.5 ~ 1772.5	0.1549	14M1G7D	0.1230	14M1W7D
20	1720.0 ~ 1770.0	0.1528	18M9G7D	0.1225	18M9W7D
25	1722.5 ~ 1767.5	0.1528	23M7G7D	0.1175	23M8W7D
30	1725.0 ~ 1765.0	0.1469	28M6G7D	0.1127	28M6W7D
35	1727.5 ~ 1762.5	0.1419	33M6G7D	0.1104	33M7W7D
40	1730.0 ~ 1760.0	0.1361	38M6G7D	0.1062	38M6W7D
45	1732.5 ~ 1757.5	0.1578	43M2G7D	0.1247	43M2W7D

5G NR n70		PI/2 BPSK / QPSK		16QAM / 64QAM / 256QAM	
BW (MHz)	Frequency Range (MHz)	Maximum EIRP(W)	Emission Designator (99%OBW)	Maximum EIRP(W)	Emission Designator (99%OBW)
5	1697.5 ~ 1707.5	0.1432	4M47G7D	0.1143	4M47W7D
10	1700.0 ~ 1705.0	0.1374	9M29G7D	0.1094	9M29W7D
15	1702.5	0.1445	14M1G7D	0.1099	14M2W7D

Note: All modulations have been tested, only the worst test results of PSK & QAM are shown in the report.

1.8 Testing Location

Sporton International Inc. (ShenZhen) is accredited to ISO/IEC 17025:2017 by American Association for Laboratory Accreditation with Certificate Number 5145.01.

Test Firm	Sporton International Inc. (ShenZhen)		
Test Site Location	1/F, 2/F, Bldg 5, Shiling Industrial Zone, Xinwei Village, Xili, Nanshan, Shenzhen, 518055 People's Republic of China TEL: +86-755-86379589 FAX: +86-755-86379595		
Test Site No.	Sporton Site No.	FCC Designation No.	FCC Test Firm Registration No.
	TH01-SZ	CN1256	421272

Test Firm	Sporton International Inc. (ShenZhen)		
Test Site Location	101, 1st Floor, Block B, Building 1, No. 2, Tengfeng 4th Road, Fenghuang Community, Fuyong Street, Baoan District, Shenzhen City, Guangdong Province 518103 People's Republic of China TEL: +86-755-86066985		
Test Site No.	Sporton Site No.	FCC Designation No.	FCC Test Firm Registration No.
	03CH01-SZ	CN1256	421272



1.9 Test Software

Item	Site	Manufacture	Name	Version
1.	03CH01-SZ	AUDIX	E3	6.2009-8-24

1.10 Applicable Standards

According to the specifications of the manufacturer, the EUT must comply with the requirements of the following standards:

- ♦ 47 CFR Part 2, 27
- ♦ ANSI C63.26-2015
- ♦ FCC KDB 971168 D01 Power Meas License Digital Systems v03r01
- ♦ FCC KDB 412172 D01 Determining ERP and EIRP v01r01

Remark:

All test items were verified and recorded according to the standards and without any deviation during the test.



2 Test Configuration of Equipment Under Test

2.1 Test Mode

Antenna port conducted and radiated test items are performed according to KDB 971168 D01 Power Meas License Digital Systems v03r01 with maximum output power.

For radiated measurement, pre-scanned in three orthogonal panels, X, Y, Z. The worst cases (X/Y plane) were recorded in this report.

The device is investigated from 30MHz to 10 times of fundamental signal for radiated spurious emission test under different RB size/offset and modulations in exploratory test. Subsequently, only the worst case emissions are reported.

Orthogonal Planes of EUT	X Plane	Y Plane	Z Plane
			

Test Items	5G NR	Bandwidth (MHz)													Modulation				RB #		Test Channel					
		5	10	15	20	25	30	35	40	45	50	60	70~90	100	PI/2 BPSK	QPSK	16QAM	64QAM	256QAM	1	Full	L	M	H		
Max. Output Power	n7	v	v	v	v	v	v	-	v	-	v	-	-	-	v	v	v	v	v	v	v	v	v	v	v	
	n41	-	v	v	v	-	v	v	v	-	v	v	v	v	v	v	v	v	v	v	v	v	v	v	v	v
	n66	v	v	v	v	v	v	v	v	v	-	-	-	-	v	v	v	v	v	v	v	v	v	v	v	v
	n70	v	v	v	-	-	-	-	-	-	-	-	-	-	v	v	v	v	v	v	v	v	v	v	v	v
Peak-to-Average Ratio	n7				v			-							v	v					v	v		v		
	n41	-			v	-									v	v					v	v		v		
	n66				v						-	-	-	-	v	v					v	v		v		
	n70		v		-	-	-	-	-	-	-	-	-	-	v	v					v	v		v		
26dB and 99% Bandwidth	n7	v	v	v	v	v	v	-	v	-	v	-	-	-		v	v	v	v		v		v			
	n41	-	v	v	v	-	v	v	v	-	v	v	v	v		v	v	v	v		v		v			
	n66	v	v	v	v	v	v	v	v	v	-	-	-	-		v	v	v	v		v		v			
	n70	v	v	v	-	-	-	-	-	-	-	-	-	-		v	v	v	v		v		v			
Conducted Band Edge	n7	v			v			-		-	v	-	-	-	v	v					v	v	v		v	
	n41	-	v			-				-	v			v	v	v					v	v	v		v	
	n66	v				v				v	-	-	-	-	v	v					v	v	v		v	
	n70	v	v	v	-	-	-	-	-	-	-	-	-	-	v	v					v	v	v		v	
Conducted	n7	v			v			-		-	v	-	-	-	v	v					v		v	v	v	



Test Items	5G NR	Bandwidth (MHz)														Modulation				RB #		Test Channel		
		5	10	15	20	25	30	35	40	45	50	60	70~90	100	PI/2 BPSK	QPSK	16QAM	64QAM	256QAM	1	Full	L	M	H
Spurious Emission	n41	-	v			-				-	v			v	v	v				v		v	v	v
	n66	v				v				v	-	-	-	-	v	v				v		v	v	v
	n70	v	v	v	-	-	-	-	-	-	-	-	-	-	v	v				v		v	v	v
Frequency Stability	n7				v					-		-	-		v					v		v		
	n41	-			v	-				-					v					v		v		
	n66				v						-	-	-	-	v					v		v		
	n70		v		-	-	-	-	-	-	-	-	-	-	v					v		v		
E.I.R.P	n7	v	v	v	v	v	v	-	v	-	v	-	-	-	v	v	v	v	v	v	v	v	v	
	n41	-	v	v	v	-	v	v	v	-	v	v	v	v	v	v	v	v	v	v	v	v	v	
	n66	v	v	v	v	v	v	v	v	v	-	-	-	-	v	v	v	v	v	v	v	v	v	
	n70	v	v	v	-	-	-	-	-	-	-	-	-	-	v	v	v	v	v	v	v	v	v	
Radiated Spurious Emission	n7	Worst Case																			v	v	v	
	n41	Worst Case																			v	v	v	
	n66	Worst Case																			v	v	v	
	n70	Worst Case																			v	v	v	
Note	1. The mark "v " means that this configuration is chosen for testing 2. The mark "- " means that this bandwidth is not supported. 3. The device is investigated from 30MHz to 10 times of fundamental signal for radiated spurious emission test under different RB size/offset and modulations in exploratory test. Subsequently, only the worst case emissions are reported. 4. Frequency Stability : Normal Voltage = 3.91V ; Low Voltage =3.6V. ; High Voltage =4.45V 5. All test items are based on engineering evaluation.																							

2.2 Connection Diagram of Test System

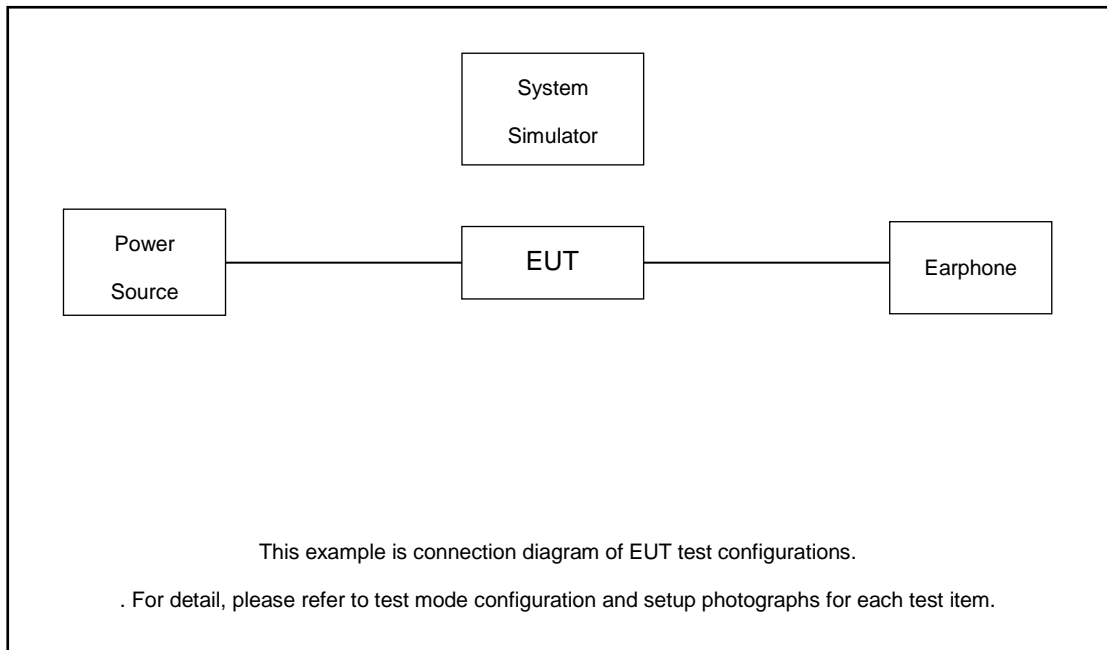

The EUT has been configuration operated in a manner tended to maximize its emission characteristics in a typical application.

2.3 Support Unit used in test configuration and system

Item	Equipment	Trade Name	Model No.	FCC ID	Data Cable	Power Cord
1.	DC Power Supply	GW	GPS-3030D	N/A	N/A	Unshielded, 1.8 m
2.	LTE Base Station	Anritsu	MT8821C	N/A	N/A	Unshielded, 1.8 m
3.	NR Base Station	Anritsu	MT8000A	N/A	N/A	Unshielded, 1.8 m
4.	Earphone	Lenovo	SH100	N/A	Unshielded, 1.2m	N/A



2.4 Measurement Results Explanation Example

For all conducted test items:

The offset level is set in the spectrum analyzer to compensate the RF cable loss between EUT conducted output port and spectrum analyzer. With the offset compensation, the spectrum analyzer reading level is exactly the EUT RF output level.

The spectrum analyzer offset is derived from RF cable loss.

$$\text{Offset} = \text{RF cable loss.}$$

Following shows an offset computation example with cable loss 8.6 dB.

Example :

$$\begin{aligned} \text{Offset(dB)} &= \text{RF cable loss(dB)}. \\ &= 8.6 \text{ (dB)} \end{aligned}$$

2.5 Frequency List of Low/Middle/High Channels

5G NR n7 Channel and Frequency List				
BW [MHz]	Channel/Frequency(MHz)	Lowest	Middle	Highest
50	Channel	505000	507000	509000
	Frequency	2525	2535	2545
40	Channel	504000	507000	510000
	Frequency	2520	2535	2550
30	Channel	503000	507000	511000
	Frequency	2515	2535	2555
25	Channel	502500	507000	511500
	Frequency	2512.5	2535	2557.5
20	Channel	502000	507000	512000
	Frequency	2510	2535	2560
15	Channel	501500	507000	512500
	Frequency	2507.5	2535	2562.5
10	Channel	501000	507000	513000
	Frequency	2505	2535	2565
5	Channel	500500	507000	513500
	Frequency	2502.5	2535	2567.5



5G NR n41 Channel and Frequency List				
BW [MHz]	Channel/Frequency(MHz)	Lowest	Middle	Highest
100	Channel	509202	518598	528000
	Frequency	2546.01	2592.99	2640
90	Channel	508200	518598	528996
	Frequency	2541	2592.99	2644.98
80	Channel	507204	518598	529998
	Frequency	2536.02	2592.99	2649.99
70	Channel	506202	518598	531000
	Frequency	2531.01	2592.99	2655
60	Channel	505200	518598	531996
	Frequency	2526	2592.99	2659.98
50	Channel	504204	518598	532998
	Frequency	2521.02	2592.99	2664.99
40	Channel	503202	518598	534000
	Frequency	2516.01	2592.99	2670
30	Channel	502200	518598	534996
	Frequency	2511	2592.99	2674.98
20	Channel	501204	518598	535998
	Frequency	2506.02	2592.99	2679.99
15	Channel	500700	518598	536496
	Frequency	2503.5	2592.99	2682.48
10	Channel	500202	518598	537000
	Frequency	2501.01	2592.99	2685



5G NR n66 Channel and Frequency List				
BW [MHz]	Channel/Frequency(MHz)	Lowest	Middle	Highest
45	Channel	346500	349000	351500
	Frequency	1732.5	1745	1757.5
40	Channel	346000	349000	352000
	Frequency	1730	1745	1760
35	Channel	345500	349000	352500
	Frequency	1727.5	1745	1762.5
30	Channel	345000	349000	353000
	Frequency	1725	1745	1765
25	Channel	344500	349000	353500
	Frequency	1722.5	1745	1767.5
20	Channel	344000	349000	354000
	Frequency	1720	1745	1770
15	Channel	343500	349000	354500
	Frequency	1717.5	1745	1772.5
10	Channel	343000	349000	355000
	Frequency	1715	1745	1775
5	Channel	342500	349000	355500
	Frequency	1712.5	1745	1777.5

5G NR n70 Channel and Frequency List				
BW [MHz]	Channel/Frequency(MHz)	Lowest	Middle	Highest
15	Channel	340500		
	Frequency	1702.5		
10	Channel	340000	340500	341000
	Frequency	1700	1702.5	1705
5	Channel	399500	340500	341500
	Frequency	1697.5	1702.5	1707.5

3 Conducted Test Items

3.1 Measuring Instruments

See list of measuring instruments of this test report.

3.2 Test Setup

3.2.1 Conducted Output Power



3.2.2 Peak-to-Average Ratio, Occupied Bandwidth ,Conducted Band-Edge and Conducted Spurious Emission

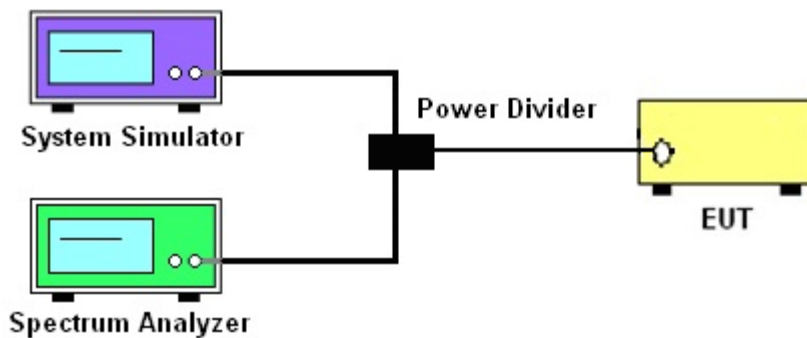

3.2.3 Frequency Stability



3.3 Test Result of Conducted Test

Please refer to Appendix A.



3.4 Conducted Output Power and EIRP

3.4.1 Description of the Conducted Output Power Measurement and EIRP Measurement

A system simulator was used to establish communication with the EUT. Its parameters were set to force the EUT transmitting at maximum output power. The measured power in the radio frequency on the transmitter output terminals shall be reported.

The EIRP of mobile transmitters must not exceed 2 Watts for 5G NR n7, n41.

The EIRP of mobile transmitters must not exceed 1 Watts for 5G NR n66, n70.

According to KDB 412172 D01 Power Approach,

$EIRP = P_T + G_T - L_C$, $ERP = EIRP - 2.15$, where

P_T = transmitter output power in dBm

G_T = gain of the transmitting antenna in dBi

L_C = signal attenuation in the connecting cable between the transmitter and antenna in dB

3.4.2 Test Procedures

1. The testing follows ANSI C63.26 Section 5.2
2. The transmitter output port was connected to the system simulator.
3. Set EUT at maximum power through the system simulator.
4. Select lowest, middle, and highest channels for each band and different modulation.
5. Measure and record the power level from the system simulator.



3.5 Peak-to-Average Ratio

3.5.1 Description of the PAR Measurement

Power Complementary Cumulative Distribution Function (CCDF) curves provide a means for characterizing the power peaks of a digitally modulated signal on a statistical basis. A CCDF curve depicts the probability of the peak signal amplitude exceeding the average power level. Most contemporary measurement instrumentation include the capability to produce CCDF curves for an input signal provided that the instrument's resolution bandwidth can be set wide enough to accommodate the entire input signal bandwidth. In measuring transmissions in this band using an average power technique, the peak-to-average ratio (PAR) of the transmission may not exceed 13 dB.

3.5.2 Test Procedures

1. The testing follows ANSI C63.26 Section 5.2.3.4 (CCDF).
2. The EUT was connected to spectrum and system simulator via a power divider.
3. Set the CCDF (Complementary Cumulative Distribution Function) option in spectrum analyzer.
4. The highest RF powers were measured and recorded the maximum PAPR level associated with a probability of 0.1 %.
5. Record the deviation as Peak to Average Ratio.



3.6 Occupied Bandwidth

3.6.1 Description of Occupied Bandwidth Measurement

The occupied bandwidth is the width of a frequency band such that, below the lower and above the upper frequency limits, the mean powers emitted are each equal to a specified percentage 0.5% of the total mean transmitted power.

The 26 dB emission bandwidth is defined as the frequency range between two points, one above and one below the carrier frequency, at which the spectral density of the emission is attenuated 26 dB below the maximum in-band spectral density of the modulated signal. Spectral density (power per unit bandwidth) is to be measured with a detector of resolution bandwidth equal to approximately 1.0% of the emission bandwidth.

3.6.2 Test Procedures

1. The testing follows ANSI C63.26 Section 5.4
2. The EUT was connected to spectrum analyzer and system simulator via a power divider.
3. The spectrum analyzer center frequency is set to the nominal EUT channel center frequency. The span range for the spectrum analyzer shall be between two and five times the anticipated OBW.
4. The nominal resolution bandwidth (RBW) shall be in the range of 1 to 5 % of the anticipated OBW, and the VBW shall be at least 3 times the RBW.
5. Set the detection mode to peak, and the trace mode to max hold.
6. Determine the reference value: Set the EUT to transmit a modulated signal. Allow the trace to stabilize. Set the spectrum analyzer marker to the highest level of the displayed trace.
(this is the reference value)
7. Determine the “-26 dB down amplitude” as equal to (Reference Value – X).
8. Place two markers, one at the lowest and the other at the highest frequency of the envelope of the spectral display such that each marker is at or slightly below the “-X dB down amplitude” determined in step 6. If a marker is below this “-X dB down amplitude” value it shall be placed as close as possible to this value. The OBW is the positive frequency difference between the two markers.
9. Use the 99 % power bandwidth function of the spectrum analyzer and report the measured bandwidth.



3.7 Conducted Band Edge

3.7.1 Description of Conducted Band Edge Measurement

27.53 (h)

For operations in the 1695 –1710 MHz and 1710 – 1780 MHz band, the FCC limit is $43 + 10\log_{10}(P[\text{Watts}])$ dB below the transmitter power $P(\text{Watts})$ in a 1 MHz bandwidth. However, in the 1MHz bands immediately outside and adjacent to the licensee's frequency block, a resolution bandwidth of at least one percent of the emission bandwidth of the fundamental emission of the transmitter may be employed.

27.53(m)(4)

For mobile digital stations, the attenuation factor shall be not less than $40 + 10 \log (P)$ dB on all frequencies between the channel edge and 5 megahertz from the channel edge, $43 + 10 \log (P)$ dB on all frequencies between 5 megahertz and X megahertz from the channel edge, and $55 + 10 \log (P)$ dB on all frequencies more than X megahertz from the channel edge, where X is the greater of 6 megahertz or the actual emission bandwidth as defined in paragraph (m)(6) of this section. In addition, the attenuation factor shall not be less that $43 + 10 \log (P)$ dB on all frequencies between 2490.5 MHz and 2496 MHz and $55 + 10 \log (P)$ dB at or below 2490.5 MHz. Mobile Satellite Service licensees operating on frequencies below 2495 MHz may also submit a documented interference complaint against BRS licensees operating on channel BRS Channel 1 on the same terms and conditions as adjacent channel BRS or EBS licensees.



3.7.2 Test Procedures

1. The testing follows ANSI C63.26 section 5.7
2. The EUT was connected to spectrum analyzer and system simulator via a power divider.
3. The band edges of low and high channels for the highest RF powers were measured.
4. Set RBW $\geq 1\%$ /2%EBW in the 1MHz band immediately outside and adjacent to the band edge.
5. Beyond the 1 MHz band from the band edge, RBW=1MHz was used or a narrower RBW was used (generally limited to no less than 1% of the OBW) and the measured power was integrated over the full required measurement bandwidth.
6. Set spectrum analyzer with RMS detector.
7. The RF fundamental frequency should be excluded against the limit line in the operating frequency band.
8. Checked that all the results comply with the emission limit line.

Example:

The limit line is derived from $43 + 10\log(P)$ dB below the transmitter power P(Watts)

$$= P(W) - [43 + 10\log(P)] \text{ (dB)}$$

$$= [30 + 10\log(P)] \text{ (dBm)} - [43 + 10\log(P)] \text{ (dB)} = -13\text{dBm.}$$

9. For 5G NR n7/n41, the other 40 dB, and 55 dB have additionally applied same calculation above.
10. When using the integration method, the starting frequency of the integration shall be centered at one-half of the RBW away from the band edge.



3.8 Conducted Spurious Emission

3.8.1 Description of Conducted Spurious Emission Measurement

The power of any emission outside of the authorized operating frequency ranges must be lower than the transmitter power (P) by a factor of at least $43 + 10 \log (P)$ dB.

For 5G NR n7/n41:

The power of any emission outside of the authorized operating frequency ranges must be lower than the transmitter power (P) by a factor of at least $55 + 10 \log (P)$ dB.

It is measured by means of a calibrated spectrum analyzer and scanned from 30 MHz up to a frequency including its 10th harmonic.

3.8.2 Test Procedures

1. The testing follows ANSI C63.26 section 5.7
2. The EUT was connected to spectrum analyzer and system simulator via a power divider.
3. The RF output of EUT was connected to the spectrum analyzer by RF cable and attenuator. The path loss was compensated to the results for each measurement.
4. The middle channel for the highest RF power within the transmitting frequency was measured.
5. The conducted spurious emission for the whole frequency range was taken.
6. Make the measurement with the spectrum analyzer's RBW = 1MHz, VBW = 3MHz.
7. Set spectrum analyzer with RMS detector.
8. Taking the record of maximum spurious emission.
9. The RF fundamental frequency should be excluded against the limit line in the operating frequency band.
10. The limit line is derived from $43 + 10\log(P)$ dB below the transmitter power P(Watts)
 $= P(W) - [43 + 10\log(P)]$ (dB)
 $= [30 + 10\log(P)]$ (dBm) - $[43 + 10\log(P)]$ (dB)
 $= -13$ dBm.
11. For 5G NR n7/n41
The limit line is derived from $55 + 10\log(P)$ dB below the transmitter power P(Watts)
 $= P(W) - [55 + 10\log(P)]$ (dB)
 $= [30 + 10\log(P)]$ (dBm) - $[55 + 10\log(P)]$ (dB)
 $= -25$ dBm.



3.9 Frequency Stability

3.9.1 Description of Frequency Stability Measurement

The frequency stability shall be measured by variation of ambient temperature and variation of primary supply voltage to ensure that the fundamental emission stays within the authorized frequency block.

3.9.2 Test Procedures for Temperature Variation

1. The testing follows ANSI C63.26 section 5.6.4
2. The EUT was set up in the thermal chamber and connected with the system simulator.
3. With power OFF, the temperature was decreased to -30°C and the EUT was stabilized before testing. Power was applied and the maximum change in frequency was recorded within one minute.
4. With power OFF, the temperature was raised in 10°C step up to 50°C. The EUT was stabilized at each step for at least half an hour. Power was applied and the maximum frequency change was recorded within one minute.

3.9.3 Test Procedures for Voltage Variation

1. The testing follows ANSI C63.26 section 5.6.5
2. The EUT was placed in a temperature chamber at 20±5°C and connected with the system simulator.
3. The power supply voltage to the EUT was varied from 85% to 115% of the nominal value for other than hand carried battery equipment.
4. For hand carried, battery powered equipment, reduce the primary ac or dc supply voltage to the battery operating end point, which shall be specified by the manufacturer.
5. The variation in frequency was measured for the worst case.

4 Radiated Test Items

4.1 Measuring Instruments

See list of measuring instruments of this test report.

4.2 Test Setup

4.2.1 For radiated test below 30MHz

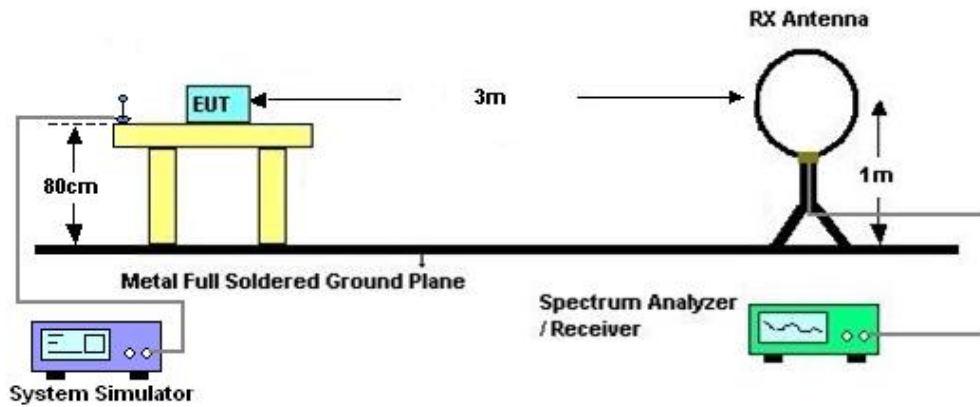

4.2.2 For radiated test from 30MHz to 1GHz

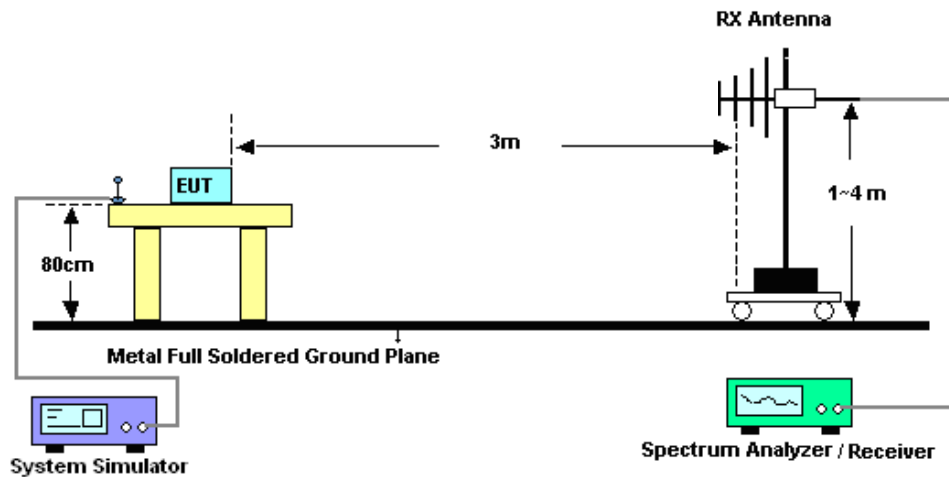

4.2.3 For radiated test above 1GHz

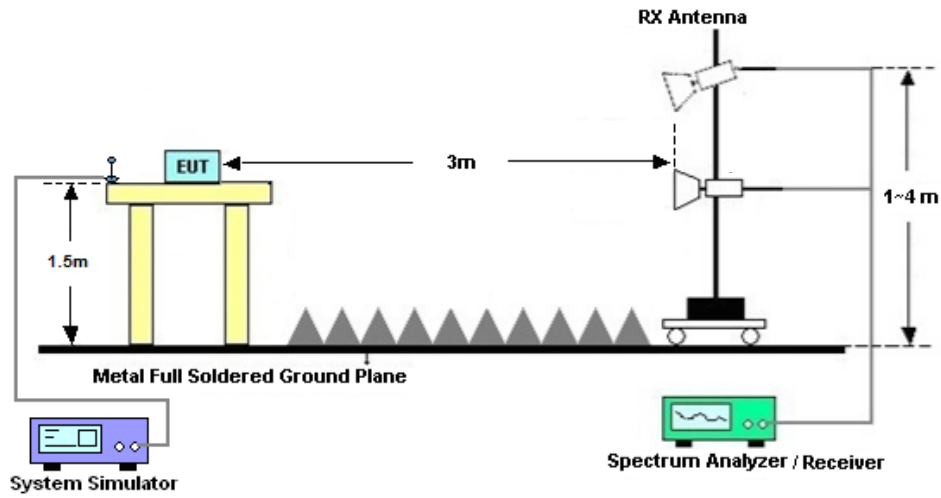

4.3 Test Result of Radiated Test

The low frequency, which started from 9 kHz to 30MHz, was pre-scanned and the result which was 20dB lower than the limit line was not reported.

Please refer to Appendix B.



4.4 Radiated Spurious Emission

4.4.1 Description of Radiated Spurious Emission

The radiated spurious emission was measured by substitution method according to ANSI C63.26. The power of any emission outside of the authorized operating frequency ranges must be attenuated below the transmitter power (P) by a factor of at least $43 + 10 \log (P)$ dB.

For 5G NR n7/n41

The power of any emission outside of the authorized operating frequency ranges must be attenuated below the transmitter power (P) by a factor of at least $55 + 10 \log (P)$ dB.

The spectrum is scanned from 30 MHz up to a frequency including its 10th harmonic.

4.4.2 Test Procedures

1. The testing follows ANSI C63.26 Section 5.5
2. The EUT was placed on a turntable with 0.8 meter height for frequency below 1GHz and 1.5 meter height for frequency above 1GHz respectively above ground.
3. The EUT was set 3 meters from the receiving antenna mounted on the antenna tower.
4. The table was rotated 360 degrees to determine the position of the highest spurious emission.
5. The height of the receiving antenna is varied between 1m to 4m to search the maximum spurious emission for both horizontal and vertical polarizations.
6. During the measurement, the system simulator parameters were set to force the EUT transmitting at maximum output power.
7. Make the measurement with the spectrum analyzer's RBW = 1MHz, VBW = 3MHz, taking the record of maximum spurious emission.
8. A horn antenna was substituted in place of the EUT and was driven by a signal generator.
9. Tune the output power of signal generator to the same emission level with EUT maximum spurious emission.
10. $EIRP (dBm) = S.G. Power - Tx Cable Loss + Tx Antenna Gain$
11. $ERP (dBm) = EIRP - 2.15$
12. The RF fundamental frequency should be excluded against the limit line in the operating frequency band.

The limit line is derived from $43 + 10\log(P)$ dB below the transmitter power P(Watts)
 $= P(W) - [43 + 10\log(P)] (dB)$
 $= [30 + 10\log(P)] (dBm) - [43 + 10\log(P)] (dB)$
 $= -13dBm.$

13. For 5G NR n7/n41:

The limit line is derived from $55 + 10\log(P)$ dB below the transmitter power P(Watts)
The limit line is derived from $55 + 10\log(P)$ dB below the transmitter power P(Watts)



5 List of Measuring Equipment

Instrument	Manufacturer	Model No.	Serial No.	Characteristics	Calibration Date	Test Date	Due Date	Remark
EMI Test Receiver&SA	Agilent	N9038A	MY52260185	20Hz~26.5GHz	Dec. 26, 2022	Sep. 25, 2023~ Oct. 16, 2023	Dec. 25, 2023	Conducted (TH01-SZ)
Power Divider	TOJOIN	PS-2SM-04 265	60.06.020.007 7	0.4GHz~26.5GHz	Dec. 25, 2022	Sep. 25, 2023~ Oct. 16, 2023	Dec. 24, 2023	Conducted (TH01-SZ)
Thermal Chamber	Ten Billion Hongzhangroup	LP-150U	H2014081803	-40~+150°C	Jul. 05, 2023	Sep. 25, 2023~ Oct. 16, 2023	Jul. 04, 2024	Conducted (TH01-SZ)
EMI Test Receiver&SA	Agilent	N9038A	MY52260185	20Hz~26.5GHz	Dec. 26, 2022	Oct. 10, 2023	Dec. 25, 2023	Radiation (03CH01-SZ)
Loop Antenna	R&S	HFH2-Z2	100354	9kHz~30MHz	Jul. 28, 2022	Oct. 10, 2023	Jul. 27, 2024	Radiation (03CH01-SZ)
HF Amplifier	KEYSIGHT	83017A	MY53270105	0.5GHz~26.5Ghz	Oct. 19, 2022	Oct. 10, 2023	Oct. 18, 2023	Radiation (03CH01-SZ)
Bilog Antenna	TeseQ	CBL6112D	35407	30MHz-2GHz	Sep. 27, 2023	Oct. 10, 2023	Sep. 26, 2024	Radiation (03CH01-SZ)
Double Ridge Horn Antenna	ETS-Lindgren	3117	00119436	1GHz~18GHz	Jul. 08, 2023	Oct. 10, 2023	Jul. 07, 2024	Radiation (03CH01-SZ)
SHF-EHF Horn	com-power	AH-840	101071	18Ghz-40GHz	Apr. 08, 2023	Oct. 10, 2023	Apr. 07, 2024	Radiation (03CH01-SZ)
LF Amplifier	Burgeon	BPA-530	102209	0.01~3000Mhz	Apr. 04, 2023	Oct. 10, 2023	Apr. 03, 2024	Radiation (03CH01-SZ)
HF Amplifier	MITEQ	AMF-7D-00 101800-30-1 0P-R	1943528	1GHz~18GHz	Oct. 19, 2022	Oct. 10, 2023	Oct. 18, 2023	Radiation (03CH01-SZ)
HF Amplifier	MITEQ	TTA1840-35 -HG	1871923	18GHz~40GHz	Jul. 07, 2023	Oct. 10, 2023	Jul. 06, 2024	Radiation (03CH01-SZ)
AC Power Source	Chroma	61601	616010001985	N/A	Nov. 10, 2022	Oct. 10, 2023	Nov. 09, 2023	Radiation (03CH01-SZ)
Turn Table	EM	EM1000	N/A	0~360 degree	NCR	Oct. 10, 2023	NCR	Radiation (03CH01-SZ)
Antenna Mast	EM	EM1000	N/A	1 m~4 m	NCR	Oct. 10, 2023	NCR	Radiation (03CH01-SZ)

NCR: No Calibration Required



6 Measurement Uncertainty

The measurement uncertainties shown below were calculated in accordance with the requirements of ANSI 63.26-2015. All the measurement uncertainty value were shown with a coverage K=2 to indicate 95% level of confidence. The measurement data show herein meets or exceeds the CISPR measurement uncertainty values specified in CISPR 16-4-2 and can be compared directly to specified limit to determine compliance.

Uncertainty of Conducted Measurement

Test Item	Uncertainty
Conducted Power	±1.34 dB
Conducted Emissions	±1.34 dB
Occupied Channel Bandwidth	±0.13 %

Uncertainty of Radiated Emission Measurement (30 MHz ~ 1000 MHz)

Measuring Uncertainty for a Level of Confidence of 95% (U = 2Uc(y))	2.48dB
---	--------

Uncertainty of Radiated Emission Measurement (1GHz ~ 18GHz)

Measuring Uncertainty for a Level of Confidence of 95% (U = 2Uc(y))	3.53dB
---	--------

Uncertainty of Radiated Emission Measurement (18GHz ~ 40GHz)

Measuring Uncertainty for a Level of Confidence of 95% (U = 2Uc(y))	4.02dB
---	--------

----- THE END -----



Appendix A. Test Results of Conducted Test

Test Engineer :	Jung Kuo	Temperature :	22~23°C
		Relative Humidity :	40~42%

FR1 N7(ANT1)

Transmitter Conducted Output Power And EIRP, ($G_T - L_C$)=-0.4dB

NR Band	SCS (kHz)	Bandwidth (MHz)	Arfcn	Freq (MHz)	Modulation	RB	Conducted Power(dBm)	EIRP (dBm)	EIRP (W)
7	15	5	500500	2502.5	DFT-s-OFDM QPSK	1@1	22.19	21.79	0.1510
7	15	5	500500	2502.5	DFT-s-OFDM 16 QAM	1@1	22.16	21.76	0.1500
7	15	5	507000	2535	DFT-s-OFDM QPSK	1@1	22.93	22.53	0.1791
7	15	5	507000	2535	DFT-s-OFDM 16 QAM	1@1	21.91	21.51	0.1416
7	15	5	513500	2567.5	DFT-s-OFDM QPSK	1@1	22.25	21.85	0.1531
7	15	5	513500	2567.5	DFT-s-OFDM 16 QAM	1@1	21.19	20.79	0.1199
7	15	10	501000	2505	DFT-s-OFDM QPSK	1@1	22.95	22.55	0.1799
7	15	10	501000	2505	DFT-s-OFDM 16 QAM	1@1	21.88	21.48	0.1406
7	15	10	507000	2535	DFT-s-OFDM QPSK	1@1	22.74	22.34	0.1714
7	15	10	507000	2535	DFT-s-OFDM 16 QAM	1@1	21.68	21.28	0.1343
7	15	10	513000	2565	DFT-s-OFDM QPSK	1@1	22.82	22.42	0.1746
7	15	10	513000	2565	DFT-s-OFDM 16 QAM	1@1	21.77	21.37	0.1371
7	15	15	501500	2507.5	DFT-s-OFDM QPSK	1@1	23.12	22.72	0.1871
7	15	15	501500	2507.5	DFT-s-OFDM 16 QAM	1@1	22.06	21.66	0.1466
7	15	15	507000	2535	DFT-s-OFDM QPSK	1@1	23.01	22.61	0.1824
7	15	15	507000	2535	DFT-s-OFDM 16 QAM	1@1	21.95	21.55	0.1429
7	15	15	512500	2562.5	DFT-s-OFDM QPSK	1@1	22.79	22.39	0.1734
7	15	15	512500	2562.5	DFT-s-OFDM 16 QAM	1@1	21.8	21.4	0.1380
7	15	20	502000	2510	DFT-s-OFDM QPSK	1@1	23.06	22.66	0.1845
7	15	20	502000	2510	DFT-s-OFDM 16 QAM	1@1	22.01	21.61	0.1449
7	15	20	507000	2535	DFT-s-OFDM QPSK	1@1	22.98	22.58	0.1811
7	15	20	507000	2535	DFT-s-OFDM 16 QAM	1@1	21.97	21.57	0.1435
7	15	20	512000	2560	DFT-s-OFDM QPSK	1@1	22.77	22.37	0.1726
7	15	20	512000	2560	DFT-s-OFDM 16 QAM	1@1	21.78	21.38	0.1374
7	15	25	502500	2512.5	DFT-s-OFDM QPSK	1@1	22.95	22.55	0.1799
7	15	25	502500	2512.5	DFT-s-OFDM 16 QAM	1@1	21.95	21.55	0.1429
7	15	25	507000	2535	DFT-s-OFDM QPSK	1@1	22.85	22.45	0.1758
7	15	25	507000	2535	DFT-s-OFDM 16 QAM	1@1	21.81	21.41	0.1384
7	15	25	511500	2557.5	DFT-s-OFDM QPSK	1@1	22.63	22.23	0.1671
7	15	25	511500	2557.5	DFT-s-OFDM 16 QAM	1@1	21.63	21.23	0.1327
7	15	30	503000	2515	DFT-s-OFDM QPSK	1@1	22.84	22.44	0.1754
7	15	30	503000	2515	DFT-s-OFDM 16 QAM	1@1	21.77	21.37	0.1371
7	15	30	507000	2535	DFT-s-OFDM QPSK	1@1	22.77	22.37	0.1726
7	15	30	507000	2535	DFT-s-OFDM 16 QAM	1@1	21.75	21.35	0.1365
7	15	30	511000	2555	DFT-s-OFDM QPSK	1@1	22.49	22.09	0.1618
7	15	30	511000	2555	DFT-s-OFDM 16 QAM	1@1	21.48	21.08	0.1282

7	15	40	504000	2520	DFT-s-OFDM QPSK	1@1	22.59	22.19	0.1656
7	15	40	504000	2520	DFT-s-OFDM 16 QAM	1@1	21.52	21.12	0.1294
7	15	40	507000	2535	DFT-s-OFDM QPSK	1@1	22.57	22.17	0.1648
7	15	40	507000	2535	DFT-s-OFDM 16 QAM	1@1	21.56	21.16	0.1306
7	15	40	510000	2550	DFT-s-OFDM QPSK	1@1	22.4	22	0.1585
7	15	40	510000	2550	DFT-s-OFDM 16 QAM	1@1	21.37	20.97	0.1250
7	15	50	505000	2525	DFT-s-OFDM PI/2 BPSK	135@67	22.87	22.47	0.1766
7	15	50	505000	2525	DFT-s-OFDM PI/2 BPSK	1@1	22.83	22.43	0.1750
7	15	50	505000	2525	DFT-s-OFDM PI/2 BPSK	1@268	22.45	22.05	0.1603
7	15	50	505000	2525	DFT-s-OFDM QPSK	135@67	22.97	22.57	0.1807
7	15	50	505000	2525	DFT-s-OFDM QPSK	1@1	22.94	22.54	0.1795
7	15	50	505000	2525	DFT-s-OFDM QPSK	1@268	22.58	22.18	0.1652
7	15	50	505000	2525	DFT-s-OFDM 16 QAM	135@67	22.13	21.73	0.1489
7	15	50	505000	2525	DFT-s-OFDM 16 QAM	1@1	21.91	21.51	0.1416
7	15	50	505000	2525	DFT-s-OFDM 16 QAM	1@268	21.61	21.21	0.1321
7	15	50	505000	2525	DFT-s-OFDM 64 QAM	135@67	20.54	20.14	0.1033
7	15	50	505000	2525	DFT-s-OFDM 64 QAM	1@1	20.35	19.95	0.0989
7	15	50	505000	2525	DFT-s-OFDM 64 QAM	1@268	20.07	19.67	0.0927
7	15	50	505000	2525	DFT-s-OFDM 256 QAM	135@67	18.53	18.13	0.0650
7	15	50	505000	2525	DFT-s-OFDM 256 QAM	1@1	18.51	18.11	0.0647
7	15	50	505000	2525	DFT-s-OFDM 256 QAM	1@268	18.24	17.84	0.0608
7	15	50	505000	2525	CP-OFDM QPSK	135@67	21.55	21.15	0.1303
7	15	50	505000	2525	CP-OFDM QPSK	1@1	21.51	21.11	0.1291
7	15	50	505000	2525	CP-OFDM QPSK	1@268	21.18	20.78	0.1197
7	15	50	507000	2535	DFT-s-OFDM PI/2 BPSK	135@67	22.76	22.36	0.1722
7	15	50	507000	2535	DFT-s-OFDM PI/2 BPSK	1@1	22.88	22.48	0.1770
7	15	50	507000	2535	DFT-s-OFDM PI/2 BPSK	1@268	22.58	22.18	0.1652
7	15	50	507000	2535	DFT-s-OFDM QPSK	135@67	22.82	22.42	0.1746
7	15	50	507000	2535	DFT-s-OFDM QPSK	1@1	23.01	22.61	0.1824
7	15	50	507000	2535	DFT-s-OFDM QPSK	1@268	22.76	22.36	0.1722
7	15	50	507000	2535	DFT-s-OFDM 16 QAM	135@67	21.96	21.56	0.1432
7	15	50	507000	2535	DFT-s-OFDM 16 QAM	1@1	22.03	21.63	0.1455
7	15	50	507000	2535	DFT-s-OFDM 16 QAM	1@268	21.76	21.36	0.1368
7	15	50	507000	2535	DFT-s-OFDM 64 QAM	135@67	20.43	20.03	0.1007
7	15	50	507000	2535	DFT-s-OFDM 64 QAM	1@1	20.44	20.04	0.1009
7	15	50	507000	2535	DFT-s-OFDM 64 QAM	1@268	20.15	19.75	0.0944
7	15	50	507000	2535	DFT-s-OFDM 256 QAM	135@67	18.54	18.14	0.0652
7	15	50	507000	2535	DFT-s-OFDM 256 QAM	1@1	18.6	18.2	0.0661
7	15	50	507000	2535	DFT-s-OFDM 256 QAM	1@268	18.37	17.97	0.0627
7	15	50	507000	2535	CP-OFDM QPSK	135@67	21.44	21.04	0.1271
7	15	50	507000	2535	CP-OFDM QPSK	1@1	21.57	21.17	0.1309
7	15	50	507000	2535	CP-OFDM QPSK	1@268	21.37	20.97	0.1250
7	15	50	509000	2545	DFT-s-OFDM PI/2 BPSK	135@67	22.79	22.39	0.1734
7	15	50	509000	2545	DFT-s-OFDM PI/2 BPSK	1@1	22.74	22.34	0.1714

7	15	50	509000	2545	DFT-s-OFDM PI/2 BPSK	1@268	23.28	22.88	0.1941
7	15	50	509000	2545	DFT-s-OFDM QPSK	135@67	22.74	22.34	0.1714
7	15	50	509000	2545	DFT-s-OFDM QPSK	1@1	22.91	22.51	0.1782
7	15	50	509000	2545	DFT-s-OFDM QPSK	1@268	23.24	22.84	0.1923
7	15	50	509000	2545	DFT-s-OFDM 16 QAM	135@67	21.95	21.55	0.1429
7	15	50	509000	2545	DFT-s-OFDM 16 QAM	1@1	21.93	21.53	0.1422
7	15	50	509000	2545	DFT-s-OFDM 16 QAM	1@268	22.2	21.8	0.1514
7	15	50	509000	2545	DFT-s-OFDM 64 QAM	135@67	20.38	19.98	0.0995
7	15	50	509000	2545	DFT-s-OFDM 64 QAM	1@1	20.28	19.88	0.0973
7	15	50	509000	2545	DFT-s-OFDM 64 QAM	1@268	20.44	20.04	0.1009
7	15	50	509000	2545	DFT-s-OFDM 256 QAM	135@67	18.45	18.05	0.0638
7	15	50	509000	2545	DFT-s-OFDM 256 QAM	1@1	18.48	18.08	0.0643
7	15	50	509000	2545	DFT-s-OFDM 256 QAM	1@268	18.58	18.18	0.0658
7	15	50	509000	2545	CP-OFDM QPSK	135@67	21.42	21.02	0.1265
7	15	50	509000	2545	CP-OFDM QPSK	1@1	21.48	21.08	0.1282
7	15	50	509000	2545	CP-OFDM QPSK	1@268	21.74	21.34	0.1361

Frequency Stability

NR Band	SCS (kHz)	Bandwidth (MHz)	Arfcn	Freq (MHz)	Modulation	RB	Deviation (ppm)	Verdict	Environment
7	15	20	507000	2535.0	DFT-s-OFDM QPSK	100@0	0.0063	PASS	NV
7	15	20	507000	2535.0	DFT-s-OFDM QPSK	100@0	0.0020	PASS	LV
7	15	20	507000	2535.0	DFT-s-OFDM QPSK	100@0	0.0048	PASS	HV
7	15	20	507000	2535.0	DFT-s-OFDM QPSK	100@0	0.0054	PASS	-30°C
7	15	20	507000	2535.0	DFT-s-OFDM QPSK	100@0	0.0064	PASS	-20°C
7	15	20	507000	2535.0	DFT-s-OFDM QPSK	100@0	0.0026	PASS	-10°C
7	15	20	507000	2535.0	DFT-s-OFDM QPSK	100@0	0.0040	PASS	0°C
7	15	20	507000	2535.0	DFT-s-OFDM QPSK	100@0	0.0064	PASS	10°C
7	15	20	507000	2535.0	DFT-s-OFDM QPSK	100@0	0.0063	PASS	20°C
7	15	20	507000	2535.0	DFT-s-OFDM QPSK	100@0	0.0030	PASS	30°C
7	15	20	507000	2535.0	DFT-s-OFDM QPSK	100@0	0.0060	PASS	40°C
7	15	20	507000	2535.0	DFT-s-OFDM QPSK	100@0	0.0051	PASS	50°C

Peak to Average Ratio

NR Band	SCS (kHz)	Bandwidth (MHz)	Arfcn	Freq (MHz)	Modulation	RB	Result (dB)	Limit (dB)	Verdict
7	15	20	507000	2535.0	DFT-s-OFDM PI/2 BPSK	100@0	4.43	13	PASS
7	15	20	507000	2535.0	DFT-s-OFDM PI/2 BPSK	1@0	3.71	13	PASS
7	15	20	507000	2535.0	DFT-s-OFDM QPSK	100@0	5.72	13	PASS
7	15	20	507000	2535.0	DFT-s-OFDM QPSK	1@0	4.53	13	PASS

N7(20M)_DFT-s-OFDM_PI_2-BPSK_Outer_Full_Mid_CH



N7(20M)_DFT-s-OFDM_PI_2-BPSK_Edge_1RB_Left_Mid_CH



N7(20M)_DFT-s-OFDM_QPSK_Outer_Full_Mid_CH



N7(20M)_DFT-s-OFDM_QPSK_Edge_1RB_Left_Mid_CH

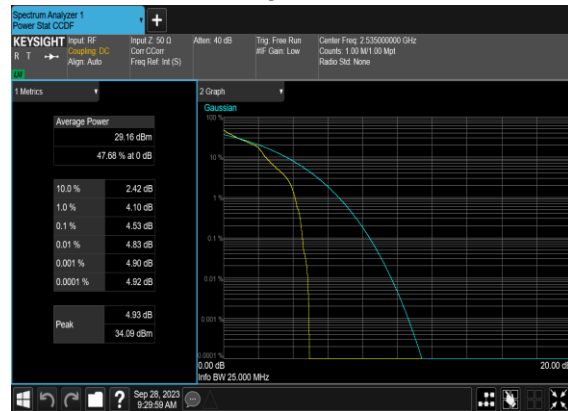

Occupied Bandwidth

NR Band	SCS (kHz)	Bandwidth (MHz)	Arfcn	Freq (MHz)	Modulation	RB	OBW (MHz)	26dB BW (MHz)
7	15	5	507000	2535.0	CP-OFDM QPSK	25@0	4.4542	4.794
7	15	5	507000	2535.0	CP-OFDM 16 QAM	25@0	4.4595	4.779
7	15	5	507000	2535.0	CP-OFDM 64 QAM	25@0	4.4573	4.859
7	15	5	507000	2535.0	CP-OFDM 256 QAM	25@0	4.4645	4.808
7	15	10	507000	2535.0	CP-OFDM QPSK	52@0	9.2705	9.809
7	15	10	507000	2535.0	CP-OFDM 16 QAM	52@0	9.2834	9.764
7	15	10	507000	2535.0	CP-OFDM 64 QAM	52@0	9.276	9.734
7	15	10	507000	2535.0	CP-OFDM 256 QAM	52@0	9.2831	9.884
7	15	15	507000	2535.0	CP-OFDM QPSK	79@0	14.091	14.74
7	15	15	507000	2535.0	CP-OFDM 16 QAM	79@0	14.084	14.81
7	15	15	507000	2535.0	CP-OFDM 64 QAM	79@0	14.125	14.77
7	15	15	507000	2535.0	CP-OFDM 256 QAM	79@0	14.081	14.7
7	15	20	507000	2535.0	CP-OFDM QPSK	106@0	18.885	19.75
7	15	20	507000	2535.0	CP-OFDM 16 QAM	106@0	18.888	19.74
7	15	20	507000	2535.0	CP-OFDM 64 QAM	106@0	18.895	19.89
7	15	20	507000	2535.0	CP-OFDM 256 QAM	106@0	18.933	19.84
7	15	25	507000	2535.0	CP-OFDM QPSK	133@0	23.689	24.69
7	15	25	507000	2535.0	CP-OFDM 16 QAM	133@0	23.73	24.62
7	15	25	507000	2535.0	CP-OFDM 64 QAM	133@0	23.689	24.64
7	15	25	507000	2535.0	CP-OFDM 256 QAM	133@0	23.816	24.62
7	15	30	507000	2535.0	CP-OFDM QPSK	160@0	28.591	29.72
7	15	30	507000	2535.0	CP-OFDM 16 QAM	160@0	28.477	29.56
7	15	30	507000	2535.0	CP-OFDM 64 QAM	160@0	28.546	29.59
7	15	30	507000	2535.0	CP-OFDM 256 QAM	160@0	28.461	29.61
7	15	40	507000	2535.0	CP-OFDM QPSK	216@0	38.57	40.04

7	15	40	507000	2535.0	CP-OFDM 16 QAM	216@0	38.493	39.86
7	15	40	507000	2535.0	CP-OFDM 64 QAM	216@0	38.479	39.89
7	15	40	507000	2535.0	CP-OFDM 256 QAM	216@0	38.573	39.83
7	15	50	507000	2535.0	CP-OFDM QPSK	270@0	48.108	49.78
7	15	50	507000	2535.0	CP-OFDM 16 QAM	270@0	48.173	49.84
7	15	50	507000	2535.0	CP-OFDM 64 QAM	270@0	48.12	49.79
7	15	50	507000	2535.0	CP-OFDM 256 QAM	270@0	48.17	49.8

N7(5M)_CP-OFDM_QPSK_Outer_Full_Mid_CH

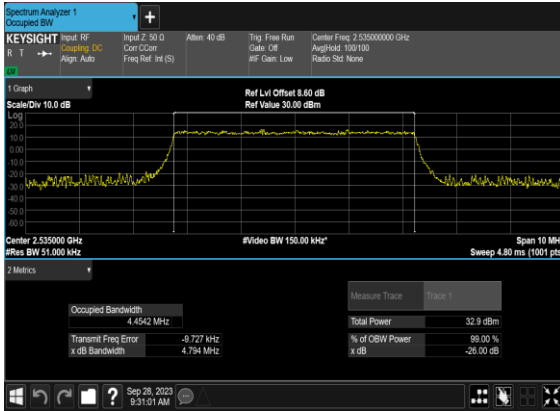

N7(5M)_CP-OFDM_16QAM_Outer_Full_Mid_CH



N7(5M)_CP-OFDM_64QAM_Outer_Full_Mid_CH

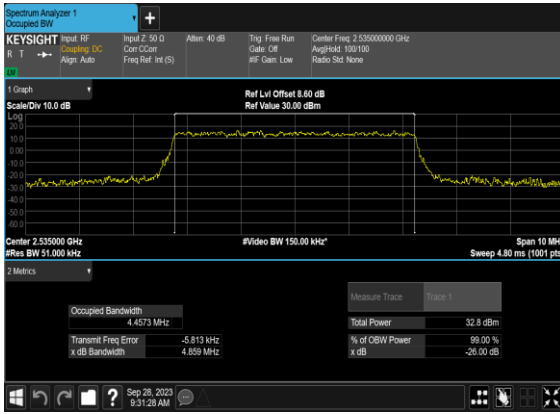

N7(5M)_CP-OFDM_256QAM_Outer_Full_Mid_CH



N7(10M)_CP-OFDM_QPSK_Outer_Full_Mid_CH

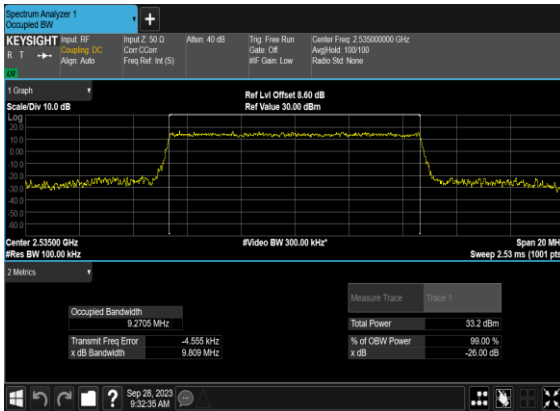

N7(10M)_CP-OFDM_16QAM_Outer_Full_Mid_CH

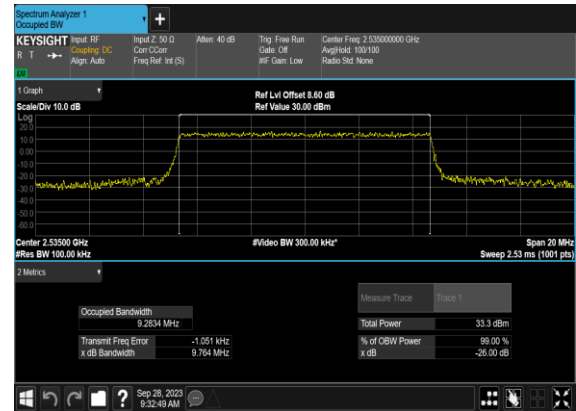

N7(10M)_CP-OFDM_64 QAM_Outer_Full_Mid_CH

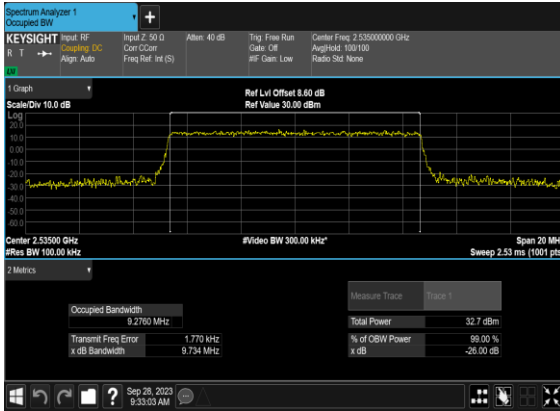

N7(10M)_CP-OFDM_256 QAM_Outer_Full_Mid_CH

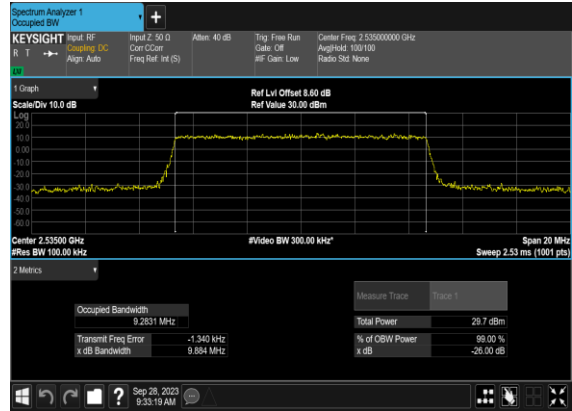

N7(15M)_CP- OFDM_QPSK_Outer_Full_Mid_CH

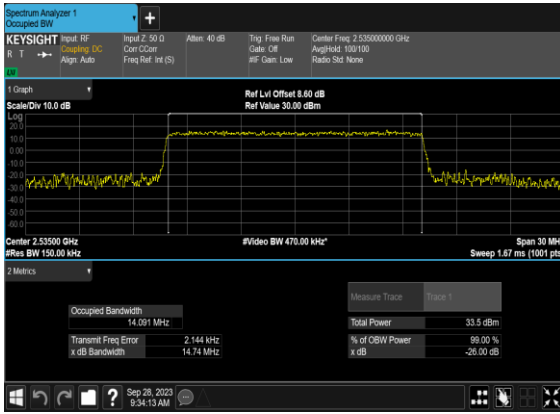

N7(15M)_CP-OFDM_16 QAM_Outer_Full_Mid_CH

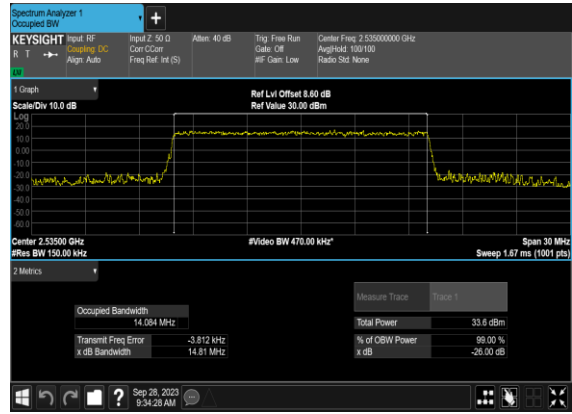

N7(15M)_CP-OFDM_64 QAM_Outer_Full_Mid_CH

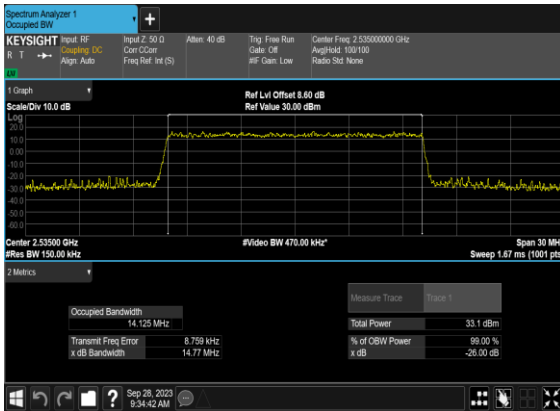

N7(15M)_CP-OFDM_256 QAM_Outer_Full_Mid_CH

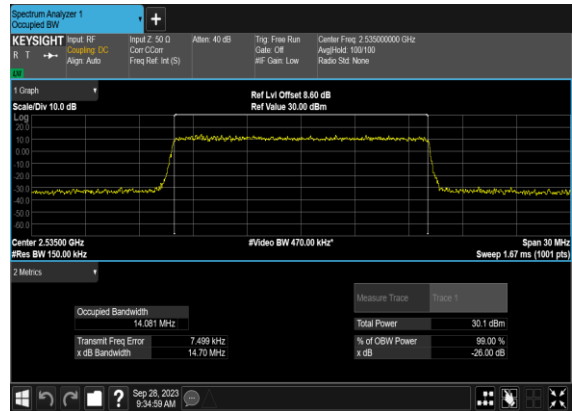

N7(20M)_CP-OFDM_QPSK_Outer_Full_Mid_CH

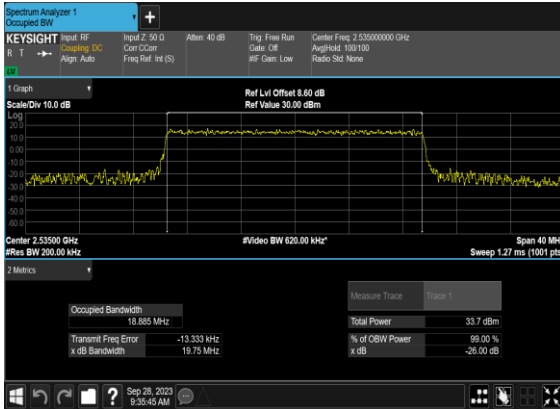

N7(20M)_CP-OFDM_16QAM_Outer_Full_Mid_CH

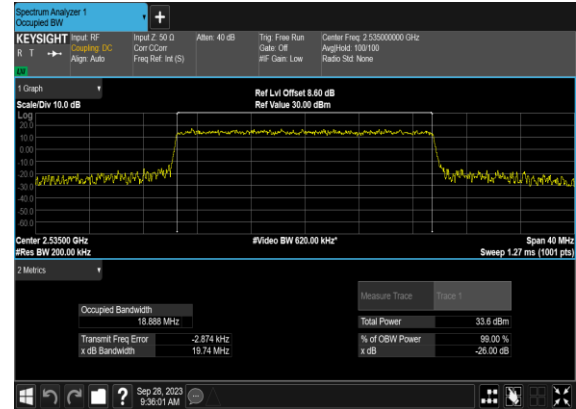

N7(20M)_CP-OFDM_64QAM_Outer_Full_Mid_CH

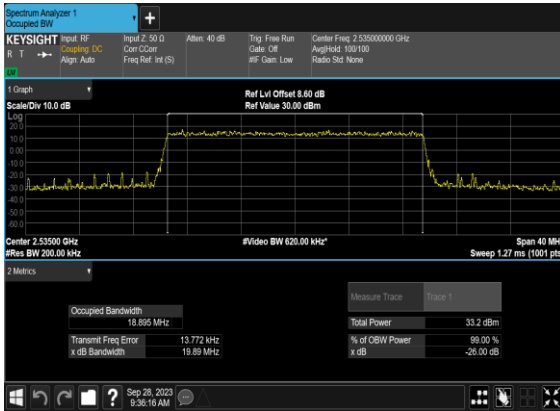

N7(20M)_CP-OFDM_256QAM_Outer_Full_Mid_CH

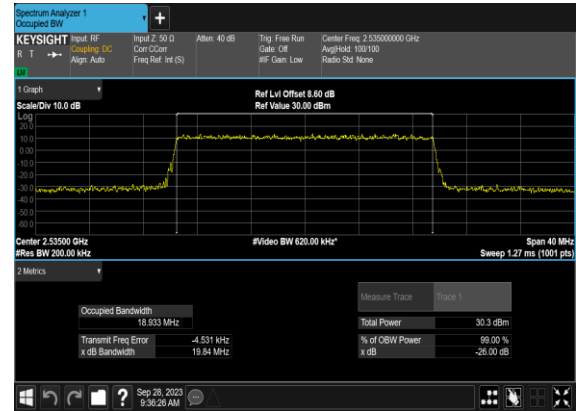

N7(25M)_CP-OFDM_QPSK_Outer_Full_Mid_CH

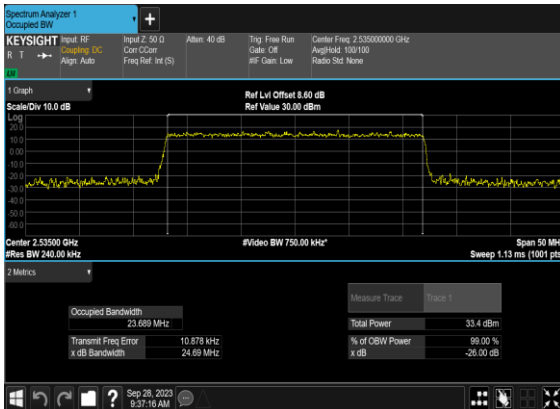

N7(25M)_CP-OFDM_16QAM_Outer_Full_Mid_CH

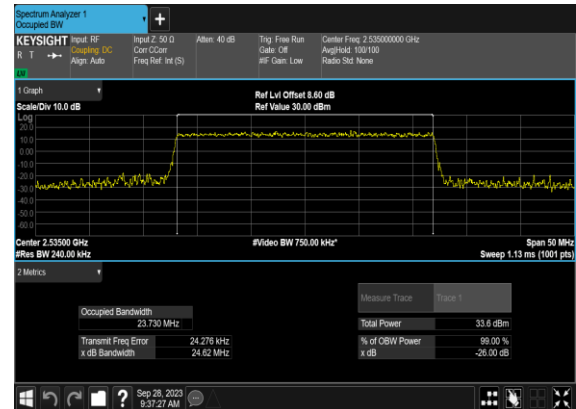

N7(25M)_CP-OFDM_64 QAM_Outer_Full_Mid_CH

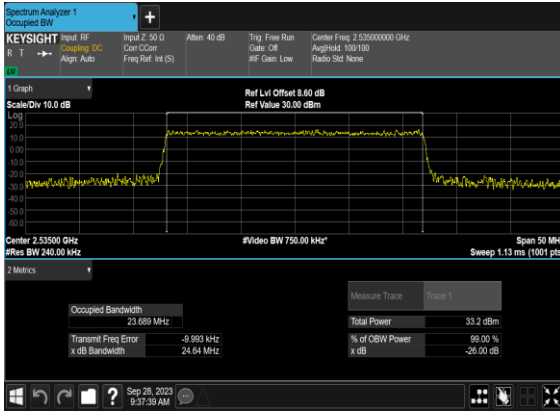

N7(25M)_CP-OFDM_256 QAM_Outer_Full_Mid_CH

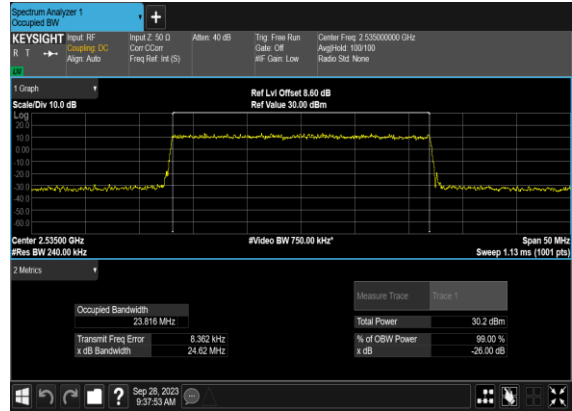

N7(30M)_CP- OFDM_QPSK_Outer_Full_Mid_CH

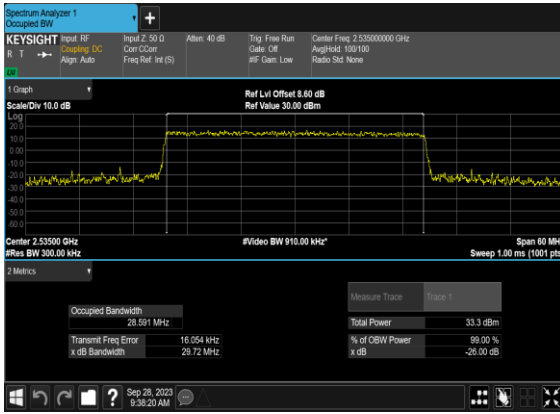

N7(30M)_CP-OFDM_16 QAM_Outer_Full_Mid_CH

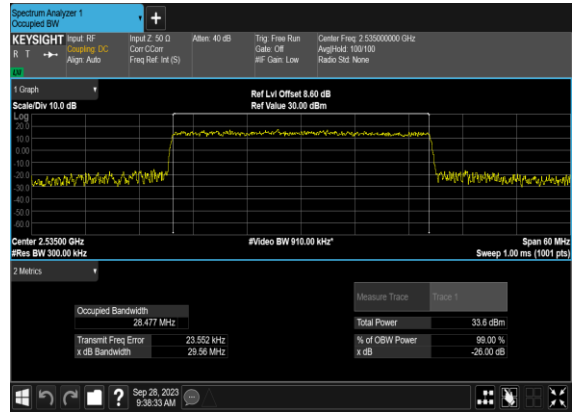

N7(30M)_CP-OFDM_64 QAM_Outer_Full_Mid_CH

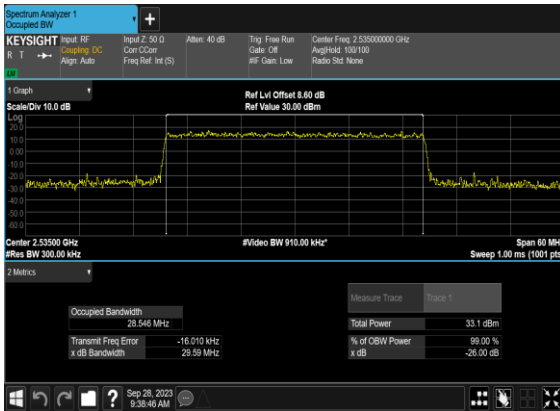

N7(30M)_CP-OFDM_256 QAM_Outer_Full_Mid_CH

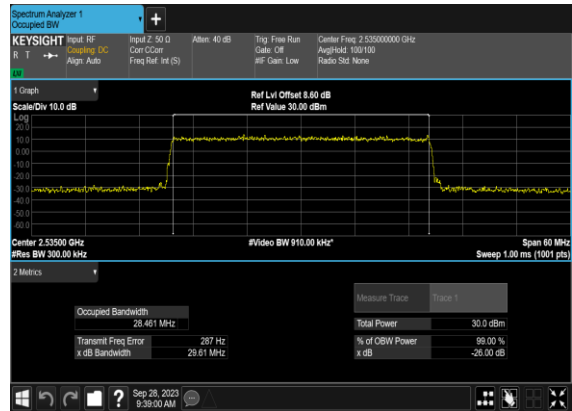

N7(40M)_CP-OFDM_QPSK_Outer_Full_Mid_CH

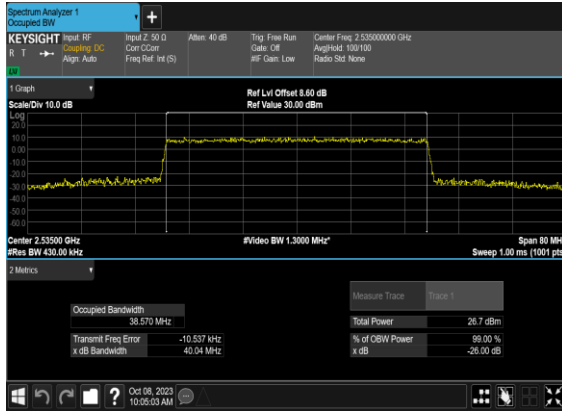

N7(40M)_CP-OFDM_16QAM_Outer_Full_Mid_CH

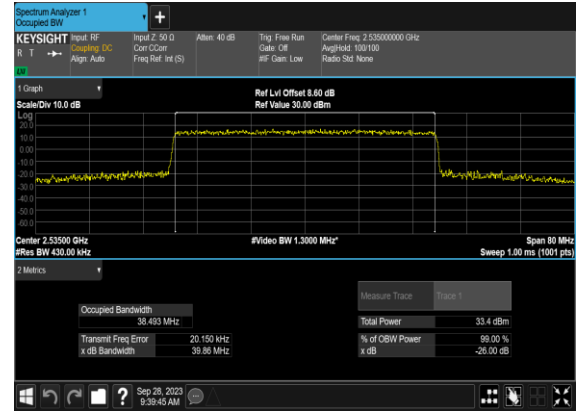

N7(40M)_CP-OFDM_64QAM_Outer_Full_Mid_CH

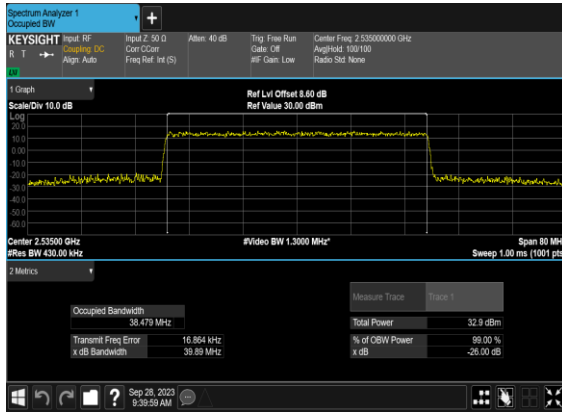

N7(40M)_CP-OFDM_256QAM_Outer_Full_Mid_CH

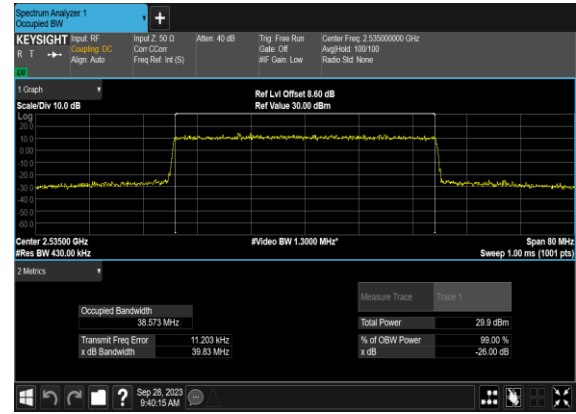

N7(50M)_CP-OFDM_QPSK_Outer_Full_Mid_CH

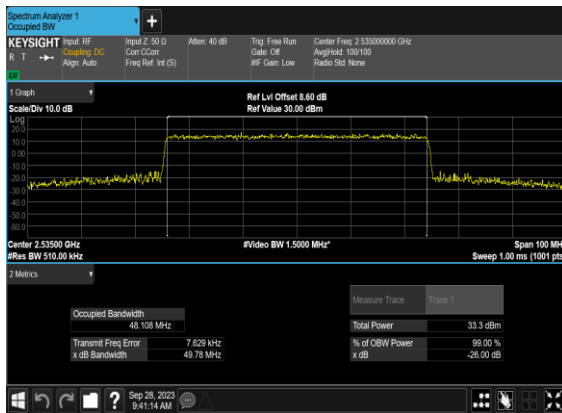

N7(50M)_CP-OFDM_16QAM_Outer_Full_Mid_CH

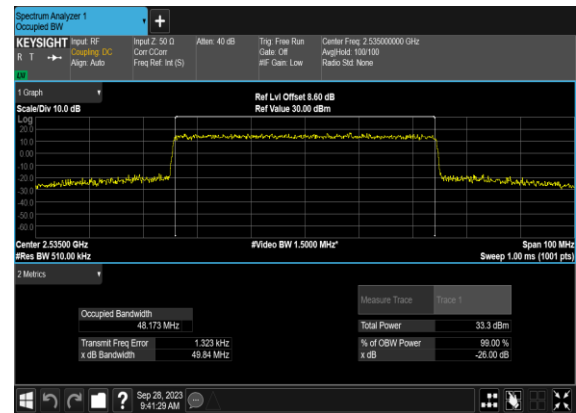

N7(50M)_CP-OFDM_64 QAM_Outer_Full_Mid_CH

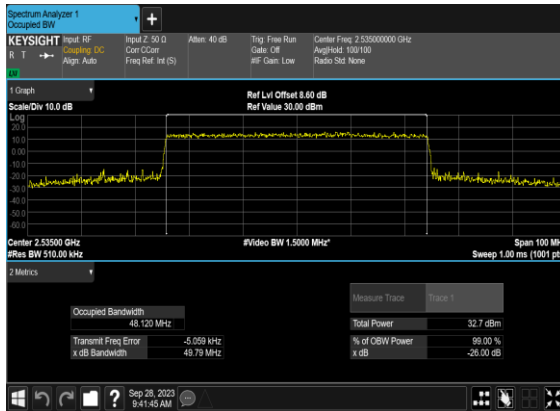

N7(50M)_CP-OFDM_256 QAM_Outer_Full_Mid_CH

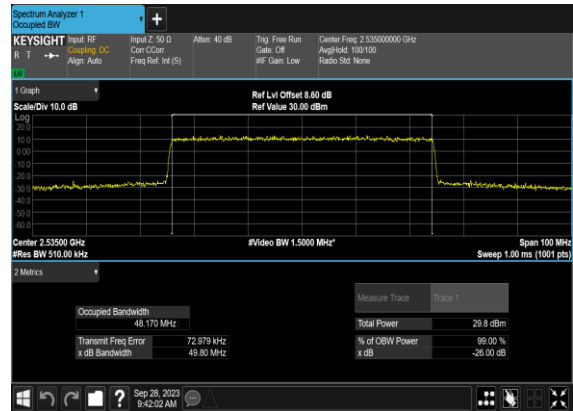

Conducted Spurious Emissions

NR Band	SCS (kHz)	Bandwidth (MHz)	Arfcn	Freq (MHz)	Modulation	RB	Result	Verdict
7	15	5	500500	2502.5	DFT-s-OFDM BPSK	1@0	see graph	---
7	15	5	500500	2502.5	DFT-s-OFDM BPSK	1@0	see graph	PASS
7	15	5	500500	2502.5	DFT-s-OFDM BPSK	1@0	see graph	PASS
7	15	5	500500	2502.5	DFT-s-OFDM QPSK	1@0	see graph	---
7	15	5	500500	2502.5	DFT-s-OFDM QPSK	1@0	see graph	PASS
7	15	5	500500	2502.5	DFT-s-OFDM QPSK	1@0	see graph	PASS
7	15	5	507000	2535.0	DFT-s-OFDM BPSK	1@0	see graph	---
7	15	5	507000	2535.0	DFT-s-OFDM BPSK	1@0	see graph	PASS
7	15	5	507000	2535.0	DFT-s-OFDM BPSK	1@0	see graph	PASS
7	15	5	507000	2535.0	DFT-s-OFDM QPSK	1@0	see graph	---
7	15	5	507000	2535.0	DFT-s-OFDM QPSK	1@0	see graph	PASS
7	15	5	507000	2535.0	DFT-s-OFDM QPSK	1@0	see graph	PASS
7	15	5	513500	2567.5	DFT-s-OFDM BPSK	1@0	see graph	---
7	15	5	513500	2567.5	DFT-s-OFDM BPSK	1@0	see graph	PASS
7	15	5	513500	2567.5	DFT-s-OFDM BPSK	1@0	see graph	PASS
7	15	5	513500	2567.5	DFT-s-OFDM QPSK	1@0	see graph	---
7	15	5	513500	2567.5	DFT-s-OFDM QPSK	1@0	see graph	PASS
7	15	5	513500	2567.5	DFT-s-OFDM QPSK	1@0	see graph	PASS
7	15	20	502000	2510.0	DFT-s-OFDM BPSK	1@0	see graph	---
7	15	20	502000	2510.0	DFT-s-OFDM BPSK	1@0	see graph	PASS
7	15	20	502000	2510.0	DFT-s-OFDM BPSK	1@0	see graph	PASS
7	15	20	502000	2510.0	DFT-s-OFDM QPSK	1@0	see graph	---

7	15	20	502000	2510.0	DFT-s-OFDM QPSK	1@0	see graph	PASS
7	15	20	502000	2510.0	DFT-s-OFDM QPSK	1@0	see graph	PASS
7	15	20	507000	2535.0	DFT-s-OFDM BPSK	1@0	see graph	---
7	15	20	507000	2535.0	DFT-s-OFDM BPSK	1@0	see graph	PASS
7	15	20	507000	2535.0	DFT-s-OFDM BPSK	1@0	see graph	PASS
7	15	20	507000	2535.0	DFT-s-OFDM QPSK	1@0	see graph	---
7	15	20	507000	2535.0	DFT-s-OFDM QPSK	1@0	see graph	PASS
7	15	20	507000	2535.0	DFT-s-OFDM QPSK	1@0	see graph	PASS
7	15	20	512000	2560.0	DFT-s-OFDM BPSK	1@0	see graph	---
7	15	20	512000	2560.0	DFT-s-OFDM BPSK	1@0	see graph	PASS
7	15	20	512000	2560.0	DFT-s-OFDM BPSK	1@0	see graph	PASS
7	15	20	512000	2560.0	DFT-s-OFDM QPSK	1@0	see graph	---
7	15	20	512000	2560.0	DFT-s-OFDM QPSK	1@0	see graph	PASS
7	15	20	512000	2560.0	DFT-s-OFDM QPSK	1@0	see graph	PASS
7	15	50	505000	2525.0	DFT-s-OFDM BPSK	1@0	see graph	---
7	15	50	505000	2525.0	DFT-s-OFDM BPSK	1@0	see graph	PASS
7	15	50	505000	2525.0	DFT-s-OFDM BPSK	1@0	see graph	PASS
7	15	50	505000	2525.0	DFT-s-OFDM QPSK	1@0	see graph	---
7	15	50	505000	2525.0	DFT-s-OFDM QPSK	1@0	see graph	PASS
7	15	50	505000	2525.0	DFT-s-OFDM QPSK	1@0	see graph	PASS
7	15	50	507000	2535.0	DFT-s-OFDM BPSK	1@0	see graph	---
7	15	50	507000	2535.0	DFT-s-OFDM BPSK	1@0	see graph	PASS
7	15	50	507000	2535.0	DFT-s-OFDM BPSK	1@0	see graph	PASS
7	15	50	507000	2535.0	DFT-s-OFDM QPSK	1@0	see graph	---

7	15	50	507000	2535.0	DFT-s-OFDM QPSK	1@0	see graph	PASS
7	15	50	507000	2535.0	DFT-s-OFDM QPSK	1@0	see graph	PASS
7	15	50	509000	2545.0	DFT-s-OFDM BPSK	1@0	see graph	---
7	15	50	509000	2545.0	DFT-s-OFDM BPSK	1@0	see graph	PASS
7	15	50	509000	2545.0	DFT-s-OFDM BPSK	1@0	see graph	PASS
7	15	50	509000	2545.0	DFT-s-OFDM QPSK	1@0	see graph	---
7	15	50	509000	2545.0	DFT-s-OFDM QPSK	1@0	see graph	PASS
7	15	50	509000	2545.0	DFT-s-OFDM QPSK	1@0	see graph	PASS

N7(5M)_DFT-s-OFDM_BPSK_Edge_1RB_Left_Low_CH

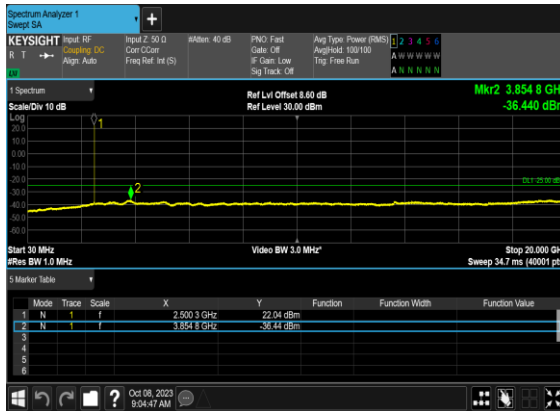

N7(5M)_DFT-s-OFDM_BPSK_Edge_1RB_Left_Low_CH

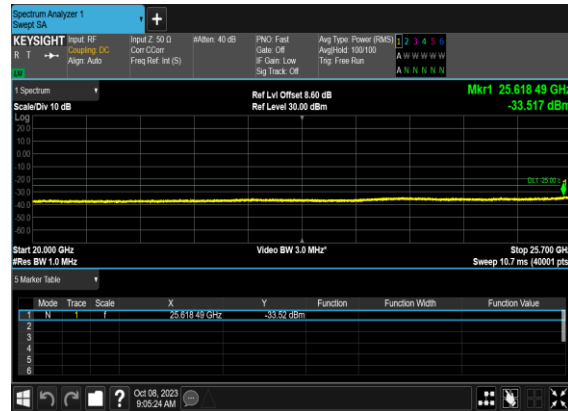

N7(5M)_DFT-s-OFDM_QPSK_Edge_1RB_Left_Low_CH

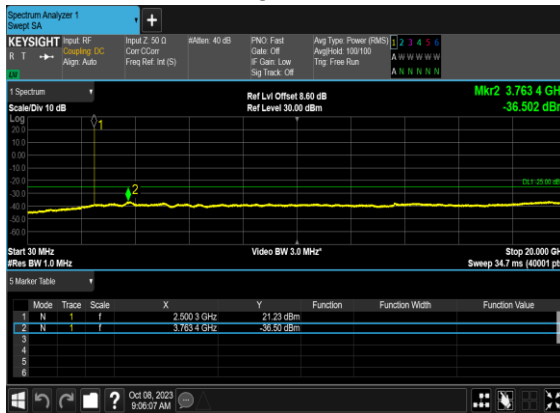

N7(5M)_DFT-s-OFDM_QPSK_Edge_1RB_Left_Low_CH

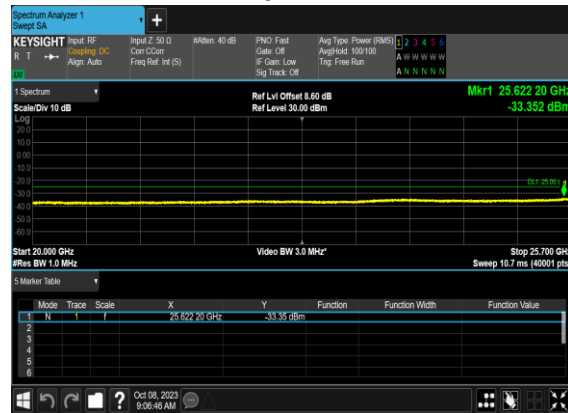

N7(5M)_DFT-s-OFDM_BPSK_Edge_1RB_Left_Mid_CH

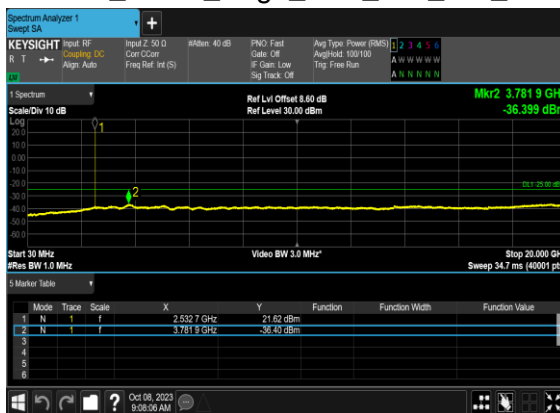

N7(5M)_DFT-s-OFDM_BPSK_Edge_1RB_Left_Mid_CH

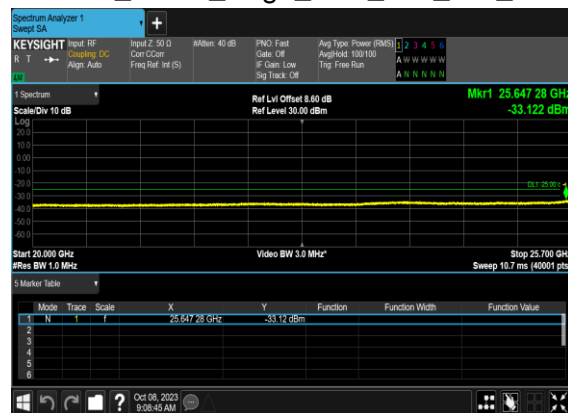

N7(5M)_DFT-s-OFDM_QPSK_Edge_1RB_Left_Mid_CH

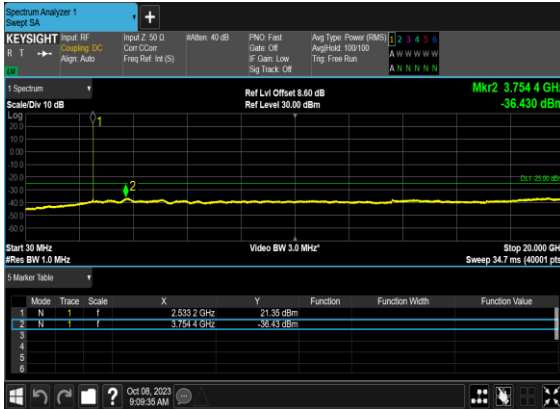

N7(5M)_DFT-s-OFDM_QPSK_Edge_1RB_Left_Mid_CH

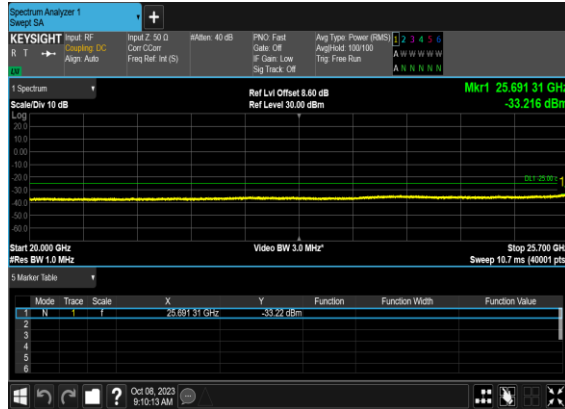

N7(5M)_DFT-s-OFDM_BPSK_Edge_1RB_Left_High_CH

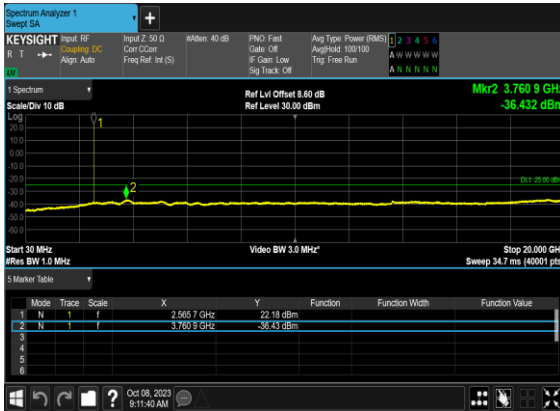

N7(5M)_DFT-s-OFDM_BPSK_Edge_1RB_Left_High_CH

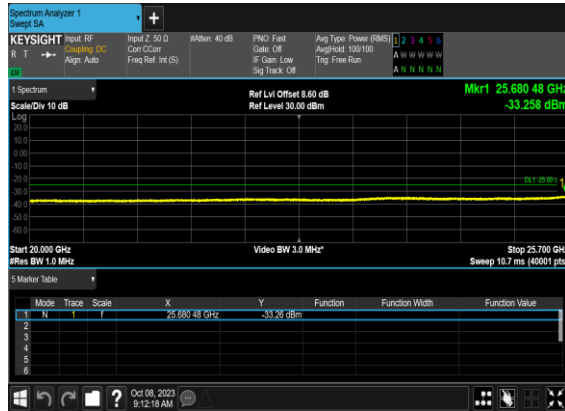

N7(5M)_DFT-s-OFDM_QPSK_Edge_1RB_Left_High_CH

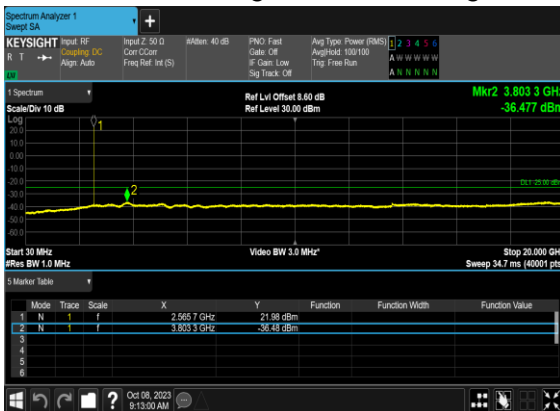

N7(5M)_DFT-s-OFDM_QPSK_Edge_1RB_Left_High_CH

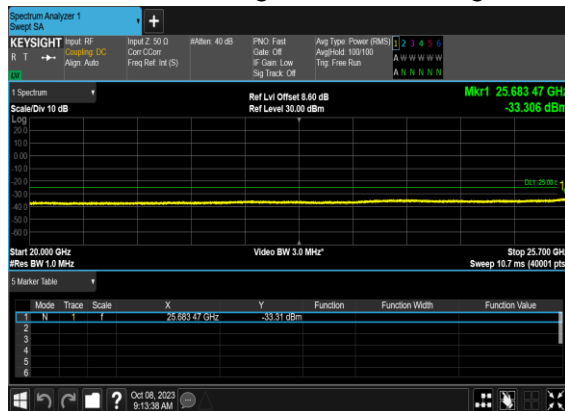

N7(20M)_DFT-s-OFDM_BPSK_Edge_1RB_Left_Low_CH

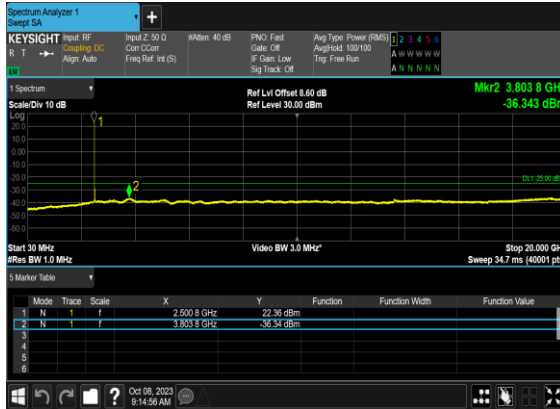

N7(20M)_DFT-s-OFDM_BPSK_Edge_1RB_Left_Low_CH

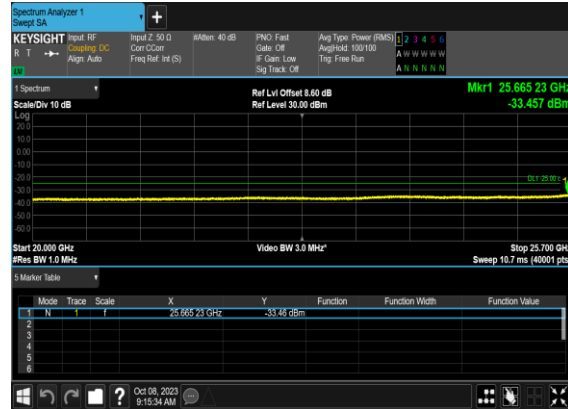

N7(20M)_DFT-s-OFDM_QPSK_Edge_1RB_Left_Low_CH

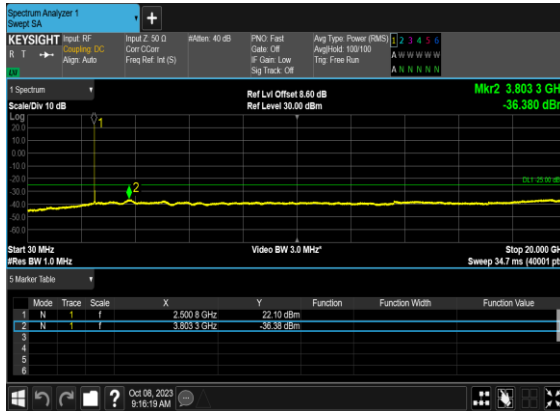

N7(20M)_DFT-s-OFDM_QPSK_Edge_1RB_Left_Low_CH

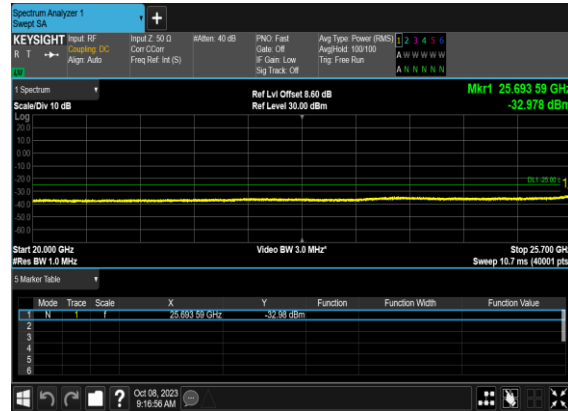

N7(20M)_DFT-s-OFDM_BPSK_Edge_1RB_Left_Mid_CH

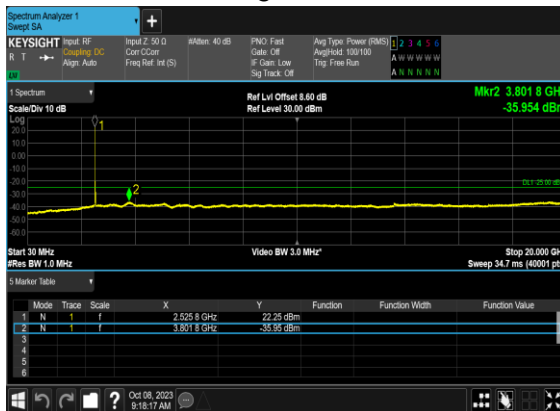

N7(20M)_DFT-s-OFDM_BPSK_Edge_1RB_Left_Mid_CH

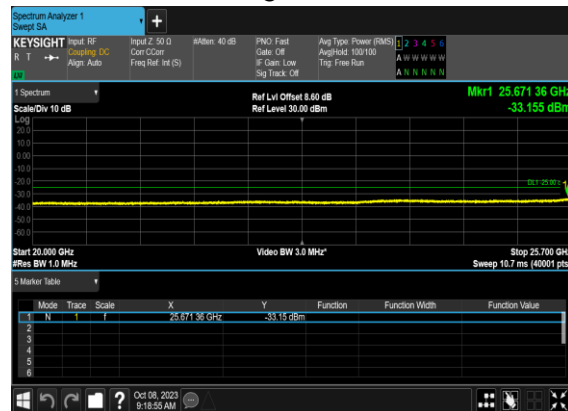

N7(20M)_DFT-s-OFDM_QPSK_Edge_1RB_Left_Mid_CH

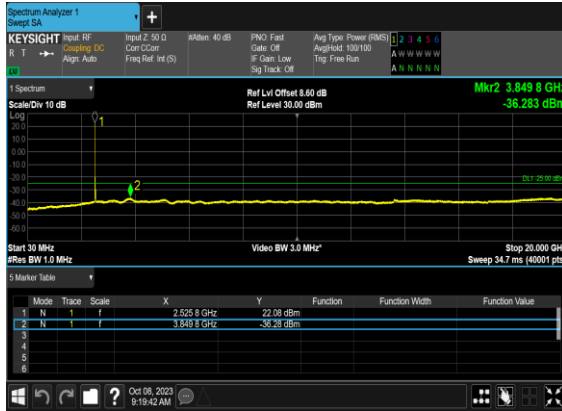

N7(20M)_DFT-s-OFDM_QPSK_Edge_1RB_Left_Mid_CH

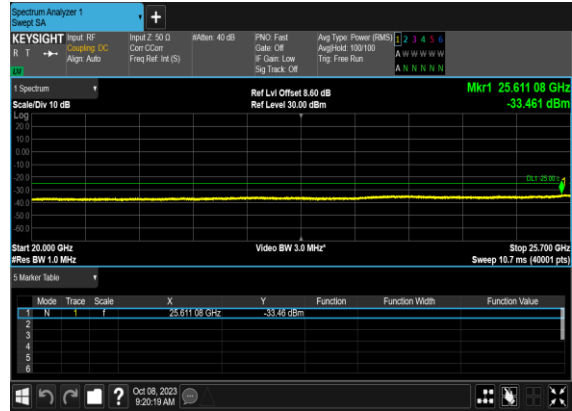

N7(20M)_DFT-s-OFDM_BPSK_Edge_1RB_Left_High_CH

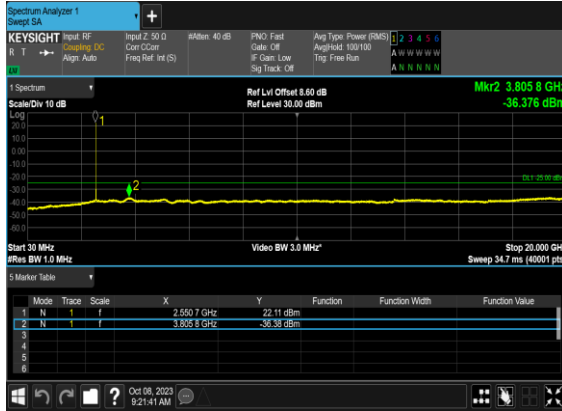

N7(20M)_DFT-s-OFDM_BPSK_Edge_1RB_Left_High_CH

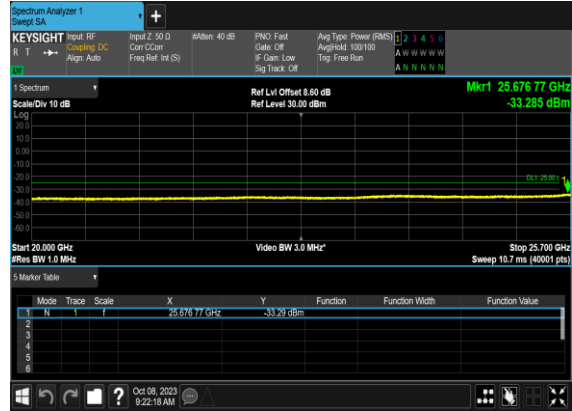

N7(20M)_DFT-s-OFDM_QPSK_Edge_1RB_Left_High_CH

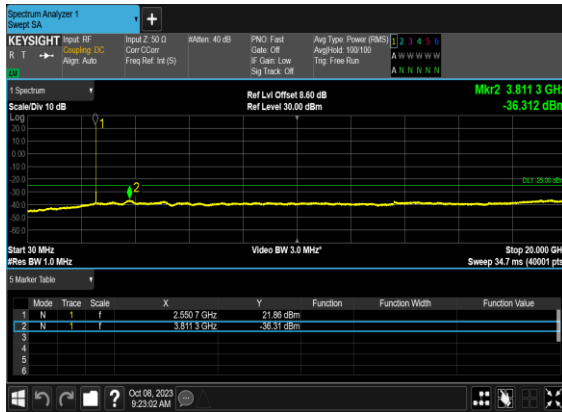

N7(20M)_DFT-s-OFDM_QPSK_Edge_1RB_Left_High_CH

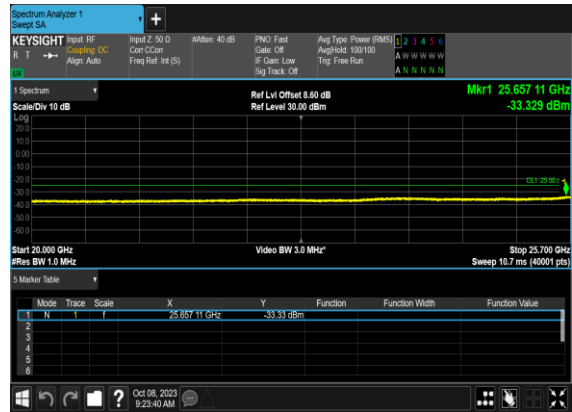

N7(50M)_DFT-s-OFDM_BPSK_Edge_1RB_Left_Low_CH

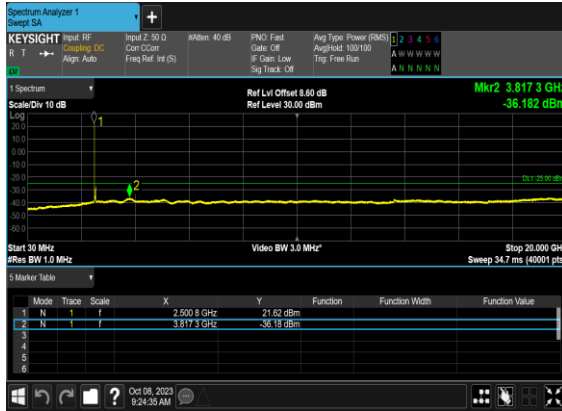

N7(50M)_DFT-s-OFDM_BPSK_Edge_1RB_Left_Low_CH

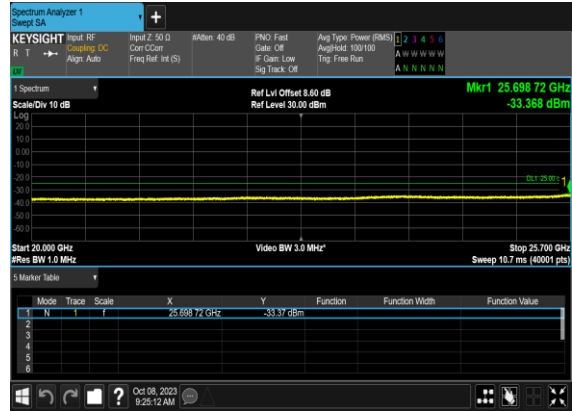

N7(50M)_DFT-s-OFDM_QPSK_Edge_1RB_Left_Low_CH

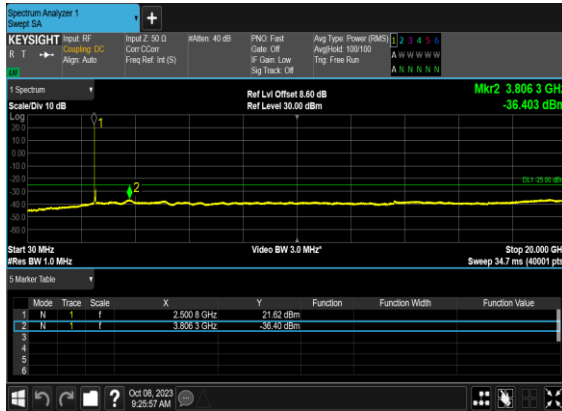

N7(50M)_DFT-s-OFDM_QPSK_Edge_1RB_Left_Low_CH

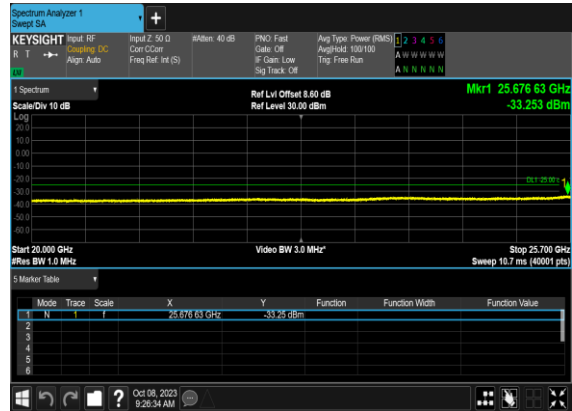

N7(50M)_DFT-s-OFDM_BPSK_Edge_1RB_Left_Mid_CH

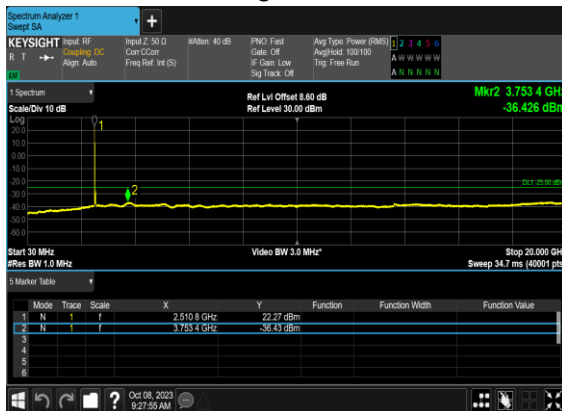

N7(50M)_DFT-s-OFDM_BPSK_Edge_1RB_Left_Mid_CH

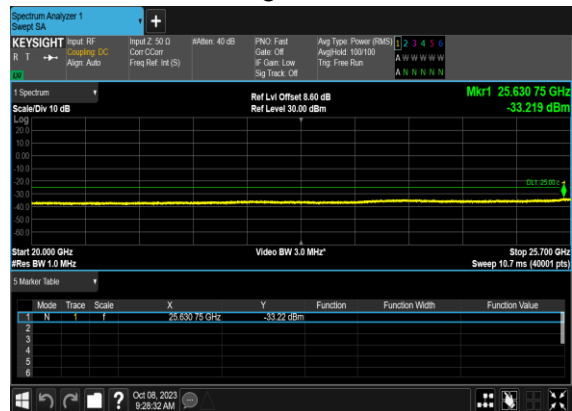

N7(50M)_DFT-s-OFDM_QPSK_Edge_1RB_Left_Mid_CH

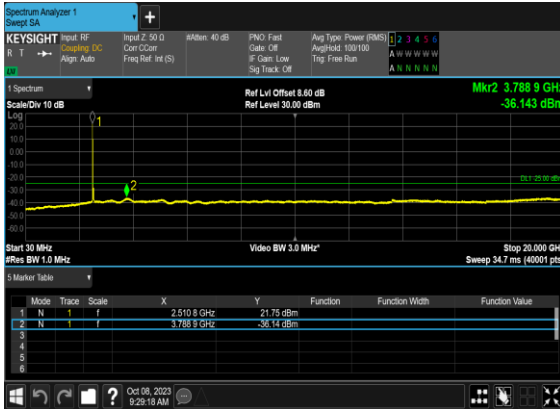

N7(50M)_DFT-s-OFDM_QPSK_Edge_1RB_Left_Mid_CH

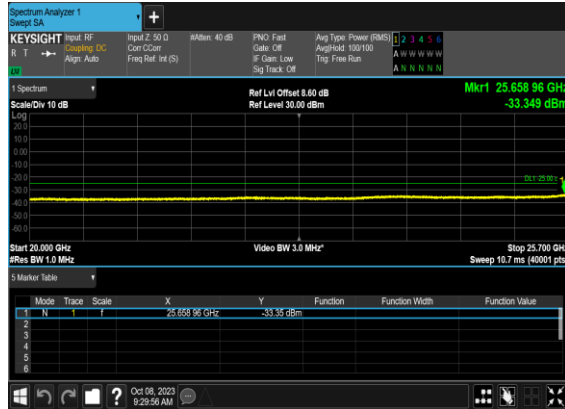

N7(50M)_DFT-s-OFDM_BPSK_Edge_1RB_Left_High_CH

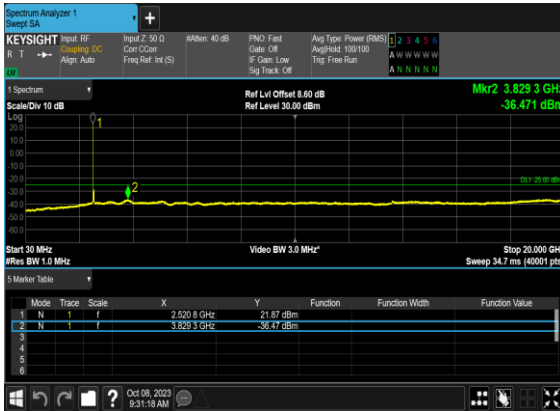

N7(50M)_DFT-s-OFDM_BPSK_Edge_1RB_Left_High_CH

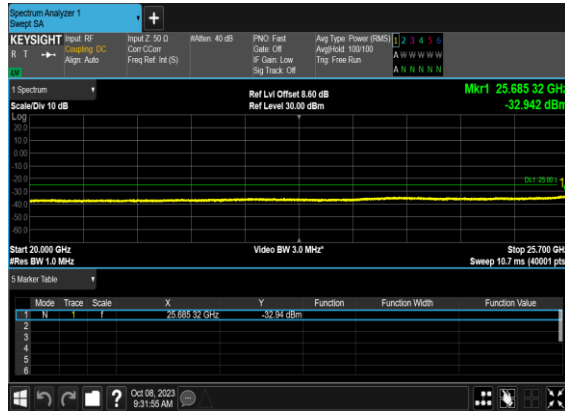

N7(50M)_DFT-s-OFDM_QPSK_Edge_1RB_Left_High_CH

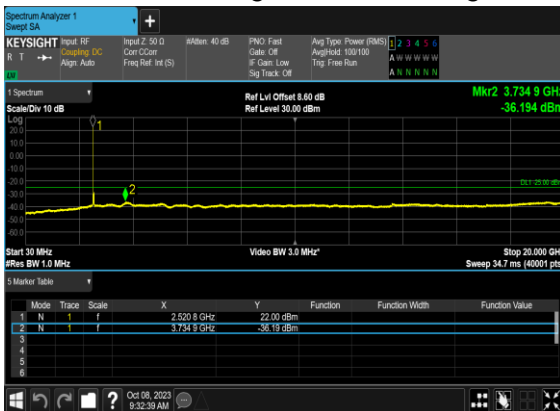

N7(50M)_DFT-s-OFDM_QPSK_Edge_1RB_Left_High_CH

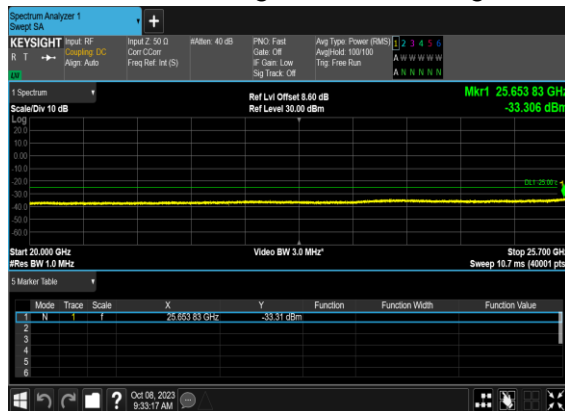

Conducted Band Edge

NR Band	SCS (kHz)	Bandwidth (MHz)	Arfcn	Freq (MHz)	Modulation	RB	Result	Verdict
7	15	5	500500	2502.5	DFT-s-OFDM BPSK	1@0	see graph	PASS
7	15	5	500500	2502.5	DFT-s-OFDM QPSK	1@0	see graph	PASS
7	15	5	500500	2502.5	DFT-s-OFDM BPSK	25@0	see graph	PASS
7	15	5	500500	2502.5	DFT-s-OFDM QPSK	25@0	see graph	PASS
7	15	5	513500	2567.5	DFT-s-OFDM BPSK	1@24	see graph	PASS
7	15	5	513500	2567.5	DFT-s-OFDM QPSK	1@24	see graph	PASS
7	15	5	513500	2567.5	DFT-s-OFDM BPSK	25@0	see graph	PASS
7	15	5	513500	2567.5	DFT-s-OFDM QPSK	25@0	see graph	PASS
7	15	20	502000	2510.0	DFT-s-OFDM BPSK	1@0	see graph	PASS
7	15	20	502000	2510.0	DFT-s-OFDM QPSK	1@0	see graph	PASS
7	15	20	502000	2510.0	DFT-s-OFDM BPSK	100@0	see graph	PASS
7	15	20	502000	2510.0	DFT-s-OFDM QPSK	100@0	see graph	PASS
7	15	20	512000	2560.0	DFT-s-OFDM BPSK	1@105	see graph	PASS
7	15	20	512000	2560.0	DFT-s-OFDM QPSK	1@105	see graph	PASS
7	15	20	512000	2560.0	DFT-s-OFDM BPSK	100@0	see graph	PASS
7	15	20	512000	2560.0	DFT-s-OFDM QPSK	100@0	see graph	PASS
7	15	50	505000	2525.0	DFT-s-OFDM BPSK	1@0	see graph	PASS
7	15	50	505000	2525.0	DFT-s-OFDM QPSK	1@0	see graph	PASS
7	15	50	505000	2525.0	DFT-s-OFDM BPSK	270@0	see graph	PASS
7	15	50	505000	2525.0	DFT-s-OFDM QPSK	270@0	see graph	PASS
7	15	50	509000	2545.0	DFT-s-OFDM BPSK	1@269	see graph	PASS
7	15	50	509000	2545.0	DFT-s-OFDM QPSK	1@269	see graph	PASS
7	15	50	509000	2545.0	DFT-s-OFDM BPSK	270@0	see graph	PASS
7	15	50	509000	2545.0	DFT-s-OFDM QPSK	270@0	see graph	PASS

N7(5M)_DFT-s- OFDM_BPSK_Edge_1RB_Left_Low_CH

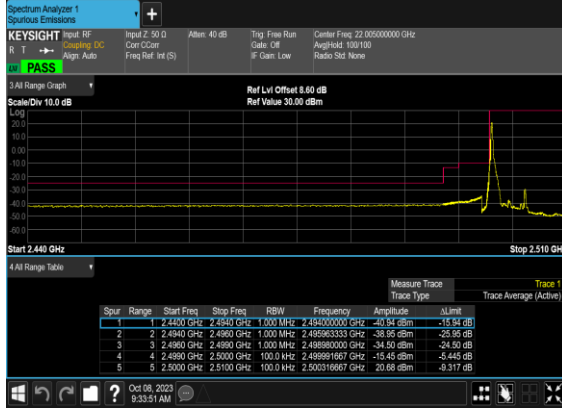

N7(5M)_DFT-s- OFDM_QPSK_Edge_1RB_Left_Low_CH



N7(5M)_DFT-s- OFDM_BPSK_Outer_Full_Low_CH

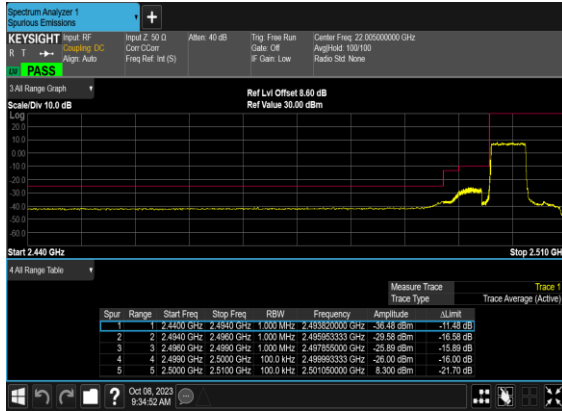

N7(5M)_DFT-s- OFDM_QPSK_Outer_Full_Low_CH

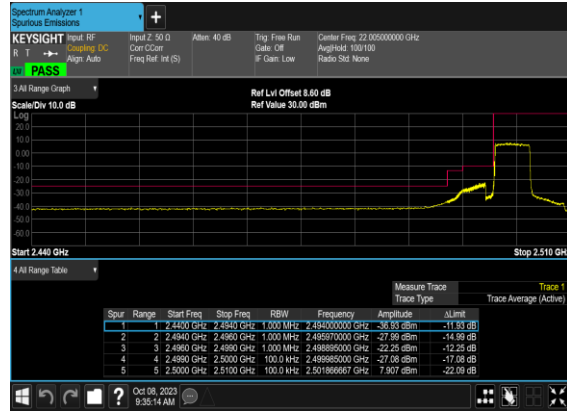

N7(5M)_DFT-s- OFDM_BPSK_Edge_1RB_Right_High_CH

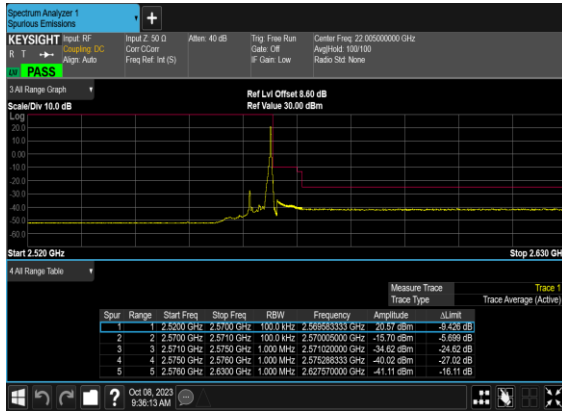

N7(5M)_DFT-s- OFDM_QPSK_Edge_1RB_Right_High_CH

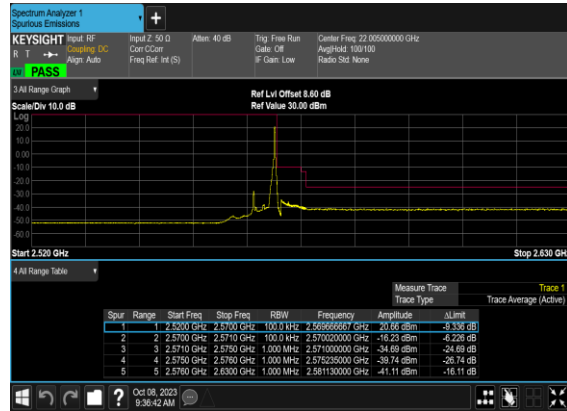

N7(5M)_DFT-s-OFDM_BPSK_Outer_Full_High_CH

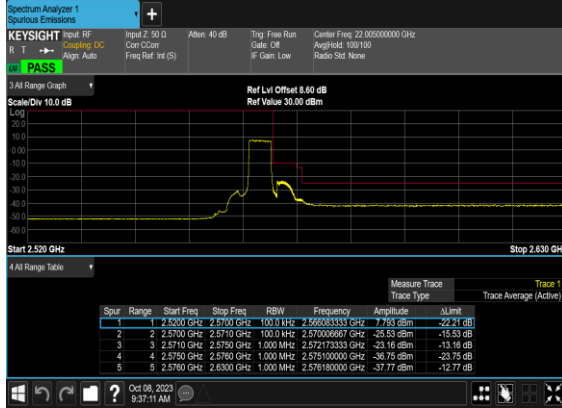

N7(5M)_DFT-s-OFDM_QPSK_Outer_Full_High_CH

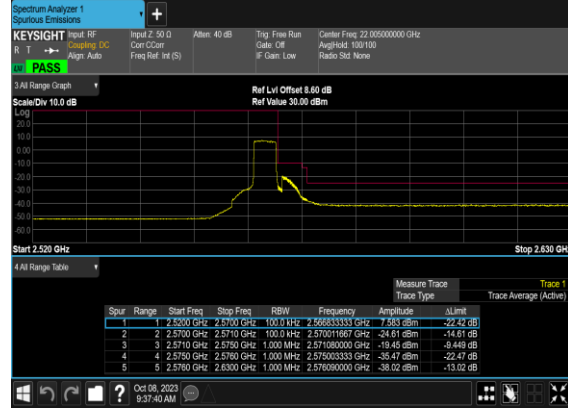

N7(20M)_DFT-s-OFDM_BPSK_Edge_1RB_Left_Low_CH

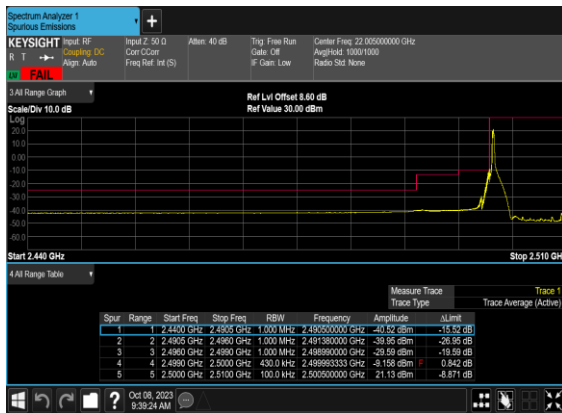

N7(20M)_DFT-s-OFDM_BPSK_Edge_1RB_Left_Low_CH_CHP_PASS

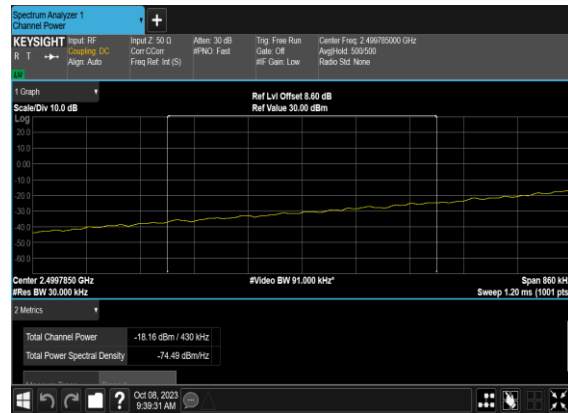

N7(20M)_DFT-s-OFDM_QPSK_Edge_1RB_Left_Low_CH

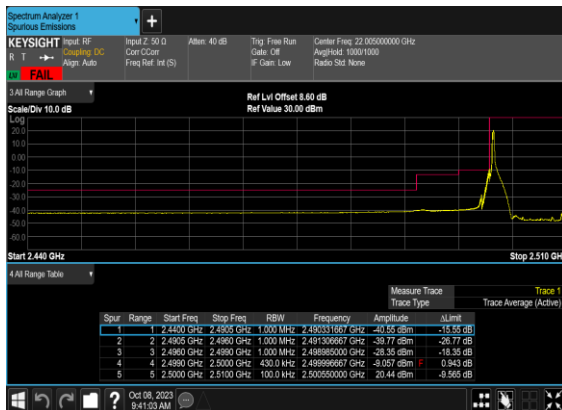

N7(20M)_DFT-s-OFDM_QPSK_Edge_1RB_Left_Low_CH_CHP_PASS

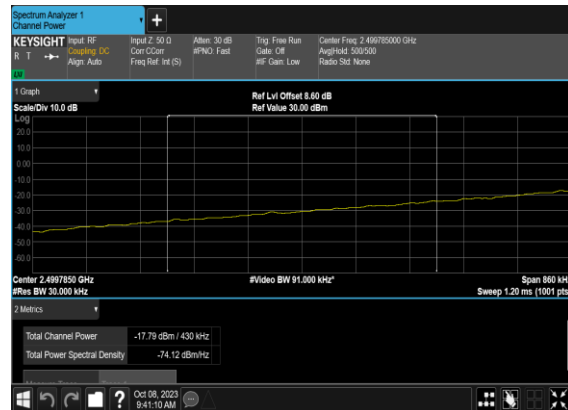

N7(20M)_DFT-s-OFDM_BPSK_Outer_Full_Low_CH

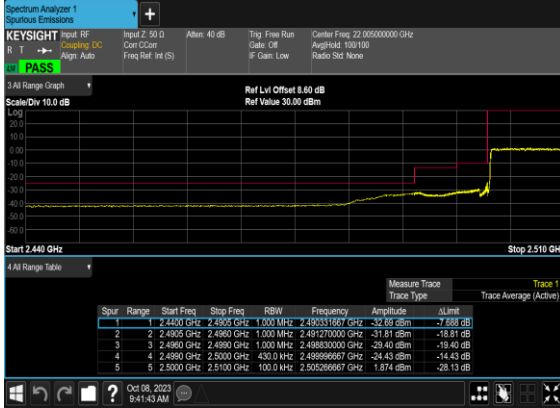

N7(20M)_DFT-s-OFDM_QPSK_Outer_Full_Low_CH

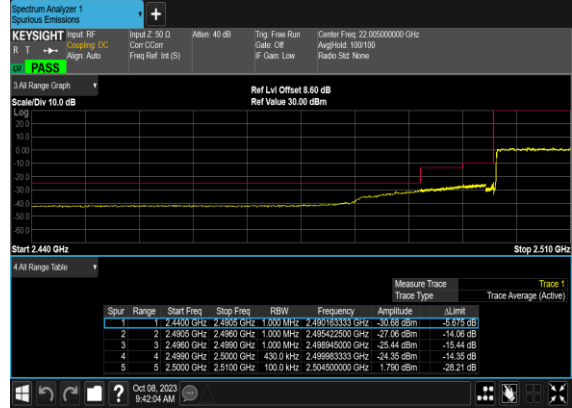

N7(20M)_DFT-s-OFDM_BPSK_Edge_1RB_Right_High_CH

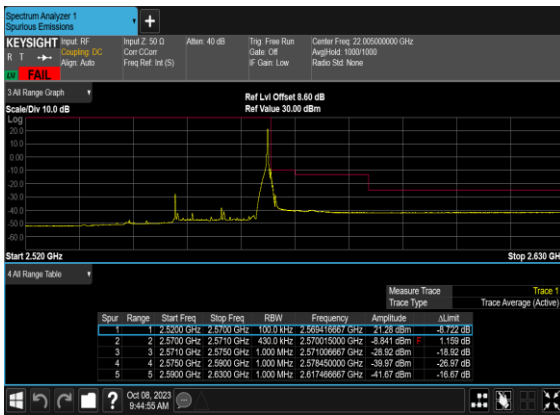

N7(20M)_DFT-s-OFDM_BPSK_Edge_1RB_Right_High_CH_CHP_PASS

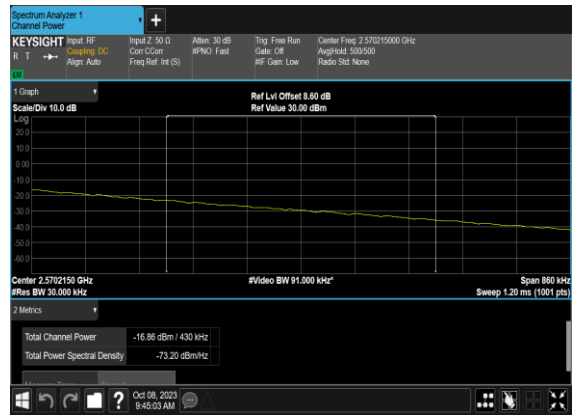

N7(20M)_DFT-s-OFDM_QPSK_Edge_1RB_Right_High_CH

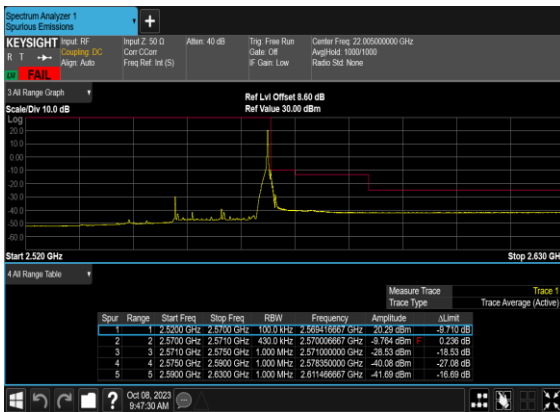

N7(20M)_DFT-s-OFDM_QPSK_Edge_1RB_Right_High_CH_CHP_PASS

