



# FCC RF Test Report

**APPLICANT** : Motorola Mobility LLC  
**EQUIPMENT** : Mobile Cellular Phone  
**BRAND NAME** : Motorola  
**MODEL NAME** : XT2415-1,XT2415-3,XT2415-5,XT2415V  
**FCC ID** : IHDT56AN5  
**STANDARD** : 47 CFR Part 2, Part 27 Subpart Q  
**CLASSIFICATION** : PCS Licensed Transmitter Held to Ear (PCE)  
**TEST DATE(S)** : Sep. 28, 2023 ~ Oct. 10, 2023

We, Sporton International Inc. (ShenZhen), would like to declare that the tested sample has been evaluated in accordance with the procedures given in ANSI C63.26-2015 and shown compliance with the applicable technical standards.

The test results in this report apply exclusively to the tested model / sample. Without written approval of Sporton International Inc. (ShenZhen), the test report shall not be reproduced except in full.

Jason Jia



Approved by: Jason Jia

**Sporton International Inc. (ShenZhen)**

**1/F, 2/F, Bldg 5, Shiling Industrial Zone, Xinwei Village, Xili, Nanshan, Shenzhen, 518055**

**People's Republic of China**



TABLE OF CONTENTS

REVISION HISTORY..... 3
SUMMARY OF TEST RESULT ..... 4
1 GENERAL DESCRIPTION ..... 5
1.1 Applicant ..... 5
1.2 Manufacturer ..... 5
1.3 Product Feature of Equipment Under Test ..... 5
1.4 Product Specification of Equipment Under Test ..... 5
1.5 Modification of EUT ..... 6
1.6 Specification of Accessory ..... 6
1.7 Maximum EIRP Power and Emission Designator ..... 7
1.8 Testing Site ..... 8
1.9 Test Software ..... 8
1.10 Applied Standards ..... 9
2 TEST CONFIGURATION OF EQUIPMENT UNDER TEST ..... 10
2.1 Test Mode ..... 10
2.2 Connection Diagram of Test System ..... 11
2.3 Support Unit used in test configuration and system ..... 11
2.4 Measurement Results Explanation Example ..... 11
2.5 Frequency List of Low/Middle/High Channels ..... 12
3 CONDUCTED TEST ITEMS ..... 13
3.1 Measuring Instruments ..... 13
3.2 Test Setup ..... 13
3.3 Test Result of Conducted Test ..... 13
3.4 Conducted Output Power Measurement ..... 14
3.5 Peak-to-Average Ratio ..... 15
3.6 EIRP ..... 16
3.7 Occupied Bandwidth ..... 17
3.8 Conducted Band Edge Measurement ..... 18
3.9 Conducted Spurious Emission Measurement ..... 19
3.10 Frequency Stability Measurement ..... 20
4 RADIATED TEST ITEMS ..... 21
4.1 Measuring Instruments ..... 21
4.2 Test Setup ..... 21
4.3 Test Result of Radiated Test ..... 22
4.4 Radiated Spurious Emission Measurement ..... 23
5 LIST OF MEASURING EQUIPMENT ..... 24
6 MEASUREMENT UNCERTAINTY ..... 25
APPENDIX A. TEST RESULTS OF CONDUCTED TEST
APPENDIX B. TEST RESULTS OF RADIATED TEST
APPENDIX C. TEST SETUP PHOTOGRAPHS



### REVISION HISTORY

REPORT NO.	VERSION	DESCRIPTION	ISSUED DATE
FG391202R	Rev. 01	Initial issue of report	Oct. 25, 2023



### SUMMARY OF TEST RESULT

Report Section	FCC Rule	Description	Limit	Result	Remark
3.4	§2.1046	Conducted Output Power	—	Report Only	-
3.5	§27.50 (k)(4)	Peak-to-Average Ratio	<13dB	PASS	
3.6	§27.50 (k)(3)	EIRP	EIRP < 1W (30dBm)	PASS	-
3.7	§2.1049	Occupied Bandwidth	—	Report Only	-
3.8	§2.1051 §27.53 (n)(2)	Conducted Band Edge Measurement	-13dBm/MHz	PASS	-
3.9	§2.1051 §27.53 (n)(2)	Conducted Spurious Emission	-13dBm/MHz	PASS	-
3.10	§2.1055 §27.54	Frequency Stability Temperature & Voltage	Within the band	PASS	-
4.4	§2.1053 §27.53 (n)(2)	Radiated Spurious Emission	-13dBm/MHz	PASS	Under limit 11.65 dB at 4611.00 MHz

**Conformity Assessment Condition:**

- The test results (PASS/FAIL) with all measurement uncertainty excluded are presented against the regulation limits or in accordance with the requirements stipulated by the applicant/manufacturer who shall bear all the risks of non-compliance that may potentially occur if measurement uncertainty is taken into account.
- The measurement uncertainty please refer to each test result in the section "Measurement Uncertainty"

**Disclaimer:**

The product specifications of the EUT presented in the test report that may affect the test assessments are declared by the manufacturer who shall take full responsibility for the authenticity.



# 1 General Description

## 1.1 Applicant

Motorola Mobility LLC  
222 W,Merchandise Mart Plaza, Chicago IL 60654 USA

## 1.2 Manufacturer

Motorola Mobility LLC  
222 W,Merchandise Mart Plaza, Chicago IL 60654 USA

## 1.3 Product Feature of Equipment Under Test

Product Feature	
Equipment	Mobile Cellular Phone
Brand Name	Motorola
Model Name	XT2415-1,XT2415-3,XT2415-5,XT2415V
FCC ID	IHDT56AN5
IMEI Code	Conducted: 357534480030391/357534480030409 Radiation: 357534480030573/357534480030581
HW Version	DVT2
SW Version	UUD34.38
EUT Stage	Identical Prototype

Remark:

1. The above EUT's information was declared by manufacturer. Please refer to the specifications or user's manual for more detailed description.
2. The four model names are only for market segment purpose, there is no other difference.

## 1.4 Product Specification of Equipment Under Test

Product Feature	
Tx/Rx Frequency	5G NR n77: 3450 MHz ~ 3550 MHz 5G NR n78: 3450 MHz ~ 3550 MHz
SCS	30kHz
Bandwidth	n77/n78: 10 / 15 / 20 / 30 / 40 / 50 / 60 / 70 / 80 / 90 / 100MHz
Antenna Gain	<Ant. 1> 5G NR n77: -2.0 dBi 5G NR n78: -2.0 dBi <Ant. 2> 5G NR n77: -3.5 dBi 5G NR n78: -3.5 dBi <Ant. 5> 5G NR n77: -1.5 dBi 5G NR n78: -1.5 dBi <Ant. 8> 5G NR n77: -4.0 dBi

	5G NR n78: -4.0 dBi
<b>Type of Modulation</b>	CP-OFDM: QPSK / 16QAM / 64QAM / 256QAM DFT-s-OFDM: PI/2 BPSK / QPSK / 16QAM / 64QAM / 256QAM

**Remark:**

1. The maximum EIRP is calculated from max output power and max antenna gain, only the maximum EIRP is shown in the report, 5G NR n77/n78 for Antenna 5.
2. 5G NR n77/n78 support SA and NSA mode. The whole testing has assessed SA mode for n77 by referring to the higher conducted power for conducted test items.
3. The device supports HPUE mode for 5G NR n77/n78.
4. The device supports n77/n78(1T4R) SRS resources on ant.1/2/5/8, only the test data of worst ant.5 is showed in the report according to the maximum power.
5. All the supported EN-DC combinations are verified conducted power, only the EN-DC combination with highest power are shown in the report.
6. The EN-DC mode combination could be referred to the product spec.

### 1.5 Modification of EUT

No modifications are made to the EUT during all test items.

### 1.6 Specification of Accessory

Accessories Information				
<b>AC Adapter 1</b>	<b>Brand Name</b>	Motorola(Salcomp)	<b>Model Name</b>	MC-101
<b>AC Adapter 2</b>	<b>Brand Name</b>	Motorola(Chenyang)	<b>Model Name</b>	MC-101
<b>AC Adapter 3</b>	<b>Brand Name</b>	Motorola(AOHAI)	<b>Model Name</b>	MC-101
<b>Battery 1</b>	<b>Brand Name</b>	Motorola (ATL)	<b>Model Name</b>	QA50
<b>USB Cable 1</b>	<b>Brand Name</b>	WASHIN	<b>Model Name</b>	S928D98335
<b>USB Cable 2</b>	<b>Brand Name</b>	Saibao	<b>Model Name</b>	S928D98333
<b>USB Cable 3</b>	<b>Brand Name</b>	Saibao	<b>Model Name</b>	S928D98334

## 1.7 Maximum EIRP Power and Emission Designator

5G NR n77 SA		PI/2 BPSK / QPSK		16QAM/64QAM/256QAM	
BW (MHz)	Frequency Range (MHz)	Maximum EIRP(W)	Emission Designator (99%OBW)	Maximum EIRP(W)	Emission Designator (99%OBW)
10	3455.01 ~ 3544.98	0.2723	8M56G7D	0.2228	8M60W7D
15	3457.50 ~ 3542.49	0.2716	13M5G7D	0.2084	13M6W7D
20	3460.02 ~ 3540.00	0.2704	18M2G7D	0.2046	18M2W7D
30	3465.00 ~ 3534.99	0.2642	27M8G7D	0.2014	27M8W7D
40	3470.01 ~ 3529.98	0.2477	37M8G7D	0.1901	37M9W7D
50	3475.02 ~ 3525.00	0.2667	47M5G7D	0.2028	47M5W7D
60	3480.00 ~ 3519.99	0.2606	57M8G7D	0.2158	57M8W7D
70	3485.01 ~ 3514.98	0.2535	67M5G7D	0.2104	67M5W7D
80	3490.02 ~ 3510.00	0.2466	77M4G7D	0.1923	77M4W7D
90	3495.00 ~ 3504.99	0.2399	87M3G7D	0.1828	87M3W7D
100	3500.01	0.2748	98M3G7D	0.2173	97M6W7D

5G NR n78 SA		PI/2 BPSK / QPSK		16QAM/64QAM/256QAM	
BW (MHz)	Frequency Range (MHz)	Maximum EIRP(W)	Emission Designator (99%OBW)	Maximum EIRP(W)	Emission Designator (99%OBW)
10	3455.01 ~ 3544.98	0.2692	8M56G7D	0.2032	8M60W7D
15	3457.50 ~ 3542.49	0.2692	13M5G7D	0.2023	13M6W7D
20	3460.02 ~ 3540.00	0.2642	18M2G7D	0.2009	18M2W7D
30	3465.00 ~ 3534.99	0.2559	27M8G7D	0.1941	27M8W7D
40	3470.01 ~ 3529.98	0.2432	37M8G7D	0.1849	37M9W7D
50	3475.02 ~ 3525.00	0.2612	47M5G7D	0.1977	47M5W7D
60	3480.00 ~ 3519.99	0.2553	57M8G7D	0.1950	57M8W7D
70	3485.01 ~ 3514.98	0.2500	67M5G7D	0.1901	67M5W7D
80	3490.02 ~ 3510.00	0.2410	77M4G7D	0.2014	77M4W7D
90	3495.00 ~ 3504.99	0.2317	87M3G7D	0.1928	87M3W7D
100	3500.01	0.2698	98M3G7D	0.2138	97M6W7D

**Note:**

- 5G NR Band n77 overlaps the entire frequency range of Band n78, and n77 power > n78 power, therefore the conducted test results of n77 provided in this report cover n78.
- All modulations have been tested, and only the worst test results of PSK & QAM are shown in the report.

### 1.8 Testing Site

Sporton International Inc. (ShenZhen) is accredited to ISO/IEC 17025:2017 by American Association for Laboratory Accreditation with Certificate Number 5145.01.

<b>Test Firm</b>	Sporton International Inc. (ShenZhen)		
<b>Test Site Location</b>	1/F, 2/F, Bldg 5, Shiling Industrial Zone, Xinwei Village, Xili, Nanshan, Shenzhen, 518055 People's Republic of China TEL: +86-755-86379589 FAX: +86-755-86379595		
<b>Test Site No.</b>	<b>Sporton Site No.</b>	<b>FCC Designation No.</b>	<b>FCC Test Firm Registration No.</b>
	TH01-SZ	CN1256	421272

<b>Test Firm</b>	Sporton International Inc. (ShenZhen)		
<b>Test Site Location</b>	101, 1st Floor, Block B, Building 1, No. 2, Tengfeng 4th Road, Fenghuang Community, Fuyong Street, Baoan District, Shenzhen City, Guangdong Province 518103 People's Republic of China TEL: +86-755-86066985		
<b>Test Site No.</b>	<b>Sporton Site No.</b>	<b>FCC Designation No.</b>	<b>FCC Test Firm Registration No.</b>
	03CH01-SZ	CN1256	421272

### 1.9 Test Software

Item	Site	Manufacture	Name	Version
1.	03CH01-SZ	AUDIX	E3	6.2009-8-24





## **1.10 Applied Standards**

According to the specifications of the manufacturer, the EUT must comply with the requirements of the following standards:

- ♦ 47 CFR Part 2, Part 27 Subpart Q
- ♦ ANSI C63.26-2015
- ♦ FCC KDB 971168 Power Meas License Digital Systems D01 v03r01
- ♦ FCC KDB 412172 D01 Determining ERP and EIRP v01r01

### **Remark:**

1. All test items were verified and recorded according to the standards and without any deviation during the test.
2. This EUT has also been tested and complied with the requirements of FCC Part 15, Subpart B, recorded in a separate test report.



## 2 Test Configuration of Equipment Under Test

### 2.1 Test Mode

Antenna port conducted and radiated test items listed below are performed according to KDB 971168 D01 Power Meas. License Digital Systems v03r01 with maximum output power.

Radiated measurements are performed by rotating the EUT in three different orthogonal test planes to find the maximum emission.

Test Items	5G NR	Bandwidth (MHz)												Modulation					RB #		Test Channel					
		5	10	15	20	25	30	40	50	60	70	80	90	100	PI/2 BPSK	QPSK	16QAM	64QAM	256QAM	1	Full	L	M	H		
Max. Output Power	n77	-	v	v	v	-	v	v	v	v	v	v	v	v	v	v	v	v	v	v	v	v	v	v	v	
	n78	-	v	v	v	-	v	v	v	v	v	v	v	v	v	v	v	v	v	v	v	v	v	v	v	v
Peak-to-Average Ratio	n77	-			v	-										v	v				v	v			v	
26dB and 99% Bandwidth	n77	-	v	v	v	-	v	v	v	v	v	v	v	v	v	v	v	v	v	v			v		v	
Conducted Band Edge	n77	-	v			-			v					v	v	v					v	v	v		v	
Conducted Spurious Emission	n77	-	v			-			v					v	v	v					v		v	v	v	
Frequency Stability	n77	-			v	-											v					v			v	
E.I.R.P	n77	-	v	v	v	-	v	v	v	v	v	v	v	v	v	v	v	v	v	v	v	v	v	v	v	
	n78	-	v	v	v	-	v	v	v	v	v	v	v	v	v	v	v	v	v	v	v	v	v	v	v	
Radiated Spurious Emission	n77	Worst Case																							v	
Note	<ol style="list-style-type: none"> <li>The mark "v" means that this configuration is chosen for testing</li> <li>The mark "-" means that this bandwidth is not supported.</li> <li>The device is investigated from 30MHz to 10 times of fundamental signal for radiated spurious emission test under different RB size/offset and modulations in exploratory test. Subsequently, only the worst case emissions are reported.</li> <li>Frequency Stability : Normal Voltage = 3.91V ; Low Voltage =3.60V. ; High Voltage =4.45V</li> </ol>																									

## 2.2 Connection Diagram of Test System

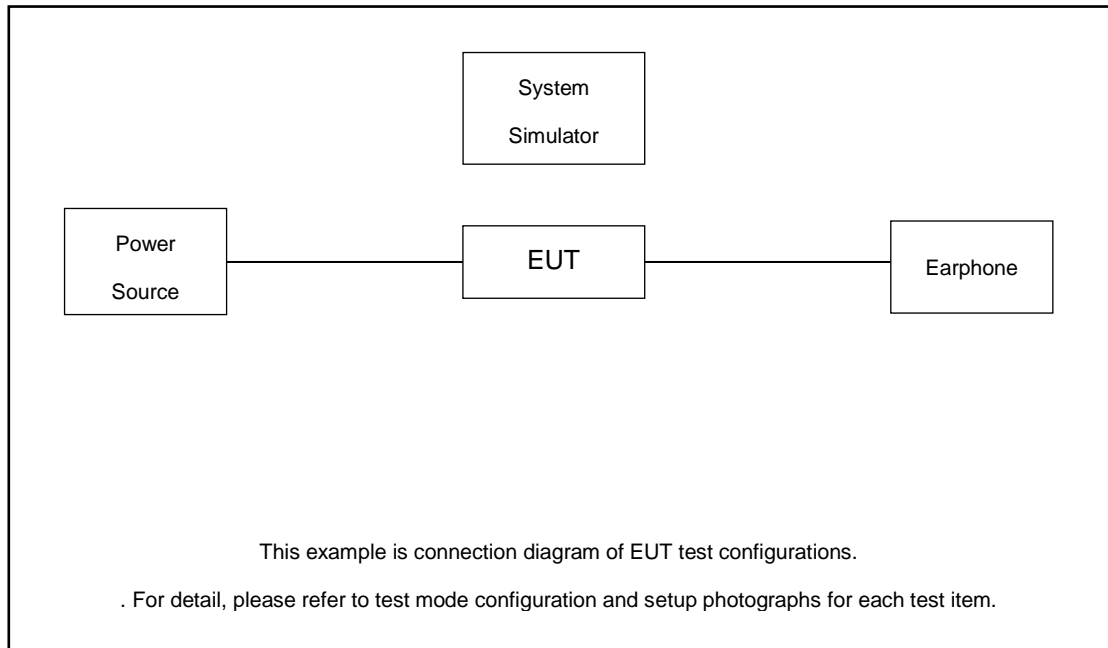

## 2.3 Support Unit used in test configuration and system

Item	Equipment	Trade Name	Model No.	FCC ID	Data Cable	Power Cord
1.	Power Supply	GWINSTEK	PSS-2002	N/A	N/A	Unshielded, 1.8 m
2.	LTE Base Station	Anritsu	MT8820C	N/A	N/A	Unshielded, 1.8 m
3.	NR Base Station	Anritsu	MT8000A	N/A	N/A	Unshielded, 1.8 m

## 2.4 Measurement Results Explanation Example

### For all conducted test items:

The offset level is set in the spectrum analyzer to compensate the RF cable loss between EUT conducted output port and spectrum analyzer. With the offset compensation, the spectrum analyzer reading level is exactly the EUT RF output level.

The spectrum analyzer offset is derived from RF cable loss.

*Offset = RF cable loss.*

Following shows an offset computation example with cable loss 8.90 dB.

Example :

$$\begin{aligned} \text{Offset(dB)} &= \text{RF cable loss(dB)}. \\ &= 8.90 \text{ (dB)} \end{aligned}$$

## 2.5 Frequency List of Low/Middle/High Channels

5G n77/n78 Channel and Frequency List for SCS 30kHz				
BW [MHz]	Channel/Frequency(MHz)	Lowest	Middle	Highest
100	Channel	-	633334	-
	Frequency	-	3500.01	-
90	Channel	633000	633334	633666
	Frequency	3495	3500.01	3504.99
80	Channel	632668	633334	634000
	Frequency	3490.02	3500.01	3510
70	Channel	632334	633334	634332
	Frequency	3485.01	3500.01	3514.98
60	Channel	632000	633334	634666
	Frequency	3480	3500.01	3519.99
50	Channel	631668	633334	635000
	Frequency	3475.02	3500.01	3525
40	Channel	631334	633334	635332
	Frequency	3470.01	3500.01	3529.98
30	Channel	631000	633334	635666
	Frequency	3465	3500.01	3534.99
20	Channel	630668	633334	636000
	Frequency	3460.02	3500.01	3540
15	Channel	630500	633334	636166
	Frequency	3457.5	3500.01	3542.49
10	Channel	630334	633334	636332
	Frequency	3455.01	3500.01	3544.98

### 3 Conducted Test Items

#### 3.1 Measuring Instruments

See list of measuring instruments of this test report.

#### 3.2 Test Setup

##### 3.2.1 Conducted Output Power

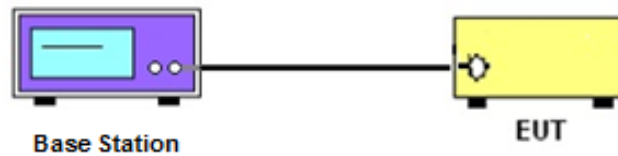

##### 3.2.2 Peak-to-Average Ratio, Occupied / 26dB Bandwidth, Band-Edge and Conducted Spurious Emission

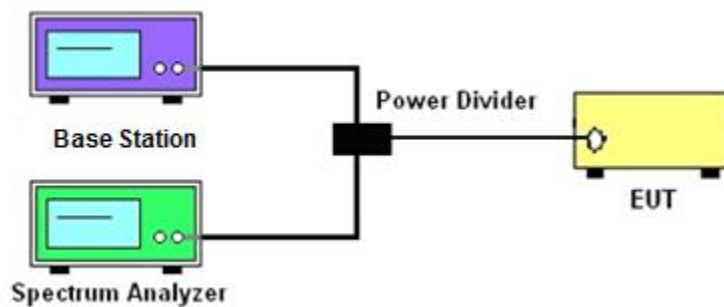

##### 3.2.3 Frequency Stability

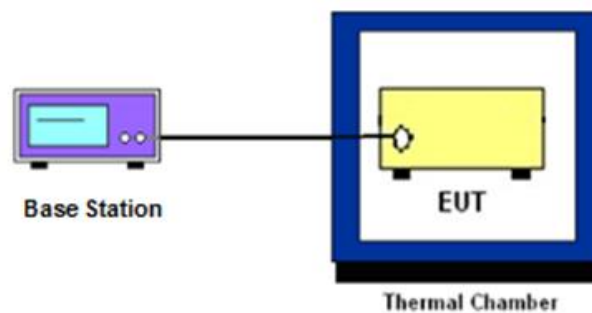

### 3.3 Test Result of Conducted Test

Please refer to Appendix A.

## **3.4 Conducted Output Power Measurement**

### **3.4.1 Description of the Conducted Output Power Measurement**

A base station simulator was used to establish communication with the EUT. Its parameters were set to transmit the maximum power on the EUT. The measured power in the radio frequency on the transmitter output terminals shall be reported.

### **3.4.2 Test Procedures**

1. The testing follows ANSI C63.26 Section 5.2
2. The transmitter output port was connected to the system simulator.
3. Set EUT at maximum power through the system simulator.
4. Select lowest, middle, and highest channels for each band and different modulation.
5. Measure and record the power level from the system simulator.

## **3.5 Peak-to-Average Ratio**

### **3.5.1 Description of the PAR Measurement**

Power Complementary Cumulative Distribution Function (CCDF) curves provide a means for characterizing the power peaks of a digitally modulated signal on a statistical basis. A CCDF curve depicts the probability of the peak signal amplitude exceeding the average power level. Most contemporary measurement instrumentation include the capability to produce CCDF curves for an input signal provided that the instrument's resolution bandwidth can be set wide enough to accommodate the entire input signal bandwidth. In measuring transmissions in this band using an average power technique, the peak-to-average ratio (PAR) of the transmission may not exceed 13 dB.

### **3.5.2 Test Procedures**

1. The testing follows ANSI C63.26 Section 5.2.3.4 (CCDF).
2. The EUT was connected to spectrum and system simulator via a power divider.
3. Set the CCDF (Complementary Cumulative Distribution Function) option in spectrum analyzer.
4. The highest RF powers were measured and recorded the maximum PAPR level associated with a probability of 0.1 %.
5. Record the deviation as Peak to Average Ratio.

## 3.6 EIRP

### 3.6.1 Description of EIRP Limit

#### § 27.50 (k)(3)

Mobile devices are limited to 1Watt (30 dBm) EIRP. Mobile devices operating in these bands must employ a means for limiting power to the minimum necessary for successful communications

### 3.6.2 Test Procedures

1. According to KDB 412172 D01 Power Approach,
2.  $EIRP = P_T + G_T - L_C$ ,  $ERP = EIRP - 2.15$ , where  
 $P_T$  = transmitter output power in dBm  
 $G_T$  = gain of the transmitting antenna in dBi  
 $L_C$  = signal attenuation in the connecting cable between the transmitter and antenna in dB



## 3.7 Occupied Bandwidth

### 3.7.1 Description of Occupied Bandwidth Measurement

The occupied bandwidth is the width of a frequency band such that, below the lower and above the upper frequency limits, the mean powers emitted are each equal to a specified percentage 0.5% of the total mean transmitted power.

The 26 dB emission bandwidth is defined as the frequency range between two points, one above and one below the carrier frequency, at which the spectral density of the emission is attenuated 26 dB below the maximum in-band spectral density of the modulated signal. Spectral density (power per unit bandwidth) is to be measured with a detector of resolution bandwidth equal to approximately 1.0% of the emission bandwidth.

### 3.7.2 Test Procedures

1. The testing follows ANSI C63.26 Section 5.4
2. The EUT was connected to spectrum analyzer and system simulator via a power divider.
3. The spectrum analyzer center frequency is set to the nominal EUT channel center frequency. The span range for the spectrum analyzer shall be between two and five times the anticipated OBW.
4. The nominal resolution bandwidth (RBW) shall be in the range of 1 to 5 % of the anticipated OBW, and the VBW shall be at least 3 times the RBW.
5. Set the detection mode to peak, and the trace mode to max hold.
6. Determine the reference value: Set the EUT to transmit a modulated signal. Allow the trace to stabilize. Set the spectrum analyzer marker to the highest level of the displayed trace.  
(this is the reference value)
7. Determine the “-26 dB down amplitude” as equal to (Reference Value – X).
8. Place two markers, one at the lowest and the other at the highest frequency of the envelope of the spectral display such that each marker is at or slightly below the “-X dB down amplitude” determined in step 6. If a marker is below this “-X dB down amplitude” value it shall be placed as close as possible to this value. The OBW is the positive frequency difference between the two markers.
9. Use the 99 % power bandwidth function of the spectrum analyzer and report the measured bandwidth.

## 3.8 Conducted Band Edge Measurement

### 3.8.1 Description of Conducted Band Edge Measurement

#### § 27.53 (n)(2)

For mobile operations in the 3450-3550 MHz band, the conducted power of any emission outside the licensee's authorized bandwidth shall not exceed  $-13$  dBm/MHz.

Compliance with this paragraph is based on the use of measurement instrumentation employing a resolution bandwidth of 1 megahertz or greater. However, in the 1 megahertz bands immediately outside and adjacent to the licensee's frequency block, a resolution bandwidth of at least one percent of the emission bandwidth of the fundamental emission of the transmitter may be employed, but limited to a maximum of 200 kHz. In the bands between 1 and 5 MHz removed from the licensee's frequency block, the minimum resolution bandwidth for the measurement shall be 500 kHz.

### 3.8.2 Test Procedures

1. The testing follows ANSI C63.26 section 5.7
2. The EUT was connected to spectrum analyzer and system simulator via a power divider.
3. The band edges of low and high channels for the highest RF powers were measured.
4. Set RBW  $\geq$  1% EBW but limited to a maximum of 200 kHz in the 1MHz band immediately outside and adjacent to the band edge.
5. Beyond the 1 MHz and 5 MHz removed from the band edge, set RBW  $\geq$  500KHz.
6. Beyond the 5 MHz removed from the band edge, set RBW = 1MHz.
7. Set spectrum analyzer with RMS detector.
8. The RF fundamental frequency should be excluded against the limit line in the operating frequency band.
9. Checked that all the results comply with the emission limit line.

## 3.9 Conducted Spurious Emission Measurement

### 3.9.1 Description of Conducted Spurious Emission Measurement

The power of any emission outside of the authorized operating frequency ranges shall not exceed -13 dBm/MHz.

It is measured by means of a calibrated spectrum analyzer and scanned from 9 kHz up to a frequency including its 10<sup>th</sup> harmonic.

### 3.9.2 Test Procedures

1. The testing follows ANSI C63.26 section 5.7
2. The EUT was connected to spectrum analyzer and system simulator via a power divider.
3. The RF output of EUT was connected to the spectrum analyzer by RF cable and attenuator. The path loss was compensated to the results for each measurement.
4. The middle channel for the highest RF power within the transmitting frequency was measured.
5. The conducted spurious emission for the whole frequency range was taken.
6. Make the measurement with the spectrum analyzer's RBW = 1MHz, VBW = 3MHz.
7. Set spectrum analyzer with RMS detector.
8. Taking the record of maximum spurious emission.
9. The RF fundamental frequency should be excluded against the limit line in the operating frequency band.
10. Checked that all the results comply with the emission limit line.

## 3.10 Frequency Stability Measurement

### 3.10.1 Description of Frequency Stability Measurement

The frequency stability shall be measured by variation of ambient temperature and variation of primary supply voltage to ensure that the fundamental emission stays within the authorized frequency block.

### 3.10.2 Test Procedures for Temperature Variation

1. The testing follows ANSI C63.26 section 5.6.4
2. The EUT was set up in the thermal chamber and connected with the system simulator.
3. With power OFF, the temperature was decreased to  $-30^{\circ}\text{C}$  and the EUT was stabilized before testing. Power was applied and the maximum change in frequency was recorded within one minute.
4. With power OFF, the temperature was raised in  $10^{\circ}\text{C}$  step up to  $50^{\circ}\text{C}$ . The EUT was stabilized at each step for at least half an hour. Power was applied and the maximum frequency change was recorded within one minute.

### 3.10.3 Test Procedures for Voltage Variation

1. The testing follows ANSI C63.26 section 5.6.5.
2. The EUT was placed in a temperature chamber at  $20\pm 5^{\circ}\text{C}$  and connected with the system simulator.
3. The power supply voltage to the EUT was varied from 85% to 115% of the nominal value for other than hand carried battery equipment.
4. For hand carried, battery powered equipment, reduce the primary ac or dc supply voltage to the battery operating end point, which shall be specified by the manufacturer.
5. The variation in frequency was measured for the worst case.

## 4 Radiated Test Items

### 4.1 Measuring Instruments

See list of measuring instruments of this test report.

### 4.2 Test Setup

#### 4.2.1 For radiated test below 30MHz

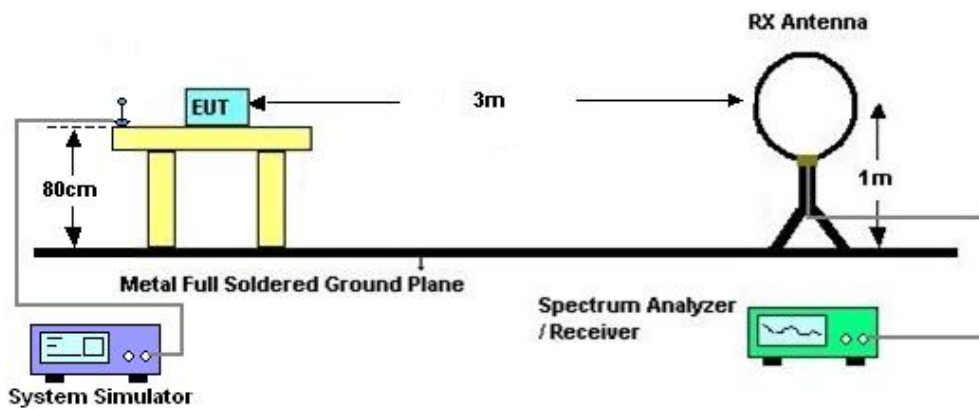

#### 4.2.2 For radiated test from 30MHz to 1GHz

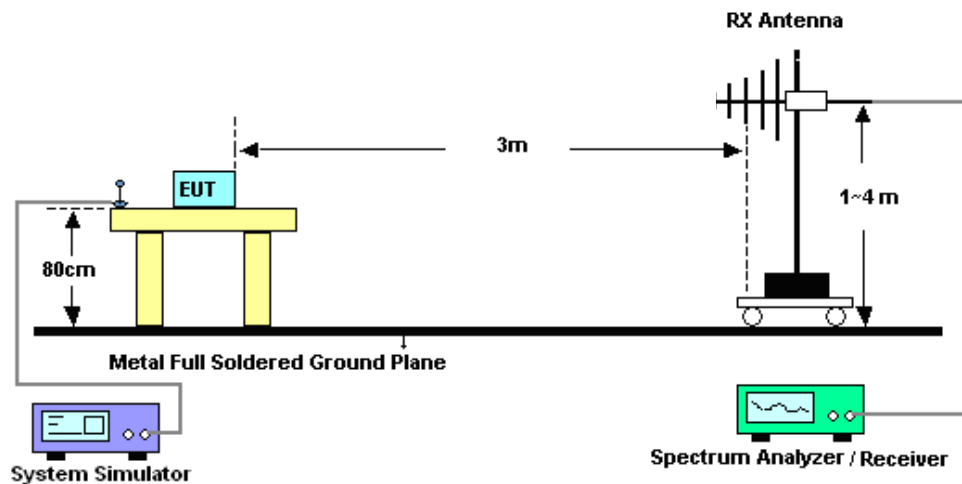

### 4.2.3 For radiated test above 1GHz

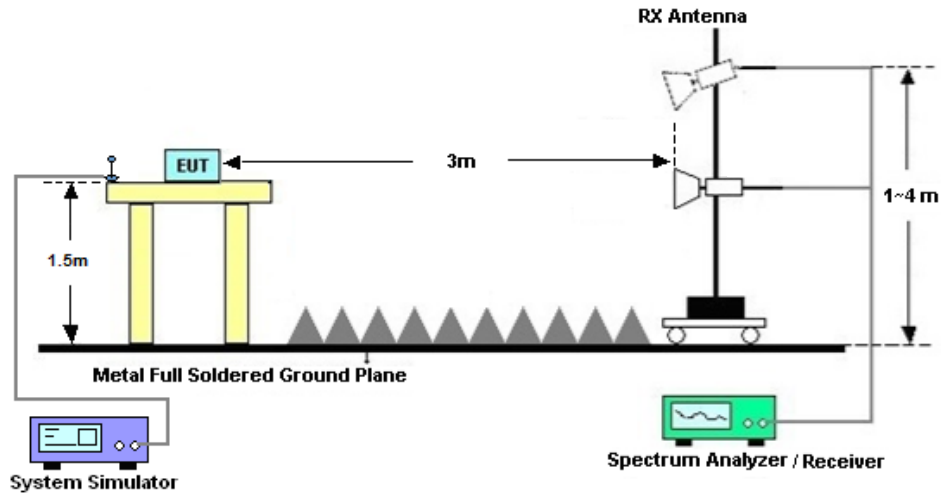

### 4.3 Test Result of Radiated Test

The low frequency, which started from 9 kHz to 30MHz, was pre-scanned and the result which was 20dB lower than the limit line was not reported.

Please refer to Appendix B.

## 4.4 Radiated Spurious Emission Measurement

### 4.4.1 Description of Radiated Spurious Emission

The radiated spurious emission was measured by substitution method according to ANSI/TIA-603-E. The power of any emission outside of the authorized operating frequency ranges shall not exceed -13 dBm/MHz.

The spectrum is scanned from 30 MHz up to a frequency including its 10th harmonic.

### 4.4.2 Test Procedures

1. The testing follows ANSI C63.26 Section 5.5
2. The EUT was placed on a turntable with 0.8 meter height for frequency below 1GHz and 1.5 meter height for frequency above 1GHz respectively above ground.
3. The EUT was set 3 meters from the receiving antenna mounted on the antenna tower.
4. The table was rotated 360 degrees to determine the position of the highest spurious emission.
5. The height of the receiving antenna is varied between 1m to 4m to search the maximum spurious emission for both horizontal and vertical polarizations.
6. During the measurement, the system simulator parameters were set to force the EUT transmitting at maximum output power.
7. Make the measurement with the spectrum analyzer's RBW = 1MHz, VBW = 3MHz, taking the record of maximum spurious emission.
8. A horn antenna was substituted in place of the EUT and was driven by a signal generator.
9. Tune the output power of signal generator to the same emission level with EUT maximum spurious emission.  
$$\text{EIRP (dBm)} = \text{S.G. Power} - \text{Tx Cable Loss} + \text{Tx Antenna Gain}$$
$$\text{ERP (dBm)} = \text{EIRP} - 2.15$$
10. The RF fundamental frequency should be excluded against the limit line in the operating frequency band.



## 5 List of Measuring Equipment

Instrument	Manufacturer	Model No.	Serial No.	Characteristics	Calibration Date	Test Date	Due Date	Remark
Spectrum Analyzer	R&S	FSV40	101078	10Hz~40GHz	Apr. 06, 2023	Sep. 28, 2023	Apr. 05, 2024	Conducted (TH01-SZ)
DC Power Supply	TTI	PL330P	290070	Max 32V , 3A	Oct. 17, 2022	Sep. 28, 2023	Oct. 16, 2023	Conducted (TH01-SZ)
Power Divider	TOJOIN	PS-2SM-04 265	60.06.020.007 7	0.4GHz~26.5GHz	Dec. 25, 2022	Sep. 28, 2023	Dec. 24, 2023	Conducted (TH01-SZ)
Thermal Chamber	Ten Billion Hongzhangroup	LP-150U	H2014081803	-40~+150°C	Jul. 05, 2023	Sep. 28, 2023	Jul. 04, 2024	Conducted (TH01-SZ)
EMI Test Receiver&SA	Agilent	N9038A	MY52260185	20Hz~26.5GHz	Dec. 26, 2022	Oct. 10, 2023	Dec. 25, 2023	Radiation (03CH01-SZ)
Loop Antenna	R&S	HFH2-Z2	100354	9kHz~30MHz	Jul. 28, 2022	Oct. 10, 2023	Jul. 27, 2024	Radiation (03CH01-SZ)
HF Amplifier	KEYSIGHT	83017A	MY53270105	0.5GHz~26.5Ghz	Oct. 19, 2022	Oct. 10, 2023	Oct. 18, 2023	Radiation (03CH01-SZ)
Bilog Antenna	TeseQ	CBL6112D	35407	30MHz-2GHz	Sep. 27, 2023	Oct. 10, 2023	Sep. 26, 2024	Radiation (03CH01-SZ)
Double Ridge Horn Antenna	ETS-Lindgren	3117	00119436	1GHz~18GHz	Jul. 08, 2023	Oct. 10, 2023	Jul. 07, 2024	Radiation (03CH01-SZ)
SHF-EHF Horn	com-power	AH-840	101071	18Ghz-40GHz	Apr. 08,2023	Oct. 10, 2023	Apr. 07,2024	Radiation (03CH01-SZ)
LF Amplifier	Burgeon	BPA-530	102209	0.01~3000Mhz	Apr. 04, 2023	Oct. 10, 2023	Apr. 03, 2024	Radiation (03CH01-SZ)
HF Amplifier	MITEQ	AMF-7D-00 101800-30-1 0P-R	1943528	1GHz~18GHz	Oct. 19, 2022	Oct. 10, 2023	Oct. 18, 2023	Radiation (03CH01-SZ)
HF Amplifier	MITEQ	TTA1840-35 -HG	1871923	18GHz~40GHz	Jul. 07, 2023	Oct. 10, 2023	Jul. 06, 2024	Radiation (03CH01-SZ)
AC Power Source	Chroma	61601	616010001985	N/A	Nov. 10, 2022	Oct. 10, 2023	Nov. 09, 2023	Radiation (03CH01-SZ)
Turn Table	EM	EM1000	N/A	0~360 degree	NCR	Oct. 10, 2023	NCR	Radiation (03CH01-SZ)
Antenna Mast	EM	EM1000	N/A	1 m~4 m	NCR	Oct. 10, 2023	NCR	Radiation (03CH01-SZ)

NCR: No Calibration Required



## 6 Measurement Uncertainty

The measurement uncertainties shown below were calculated in accordance with the requirements of ANSI 63.26-2015. All the measurement uncertainty value were shown with a coverage K=2 to indicate 95% level of confidence. The measurement data show herein meets or exceeds the CISPR measurement uncertainty values specified in CISPR 16-4-2 and can be compared directly to specified limit to determine compliance.

### Uncertainty of Conducted Measurement

Test Item	Uncertainty
Conducted Power	±1.34 dB
Conducted Emissions	±1.34 dB
Occupied Channel Bandwidth	±0.13 %

### Uncertainty of Radiated Emission Measurement (30 MHz ~ 1000 MHz)

Measuring Uncertainty for a Level of Confidence of 95% (U = 2Uc(y))	2.48dB
---	--------

### Uncertainty of Radiated Emission Measurement (1 GHz ~ 18 GHz)

Measuring Uncertainty for a Level of Confidence of 95% (U = 2Uc(y))	3.53dB
---	--------

### Uncertainty of Radiated Emission Measurement (18 GHz ~ 40 GHz)

Measuring Uncertainty for a Level of Confidence of 95% (U = 2Uc(y))	4.02dB
---	--------

----- THE END -----



## Appendix A. Test Results of Conducted Test

Test Engineer :	Jung Kuo	Temperature :	22~23°C
		Relative Humidity :	40~42%

# FR1 N77(ANT5)

## Transmitter Conducted Output Power And EIRP, ( $G_T - L_C$ )=-1.5dB

NR Band	SCS (kHz)	Bandwidth (MHz)	Arfcn	Freq (MHz)	Modulation	RB	Conducted Power(dBm)	EIRP (dBm)	EIRP (W)
77	30	10	630334	3455.01	DFT-s-OFDM QPSK	1@1	25.85	24.35	0.2723
77	30	10	630334	3455.01	DFT-s-OFDM 16 QAM	1@1	24.98	23.48	0.2228
77	30	10	633334	3500.01	DFT-s-OFDM QPSK	1@1	25.72	24.22	0.2642
77	30	10	633334	3500.01	DFT-s-OFDM 16 QAM	1@1	24.7	23.2	0.2089
77	30	10	636332	3544.98	DFT-s-OFDM QPSK	1@1	25.84	24.34	0.2716
77	30	10	636332	3544.98	DFT-s-OFDM 16 QAM	1@1	24.63	23.13	0.2056
77	30	15	630500	3457.5	DFT-s-OFDM QPSK	1@1	25.84	24.34	0.2716
77	30	15	630500	3457.5	DFT-s-OFDM 16 QAM	1@1	24.67	23.17	0.2075
77	30	15	633334	3500.01	DFT-s-OFDM QPSK	1@1	25.7	24.2	0.2630
77	30	15	633334	3500.01	DFT-s-OFDM 16 QAM	1@1	24.69	23.19	0.2084
77	30	15	636166	3542.49	DFT-s-OFDM QPSK	1@1	25.82	24.32	0.2704
77	30	15	636166	3542.49	DFT-s-OFDM 16 QAM	1@1	24.6	23.1	0.2042
77	30	20	630668	3460.02	DFT-s-OFDM QPSK	1@1	25.8	24.3	0.2692
77	30	20	630668	3460.02	DFT-s-OFDM 16 QAM	1@1	24.6	23.1	0.2042
77	30	20	633334	3500.01	DFT-s-OFDM QPSK	1@1	25.82	24.32	0.2704
77	30	20	633334	3500.01	DFT-s-OFDM 16 QAM	1@1	24.61	23.11	0.2046
77	30	20	636000	3540	DFT-s-OFDM QPSK	1@1	25.78	24.28	0.2679
77	30	20	636000	3540	DFT-s-OFDM 16 QAM	1@1	24.56	23.06	0.2023
77	30	30	631000	3465	DFT-s-OFDM QPSK	1@1	25.68	24.18	0.2618
77	30	30	631000	3465	DFT-s-OFDM 16 QAM	1@1	24.5	23	0.1995
77	30	30	633334	3500.01	DFT-s-OFDM QPSK	1@1	25.72	24.22	0.2642
77	30	30	633334	3500.01	DFT-s-OFDM 16 QAM	1@1	24.54	23.04	0.2014
77	30	30	635666	3534.99	DFT-s-OFDM QPSK	1@1	25.7	24.2	0.2630
77	30	30	635666	3534.99	DFT-s-OFDM 16 QAM	1@1	24.46	22.96	0.1977
77	30	40	631334	3470.01	DFT-s-OFDM QPSK	1@1	25.43	23.93	0.2472
77	30	40	631334	3470.01	DFT-s-OFDM 16 QAM	1@1	24.29	22.79	0.1901
77	30	40	633334	3500.01	DFT-s-OFDM QPSK	1@1	25.44	23.94	0.2477
77	30	40	633334	3500.01	DFT-s-OFDM 16 QAM	1@1	24.23	22.73	0.1875
77	30	40	635332	3529.98	DFT-s-OFDM QPSK	1@1	25.42	23.92	0.2466

77	30	40	635332	3529.98	DFT-s-OFDM 16 QAM	1@1	24.24	22.74	0.1879
77	30	50	631668	3475.02	DFT-s-OFDM QPSK	1@1	25.74	24.24	0.2655
77	30	50	631668	3475.02	DFT-s-OFDM 16 QAM	1@1	24.53	23.03	0.2009
77	30	50	633334	3500.01	DFT-s-OFDM QPSK	1@1	25.76	24.26	0.2667
77	30	50	633334	3500.01	DFT-s-OFDM 16 QAM	1@1	24.56	23.06	0.2023
77	30	50	635000	3525	DFT-s-OFDM QPSK	1@1	25.75	24.25	0.2661
77	30	50	635000	3525	DFT-s-OFDM 16 QAM	1@1	24.57	23.07	0.2028
77	30	60	632000	3480	DFT-s-OFDM QPSK	1@1	25.66	24.16	0.2606
77	30	60	632000	3480	DFT-s-OFDM 16 QAM	1@1	24.51	23.01	0.2000
77	30	60	633334	3500.01	DFT-s-OFDM QPSK	1@1	25.64	24.14	0.2594
77	30	60	633334	3500.01	DFT-s-OFDM 16 QAM	1@1	24.84	23.34	0.2158
77	30	60	634666	3519.99	DFT-s-OFDM QPSK	1@1	25.65	24.15	0.2600
77	30	60	634666	3519.99	DFT-s-OFDM 16 QAM	1@1	24.82	23.32	0.2148
77	30	70	632334	3485.01	DFT-s-OFDM QPSK	1@1	25.51	24.01	0.2518
77	30	70	632334	3485.01	DFT-s-OFDM 16 QAM	1@1	24.72	23.22	0.2099
77	30	70	633334	3500.01	DFT-s-OFDM QPSK	1@1	25.54	24.04	0.2535
77	30	70	633334	3500.01	DFT-s-OFDM 16 QAM	1@1	24.73	23.23	0.2104
77	30	70	634332	3514.98	DFT-s-OFDM QPSK	1@1	25.53	24.03	0.2529
77	30	70	634332	3514.98	DFT-s-OFDM 16 QAM	1@1	24.61	23.11	0.2046
77	30	80	632668	3490.02	DFT-s-OFDM QPSK	1@1	25.4	23.9	0.2455
77	30	80	632668	3490.02	DFT-s-OFDM 16 QAM	1@1	24.22	22.72	0.1871
77	30	80	633334	3500.01	DFT-s-OFDM QPSK	1@1	25.4	23.9	0.2455
77	30	80	633334	3500.01	DFT-s-OFDM 16 QAM	1@1	24.34	22.84	0.1923
77	30	80	634000	3510	DFT-s-OFDM QPSK	1@1	25.42	23.92	0.2466
77	30	80	634000	3510	DFT-s-OFDM 16 QAM	1@1	24.24	22.74	0.1879
77	30	90	633000	3495	DFT-s-OFDM QPSK	1@1	25.24	23.74	0.2366
77	30	90	633000	3495	DFT-s-OFDM 16 QAM	1@1	24.12	22.62	0.1828
77	30	90	633334	3500.01	DFT-s-OFDM QPSK	1@1	25.23	23.73	0.2360
77	30	90	633334	3500.01	DFT-s-OFDM 16 QAM	1@1	24.03	22.53	0.1791
77	30	90	633666	3504.99	DFT-s-OFDM QPSK	1@1	25.3	23.8	0.2399
77	30	90	633666	3504.99	DFT-s-OFDM 16 QAM	1@1	24.1	22.6	0.1820
77	30	100	633334	3500.01	DFT-s-OFDM PI/2 BPSK	135@67	25.86	24.36	0.2729
77	30	100	633334	3500.01	DFT-s-OFDM PI/2 BPSK	1@1	25.1	23.6	0.2291
77	30	100	633334	3500.01	DFT-s-OFDM PI/2 BPSK	1@271	24.73	23.23	0.2104
77	30	100	633334	3500.01	DFT-s-OFDM QPSK	135@67	25.89	24.39	0.2748

77	30	100	633334	3500.01	DFT-s-OFDM QPSK	1@1	25.11	23.61	0.2296
77	30	100	633334	3500.01	DFT-s-OFDM QPSK	1@271	24.74	23.24	0.2109
77	30	100	633334	3500.01	DFT-s-OFDM 16 QAM	135@67	24.87	23.37	0.2173
77	30	100	633334	3500.01	DFT-s-OFDM 16 QAM	1@1	23.95	22.45	0.1758
77	30	100	633334	3500.01	DFT-s-OFDM 16 QAM	1@271	23.54	22.04	0.1600
77	30	100	633334	3500.01	DFT-s-OFDM 64 QAM	135@67	23.41	21.91	0.1552
77	30	100	633334	3500.01	DFT-s-OFDM 64 QAM	1@1	22.54	21.04	0.1271
77	30	100	633334	3500.01	DFT-s-OFDM 64 QAM	1@271	22.18	20.68	0.1169
77	30	100	633334	3500.01	DFT-s-OFDM 256 QAM	135@67	21.4	19.9	0.0977
77	30	100	633334	3500.01	DFT-s-OFDM 256 QAM	1@1	20.54	19.04	0.0802
77	30	100	633334	3500.01	DFT-s-OFDM 256 QAM	1@271	20.17	18.67	0.0736
77	30	100	633334	3500.01	CP-OFDM QPSK	137@68	24.34	22.84	0.1923
77	30	100	633334	3500.01	CP-OFDM QPSK	1@1	23.62	22.12	0.1629
77	30	100	633334	3500.01	CP-OFDM QPSK	1@271	23.27	21.77	0.1503

## Frequency Stability

NR Band	SCS (kHz)	Bandwidth (MHz)	Arfcn	Freq (MHz)	Modulation	RB	Deviation (ppm)	Verdict	Environment
77	30	20	633334	3500.01	DFT-s-OFDM QPSK	50@0	0.0042	PASS	NV
77	30	20	633334	3500.01	DFT-s-OFDM QPSK	50@0	0.0032	PASS	LV
77	30	20	633334	3500.01	DFT-s-OFDM QPSK	50@0	0.0049	PASS	HV
77	30	20	633334	3500.01	DFT-s-OFDM QPSK	50@0	0.0035	PASS	-30°C
77	30	20	633334	3500.01	DFT-s-OFDM QPSK	50@0	0.0066	PASS	-20°C
77	30	20	633334	3500.01	DFT-s-OFDM QPSK	50@0	0.0022	PASS	-10°C
77	30	20	633334	3500.01	DFT-s-OFDM QPSK	50@0	0.0066	PASS	0°C
77	30	20	633334	3500.01	DFT-s-OFDM QPSK	50@0	0.0039	PASS	10°C
77	30	20	633334	3500.01	DFT-s-OFDM QPSK	50@0	0.0042	PASS	20°C
77	30	20	633334	3500.01	DFT-s-OFDM QPSK	50@0	0.0036	PASS	30°C
77	30	20	633334	3500.01	DFT-s-OFDM QPSK	50@0	0.0025	PASS	40°C
77	30	20	633334	3500.01	DFT-s-OFDM QPSK	50@0	0.0021	PASS	50°C

## Peak to Average Ratio

NR Band	SCS (kHz)	Bandwidth (MHz)	Arfcn	Freq (MHz)	Modulation	RB	Result (dB)	Limit (dB)	Verdict
77	30	20	633334	3500.01	DFT-s-OFDM PI/2 BPSK	50@0	7.11	13	PASS
77	30	20	633334	3500.01	DFT-s-OFDM PI/2 BPSK	1@0	8.07	13	PASS
77	30	20	633334	3500.01	DFT-s-OFDM QPSK	50@0	8.34	13	PASS
77	30	20	633334	3500.01	DFT-s-OFDM QPSK	1@0	9.07	13	PASS

N77(20M)\_DFT-s-OFDM\_PI\_2-BPSK\_Outer\_Full\_Mid\_CH

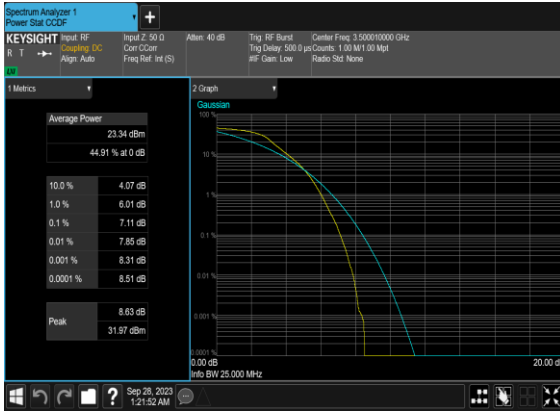

N77(20M)\_DFT-s-OFDM\_PI\_2-BPSK\_Edge\_1RB\_Left\_Mid\_CH

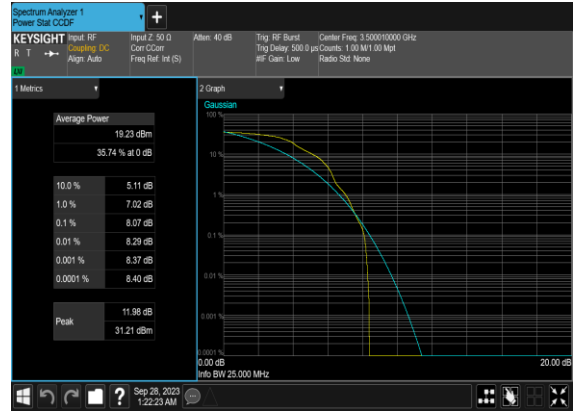

N77(20M)\_DFT-s-OFDM\_QPSK\_Outer\_Full\_Mid\_CH



N77(20M)\_DFT-s-OFDM\_QPSK\_Edge\_1RB\_Left\_Mid\_CH

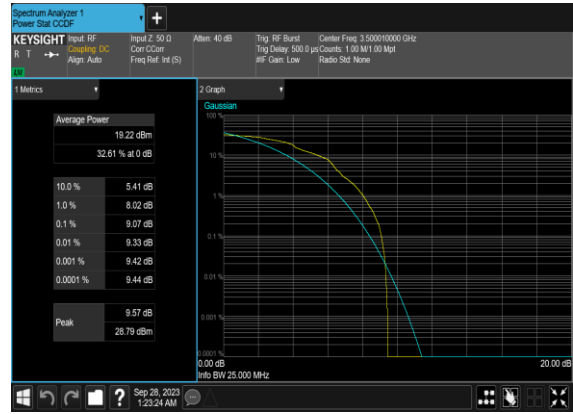



## Occupied Bandwidth

NR Band	SCS (kHz)	Bandwidth (MHz)	Arfcn	Freq (MHz)	Modulation	RB	OBW (MHz)	26dB BW (MHz)
77	30	10	633334	3500.01	CP-OFDM QPSK	24@0	8.5577	9.309
77	30	10	633334	3500.01	CP-OFDM 16 QAM	24@0	8.6027	9.21
77	30	10	633334	3500.01	CP-OFDM 64 QAM	24@0	8.584	9.249
77	30	10	633334	3500.01	CP-OFDM 256 QAM	24@0	8.5815	9.361
77	30	15	633334	3500.01	CP-OFDM QPSK	38@0	13.516	14.43
77	30	15	633334	3500.01	CP-OFDM 16 QAM	38@0	13.545	14.36
77	30	15	633334	3500.01	CP-OFDM 64 QAM	38@0	13.565	14.13
77	30	15	633334	3500.01	CP-OFDM 256 QAM	38@0	13.56	14.31
77	30	20	633334	3500.01	CP-OFDM QPSK	51@0	18.177	19.13
77	30	20	633334	3500.01	CP-OFDM 16 QAM	51@0	18.134	19.16
77	30	20	633334	3500.01	CP-OFDM 64 QAM	51@0	18.2	19.26
77	30	20	633334	3500.01	CP-OFDM 256 QAM	51@0	18.139	18.94
77	30	30	633334	3500.01	CP-OFDM QPSK	78@0	27.816	29.03
77	30	30	633334	3500.01	CP-OFDM 16 QAM	78@0	27.707	28.99
77	30	30	633334	3500.01	CP-OFDM 64 QAM	78@0	27.766	28.76
77	30	30	633334	3500.01	CP-OFDM 256 QAM	78@0	27.707	28.9
77	30	40	633334	3500.01	CP-OFDM QPSK	106@0	37.78	39.38
77	30	40	633334	3500.01	CP-OFDM 16 QAM	106@0	37.708	39.1
77	30	40	633334	3500.01	CP-OFDM 64 QAM	106@0	37.823	39.26
77	30	40	633334	3500.01	CP-OFDM 256 QAM	106@0	37.883	39.16
77	30	50	633334	3500.01	CP-OFDM QPSK	133@0	47.471	49.03
77	30	50	633334	3500.01	CP-OFDM 16 QAM	133@0	47.331	49.17
77	30	50	633334	3500.01	CP-OFDM 64 QAM	133@0	47.411	49.01
77	30	50	633334	3500.01	CP-OFDM 256 QAM	133@0	47.502	49.41
77	30	60	633334	3500.01	CP-OFDM QPSK	162@0	57.785	59.7

77	30	60	633334	3500.01	CP-OFDM 16 QAM	162@0	57.819	59.8
77	30	60	633334	3500.01	CP-OFDM 64 QAM	162@0	57.617	59.7
77	30	60	633334	3500.01	CP-OFDM 256 QAM	162@0	57.83	59.75
77	30	70	633334	3500.01	CP-OFDM QPSK	189@0	67.474	70.01
77	30	70	633334	3500.01	CP-OFDM 16 QAM	189@0	67.521	69.56
77	30	70	633334	3500.01	CP-OFDM 64 QAM	189@0	67.462	69.51
77	30	70	633334	3500.01	CP-OFDM 256 QAM	189@0	67.28	69.78
77	30	80	633334	3500.01	CP-OFDM QPSK	217@0	77.39	79.96
77	30	80	633334	3500.01	CP-OFDM 16 QAM	217@0	77.354	79.89
77	30	80	633334	3500.01	CP-OFDM 64 QAM	217@0	77.283	79.88
77	30	80	633334	3500.01	CP-OFDM 256 QAM	217@0	77.376	79.91
77	30	90	633334	3500.01	CP-OFDM QPSK	245@0	87.273	90.21
77	30	90	633334	3500.01	CP-OFDM 16 QAM	245@0	87.074	90.37
77	30	90	633334	3500.01	CP-OFDM 64 QAM	245@0	87.082	90.24
77	30	90	633334	3500.01	CP-OFDM 256 QAM	245@0	87.326	90.26
77	30	100	633334	3500.01	CP-OFDM QPSK	273@0	98.288	199.3
77	30	100	633334	3500.01	CP-OFDM 16 QAM	273@0	97.122	100.4
77	30	100	633334	3500.01	CP-OFDM 64 QAM	273@0	97.626	100.5
77	30	100	633334	3500.01	CP-OFDM 256 QAM	273@0	97.22	100.4

### N77(10M)\_CP-OFDM\_QPSK\_Outer\_Full\_Mid\_CH



### N77(10M)\_CP-OFDM\_16 QAM\_Outer\_Full\_Mid\_CH

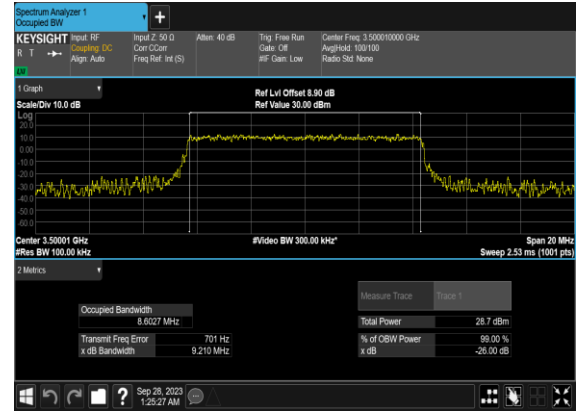

### N77(10M)\_CP-OFDM\_64 QAM\_Outer\_Full\_Mid\_CH



### N77(10M)\_CP-OFDM\_256 QAM\_Outer\_Full\_Mid\_CH

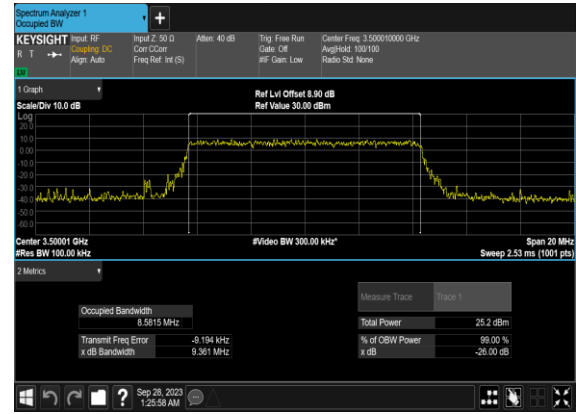

### N77(15M)\_CP-OFDM\_QPSK\_Outer\_Full\_Mid\_CH

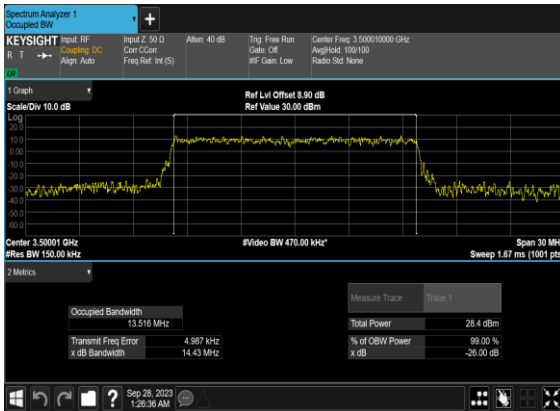

### N77(15M)\_CP-OFDM\_16 QAM\_Outer\_Full\_Mid\_CH

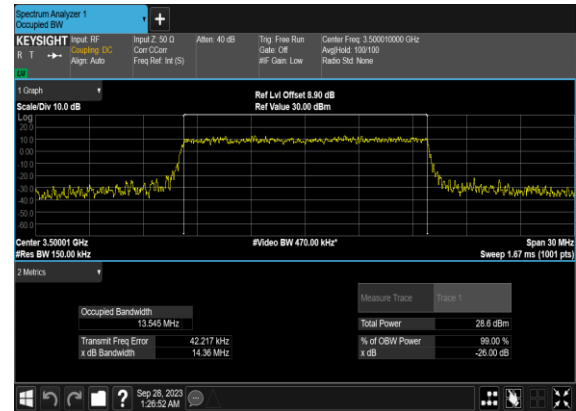

### N77(15M)\_CP-OFDM\_64 QAM\_Outer\_Full\_Mid\_CH

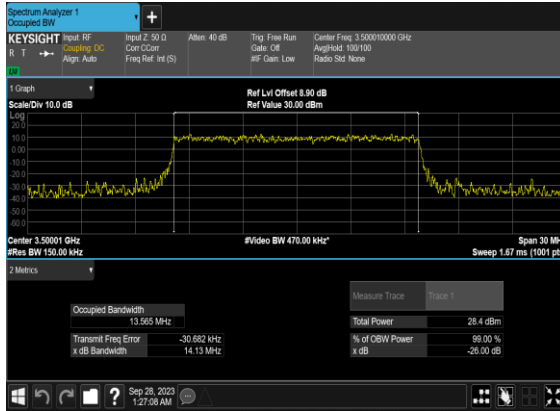

### N77(15M)\_CP-OFDM\_256 QAM\_Outer\_Full\_Mid\_CH

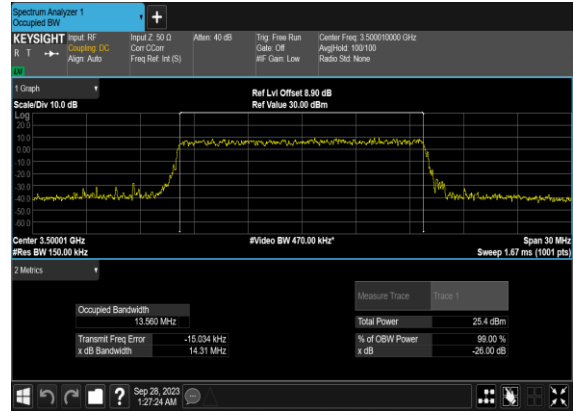

### N77(20M)\_CP- OFDM\_QPSK\_Outer\_Full\_Mid\_CH

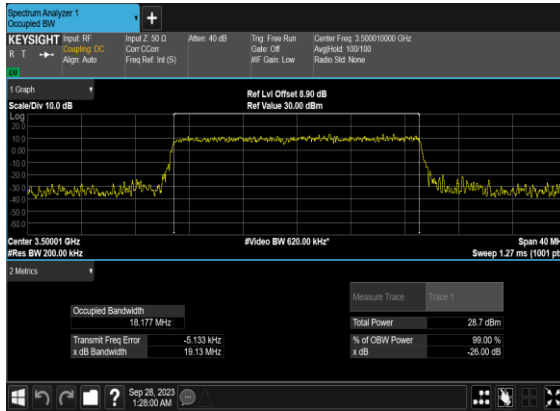

### N77(20M)\_CP-OFDM\_16 QAM\_Outer\_Full\_Mid\_CH

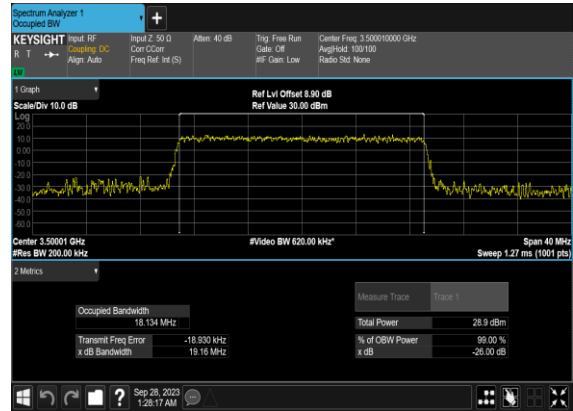

### N77(20M)\_CP-OFDM\_64 QAM\_Outer\_Full\_Mid\_CH

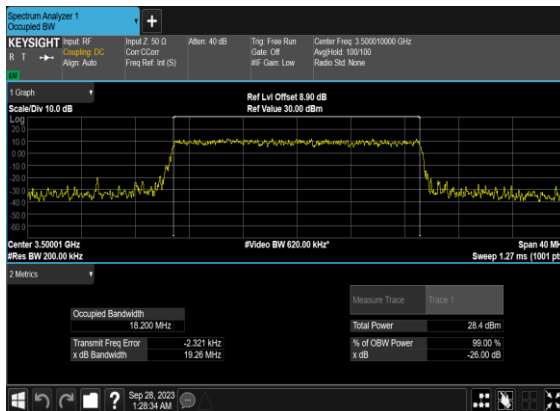

### N77(20M)\_CP-OFDM\_256 QAM\_Outer\_Full\_Mid\_CH

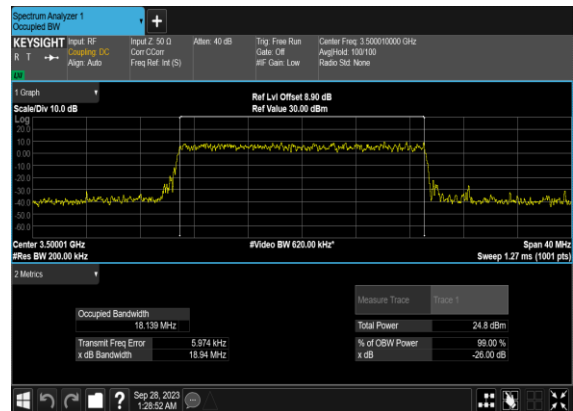

### N77(30M)\_CP-OFDM\_QPSK\_Outer\_Full\_Mid\_CH

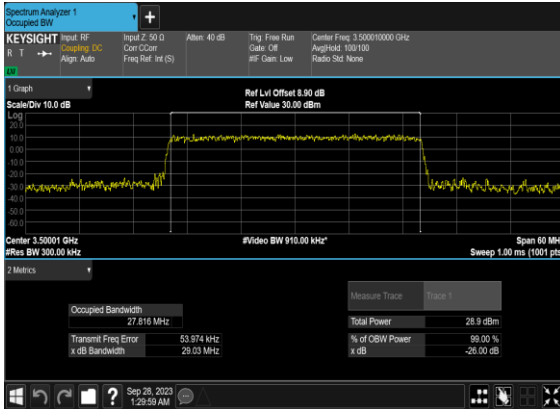

### N77(30M)\_CP-OFDM\_16QAM\_Outer\_Full\_Mid\_CH

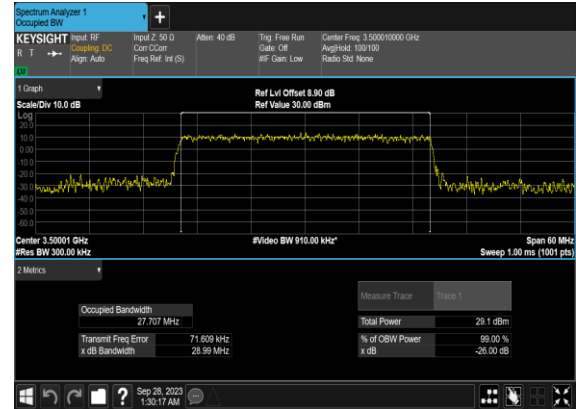

### N77(30M)\_CP-OFDM\_64QAM\_Outer\_Full\_Mid\_CH



### N77(30M)\_CP-OFDM\_256QAM\_Outer\_Full\_Mid\_CH

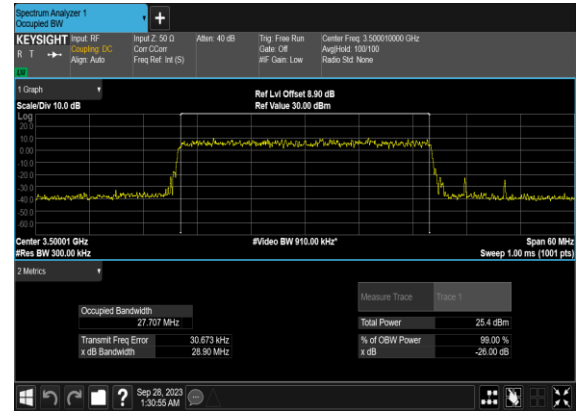

### N77(40M)\_CP-OFDM\_QPSK\_Outer\_Full\_Mid\_CH

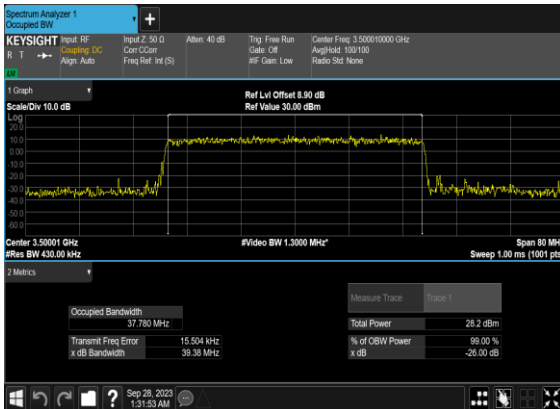

### N77(40M)\_CP-OFDM\_16QAM\_Outer\_Full\_Mid\_CH

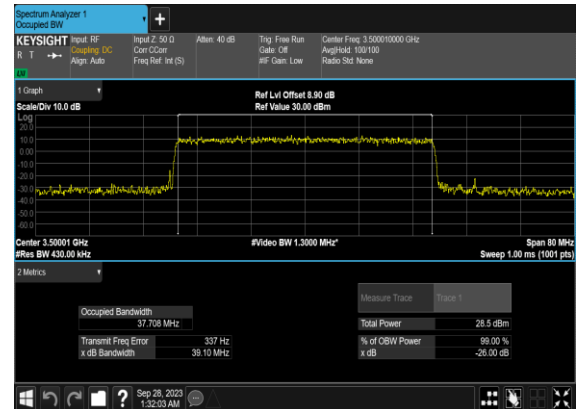

### N77(40M)\_CP-OFDM\_64 QAM\_Outer\_Full\_Mid\_CH



### N77(40M)\_CP-OFDM\_256 QAM\_Outer\_Full\_Mid\_CH

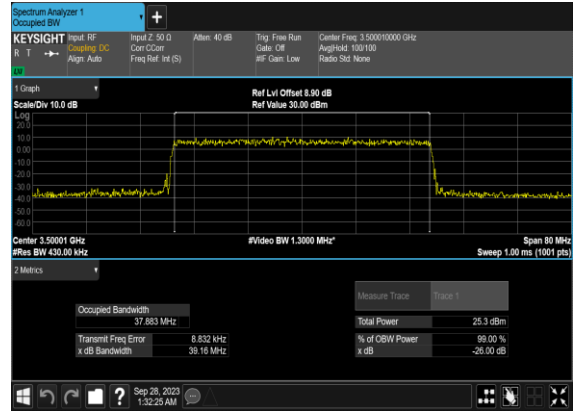

### N77(50M)\_CP- OFDM\_QPSK\_Outer\_Full\_Mid\_CH

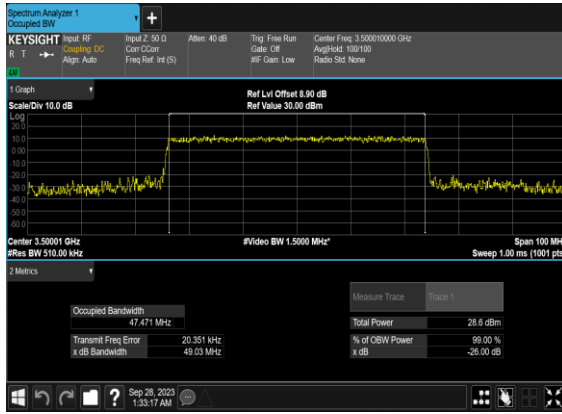

### N77(50M)\_CP-OFDM\_16 QAM\_Outer\_Full\_Mid\_CH

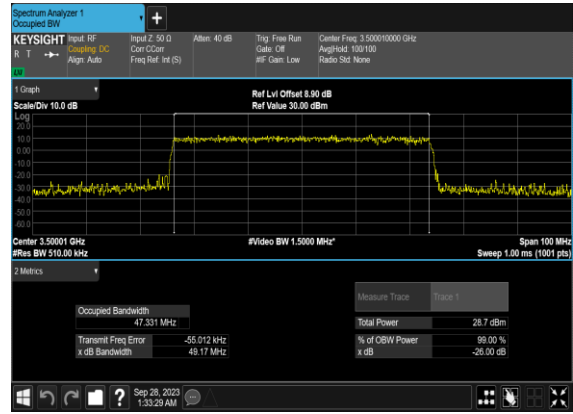

### N77(50M)\_CP-OFDM\_64 QAM\_Outer\_Full\_Mid\_CH

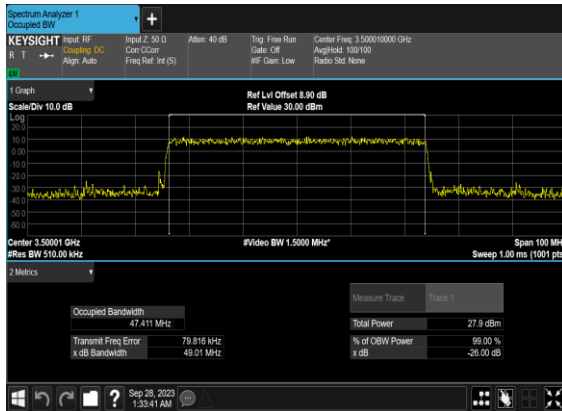

### N77(50M)\_CP-OFDM\_256 QAM\_Outer\_Full\_Mid\_CH

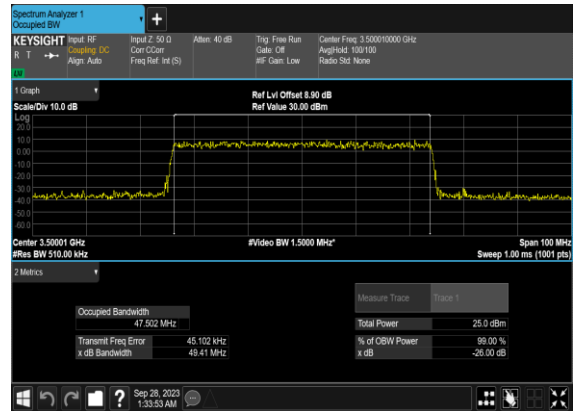

### N77(60M)\_CP-OFDM\_QPSK\_Outer\_Full\_Mid\_CH

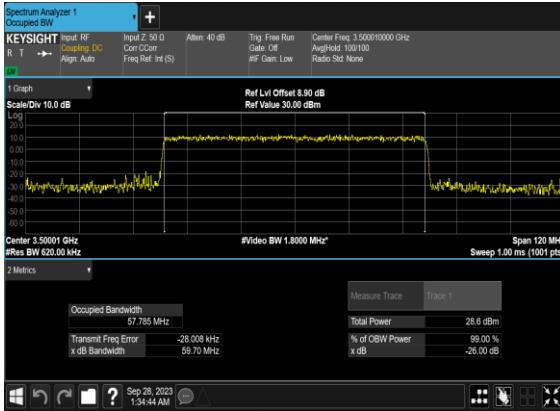

### N77(60M)\_CP-OFDM\_16QAM\_Outer\_Full\_Mid\_CH

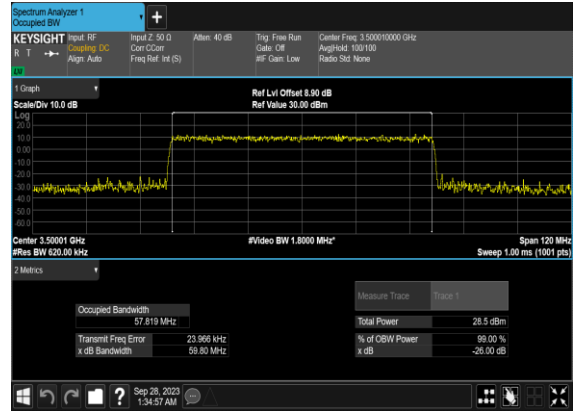

### N77(60M)\_CP-OFDM\_64QAM\_Outer\_Full\_Mid\_CH

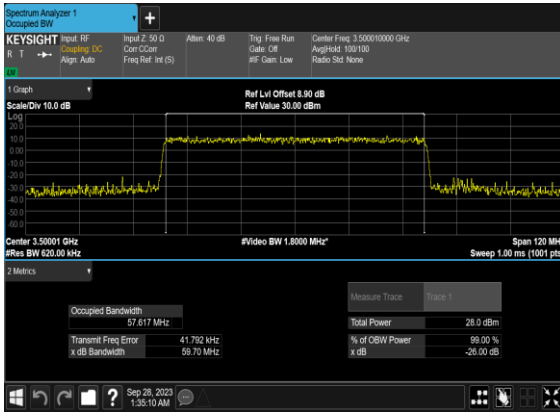

### N77(60M)\_CP-OFDM\_256QAM\_Outer\_Full\_Mid\_CH

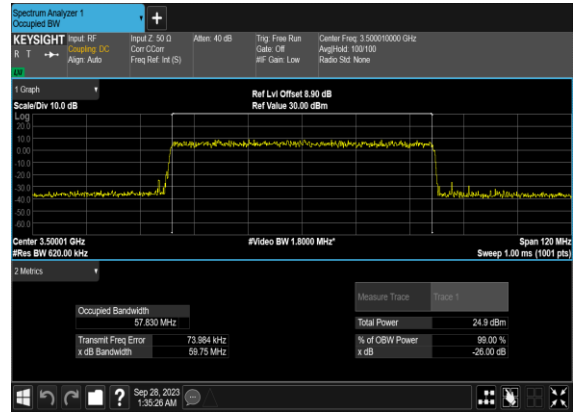

### N77(70M)\_CP-OFDM\_QPSK\_Outer\_Full\_Mid\_CH

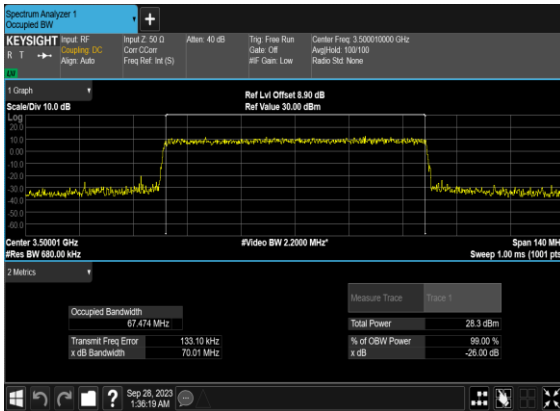

### N77(70M)\_CP-OFDM\_16QAM\_Outer\_Full\_Mid\_CH

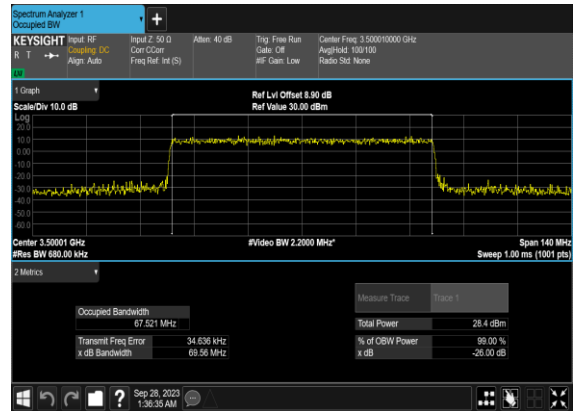

### N77(70M)\_CP-OFDM\_64 QAM\_Outer\_Full\_Mid\_CH

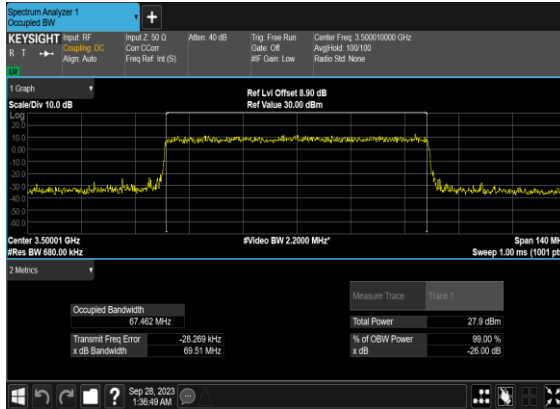

### N77(70M)\_CP-OFDM\_256 QAM\_Outer\_Full\_Mid\_CH

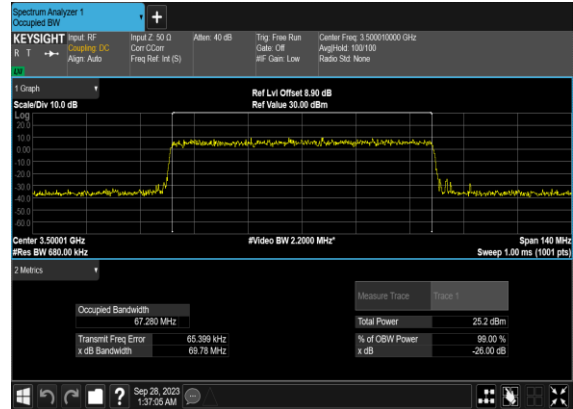

### N77(80M)\_CP- OFDM\_QPSK\_Outer\_Full\_Mid\_CH

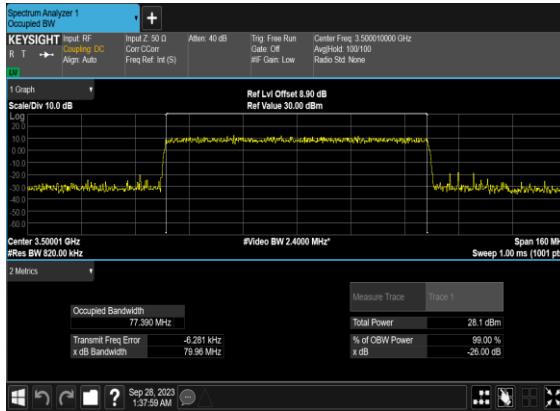

### N77(80M)\_CP-OFDM\_16 QAM\_Outer\_Full\_Mid\_CH

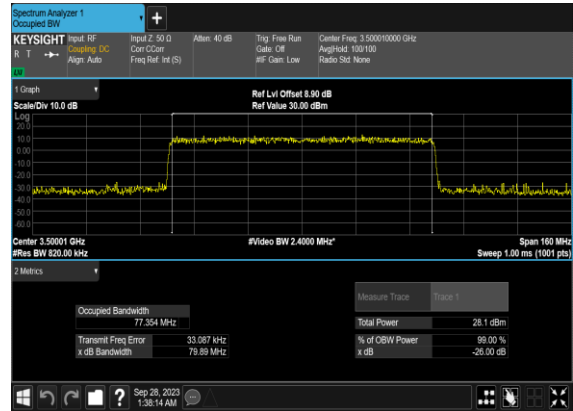

### N77(80M)\_CP-OFDM\_64 QAM\_Outer\_Full\_Mid\_CH

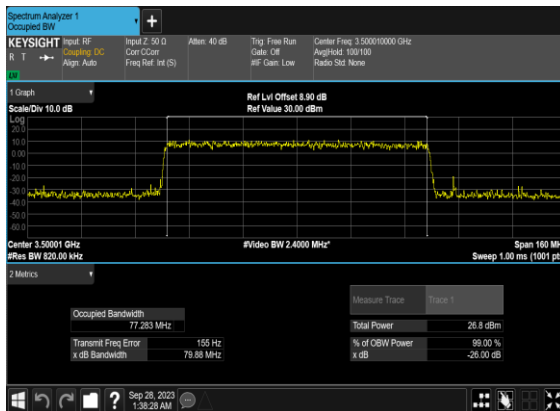

### N77(80M)\_CP-OFDM\_256 QAM\_Outer\_Full\_Mid\_CH

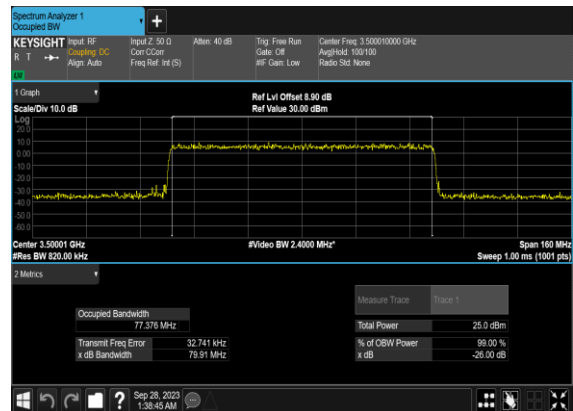



### N77(90M)\_CP-OFDM\_QPSK\_Outer\_Full\_Mid\_CH

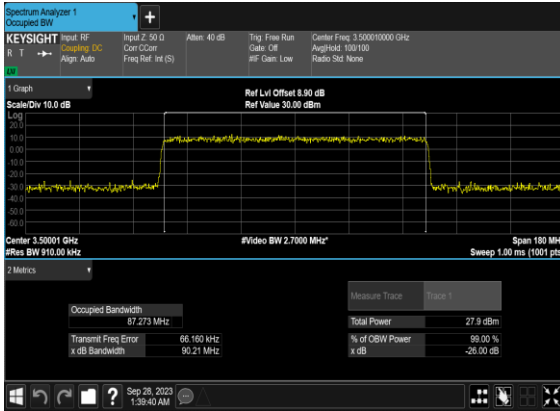

### N77(90M)\_CP-OFDM\_16 QAM\_Outer\_Full\_Mid\_CH

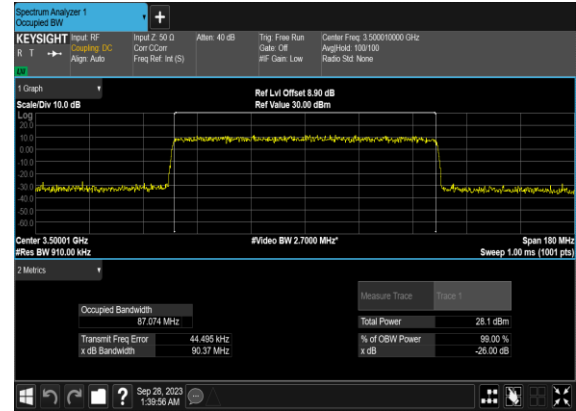

### N77(90M)\_CP-OFDM\_64 QAM\_Outer\_Full\_Mid\_CH

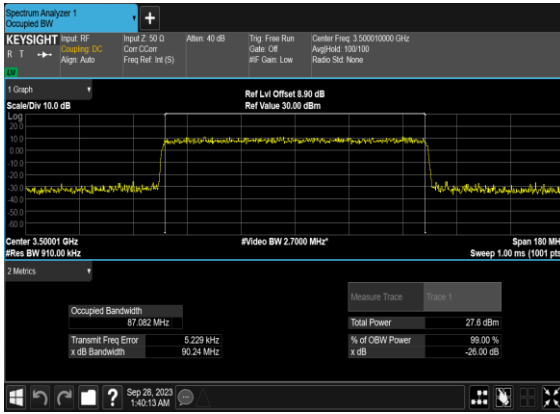

### N77(90M)\_CP-OFDM\_256 QAM\_Outer\_Full\_Mid\_CH

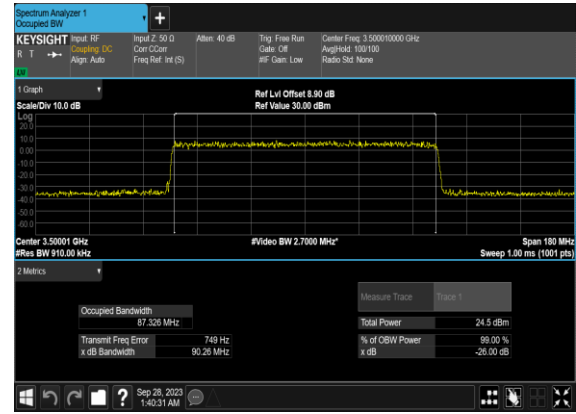

### N77(100M)\_CP-OFDM\_QPSK\_Outer\_Full\_Mid\_CH

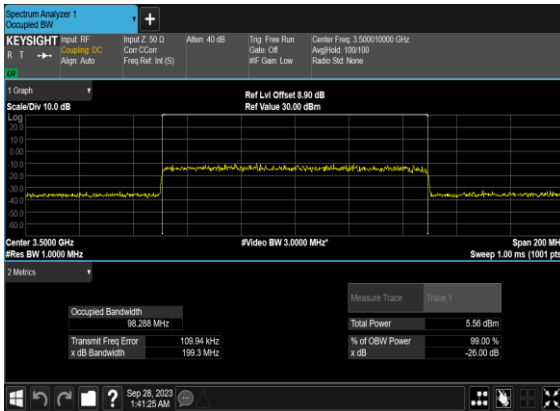

### N77(100M)\_CP-OFDM\_16 QAM\_Outer\_Full\_Mid\_CH

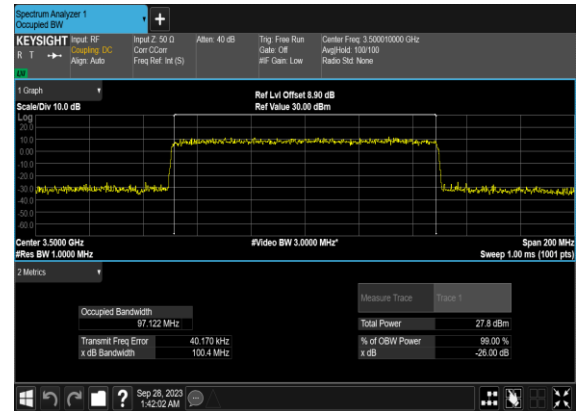

## N77(100M)\_CP-OFDM\_64 QAM\_Outer\_Full\_Mid\_CH

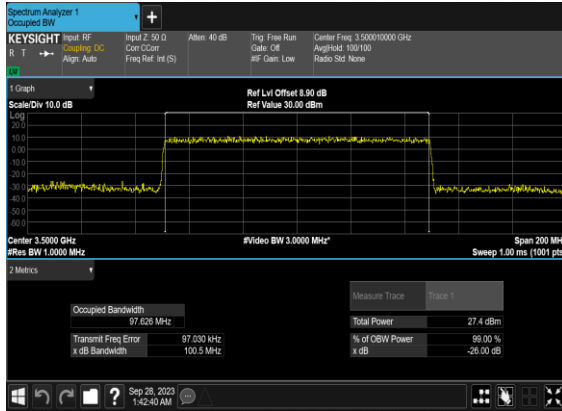

## N77(100M)\_CP-OFDM\_256 QAM\_Outer\_Full\_Mid\_CH

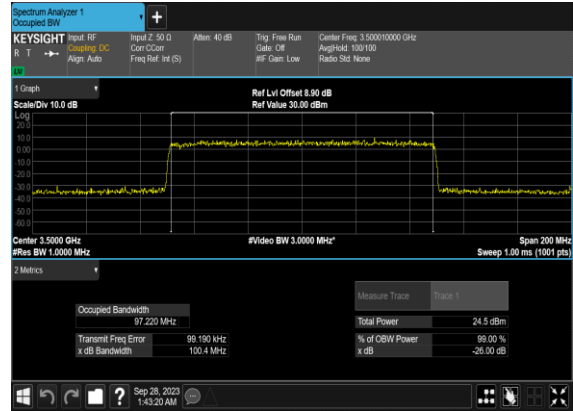

## Conducted Spurious Emissions

NR Band	SCS (kHz)	Bandwidth (MHz)	Arfcn	Freq (MHz)	Modulation	RB	Result	Verdict
77	30	10	630334	3455.01	DFT-s-OFDM BPSK	1@0	see graph	---
77	30	10	630334	3455.01	DFT-s-OFDM BPSK	1@0	see graph	PASS
77	30	10	630334	3455.01	DFT-s-OFDM BPSK	1@0	see graph	PASS
77	30	10	630334	3455.01	DFT-s-OFDM QPSK	1@0	see graph	---
77	30	10	630334	3455.01	DFT-s-OFDM QPSK	1@0	see graph	PASS
77	30	10	630334	3455.01	DFT-s-OFDM QPSK	1@0	see graph	PASS
77	30	10	633334	3500.01	DFT-s-OFDM BPSK	1@0	see graph	---
77	30	10	633334	3500.01	DFT-s-OFDM BPSK	1@0	see graph	PASS
77	30	10	633334	3500.01	DFT-s-OFDM BPSK	1@0	see graph	PASS
77	30	10	633334	3500.01	DFT-s-OFDM QPSK	1@0	see graph	---
77	30	10	633334	3500.01	DFT-s-OFDM QPSK	1@0	see graph	PASS
77	30	10	633334	3500.01	DFT-s-OFDM QPSK	1@0	see graph	PASS
77	30	10	636332	3544.98	DFT-s-OFDM BPSK	1@0	see graph	---
77	30	10	636332	3544.98	DFT-s-OFDM BPSK	1@0	see graph	PASS
77	30	10	636332	3544.98	DFT-s-OFDM BPSK	1@0	see graph	PASS
77	30	10	636332	3544.98	DFT-s-OFDM QPSK	1@0	see graph	---
77	30	10	636332	3544.98	DFT-s-OFDM QPSK	1@0	see graph	PASS
77	30	10	636332	3544.98	DFT-s-OFDM QPSK	1@0	see graph	PASS
77	30	50	631668	3475.02	DFT-s-OFDM BPSK	1@0	see graph	---
77	30	50	631668	3475.02	DFT-s-OFDM BPSK	1@0	see graph	PASS
77	30	50	631668	3475.02	DFT-s-OFDM BPSK	1@0	see graph	PASS
77	30	50	631668	3475.02	DFT-s-OFDM QPSK	1@0	see graph	---

77	30	50	631668	3475.02	DFT-s-OFDM QPSK	1@0	see graph	<b>PASS</b>
77	30	50	631668	3475.02	DFT-s-OFDM QPSK	1@0	see graph	<b>PASS</b>
77	30	50	633334	3500.01	DFT-s-OFDM BPSK	1@0	see graph	---
77	30	50	633334	3500.01	DFT-s-OFDM BPSK	1@0	see graph	<b>PASS</b>
77	30	50	633334	3500.01	DFT-s-OFDM BPSK	1@0	see graph	<b>PASS</b>
77	30	50	633334	3500.01	DFT-s-OFDM QPSK	1@0	see graph	---
77	30	50	633334	3500.01	DFT-s-OFDM QPSK	1@0	see graph	<b>PASS</b>
77	30	50	633334	3500.01	DFT-s-OFDM QPSK	1@0	see graph	<b>PASS</b>
77	30	50	635000	3525.0	DFT-s-OFDM BPSK	1@0	see graph	---
77	30	50	635000	3525.0	DFT-s-OFDM BPSK	1@0	see graph	<b>PASS</b>
77	30	50	635000	3525.0	DFT-s-OFDM BPSK	1@0	see graph	<b>PASS</b>
77	30	50	635000	3525.0	DFT-s-OFDM QPSK	1@0	see graph	---
77	30	50	635000	3525.0	DFT-s-OFDM QPSK	1@0	see graph	<b>PASS</b>
77	30	50	635000	3525.0	DFT-s-OFDM QPSK	1@0	see graph	<b>PASS</b>
77	30	100	633334	3500.01	DFT-s-OFDM BPSK	1@0	see graph	---
77	30	100	633334	3500.01	DFT-s-OFDM BPSK	1@0	see graph	<b>PASS</b>
77	30	100	633334	3500.01	DFT-s-OFDM BPSK	1@0	see graph	<b>PASS</b>
77	30	100	633334	3500.01	DFT-s-OFDM QPSK	1@0	see graph	---
77	30	100	633334	3500.01	DFT-s-OFDM QPSK	1@0	see graph	<b>PASS</b>
77	30	100	633334	3500.01	DFT-s-OFDM QPSK	1@0	see graph	<b>PASS</b>

### N77(10M)\_DFT-s-OFDM\_BPSK\_Edge\_1RB\_Left\_Low\_CH

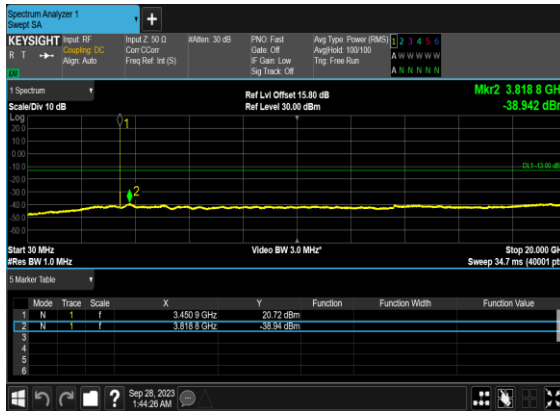

### N77(10M)\_DFT-s-OFDM\_BPSK\_Edge\_1RB\_Left\_Low\_CH

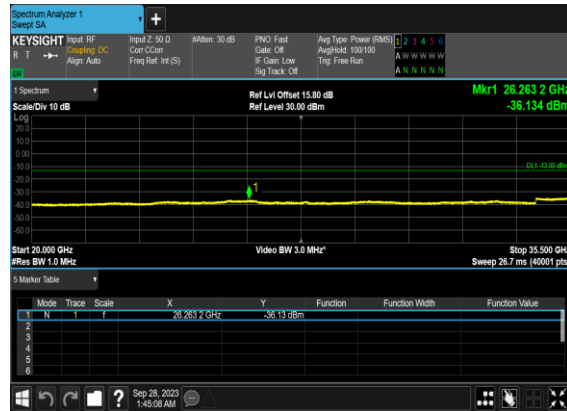

### N77(10M)\_DFT-s-OFDM\_QPSK\_Edge\_1RB\_Left\_Low\_CH



### N77(10M)\_DFT-s-OFDM\_QPSK\_Edge\_1RB\_Left\_Low\_CH

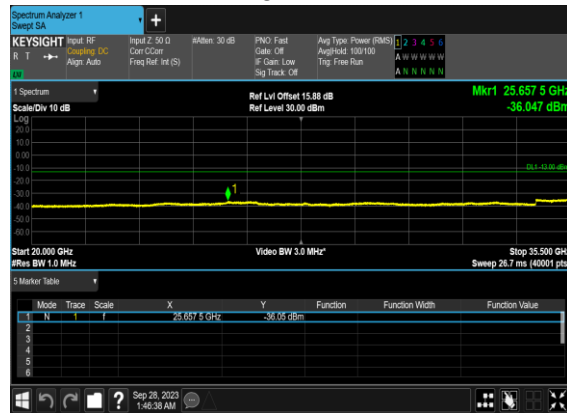

### N77(10M)\_DFT-s-OFDM\_BPSK\_Edge\_1RB\_Left\_Mid\_CH

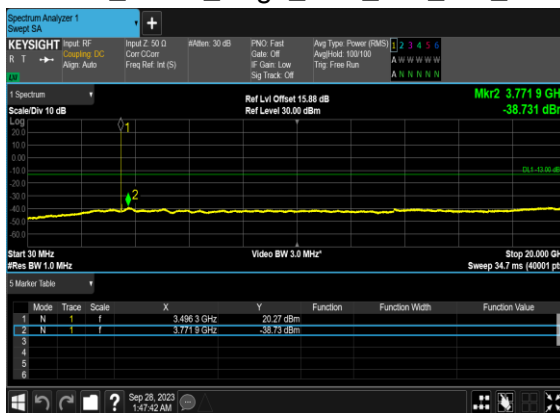

### N77(10M)\_DFT-s-OFDM\_BPSK\_Edge\_1RB\_Left\_Mid\_CH

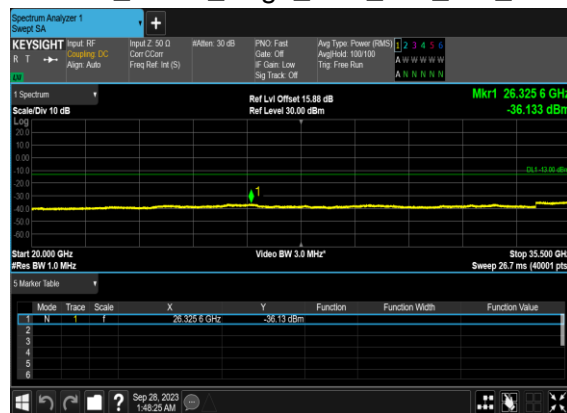

### N77(10M)\_DFT-s-OFDM\_QPSK\_Edge\_1RB\_Left\_Mid\_CH

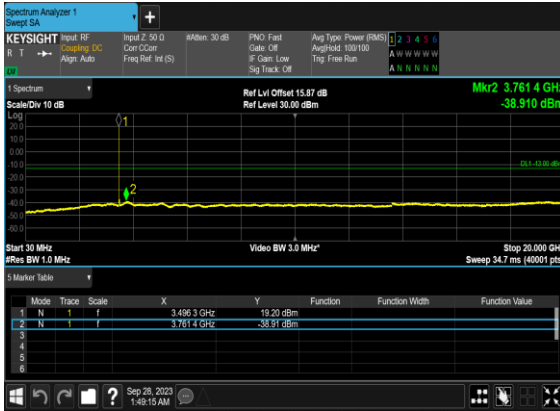

### N77(10M)\_DFT-s-OFDM\_QPSK\_Edge\_1RB\_Left\_Mid\_CH

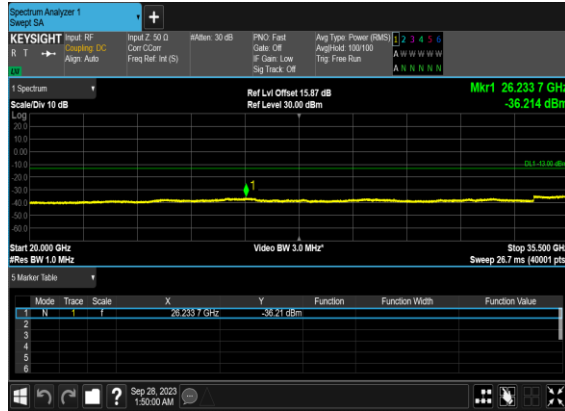

### N77(10M)\_DFT-s-OFDM\_BPSK\_Edge\_1RB\_Left\_High\_CH



### N77(10M)\_DFT-s-OFDM\_BPSK\_Edge\_1RB\_Left\_High\_CH

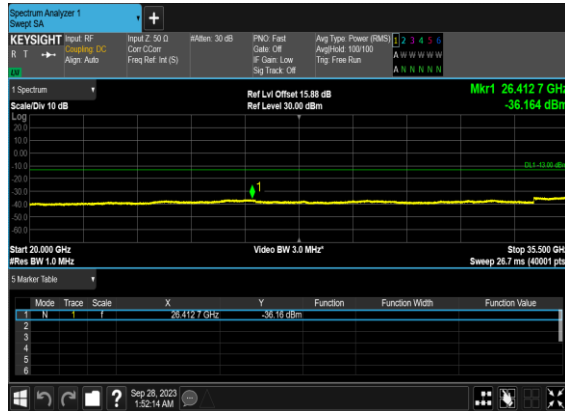

### N77(10M)\_DFT-s-OFDM\_QPSK\_Edge\_1RB\_Left\_High\_CH

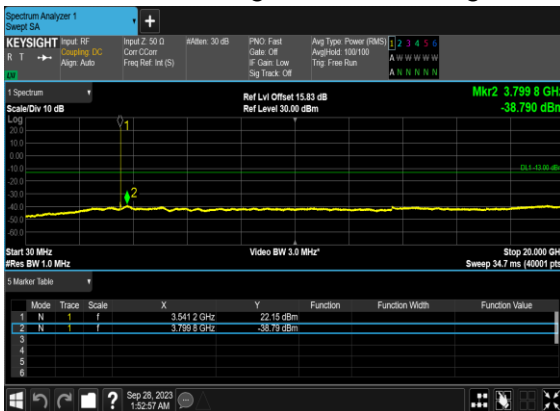

### N77(10M)\_DFT-s-OFDM\_QPSK\_Edge\_1RB\_Left\_High\_CH

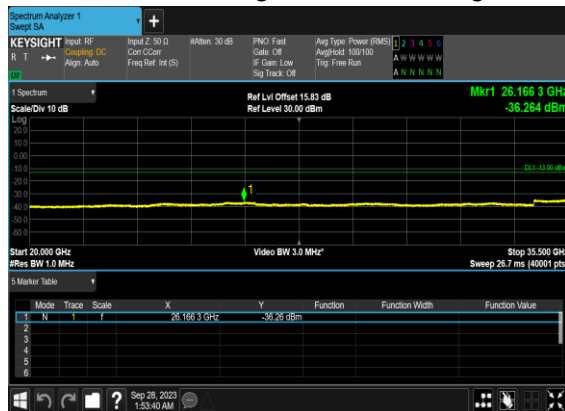

### N77(50M)\_DFT-s-OFDM\_BPSK\_Edge\_1RB\_Left\_Low\_CH

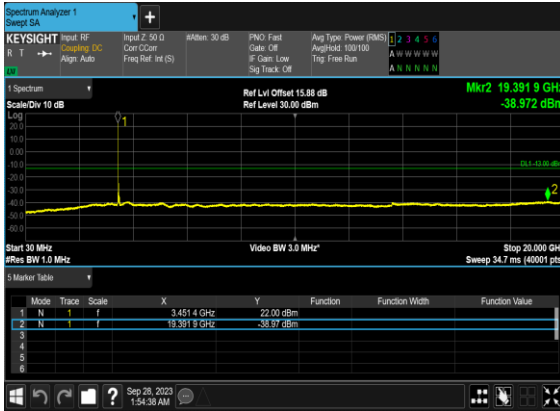

### N77(50M)\_DFT-s-OFDM\_BPSK\_Edge\_1RB\_Left\_Low\_CH

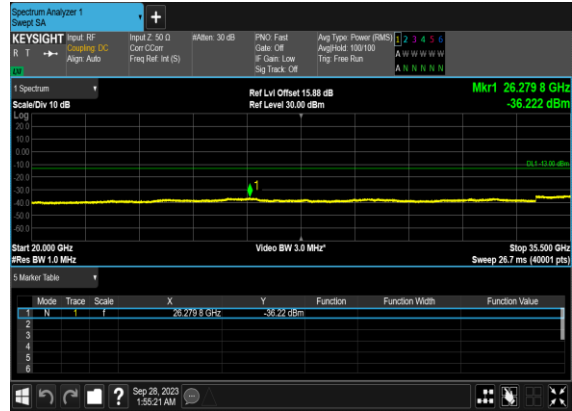

### N77(50M)\_DFT-s-OFDM\_QPSK\_Edge\_1RB\_Left\_Low\_CH

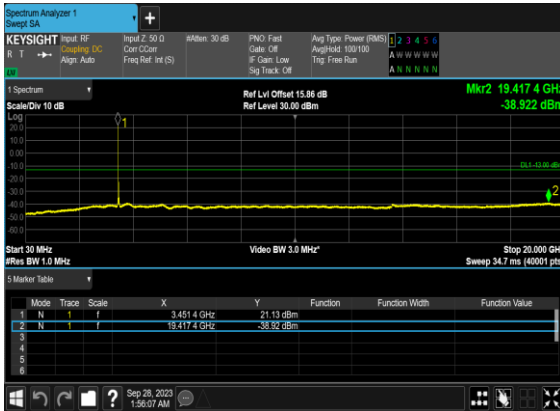

### N77(50M)\_DFT-s-OFDM\_QPSK\_Edge\_1RB\_Left\_Low\_CH

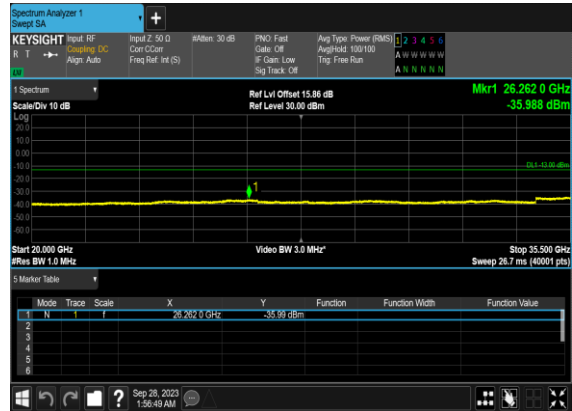

### N77(50M)\_DFT-s-OFDM\_BPSK\_Edge\_1RB\_Left\_Mid\_CH

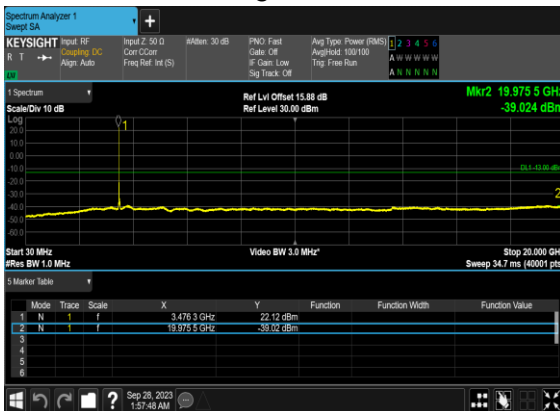

### N77(50M)\_DFT-s-OFDM\_BPSK\_Edge\_1RB\_Left\_Mid\_CH

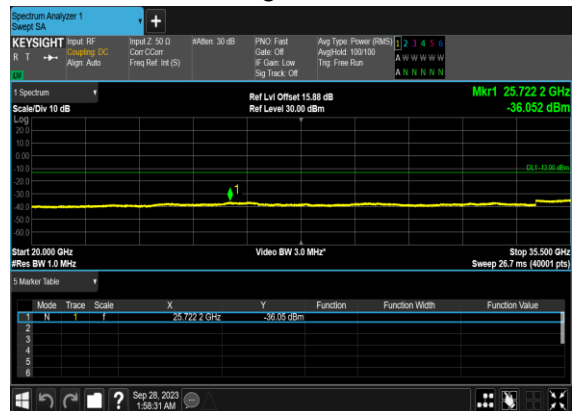

### N77(50M)\_DFT-s-OFDM\_QPSK\_Edge\_1RB\_Left\_Mid\_CH

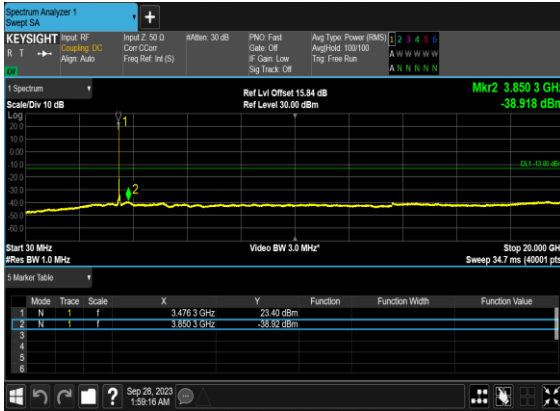

### N77(50M)\_DFT-s-OFDM\_QPSK\_Edge\_1RB\_Left\_Mid\_CH

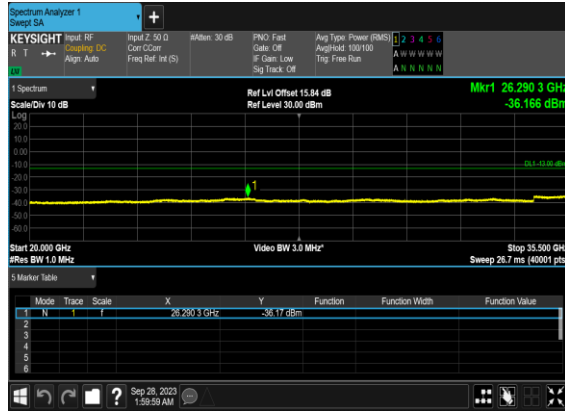

### N77(50M)\_DFT-s-OFDM\_BPSK\_Edge\_1RB\_Left\_High\_CH



### N77(50M)\_DFT-s-OFDM\_BPSK\_Edge\_1RB\_Left\_High\_CH

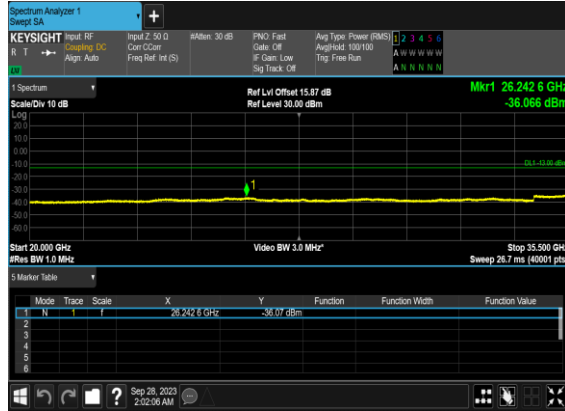

### N77(50M)\_DFT-s-OFDM\_QPSK\_Edge\_1RB\_Left\_High\_CH



### N77(50M)\_DFT-s-OFDM\_QPSK\_Edge\_1RB\_Left\_High\_CH

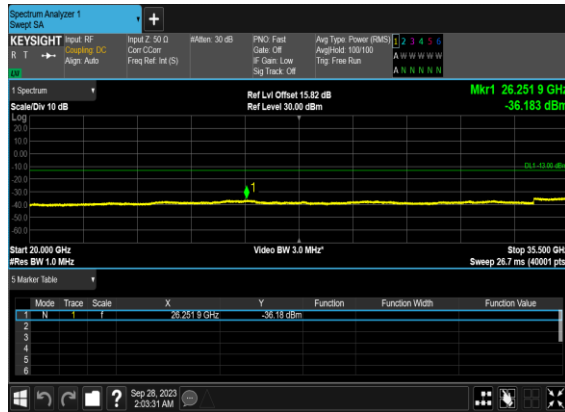



### N77(100M)\_DFT-s-OFDM\_BPSK\_Edge\_1RB\_Left\_Mid\_CH

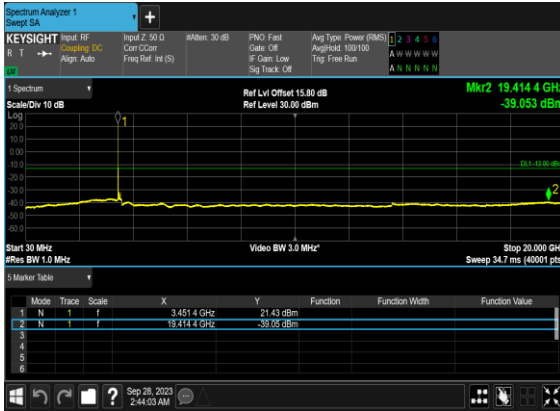

### N77(100M)\_DFT-s-OFDM\_BPSK\_Edge\_1RB\_Left\_Mid\_CH

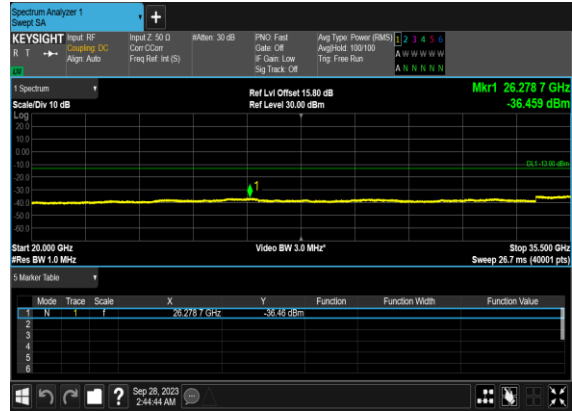

### N77(100M)\_DFT-s-OFDM\_QPSK\_Edge\_1RB\_Left\_Mid\_CH



### N77(100M)\_DFT-s-OFDM\_QPSK\_Edge\_1RB\_Left\_Mid\_CH

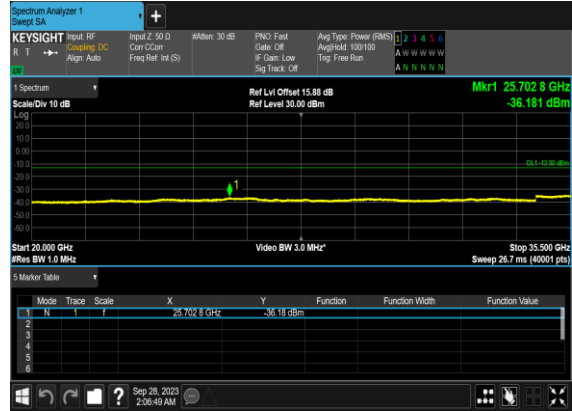

## Conducted Band Edge

NR Band	SCS (kHz)	Bandwidth (MHz)	Arfcn	Freq (MHz)	Modulation	RB	Result	Verdict
77	30	10	630334	3455.01	DFT-s-OFDM BPSK	1@0	see graph	PASS
77	30	10	630334	3455.01	DFT-s-OFDM QPSK	1@0	see graph	PASS
77	30	10	630334	3455.01	DFT-s-OFDM BPSK	24@0	see graph	PASS
77	30	10	630334	3455.01	DFT-s-OFDM QPSK	24@0	see graph	PASS
77	30	10	636332	3544.98	DFT-s-OFDM BPSK	1@23	see graph	PASS
77	30	10	636332	3544.98	DFT-s-OFDM QPSK	1@23	see graph	PASS
77	30	10	636332	3544.98	DFT-s-OFDM BPSK	24@0	see graph	PASS
77	30	10	636332	3544.98	DFT-s-OFDM QPSK	24@0	see graph	PASS
77	30	50	631668	3475.02	DFT-s-OFDM BPSK	1@0	see graph	PASS
77	30	50	631668	3475.02	DFT-s-OFDM QPSK	1@0	see graph	PASS
77	30	50	631668	3475.02	DFT-s-OFDM BPSK	128@0	see graph	PASS
77	30	50	631668	3475.02	DFT-s-OFDM QPSK	128@0	see graph	PASS
77	30	50	635000	3525.0	DFT-s-OFDM BPSK	1@132	see graph	PASS
77	30	50	635000	3525.0	DFT-s-OFDM QPSK	1@132	see graph	PASS
77	30	50	635000	3525.0	DFT-s-OFDM BPSK	128@0	see graph	PASS
77	30	50	635000	3525.0	DFT-s-OFDM QPSK	128@0	see graph	PASS
77	30	100	633334	3500.01	DFT-s-OFDM BPSK	1@0	see graph	PASS
77	30	100	633334	3500.01	DFT-s-OFDM QPSK	1@0	see graph	PASS
77	30	100	633334	3500.01	DFT-s-OFDM BPSK	1@272	see graph	PASS
77	30	100	633334	3500.01	DFT-s-OFDM QPSK	1@272	see graph	PASS
77	30	100	633334	3500.01	DFT-s-OFDM BPSK	270@0	see graph	PASS
77	30	100	633334	3500.01	DFT-s-OFDM QPSK	270@0	see graph	PASS

N77(10M)\_DFT-s-  
OFDM\_BPSK\_Edge\_1RB\_Left\_Low\_CH

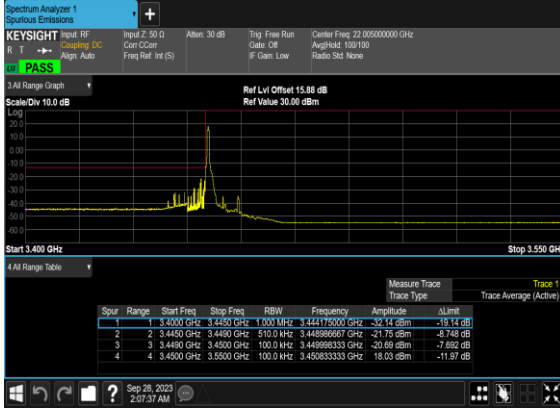

N77(10M)\_DFT-s-  
OFDM\_QPSK\_Edge\_1RB\_Left\_Low\_CH

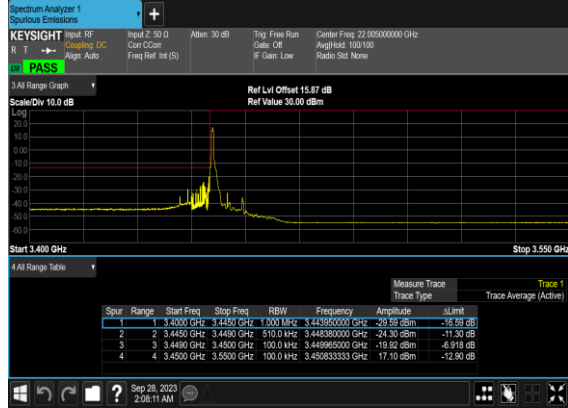

N77(10M)\_DFT-s-  
OFDM\_BPSK\_Outer\_Full\_Low\_CH

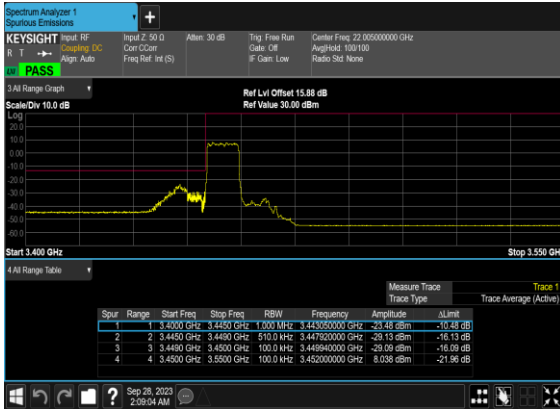

N77(10M)\_DFT-s-  
OFDM\_QPSK\_Outer\_Full\_Low\_CH

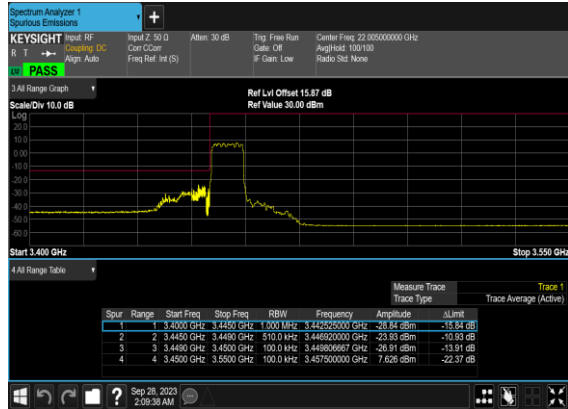

N77(10M)\_DFT-s-  
OFDM\_BPSK\_Edge\_1RB\_Right\_High\_CH

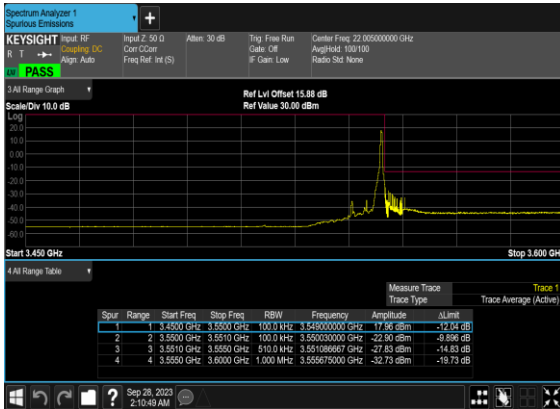

N77(10M)\_DFT-s-  
OFDM\_QPSK\_Edge\_1RB\_Right\_High\_CH

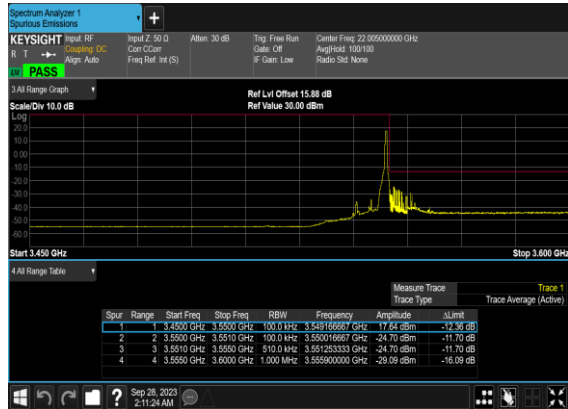

### N77(10M)\_DFT-s-OFDM\_BPSK\_Outer\_Full\_High\_CH



### N77(10M)\_DFT-s-OFDM\_QPSK\_Outer\_Full\_High\_CH



### N77(50M)\_DFT-s-OFDM\_BPSK\_Edge\_1RB\_Left\_Low\_CH

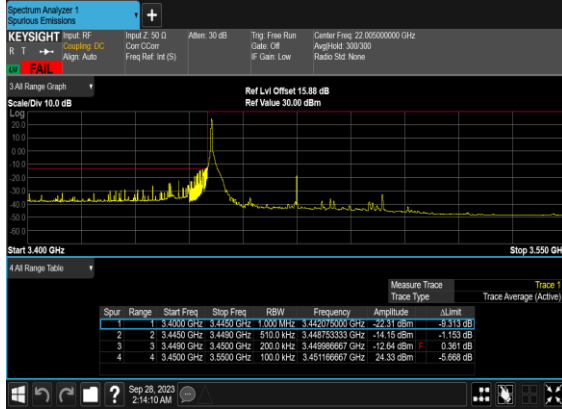

### N77(50M)\_DFT-s-OFDM\_BPSK\_Edge\_1RB\_Left\_Low\_CH\_CHP\_P ASS

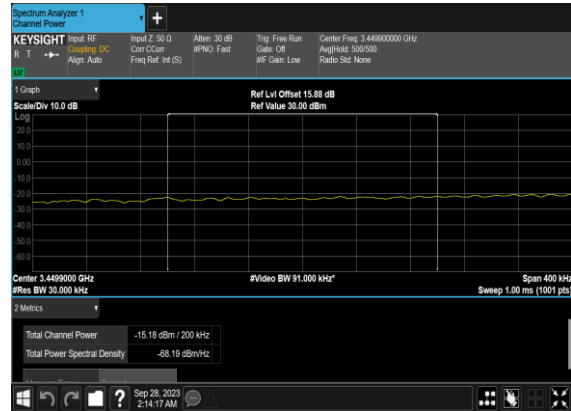

### N77(50M)\_DFT-s-OFDM\_QPSK\_Edge\_1RB\_Left\_Low\_CH

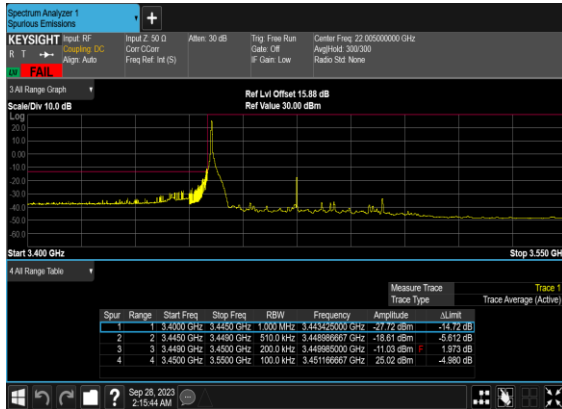

### N77(50M)\_DFT-s-OFDM\_QPSK\_Edge\_1RB\_Left\_Low\_CH\_CHP\_P ASS

