



FCC RF Test Report

APPLICANT : Motorola Mobility LLC
EQUIPMENT : Mobile Cellular Phone
BRAND NAME : Motorola
MODEL NAME : XT2413-1, XT2413-3
FCC ID : IHDT56AN3
STANDARD : 47 CFR Part 2, 22(H), 24(E)
CLASSIFICATION : PCS Licensed Transmitter Held to Ear (PCE)
TEST DATE(S) : Oct. 08, 2023 ~ Oct. 13, 2023

We, Sporton International Inc. (Shenzhen), would like to declare that the tested sample has been evaluated in accordance with the procedures given in ANSI C63.26-2015 and shown compliance with the applicable technical standards.

The test results in this report apply exclusively to the tested model / sample. Without written approval of Sporton International Inc. (Shenzhen), the test report shall not be reproduced except in full.

Jason Jia

Approved by: Jason Jia



Sporton International Inc. (ShenZhen)

1/F, 2/F, Bldg 5, Shiling Industrial Zone, Xinwei Village, Xili, Nanshan, Shenzhen, 518055

People's Republic of China



TABLE OF CONTENTS

REVISION HISTORY... 3
SUMMARY OF TEST RESULT ... 4
1 GENERAL DESCRIPTION ... 5
1.1 Applicant ... 5
1.2 Manufacturer ... 5
1.3 Product Feature of Equipment Under Test ... 5
1.4 Product Specification of Equipment Under Test ... 5
1.5 Modification of EUT ... 6
1.6 Specification of Accessory ... 6
1.7 Maximum ERP/EIRP Power and Emission Designator ... 6
1.8 Testing Location ... 7
1.9 Test Software ... 7
1.10 Applicable Standards ... 8
2 TEST CONFIGURATION OF EQUIPMENT UNDER TEST ... 9
2.1 Test Mode ... 9
2.2 Connection Diagram of Test System ... 10
2.3 Support Unit used in test configuration and system ... 10
2.4 Measurement Results Explanation Example ... 10
2.5 Frequency List of Low/Middle/High Channels ... 11
3 CONDUCTED TEST ITEMS ... 12
3.1 Measuring Instruments ... 12
3.2 Test Setup ... 12
3.3 Test Result of Conducted Test ... 12
3.4 Conducted Output Power and ERP/EIRP ... 13
3.5 Peak-to-Average Ratio ... 14
3.6 Occupied Bandwidth ... 15
3.7 Conducted Band Edge ... 16
3.8 Conducted Spurious Emission ... 17
3.9 Frequency Stability ... 18
4 RADIATED TEST ITEMS ... 19
4.1 Measuring Instruments ... 19
4.2 Test Setup ... 19
4.3 Test Result of Radiated Test ... 20
4.4 Radiated Spurious Emission ... 21
5 LIST OF MEASURING EQUIPMENT ... 22
6 MEASUREMENT UNCERTAINTY ... 23
APPENDIX A. TEST RESULTS OF CONDUCTED TEST
APPENDIX B. TEST RESULTS OF RADIATED TEST
APPENDIX C. TEST SETUP PHOTOGRAPHS



REVISION HISTORY

REPORT NO.	VERSION	DESCRIPTION	ISSUED DATE
FG391515-01C	Rev. 01	Initial issue of report	Nov. 07, 2023



SUMMARY OF TEST RESULT

Report Section	FCC Rule	Description	Limit	Result	Remark
3.4	§2.1046	Conducted Output Power	-	Report Only	-
	§22.913(a)(5)	Effective Radiated Power (Band 5)	ERP < 7 Watt	PASS	-
	§24.232(c)	Equivalent Isotropic Radiated Power (Band 2)	EIRP < 2Watt		-
3.5	§24.232(d)	Peak-to-Average Ratio	<13 dB	PASS	-
3.6	§2.1049	Occupied Bandwidth	-	Report Only	-
3.7	§2.1051 §22.917(a) §24.238(a)	Conducted Band Edge Measurement (Band 2) (Band 5)	< 43+10log10(P[Watts])	PASS	-
3.8	§2.1051 §22.917(a) §24.238(a)	Conducted Spurious Emission (Band 2) (Band 5)	< 43+10log10(P[Watts])	PASS	-
3.9	§2.1055 §22.355	Frequency Stability Temperature & Voltage	< 2.5 ppm for Part 22	PASS	-
	§2.1055 §24.235		Within Authorized Band		
4.4	§2.1053 §22.917(a) §24.238(a)	Radiated Spurious Emission (Band 2) (Band 5)	< 43+10log10(P[Watts])	PASS	Under limit 28.23 dB at 2496.270 MHz

Conformity Assessment Condition:

- The test results (PASS/FAIL) with all measurement uncertainty excluded are presented against the regulation limits or in accordance with the requirements stipulated by the applicant/manufacturer who shall bear all the risks of non-compliance that may potentially occur if measurement uncertainty is taken into account.
- The measurement uncertainty please refer to each test result in the section "Measurement Uncertainty"

Disclaimer:

The product specifications of the EUT presented in the test report that may affect the test assessments are declared by the manufacturer who shall take full responsibility for the authenticity.



1 General Description

1.1 Applicant

Motorola Mobility LLC
222 W,Merchandise Mart Plaza, Chicago IL 60654 USA

1.2 Manufacturer

Motorola Mobility LLC
222 W,Merchandise Mart Plaza, Chicago IL 60654 USA

1.3 Product Feature of Equipment Under Test

Product Feature	
Equipment	Mobile Cellular Phone
Brand Name	Motorola
Model Name	XT2413-1, XT2413-3
FCC ID	IHDT56AN3
IMEI Code	Conducted: 350803920011023 Radiation: 350803920011585
HW Version	DVT2
SW Version	T3TF33.55
EUT Stage	Identical Prototype

Remark:

1. The above EUT's information was declared by manufacturer. Please refer to the specifications or user's manual for more detailed description.
2. The model name XT2413-1, XT2413-3 are the same product except model name different for market segment.

1.4 Product Specification of Equipment Under Test

Standards-related Product Specification	
Tx Frequency	LTE Band 2 : 1850 MHz ~ 1910 MHz LTE Band 5 : 824 MHz ~ 849 MHz
Rx Frequency	LTE Band 2 : 1930 MHz ~ 1990 MHz LTE Band 5 : 869 MHz ~ 894 MHz
Bandwidth	LTE Band 2 : 1.4MHz / 3MHz / 5MHz / 10MHz / 15MHz / 20MHz LTE Band 5 : 1.4MHz / 3MHz / 5MHz / 10MHz
Maximum Output Power to Antenna	<Ant.0> LTE Band 2 : 22.53 dBm LTE Band 5 : 22.88 dBm <Ant.1> LTE Band 2 : 22.85 dBm LTE Band 5 : 23.05 dBm
Antenna Gain	<Ant.0> LTE Band 2 : -4.3 dBi LTE Band 5 : -6.9 dBi



	<Ant.1> LTE Band 2 : -6.2 dBi LTE Band 5 : -10.1 dBi
Type of Modulation	QPSK / 16QAM / 64QAM

Note: The maximum ERP/EIRP is calculated from max output power and max antenna gain, so only the maximum ERP/EIRP of Ant.0 for LTE Band 2/5 are shown in the report.

1.5 Modification of EUT

No modifications are made to the EUT during all test items.

1.6 Specification of Accessory

Specification of Accessory					
AC Adapter 1	Brand Name	Motorola(AOHAI)	Model Name	MC-101	
AC Adapter 2	Brand Name	Motorola(Salcomp)	Model Name	MC-101	
AC Adapter 3	Brand Name	Motorola(Chenyang)	Model Name	MC-101	
Battery 1	Brand Name	Motorola (Sunwoda)	Model Name	QF50	
Battery 2	Brand Name	Motorola (SCUD)	Model Name	QF50	
USB Cable 1	Brand Name	Motorola(Saibao)	Model Name	S928D97979/S928D97981	
USB Cable 2	Brand Name	Motorola(Naiyi)	Model Name	S928D97980/S928D97982	

1.7 Maximum ERP/EIRP Power and Emission Designator

LTE Band 2		QPSK		16QAM/64QAM	
BW (MHz)	Frequency Range (MHz)	Maximum EIRP(W)	Emission Designator (99%OBW)	Maximum EIRP(W)	Emission Designator (99%OBW)
1.4	1850.7 ~ 1909.3	0.0649	1M09G7D	0.0571	1M09W7D
3	1851.5 ~ 1908.5	0.0643	2M71G7D	0.0530	2M71W7D
5	1852.5 ~ 1907.5	0.0652	4M51G7D	0.0541	4M48W7D
10	1855.0 ~ 1905.0	0.0655	8M99G7D	0.0543	8M97W7D
15	1857.5 ~ 1902.5	0.0659	13M5G7D	0.0538	13M4W7D
20	1860.0 ~ 1900.0	0.0665	17M9G7D	0.0550	17M8W7D
LTE Band 5		QPSK		16QAM/64QAM	
BW (MHz)	Frequency Range (MHz)	Maximum ERP(W)	Emission Designator (99%OBW)	Maximum ERP(W)	Emission Designator (99%OBW)
1.4	824.7 ~ 848.3	0.0233	1M09G7D	0.0212	1M10W7D
3	825.5 ~ 847.5	0.0239	2M72G7D	0.0203	2M71W7D
5	826.5 ~ 846.5	0.0239	4M51G7D	0.0201	4M48W7D
10	829.0 ~ 844.0	0.0242	9M05G7D	0.0205	9M05W7D

Note: All modulations have been tested, and only the worst test results of PSK & QAM are shown in the report.



1.8 Testing Location

Sporton International Inc. (ShenZhen) is accredited to ISO/IEC 17025:2017 by American Association for Laboratory Accreditation with Certificate Number 5145.01.

Test Firm	Sporton International Inc. (ShenZhen)		
Test Site Location	1/F, 2/F, Bldg 5, Shiling Industrial Zone, Xinwei Village, Xili, Nanshan, Shenzhen, 518055 People's Republic of China TEL: +86-755-86379589 FAX: +86-755-86379595		
Test Site No.	Sporton Site No.	FCC Designation No.	FCC Test Firm Registration No.
	TH01-SZ	CN1256	421272

Test Firm	Sporton International Inc. (ShenZhen)		
Test Site Location	101, 1st Floor, Block B, Building 1, No. 2, Tengfeng 4th Road, Fenghuang Community, Fuyong Street, Baoan District, Shenzhen City, Guangdong Province 518103 People's Republic of China TEL: +86-755-86066985		
Test Site No.	Sporton Site No.	FCC Designation No.	FCC Test Firm Registration No.
	03CH03-SZ	CN1256	421272

1.9 Test Software

Item	Site	Manufacture	Name	Version
1.	03CH03-SZ	AUDIX	E3	6.2009-8-24



1.10 Applicable Standards

According to the specifications of the manufacturer, the EUT must comply with the requirements of the following standards:

- ♦ 47 CFR Part 2, 22(H), 24(E)
- ♦ ANSI C63.26-2015
- ♦ FCC KDB 971168 D01 Power Meas License Digital Systems v03r01
- ♦ FCC KDB 412172 D01 Determining ERP and EIRP v01r01

Remark:

1. All test items were verified and recorded according to the standards and without any deviation during the test.
2. This EUT has also been tested and complied with the requirements of FCC Part 15, Subpart B, recorded in a separate test report.



2 Test Configuration of Equipment Under Test

2.1 Test Mode

Antenna port conducted and radiated test items listed below are performed according to KDB 971168 D01 Power Meas License Digital Systems v03r01 with maximum output power.

Radiated measurements are performed by rotating the EUT in three different orthogonal test planes to find the maximum emission.

Test Items	Band	Bandwidth (MHz)						Modulation			RB #			Test Channel			
		1.4	3	5	10	15	20	QPSK	16QA M	64QA M	1	Half	Full	L	M	H	
Max. Output Power	2	v	v	v	v	v	v	v	v	v	v	v	v	v	v	v	
	5	v	v	v	v	-	-	v	v	v	v	v	v	v	v	v	
Peak-to-Average Ratio	2						v	v	v	v			v		v		
	5				v	-	-	v	v	v			v		v		
26dB and 99% Bandwidth	2	v	v	v	v	v	v	v	v				v		v		
	5	v	v	v	v	-	-	v	v				v		v		
Conducted Band Edge	2	v	v	v	v	v	v	v	v	v	v		v		v		
	5	v	v	v	v	-	-	v	v	v	v		v		v		
Conducted Spurious Emission	2	v	v	v	v	v	v	v				v			v	v	v
	5	v	v	v	v	-	-	v				v			v	v	v
Frequency Stability	2				v			v						v		v	
	5				v	-	-	v						v		v	
E.R.P / E.I.R.P	2	v	v	v	v	v	v	v	v	v	v	v			v	v	v
	5	v	v	v	v	-	-	v	v	v	v	v			v	v	v
Radiated Spurious Emission	2	Worst Case														v	
	5	Worst Case														v	
Note	1. The mark "v" means that this configuration is chosen for testing 2. The mark "-" means that this bandwidth is not supported. 3. The device is investigated from 30MHz to 10 times of fundamental signal for radiated spurious emission test under different RB size/offset and modulations in exploratory test. Subsequently, only the worst case emissions are reported.																

2.2 Connection Diagram of Test System

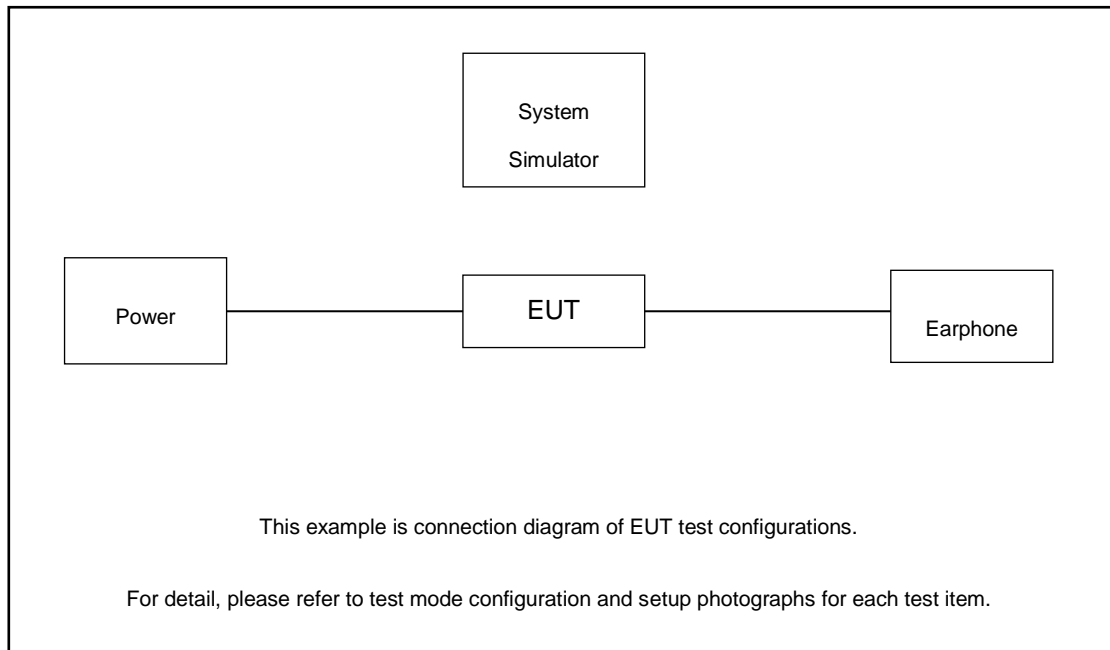

2.3 Support Unit used in test configuration and system

Item	Equipment	Trade Name	Model No.	FCC ID	Data Cable	Power Cord
1.	Power Supply	GWINSTEK	PSS-2002	N/A	N/A	Unshielded, 1.8 m
2.	LTE Base Station	Anritsu	MT8820C	N/A	N/A	Unshielded, 1.8 m
3.	Earphone	N/A	N/A	N/A	N/A	N/A

2.4 Measurement Results Explanation Example

For all conducted test items:

The offset level is set in the spectrum analyzer to compensate the RF cable loss and attenuator factor between EUT conducted output port and spectrum analyzer. With the offset compensation, the spectrum analyzer reading level is exactly the EUT RF output level.

The spectrum analyzer offset is derived from RF cable loss and attenuator factor.

Offset = RF cable loss + attenuator factor.

Following shows an offset computation example with cable loss 4.5 dB and 10dB attenuator.

Example :

$$\begin{aligned} \text{Offset(dB)} &= \text{RF cable loss(dB)} + \text{attenuator factor(dB)}. \\ &= 4.5 + 10 = 14.5 \text{ (dB)} \end{aligned}$$



2.5 Frequency List of Low/Middle/High Channels

LTE Band 2 Channel and Frequency List				
BW [MHz]	Channel/Frequency(MHz)	Lowest	Middle	Highest
20	Channel	18700	18900	19100
	Frequency	1860	1880	1900
15	Channel	18675	18900	19125
	Frequency	1857.5	1880	1902.5
10	Channel	18650	18900	19150
	Frequency	1855	1880	1905
5	Channel	18625	18900	19175
	Frequency	1852.5	1880	1907.5
3	Channel	18615	18900	19185
	Frequency	1851.5	1880	1908.5
1.4	Channel	18607	18900	19193
	Frequency	1850.7	1880	1909.3

LTE Band 5 Channel and Frequency List				
BW [MHz]	Channel/Frequency(MHz)	Lowest	Middle	Highest
10	Channel	20450	20525	20600
	Frequency	829	836.5	844
5	Channel	20425	20525	20625
	Frequency	826.5	836.5	846.5
3	Channel	20415	20525	20635
	Frequency	825.5	836.5	847.5
1.4	Channel	20407	20525	20643
	Frequency	824.7	836.5	848.3

3 Conducted Test Items

3.1 Measuring Instruments

See list of measuring instruments of this test report.

3.2 Test Setup

3.2.1 Conducted Output Power

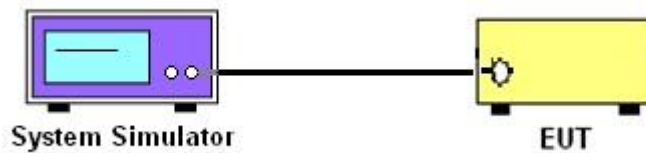

3.2.2 Peak-to-Average Ratio, Occupied Bandwidth ,Conducted Band-Edge and Conducted Spurious Emission

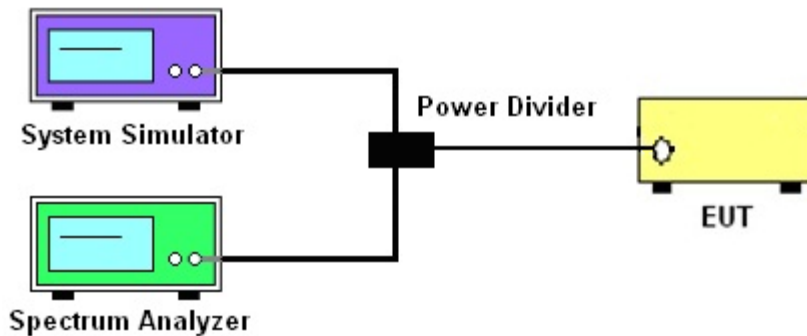

3.2.3 Frequency Stability

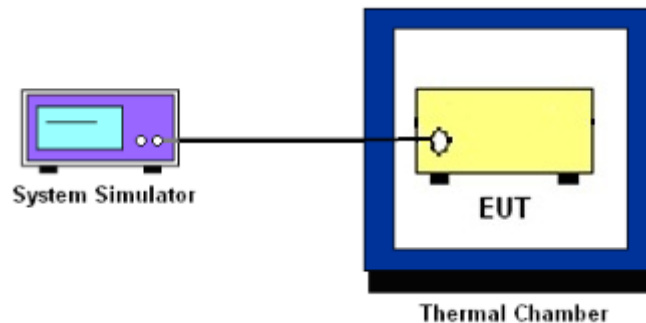

3.3 Test Result of Conducted Test

Please refer to Appendix A.



3.4 Conducted Output Power and ERP/EIRP

3.4.1 Description of the Conducted Output Power Measurement and ERP/EIRP Measurement

A system simulator was used to establish communication with the EUT. Its parameters were set to force the EUT transmitting at maximum output power. The measured power in the radio frequency on the transmitter output terminals shall be reported.

The ERP of mobile transmitters must not exceed 7 Watts for LTE Band 5.

The EIRP of mobile transmitters must not exceed 2 Watts for LTE Band 2.

According to KDB 412172 D01 Power Approach,

$EIRP = P_T + G_T - L_C$, $ERP = EIRP - 2.15$, where

P_T = transmitter output power in dBm

G_T = gain of the transmitting antenna in dBi

L_C = signal attenuation in the connecting cable between the transmitter and antenna in dB

3.4.2 Test Procedures

1. The testing follows ANSI C63.26 Section 5.2
2. The transmitter output port was connected to the system simulator.
3. Set EUT at maximum power through the system simulator.
4. Select lowest, middle, and highest channels for each band and different modulation.
5. Measure and record the power level from the system simulator.



3.5 Peak-to-Average Ratio

3.5.1 Description of the PAR Measurement

Power Complementary Cumulative Distribution Function (CCDF) curves provide a means for characterizing the power peaks of a digitally modulated signal on a statistical basis. A CCDF curve depicts the probability of the peak signal amplitude exceeding the average power level. Most contemporary measurement instrumentation include the capability to produce CCDF curves for an input signal provided that the instrument's resolution bandwidth can be set wide enough to accommodate the entire input signal bandwidth. In measuring transmissions in this band using an average power technique, the peak-to-average ratio (PAR) of the transmission may not exceed 13 dB.

3.5.2 Test Procedures

1. The testing follows ANSI C63.26 Section 5.2.3.4 (CCDF).
2. The EUT was connected to spectrum and system simulator via a power divider.
3. Set the CCDF (Complementary Cumulative Distribution Function) option in spectrum analyzer.
4. The highest RF powers were measured and recorded the maximum PAPR level associated with a probability of 0.1 %.
5. Record the deviation as Peak to Average Ratio.



3.6 Occupied Bandwidth

3.6.1 Description of Occupied Bandwidth Measurement

The occupied bandwidth is the width of a frequency band such that, below the lower and above the upper frequency limits, the mean powers emitted are each equal to a specified percentage 0.5% of the total mean transmitted power.

The 26 dB emission bandwidth is defined as the frequency range between two points, one above and one below the carrier frequency, at which the spectral density of the emission is attenuated 26 dB below the maximum in-band spectral density of the modulated signal. Spectral density (power per unit bandwidth) is to be measured with a detector of resolution bandwidth equal to approximately 1.0% of the emission bandwidth.

3.6.2 Test Procedures

1. The testing follows ANSI C63.26 Section 5.4
2. The EUT was connected to spectrum analyzer and system simulator via a power divider.
3. The spectrum analyzer center frequency is set to the nominal EUT channel center frequency. The span range for the spectrum analyzer shall be between two and five times the anticipated OBW.
4. The nominal resolution bandwidth (RBW) shall be in the range of 1 to 5 % of the anticipated OBW, and the VBW shall be at least 3 times the RBW.
5. Set the detection mode to peak, and the trace mode to max hold.
6. Determine the reference value: Set the EUT to transmit a modulated signal. Allow the trace to stabilize. Set the spectrum analyzer marker to the highest level of the displayed trace.
(this is the reference value)
7. Determine the “-26 dB down amplitude” as equal to (Reference Value – X).
8. Place two markers, one at the lowest and the other at the highest frequency of the envelope of the spectral display such that each marker is at or slightly below the “-X dB down amplitude” determined in step 6. If a marker is below this “-X dB down amplitude” value it shall be placed as close as possible to this value. The OBW is the positive frequency difference between the two markers.
9. Use the 99 % power bandwidth function of the spectrum analyzer and report the measured bandwidth.



3.7 Conducted Band Edge

3.7.1 Description of Conducted Band Edge Measurement

22.917(a)

For operations in the 824 – 849 MHz band, the FCC limit is $43 + 10\log_{10}(P[\text{Watts}])$ dB below the transmitter power P(Watts) in a 100kHz bandwidth. However, in the 1MHz bands immediately outside and adjacent to the licensee's frequency block, a resolution bandwidth of at least one percent of the emission bandwidth of the fundamental emission of the transmitter may be employed.

24.238 (a)

For operations in the 1850-1910 and 1930-1990 MHz band, the FCC limit is $43 + 10\log_{10}(P[\text{Watts}])$ dB below the transmitter power P(Watts) in a 1MHz bandwidth. However, in the 1 MHz bands immediately outside and adjacent to the frequency block a resolution bandwidth of at least one percent of the emission bandwidth of the fundamental emission of the transmitter may be employed.

3.7.2 Test Procedures

1. The testing follows ANSI C63.26 section 5.7
2. The EUT was connected to spectrum analyzer and system simulator via a power divider.
3. The band edges of low and high channels for the highest RF powers were measured.
4. Set RBW \geq 1% EBW in the 1MHz band immediately outside and adjacent to the band edge.
5. Beyond the 1 MHz band from the band edge, RBW=1MHz was used
6. Set spectrum analyzer with RMS detector.
7. The RF fundamental frequency should be excluded against the limit line in the operating frequency band.
8. Checked that all the results comply with the emission limit line.

Example:

$$\begin{aligned} & \text{The limit line is derived from } 43 + 10\log(P)\text{dB below the transmitter power } P(\text{Watts}) \\ & = P(\text{W}) - [43 + 10\log(P)] \text{ (dB)} \\ & = [30 + 10\log(P)] \text{ (dBm)} - [43 + 10\log(P)] \text{ (dB)} = -13\text{dBm}. \end{aligned}$$

9. When using the integration method, the starting frequency of the integration shall be centered at one-half of the RBW away from the band edge.



3.8 Conducted Spurious Emission

3.8.1 Description of Conducted Spurious Emission Measurement

The power of any emission outside of the authorized operating frequency ranges must be lower than the transmitter power (P) by a factor of at least $43 + 10 \log (P)$ dB.

It is measured by means of a calibrated spectrum analyzer and scanned from 30 MHz up to a frequency including its 10th harmonic.

3.8.2 Test Procedures

1. The testing follows ANSI C63.26 section 5.7
2. The EUT was connected to spectrum analyzer and system simulator via a power divider.
3. The RF output of EUT was connected to the spectrum analyzer by RF cable and attenuator. The path loss was compensated to the results for each measurement.
4. The middle channel for the highest RF power within the transmitting frequency was measured.
5. The conducted spurious emission for the whole frequency range was taken.
6. Make the measurement with the spectrum analyzer's RBW = 1MHz, VBW = 3MHz.
7. Set spectrum analyzer with RMS detector.
8. Taking the record of maximum spurious emission.
9. The RF fundamental frequency should be excluded against the limit line in the operating frequency band.
10. The limit line is derived from $43 + 10\log(P)$ dB below the transmitter power P(Watts)
= P(W)- [43 + 10log(P)] (dB)
= [30 + 10log(P)] (dBm) - [43 + 10log(P)] (dB)
= -13dBm.



3.9 Frequency Stability

3.9.1 Description of Frequency Stability Measurement

The frequency stability shall be measured by variation of ambient temperature and variation of primary supply voltage to ensure that the fundamental emission stays within the authorized frequency block. The frequency stability of the transmitter shall be maintained within $\pm 0.00025\%$ ($\pm 2.5\text{ppm}$) of the center frequency.

3.9.2 Test Procedures for Temperature Variation

1. The testing follows ANSI C63.26 section 5.6.4
2. The EUT was set up in the thermal chamber and connected with the system simulator.
3. With power OFF, the temperature was decreased to -30°C and the EUT was stabilized before testing. Power was applied and the maximum change in frequency was recorded within one minute.
4. With power OFF, the temperature was raised in 10°C step up to 50°C . The EUT was stabilized at each step for at least half an hour. Power was applied and the maximum frequency change was recorded within one minute.

3.9.3 Test Procedures for Voltage Variation

1. The testing follows ANSI C63.26 section 5.6.5
2. The EUT was placed in a temperature chamber at $20\pm 5^{\circ}\text{C}$ and connected with the system simulator.
3. The power supply voltage to the EUT was varied from 85% to 115% of the nominal value for other than hand carried battery equipment.
4. For hand carried, battery powered equipment, reduce the primary ac or dc supply voltage to the battery operating end point, which shall be specified by the manufacturer.
5. The variation in frequency was measured for the worst case.

4 Radiated Test Items

4.1 Measuring Instruments

See list of measuring instruments of this test report.

4.2 Test Setup

4.2.1 For radiated test below 30MHz

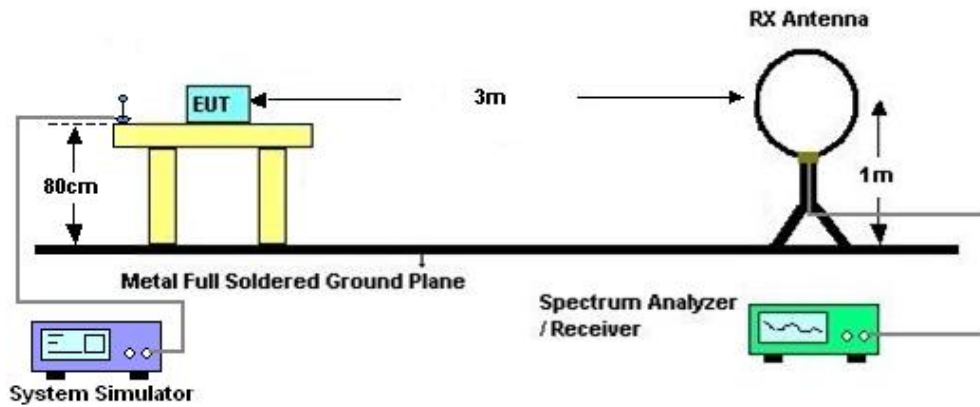

4.2.2 For radiated test from 30MHz to 1GHz

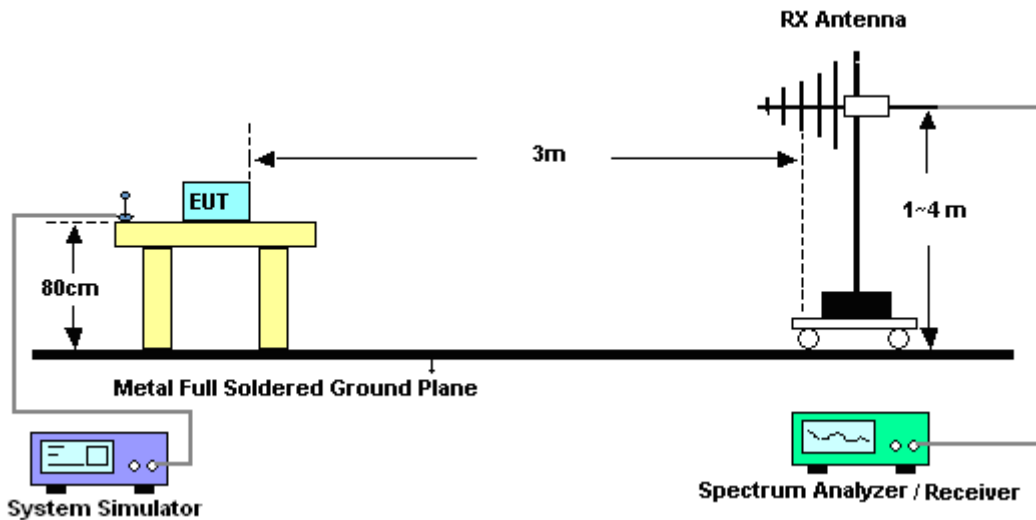

4.2.3 For radiated test above 1GHz

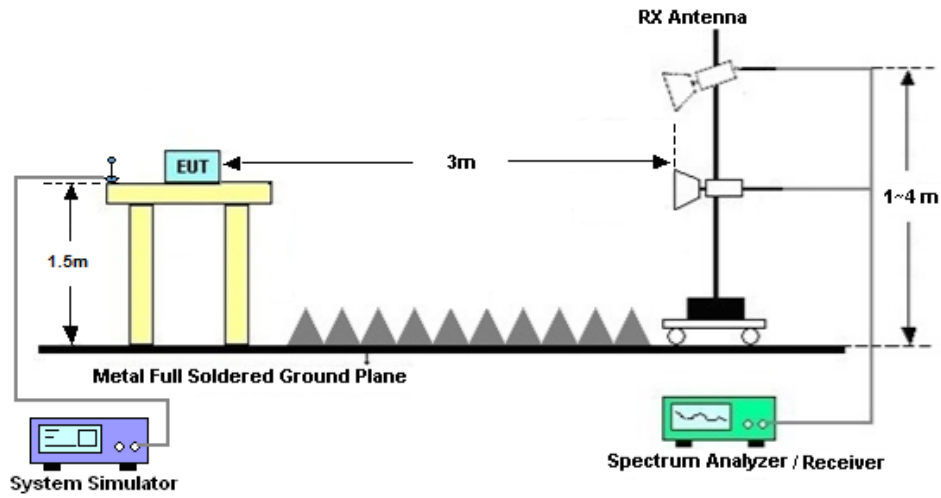

4.3 Test Result of Radiated Test

The low frequency, which started from 9 kHz to 30MHz, was pre-scanned and the result which was 20dB lower than the limit line was not reported.

Please refer to Appendix B.



4.4 Radiated Spurious Emission

4.4.1 Description of Radiated Spurious Emission

The radiated spurious emission was measured by substitution method according to ANSI C63.26. The power of any emission outside of the authorized operating frequency ranges must be attenuated below the transmitter power (P) by a factor of at least $43 + 10 \log (P)$ dB.

The spectrum is scanned from 30 MHz up to a frequency including its 10th harmonic.

4.4.2 Test Procedures

1. The testing follows ANSI C63.26 Section 5.5
2. The EUT was placed on a turntable with 0.8 meter height for frequency below 1GHz and 1.5 meter height for frequency above 1GHz respectively above ground.
3. The EUT was set 3 meters from the receiving antenna mounted on the antenna tower.
4. The table was rotated 360 degrees to determine the position of the highest spurious emission.
5. The height of the receiving antenna is varied between 1m to 4m to search the maximum spurious emission for both horizontal and vertical polarizations.
6. During the measurement, the system simulator parameters were set to force the EUT transmitting at maximum output power.
7. Make the measurement with the spectrum analyzer's RBW = 1MHz, VBW = 3MHz, taking the record of maximum spurious emission.
8. A horn antenna was substituted in place of the EUT and was driven by a signal generator.
9. Tune the output power of signal generator to the same emission level with EUT maximum spurious emission.
10. $EIRP \text{ (dBm)} = S.G. \text{ Power} - Tx \text{ Cable Loss} + Tx \text{ Antenna Gain}$
11. $ERP \text{ (dBm)} = EIRP - 2.15$
12. The RF fundamental frequency should be excluded against the limit line in the operating frequency band.

The limit line is derived from $43 + 10\log(P)$ dB below the transmitter power P(Watts)
= $P(W) - [43 + 10\log(P)] \text{ (dB)}$
= $[30 + 10\log(P)] \text{ (dBm)} - [43 + 10\log(P)] \text{ (dB)}$
= -13dBm.



5 List of Measuring Equipment

Instrument	Manufacturer	Model No.	Serial No.	Characteristics	Calibration Date	Test Date	Due Date	Remark
Spectrum Analyzer	R&S	FSV40	101078	10Hz~40GHz	Apr. 06, 2023	Oct. 08, 2023	Apr. 05, 2024	Conducted (TH01-SZ)
Power Divider	TOJOIN	PS-2SM-04 265	60.06.020.007 7	0.4GHz~26.5GHz	Dec. 25, 2022	Oct. 08, 2023	Dec. 24, 2023	Conducted (TH01-SZ)
DC Power Supply	TTI	PL330P	290070	Max 32V , 3A	Oct. 17, 2022	Oct. 08, 2023	Oct. 16, 2023	Conducted (TH01-SZ)
Thermal Chamber	Ten Billion Hongzhangroup	LP-150U	H2014081803	-40~+150°C	Jul. 05, 2023	Oct. 08, 2023	Jul. 04, 2024	Conducted (TH01-SZ)
EMI Test Receiver&SA	KEYSIGHT	N9038A	MY54450083	20Hz~8.4GHz	Apr. 04, 2023	Oct. 13, 2023	Apr. 03, 2024	Radiation (03CH03-SZ)
Loop Antenna	R&S	HFH2-Z2	100354	9kHz~30MHz	Jun. 28, 2022	Oct. 13, 2023	Jun. 27, 2024	Radiation (03CH03-SZ)
EXA Spectrum Analyzer	KEYSIGHT	N9010A	MY55150246	10Hz~44GHz;	Apr. 04, 2023	Oct. 13, 2023	Apr. 03, 2024	Radiation (03CH03-SZ)
Bilog Antenna	TeseQ	CBL6112D	35408	30MHz-2GHz	Aug. 20, 2023	Oct. 13, 2023	Aug. 19, 2025	Radiation (03CH03-SZ)
Double Ridge Horn Antenna	SCHWARZBECK	BBHA9120D	9120D-1355	1GHz~18GHz	Apr. 08, 2023	Oct. 13, 2023	Apr. 07, 2024	Radiation (03CH03-SZ)
Amplifier	Burgeon	BPA-530	102211	0.01Hz ~3000MHz	Oct. 19, 2022	Oct. 13, 2023	Oct. 18, 2023	Radiation (03CH03-SZ)
HF Amplifier	MITEQ	TTA1840-35 -HG	1871923	18GHz~40GHz	Jul. 07, 2023	Oct. 13, 2023	Jul. 06, 2024	Radiation (03CH03-SZ)
SHF-EHF Horn	com-power	AH-840	101071	18Ghz-40GHz	Apr. 08, 2023	Oct. 13, 2023	Apr. 07, 2024	Radiation (03CH03-SZ)
Amplifier	Agilent Technologies	83017A	MY39501302	500MHz~26.5GHz	Dec. 26, 2022	Oct. 13, 2023	Dec. 25, 2023	Radiation (03CH03-SZ)
AC Power Source	Chroma	61601	616010002729	N/A	Nov. 10, 2022	Oct. 13, 2023	Nov. 09, 2023	Radiation (03CH03-SZ)
Turn Table	EM	EM1000	N/A	0~360 degree	NCR	Oct. 13, 2023	NCR	Radiation (03CH03-SZ)
Antenna Mast	EM	EM1000	N/A	1 m~4 m	NCR	Oct. 13, 2023	NCR	Radiation (03CH03-SZ)

NCR: No Calibration Required



6 Measurement Uncertainty

The measurement uncertainties shown below were calculated in accordance with the requirements of ANSI 63.26-2015. All the measurement uncertainty value were shown with a coverage K=2 to indicate 95% level of confidence. The measurement data show herein meets or exceeds the CISPR measurement uncertainty values specified in CISPR 16-4-2 and can be compared directly to specified limit to determine compliance.

Uncertainty of Conducted Measurement

Test Item	Uncertainty
Conducted Power	±1.34 dB
Conducted Emissions	±1.34 dB
Occupied Channel Bandwidth	±0.13 %

Uncertainty of Radiated Emission Measurement (30 MHz ~ 1000 MHz)

Measuring Uncertainty for a Level of Confidence of 95% (U = 2Uc(y))	3.0dB
---	-------

Uncertainty of Radiated Emission Measurement (1 GHz ~ 18 GHz)

Measuring Uncertainty for a Level of Confidence of 95% (U = 2Uc(y))	3.6dB
---	-------

Uncertainty of Radiated Emission Measurement (18 GHz ~ 40 GHz)

Measuring Uncertainty for a Level of Confidence of 95% (U = 2Uc(y))	3.8dB
---	-------



Appendix A. Test Results of Conducted Test

Test Engineer :	Change Chen	Temperature :	24~26°C
		Relative Humidity :	50~53%

Conducted Output Power(Average power)

LTE Band 2:

BW [MHz]	Modulation	RB Size	RB Offset	Power Low Ch. / Freq.	Power Middle Ch. / Freq.	Power High Ch. / Freq.
Channel				18700	18900	19100
Frequency (MHz)				1860	1880	1900
20	QPSK	1	0	22.21	22.26	22.34
20	QPSK	1	49	22.32	22.53	22.45
20	QPSK	1	99	22.29	22.35	22.33
20	QPSK	50	0	21.30	21.29	21.38
20	QPSK	50	24	21.35	21.52	21.47
20	QPSK	50	50	21.11	21.16	21.24
20	QPSK	100	0	21.34	21.39	21.35
20	16QAM	1	0	21.58	21.57	21.30
20	16QAM	1	49	21.61	21.70	21.69
20	16QAM	1	99	21.24	21.38	21.21
20	16QAM	50	0	20.32	20.16	20.45
20	16QAM	50	24	20.36	20.27	20.31
20	16QAM	50	50	20.09	20.11	20.23
20	16QAM	100	0	20.12	20.23	20.36
20	64QAM	1	0	20.71	20.82	20.55
20	64QAM	1	49	20.49	20.63	20.51
20	64QAM	1	99	20.48	20.52	20.78
20	64QAM	50	0	19.41	19.43	19.30
20	64QAM	50	24	19.44	19.42	19.43
20	64QAM	50	50	19.40	19.32	19.31
20	64QAM	100	0	19.39	19.36	19.39
Channel				18675	18900	19125
Frequency (MHz)				1857.5	1880	1902.5
15	QPSK	1	0	22.11	22.20	22.19
15	QPSK	1	37	22.28	22.49	22.41
15	QPSK	1	74	22.18	22.29	22.27
15	QPSK	36	0	21.26	21.13	21.32
15	QPSK	36	20	21.24	21.43	21.40
15	QPSK	36	39	21.00	21.08	21.17
15	QPSK	75	0	21.24	21.34	21.29
15	16QAM	1	0	21.44	21.49	21.21
15	16QAM	1	37	21.53	21.61	21.61
15	16QAM	1	74	21.17	21.30	21.08
15	16QAM	36	0	20.24	20.05	20.29
15	16QAM	36	20	20.26	20.17	20.17
15	16QAM	36	39	20.00	20.01	20.10



15	16QAM	75	0	20.02	20.13	20.23
15	64QAM	1	0	20.61	20.72	20.45
15	64QAM	1	37	20.39	20.53	20.41
15	64QAM	1	74	20.38	20.42	20.71
15	64QAM	36	0	19.31	19.33	19.18
15	64QAM	36	20	19.34	19.32	19.33
15	64QAM	36	39	19.30	19.22	19.21
15	64QAM	75	0	19.29	19.26	19.29
Channel				18650	18900	19150
Frequency (MHz)				1855	1880	1905
10	QPSK	1	0	22.08	22.21	22.19
10	QPSK	1	25	22.23	22.46	22.35
10	QPSK	1	49	22.14	22.20	22.23
10	QPSK	25	0	21.22	21.20	21.34
10	QPSK	25	12	21.24	21.39	21.36
10	QPSK	25	25	21.07	21.04	21.10
10	QPSK	50	0	21.30	21.23	21.22
10	16QAM	1	0	21.46	21.48	21.19
10	16QAM	1	25	21.53	21.65	21.54
10	16QAM	1	49	21.12	21.24	21.08
10	16QAM	25	0	20.24	20.05	20.40
10	16QAM	25	12	20.26	20.17	20.15
10	16QAM	25	25	20.00	20.01	20.12
10	16QAM	50	0	20.02	20.13	20.23
10	64QAM	1	0	20.61	20.72	20.44
10	64QAM	1	25	20.39	20.53	20.46
10	64QAM	1	49	20.38	20.42	20.65
10	64QAM	25	0	19.31	19.33	19.14
10	64QAM	25	12	19.34	19.32	19.33
10	64QAM	25	25	19.30	19.22	19.21
10	64QAM	50	0	19.29	19.26	19.29
Channel				18625	18900	19175
Frequency (MHz)				1852.5	1880	1907.5
5	QPSK	1	0	22.05	22.21	22.21
5	QPSK	1	12	22.28	22.44	22.32
5	QPSK	1	24	22.23	22.26	22.19
5	QPSK	12	0	21.15	21.22	21.25
5	QPSK	12	7	21.28	21.46	21.40
5	QPSK	12	13	21.01	21.10	21.11
5	QPSK	25	0	21.25	21.28	21.23
5	16QAM	1	0	21.51	21.49	21.21
5	16QAM	1	12	21.48	21.59	21.63
5	16QAM	1	24	21.10	21.31	21.17
5	16QAM	12	0	20.18	20.01	20.32
5	16QAM	12	7	20.26	20.17	20.19
5	16QAM	12	13	20.00	20.01	20.13
5	16QAM	25	0	20.02	20.13	20.23
5	64QAM	1	0	20.61	20.72	20.47
5	64QAM	1	12	20.39	20.53	20.45
5	64QAM	1	24	20.38	20.42	20.74



5	64QAM	12	0	19.31	19.33	19.19
5	64QAM	12	7	19.34	19.32	19.33
5	64QAM	12	13	19.30	19.22	19.21
5	64QAM	25	0	19.29	19.26	19.29
Channel				18615	18900	19185
Frequency (MHz)				1851.5	1880	1908.5
3	QPSK	1	0	22.17	22.15	22.28
3	QPSK	1	8	22.28	22.38	22.32
3	QPSK	1	14	22.16	22.25	22.17
3	QPSK	8	0	21.24	21.15	21.24
3	QPSK	8	4	21.28	21.40	21.35
3	QPSK	8	7	21.05	21.06	21.19
3	QPSK	15	0	21.29	21.28	21.29
3	16QAM	1	0	21.54	21.49	21.14
3	16QAM	1	8	21.51	21.54	21.54
3	16QAM	1	14	21.12	21.29	21.12
3	16QAM	8	0	20.25	20.12	20.31
3	16QAM	8	4	20.26	20.17	20.26
3	16QAM	8	7	20.00	20.01	20.08
3	16QAM	15	0	20.02	20.13	20.22
3	64QAM	1	0	20.61	20.72	20.41
3	64QAM	1	8	20.39	20.53	20.43
3	64QAM	1	14	20.38	20.42	20.68
3	64QAM	8	0	19.31	19.33	19.18
3	64QAM	8	4	19.34	19.32	19.33
3	64QAM	8	7	19.30	19.22	19.21
3	64QAM	15	0	19.29	19.26	19.29
Channel				18607	18900	19193
Frequency (MHz)				1850.7	1880	1909.3
1.4	QPSK	1	0	22.26	22.23	22.32
1.4	QPSK	1	3	22.29	22.41	22.26
1.4	QPSK	1	5	22.21	22.42	22.32
1.4	QPSK	3	0	22.31	22.32	22.12
1.4	QPSK	3	1	22.22	22.38	22.36
1.4	QPSK	3	3	22.27	22.35	22.35
1.4	QPSK	6	0	21.22	21.28	21.23
1.4	16QAM	1	0	21.79	21.45	21.82
1.4	16QAM	1	3	21.32	21.66	21.29
1.4	16QAM	1	5	21.87	21.51	21.21
1.4	16QAM	3	0	21.29	21.41	21.23
1.4	16QAM	3	1	21.33	21.20	21.34
1.4	16QAM	3	3	21.36	21.36	21.07
1.4	16QAM	6	0	20.31	20.31	20.29
1.4	64QAM	1	0	20.28	20.51	20.70
1.4	64QAM	1	3	20.44	20.59	20.46
1.4	64QAM	1	5	20.00	20.58	20.77
1.4	64QAM	3	0	20.39	20.29	20.40
1.4	64QAM	3	1	20.33	20.47	20.40
1.4	64QAM	3	3	20.55	20.52	20.49
1.4	64QAM	6	0	19.25	19.33	19.28



LTE Band 5:

BW [MHz]	Modulation	RB Size	RB Offset	Power Low Ch. / Freq.	Power Middle Ch. / Freq.	Power High Ch. / Freq.
Channel				20450	20525	20600
Frequency (MHz)				829	836.5	844
10	QPSK	1	0	22.49	22.74	22.56
10	QPSK	1	25	22.83	22.88	22.75
10	QPSK	1	49	22.81	22.84	22.74
10	QPSK	25	0	21.57	21.67	21.64
10	QPSK	25	12	21.60	21.75	21.68
10	QPSK	25	25	21.58	21.62	21.62
10	QPSK	50	0	21.62	21.72	21.66
10	16QAM	1	0	21.86	21.82	21.75
10	16QAM	1	25	22.17	21.98	21.89
10	16QAM	1	49	22.08	22.08	21.78
10	16QAM	25	0	20.65	20.69	20.64
10	16QAM	25	12	20.54	20.56	20.66
10	16QAM	25	25	20.59	20.53	20.73
10	16QAM	50	0	20.53	20.60	20.71
10	64QAM	1	0	20.87	20.84	20.96
10	64QAM	1	25	20.84	20.82	20.75
10	64QAM	1	49	20.71	21.15	20.79
10	64QAM	25	0	19.59	19.60	19.63
10	64QAM	25	12	19.62	19.60	19.62
10	64QAM	25	25	19.62	19.66	19.64
10	64QAM	50	0	19.61	19.68	19.64
Channel				20425	20525	20625
Frequency (MHz)				826.5	836.5	846.5
5	QPSK	1	0	22.40	22.73	22.55
5	QPSK	1	12	22.77	22.84	22.70
5	QPSK	1	24	22.74	22.76	22.73
5	QPSK	12	0	21.51	21.61	21.56
5	QPSK	12	7	21.51	21.66	21.59
5	QPSK	12	13	21.57	21.52	21.54
5	QPSK	25	0	21.60	21.69	21.62
5	16QAM	1	0	21.76	21.78	21.65
5	16QAM	1	12	22.08	21.88	21.87
5	16QAM	1	24	22.03	22.04	21.74
5	16QAM	12	0	20.59	20.63	20.60
5	16QAM	12	7	20.53	20.54	20.56
5	16QAM	12	13	20.52	20.48	20.63
5	16QAM	25	0	20.52	20.54	20.63
5	64QAM	1	0	20.83	20.74	20.88
5	64QAM	1	12	20.77	20.74	20.72
5	64QAM	1	24	20.65	21.11	20.74
5	64QAM	12	0	19.58	19.53	19.54
5	64QAM	12	7	19.58	19.56	19.55
5	64QAM	12	13	19.56	19.64	19.61
5	64QAM	25	0	19.60	19.61	19.57



Channel				20415	20525	20635
Frequency (MHz)				825.5	836.5	847.5
3	QPSK	1	0	22.47	22.66	22.46
3	QPSK	1	8	22.77	22.84	22.72
3	QPSK	1	14	22.79	22.83	22.73
3	QPSK	8	0	21.51	21.58	21.59
3	QPSK	8	4	21.59	21.66	21.62
3	QPSK	8	7	21.49	21.52	21.54
3	QPSK	15	0	21.61	21.64	21.57
3	16QAM	1	0	21.77	21.77	21.70
3	16QAM	1	8	22.12	21.97	21.82
3	16QAM	1	14	22.00	22.01	21.71
3	16QAM	8	0	20.64	20.60	20.57
3	16QAM	8	4	20.44	20.53	20.63
3	16QAM	8	7	20.56	20.45	20.65
3	16QAM	15	0	20.43	20.56	20.69
3	64QAM	1	0	20.77	20.78	20.93
3	64QAM	1	8	20.74	20.76	20.65
3	64QAM	1	14	20.66	21.05	20.76
3	64QAM	8	0	19.53	19.56	19.58
3	64QAM	8	4	19.58	19.51	19.55
3	64QAM	8	7	19.52	19.64	19.55
3	64QAM	15	0	19.54	19.63	19.63
Channel				20407	20525	20643
Frequency (MHz)				824.7	836.5	848.3
1.4	QPSK	1	0	22.66	22.56	22.53
1.4	QPSK	1	3	22.73	22.59	22.62
1.4	QPSK	1	5	22.59	22.55	22.65
1.4	QPSK	3	0	22.65	22.50	22.51
1.4	QPSK	3	1	22.71	22.69	22.71
1.4	QPSK	3	3	22.68	22.58	22.52
1.4	QPSK	6	0	21.69	21.62	21.50
1.4	16QAM	1	0	22.11	22.06	22.20
1.4	16QAM	1	3	22.31	21.84	22.15
1.4	16QAM	1	5	22.02	22.13	21.54
1.4	16QAM	3	0	21.61	21.54	21.66
1.4	16QAM	3	1	21.78	21.78	21.57
1.4	16QAM	3	3	21.74	21.84	21.64
1.4	16QAM	6	0	20.84	20.65	20.63
1.4	64QAM	1	0	20.66	20.87	20.77
1.4	64QAM	1	3	20.45	20.62	20.61
1.4	64QAM	1	5	20.73	20.85	20.87
1.4	64QAM	3	0	20.76	20.47	20.78
1.4	64QAM	3	1	20.61	20.78	20.71
1.4	64QAM	3	3	20.78	20.68	20.84
1.4	64QAM	6	0	19.85	19.67	19.65



ERP/EIRP

LTE Band 2 (GT - LC = -4.3 dB) QPSK									
Bandwidth	1.4M			3M			5M		
Channel	26407	26340	26683	26055	26340	26675	26065	26340	26665
	(Low)	(Mid)	(High)	(Low)	(Mid)	(High)	(Low)	(Mid)	(High)
Frequency (MHz)	1850.7	1880	1914.3	1851.5	1880	1913.5	1852.5	1880	1912.5
Conducted Power (dBm)	22.21	22.42	22.32	22.28	22.38	22.32	22.28	22.44	22.32
Conducted Power (Watts)	0.1663	0.1746	0.1706	0.1690	0.1730	0.1706	0.1690	0.1754	0.1706
EIRP(dBm)	17.91	18.12	18.02	17.98	18.08	18.02	17.98	18.14	18.02
EIRP(Watts)	0.0618	0.0649	0.0634	0.0628	0.0643	0.0634	0.0628	0.0652	0.0634

LTE Band 2 (GT - LC = -4.3 dB) QPSK									
Bandwidth	10M			15M			20M		
Channel	26090	26340	26640	26115	26340	26615	26140	26340	26590
	(Low)	(Mid)	(High)	(Low)	(Mid)	(High)	(Low)	(Mid)	(High)
Frequency (MHz)	1855	1880	1910	1857.5	1880	1907.5	1860	1880	1905
Conducted Power (dBm)	22.23	22.46	22.35	22.28	22.49	22.41	22.32	22.53	22.45
Conducted Power (Watts)	0.1671	0.1762	0.1718	0.1690	0.1774	0.1742	0.1706	0.1791	0.1758
EIRP(dBm)	17.93	18.16	18.05	17.98	18.19	18.11	18.02	18.23	18.15
EIRP(Watts)	0.0621	0.0655	0.0638	0.0628	0.0659	0.0647	0.0634	0.0665	0.0653



LTE Band 2 (GT - LC = -4.3 dB) 16QAM									
Bandwidth	1.4M			3M			5M		
Channel	26407	26340	26683	26055	26340	26675	26065	26340	26665
	(Low)	(Mid)	(High)	(Low)	(Mid)	(High)	(Low)	(Mid)	(High)
Frequency (MHz)	1850.7	1880	1914.3	1851.5	1880	1913.5	1852.5	1880	1912.5
Conducted Power (dBm)	21.87	21.51	21.21	21.51	21.54	21.54	21.48	21.59	21.63
Conducted Power (Watts)	0.1538	0.1416	0.1321	0.1416	0.1426	0.1426	0.1406	0.1442	0.1455
EIRP(dBm)	17.57	17.21	16.91	17.21	17.24	17.24	17.18	17.29	17.33
EIRP(Watts)	0.0571	0.0526	0.0491	0.0526	0.0530	0.0530	0.0522	0.0536	0.0541

LTE Band 2 (GT - LC = -4.3 dB) 16QAM									
Bandwidth	10M			15M			20M		
Channel	26090	26340	26640	26115	26340	26615	26140	26340	26590
	(Low)	(Mid)	(High)	(Low)	(Mid)	(High)	(Low)	(Mid)	(High)
Frequency (MHz)	1855	1880	1910	1857.5	1880	1907.5	1860	1880	1905
Conducted Power (dBm)	21.53	21.65	21.54	21.53	21.61	21.61	21.61	21.70	21.69
Conducted Power (Watts)	0.1422	0.1462	0.1426	0.1422	0.1449	0.1449	0.1449	0.1479	0.1476
EIRP(dBm)	17.23	17.35	17.24	17.23	17.31	17.31	17.31	17.40	17.39
EIRP(Watts)	0.0528	0.0543	0.0530	0.0528	0.0538	0.0538	0.0538	0.0550	0.0548



LTE Band 2 (GT - LC = -4.3 dB) 64QAM									
Bandwidth	1.4M			3M			5M		
Channel	26407	26340	26683	26055	26340	26675	26065	26340	26665
	(Low)	(Mid)	(High)	(Low)	(Mid)	(High)	(Low)	(Mid)	(High)
Frequency (MHz)	1850.7	1880	1914.3	1851.5	1880	1913.5	1852.5	1880	1912.5
Conducted Power (dBm)	20.00	20.58	20.77	20.61	20.72	20.41	20.38	20.42	20.74
Conducted Power (Watts)	0.1000	0.1143	0.1194	0.1151	0.1180	0.1099	0.1091	0.1102	0.1186
EIRP(dBm)	15.70	16.28	16.47	16.31	16.42	16.11	16.08	16.12	16.44
EIRP(Watts)	0.0372	0.0425	0.0444	0.0428	0.0439	0.0408	0.0406	0.0409	0.0441

LTE Band 2 (GT - LC = -4.3 dB) 64QAM									
Bandwidth	10M			15M			20M		
Channel	26090	26340	26640	26115	26340	26615	26140	26340	26590
	(Low)	(Mid)	(High)	(Low)	(Mid)	(High)	(Low)	(Mid)	(High)
Frequency (MHz)	1855	1880	1910	1857.5	1880	1907.5	1860	1880	1905
Conducted Power (dBm)	20.61	20.72	20.44	20.61	20.72	20.45	20.71	20.82	20.55
Conducted Power (Watts)	0.1151	0.1180	0.1107	0.1151	0.1180	0.1109	0.1178	0.1208	0.1135
EIRP(dBm)	16.31	16.42	16.14	16.31	16.42	16.15	16.41	16.52	16.25
EIRP(Watts)	0.0428	0.0439	0.0411	0.0428	0.0439	0.0412	0.0438	0.0449	0.0422



LTE Band 5 (GT - LC = -6.9 dB) QPSK									
Bandwidth	1.4M			3M			5M		
Channel	20407	20525	20643	20415	20525	20635	20425	20525	20625
	(Low)	(Mid)	(High)	(Low)	(Mid)	(High)	(Low)	(Mid)	(High)
Frequency (MHz)	824.7	836.5	848.3	825.5	836.5	847.5	826.5	836.5	846.5
Conducted Power (dBm)	22.73	22.59	22.62	22.77	22.84	22.72	22.77	22.84	22.70
Conducted Power (Watts)	0.1875	0.1816	0.1828	0.1892	0.1923	0.1871	0.1892	0.1923	0.1862
ERP(dBm)	13.68	13.54	13.57	13.72	13.79	13.67	13.72	13.79	13.65
ERP(Watts)	0.0233	0.0226	0.0228	0.0236	0.0239	0.0233	0.0236	0.0239	0.0232

LTE Band 5 (GT - LC = -6.9 dB) QPSK			
Bandwidth	10M		
Channel	20450	20525	20600
	(Low)	(Mid)	(High)
Frequency (MHz)	829	836.5	844
Conducted Power (dBm)	22.83	22.88	22.75
Conducted Power (Watts)	0.1919	0.1941	0.1884
ERP(dBm)	13.78	13.83	13.70
ERP(Watts)	0.0239	0.0242	0.0234



LTE Band 5 (GT - LC = -6.9 dB) 16QAM									
Bandwidth	1.4M			3M			5M		
Channel	20407	20525	20643	20415	20525	20635	20425	20525	20625
	(Low)	(Mid)	(High)	(Low)	(Mid)	(High)	(Low)	(Mid)	(High)
Frequency	824.7	836.5	848.3	825.5	836.5	847.5	826.5	836.5	846.5
(MHz)									
Conducted Power (dBm)	22.31	21.84	22.15	22.12	21.97	21.82	22.08	21.88	21.87
Conducted Power (Watts)	0.1702	0.1528	0.1641	0.1629	0.1574	0.1521	0.1614	0.1542	0.1538
ERP(dBm)	13.26	12.79	13.10	13.07	12.92	12.77	13.03	12.83	12.82
ERP(Watts)	0.0212	0.0190	0.0204	0.0203	0.0196	0.0189	0.0201	0.0192	0.0191

LTE Band 5 (GT - LC = -6.9 dB) 16QAM			
Bandwidth	10M		
Channel	20450	20525	20600
	(Low)	(Mid)	(High)
Frequency	829	836.5	844
(MHz)			
Conducted Power (dBm)	22.17	21.98	21.89
Conducted Power (Watts)	0.1648	0.1578	0.1545
ERP(dBm)	13.12	12.93	12.84
ERP(Watts)	0.0205	0.0196	0.0192



LTE Band 5 (GT - LC = -6.9 dB) 64QAM									
Bandwidth	1.4M			3M			5M		
Channel	20407	20525	20643	20415	20525	20635	20425	20525	20625
	(Low)	(Mid)	(High)	(Low)	(Mid)	(High)	(Low)	(Mid)	(High)
Frequency	824.7	836.5	848.3	825.5	836.5	847.5	826.5	836.5	846.5
(MHz)									
Conducted Power (dBm)	20.66	20.87	20.77	20.66	21.05	20.76	20.65	21.11	20.74
Conducted Power (Watts)	0.1164	0.1222	0.1194	0.1164	0.1274	0.1191	0.1161	0.1291	0.1186
ERP(dBm)	11.61	11.82	11.72	11.61	12.00	11.71	11.60	12.06	11.69
ERP(Watts)	0.0145	0.0152	0.0149	0.0145	0.0158	0.0148	0.0145	0.0161	0.0148

LTE Band 5 (GT - LC = -6.9 dB) 64QAM			
Bandwidth	10M		
Channel	20450	20525	20600
	(Low)	(Mid)	(High)
Frequency	829	836.5	844
(MHz)			
Conducted Power (dBm)	20.71	21.15	20.79
Conducted Power (Watts)	0.1178	0.1303	0.1199
ERP(dBm)	11.66	12.10	11.74
ERP(Watts)	0.0147	0.0162	0.0149



LTE Band 2

Peak-to-Average Ratio

Mode	LTE Band 2 / 20MHz			
Mod.	QPSK	16QAM	64QAM	Limit: 13dB
RB Size	Full RB	Full RB	Full RB	Result
Middle CH	5.10	6.06	6.29	PASS

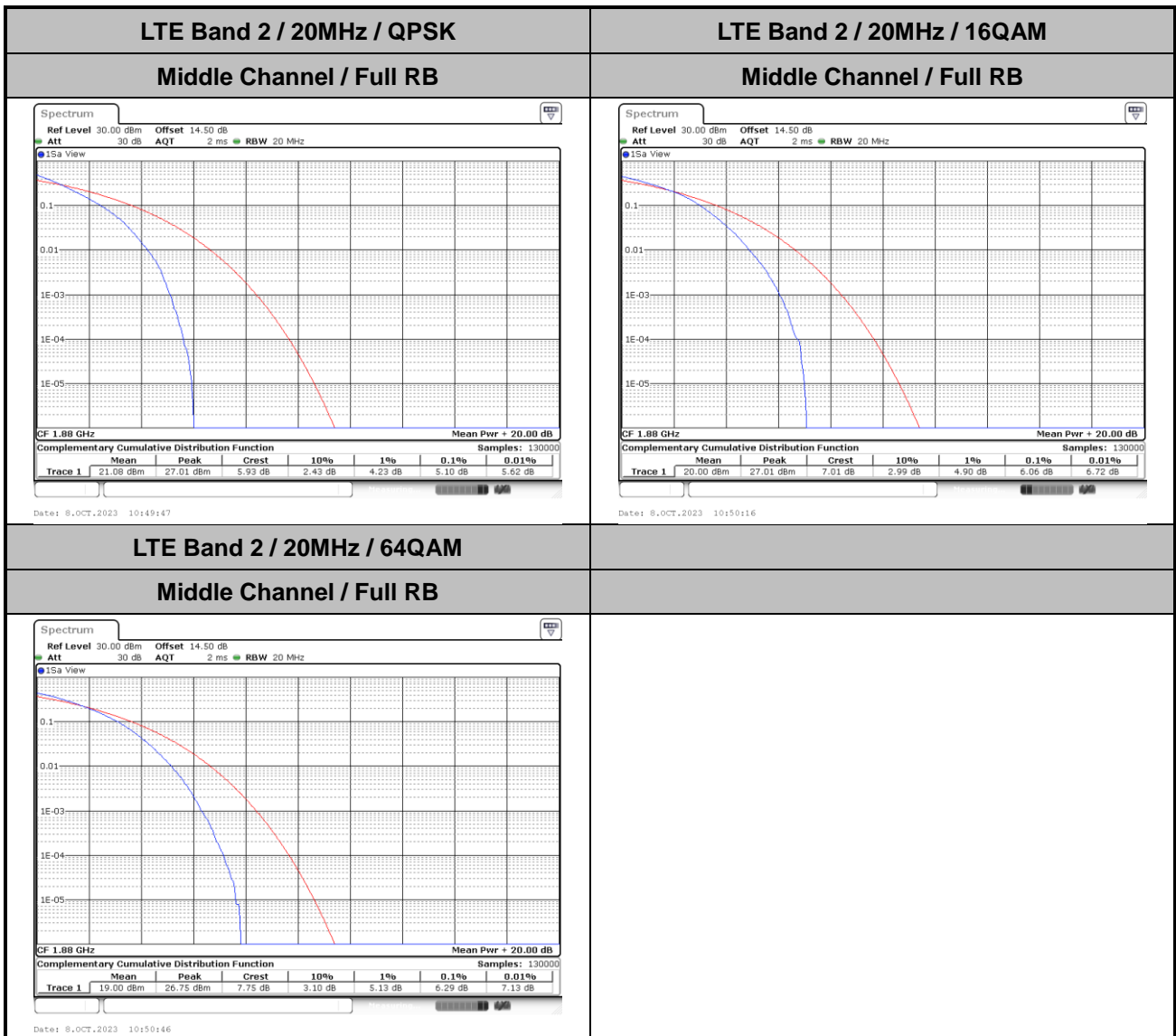



26dB Bandwidth

Mode	LTE Band 2 : 26dB BW(MHz)											
	1.4MHz		3MHz		5MHz		10MHz		15MHz		20MHz	
BW												
Mod.	QPSK	16QAM	QPSK	16QAM	QPSK	16QAM	QPSK	16QAM	QPSK	16QAM	QPSK	16QAM
Middle CH	1.29	1.29	3.03	3.02	4.98	4.95	9.73	9.87	14.12	14.57	18.86	18.82



LTE Band 2

Middle Channel / 1.4MHz / QPSK

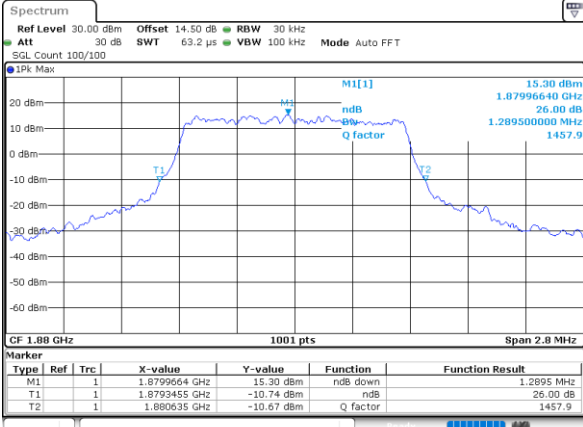

Date: 8.OCT.2023 09:13:48

Middle Channel / 1.4MHz / 16QAM

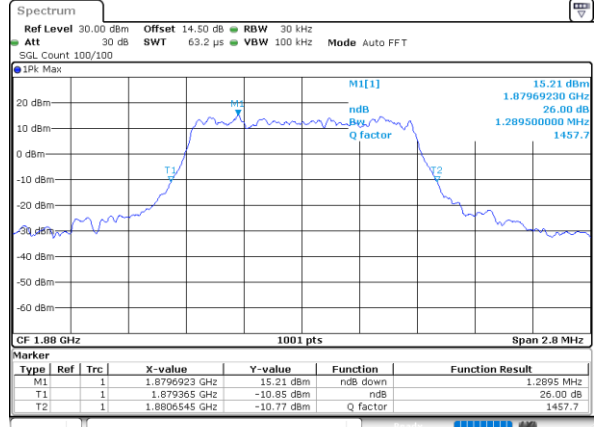

Date: 8.OCT.2023 09:13:30

Middle Channel / 3MHz / QPSK

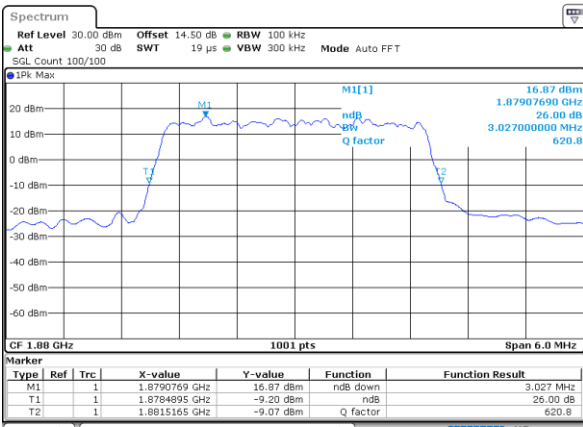

Date: 8.OCT.2023 09:14:04

Middle Channel / 3MHz / 16QAM

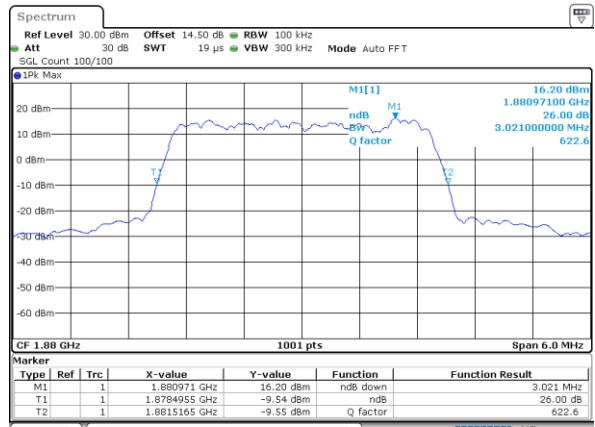

Date: 8.OCT.2023 09:14:46

Middle Channel / 5MHz / QPSK

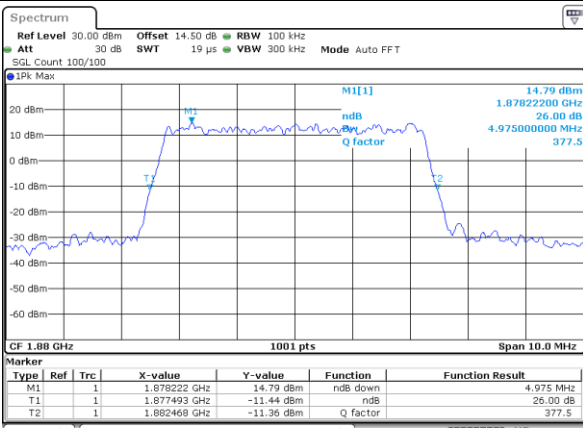

Date: 8.OCT.2023 10:07:40

Middle Channel / 5MHz / 16QAM

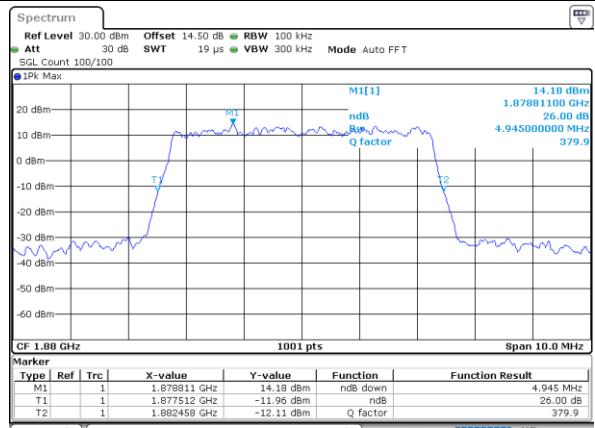

Date: 8.OCT.2023 10:08:23



LTE Band 2

Middle Channel / 10MHz / QPSK

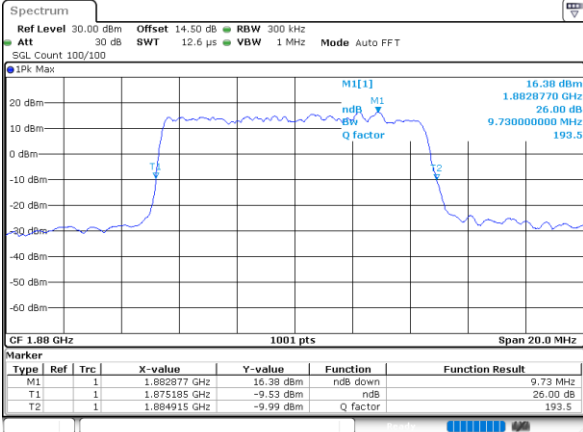

Date: 8.OCT.2023 10:21:22

Middle Channel / 10MHz / 16QAM

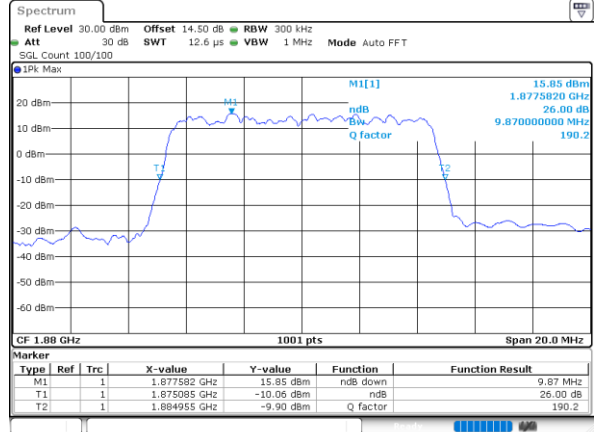

Date: 8.OCT.2023 10:22:04

Middle Channel / 15MHz / QPSK

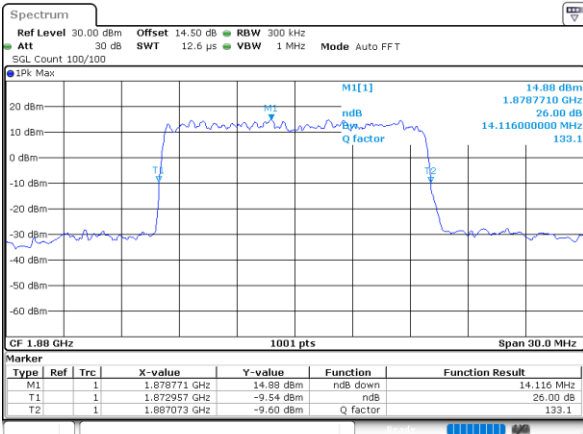

Date: 8.OCT.2023 10:24:58

Middle Channel / 15MHz / 16QAM

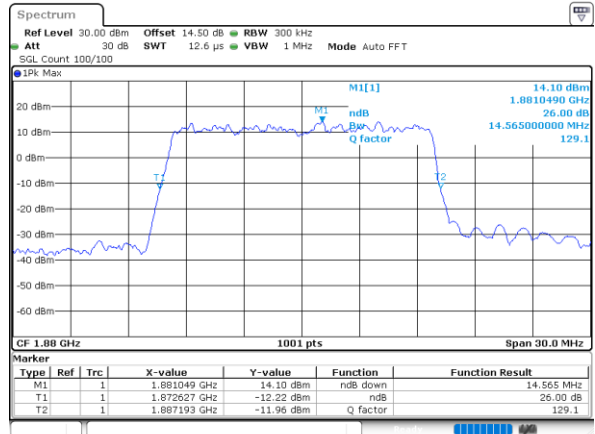

Date: 8.OCT.2023 10:25:40

Middle Channel / 20MHz / QPSK

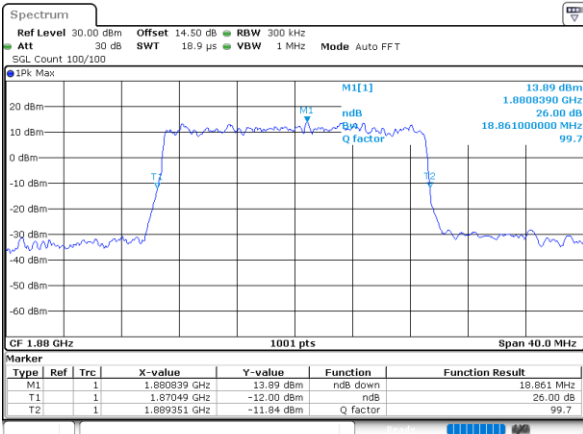

Date: 8.OCT.2023 10:48:36

Middle Channel / 20MHz / 16QAM

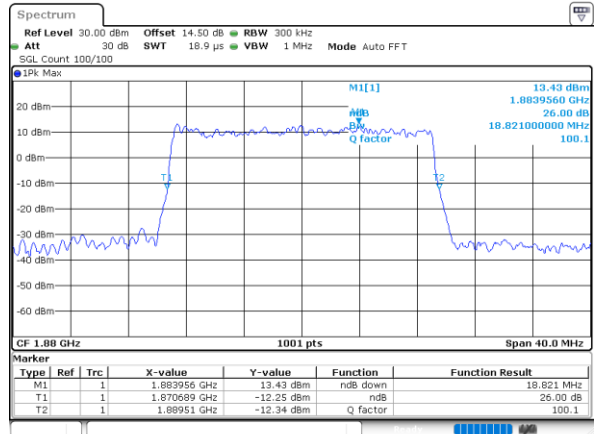

Date: 8.OCT.2023 10:49:18



Occupied Bandwidth

Mode	LTE Band 2 : 99%OBW(MHz)											
	1.4MHz		3MHz		5MHz		10MHz		15MHz		20MHz	
Mod.	QPSK	16QAM	QPSK	16QAM	QPSK	16QAM	QPSK	16QAM	QPSK	16QAM	QPSK	16QAM
Middle CH	1.09	1.09	2.71	2.72	4.51	4.48	8.99	8.97	13.46	13.43	17.86	17.82



LTE Band 2

Middle Channel / 1.4MHz / QPSK

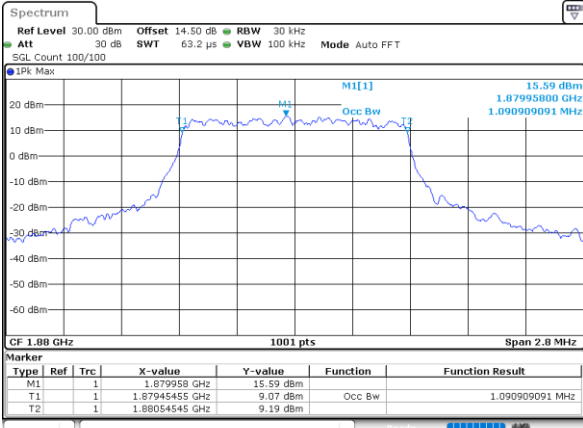

Date: 8.OCT.2023 09:13:14

Middle Channel / 1.4MHz / 16QAM

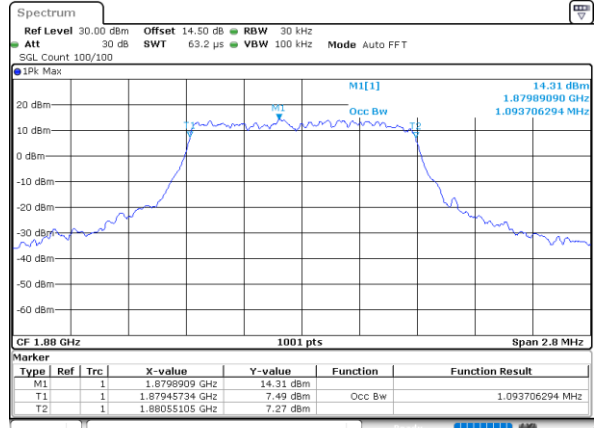

Date: 8.OCT.2023 09:13:16

Middle Channel / 3MHz / QPSK

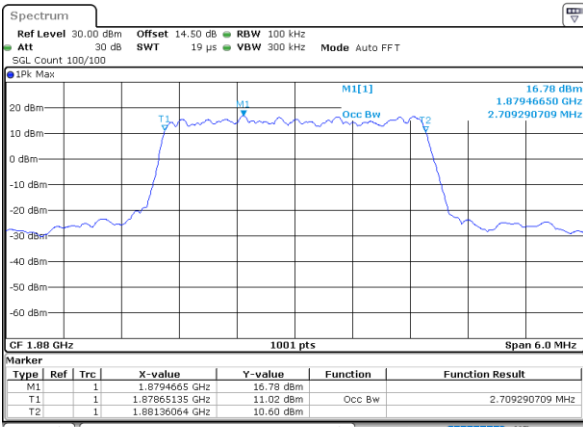

Date: 8.OCT.2023 09:13:50

Middle Channel / 3MHz / 16QAM

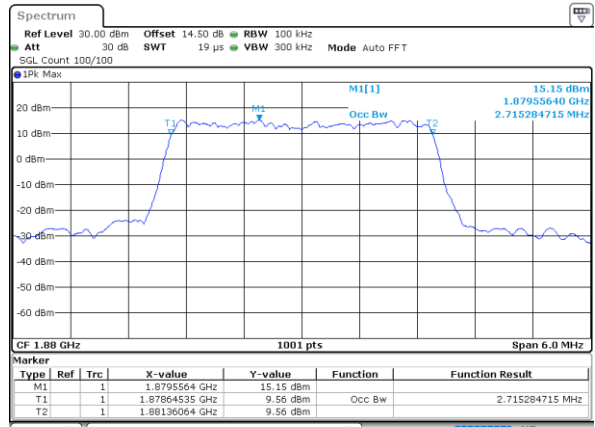

Date: 8.OCT.2023 09:14:32

Middle Channel / 5MHz / QPSK

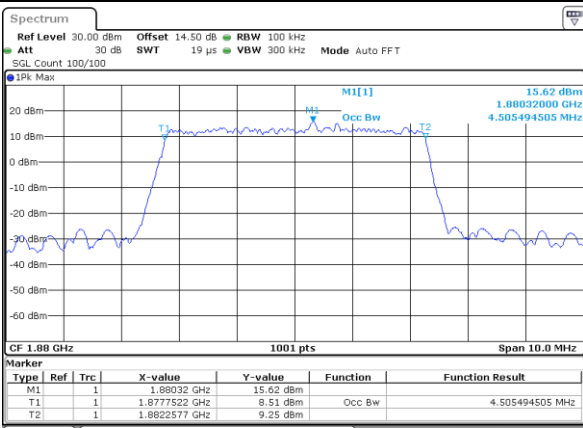

Date: 8.OCT.2023 10:07:27

Middle Channel / 5MHz / 16QAM

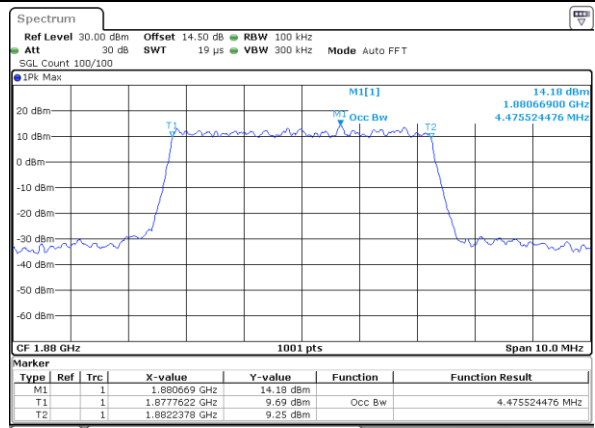

Date: 8.OCT.2023 10:08:09



LTE Band 2

Middle Channel / 10MHz / QPSK

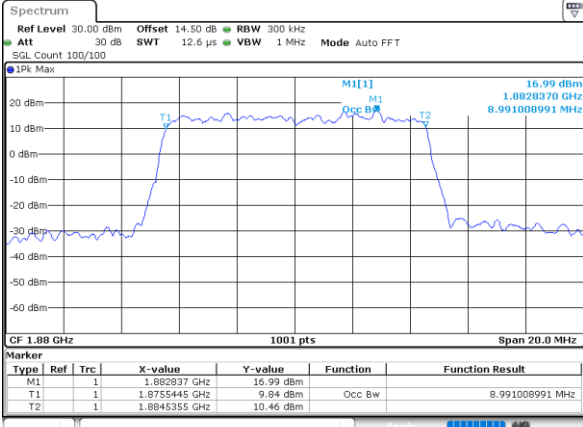

Date: 8.OCT.2023 10:21:08

Middle Channel / 10MHz / 16QAM

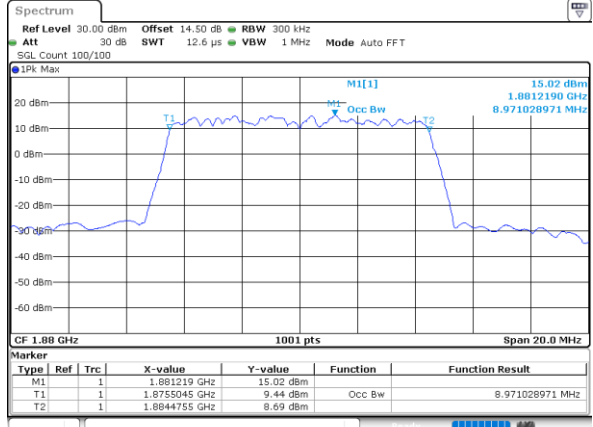

Date: 8.OCT.2023 10:21:50

Middle Channel / 15MHz / QPSK

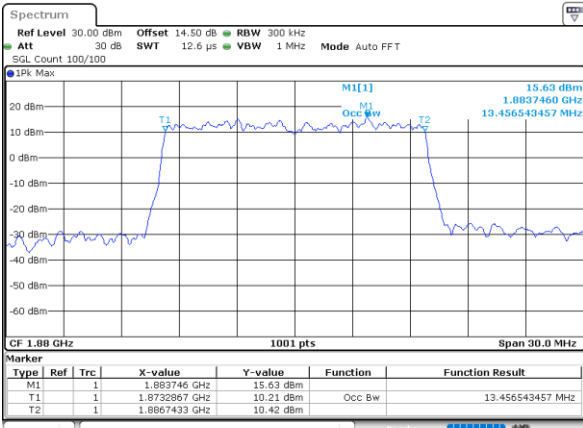

Date: 8.OCT.2023 10:34:44

Middle Channel / 15MHz / 16QAM

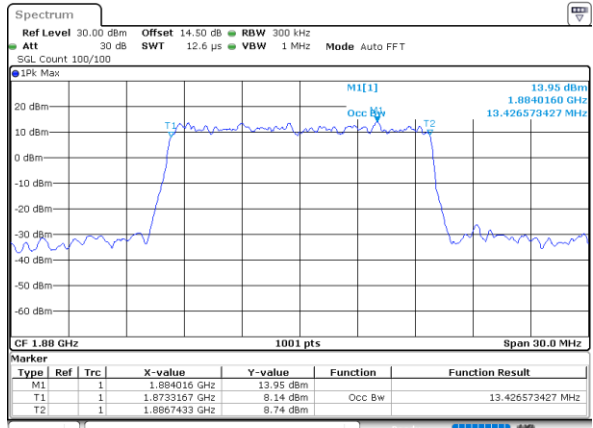

Date: 8.OCT.2023 10:35:26

Middle Channel / 20MHz / QPSK

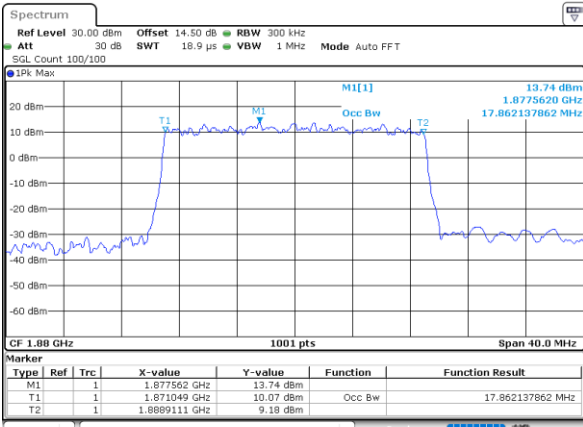

Date: 8.OCT.2023 10:48:22

Middle Channel / 20MHz / 16QAM

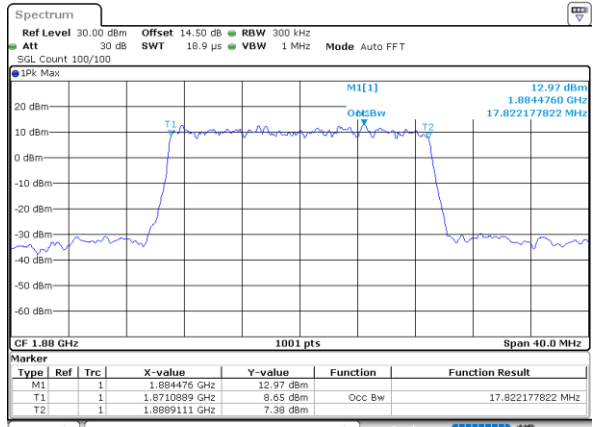

Date: 8.OCT.2023 10:49:04



Conducted Band Edge

LTE Band 2 / 1.4MHz / QPSK

Lowest Band Edge / 1RB

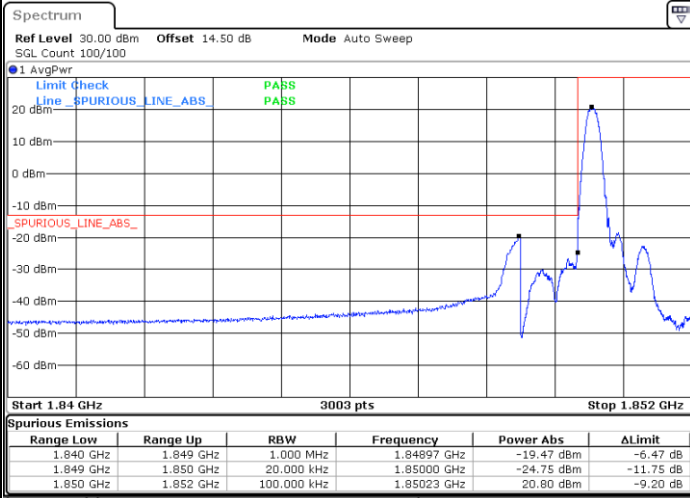

Date: 8.OCT.2023 09:30:09

Highest Band Edge / 1RB

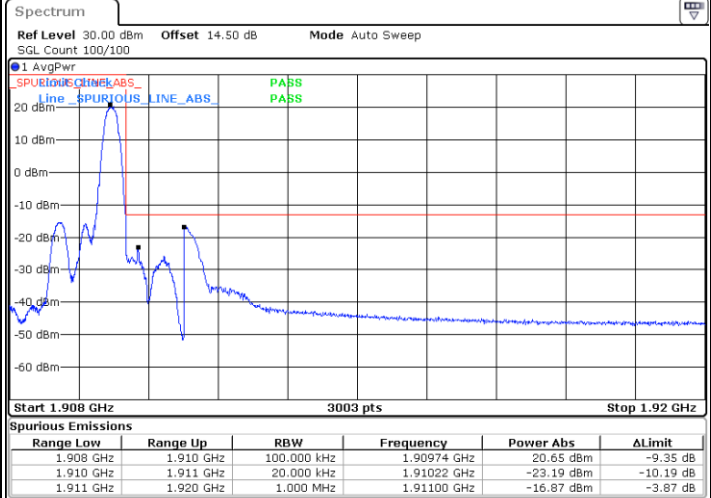

Date: 8.OCT.2023 09:41:52

Lowest Band Edge / Full RB

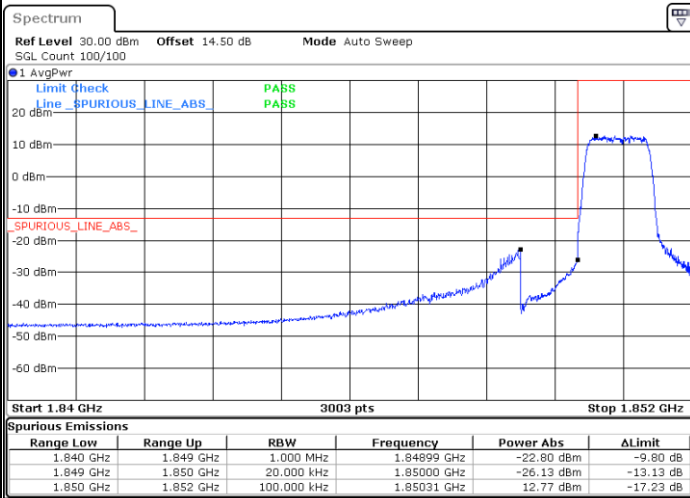

Date: 8.OCT.2023 09:33:30

Highest Band Edge / Full RB

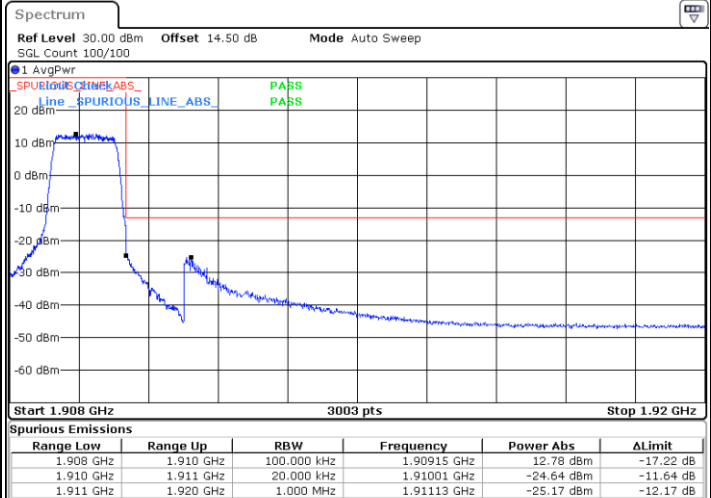

Date: 8.OCT.2023 09:45:12



LTE Band 2 / 1.4MHz / 16QAM

Lowest Band Edge / 1 RB

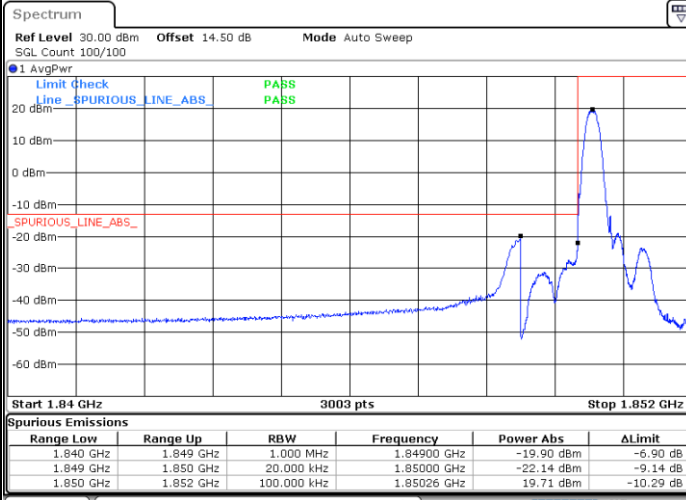

Date: 8.OCT.2023 09:30:52

Highest Band Edge / 1 RB

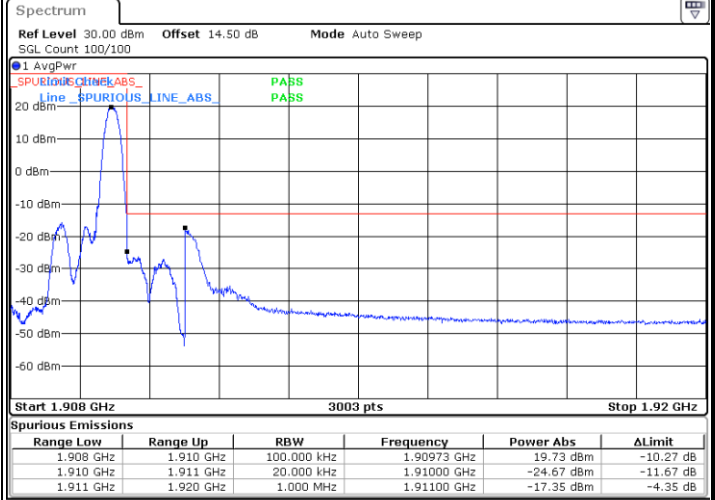

Date: 8.OCT.2023 09:42:35

Lowest Band Edge / Full RB

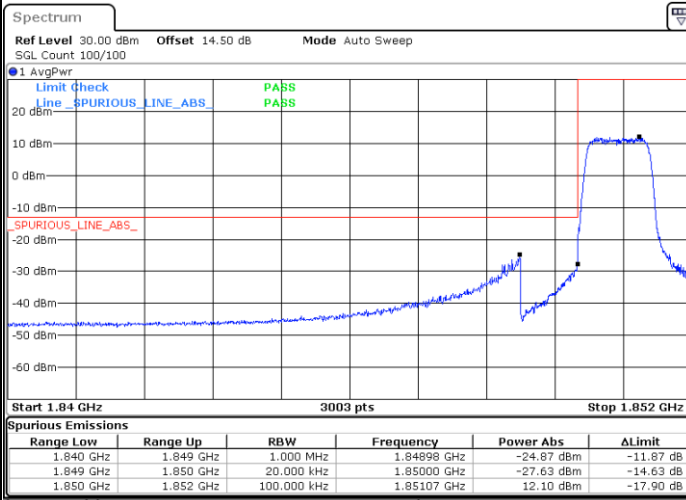

Date: 8.OCT.2023 09:34:14

Highest Band Edge / Full RB

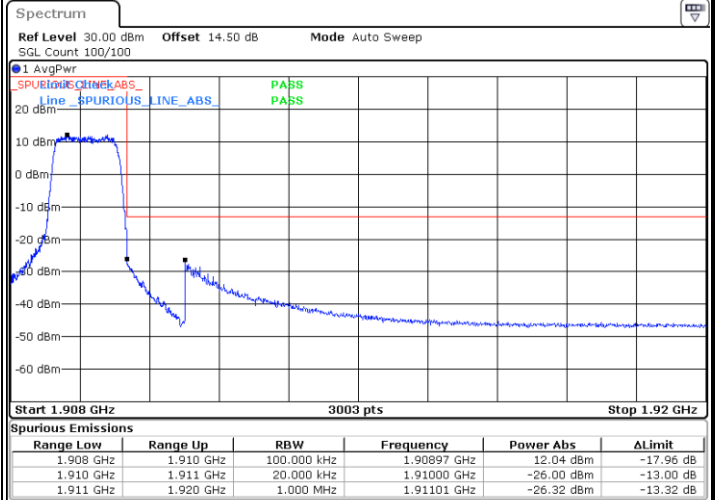

Date: 8.OCT.2023 09:45:55



LTE Band 2 / 1.4MHz / 64QAM

Lowest Band Edge / 1 RB

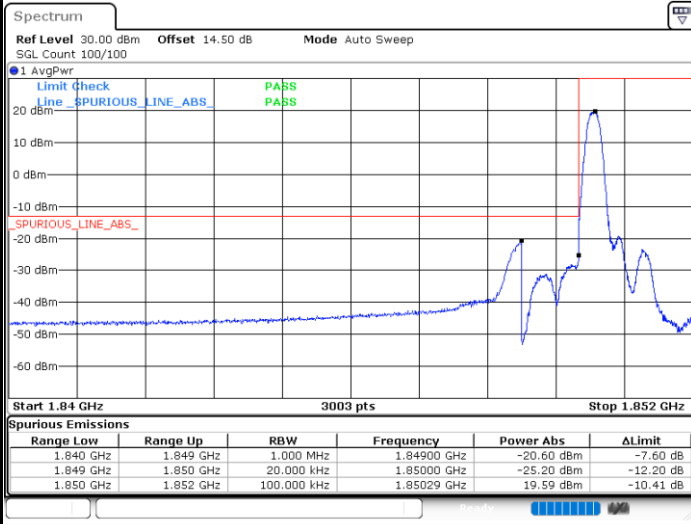

Highest Band Edge / 1 RB

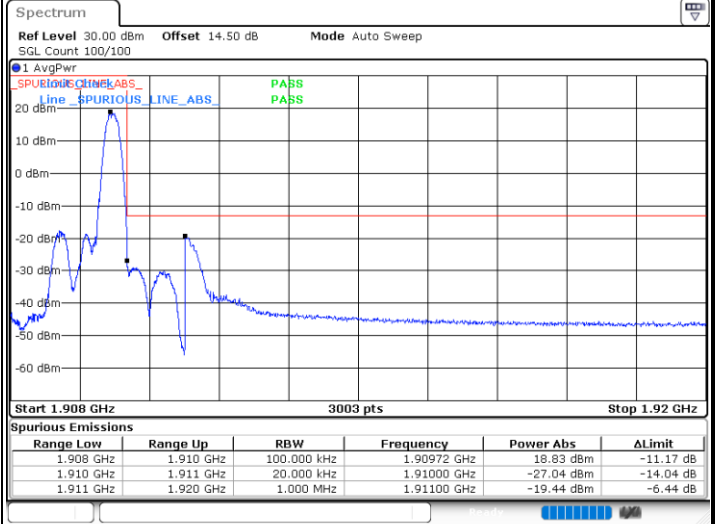

Lowest Band Edge / Full RB

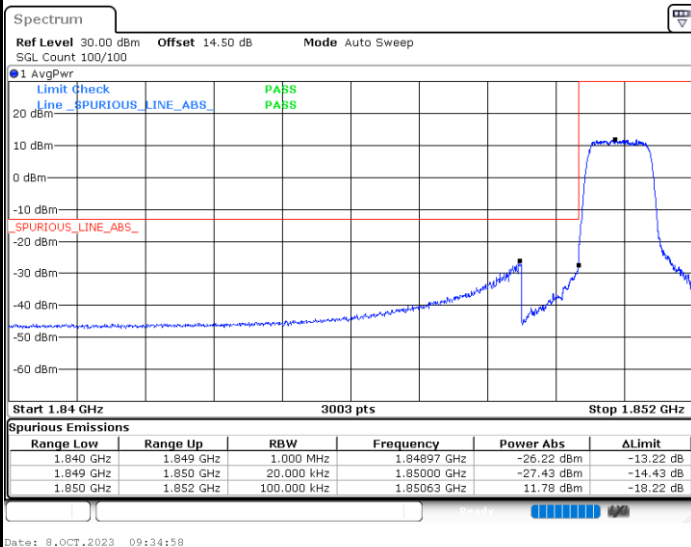

Highest Band Edge / Full RB

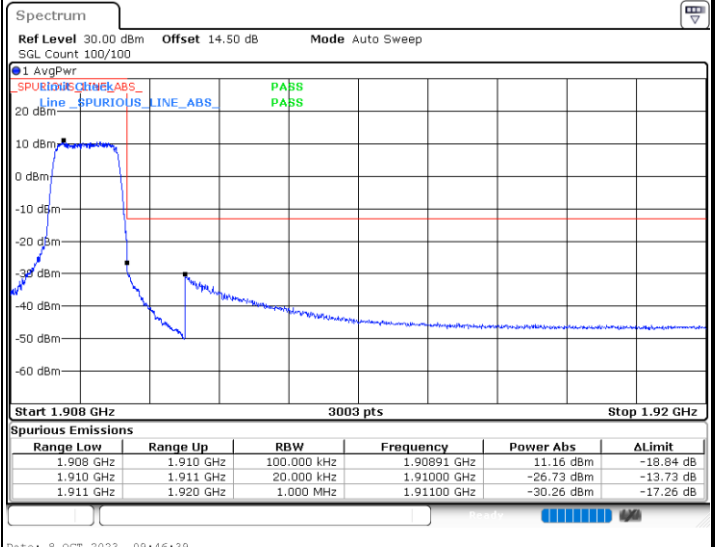



LTE Band 2 / 3MHz / QPSK

Lowest Band Edge / 1RB

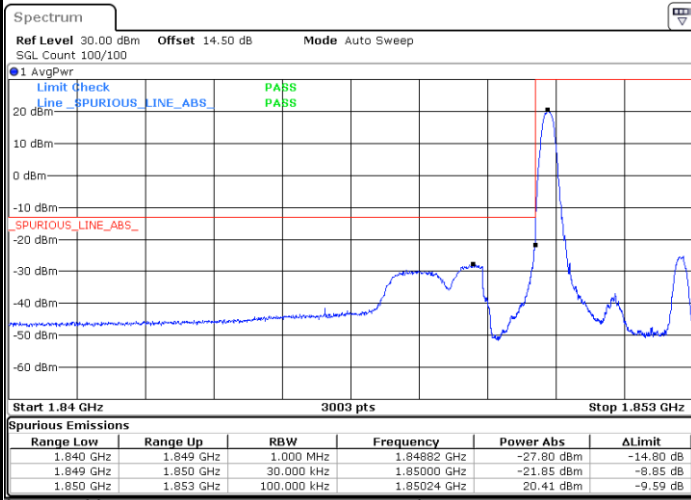

Date: 8.OCT.2023 09:47:25

Highest Band Edge / 1RB

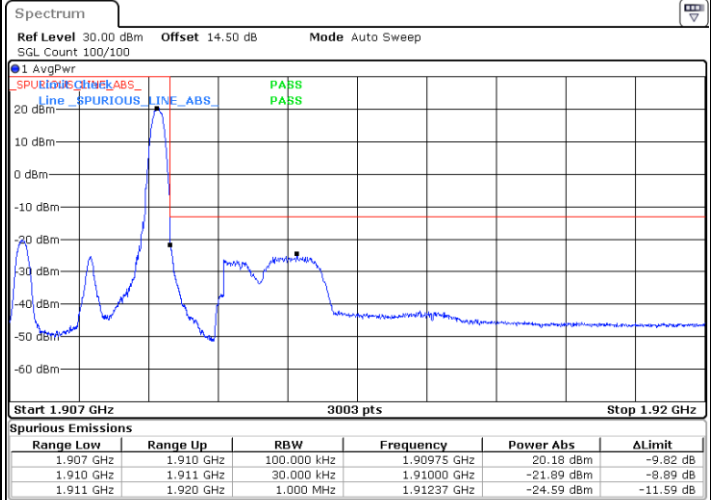

Date: 8.OCT.2023 09:55:28

Lowest Band Edge / Full RB

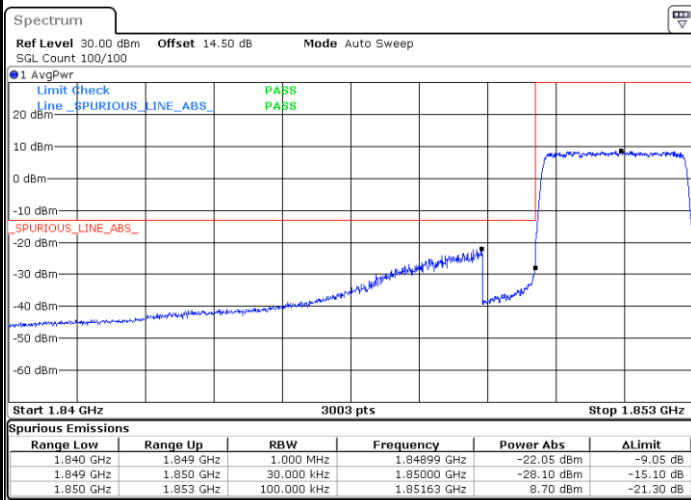

Date: 8.OCT.2023 09:50:44

Highest Band Edge / Full RB

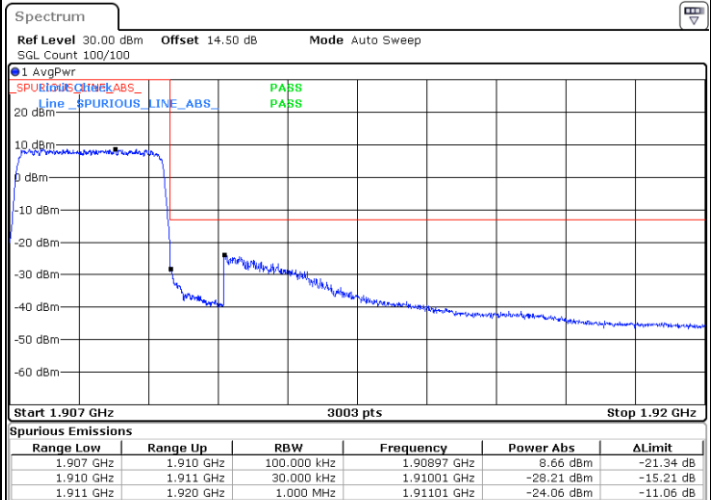

Date: 8.OCT.2023 09:57:39



LTE Band 2 / 3MHz / 16QAM

Lowest Band Edge / 1 RB

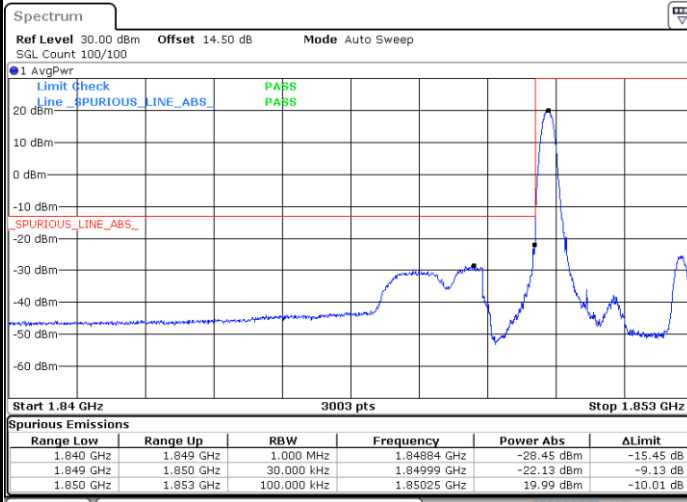

Date: 8.OCT.2023 09:48:08

Highest Band Edge / 1 RB

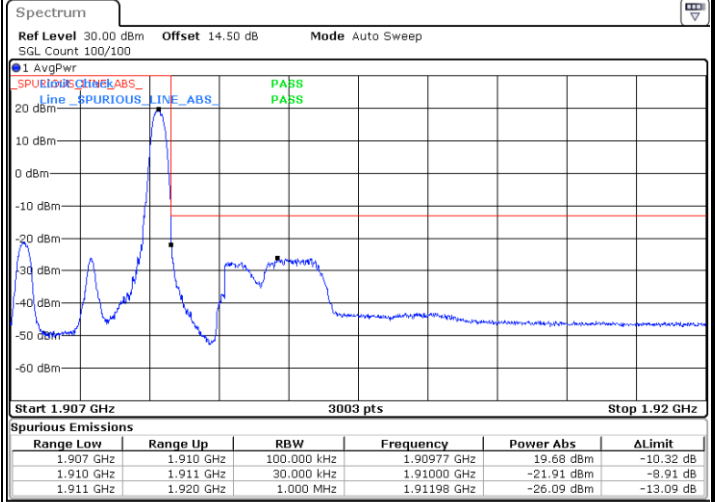

Date: 8.OCT.2023 09:56:12

Lowest Band Edge / Full RB

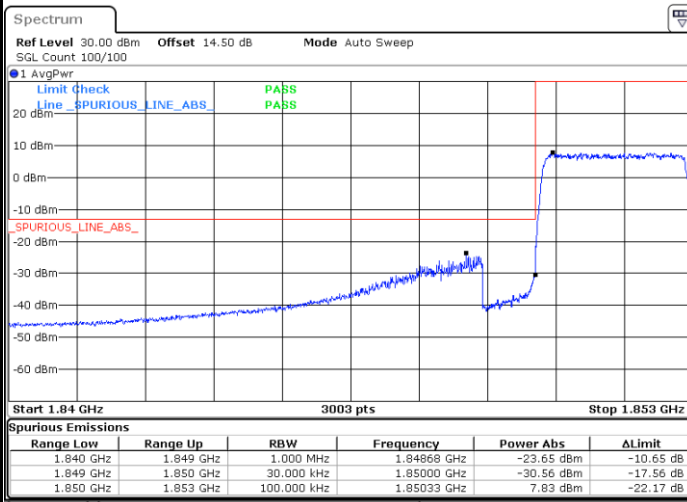

Date: 8.OCT.2023 09:51:27

Highest Band Edge / Full RB

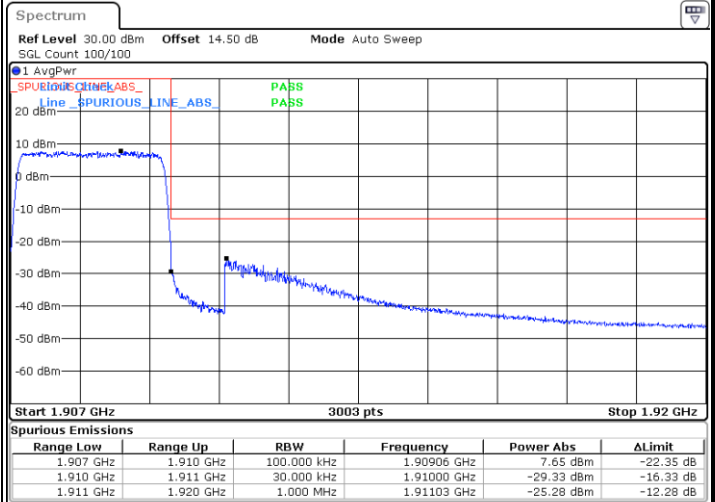

Date: 8.OCT.2023 09:58:23



LTE Band 2 / 3MHz / 64QAM

Lowest Band Edge / 1 RB

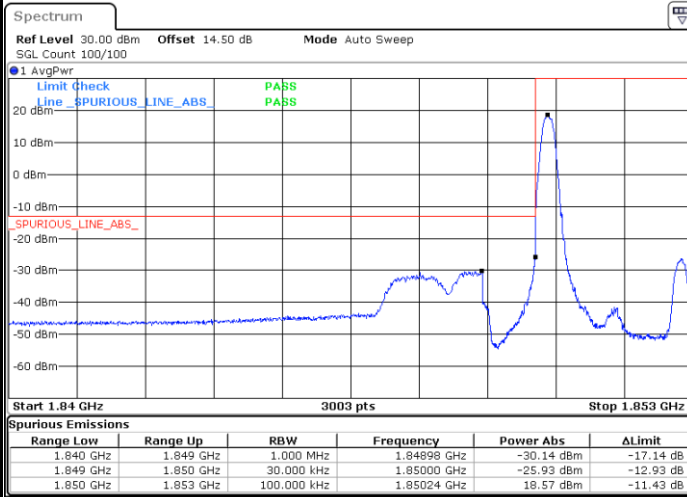

Date: 8.OCT.2023 09:48:52

Highest Band Edge / 1 RB

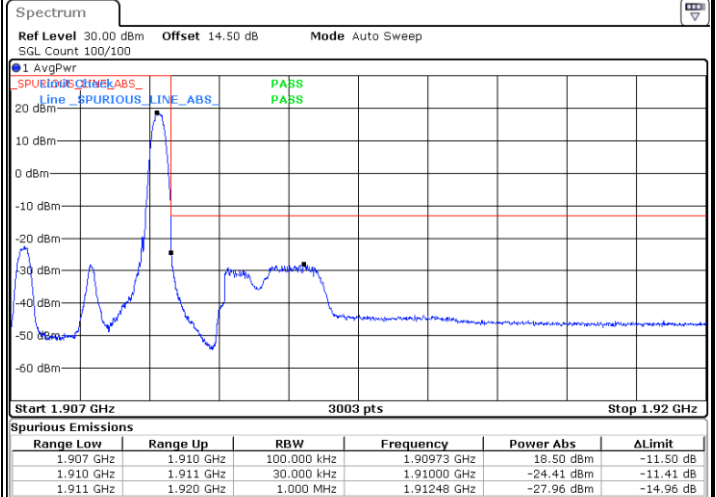

Date: 8.OCT.2023 09:56:56

Lowest Band Edge / Full RB

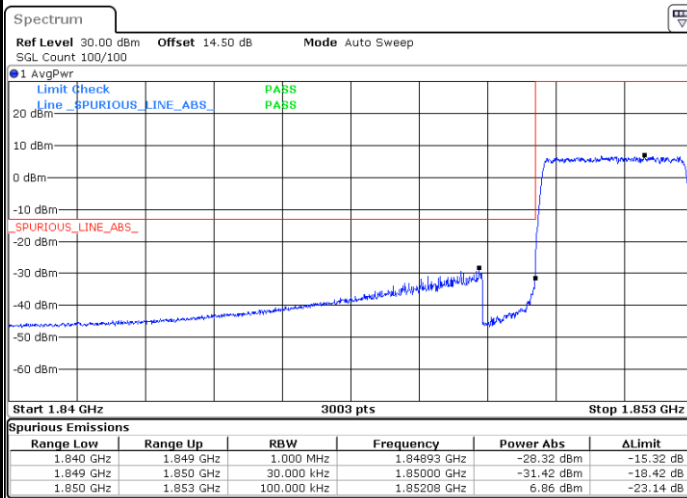

Date: 8.OCT.2023 09:52:12

Highest Band Edge / Full RB

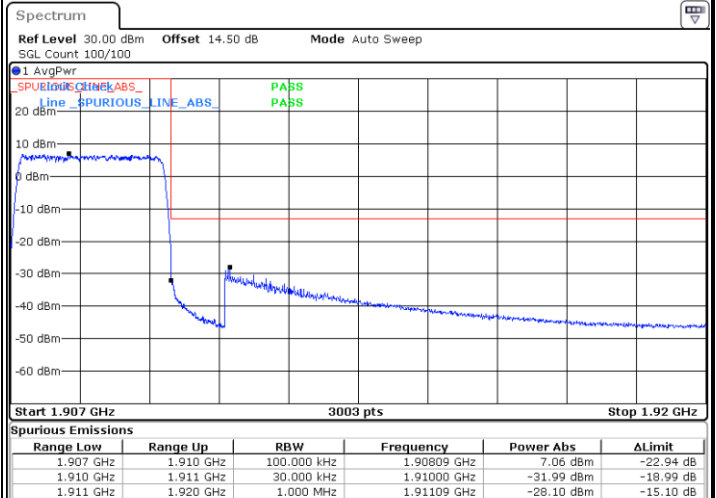

Date: 8.OCT.2023 09:59:06



LTE Band 2 / 5MHz / QPSK

Lowest Band Edge / 1RB

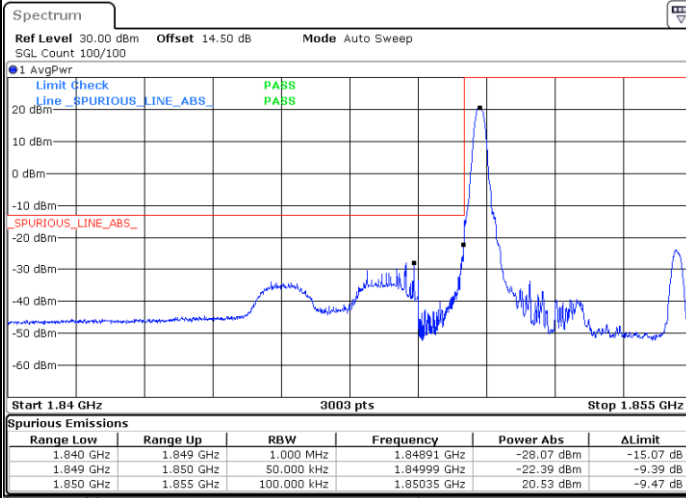

Date: 8.OCT.2023 10:01:00

Highest Band Edge / 1RB

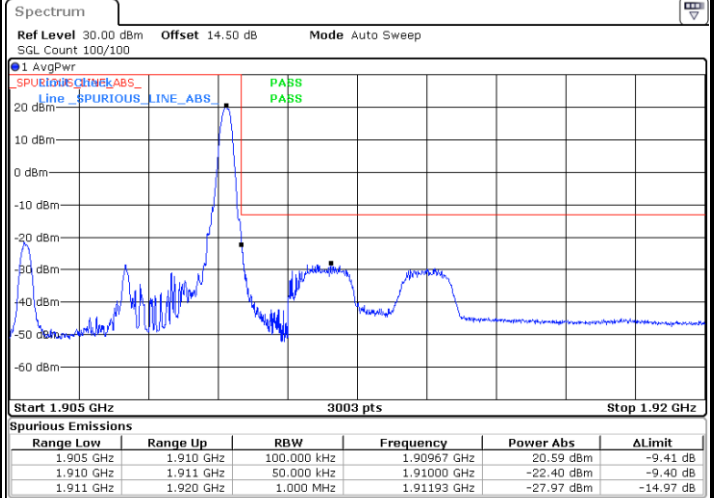

Date: 8.OCT.2023 10:09:06

Lowest Band Edge / Full RB

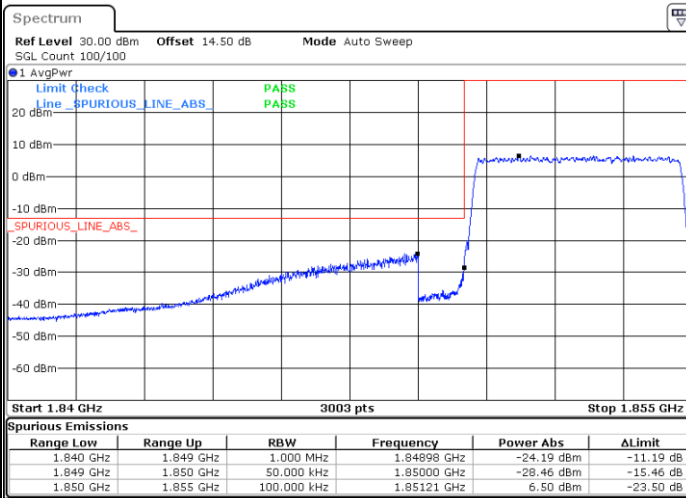

Date: 8.OCT.2023 10:04:20

Highest Band Edge / Full RB

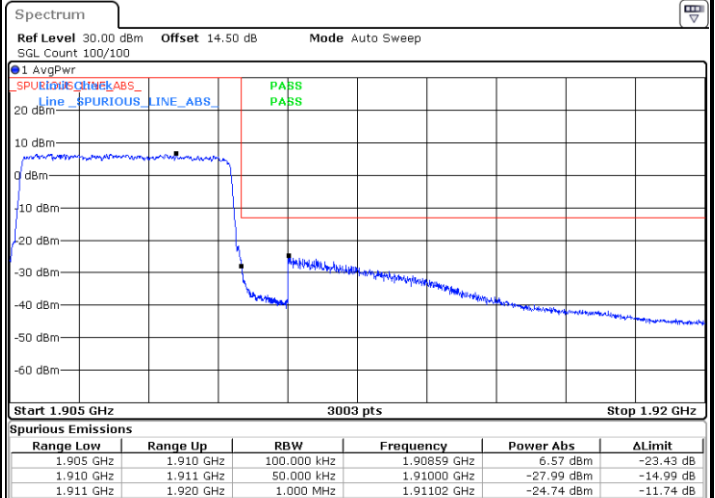

Date: 8.OCT.2023 10:11:17



LTE Band 2 / 5MHz / 16QAM

Lowest Band Edge / 1 RB

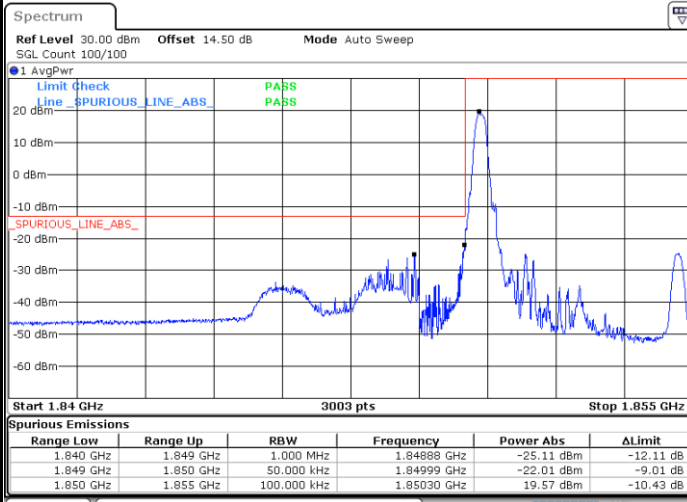

Date: 8.OCT.2023 10:01:44

Highest Band Edge / 1 RB



Date: 8.OCT.2023 10:09:50

Lowest Band Edge / Full RB

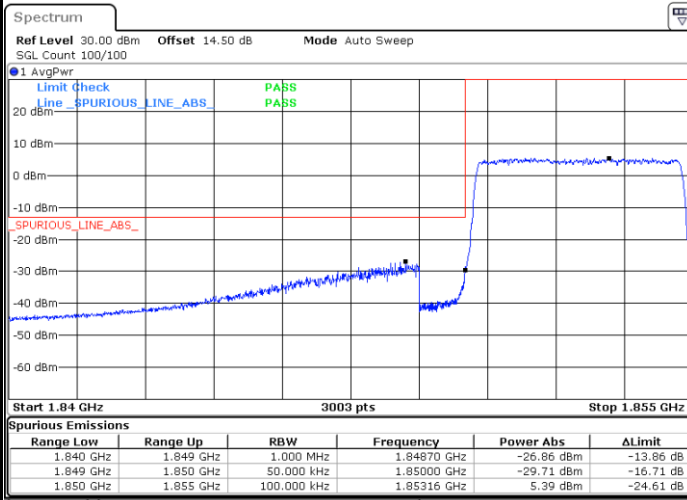

Date: 8.OCT.2023 10:05:04

Highest Band Edge / Full RB

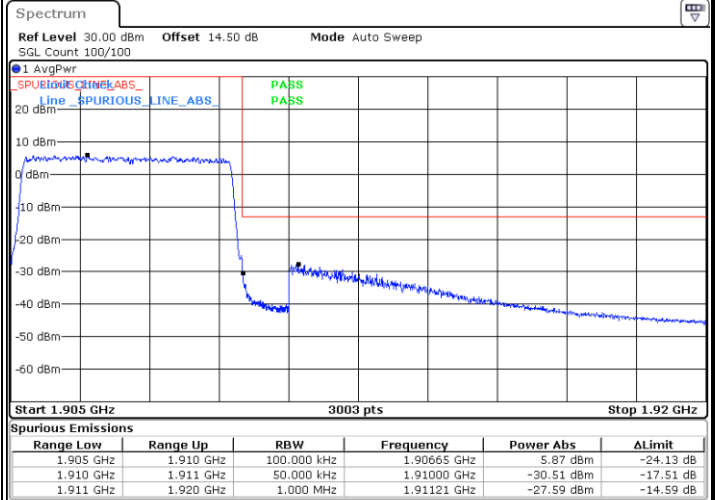

Date: 8.OCT.2023 10:12:02



LTE Band 2 / 5MHz / 64QAM

Lowest Band Edge / 1 RB

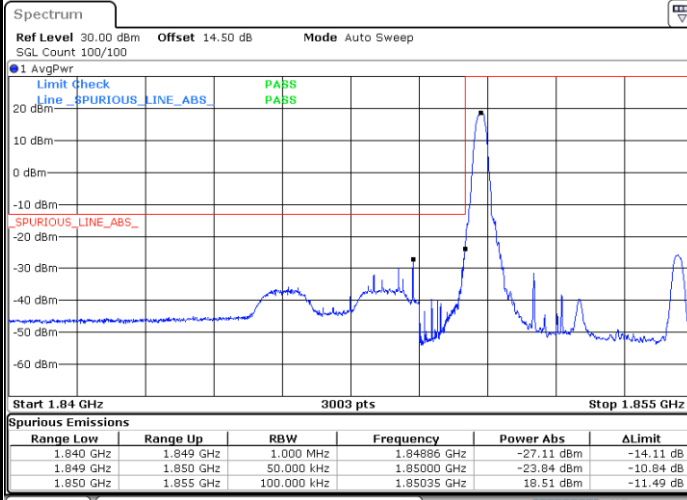

Date: 8.OCT.2023 10:02:28

Highest Band Edge / 1 RB

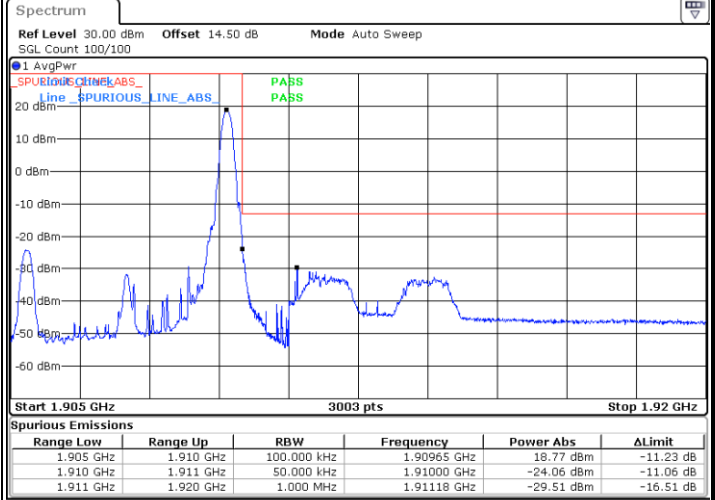

Date: 8.OCT.2023 10:10:34

Lowest Band Edge / Full RB

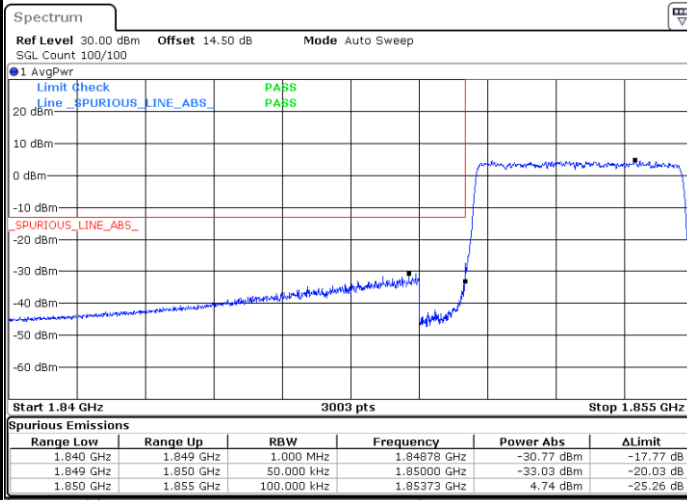

Date: 8.OCT.2023 10:05:47

Highest Band Edge / Full RB

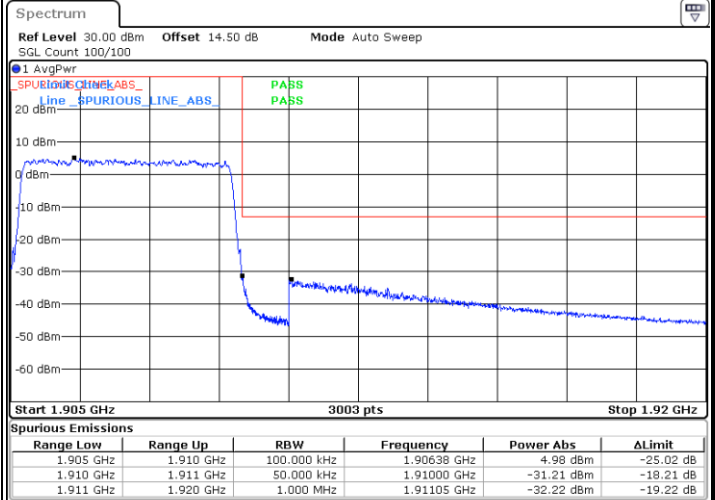

Date: 8.OCT.2023 10:12:46



LTE Band 2 / 10MHz / QPSK

Lowest Band Edge / 1RB

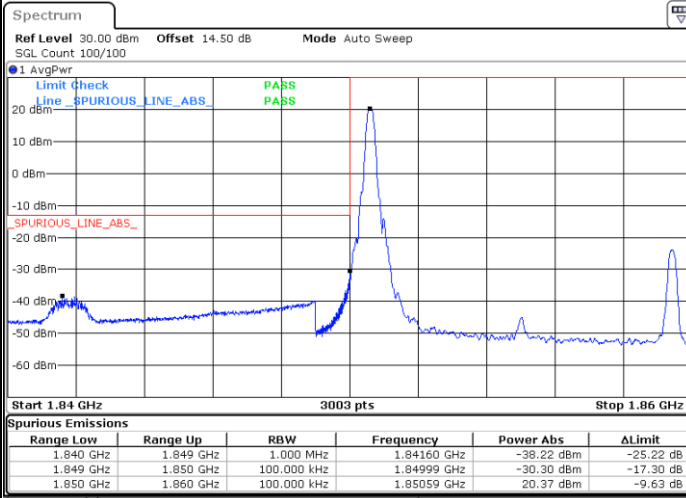

Date: 8.OCT.2023 10:14:42

Highest Band Edge / 1RB

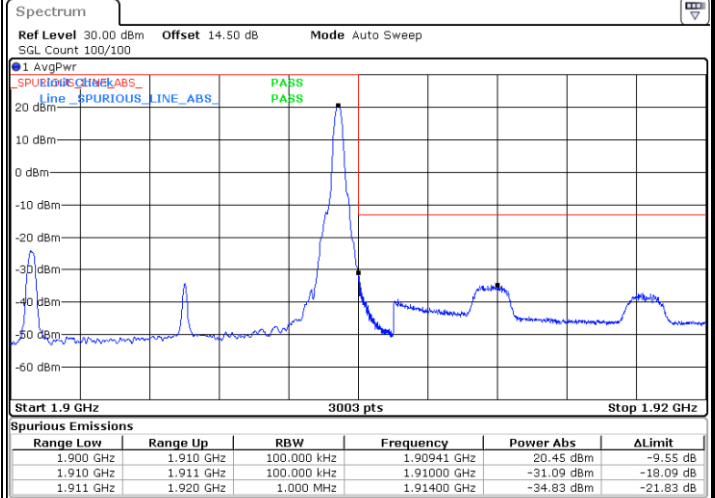

Date: 8.OCT.2023 10:22:47

Lowest Band Edge / Full RB

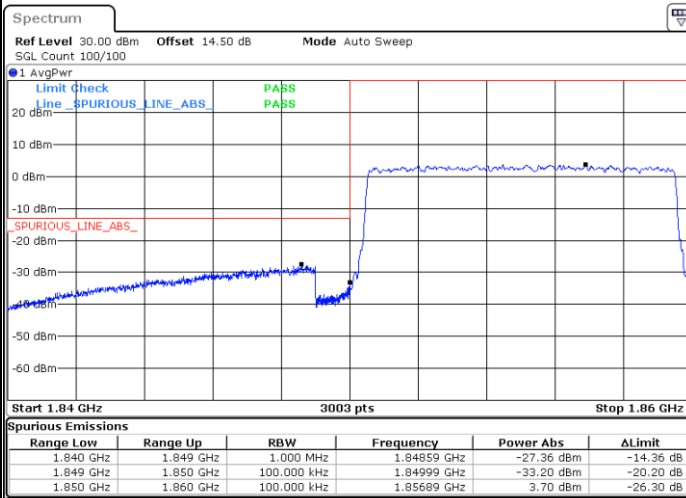

Date: 8.OCT.2023 10:16:53

Highest Band Edge / Full RB

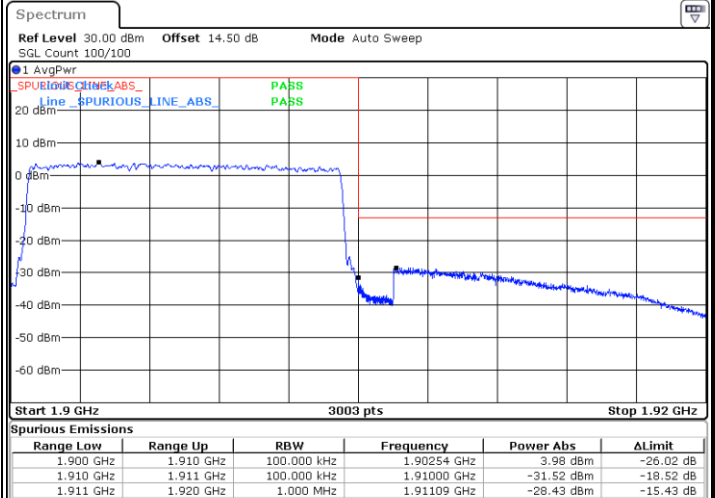

Date: 8.OCT.2023 10:24:58



LTE Band 2 / 10MHz / 16QAM

Lowest Band Edge / 1 RB

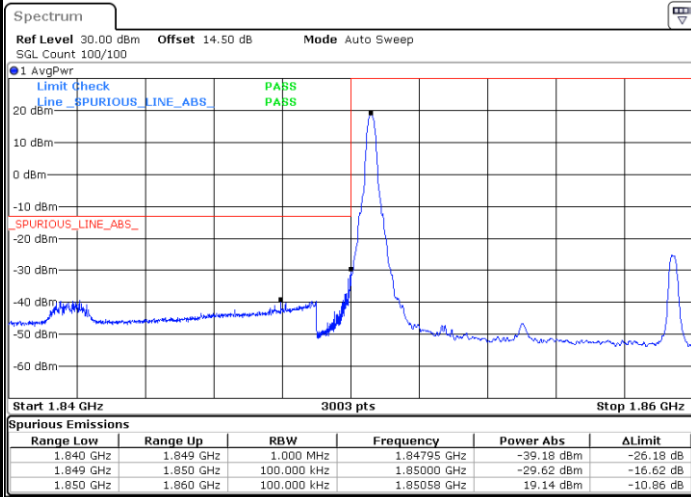

Date: 8.OCT.2023 10:15:26

Highest Band Edge / 1 RB

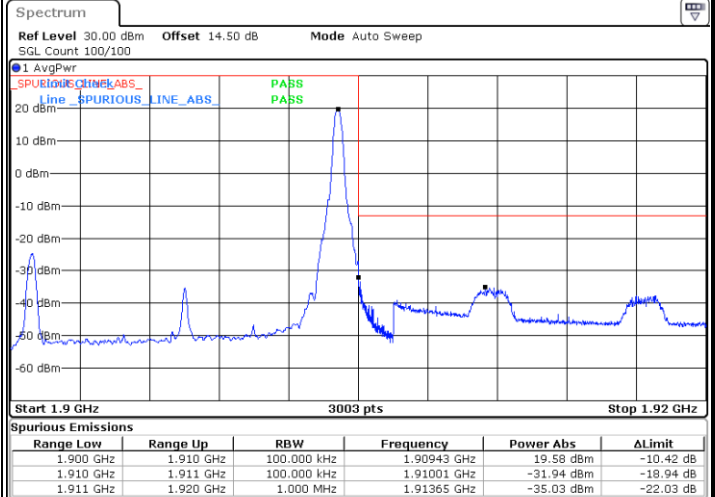

Date: 8.OCT.2023 10:23:30

Lowest Band Edge / Full RB

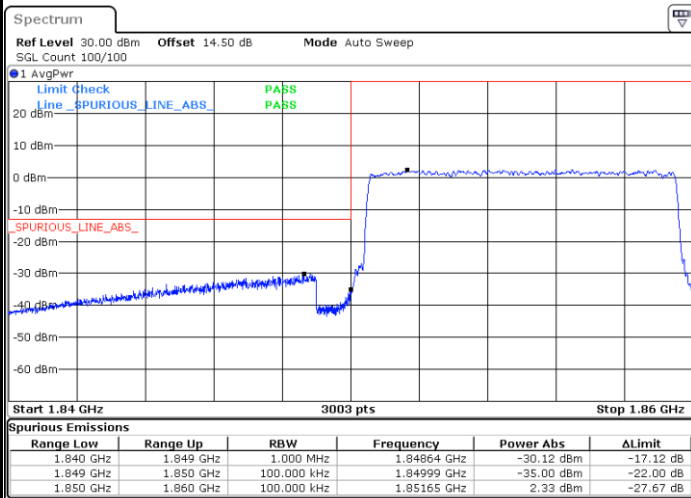

Date: 8.OCT.2023 10:17:38

Highest Band Edge / Full RB

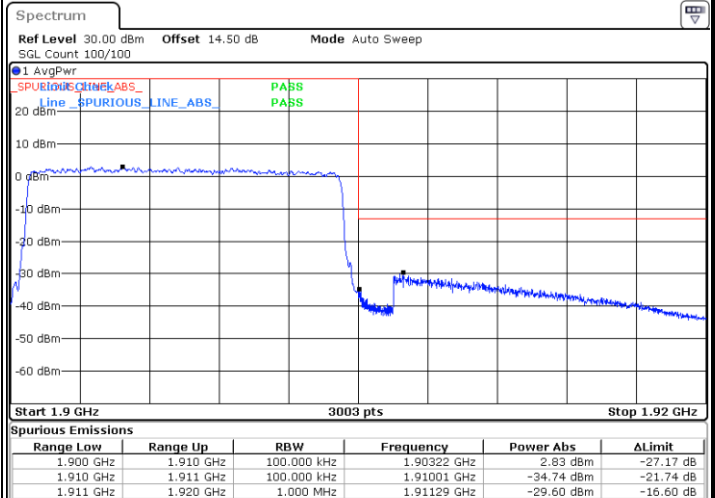

Date: 8.OCT.2023 10:25:42



LTE Band 2 / 10MHz / 64QAM

Lowest Band Edge / 1 RB

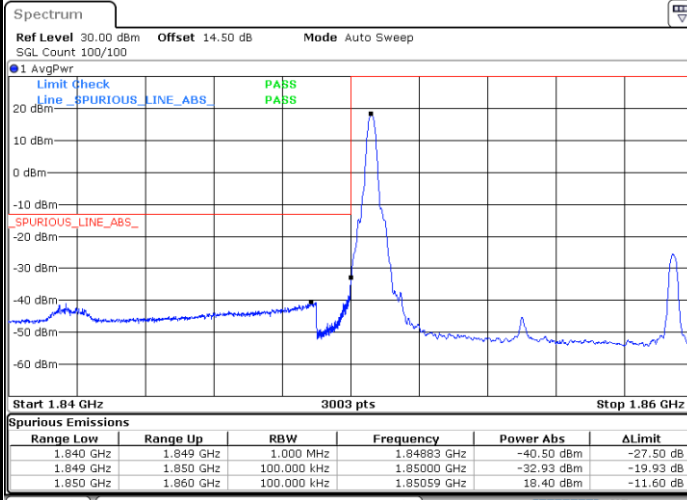

Date: 8.OCT.2023 10:16:09

Highest Band Edge / 1 RB

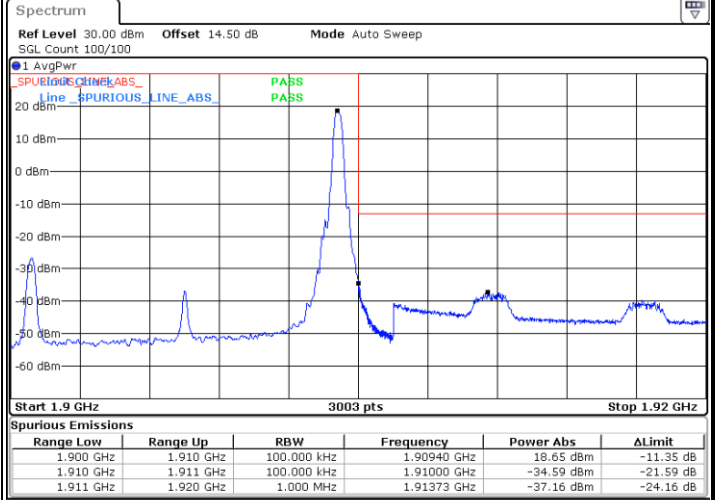

Date: 8.OCT.2023 10:24:14

Lowest Band Edge / Full RB

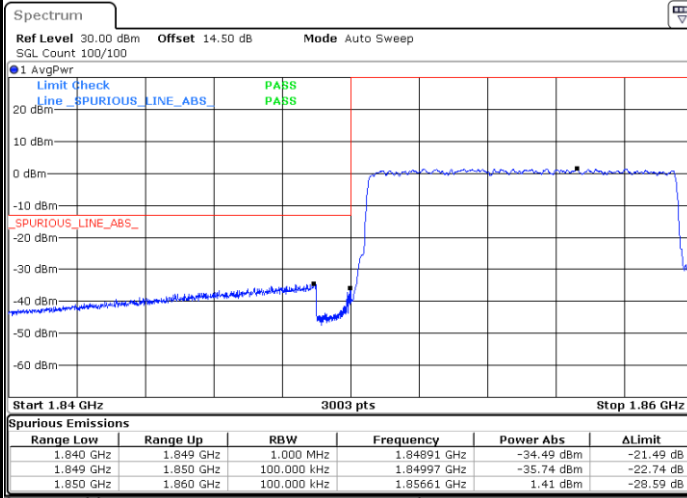

Date: 8.OCT.2023 10:18:22

Highest Band Edge / Full RB

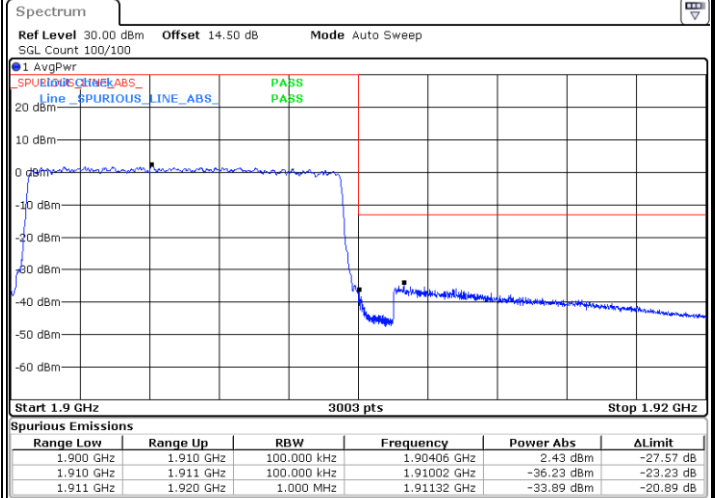

Date: 8.OCT.2023 10:26:25



LTE Band 2 / 15MHz / QPSK

Lowest Band Edge / 1RB

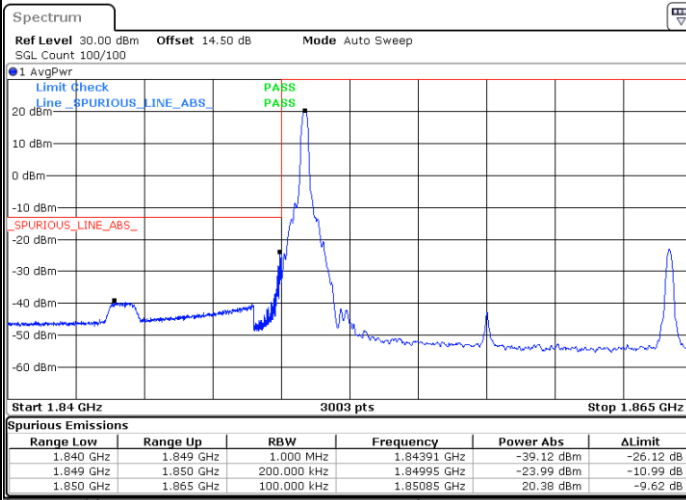

Date: 8.OCT.2023 10:28:20

Highest Band Edge / 1RB

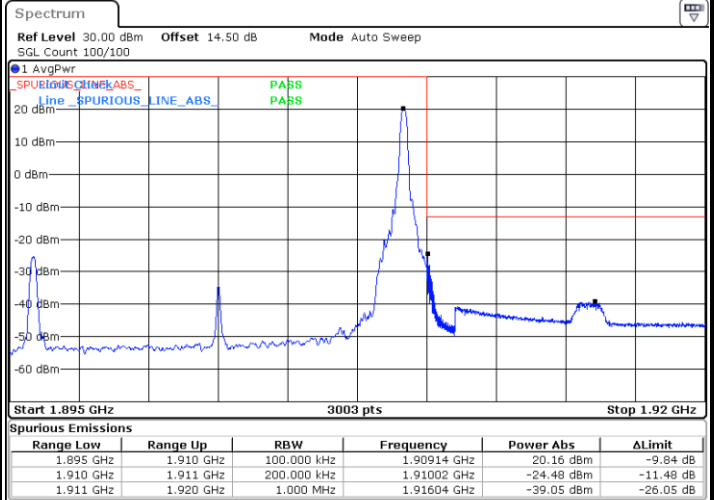

Date: 8.OCT.2023 10:36:23

Lowest Band Edge / Full RB

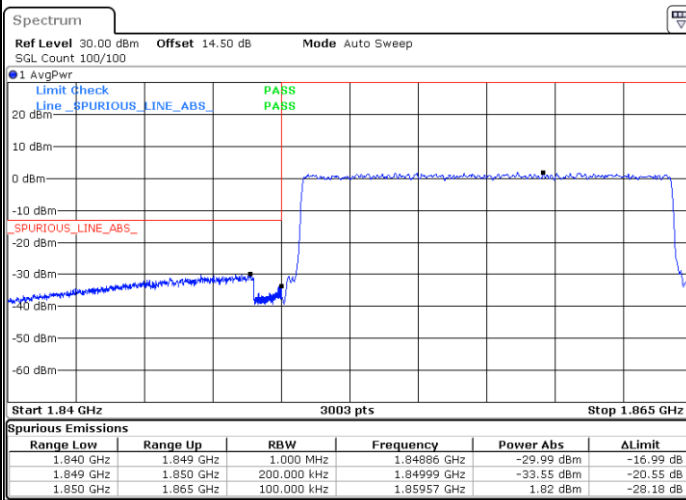

Date: 8.OCT.2023 10:30:31

Highest Band Edge / Full RB

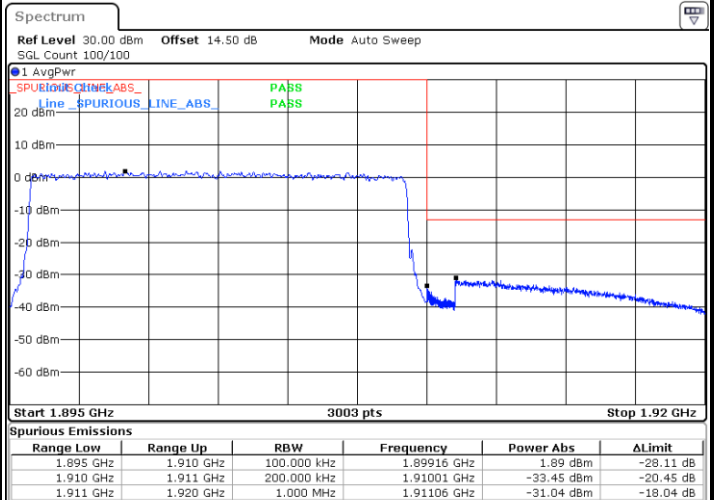

Date: 8.OCT.2023 10:38:36



LTE Band 2 / 15MHz / 16QAM

Lowest Band Edge / 1 RB

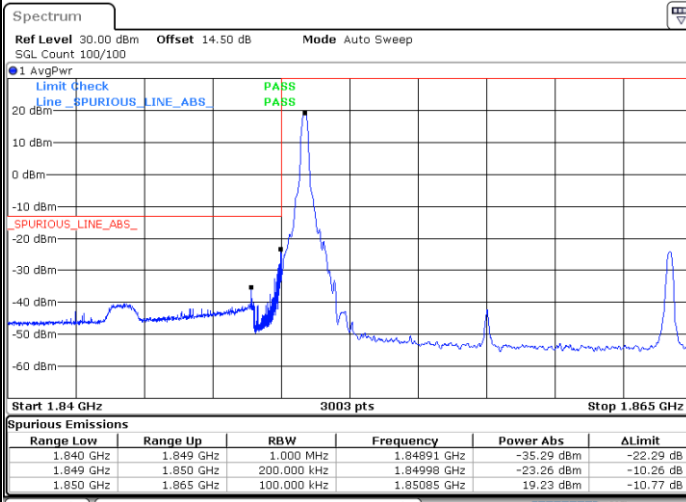

Date: 8.OCT.2023 10:29:04

Highest Band Edge / 1 RB

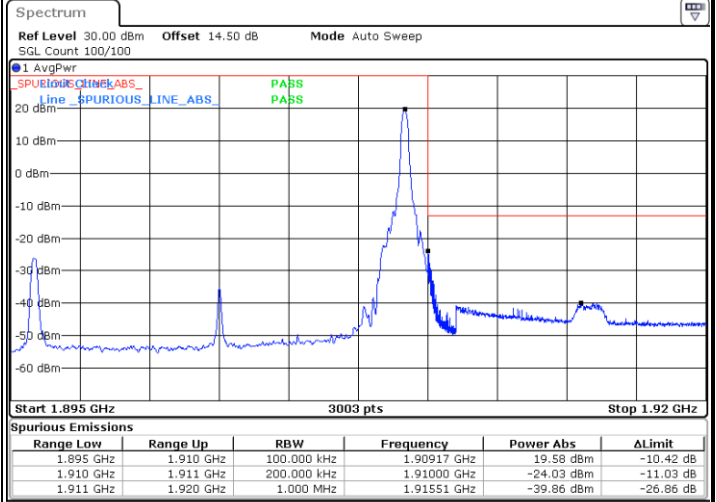

Date: 8.OCT.2023 10:37:06

Lowest Band Edge / Full RB

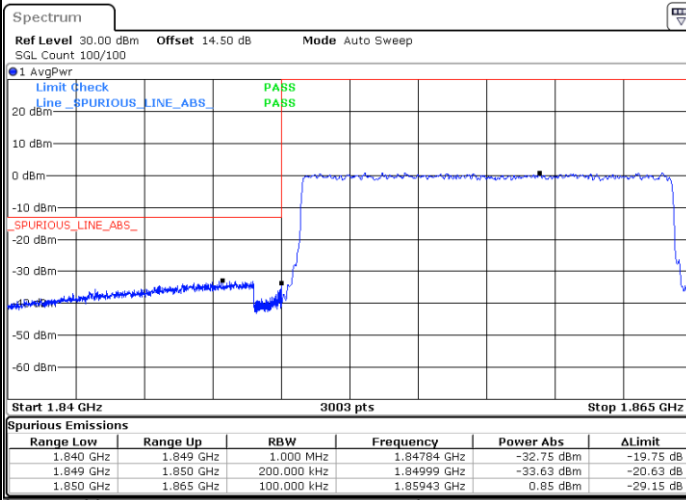

Date: 8.OCT.2023 10:31:15

Highest Band Edge / Full RB

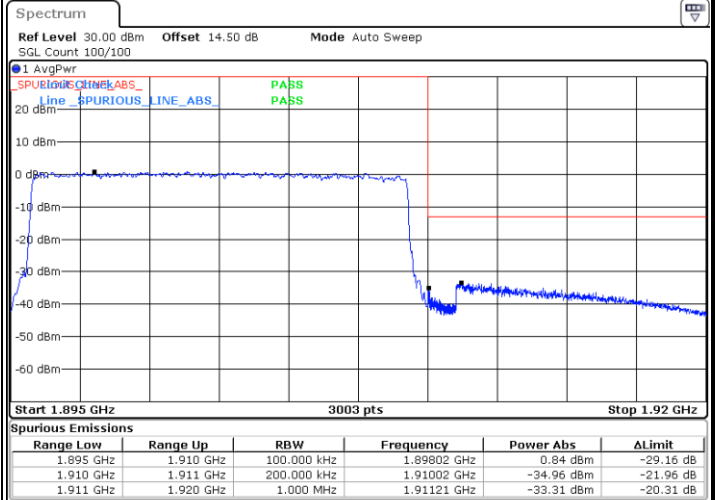

Date: 8.OCT.2023 10:39:20



LTE Band 2 / 15MHz / 64QAM

Lowest Band Edge / 1 RB

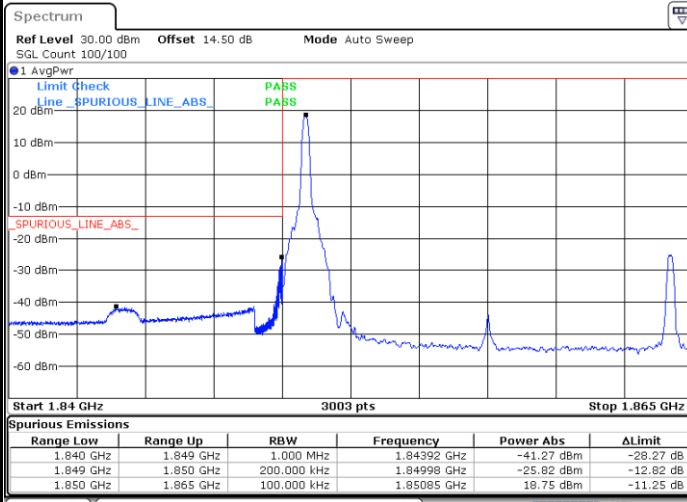

Date: 8.OCT.2023 10:29:47

Highest Band Edge / 1 RB

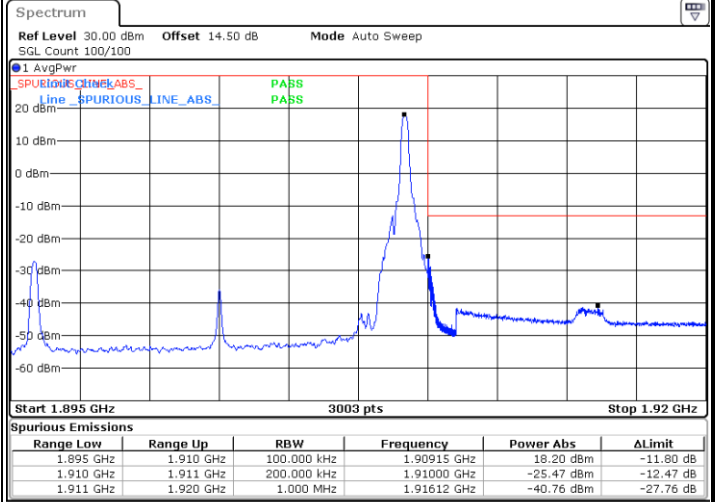

Date: 8.OCT.2023 10:37:51

Lowest Band Edge / Full RB

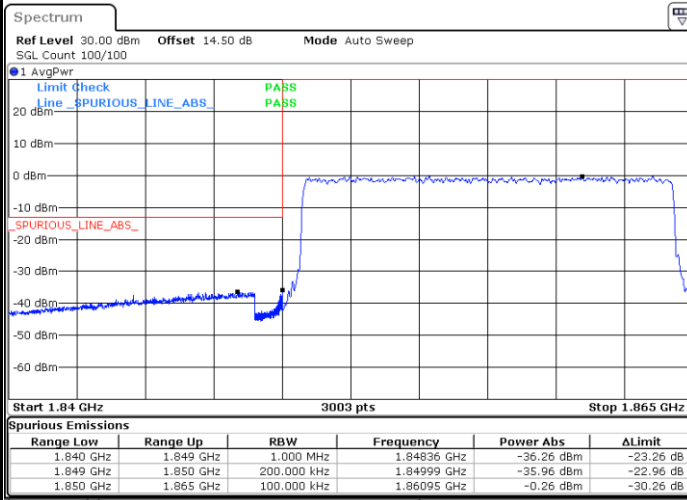

Date: 8.OCT.2023 10:31:59

Highest Band Edge / Full RB

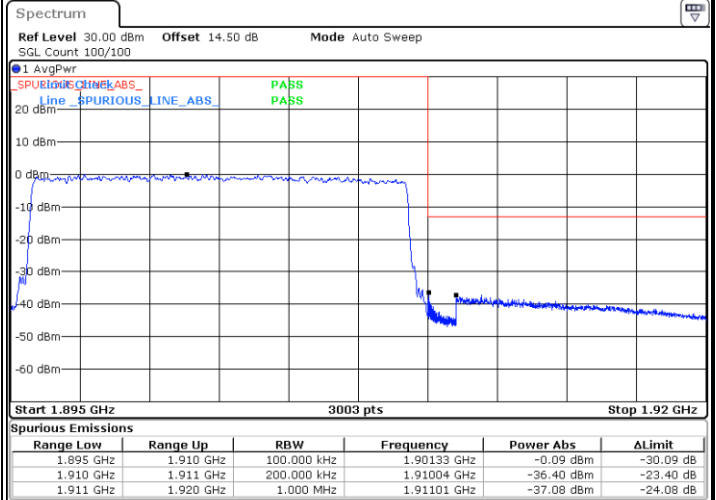

Date: 8.OCT.2023 10:40:04



LTE Band 2 / 20MHz / QPSK

Lowest Band Edge / 1RB

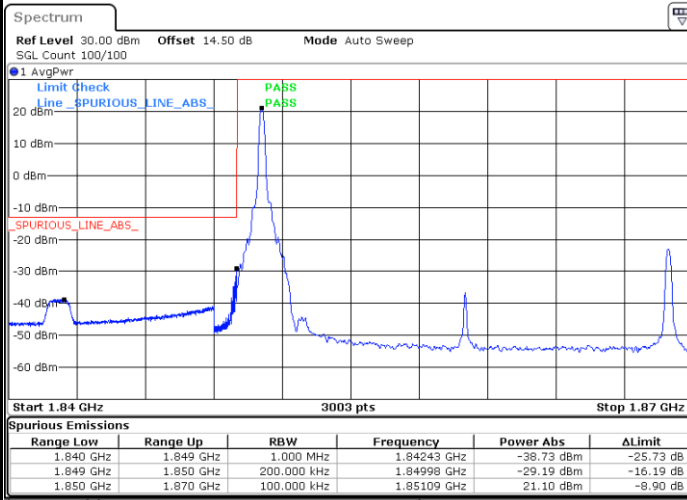

Date: 8.OCT.2023 10:41:58

Highest Band Edge / 1RB

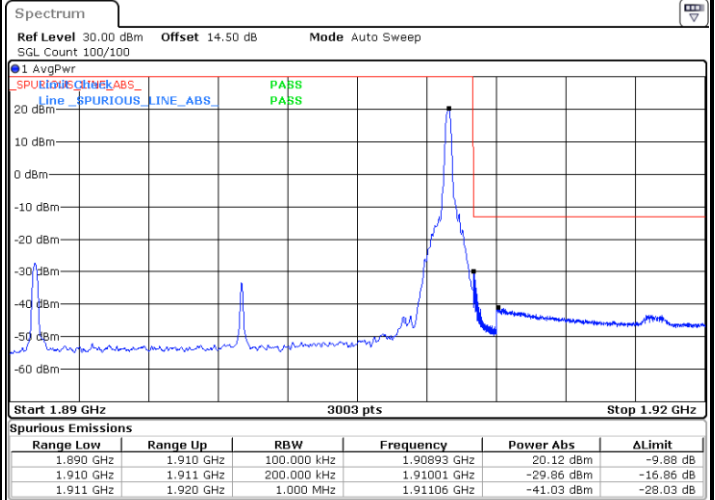

Date: 8.OCT.2023 10:51:29

Lowest Band Edge / Full RB

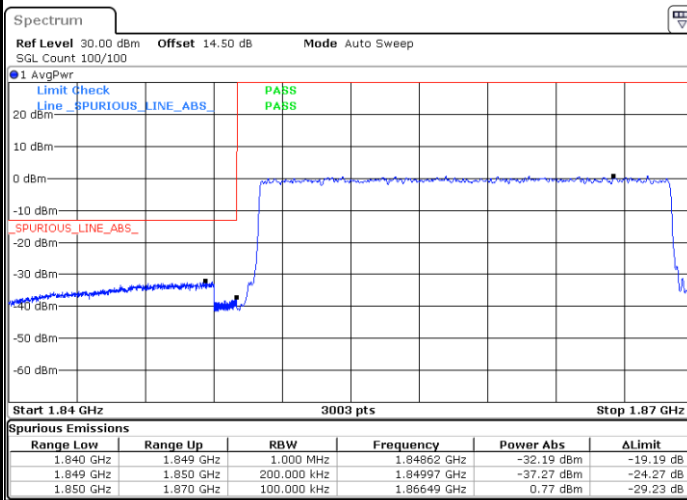

Date: 8.OCT.2023 10:44:10

Highest Band Edge / Full RB

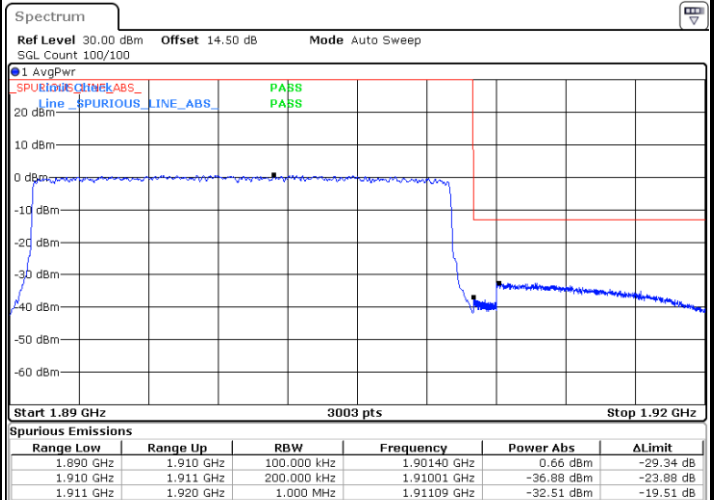

Date: 8.OCT.2023 10:53:40



LTE Band 2 / 20MHz / 16QAM

Lowest Band Edge / 1 RB

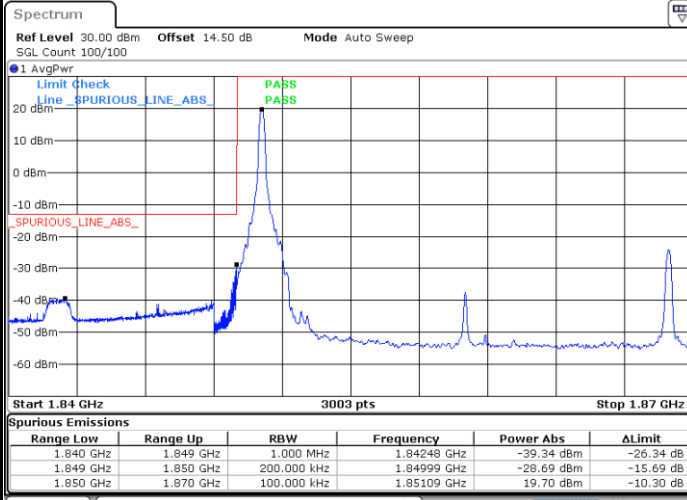

Date: 8.OCT.2023 10:42:42

Highest Band Edge / 1 RB

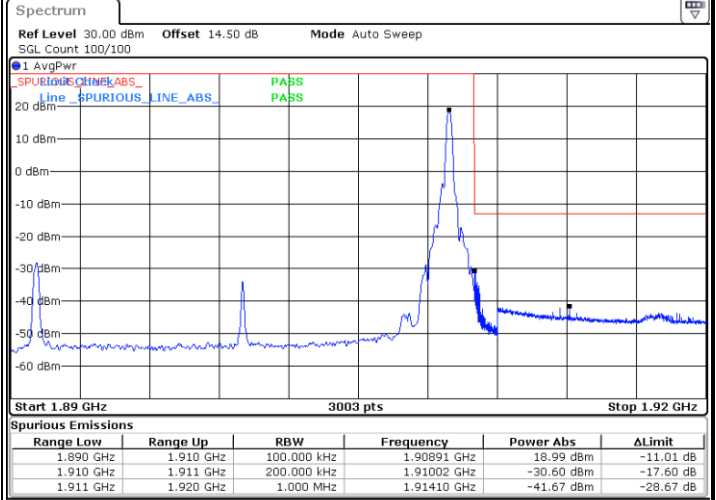

Date: 8.OCT.2023 10:52:12

Lowest Band Edge / Full RB

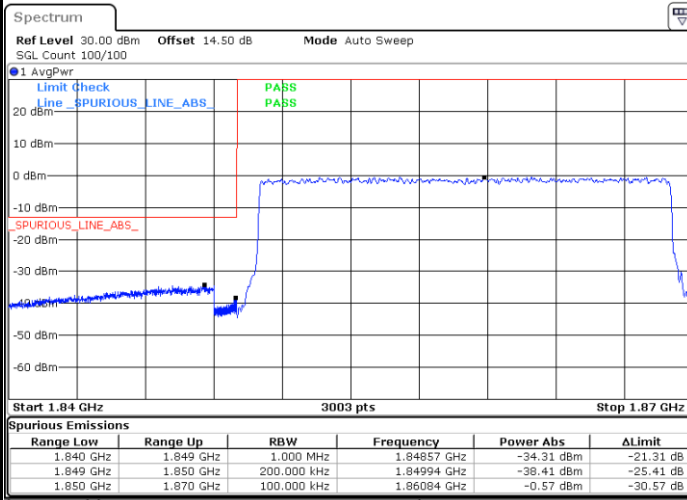

Date: 8.OCT.2023 10:44:54

Highest Band Edge / Full RB

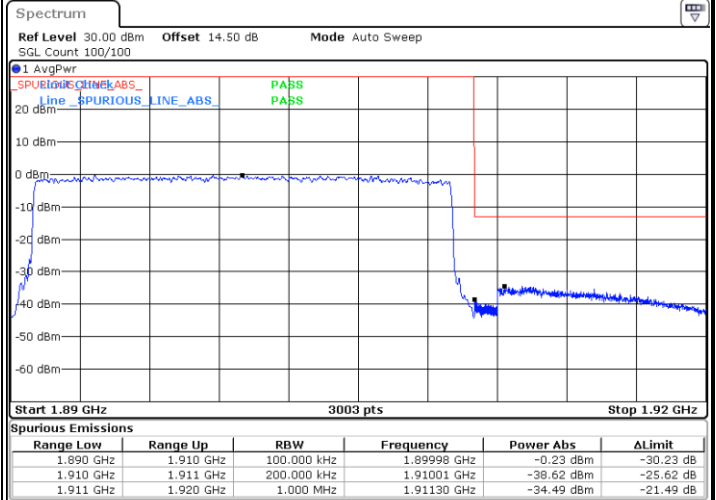

Date: 8.OCT.2023 10:54:23