

# DASY5 Validation Report for Head TSL

Date: 25.04.2023

Test Laboratory: SPEAG, Zurich, Switzerland

**DUT: Dipole 2450 MHz; Type: D2450V2; Serial: D2450V2 - SN: 1040**

Communication System: UID 0 - CW; Frequency: 2450 MHz

Medium parameters used:  $f = 2450$  MHz;  $\sigma = 1.86$  S/m;  $\epsilon_r = 37.7$ ;  $\rho = 1000$  kg/m<sup>3</sup>

Phantom section: Flat Section

Measurement Standard: DASY5 (IEEE/IEC/ANSI C63.19-2011)

DASY52 Configuration:

- Probe: EX3DV4 - SN7349; ConvF(7.88, 7.88, 7.88) @ 2450 MHz; Calibrated: 10.01.2023
- Sensor-Surface: 1.4mm (Mechanical Surface Detection)
- Electronics: DAE4 Sn601; Calibrated: 19.12.2022
- Phantom: Flat Phantom 5.0 (front); Type: QD 000 P50 AA; Serial: 1001
- DASY52 52.10.4(1535); SEMCAD X 14.6.14(7501)

## Dipole Calibration for Head Tissue/Pin=250 mW, d=10mm/Zoom Scan (7x7x7)/Cube 0:

Measurement grid: dx=5mm, dy=5mm, dz=5mm

Reference Value = 117.6 V/m; Power Drift = 0.03 dB

Peak SAR (extrapolated) = 26.7 W/kg

**SAR(1 g) = 13.5 W/kg; SAR(10 g) = 6.24 W/kg**

Smallest distance from peaks to all points 3 dB below = 9 mm

Ratio of SAR at M2 to SAR at M1 = 50.3%

Maximum value of SAR (measured) = 22.2 W/kg

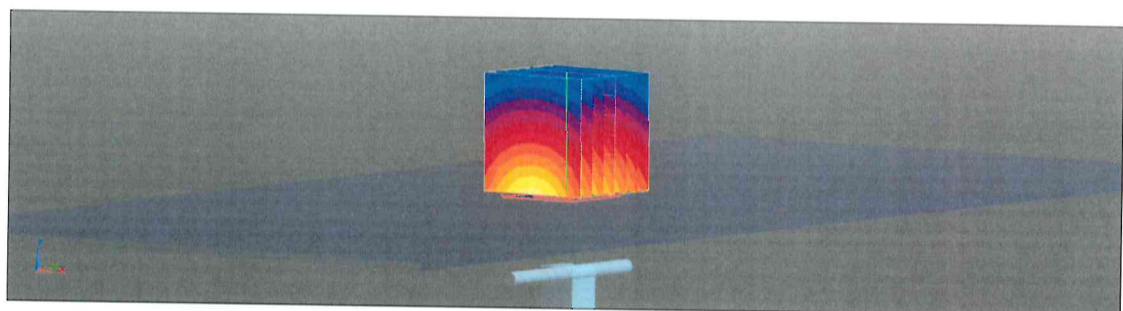
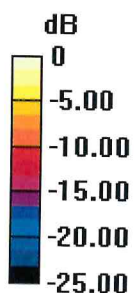

0 dB = 22.2 W/kg = 13.46 dBW/kg

# Impedance Measurement Plot for Head TSL

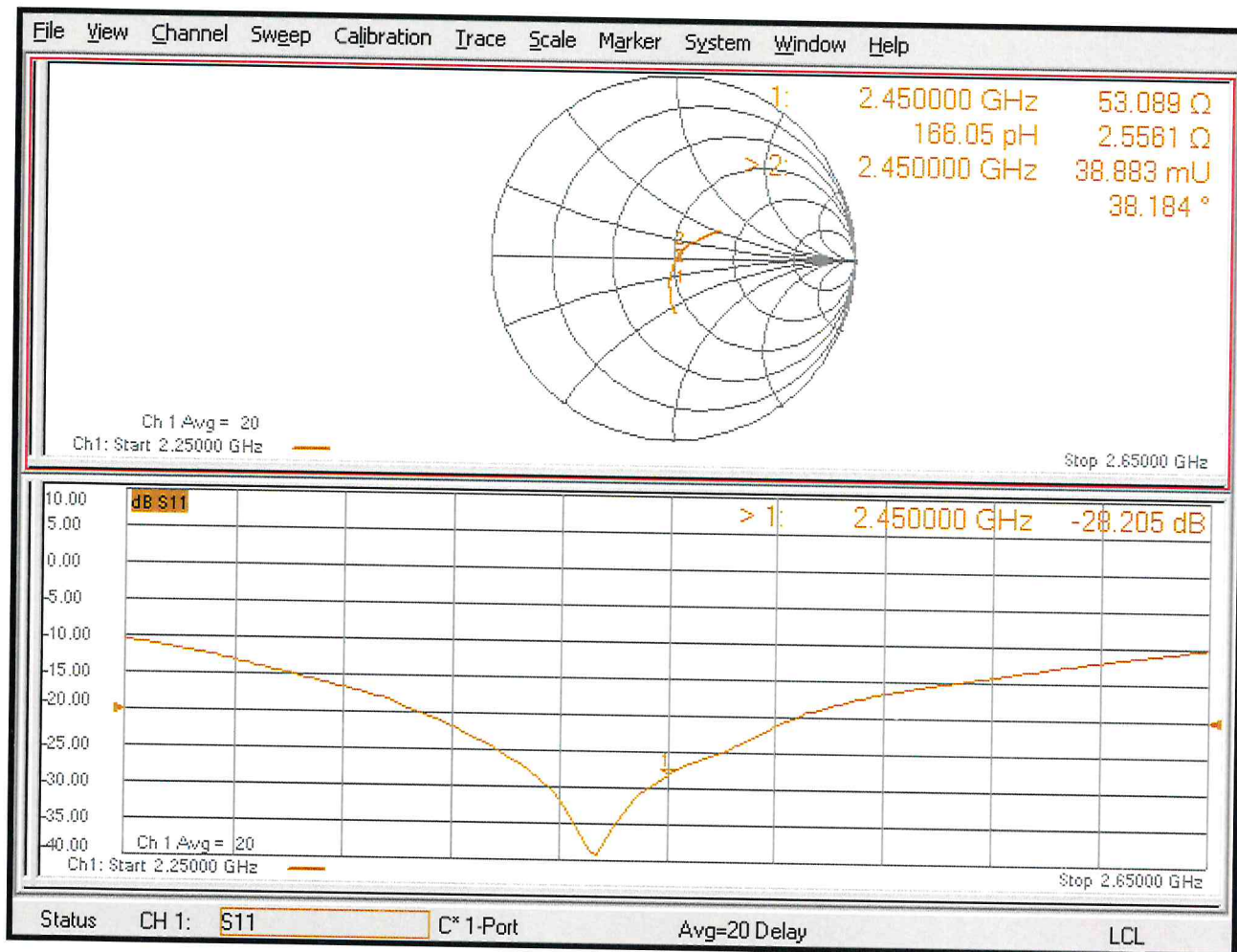



In Collaboration with  
**s p e a g**  
CALIBRATION LABORATORY



中国认可  
国际互认  
校准  
CALIBRATION  
CNAS L0570

Add: No.52 HuaYuanBei Road, Haidian District, Beijing, 100191, Chi  
Tel: +86-10-62304633-2079 Fax: +86-10-62304633-2504  
E-mail: cttl@chinattl.com http://www.chinattl.cn

Client **Sporton**

Certificate No: **Z21-60554**

## CALIBRATION CERTIFICATE

Object **D2600V2 - SN: 1070**

Calibration Procedure(s) **FF-Z11-003-01**  
Calibration Procedures for dipole validation kits

Calibration date: **December 20, 2021**

This calibration Certificate documents the traceability to national standards, which realize the physical units of measurements (SI). The measurements and the uncertainties with confidence probability are given on the following pages and are part of the certificate.

All calibrations have been conducted in the closed laboratory facility: environment temperature (22±3)°C and humidity<70%.

Calibration Equipment used (M&TE critical for calibration)

Primary Standards	ID #	Cal Date (Calibrated by, Certificate No.)	Scheduled Calibration
Power Meter NRP2	106277	24-Sep-21 (CTTL, No.J21X08326)	Sep-22
Power sensor NRP8S	104291	24-Sep-21 (CTTL, No.J21X08326)	Sep-22
Reference Probe EX3DV4	SN 7307	26-May-21(SPEAG,No.EX3-7307_May21)	May-22
DAE4	SN 1556	15-Jan-21(SPEAG,No.DAE4-1556_Jan21)	Jan-22
Secondary Standards	ID #	Cal Date (Calibrated by, Certificate No.)	Scheduled Calibration
Signal Generator E4438C	MY49071430	01-Feb-21 (CTTL, No.J21X00593)	Jan-22
Network Analyzer E5071C	MY46110673	14-Jan-21 (CTTL, No.J21X00232)	Jan-22

	Name	Function	Signature
Calibrated by:	Zhao Jing	SAR Test Engineer	
Reviewed by:	Lin Hao	SAR Test Engineer	
Approved by:	Qi Dianyuan	SAR Project Leader	

Issued: December 27, 2021

This calibration certificate shall not be reproduced except in full without written approval of the laboratory.





### Glossary:

TSL	tissue simulating liquid
ConvF	sensitivity in TSL / NORM <sub>x,y,z</sub>
N/A	not applicable or not measured

### Calibration is Performed According to the Following Standards:

- IEEE Std 1528-2013, "IEEE Recommended Practice for Determining the Peak Spatial-Averaged Specific Absorption Rate (SAR) in the Human Head from Wireless Communications Devices: Measurement Techniques", June 2013
- IEC 62209-1, "Measurement procedure for assessment of specific absorption rate of human exposure to radio frequency fields from hand-held and body-mounted wireless communication devices- Part 1: Device used next to the ear (Frequency range of 300MHz to 6GHz)", July 2016
- IEC 62209-2, "Procedure to measure the Specific Absorption Rate (SAR) For wireless communication devices used in close proximity to the human body (frequency range of 30MHz to 6GHz)", March 2010
- KDB865664, SAR Measurement Requirements for 100 MHz to 6 GHz

### Additional Documentation:

- DASY4/5 System Handbook

### Methods Applied and Interpretation of Parameters:

- Measurement Conditions:* Further details are available from the Validation Report at the end of the certificate. All figures stated in the certificate are valid at the frequency indicated.
- Antenna Parameters with TSL:* The dipole is mounted with the spacer to position its feed point exactly below the center marking of the flat phantom section, with the arms oriented parallel to the body axis.
- Feed Point Impedance and Return Loss:* These parameters are measured with the dipole positioned under the liquid filled phantom. The impedance stated is transformed from the measurement at the SMA connector to the feed point. The Return Loss ensures low reflected power. No uncertainty required.
- Electrical Delay:* One-way delay between the SMA connector and the antenna feed point. No uncertainty required.
- SAR measured:* SAR measured at the stated antenna input power.
- SAR normalized:* SAR as measured, normalized to an input power of 1 W at the antenna connector.
- SAR for nominal TSL parameters:* The measured TSL parameters are used to calculate the nominal SAR result.

The reported uncertainty of measurement is stated as the standard uncertainty of Measurement multiplied by the coverage factor  $k=2$ , which for a normal distribution Corresponds to a coverage probability of approximately 95%.



### Measurement Conditions

DASY system configuration, as far as not given on page 1.

DASY Version	DASY52	V52.10.4
Extrapolation	Advanced Extrapolation	
Phantom	Triple Flat Phantom 5.1C	
Distance Dipole Center - TSL	10 mm	with Spacer
Zoom Scan Resolution	dx, dy, dz = 5 mm	
Frequency	2600 MHz ± 1 MHz	

### Head TSL parameters

The following parameters and calculations were applied.

	Temperature	Permittivity	Conductivity
Nominal Head TSL parameters	22.0 °C	39.0	1.96 mho/m
Measured Head TSL parameters	(22.0 ± 0.2) °C	40.1 ± 6 %	1.97 mho/m ± 6 %
Head TSL temperature change during test	<1.0 °C	----	----

### SAR result with Head TSL

SAR averaged over 1 cm <sup>3</sup> (1 g) of Head TSL	Condition	
SAR measured	250 mW input power	14.0 W/kg
SAR for nominal Head TSL parameters	normalized to 1W	<b>56.2 W/kg ± 18.8 % (k=2)</b>
SAR averaged over 10 cm <sup>3</sup> (10 g) of Head TSL	Condition	
SAR measured	250 mW input power	6.14 W/kg
SAR for nominal Head TSL parameters	normalized to 1W	<b>24.6 W/kg ± 18.7 % (k=2)</b>



Add: No.52 HuaYuanBei Road, Haidian District, Beijing, 100191, China  
Tel: +86-10-62304633-2079 Fax: +86-10-62304633-2504  
E-mail: cttl@chinattl.com http://www.chinattl.cn

## Appendix (Additional assessments outside the scope of CNAS L0570)

### Antenna Parameters with Head TSL

Impedance, transformed to feed point	50.5Ω- 6.60jΩ
Return Loss	- 23.6dB

### General Antenna Parameters and Design

Electrical Delay (one direction)	1.058 ns
----------------------------------	----------

After long term use with 100W radiated power, only a slight warming of the dipole near the feedpoint can be measured.

The dipole is made of standard semirigid coaxial cable. The center conductor of the feeding line is directly connected to the second arm of the dipole. The antenna is therefore short-circuited for DC-signals. On some of the dipoles, small end caps are added to the dipole arms in order to improve matching when loaded according to the position as explained in the "Measurement Conditions" paragraph. The SAR data are not affected by this change. The overall dipole length is still according to the Standard. No excessive force must be applied to the dipole arms, because they might bend or the soldered connections near the feedpoint may be damaged.

### Additional EUT Data

Manufactured by	SPEAG
-----------------	-------





### DASY5 Validation Report for Head TSL

Date: 2021-12-20

Test Laboratory: CTTL, Beijing, China

**DUT: Dipole 2600 MHz; Type: D2600V2; Serial: D2600V2 - SN: 1070**

Communication System: UID 0, CW; Frequency: 2600 MHz; Duty Cycle: 1:1

Medium parameters used:  $f = 2600$  MHz;  $\sigma = 1.97$  S/m;  $\epsilon_r = 40.05$ ;  $\rho = 1000$  kg/m<sup>3</sup>

Phantom section: Right Section

Measurement Standard: DASY5 (IEEE/IEC/ANSI C63.19-2007)

DASY5 Configuration:

- Probe: EX3DV4 - SN7307; ConvF(7.5, 7.5, 7.5) @ 2600 MHz; Calibrated: 2021-05-26
- Sensor-Surface: 1.4mm (Mechanical Surface Detection)
- Electronics: DAE4 Sn1556; Calibrated: 2021-01-15
- Phantom: MFP\_V5.1C (20deg probe tilt); Type: QD 000 P51 Cx; Serial: 1062
- DASY52 52.10.4(1535); SEMCAD X 14.6.14(7501)

**Dipole Calibration/Zoom Scan (7x7x7) (7x7x7)/Cube 0:** Measurement grid: dx=5mm, dy=5mm, dz=5mm

Reference Value = 106.3 V/m; Power Drift = -0.02 dB

Peak SAR (extrapolated) = 30.8 W/kg

**SAR(1 g) = 14 W/kg; SAR(10 g) = 6.14 W/kg**

Smallest distance from peaks to all points 3 dB below = 9 mm

Ratio of SAR at M2 to SAR at M1 = 44.7%

Maximum value of SAR (measured) = 24.5 W/kg

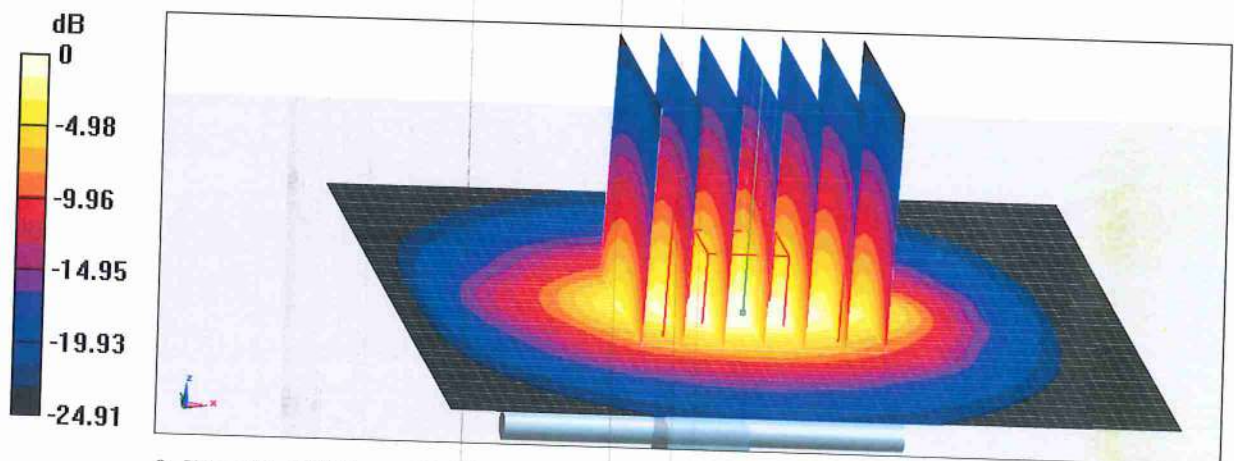

0 dB = 24.5 W/kg = 13.89 dBW/kg



In Collaboration with  
**s p e a g**  
CALIBRATION LABORATORY

Add: No.52 HuaYuanBei Road, Haidian District, Beijing, 100191, China  
Tel: +86-10-62304633-2079 Fax: +86-10-62304633-2504  
E-mail: cttl@chinattl.com http://www.chinattl.cn

### Impedance Measurement Plot for Head TSL

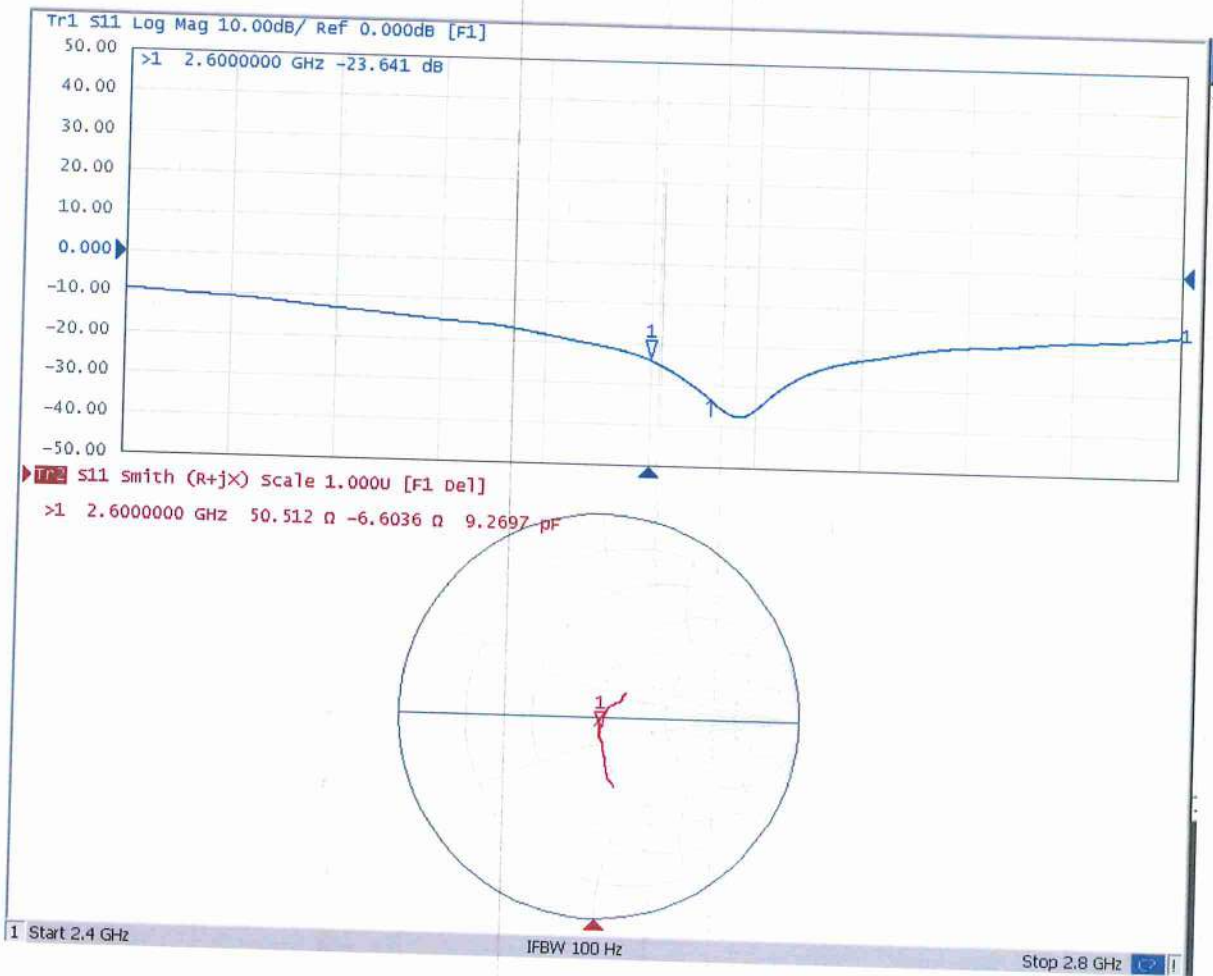





---

## D2600V2, Serial No. 1070 Extended Dipole Calibrations

Referring to KDB 865664 D01, if dipoles are verified in return loss (<-20dB, within 20% of prior calibration), and in impedance (within 5 ohm of prior calibration), the annual calibration is not necessary and the calibration interval can be extended.

D2600V2 – serial no. 1070						
2600 Head						
Date of Measurement	Return-Loss (dB)	Delta (%)	Real Impedance (ohm)	Delta (ohm)	Imaginary Impedance (ohm)	Delta (ohm)
2021.12.20	-23.6		50.5		-6.6	
2022.12.19	-24.0	1.6%	51.2	-0.7	-6.3	-0.3

### <Justification of the extended calibration>

The return loss is < -20dB, within 20% of prior calibration; the impedance is within 5 ohm of prior calibration. Therefore the verification result should support extended calibration.

---

Dipole Verification Data> D2600V2, serial no. 1070

2600MHz – Head---2022.12.19

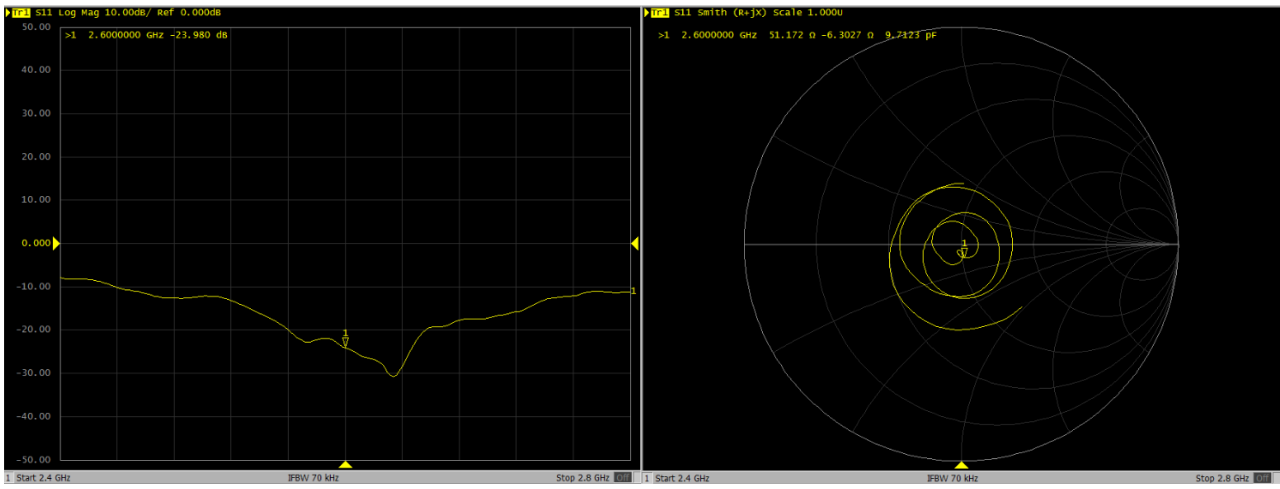

Add: No.52 HuaYuanBei Road, Haidian District, Beijing, 100191  
Tel: +86-10-62304633-2117  
E-mail: cttl@chinattl.com      http://www.caict.ac.cn

Client

**Sporton**

Certificate No: **Z22-60145**

## CALIBRATION CERTIFICATE

Object **D3500V2 - SN: 1076**

Calibration Procedure(s) **FF-Z11-003-01**  
**Calibration Procedures for dipole validation kits**



Calibration date: **May 9, 2022**

This calibration Certificate documents the traceability to national standards, which realize the physical units of measurements (SI). The measurements and the uncertainties with confidence probability are given on the following pages and are part of the certificate.

All calibrations have been conducted in the closed laboratory facility: environment temperature (22±3)°C and humidity<70%.

Calibration Equipment used (M&TE critical for calibration)

Primary Standards	ID #	Cal Date (Calibrated by, Certificate No.)	Scheduled Calibration
Power Meter NRP2	106277	24-Sep-21 (CTTL, No.J21X08326)	Sep-22
Power sensor NRP8S	104291	24-Sep-21 (CTTL, No.J21X08326)	Sep-22
Reference Probe EX3DV4	SN 7307	26-May-21(SPEAG,No.EX3-7307_May21)	May-22
DAE4	SN 1556	12-Jan-22(CTTL-SPEAG,No.Z22-60007)	Jan-23
Secondary Standards	ID #	Cal Date (Calibrated by, Certificate No.)	Scheduled Calibration
Signal Generator E4438C	MY49071430	13-Jan-22 (CTTL, No.J22X00409)	Jan-23
Network Analyzer E5071C	MY46110673	14-Jan-22 (CTTL, No.J22X00406)	Jan-23

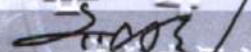
	Name	Function	Signature
Calibrated by:	Zhao Jing	SAR Test Engineer	
Reviewed by:	Lin Hao	SAR Test Engineer	
Approved by:	Qi Dianyuan	SAR Project Leader	

Issued: May 13, 2022

This calibration certificate shall not be reproduced except in full without written approval of the laboratory.





### Glossary:

TSL	tissue simulating liquid
ConvF	sensitivity in TSL / NORM <sub>x,y,z</sub>
N/A	not applicable or not measured

### Calibration is Performed According to the Following Standards:

- a) IEC/IEEE 62209-1528, "Measurement Procedure for The Assessment of Specific Absorption Rate of Human Exposure to Radio Frequency Fields from Hand-held and Body-mounted Wireless Communication Devices- Part 1528: Human Models, Instrumentation and Procedures (Frequency range of 4 MHz to 10 GHz)", October 2020
- b) KDB 865664, "SAR Measurement Requirements for 100 MHz to 6 GHz"

### Additional Documentation:

- c) DASY4/5 System Handbook

### Methods Applied and Interpretation of Parameters:

- *Measurement Conditions:* Further details are available from the Validation Report at the end of the certificate. All figures stated in the certificate are valid at the frequency indicated.
- *Antenna Parameters with TSL:* The dipole is mounted with the spacer to position its feed point exactly below the center marking of the flat phantom section, with the arms oriented parallel to the body axis.
- *Feed Point Impedance and Return Loss:* These parameters are measured with the dipole positioned under the liquid filled phantom. The impedance stated is transformed from the measurement at the SMA connector to the feed point. The Return Loss ensures low reflected power. No uncertainty required.
- *Electrical Delay:* One-way delay between the SMA connector and the antenna feed point. No uncertainty required.
- *SAR measured:* SAR measured at the stated antenna input power.
- *SAR normalized:* SAR as measured, normalized to an input power of 1 W at the antenna connector.
- *SAR for nominal TSL parameters:* The measured TSL parameters are used to calculate the nominal SAR result.

The reported uncertainty of measurement is stated as the standard uncertainty of Measurement multiplied by the coverage factor  $k=2$ , which for a normal distribution Corresponds to a coverage probability of approximately 95%.



Add: No.52 HuaYuanBei Road, Haidian District, Beijing, 100191, China  
Tel: +86-10-62304633-2117  
E-mail: cttl@chinattl.com <http://www.caict.ac.cn>

### Measurement Conditions

DASY system configuration, as far as not given on page 1.

DASY Version	DASY52	52.10.4
Extrapolation	Advanced Extrapolation	
Phantom	Triple Flat Phantom 5.1C	
Distance Dipole Center - TSL	10 mm	with Spacer
Zoom Scan Resolution	dx, dy = 4 mm, dz = 1.4 mm	Graded Ratio = 1.4 (Z direction)
Frequency	3500 MHz $\pm$ 1 MHz	

### Head TSL parameters

The following parameters and calculations were applied.

	Temperature	Permittivity	Conductivity
Nominal Head TSL parameters	22.0 °C	37.9	2.91 mho/m
Measured Head TSL parameters	(22.0 $\pm$ 0.2) °C	38.1 $\pm$ 6 %	2.92 mho/m $\pm$ 6 %
Head TSL temperature change during test	<1.0 °C	---	---

### SAR result with Head TSL

<b>SAR averaged over 1 cm<sup>3</sup> (1 g) of Head TSL</b>	Condition	
SAR measured	100 mW input power	6.62 W/kg
SAR for nominal Head TSL parameters	normalized to 1W	<b>66.2 W/kg <math>\pm</math> 24.4 % (k=2)</b>
<b>SAR averaged over 10 cm<sup>3</sup> (10 g) of Head TSL</b>	Condition	
SAR measured	100 mW input power	2.55 W/kg
SAR for nominal Head TSL parameters	normalized to 1W	<b>25.5 W/kg <math>\pm</math> 24.2 % (k=2)</b>





Add: No.52 HuaYuanBei Road, Haidian District, Beijing, 100191, China  
 Tel: +86-10-62304633-2117  
 E-mail: cttl@chinattl.com      <http://www.caict.ac.cn>

**Appendix (Additional assessments outside the scope of CNAS L0570)**

**Antenna Parameters with Head TSL**

Impedance, transformed to feed point	55.1Ω- 6.03jΩ
Return Loss	- 22.5dB

**General Antenna Parameters and Design**

Electrical Delay (one direction)	1.046 ns
----------------------------------	----------

After long term use with 100W radiated power, only a slight warming of the dipole near the feed-point can be measured.

The dipole is made of standard semirigid coaxial cable. The center conductor of the feeding line is directly connected to the second arm of the dipole. The antenna is therefore short-circuited for DC-signals. On some of the dipoles, small end caps are added to the dipole arms in order to improve matching when loaded according to the position as explained in the "Measurement Conditions" paragraph. The SAR data are not affected by this change. The overall dipole length is still according to the Standard. No excessive force must be applied to the dipole arms, because they might bend or the soldered connections near the feed-point may be damaged.

**Additional EUT Data**

Manufactured by	SPEAG
-----------------	-------



Add: No.52 HuaYuanBei Road, Haidian District, Beijing, 100191, China  
Tel: +86-10-62304633-2117  
E-mail: cttl@chinattl.com <http://www.caict.ac.cn>

### DASY5 Validation Report for Head TSL

Date: 2022-05-09

Test Laboratory: CTTL, Beijing, China

**DUT: Dipole 3500 MHz; Type: D3500V2; Serial: D3500V2 - SN: 1076**

Communication System: UID 0, CW; Frequency: 3500 MHz; Duty Cycle: 1:1

Medium parameters used:  $f = 3500$  MHz;  $\sigma = 2.924$  S/m;  $\epsilon_r = 38.1$ ;  $\rho = 1000$  kg/m<sup>3</sup>

Phantom section: Right Section

Measurement Standard: DASY5 (IEEE/IEC/ANSI C63.19-2007)

DASY5 Configuration:

- Probe: EX3DV4 - SN7307; ConvF(6.87, 6.87, 6.87) @ 3500 MHz; Calibrated: 2021-05-26
- Sensor-Surface: 1.4mm (Mechanical Surface Detection)
- Electronics: DAE4 Sn1556; Calibrated: 2022-01-12
- Phantom: MFP\_V5.1C (20deg probe tilt); Type: QD 000 P51 Cx; Serial: 1062
- DASY52 52.10.4(1535); SEMCAD X 14.6.14(7501)

**Dipole Calibration /Pin=100mW, d=10mm, f=3500 MHz/Zoom Scan,**

**dist=1.4mm (8x8x7)/Cube 0:** Measurement grid: dx=4mm, dy=4mm, dz=1.4mm

Reference Value = 62.00 V/m; Power Drift = -0.02 dB

Peak SAR (extrapolated) = 16.9 W/kg

**SAR(1 g) = 6.62 W/kg; SAR(10 g) = 2.55 W/kg**

Smallest distance from peaks to all points 3 dB below = 8 mm

Ratio of SAR at M2 to SAR at M1 = 76.4%

Maximum value of SAR (measured) = 12.1 W/kg

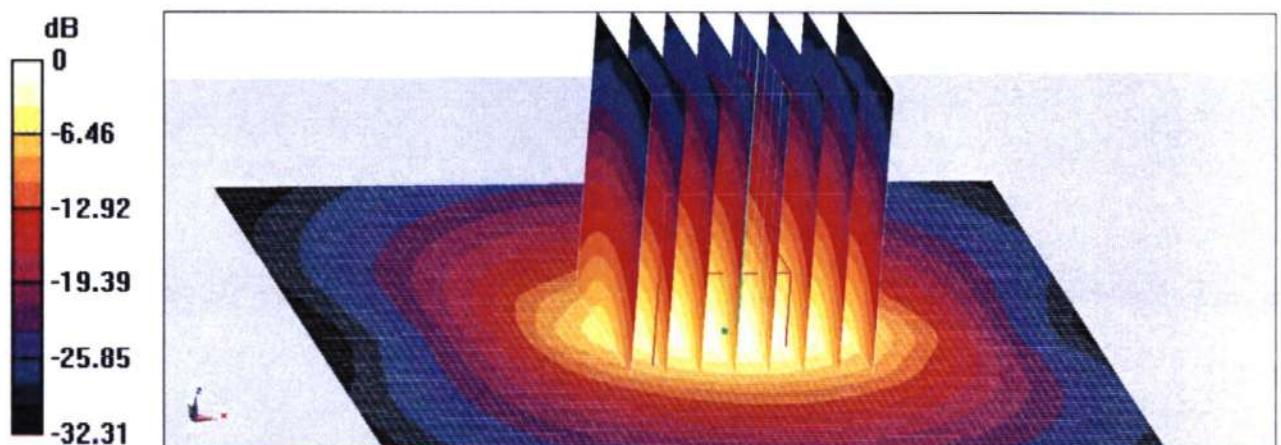

0 dB = 12.1 W/kg = 10.83 dBW/kg



Add: No.52 HuaYuanBei Road, Haidian District, Beijing, 100191, China  
Tel: +86-10-62304633-2117  
E-mail: cttl@chinattl.com <http://www.caict.ac.cn>

### Impedance Measurement Plot for Head TSL

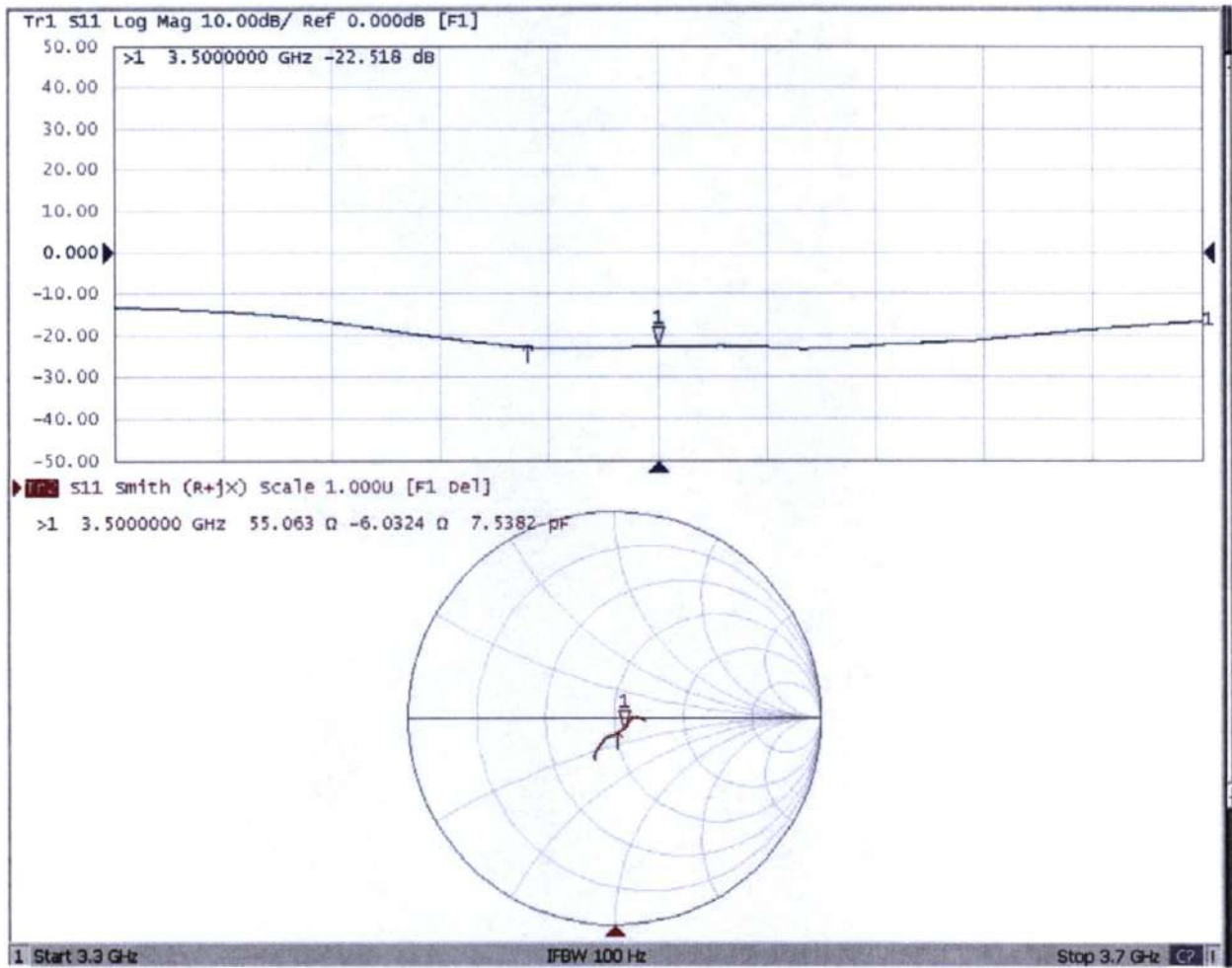



## D3500V2, Serial No. 1076 Extended Dipole Calibrations

if dipoles are verified in return loss ( $< -20\text{dB}$ , within 20% of prior calibration), and in impedance (within 5 ohm of prior calibration), the annual calibration is not necessary and the calibration interval can be extended.

D3500V2 – serial no. 1076						
3500 Head						
Date of Measurement	Return-Loss (dB)	Delta (%)	Real Impedance (ohm)	Delta (ohm)	Imaginary Impedance (ohm)	Delta (ohm)
2022.5.9	-22.5		55.1		-6	
2023.5.8	-22.9	1.8%	54.7	0.4	-5.8	-0.2

### <Justification of the extended calibration>

The return loss is  $< -20\text{dB}$ , within 20% of prior calibration; the impedance is within 5 ohm of prior calibration. Therefore the verification result should support extended calibration.



Dipole Verification Data> D3500V2, serial no. 1076

3500MHz - Head----2023.5.8

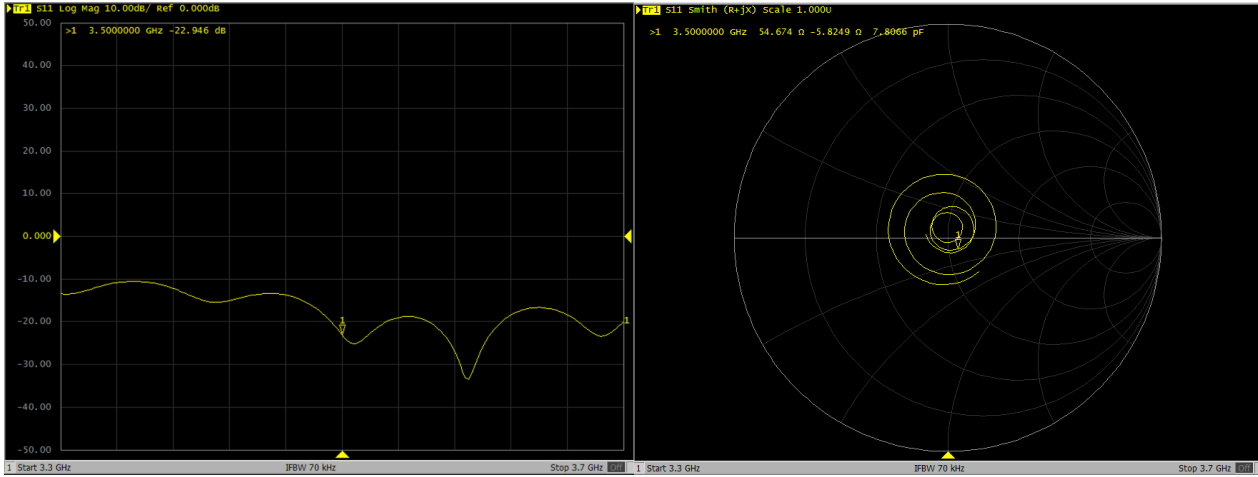

Client

**Sporton**

Certificate No: **Z22-60146**

## CALIBRATION CERTIFICATE

Object **D3700V2 - SN: 1037**

Calibration Procedure(s) **FF-Z11-003-01**  
**Calibration Procedures for dipole validation kits**



Calibration date: **May 9, 2022**

This calibration Certificate documents the traceability to national standards, which realize the physical units of measurements (SI). The measurements and the uncertainties with confidence probability are given on the following pages and are part of the certificate.

All calibrations have been conducted in the closed laboratory facility: environment temperature (22±3)°C and humidity<70%.

Calibration Equipment used (M&TE critical for calibration)

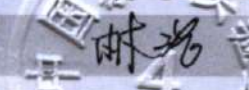
Primary Standards	ID #	Cal Date (Calibrated by, Certificate No.)	Scheduled Calibration
Power Meter NRP2	106277	24-Sep-21 (CTTL, No.J21X08326)	Sep-22
Power sensor NRP8S	104291	24-Sep-21 (CTTL, No.J21X08326)	Sep-22
Reference Probe EX3DV4	SN 7307	26-May-21(SPEAG,No.EX3-7307_May21)	May-22
DAE4	SN 1556	12-Jan-22(CTTL-SPEAG,No.Z22-60007)	Jan-23
Secondary Standards	ID #	Cal Date (Calibrated by, Certificate No.)	Scheduled Calibration
Signal Generator E4438C	MY49071430	13-Jan-22 (CTTL, No.J22X00409)	Jan-23
Network Analyzer E5071C	MY46110673	14-Jan-22 (CTTL, No.J22X00406)	Jan-23

	Name	Function	Signature
Calibrated by:	Zhao Jing	SAR Test Engineer	
Reviewed by:	Lin Hao	SAR Test Engineer	
Approved by:	Qi Dianyuan	SAR Project Leader	

Issued: May 13, 2022

This calibration certificate shall not be reproduced except in full without written approval of the laboratory.





### Glossary:

TSL	tissue simulating liquid
ConvF	sensitivity in TSL / NORM <sub>x,y,z</sub>
N/A	not applicable or not measured

### Calibration is Performed According to the Following Standards:

- a) IEC/IEEE 62209-1528, "Measurement Procedure for The Assessment of Specific Absorption Rate of Human Exposure to Radio Frequency Fields from Hand-held and Body-mounted Wireless Communication Devices- Part 1528: Human Models, Instrumentation and Procedures (Frequency range of 4 MHz to 10 GHz)", October 2020
- b) KDB 865664, "SAR Measurement Requirements for 100 MHz to 6 GHz"

### Additional Documentation:

- c) DASY4/5 System Handbook

### Methods Applied and Interpretation of Parameters:

- *Measurement Conditions:* Further details are available from the Validation Report at the end of the certificate. All figures stated in the certificate are valid at the frequency indicated.
- *Antenna Parameters with TSL:* The dipole is mounted with the spacer to position its feed point exactly below the center marking of the flat phantom section, with the arms oriented parallel to the body axis.
- *Feed Point Impedance and Return Loss:* These parameters are measured with the dipole positioned under the liquid filled phantom. The impedance stated is transformed from the measurement at the SMA connector to the feed point. The Return Loss ensures low reflected power. No uncertainty required.
- *Electrical Delay:* One-way delay between the SMA connector and the antenna feed point. No uncertainty required.
- *SAR measured:* SAR measured at the stated antenna input power.
- *SAR normalized:* SAR as measured, normalized to an input power of 1 W at the antenna connector.
- *SAR for nominal TSL parameters:* The measured TSL parameters are used to calculate the nominal SAR result.

The reported uncertainty of measurement is stated as the standard uncertainty of Measurement multiplied by the coverage factor  $k=2$ , which for a normal distribution Corresponds to a coverage probability of approximately 95%.





Add: No.52 HuaYuanBei Road, Haidian District, Beijing, 100191, China  
Tel: +86-10-62304633-2117  
E-mail: cttl@chinattl.com <http://www.caict.ac.cn>

### Measurement Conditions

DASY system configuration, as far as not given on page 1.

DASY Version	DASY52	52.10.4
Extrapolation	Advanced Extrapolation	
Phantom	Triple Flat Phantom 5.1C	
Distance Dipole Center - TSL	10 mm	with Spacer
Zoom Scan Resolution	dx, dy = 4 mm, dz = 1.4 mm	Graded Ratio = 1.4 (Z direction)
Frequency	3700 MHz ± 1 MHz	

### Head TSL parameters at 3700MHz

The following parameters and calculations were applied.

	Temperature	Permittivity	Conductivity
Nominal Head TSL parameters	22.0 °C	37.7	3.12 mho/m
Measured Head TSL parameters	(22.0 ± 0.2) °C	37.1 ± 6 %	3.11 mho/m ± 6 %
Head TSL temperature change during test	<1.0 °C	---	---

### SAR result with Head TSL at 3700MHz

<b>SAR averaged over 1 cm<sup>3</sup> (1 g) of Head TSL</b>	Condition	
SAR measured	100 mW input power	6.69 W/kg
SAR for nominal Head TSL parameters	normalized to 1W	<b>66.7 W/kg ± 24.4 % (k=2)</b>
<b>SAR averaged over 10 cm<sup>3</sup> (10 g) of Head TSL</b>	Condition	
SAR measured	100 mW input power	2.47 W/kg
SAR for nominal Head TSL parameters	normalized to 1W	<b>24.6 W/kg ± 24.2 % (k=2)</b>



Add: No.52 HuaYuanBei Road, Haidian District, Beijing, 100191, China  
Tel: +86-10-62304633-2117  
E-mail: cttl@chinattl.com      <http://www.caict.ac.cn>

## Appendix (Additional assessments outside the scope of CNAS L0570)

### Antenna Parameters with Head TSL at 3700MHz

Impedance, transformed to feed point	46.2Ω+ 0.31jΩ
Return Loss	- 28.1dB

### General Antenna Parameters and Design

Electrical Delay (one direction)	1.048 ns
----------------------------------	----------

After long term use with 100W radiated power, only a slight warming of the dipole near the feed-point can be measured.

The dipole is made of standard semirigid coaxial cable. The center conductor of the feeding line is directly connected to the second arm of the dipole. The antenna is therefore short-circuited for DC-signals. On some of the dipoles, small end caps are added to the dipole arms in order to improve matching when loaded according to the position as explained in the "Measurement Conditions" paragraph. The SAR data are not affected by this change. The overall dipole length is still according to the Standard. No excessive force must be applied to the dipole arms, because they might bend or the soldered connections near the feed-point may be damaged.

### Additional EUT Data

Manufactured by	SPEAG
-----------------	-------



Add: No.52 HuaYuanBei Road, Haidian District, Beijing, 100191, China  
 Tel: +86-10-62304633-2117  
 E-mail: cttl@chinattl.com <http://www.caict.ac.cn>

Date: 2022-05-09

**DASY5 Validation Report for Head TSL**

Test Laboratory: CTTL, Beijing, China

**DUT: Dipole 3700 MHz; Type: D3700V2; Serial: D3700V2 - SN: 1037**

Communication System: UID 0, CW; Frequency: 3700 MHz; Duty Cycle: 1:1

Medium parameters used:  $f = 3700$  MHz;  $\sigma = 3.106$  S/m;  $\epsilon_r = 37.12$ ;  $\rho = 1000$  kg/m<sup>3</sup>

Phantom section: Right Section

Measurement Standard: DASY5 (IEEE/IEC/ANSI C63.19-2007)

DASY5 Configuration:

- Probe: EX3DV4 - SN7307; ConvF(6.73, 6.73, 6.73) @ 3700 MHz; Calibrated: 2021-05-26
- Sensor-Surface: 1.4mm (Mechanical Surface Detection)
- Electronics: DAE4 Sn1556; Calibrated: 2022-01-12
- Phantom: MFP\_V5.1C (20deg probe tilt); Type: QD 000 P51 Cx; Serial: 1062
- DASY52 52.10.4(1535); SEMCAD X 14.6.14(7501)

**Dipole Calibration /Pin=100mW, d=10mm, f=3700 MHz/Zoom Scan, dist=1.4mm (8x8x7)/Cube 0:** Measurement grid: dx=4mm, dy=4mm, dz=1.4mm  
 Reference Value = 62.62 V/m; Power Drift = -0.05 dB  
 Peak SAR (extrapolated) = 18.1 W/kg  
**SAR(1 g) = 6.69 W/kg; SAR(10 g) = 2.47 W/kg**  
 Smallest distance from peaks to all points 3 dB below = 8 mm  
 Ratio of SAR at M2 to SAR at M1 = 75%  
 Maximum value of SAR (measured) = 12.6 W/kg

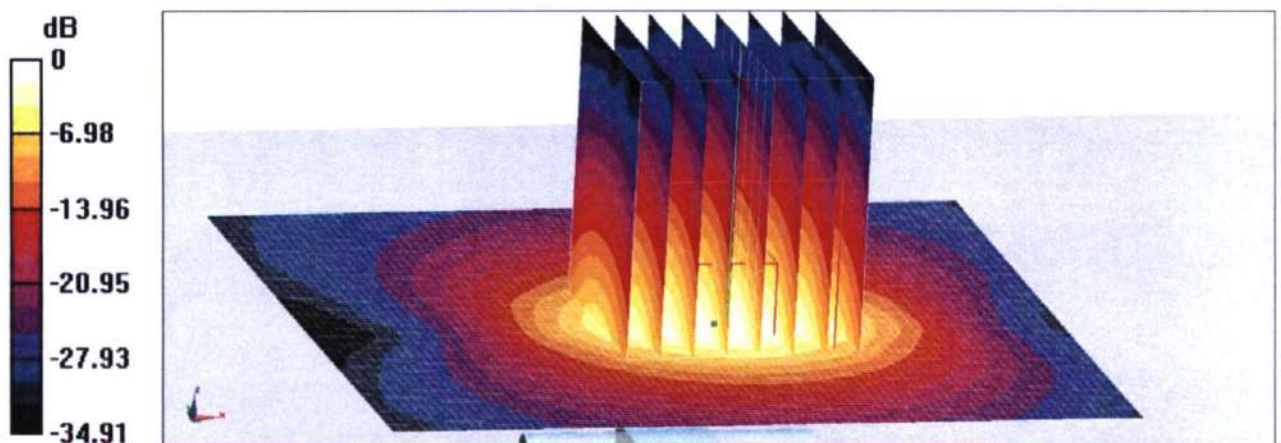

**0 dB = 12.6 W/kg = 11.00 dBW/kg**





Add: No.52 HuaYuanBei Road, Haidian District, Beijing, 100191, China  
Tel: +86-10-62304633-2117  
E-mail: cttl@chinattl.com      <http://www.caict.ac.cn>

### Impedance Measurement Plot for Head TSL

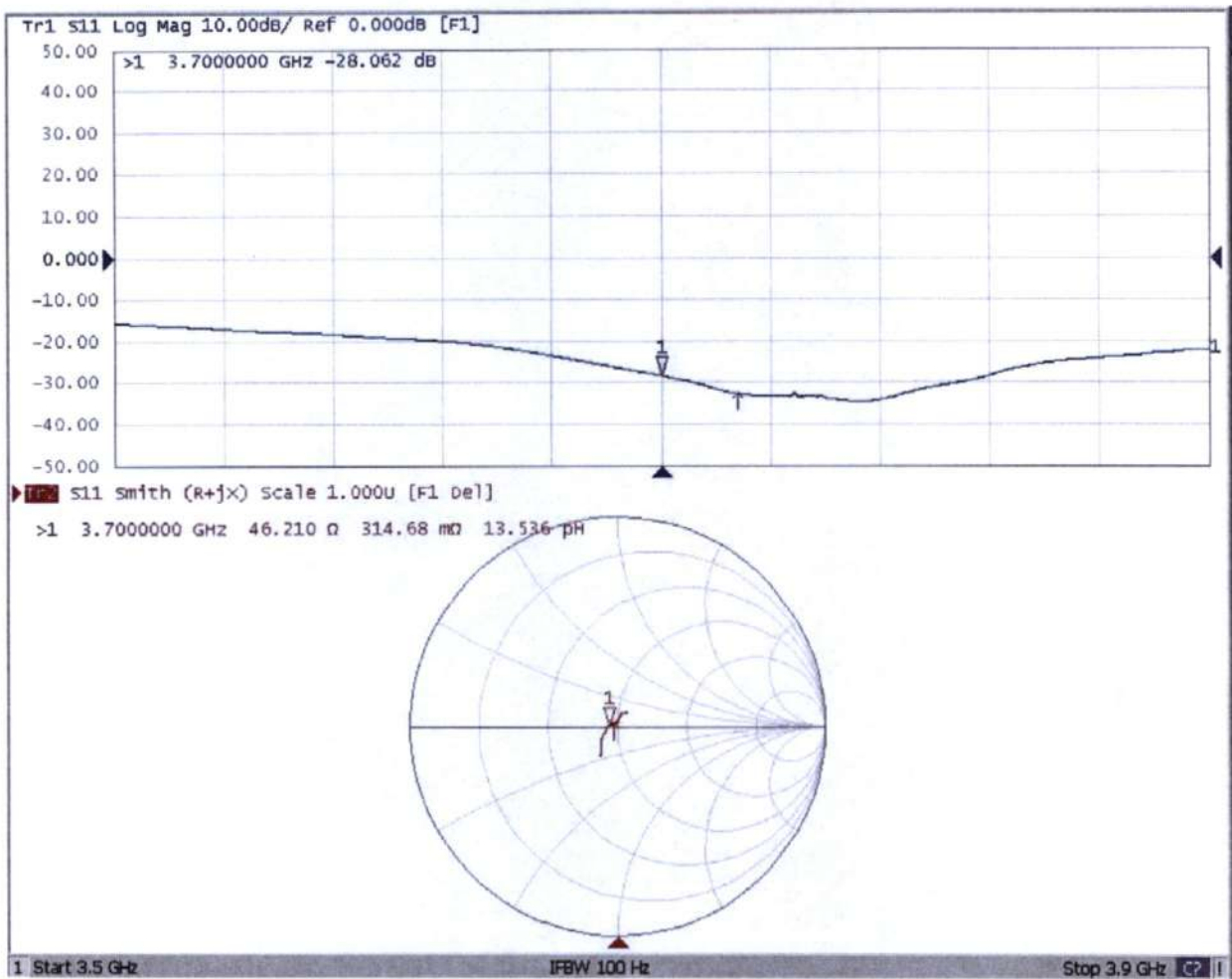

## D3700V2, Serial No. 1037 Extended Dipole Calibrations

if dipoles are verified in return loss (<-20dB, within 20% of prior calibration), and in impedance (within 5 ohm of prior calibration), the annual calibration is not necessary and the calibration interval can be extended.

D3700V2 – serial no. 1037						
3700 Head						
Date of Measurement	Return-Loss (dB)	Delta (%)	Real Impedance (ohm)	Delta (ohm)	Imaginary Impedance (ohm)	Delta (ohm)
2022.5.9	-28.1		46.2		0.3	
2023.5.8	-26.7	-5.0%	48.9	-2.7	-0.3	0.6

### <Justification of the extended calibration>

The return loss is < -20dB, within 20% of prior calibration; the impedance is within 5 ohm of prior calibration. Therefore the verification result should support extended calibration.

Dipole Verification Data> D3700V2, serial no. 1037

3700MHz - Head----2023.5.8

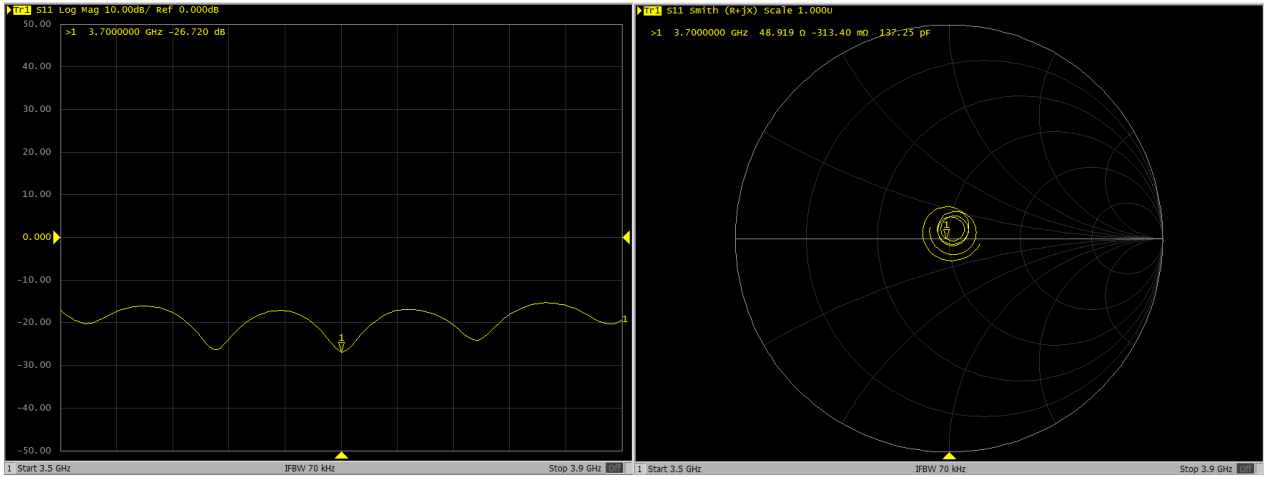





Accredited by the Swiss Accreditation Service (SAS)  
The Swiss Accreditation Service is one of the signatories to the EA  
Multilateral Agreement for the recognition of calibration certificates

Client **Sporton**  
**Kunshan City, China**

Certificate No. **D3900V2-1048\_Mar23**

## CALIBRATION CERTIFICATE

Object **D3900V2 - SN:1048**

Calibration procedure(s) **QA CAL-22.v7**  
**Calibration Procedure for SAR Validation Sources between 3-10 GHz**

Calibration date: **March 09, 2023**

This calibration certificate documents the traceability to national standards, which realize the physical units of measurements (SI).  
The measurements and the uncertainties with confidence probability are given on the following pages and are part of the certificate.

All calibrations have been conducted in the closed laboratory facility: environment temperature (22 ± 3)°C and humidity < 70%.

Calibration Equipment used (M&TE critical for calibration)

Primary Standards	ID #	Cal Date (Certificate No.)	Scheduled Calibration
Power meter NRP	SN: 104778	04-Apr-22 (No. 217-03525/03524)	Apr-23
Power sensor NRP-Z91	SN: 103244	04-Apr-22 (No. 217-03524)	Apr-23
Power sensor NRP-Z91	SN: 103245	04-Apr-22 (No. 217-03525)	Apr-23
Reference 20 dB Attenuator	SN: BH9394 (20k)	04-Apr-22 (No. 217-03527)	Apr-23
Type-N mismatch combination	SN: 310982 / 06327	04-Apr-22 (No. 217-03528)	Apr-23
Reference Probe EX3DV4	SN: 3503	07-Mar-23 (No. EX3-3503_Mar23)	Mar-24
DAE4	SN: 601	19-Dec-22 (No. DAE4-601_Dec22)	Dec-23
Secondary Standards	ID #	Check Date (in house)	Scheduled Check
Power meter E4419B	SN: GB39512475	30-Oct-14 (in house check Oct-22)	In house check: Oct-24
Power sensor HP 8481A	SN: US37292783	07-Oct-15 (in house check Oct-22)	In house check: Oct-24
Power sensor HP 8481A	SN: MY41093315	07-Oct-15 (in house check Oct-22)	In house check: Oct-24
RF generator R&S SMT-06	SN: 100972	15-Jun-15 (in house check Oct-22)	In house check: Oct-24
Network Analyzer Agilent E8358A	SN: US41080477	31-Mar-14 (in house check Oct-22)	In house check: Oct-24

Calibrated by: **Jeton Kastrati**      Function: **Laboratory Technician**      Signature:

Approved by: **Sven Kühn**      Technical Manager     

Issued: March 21, 2023

This calibration certificate shall not be reproduced except in full without written approval of the laboratory.



Accredited by the Swiss Accreditation Service (SAS)

The Swiss Accreditation Service is one of the signatories to the EA  
Multilateral Agreement for the recognition of calibration certificates

Accreditation No.: **SCS 0108**

### Glossary:

TSL	tissue simulating liquid
ConvF	sensitivity in TSL / NORM x,y,z
N/A	not applicable or not measured

### Calibration is Performed According to the Following Standards:

- IEC/IEEE 62209-1528, "Measurement Procedure For The Assessment Of Specific Absorption Rate Of Human Exposure To Radio Frequency Fields From Hand-Held And Body-Worn Wireless Communication Devices - Part 1528: Human Models, Instrumentation And Procedures (Frequency Range of 4 MHz to 10 GHz)", October 2020.
- KDB 865664, "SAR Measurement Requirements for 100 MHz to 6 GHz"

### Additional Documentation:

- DASY System Handbook

### Methods Applied and Interpretation of Parameters:

- Measurement Conditions:** Further details are available from the Validation Report at the end of the certificate. All figures stated in the certificate are valid at the frequency indicated.
- Antenna Parameters with TSL:** The source is mounted in a touch configuration below the center marking of the flat phantom.
- Return Loss:** This parameter is measured with the source positioned under the liquid filled phantom (as described in the measurement condition clause). The Return Loss ensures low reflected power. No uncertainty required.
- SAR measured:** SAR measured at the stated antenna input power.
- SAR normalized:** SAR as measured, normalized to an input power of 1 W at the antenna connector.
- SAR for nominal TSL parameters:** The measured TSL parameters are used to calculate the nominal SAR result.

The reported uncertainty of measurement is stated as the standard uncertainty of measurement multiplied by the coverage factor  $k=2$ , which for a normal distribution corresponds to a coverage probability of approximately 95%.



## Measurement Conditions

DASY system configuration, as far as not given on page 1.

<b>DASY Version</b>	DASY52	V52.10.4
<b>Extrapolation</b>	Advanced Extrapolation	
<b>Phantom</b>	Modular Flat Phantom V5.0	
<b>Distance Dipole Center - TSL</b>	10 mm	with Spacer
<b>Zoom Scan Resolution</b>	dx, dy = 4.0 mm, dz = 1.4 mm	Graded Ratio = 1.4 (Z direction)
<b>Frequency</b>	3900 MHz ± 1 MHz 4100 MHz ± 1 MHz	

## Head TSL parameters at 3900 MHz

The following parameters and calculations were applied.

	Temperature	Permittivity	Conductivity
<b>Nominal Head TSL parameters</b>	22.0 °C	37.5	3.32 mho/m
<b>Measured Head TSL parameters</b>	(22.0 ± 0.2) °C	37.3 ± 6 %	3.23 mho/m ± 6 %
<b>Head TSL temperature change during test</b>	< 0.5 °C	----	----

## SAR result with Head TSL at 3900 MHz

<b>SAR averaged over 1 cm<sup>3</sup> (1 g) of Head TSL</b>	Condition	
SAR measured	100 mW input power	6.88 W/kg
SAR for nominal Head TSL parameters	normalized to 1W	<b>69.1 W/kg ± 19.9 % (k=2)</b>

<b>SAR averaged over 10 cm<sup>3</sup> (10 g) of Head TSL</b>	condition	
SAR measured	100 mW input power	2.41 W/kg
SAR for nominal Head TSL parameters	normalized to 1W	<b>24.1 W/kg ± 19.5 % (k=2)</b>

## Head TSL parameters at 4100 MHz

The following parameters and calculations were applied.

	Temperature	Permittivity	Conductivity
<b>Nominal Head TSL parameters</b>	22.0 °C	37.2	3.53 mho/m
<b>Measured Head TSL parameters</b>	(22.0 ± 0.2) °C	37.1 ± 6 %	3.41 mho/m ± 6 %
<b>Head TSL temperature change during test</b>	< 0.5 °C	----	----

## SAR result with Head TSL at 4100 MHz

<b>SAR averaged over 1 cm<sup>3</sup> (1 g) of Head TSL</b>	Condition	
SAR measured	100 mW input power	6.68 W/kg
SAR for nominal Head TSL parameters	normalized to 1W	<b>67.0 W/kg ± 19.9 % (k=2)</b>

<b>SAR averaged over 10 cm<sup>3</sup> (10 g) of Head TSL</b>	condition	
SAR measured	100 mW input power	2.33 W/kg
SAR for nominal Head TSL parameters	normalized to 1W	<b>23.3 W/kg ± 19.5 % (k=2)</b>