



# FCC RF Test Report

**APPLICANT** : Motorola Mobility LLC  
**EQUIPMENT** : Mobile Cellular Phone  
**BRAND NAME** : Motorola  
**MODEL NAME** : XT2431-2, XT2431-3  
**FCC ID** : IHDT56AM6  
**STANDARD** : 47 CFR Part 2,27(M)  
**CLASSIFICATION** : PCS Licensed Transmitter Held to Ear (PCE)  
**TEST DATE(S)** : Nov. 30, 2023 ~ Dec. 14, 2023

We, Sporton International Inc. (Kunshan), would like to declare that the tested sample has been evaluated in accordance with the procedures given in ANSI C63.26-2015 and shown compliance with the applicable technical standards.

This report contains data that were produced under subcontract by Sporton International Inc. (Shenzhen)

The test results in this report apply exclusively to the tested model / sample. Without written approval of Sporton International Inc. (Kunshan), the test report shall not be reproduced except in full.

Jason Jia

Approved by: Jason Jia



**Sporton International Inc. (Kunshan)**

**No. 1098, Pengxi North Road, Kunshan Economic Development Zone Jiangsu Province 215300  
People's Republic of China**



TABLE OF CONTENTS

REVISION HISTORY... 3
SUMMARY OF TEST RESULT ... 4
1 GENERAL DESCRIPTION ... 5
1.1 Applicant ... 5
1.2 Manufacturer ... 5
1.3 Product Feature of Equipment Under Test ... 5
1.4 Product Specification of Equipment Under Test ... 5
1.5 Modification of EUT ... 6
1.6 Maximum EIRP Power and Emission Designator ... 6
1.7 Testing Location ... 7
1.8 Test Software ... 7
1.9 Applicable Standards ... 8
1.10 Specification of Accessory ... 8
2 TEST CONFIGURATION OF EQUIPMENT UNDER TEST ... 9
2.1 Test Mode ... 9
2.2 Connection Diagram of Test System ... 10
2.3 Support Unit used in test configuration and system ... 11
2.4 Measurement Results Explanation Example ... 11
2.5 Frequency List of Low/Middle/High Channels ... 11
3 CONDUCTED TEST ITEMS ... 14
3.1 Measuring Instruments ... 14
3.2 Test Setup ... 14
3.3 Test Result of Conducted Test ... 14
3.4 Conducted Output Power and ERP/EIRP ... 15
3.5 Peak-to-Average Ratio ... 16
3.6 Occupied Bandwidth ... 17
3.7 Conducted Band Edge ... 18
3.8 Conducted Spurious Emission ... 19
3.9 Frequency Stability ... 20
4 RADIATED TEST ITEMS ... 21
4.1 Measuring Instruments ... 21
4.2 Test Setup ... 21
4.3 Test Result of Radiated Test ... 22
4.4 Radiated Spurious Emission ... 23
5 LIST OF MEASURING EQUIPMENT ... 24
6 MEASUREMENT UNCERTAINTY ... 25
APPENDIX A. TEST RESULTS OF CONDUCTED TEST
APPENDIX B. TEST RESULTS OF RADIATED TEST
APPENDIX C. TEST SETUP PHOTOGRAPHS





### SUMMARY OF TEST RESULT

| Report Section | FCC Rule                     | Description   | Limit                               | Result      | Remark                               |
|----------------|------------------------------|---|-------------------------------------|-------------|--------------------------------------|
| 3.4            | §2.1046                      | Conducted Output Power                                  | -                                   | Report Only | -                                    |
|                | §27.50(h)(2)                 | Equivalent Isotropic Radiated Power (Band 38) (Band 41) | EIRP < 2Watt                        | PASS        | -                                    |
| 3.5            | §24.232(d)                   | Peak-to-Average Ratio                                   | <13 dB                              | PASS        | -                                    |
| 3.6            | §2.1049                      | Occupied Bandwidth                                      | -                                   | Report Only | -                                    |
| 3.7            | §27.53(m)(4)                 | Conducted Band Edge Measurement (Band 38) (Band 41)     | §27.53(m)(4)                        | PASS        | -                                    |
| 3.8            | §2.1051<br>§27.53(m)(4)      | Conducted Spurious Emission (Band 38) (Band 41)         | < 55+10log <sub>10</sub> (P[Watts]) | PASS        | -                                    |
| 3.9            | §2.1055<br>§22.355           | Frequency Stability Temperature & Voltage               | < 2.5 ppm for Part 22               | PASS        | -                                    |
|                | §2.1055<br>§24.235<br>§27.54 |   | Within Authorized Band              |             |                                      |
| 4.4            | §2.1053<br>§27.53(m)(4)      | Radiated Spurious Emission (Band 7) (Band 38) (Band 41) | < 55+10log <sub>10</sub> (P[Watts]) | PASS        | Under limit 17.66 dB at 10291.00 MHz |

**Conformity Assessment Condition:**

- The test results (PASS/FAIL) with all measurement uncertainty excluded are presented against the regulation limits or in accordance with the requirements stipulated by the applicant/manufacturer who shall bear all the risks of non-compliance that may potentially occur if measurement uncertainty is taken into account.
- The measurement uncertainty please refer to each test result in the section "Measurement Uncertainty"

**Disclaimer:**

The product specifications of the EUT presented in the test report that may affect the test assessments are declared by the manufacturer who shall take full responsibility for the authenticity.



# 1 General Description

## 1.1 Applicant

Motorola Mobility LLC  
222 W,Merchandise Mart Plaza, Chicago IL 60654 USA

## 1.2 Manufacturer

Motorola Mobility LLC  
222 W,Merchandise Mart Plaza, Chicago IL 60654 USA

## 1.3 Product Feature of Equipment Under Test

| Product Feature |  |
|-----------------|--|
| Equipment       | Mobile Cellular Phone  |
| Brand Name      | Motorola   |
| Model Name      | XT2431-2, XT2431-3   |
| FCC ID          | IHDT56AM6  |
| IMEI Code       | Conducted: 355221240002058/355221240002066<br>Radiation: 355221240002157 |
| HW Version      | DVT  |
| SW Version      | U1TD34.37  |
| EUT Stage       | Identical Prototype  |

## 1.4 Product Specification of Equipment Under Test

| Standards-related Product Specification |  |
|---|--|
| Tx Frequency                            | LTE Band 38 : 2570 MHz ~ 2620 MHz<br>LTE Band 41 : 2496 MHz ~ 2690 MHz   |
| Rx Frequency                            | LTE Band 38: 2570 MHz ~ 2620 MHz<br>LTE Band 41 : 2496 MHz ~ 2690 MHz  |
| Bandwidth                               | LTE Band 38 : 5MHz / 10MHz / 15MHz / 20MHz<br>LTE Band 41 : 5MHz / 10MHz / 15MHz / 20MHz                                     |
| Maximum Output Power to Antenna         | <Ant1><br>LTE Band 41 : 22.95 dBm<br><Ant4><br>LTE Band 38 : 22.79 dBm<br>LTE Band 41 : 25.46 dBm / LTE Band 41C : 25.21 dBm |
| Antenna Gain                            | <Ant1><br>LTE Band 41 : -4.10 dBi<br><Ant4><br>LTE Band 38 : -4.24 dBi<br>LTE Band 41 : -4.24 dBi                            |
| Type of Modulation                      | QPSK / 16QAM / 64QAM   |

Remark:



1. The maximum EIRP is calculated from max output power and max antenna gain, so only the maximum EIRP of Ant.4 for Band 38/41/41C are shown in the report.
2. LTE Band 41 on Antenna 1 only works in EN-DC mode
3. LTE Band 41 on Antenna 4 support HPUE mode.

### 1.5 Modification of EUT

No modifications are made to the EUT during all test items.

### 1.6 Maximum EIRP Power and Emission Designator

| LTE Band 38 |                       | QPSK            |                              | 16QAM/64QAM     |                              |
|-------------|-----------------------|-----------------|------------------------------|-----------------|------------------------------|
| BW (MHz)    | Frequency Range (MHz) | Maximum EIRP(W) | Emission Designator (99%OBW) | Maximum EIRP(W) | Emission Designator (99%OBW) |
| 5           | 2572.5 ~ 2617.5       | 0.0700          | 4M50G7D                      | 0.0600          | 4M49W7D                      |
| 10          | 2575.0 ~ 2615.0       | 0.0701          | 9M07G7D                      | 0.0601          | 9M25W7D                      |
| 15          | 2577.5 ~ 2612.5       | 0.0701          | 13M5G7D                      | 0.0600          | 13M5W7D                      |
| 20          | 2580.0 ~ 2610.0       | 0.0716          | 17M7G7D                      | 0.0612          | 17M9W7D                      |
| LTE Band 41 |                       | QPSK            |                              | 16QAM/64QAM     |                              |
| BW (MHz)    | Frequency Range (MHz) | Maximum EIRP(W) | Emission Designator (99%OBW) | Maximum EIRP(W) | Emission Designator (99%OBW) |
| 5           | 2498.5 ~ 2687.5       | 0.1297          | 4M50G7D                      | 0.0995          | 4M49W7D                      |
| 10          | 2501.0 ~ 2685.0       | 0.1303          | 9M07G7D                      | 0.0995          | 9M25W7D                      |
| 15          | 2503.5 ~ 2682.5       | 0.1306          | 13M5G7D                      | 0.0995          | 13M5W7D                      |
| 20          | 2506.0 ~ 2680.0       | 0.1324          | 17M7G7D                      | 0.1016          | 17M9W7D                      |

| LTE Band 41 CA | QPSK            |                              | 16QAM/64QAM     |                              |
|----------------|-----------------|------------------------------|-----------------|------------------------------|
| BW (MHz)       | Maximum EIRP(W) | Emission Designator (99%OBW) | Maximum EIRP(W) | Emission Designator (99%OBW) |
| 5MHz+20MHz     | 0.1183          | 22M7G7D                      | 0.0948          | 23M1W7D                      |
| 10MHz+20MHz    | 0.1197          | 27M9G7D                      | 0.0948          | 27M4W7D                      |
| 10MHz+15MHz    | 0.1189          | 23M5G7D                      | 0.0935          | 23M4W7D                      |
| 15MHz+15MHz    | 0.1202          | 28M4G7D                      | 0.0953          | 28M4W7D                      |
| 15MHz+20MHz    | 0.1205          | 32M5G7D                      | 0.0935          | 32M4W7D                      |
| 15MHz+10MHz    | 0.1180          | 23M5G7D                      | 0.0929          | 23M3W7D                      |
| 20MHz+5MHz     | 0.1199          | 23M1G7D                      | 0.0957          | 23M1W7D                      |
| 20MHz+10MHz    | 0.1211          | 28M3G7D                      | 0.0959          | 27M8W7D                      |



|             |        |         |        |         |
|-------------|--------|---------|--------|---------|
| 20MHz+15MHz | 0.1194 | 32M8G7D | 0.0944 | 32M7W7D |
| 20MHz+20MHz | 0.1250 | 36M8G7D | 0.0971 | 37M4W7D |

Note:LTE Band 41 overlaps the entire frequency range of LTE Band 38. Therefore, the test results provided in this report covers Band 41 as well as Band 38.

### 1.7 Testing Location

Sporton International Inc. (Kunshan) is accredited to ISO/IEC 17025:2017 by American Association for Laboratory Accreditation with Certificate Number 5145.02.

|                           |  |                            |                                       |
|---------------------------|--|----------------------------|---------------------------------------|
| <b>Test Firm</b>          | Sporton International Inc. (Kunshan)   |                            |                                       |
| <b>Test Site Location</b> | No. 1098, Pengxi North Road, Kunshan Economic Development Zone<br>Jiangsu Province 215300 People’s Republic of China<br>TEL : +86-512-57900158 |                            |                                       |
| <b>Test Site No.</b>      | <b>Sporton Site No.</b>  | <b>FCC Designation No.</b> | <b>FCC Test Firm Registration No.</b> |
|                           | 03CH04-KS  | CN1257                     | 314309                                |

Sporton International Inc. (ShenZhen) is accredited to ISO/IEC 17025:2017 by American Association for Laboratory Accreditation with Certificate Number 5145.01.

|                           |   |                            |                                       |
|---------------------------|---|----------------------------|---------------------------------------|
| <b>Test Firm</b>          | Sporton International Inc. (ShenZhen)   |                            |                                       |
| <b>Test Site Location</b> | 1/F, 2/F, Bldg 5, Shiling Industrial Zone, Xinwei Village, Xili, Nanshan, Shenzhen, 518055 People’s Republic of China<br>TEL: +86-755-86379589<br>FAX: +86-755-86379595 |                            |                                       |
| <b>Test Site No.</b>      | <b>Sporton Site No.</b>   | <b>FCC Designation No.</b> | <b>FCC Test Firm Registration No.</b> |
|                           | TH01-SZ   | CN1256                     | 421272                                |

### 1.8 Test Software

| Item | Site      | Manufacture | Name | Version |
|------|-----------|-------------|------|---------|
| 1.   | 03CH04-KS | AUDIX       | E3   | 210616  |



### 1.9 Applicable Standards

According to the specifications of the manufacturer, the EUT must comply with the requirements of the following standards:

- ♦ 47 CFR Part 2,27(M)
- ♦ ANSI C63.26-2015
- ♦ FCC KDB 971168 D01 Power Meas License Digital Systems v03r01
- ♦ FCC KDB 412172 D01 Determining ERP and EIRP v01r01

**Remark:**

1. All test items were verified and recorded according to the standards and without any deviation during the test.
2. This EUT has also been tested and complied with the requirements of FCC Part 15, Subpart B, recorded in a separate test report.

### 1.10 Specification of Accessory

| Accessories Information |            |                  |            |      |
|-------------------------|------------|------------------|------------|------|
| Battery 1               | Brand Name | Motorola (ATL)   | Model Name | QA50 |
| Battery 2               | Brand Name | Motorola (Jiade) | Model Name | QF50 |





## 2 Test Configuration of Equipment Under Test

### 2.1 Test Mode

Antenna port conducted and radiated test items listed below are performed according to KDB 971168 D01 Power Meas License Digital Systems v03r01 with maximum output power.

Radiated measurements are performed by rotating the EUT in three different orthogonal test planes to find the maximum emission. (Y Plane)

| Test Items                  | Band  | Bandwidth (MHz) |   |   |    |    |    | Modulation |       |       | RB # |      |      | Test Channel |   |   |   |
|-----------------------------|---|-----------------|---|---|----|----|----|------------|-------|-------|------|------|------|--------------|---|---|---|
|                             |   | 1.4             | 3 | 5 | 10 | 15 | 20 | QPSK       | 16QAM | 64QAM | 1    | Half | Full | L            | M | H |   |
| Max. Output Power           | 38  | -               | - | v | v  | v  | v  | v          | v     | v     | v    |      |      | v            | v | v | v |
|                             | 41  | -               | - | v | v  | v  | v  | v          | v     | v     | v    |      |      | v            | v | v | v |
| Peak-to-Average Ratio       | 41  | -               | - |   |    |    | v  | v          | v     | v     |      |      |      | v            |   | v |   |
| 26dB and 99% Bandwidth      | 41  | -               | - | v | v  | v  | v  | v          | v     |       |      |      |      | v            |   | v |   |
| Conducted Band Edge         | 41  | -               | - | v | v  | v  | v  | v          | v     | v     | v    |      |      | v            | v |   | v |
| Conducted Spurious Emission | 41  | -               | - | v | v  | v  | v  | v          |       |       |      | v    |      |              | v | v | v |
| Frequency Stability         | 41  | -               | - |   | v  |    |    | v          |       |       |      |      |      | v            |   | v |   |
| E.I.R.P.                    | 38  | -               | - | v | v  | v  | v  | v          | v     | v     | v    |      |      | v            | v | v | v |
|                             | 41  | -               | - | v | v  | v  | v  | v          | v     | v     | v    |      |      | v            | v | v | v |
| Radiated Spurious Emission  | 41  | Worst Case      |   |   |    |    |    |            |       |       |      |      |      |              | v |   |   |
| Note                        | <ol style="list-style-type: none"> <li>The mark "v " means that this configuration is chosen for testing</li> <li>The mark "- " means that this bandwidth is not supported.</li> <li>The device is investigated from 30MHz to 10 times of fundamental signal for radiated spurious emission test under different RB size/offset and modulations in exploratory test. Subsequently, only the worst case emissions are reported.</li> </ol> |                 |   |   |    |    |    |            |       |       |      |      |      |              |   |   |   |



| Test Items                  | Band   | Bandwidth (MHz) |       |       |       |       |      |      |       |       |       | Modulation |       |       | RB # |      |      | Test Channel |   |   |   |  |
|-----------------------------|--|-----------------|-------|-------|-------|-------|------|------|-------|-------|-------|------------|-------|-------|------|------|------|--------------|---|---|---|--|
|                             |  | 20+20           | 20+15 | 15+20 | 20+10 | 10+20 | 20+5 | 5+20 | 15+15 | 15+10 | 10+15 | QPSK       | 16QAM | 64QAM | 1    | Half | Full | L            | M | H |   |  |
| Max. Output Power           | 41C_CA   | v               | v     | v     | v     | v     | v    | v    | v     | v     | v     | v          | v     | v     | v    | v    |      |              |   | v |   |  |
| 26dB and 99% Bandwidth      | 41C_CA   | v               | v     | v     | v     | v     | v    | v    | v     | v     | v     | v          | v     | v     |      |      |      | v            |   | v |   |  |
| Conducted Band Edge         | 41C_CA   | v               | v     | v     | v     | v     | v    | v    | v     | v     | v     | v          | v     | v     | v    | v    | v    | v            | v | v | v |  |
| Conducted Spurious Emission | 41C_CA   | v               | v     | v     | v     | v     | v    | v    | v     | v     | v     | v          | v     |       |      | v    |      |              | v | v | v |  |
| E.I.R.P.                    | 41C_CA   | v               | v     | v     | v     | v     | v    | v    | v     | v     | v     | v          | v     | v     | v    | v    |      |              |   | v |   |  |
| Radiated Spurious Emission  | 41C_CA   | Worst Case      |       |       |       |       |      |      |       |       |       |            |       |       |      |      |      |              |   |   | v |  |
| Note                        | 1. The mark "v" means that this configuration is chosen for testing<br>2. The mark "-" means that this bandwidth is not supported.<br>3. The device is investigated from 30MHz to 10 times of fundamental signal for radiated spurious emission test under different RB size/offset and modulations in exploratory test. Subsequently, only the worst case emissions are reported. |                 |       |       |       |       |      |      |       |       |       |            |       |       |      |      |      |              |   |   |   |  |

## 2.2 Connection Diagram of Test System

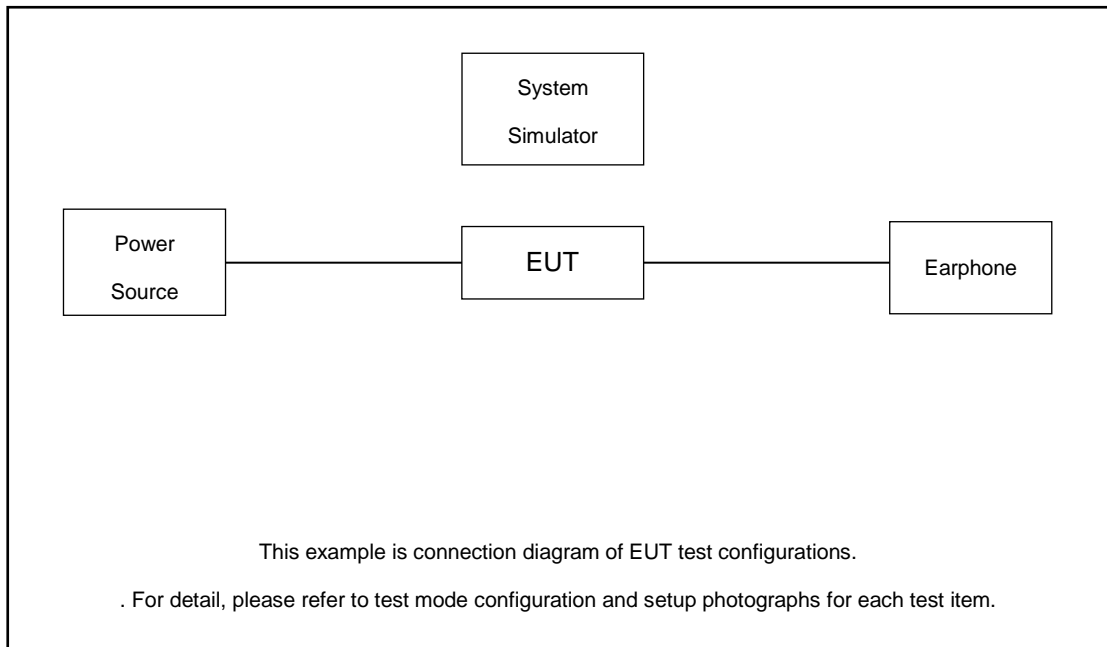

### 2.3 Support Unit used in test configuration and system

| Item | Equipment        | Trade Name | Model No. | FCC ID | Data Cable | Power Cord        |
|------|------------------|------------|-----------|--------|------------|-------------------|
| 1.   | Power Supply     | GWINSTEK   | PSS-2002  | N/A    | N/A        | Unshielded, 1.8 m |
| 2.   | LTE Base Station | Anritsu    | MT8820C   | N/A    | N/A        | Unshielded, 1.8 m |
| 3.   | Adapter          | MOTO       | MC-20L    | N/A    | N/A        | N/A               |
| 4.   | USB Cable        | saibao     | N/A       | N/A    | N/A        | N/A               |
| 5.   | Earphone         | MOTO       | N/A       | N/A    | N/A        | N/A               |

### 2.4 Measurement Results Explanation Example

For all conducted test items:

The offset level is set in the spectrum analyzer to compensate the RF cable loss and attenuator factor between EUT conducted output port and spectrum analyzer. With the offset compensation, the spectrum analyzer reading level is exactly the EUT RF output level.

The spectrum analyzer offset is derived from RF cable loss and attenuator factor.

*Offset = RF cable loss + attenuator factor.*

Following shows an offset computation example with cable loss 5.0 dB and 10dB attenuator.

Example :

$$\begin{aligned} \text{Offset(dB)} &= \text{RF cable loss(dB)} + \text{attenuator factor(dB)}. \\ &= 5.0 + 10 = 15.0 \text{ (dB)} \end{aligned}$$

### 2.5 Frequency List of Low/Middle/High Channels

| LTE Band 38 Channel and Frequency List |                        |        |        |         |
|--|------------------------|--------|--------|---------|
| BW [MHz]                               | Channel/Frequency(MHz) | Lowest | Middle | Highest |
| 20                                     | Channel                | 37850  | 38000  | 38150   |
|  | Frequency              | 2580   | 2595   | 2610    |
| 15                                     | Channel                | 37825  | 38000  | 38175   |
|  | Frequency              | 2577.5 | 2595   | 2612.5  |
| 10                                     | Channel                | 37800  | 38000  | 38200   |
|  | Frequency              | 2575   | 2595   | 2615    |
| 5                                      | Channel                | 37775  | 38000  | 38225   |
|  | Frequency              | 2572.5 | 2595   | 2617.5  |



| LTE Band 41 Channel and Frequency List |                        |        |        |         |
|--|------------------------|--------|--------|---------|
| BW [MHz]                               | Channel/Frequency(MHz) | Lowest | Middle | Highest |
| 20                                     | Channel                | 39750  | 40620  | 41490   |
|  | Frequency              | 2506   | 2593   | 2680    |
| 15                                     | Channel                | 39725  | 40620  | 41515   |
|  | Frequency              | 2503.5 | 2593   | 2682.5  |
| 10                                     | Channel                | 39700  | 40620  | 41540   |
|  | Frequency              | 2501   | 2593   | 2685    |
| 5                                      | Channel                | 39675  | 40620  | 41565   |
|  | Frequency              | 2498.5 | 2593   | 2687.5  |

| LTE Band 41C_CA Channel and Frequency List |                        |           |        |         |        |
|--|------------------------|-----------|--------|---------|--------|
| BW [MHz]                                   | Channel/Frequency(MHz) | Lowest    | Middle | Highest |        |
| 20 + 20                                    | PCC                    | Channel   | 39750  | 40521   | 41292  |
|  |                        | Frequency | 2506.0 | 2583.1  | 2660.2 |
|  | SCC                    | Channel   | 39948  | 40719   | 41490  |
|  |                        | Frequency | 2525.8 | 2602.9  | 2680.0 |
| 20 + 15                                    | PCC                    | Channel   | 39750  | 40546   | 41341  |
|  |                        | Frequency | 2506.0 | 2585.6  | 2665.1 |
|  | SCC                    | Channel   | 39921  | 40717   | 41512  |
|  |                        | Frequency | 2523.1 | 2602.7  | 2682.2 |
| 15 + 20                                    | PCC                    | Channel   | 39728  | 40523   | 41319  |
|  |                        | Frequency | 2503.8 | 2593.3  | 2662.9 |
|  | SCC                    | Channel   | 39899  | 40694   | 41490  |
|  |                        | Frequency | 2520.9 | 2600.4  | 2680.0 |
| 20 + 10                                    | PCC                    | Channel   | 39750  | 40571   | 41391  |
|  |                        | Frequency | 2506.0 | 2588.1  | 2670.1 |
|  | SCC                    | Channel   | 39894  | 40715   | 41535  |
|  |                        | Frequency | 2520.4 | 2602.5  | 2684.5 |
| 10 + 20                                    | PCC                    | Channel   | 39705  | 40526   | 41346  |
|  |                        | Frequency | 2501.5 | 2583.6  | 2665.6 |
|  | SCC                    | Channel   | 39849  | 40670   | 41490  |
|  |                        | Frequency | 2515.9 | 2598.0  | 2680.0 |



| LTE Band 41C_CA Channel and Frequency List |     |           |        |        |        |
|--|-----|-----------|--------|--------|--------|
| 20 + 5                                     | PCC | Channel   | 39750  | 40595  | 41440  |
|  |     | Frequency | 2506.0 | 2590.5 | 2675.0 |
|  | SCC | Channel   | 39867  | 40712  | 41557  |
|  |     | Frequency | 2517.7 | 2602.2 | 2686.7 |
| 5 + 20                                     | PCC | Channel   | 39683  | 40528  | 41373  |
|  |     | Frequency | 2499.3 | 2583.8 | 2668.3 |
|  | SCC | Channel   | 39800  | 40645  | 41490  |
|  |     | Frequency | 2511.0 | 2595.5 | 2680.0 |
| 15 + 15                                    | PCC | Channel   | 39725  | 40545  | 41365  |
|  |     | Frequency | 2503.5 | 2585.5 | 2667.5 |
|  | SCC | Channel   | 39875  | 40695  | 41515  |
|  |     | Frequency | 2518.5 | 2600.5 | 2682.5 |
| 10 + 15                                    | PCC | Channel   | 39703  | 40549  | 41395  |
|  |     | Frequency | 2501.3 | 2585.9 | 2670.5 |
|  | SCC | Channel   | 39823  | 40669  | 41515  |
|  |     | Frequency | 2513.3 | 2597.9 | 2682.5 |
| 15 + 10                                    | PCC | Channel   | 39725  | 40571  | 41417  |
|  |     | Frequency | 2503.5 | 2588.1 | 2672.7 |
|  | SCC | Channel   | 39845  | 40691  | 41537  |
|  |     | Frequency | 2515.5 | 2600.1 | 2684.7 |

### 3 Conducted Test Items

#### 3.1 Measuring Instruments

See list of measuring instruments of this test report.

#### 3.2 Test Setup

##### 3.2.1 Conducted Output Power

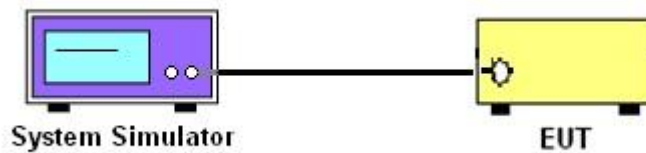

##### 3.2.2 Peak-to-Average Ratio, Occupied Bandwidth ,Conducted Band-Edge and Conducted Spurious Emission

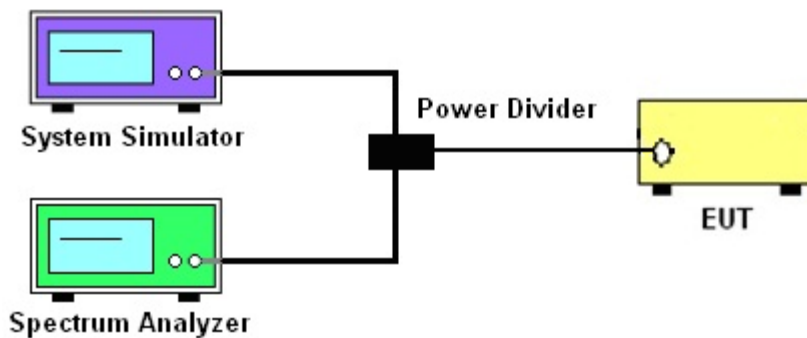

##### 3.2.3 Frequency Stability

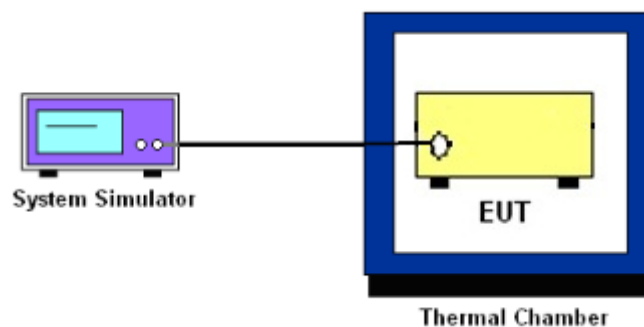

### 3.3 Test Result of Conducted Test

Please refer to Appendix A.



### 3.4 Conducted Output Power and ERP/EIRP

#### 3.4.1 Description of the Conducted Output Power Measurement and ERP/EIRP Measurement

A system simulator was used to establish communication with the EUT. Its parameters were set to force the EUT transmitting at maximum output power. The measured power in the radio frequency on the transmitter output terminals shall be reported.

The EIRP of mobile transmitters must not exceed 2 Watts for LTE Band 38 and Band 41.

According to KDB 412172 D01 Power Approach,

$EIRP = P_T + G_T - L_C$ ,  $ERP = EIRP - 2.15$ , where

$P_T$  = transmitter output power in dBm

$G_T$  = gain of the transmitting antenna in dBi

$L_C$  = signal attenuation in the connecting cable between the transmitter and antenna in dB

#### 3.4.2 Test Procedures

1. The testing follows ANSI C63.26 Section 5.2
2. The transmitter output port was connected to the system simulator.
3. Set EUT at maximum power through the system simulator.
4. Select lowest, middle, and highest channels for each band and different modulation.
5. Measure and record the power level from the system simulator.



## 3.5 Peak-to-Average Ratio

### 3.5.1 Description of the PAR Measurement

Power Complementary Cumulative Distribution Function (CCDF) curves provide a means for characterizing the power peaks of a digitally modulated signal on a statistical basis. A CCDF curve depicts the probability of the peak signal amplitude exceeding the average power level. Most contemporary measurement instrumentation include the capability to produce CCDF curves for an input signal provided that the instrument's resolution bandwidth can be set wide enough to accommodate the entire input signal bandwidth. In measuring transmissions in this band using an average power technique, the peak-to-average ratio (PAR) of the transmission may not exceed 13 dB.

### 3.5.2 Test Procedures

1. The testing follows ANSI C63.26 Section 5.2.3.4 (CCDF).
2. The EUT was connected to spectrum and system simulator via a power divider.
3. Set the CCDF (Complementary Cumulative Distribution Function) option in spectrum analyzer.
4. The highest RF powers were measured and recorded the maximum PAPR level associated with a probability of 0.1 %.
5. Record the deviation as Peak to Average Ratio.





### 3.6 Occupied Bandwidth

#### 3.6.1 Description of Occupied Bandwidth Measurement

The occupied bandwidth is the width of a frequency band such that, below the lower and above the upper frequency limits, the mean powers emitted are each equal to a specified percentage 0.5% of the total mean transmitted power.

The 26 dB emission bandwidth is defined as the frequency range between two points, one above and one below the carrier frequency, at which the spectral density of the emission is attenuated 26 dB below the maximum in-band spectral density of the modulated signal. Spectral density (power per unit bandwidth) is to be measured with a detector of resolution bandwidth equal to approximately 1.0% of the emission bandwidth.

#### 3.6.2 Test Procedures

1. The testing follows ANSI C63.26 Section 5.4
2. The EUT was connected to spectrum analyzer and system simulator via a power divider.
3. The spectrum analyzer center frequency is set to the nominal EUT channel center frequency. The span range for the spectrum analyzer shall be between two and five times the anticipated OBW.
4. The nominal resolution bandwidth (RBW) shall be in the range of 1 to 5 % of the anticipated OBW, and the VBW shall be at least 3 times the RBW.
5. Set the detection mode to peak, and the trace mode to max hold.
6. Determine the reference value: Set the EUT to transmit a modulated signal. Allow the trace to stabilize. Set the spectrum analyzer marker to the highest level of the displayed trace.  
(this is the reference value)
7. Determine the “-26 dB down amplitude” as equal to (Reference Value – X).
8. Place two markers, one at the lowest and the other at the highest frequency of the envelope of the spectral display such that each marker is at or slightly below the “-X dB down amplitude” determined in step 6. If a marker is below this “-X dB down amplitude” value it shall be placed as close as possible to this value. The OBW is the positive frequency difference between the two markers.
9. Use the 99 % power bandwidth function of the spectrum analyzer and report the measured bandwidth.



### 3.7 Conducted Band Edge

#### 3.7.1 Description of Conducted Band Edge Measurement

27.53(m)(4)

For mobile digital stations, the attenuation factor shall be not less than  $40 + 10 \log (P)$  dB on all frequencies between the channel edge and 5 megahertz from the channel edge,  $43 + 10 \log (P)$  dB on all frequencies between 5 megahertz and X megahertz from the channel edge, and  $55 + 10 \log (P)$  dB on all frequencies more than X megahertz from the channel edge, where X is the greater of 6 megahertz or the actual emission bandwidth as defined in paragraph (m)(6) of this section. In addition, the attenuation factor shall not be less that  $43 + 10 \log (P)$  dB on all frequencies between 2490.5 MHz and 2496 MHz and  $55 + 10 \log (P)$  dB at or below 2490.5 MHz. Mobile Satellite Service licensees operating on frequencies below 2495 MHz may also submit a documented interference complaint against BRS licensees operating on channel BRS Channel 1 on the same terms and conditions as adjacent channel BRS or EBS licensees.

#### 3.7.2 Test Procedures

1. The testing follows ANSI C63.26 section 5.7
2. The EUT was connected to spectrum analyzer and system simulator via a power divider.
3. The band edges of low and high channels for the highest RF powers were measured.
4. Set RBW  $\geq$  1% EBW in the 1MHz band immediately outside and adjacent to the band edge.
5. Beyond the 1 MHz band from the band edge, RBW=1MHz was used or a narrower RBW was used and the measured power was integrated over the full required measurement bandwidth of 1 MHz.
6. Set spectrum analyzer with RMS detector.
7. The RF fundamental frequency should be excluded against the limit line in the operating frequency band.
8. Checked that all the results comply with the emission limit line.

Example:

The limit line is derived from  $43 + 10\log(P)$ dB below the transmitter power P(Watts)  
 $= P(W) - [43 + 10\log(P)]$  (dB)  
 $= [30 + 10\log(P)]$  (dBm) -  $[43 + 10\log(P)]$  (dB) = -13dBm.

9. For LTE Band 38, 41, the other 40 dB, and 55 dB have additionally applied same calculation above.
10. When using the integration method, the starting frequency of the integration shall be centered at one-half of the RBW away from the band edge.



## 3.8 Conducted Spurious Emission

### 3.8.1 Description of Conducted Spurious Emission Measurement

The power of any emission outside of the authorized operating frequency ranges must be lower than the transmitter power (P) by a factor of at least  $43 + 10 \log (P)$  dB.

For Band 7,38,41:

The power of any emission outside of the authorized operating frequency ranges must be lower than the transmitter power (P) by a factor of at least  $55 + 10 \log (P)$  dB.

It is measured by means of a calibrated spectrum analyzer and scanned from 30 MHz up to a frequency including its 10<sup>th</sup> harmonic.

### 3.8.2 Test Procedures

1. The testing follows ANSI C63.26 section 5.7
2. The EUT was connected to spectrum analyzer and system simulator via a power divider.
3. The RF output of EUT was connected to the spectrum analyzer by RF cable and attenuator. The path loss was compensated to the results for each measurement.
4. The middle channel for the highest RF power within the transmitting frequency was measured.
5. The conducted spurious emission for the whole frequency range was taken.
6. Make the measurement with the spectrum analyzer's RBW = 1MHz, VBW = 3MHz.
7. Set spectrum analyzer with RMS detector.
8. Taking the record of maximum spurious emission.
9. The RF fundamental frequency should be excluded against the limit line in the operating frequency band.
10. The limit line is derived from  $43 + 10\log(P)$ dB below the transmitter power P(Watts)  
 $= P(W) - [43 + 10\log(P)]$  (dB)  
 $= [30 + 10\log(P)]$  (dBm) -  $[43 + 10\log(P)]$  (dB)  
 $= -13$ dBm.
11. For Band 38, 41  
The limit line is derived from  $55 + 10\log(P)$ dB below the transmitter power P(Watts)  
 $= P(W) - [55 + 10\log(P)]$  (dB)  
 $= [30 + 10\log(P)]$  (dBm) -  $[55 + 10\log(P)]$  (dB)  
 $= -25$ dBm.



## 3.9 Frequency Stability

### 3.9.1 Description of Frequency Stability Measurement

The frequency stability shall be measured by variation of ambient temperature and variation of primary supply voltage to ensure that the fundamental emission stays within the authorized frequency block. The frequency stability of the transmitter shall be maintained within  $\pm 0.00025\%$  ( $\pm 2.5\text{ppm}$ ) of the center frequency.

### 3.9.2 Test Procedures for Temperature Variation

1. The testing follows ANSI C63.26 section 5.6.4
2. The EUT was set up in the thermal chamber and connected with the system simulator.
3. With power OFF, the temperature was decreased to  $-30^{\circ}\text{C}$  and the EUT was stabilized before testing. Power was applied and the maximum change in frequency was recorded within one minute.
4. With power OFF, the temperature was raised in  $10^{\circ}\text{C}$  step up to  $50^{\circ}\text{C}$ . The EUT was stabilized at each step for at least half an hour. Power was applied and the maximum frequency change was recorded within one minute.

### 3.9.3 Test Procedures for Voltage Variation

1. The testing follows ANSI C63.26 section 5.6.5
2. The EUT was placed in a temperature chamber at  $20\pm 5^{\circ}\text{C}$  and connected with the system simulator.
3. The power supply voltage to the EUT was varied from 85% to 115% of the nominal value for other than hand carried battery equipment.
4. For hand carried, battery powered equipment, reduce the primary ac or dc supply voltage to the battery operating end point, which shall be specified by the manufacturer.
5. The variation in frequency was measured for the worst case.

## 4 Radiated Test Items

### 4.1 Measuring Instruments

See list of measuring instruments of this test report.

### 4.2 Test Setup

#### 4.2.1 For radiated test below 30MHz

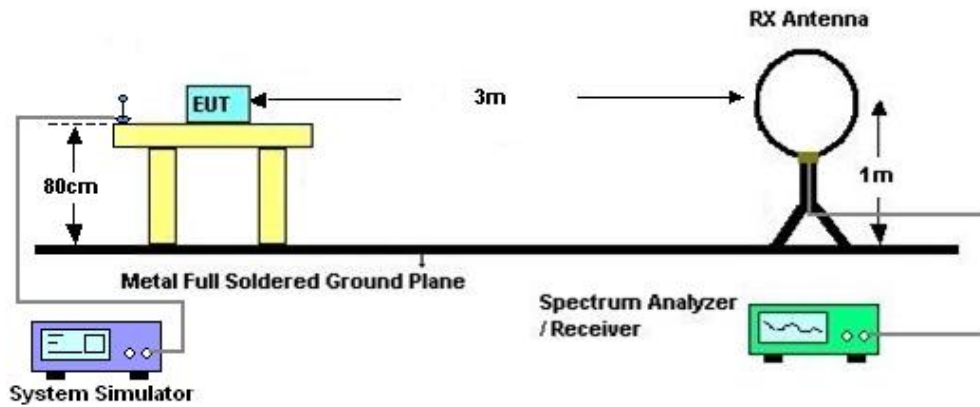

#### 4.2.2 For radiated test from 30MHz to 1GHz

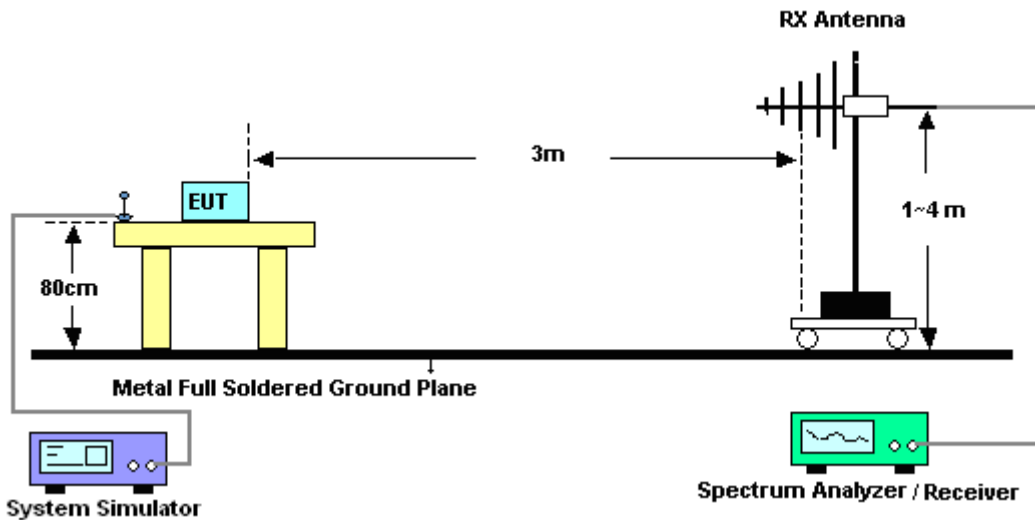

#### 4.2.3 For radiated test above 1GHz

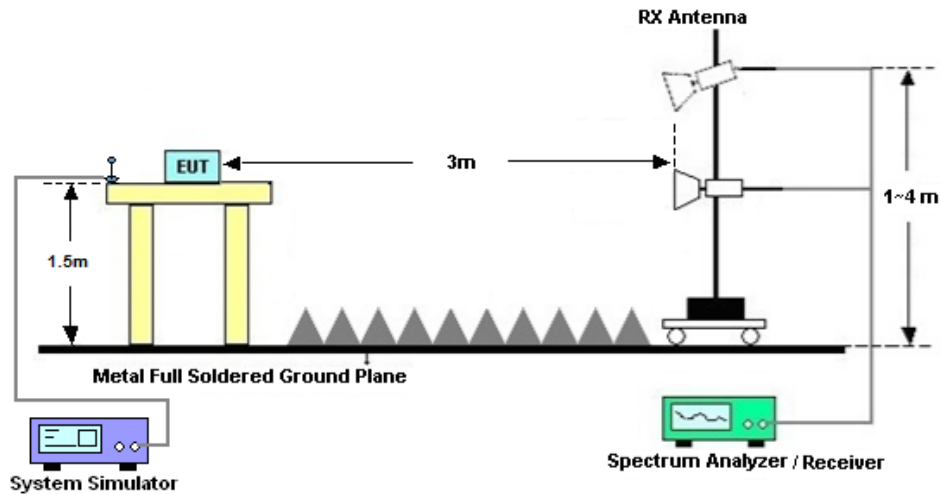

#### 4.3 Test Result of Radiated Test

The low frequency, which started from 9 kHz to 30MHz, was pre-scanned and the result which was 20dB lower than the limit line was not reported.

Please refer to Appendix B.



## 4.4 Radiated Spurious Emission

### 4.4.1 Description of Radiated Spurious Emission

The radiated spurious emission was measured by substitution method according to ANSI C63.26. The power of any emission outside of the authorized operating frequency ranges must be attenuated below the transmitter power (P) by a factor of at least  $43 + 10 \log (P)$  dB.

For Band 38, 41

The power of any emission outside of the authorized operating frequency ranges must be attenuated below the transmitter power (P) by a factor of at least  $55 + 10 \log (P)$  dB.

The spectrum is scanned from 30 MHz up to a frequency including its 10th harmonic.

### 4.4.2 Test Procedures

1. The testing follows ANSI C63.26 Section 5.5
2. The EUT was placed on a turntable with 0.8 meter height for frequency below 1GHz and 1.5 meter height for frequency above 1GHz respectively above ground.
3. The EUT was set 3 meters from the receiving antenna mounted on the antenna tower.
4. The table was rotated 360 degrees to determine the position of the highest spurious emission.
5. The height of the receiving antenna is varied between 1m to 4m to search the maximum spurious emission for both horizontal and vertical polarizations.
6. During the measurement, the system simulator parameters were set to force the EUT transmitting at maximum output power.
7. Make the measurement with the spectrum analyzer's RBW = 1MHz, VBW = 3MHz, taking the record of maximum spurious emission.
8. A horn antenna was substituted in place of the EUT and was driven by a signal generator.
9. Tune the output power of signal generator to the same emission level with EUT maximum spurious emission.
10.  $EIRP (dBm) = S.G. Power - Tx Cable Loss + Tx Antenna Gain$
11.  $ERP (dBm) = EIRP - 2.15$
12. The RF fundamental frequency should be excluded against the limit line in the operating frequency band.

The limit line is derived from  $43 + 10\log(P)$ dB below the transmitter power P(Watts)  
 $= P(W) - [43 + 10\log(P)] (dB)$   
 $= [30 + 10\log(P)] (dBm) - [43 + 10\log(P)] (dB)$   
 $= -13dBm.$

13. For Band 38, 41:

The limit line is derived from  $55 + 10\log(P)$ dB below the transmitter power P(Watts)



## 5 List of Measuring Equipment

| Instrument            | Manufacturer                 | Model No.        | Serial No.         | Characteristics      | Calibration Date | Test Date                       | Due Date      | Remark                |
|-----------------------|------------------------------|------------------|--------------------|----------------------|------------------|---------------------------------|---------------|-----------------------|
| Spectrum Analyzer     | R&S                          | FSV40            | 101078             | 10Hz~40GHz           | Apr. 06, 2023    | Dec. 12, 2023~<br>Dec. 14, 2023 | Apr. 05, 2024 | Conducted (TH01-SZ)   |
| DC Power Supply       | TTI                          | PL330P           | 290070             | Max 32V , 3A         | Oct. 16, 2023    | Dec. 12, 2023~<br>Dec. 14, 2023 | Oct. 15, 2024 | Conducted (TH01-SZ)   |
| Power Divider         | TOJOIN                       | PS-2SM-04<br>265 | 60.06.020.007<br>7 | 0.4GHz~26.5GHz       | Dec. 25, 2022    | Dec. 12, 2023~<br>Dec. 14, 2023 | Dec. 24, 2023 | Conducted (TH01-SZ)   |
| Thermal Chamber       | Ten Billion<br>Hongzhangroup | LP-150U          | H2014081803        | -40~+150°C           | Jul. 05, 2023    | Dec. 12, 2023~<br>Dec. 14, 2023 | Jul. 04, 2024 | Conducted (TH01-SZ)   |
| EXA Spectrum Analyzer | Keysight                     | N9010B           | MY57471079         | 10Hz-44G,MAX<br>30dB | Oct. 10, 2023    | Nov. 30, 2023                   | Oct. 09, 2024 | Radiation (03CH04-KS) |
| Loop Antenna          | R&S                          | HFH2-Z2E         | 101125             | 9kHz~30MHz           | Sep. 11 2023     | Nov. 30, 2023                   | Sep. 10, 2024 | Radiation (03CH04-KS) |
| Bilog Antenna         | TeseQ                        | CBL6111D         | 49922              | 30MHz-1GHz           | Apr. 09, 2023    | Nov. 30, 2023                   | Apr. 08, 2024 | Radiation (03CH04-KS) |
| Horn Antenna          | Schwarzbeck                  | BBHA9120D        | 1284               | 1GHz~18GHz           | Oct. 10, 2023    | Nov. 30, 2023                   | Oct. 09, 2024 | Radiation (03CH04-KS) |
| SHF-EHF Horn          | Com-power                    | AH-840           | 101070             | 18GHz~40GHz          | Jan. 08, 2023    | Nov. 30, 2023                   | Jan. 07, 2024 | Radiation (03CH04-KS) |
| Amplifier             | SONOMA                       | 310N             | 380827             | 9KHz-1GHz            | Jul 06, 2023     | Nov. 30, 2023                   | Jul 05, 2024  | Radiation (03CH04-KS) |
| Amplifier             | MITEQ                        | EM18G40G<br>GA   | 060728             | 18~40GHz             | Jan. 05, 2023    | Nov. 30, 2023                   | Jan. 04, 2024 | Radiation (03CH04-KS) |
| high gain Amplifier   | EM                           | EM01G18G<br>A    | 060840             | 1Ghz-18Ghz           | Oct. 10, 2023    | Nov. 30, 2023                   | Oct. 09, 2024 | Radiation (03CH04-KS) |
| Amplifier             | Agilent                      | 8449B            | 3008A02370         | 1Ghz-18Ghz           | Oct. 10, 2023    | Nov. 30, 2023                   | Oct. 09, 2024 | Radiation (03CH04-KS) |
| AC Power Source       | Chroma                       | 61601            | F104090004         | N/A                  | NCR              | Nov. 30, 2023                   | NCR           | Radiation (03CH04-KS) |
| Turn Table            | ChamPro                      | EM 1000-T        | 060762-T           | 0~360 degree         | NCR              | Nov. 30, 2023                   | NCR           | Radiation (03CH04-KS) |
| Antenna Mast          | ChamPro                      | EM 1000-A        | 060762-A           | 1 m~4 m              | NCR              | Nov. 30, 2023                   | NCR           | Radiation (03CH04-KS) |

NCR: No Calibration Required





## 6 Measurement Uncertainty

The measurement uncertainties shown below were calculated in accordance with the requirements of ANSI 63.26-2015. All the measurement uncertainty value were shown with a coverage K=2 to indicate 95% level of confidence. The measurement data show herein meets or exceeds the CISPR measurement uncertainty values specified in CISPR 16-4-2 and can be compared directly to specified limit to determine compliance.

### Uncertainty of Conducted Measurement

| Test Item                              | Uncertainty |
|--|-------------|
| Conducted Spurious Emission & Bandedge | ±1.34 dB    |
| Occupied Channel Bandwidth             | ±0.012 MHz  |
| Conducted Power                        | ±1.34 dB    |
| Peak to Average Ratio                  | ±1.34 dB    |
| Frequency Stability                    | ±1.3 Hz     |

### Uncertainty of Radiated Emission Measurement (9 KHz ~ 30 MHz)

|   |      |
|---|------|
| Measuring Uncertainty for a Level of Confidence of 95% (U = 2Uc(y)) | 3.82 |
|---|------|

### Uncertainty of Radiated Emission Measurement (30 MHz ~ 1000 MHz)

|   |      |
|---|------|
| Measuring Uncertainty for a Level of Confidence of 95% (U = 2Uc(y)) | 3.56 |
|---|------|

### Uncertainty of Radiated Emission Measurement (1 GHz ~ 40 GHz)

|   |      |
|---|------|
| Measuring Uncertainty for a Level of Confidence of 95% (U = 2Uc(y)) | 3.54 |
|---|------|

----- THE END -----



### Appendix A. Test Results of Conducted Test

|                 |          |                     |         |
|-----------------|----------|---------------------|---------|
| Test Engineer : | Hank Lin | Temperature :       | 24~26°C |
|                 |          | Relative Humidity : | 50~53%  |

### Conducted Output Power(Average power) and EIRP

#### LTE Band 38\_Ant.4:

| BW [MHz]        | Modulation | RB Size | RB Offset | Power Low Ch. / Freq. | Power Middle Ch. / Freq. | Power High Ch. / Freq. | EIRP(W) |        |        |
|-----------------|------------|---------|-----------|-----------------------|--------------------------|------------------------|---------|--------|--------|
| Channel         |            |         |           | 37850                 | 38000                    | 38150                  | EIRP(W) |        |        |
| Frequency (MHz) |            |         |           | 2580                  | 2595                     | 2610                   | L       | M      | H      |
| 20              | QPSK       | 1       | 0         | 22.71                 | 22.79                    | 22.65                  | 0.0703  | 0.0716 | 0.0693 |
| 20              | QPSK       | 1       | 99        | 22.67                 | 22.75                    | 22.61                  | 0.0697  | 0.0710 | 0.0687 |
| 20              | QPSK       | 100     | 0         | 21.99                 | 22.09                    | 21.93                  | 0.0596  | 0.0610 | 0.0587 |
| 20              | 16QAM      | 1       | 0         | 22.01                 | 22.11                    | 21.92                  | 0.0598  | 0.0612 | 0.0586 |
| 20              | 64QAM      | 1       | 0         | 21.02                 | 21.10                    | 20.95                  | 0.0476  | 0.0485 | 0.0469 |
| Channel         |            |         |           | 37825                 | 38000                    | 38175                  | EIRP(W) |        |        |
| Frequency (MHz) |            |         |           | 2577.5                | 2595                     | 2612.5                 | L       | M      | H      |
| 15              | QPSK       | 1       | 0         | 22.63                 | 22.70                    | 22.59                  | 0.0690  | 0.0701 | 0.0684 |
| 15              | 16QAM      | 1       | 0         | 21.95                 | 22.02                    | 21.83                  | 0.0590  | 0.0600 | 0.0574 |
| Channel         |            |         |           | 37800                 | 38000                    | 38200                  | EIRP(W) |        |        |
| Frequency (MHz) |            |         |           | 2575                  | 2595                     | 2615                   | L       | M      | H      |
| 10              | QPSK       | 1       | 0         | 22.62                 | 22.70                    | 22.55                  | 0.0689  | 0.0701 | 0.0678 |
| 10              | 16QAM      | 1       | 0         | 21.93                 | 22.03                    | 21.83                  | 0.0587  | 0.0601 | 0.0574 |
| Channel         |            |         |           | 37775                 | 38000                    | 38225                  | EIRP(W) |        |        |
| Frequency (MHz) |            |         |           | 2572.5                | 2595                     | 2617.5                 | L       | M      | H      |
| 5               | QPSK       | 1       | 0         | 22.60                 | 22.69                    | 22.58                  | 0.0685  | 0.0700 | 0.0682 |
| 5               | 16QAM      | 1       | 0         | 21.94                 | 22.02                    | 21.86                  | 0.0589  | 0.0600 | 0.0578 |



LTE Band 41\_Ant.4:

| BW [MHz]        | Modulation | RB Size | RB Offset | Power Low Ch. / Freq. | Power Middle Ch. / Freq. | Power High Ch. / Freq. | EIRP(W) |        |        |
|-----------------|------------|---------|-----------|-----------------------|--------------------------|------------------------|---------|--------|--------|
| Channel         |            |         |           | 39750                 | 40620                    | 41490                  |         |        |        |
| Frequency (MHz) |            |         |           | 2506                  | 2593                     | 2680                   | L       | M      | H      |
| 20              | QPSK       | 1       | 0         | 25.33                 | 25.46                    | 25.31                  | 0.1285  | 0.1324 | 0.1279 |
| 20              | QPSK       | 1       | 99        | 25.21                 | 25.35                    | 25.18                  | 0.1250  | 0.1291 | 0.1242 |
| 20              | QPSK       | 100     | 0         | 24.21                 | 24.35                    | 24.21                  | 0.0993  | 0.1026 | 0.0993 |
| 20              | 16QAM      | 1       | 0         | 24.22                 | 24.31                    | 24.20                  | 0.0995  | 0.1016 | 0.0991 |
| 20              | 64QAM      | 1       | 0         | 23.20                 | 23.38                    | 23.20                  | 0.0787  | 0.0820 | 0.0787 |
| Channel         |            |         |           | 39725                 | 40620                    | 41515                  | EIRP(W) |        |        |
| Frequency (MHz) |            |         |           | 2503.5                | 2593                     | 2682.5                 | L       | M      | H      |
| 15              | QPSK       | 1       | 0         | 25.23                 | 25.40                    | 25.23                  | 0.1256  | 0.1306 | 0.1256 |
| 15              | 16QAM      | 1       | 0         | 24.12                 | 24.22                    | 24.11                  | 0.0973  | 0.0995 | 0.0971 |
| Channel         |            |         |           | 39700                 | 40620                    | 41540                  | EIRP(W) |        |        |
| Frequency (MHz) |            |         |           | 2501                  | 2593                     | 2685                   | L       | M      | H      |
| 10              | QPSK       | 1       | 0         | 25.26                 | 25.39                    | 25.23                  | 0.1265  | 0.1303 | 0.1256 |
| 10              | 16QAM      | 1       | 0         | 24.13                 | 24.22                    | 24.10                  | 0.0975  | 0.0995 | 0.0968 |
| Channel         |            |         |           | 39675                 | 40620                    | 41565                  | EIRP(W) |        |        |
| Frequency (MHz) |            |         |           | 2498.5                | 2593                     | 2687.5                 | L       | M      | H      |
| 5               | QPSK       | 1       | 0         | 25.25                 | 25.37                    | 25.21                  | 0.1262  | 0.1297 | 0.1250 |
| 5               | 16QAM      | 1       | 0         | 24.15                 | 24.22                    | 24.14                  | 0.0979  | 0.0995 | 0.0977 |



## CA Power and EIRP

### LTE CA\_41C\_Ant.4:

| Combination 20MHz+20MHz (100RB+100RB) |            |         |           |         |           |                |         |
|---------------------------------------|------------|---------|-----------|---------|-----------|----------------|---------|
| Channel                               | Modulation | PCC     |           | SCC     |           | Measured Power | EIRP(W) |
|                                       |            | RB Size | RB offset | RB Size | RB offset |                |         |
| L                                     | QPSK       | 1       | Max       | 1       | 0         | 25.11          | 0.1222  |
| M                                     | QPSK       | 1       | Max       | 1       | 0         | 25.21          | 0.1250  |
| H                                     | QPSK       | 1       | Max       | 1       | 0         | 25.09          | 0.1216  |
| L                                     | 16QAM      | 1       | Max       | 1       | 0         | 24.02          | 0.0951  |
| M                                     | 16QAM      | 1       | Max       | 1       | 0         | 24.11          | 0.0971  |
| H                                     | 16QAM      | 1       | Max       | 1       | 0         | 24.00          | 0.0946  |
| L                                     | 64QAM      | 1       | Max       | 1       | 0         | 23.14          | 0.0776  |
| M                                     | 64QAM      | 1       | Max       | 1       | 0         | 23.28          | 0.0802  |
| H                                     | 64QAM      | 1       | Max       | 1       | 0         | 23.09          | 0.0767  |
| Combination 20MHz+15MHz (100RB+75RB)  |            |         |           |         |           |                |         |
| Channel                               | Modulation | PCC     |           | SCC     |           | Measured Power | EIRP(W) |
|                                       |            | RB Size | RB offset | RB Size | RB offset |                |         |
| M                                     | QPSK       | 1       | Max       | 1       | 0         | 25.01          | 0.1194  |
| M                                     | 16QAM      | 1       | Max       | 1       | 0         | 23.99          | 0.0944  |
| Combination 15MHz+20MHz (75RB+100RB)  |            |         |           |         |           |                |         |
| Channel                               | Modulation | PCC     |           | SCC     |           | Measured Power | EIRP(W) |
|                                       |            | RB Size | RB offset | RB Size | RB offset |                |         |
| M                                     | QPSK       | 1       | Max       | 1       | 0         | 25.05          | 0.1205  |
| M                                     | 16QAM      | 1       | Max       | 1       | 0         | 23.95          | 0.0935  |
| Combination 15MHz+15MHz (75RB+75RB)   |            |         |           |         |           |                |         |
| Channel                               | Modulation | PCC     |           | SCC     |           | Measured Power | EIRP(W) |
|                                       |            | RB Size | RB offset | RB Size | RB offset |                |         |
| M                                     | QPSK       | 1       | Max       | 1       | 0         | 25.04          | 0.1202  |
| M                                     | 16QAM      | 1       | Max       | 1       | 0         | 24.03          | 0.0953  |
| Combination 20MHz+10MHz (100RB+50RB)  |            |         |           |         |           |                |         |
| Channel                               | Modulation | PCC     |           | SCC     |           | Measured Power | EIRP(W) |
|                                       |            | RB Size | RB offset | RB Size | RB offset |                |         |
| M                                     | QPSK       | 1       | Max       | 1       | 0         | 25.07          | 0.1211  |
| M                                     | 16QAM      | 1       | Max       | 1       | 0         | 24.06          | 0.0959  |
| Combination 10MHz+20MHz (50RB+100RB)  |            |         |           |         |           |                |         |
| Channel                               | Modulation | PCC     |           | SCC     |           | Measured Power | EIRP(W) |
|                                       |            | RB Size | RB offset | RB Size | RB offset |                |         |
| M                                     | QPSK       | 1       | Max       | 1       | 0         | 25.02          | 0.1197  |
| M                                     | 16QAM      | 1       | Max       | 1       | 0         | 24.01          | 0.0948  |
| Combination 15MHz+10MHz (75RB+50RB)   |            |         |           |         |           |                |         |
| Channel                               | Modulation | PCC     |           | SCC     |           | Measured Power | EIRP(W) |
|                                       |            | RB Size | RB offset | RB Size | RB offset |                |         |
| M                                     | QPSK       | 1       | Max       | 1       | 0         | 24.96          | 0.1180  |
| M                                     | 16QAM      | 1       | Max       | 1       | 0         | 23.92          | 0.0929  |
| Combination 10MHz+15MHz (50RB+75RB)   |            |         |           |         |           |                |         |
| Channel                               | Modulation | PCC     |           | SCC     |           | Measured Power | EIRP(W) |
|                                       |            | RB Size | RB offset | RB Size | RB offset |                |         |
| M                                     | QPSK       | 1       | Max       | 1       | 0         | 24.99          | 0.1189  |
| M                                     | 16QAM      | 1       | Max       | 1       | 0         | 23.95          | 0.0935  |



| Combination 20MHz+5MHz (100RB+25RB) |            |         |           |         |           |                |         |
|-------------------------------------|------------|---------|-----------|---------|-----------|----------------|---------|
| Channel                             | Modulation | PCC     |           | SCC     |           | Measured Power | EIRP(W) |
|                                     |            | RB Size | RB offset | RB Size | RB offset |                |         |
| M                                   | QPSK       | 1       | Max       | 1       | 0         | 25.03          | 0.1199  |
| M                                   | 16QAM      | 1       | Max       | 1       | 0         | 24.05          | 0.0957  |
| Combination 5MHz+20MHz (25RB+100RB) |            |         |           |         |           |                |         |
| Channel                             | Modulation | PCC     |           | SCC     |           | Measured Power | EIRP(W) |
|                                     |            | RB Size | RB offset | RB Size | RB offset |                |         |
| M                                   | QPSK       | 1       | Max       | 1       | 0         | 24.97          | 0.1183  |
| M                                   | 16QAM      | 1       | Max       | 1       | 0         | 24.01          | 0.0948  |



# LTE Band 41

## Peak-to-Average Ratio

| Mode      | LTE Band 41 / 20MHz |         |         |             |
|-----------|---------------------|---------|---------|-------------|
| Mod.      | QPSK                | 16QAM   | 64QAM   | Limit: 13dB |
| RB Size   | Full RB             | Full RB | Full RB | Result      |
| Middle CH | 5.22                | 6.20    | 6.46    | PASS        |

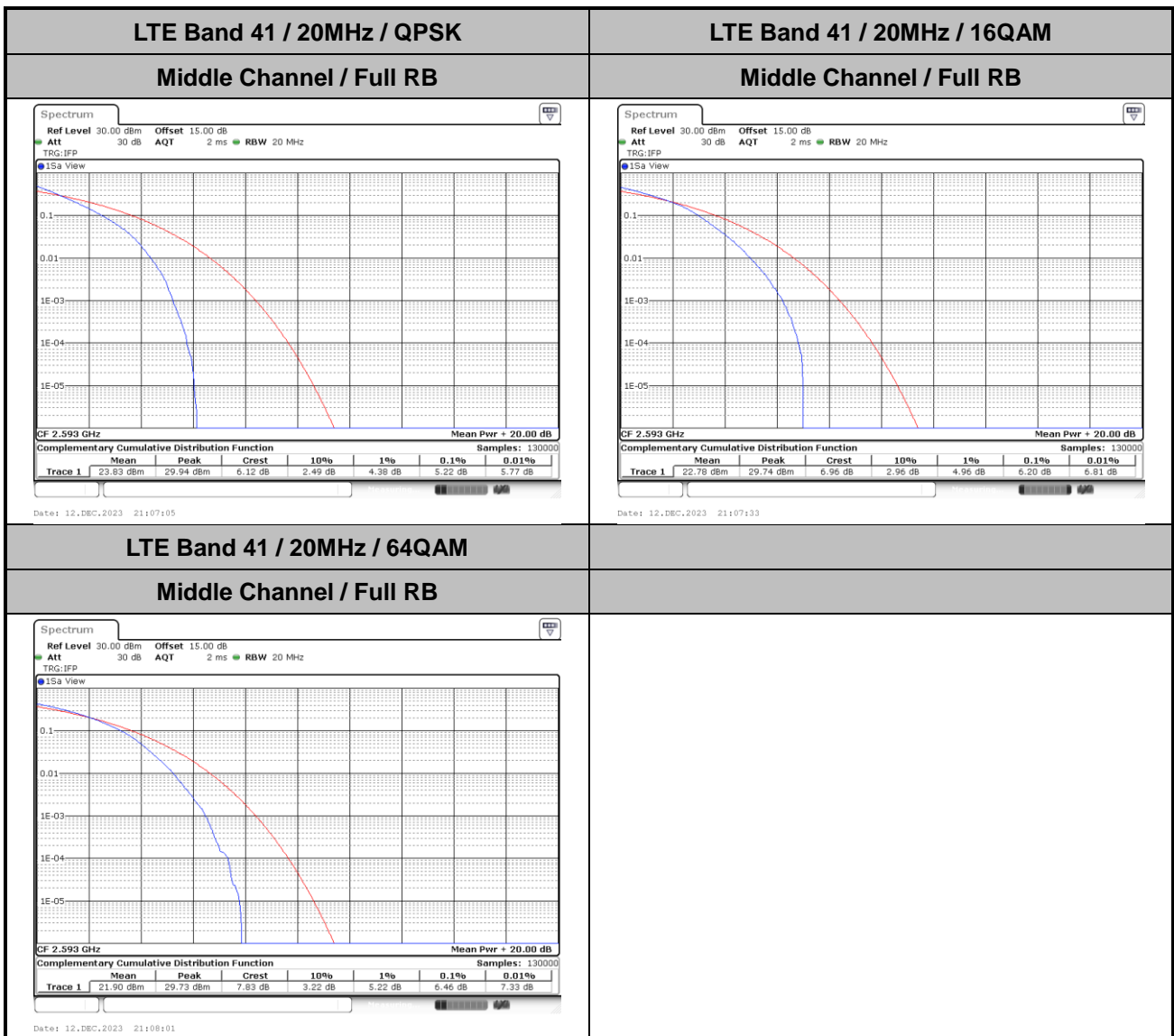



# 26dB Bandwidth

| Mode      | LTE Band 41 : 26dB BW(MHz) |       |       |       |       |       |       |       |
|-----------|----------------------------|-------|-------|-------|-------|-------|-------|-------|
|           | 5MHz                       |       | 10MHz |       | 15MHz |       | 20MHz |       |
| Mod.      | QPSK                       | 16QAM | QPSK  | 16QAM | QPSK  | 16QAM | QPSK  | 16QAM |
| Middle CH | 5.05                       | 4.84  | 9.65  | 9.63  | 14.48 | 14.12 | 18.66 | 18.62 |

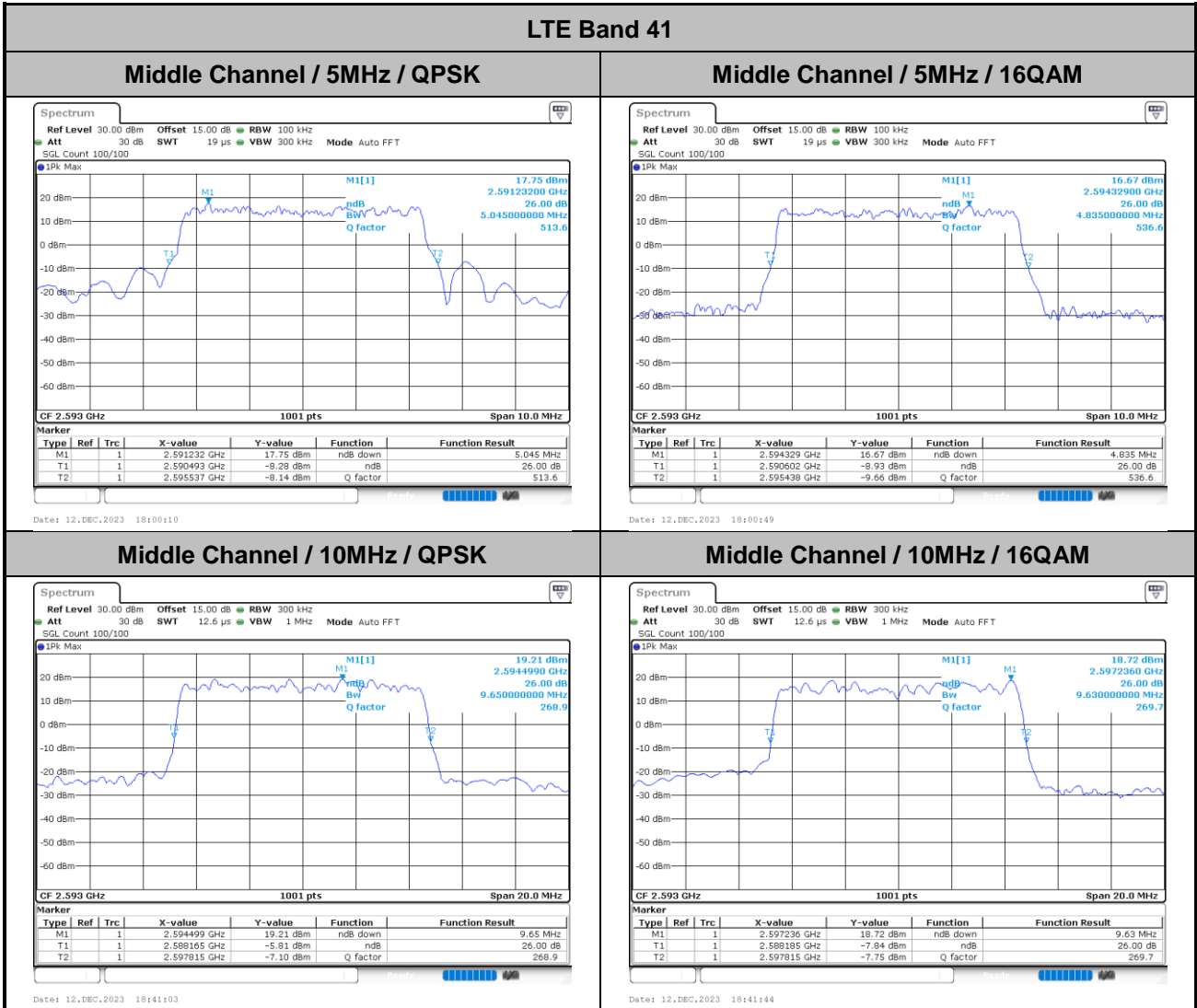



LTE Band 41

Middle Channel / 15MHz / QPSK

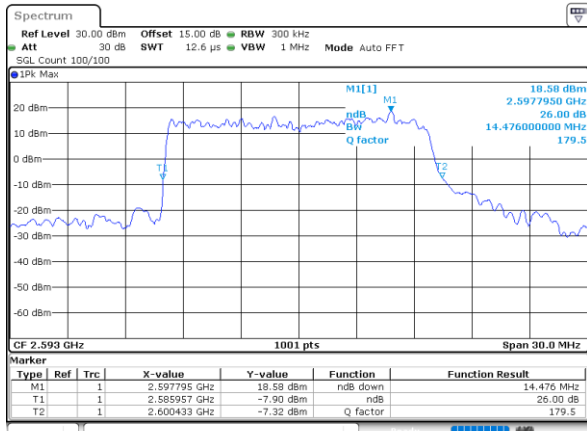

Date: 12.DEC.2023 20:54:20

Middle Channel / 15MHz / 16QAM

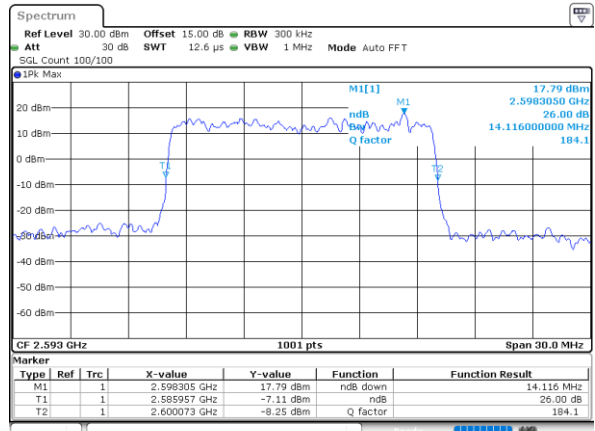

Date: 12.DEC.2023 20:55:00

Middle Channel / 20MHz / QPSK

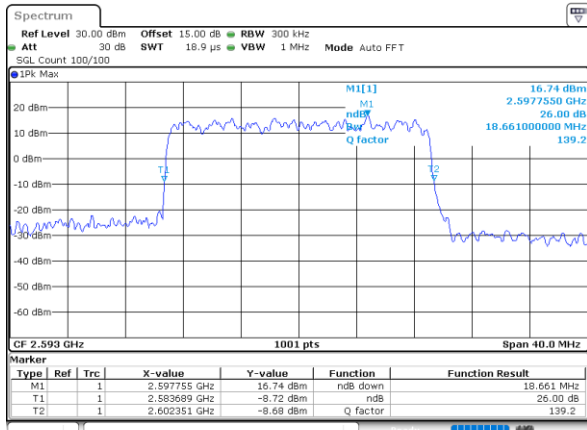

Date: 12.DEC.2023 21:05:58

Middle Channel / 20MHz / 16QAM

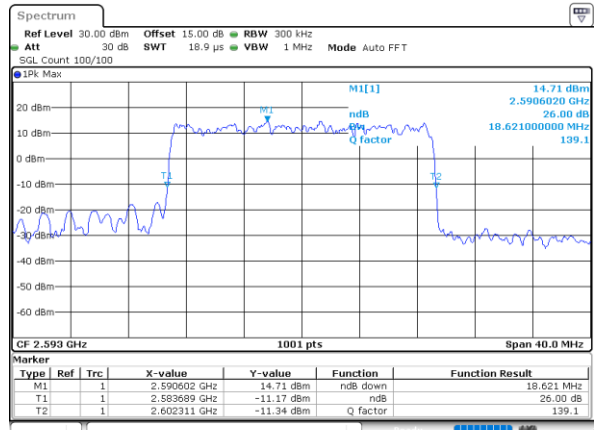

Date: 12.DEC.2023 21:06:38





# Occupied Bandwidth

| Mode      | LTE Band 41 : 99%OBW(MHz) |       |       |       |       |       |       |       |
|-----------|---------------------------|-------|-------|-------|-------|-------|-------|-------|
| BW        | 5MHz                      |       | 10MHz |       | 15MHz |       | 20MHz |       |
| Mod.      | QPSK                      | 16QAM | QPSK  | 16QAM | QPSK  | 16QAM | QPSK  | 16QAM |
| Middle CH | 4.50                      | 4.49  | 9.07  | 9.25  | 13.46 | 13.49 | 17.74 | 17.86 |

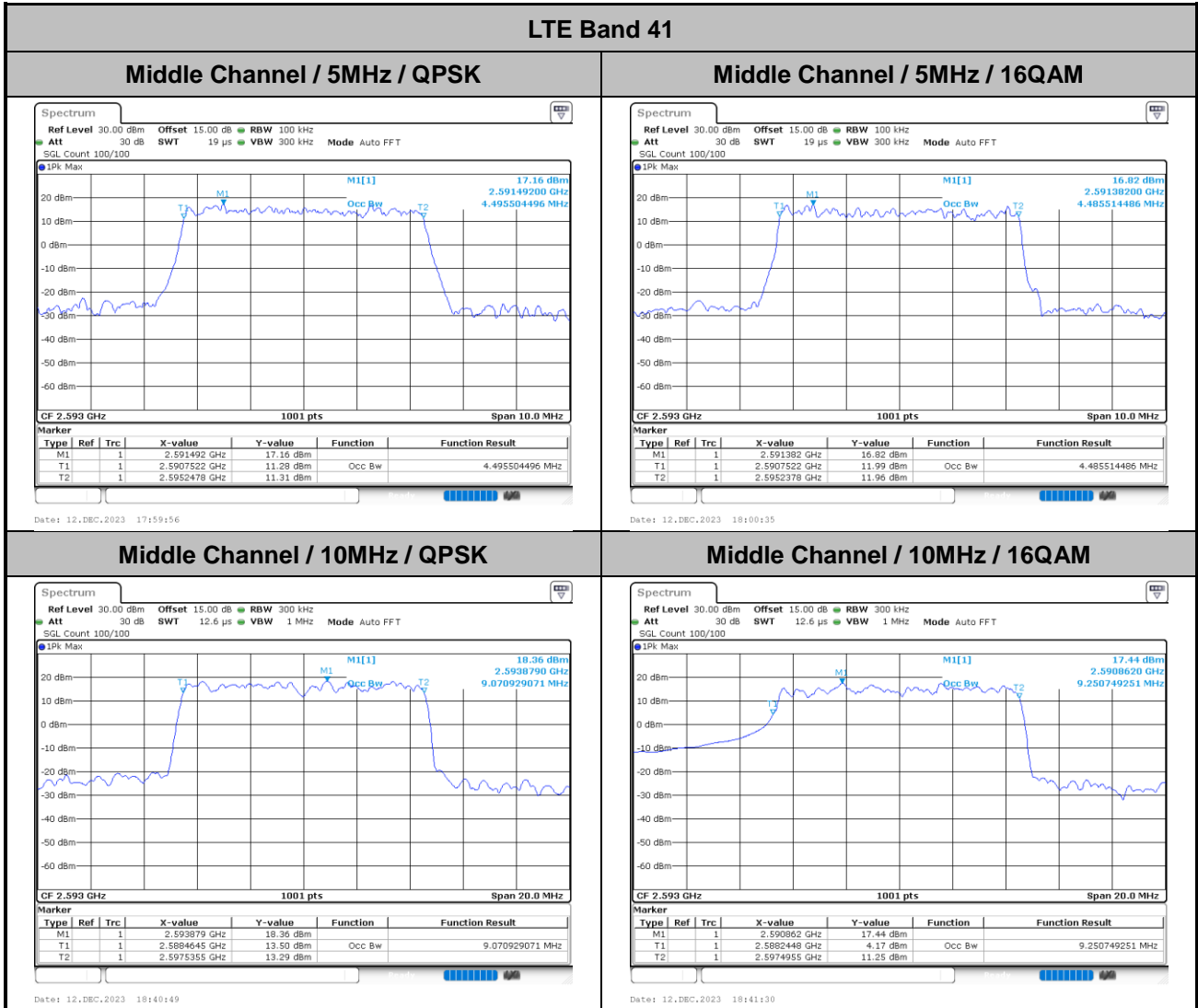



LTE Band 41

Middle Channel / 15MHz / QPSK

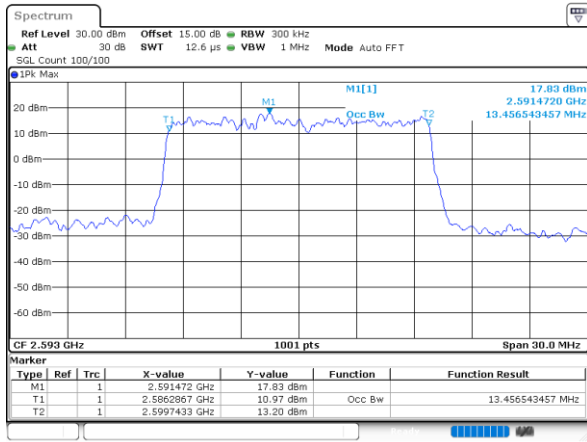

Date: 12.DEC.2023 20:54:06

Middle Channel / 15MHz / 16QAM

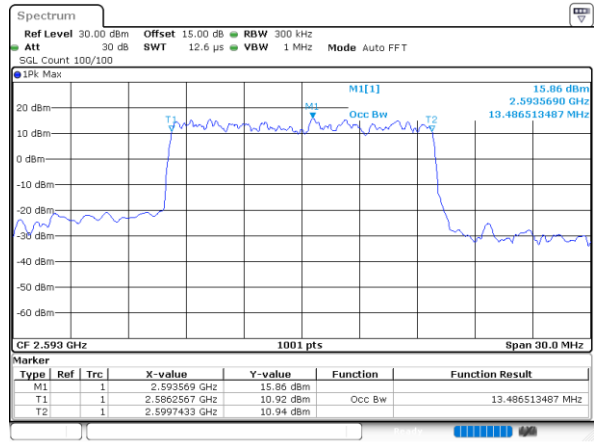

Date: 12.DEC.2023 20:54:46

Middle Channel / 20MHz / QPSK

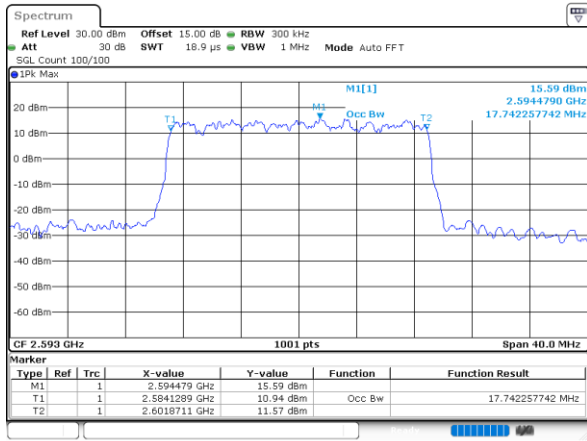

Date: 12.DEC.2023 21:05:44

Middle Channel / 20MHz / 16QAM

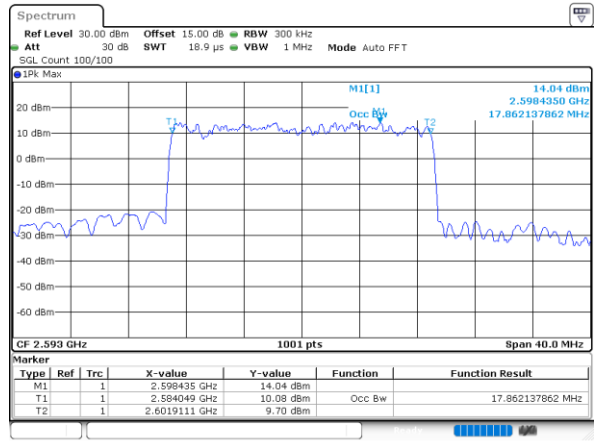

Date: 12.DEC.2023 21:06:24



# Conducted Band Edge

## LTE Band 41 / 5MHz / QPSK

### Lowest Band Edge / 1 RB

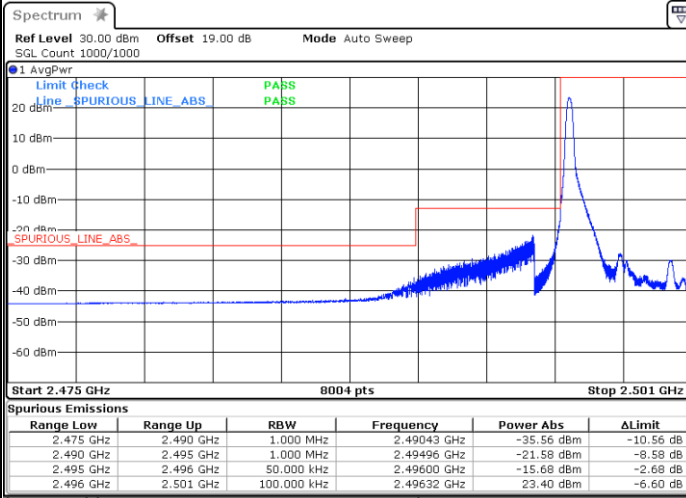

Date: 12.DEC.2023 14:22:39

### Highest Band Edge / 1 RB

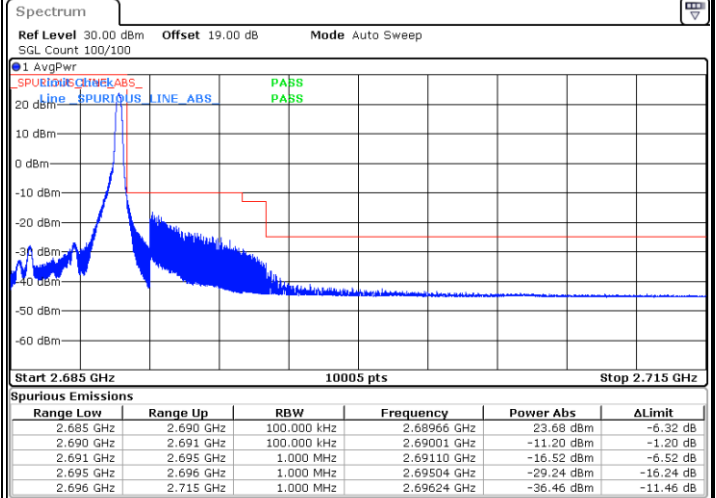

Date: 12.DEC.2023 14:54:34

### Lowest Band Edge / Full RB

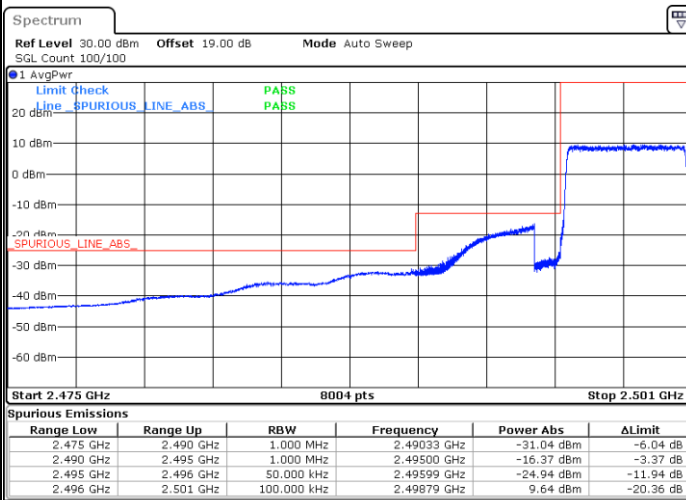

Date: 12.DEC.2023 14:31:23

### Highest Band Edge / Full RB

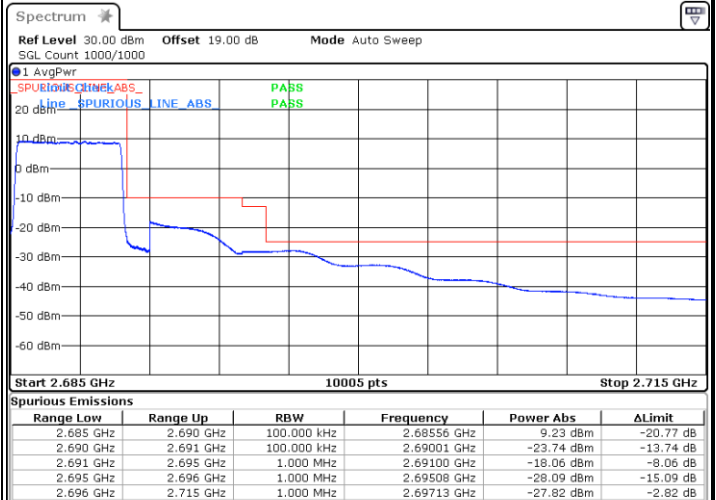

Date: 12.DEC.2023 14:44:06



LTE Band 41 / 5MHz / 16QAM

Lowest Band Edge / 1RB

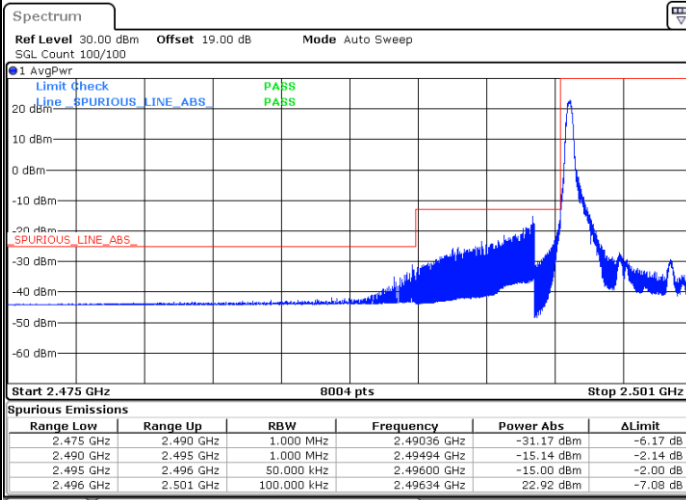

Date: 12.DEC.2023 14:24:49

Highest Band Edge / 1 RB

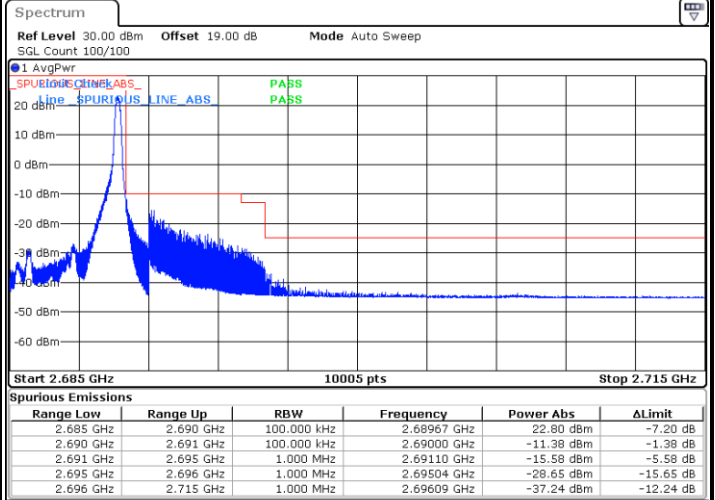

Date: 12.DEC.2023 14:55:50

Lowest Band Edge / Full RB

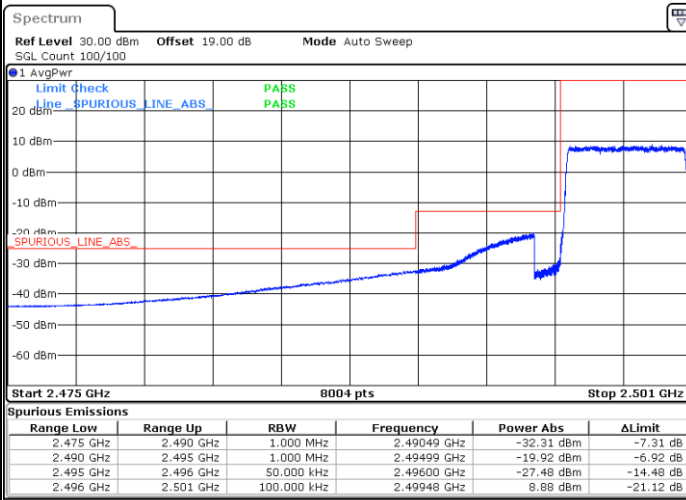

Date: 12.DEC.2023 14:30:34

Highest Band Edge / Full RB

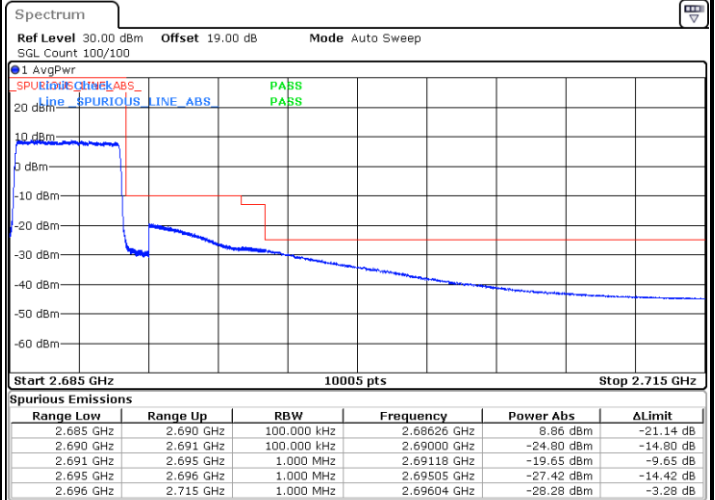

Date: 12.DEC.2023 14:45:54



LTE Band 41 / 5MHz / 64QAM

Lowest Band Edge / 1RB

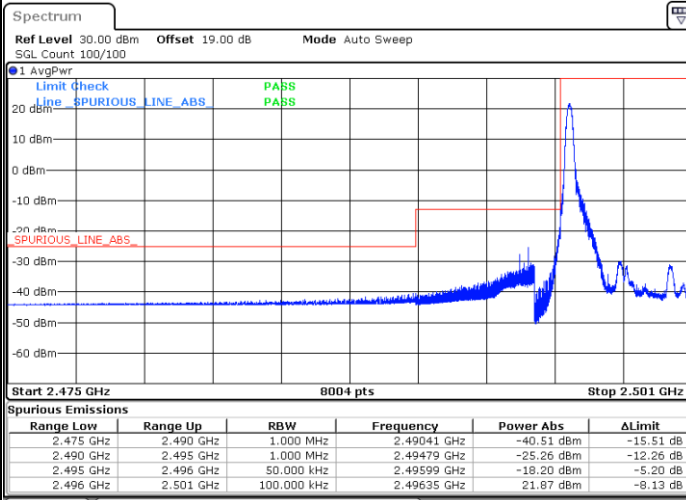

Date: 12.DEC.2023 14:27:42

Highest Band Edge / 1 RB

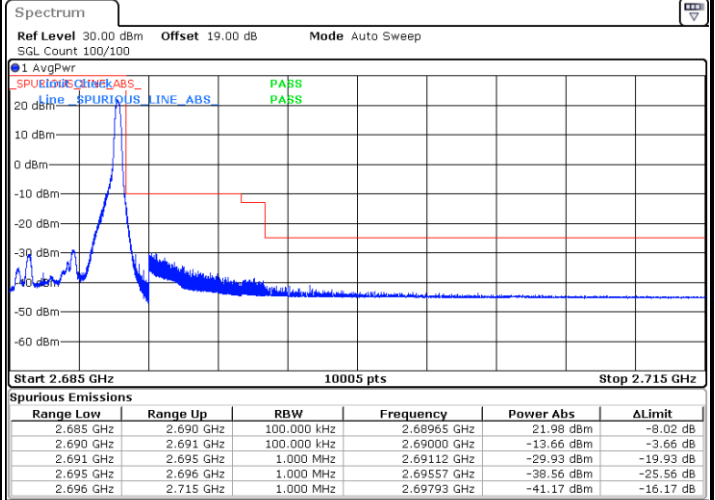

Date: 12.DEC.2023 14:57:00

Lowest Band Edge / Full RB

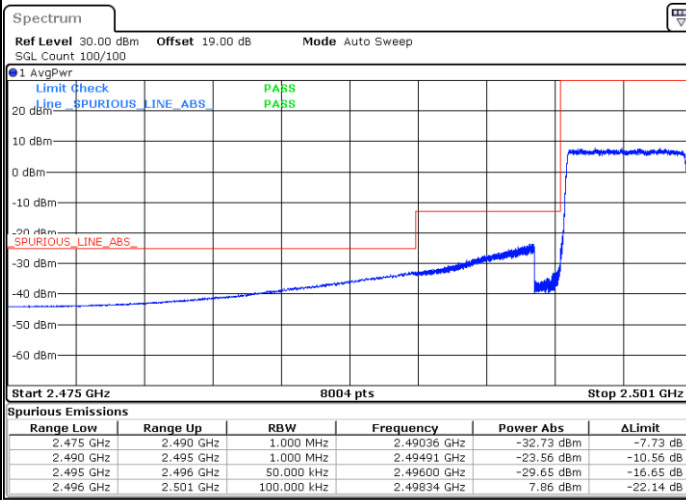

Date: 12.DEC.2023 14:29:37

Highest Band Edge / Full RB

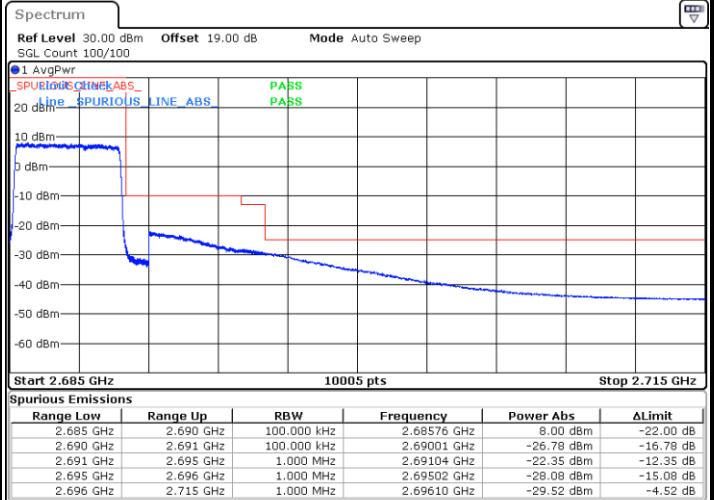

Date: 12.DEC.2023 14:47:00



LTE Band 41 / 10MHz / QPSK

Lowest Band Edge / 1 RB

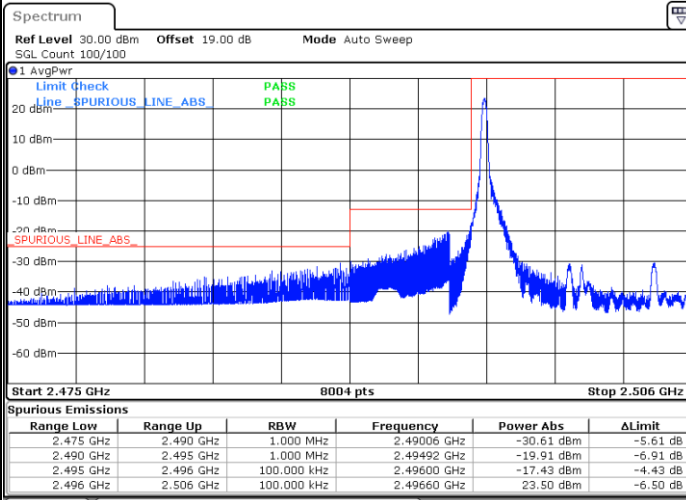

Date: 12.DEC.2023 15:09:08

Highest Band Edge / 1 RB

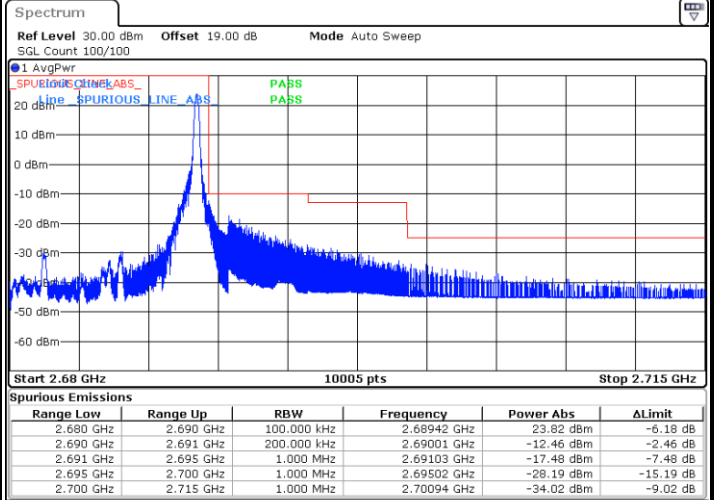

Date: 12.DEC.2023 15:19:42

Lowest Band Edge / Full RB

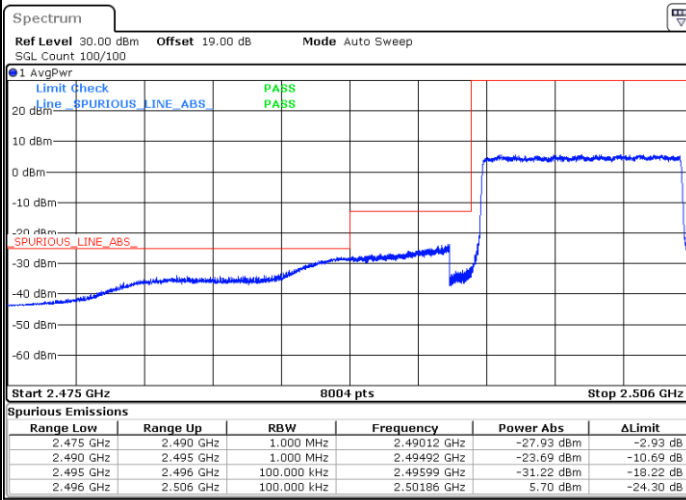

Date: 14.DEC.2023 13:06:18

Highest Band Edge / Full RB

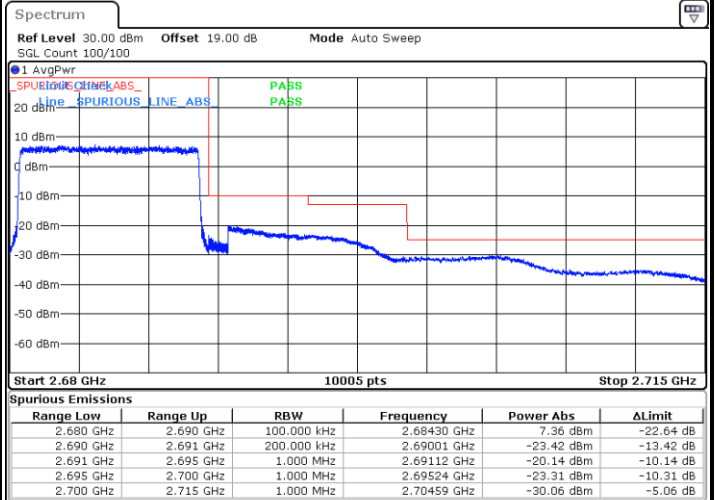

Date: 12.DEC.2023 15:18:32



LTE Band 41 / 10MHz / 16QAM

Lowest Band Edge / 1RB

Highest Band Edge / 1 RB

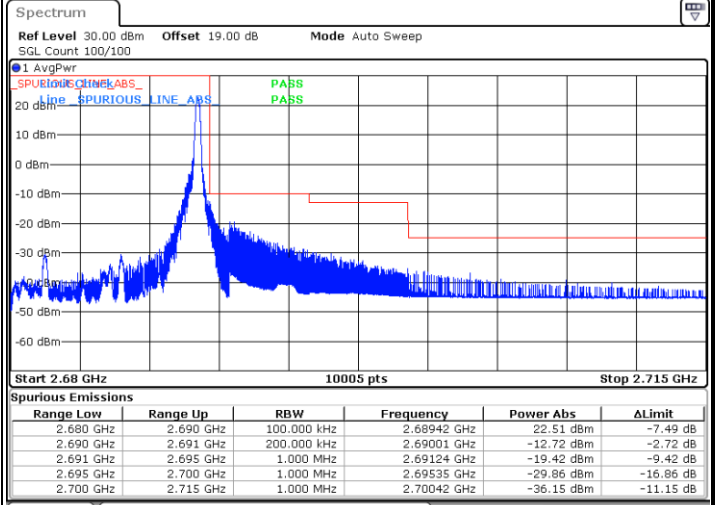
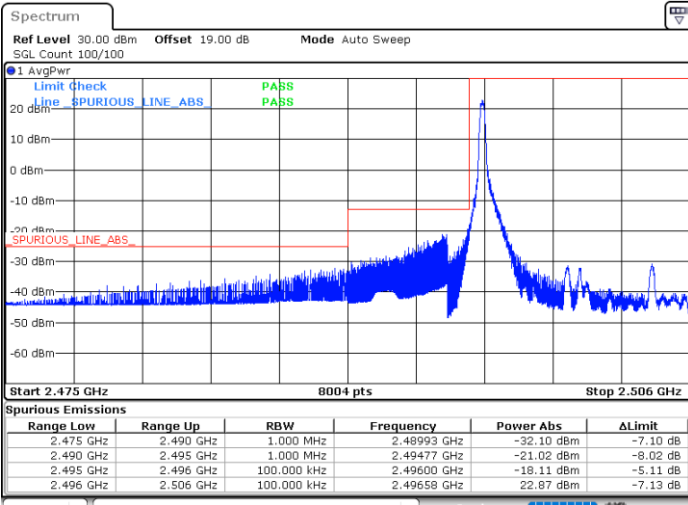

Date: 12.DEC.2023 15:10:19

Date: 12.DEC.2023 15:20:53

Lowest Band Edge / Full RB

Highest Band Edge / Full RB

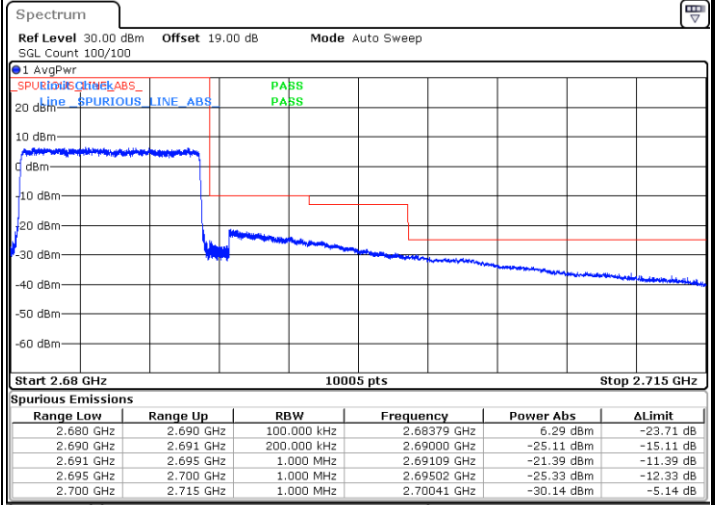
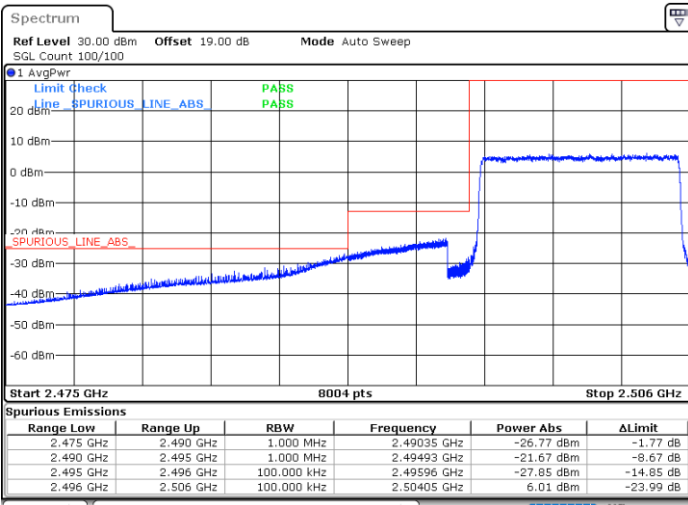

Date: 12.DEC.2023 15:13:51

Date: 12.DEC.2023 15:17:22



LTE Band 41 / 10MHz / 64QAM

Lowest Band Edge / 1RB

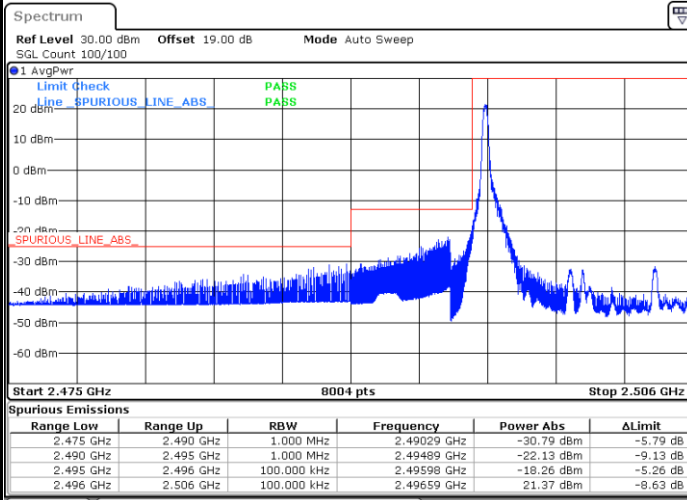

Date: 12.DEC.2023 15:11:29

Highest Band Edge / 1 RB

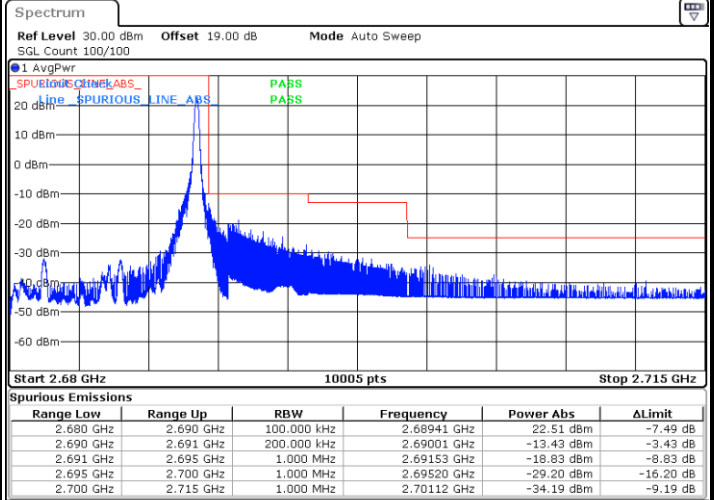

Date: 12.DEC.2023 15:22:03

Lowest Band Edge / Full RB

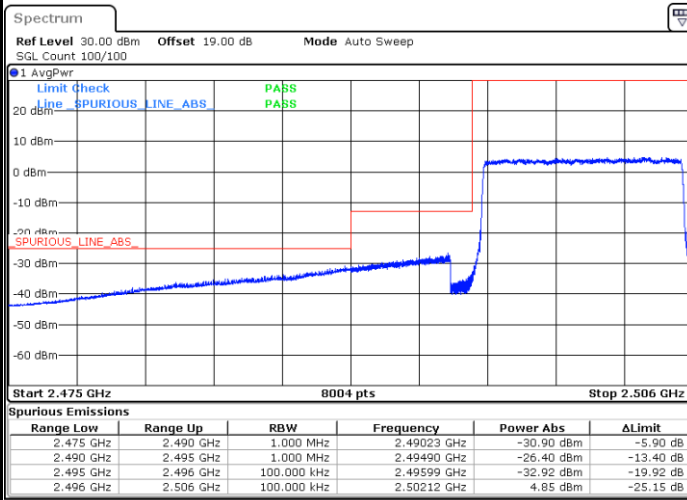

Date: 12.DEC.2023 15:15:01

Highest Band Edge / Full RB

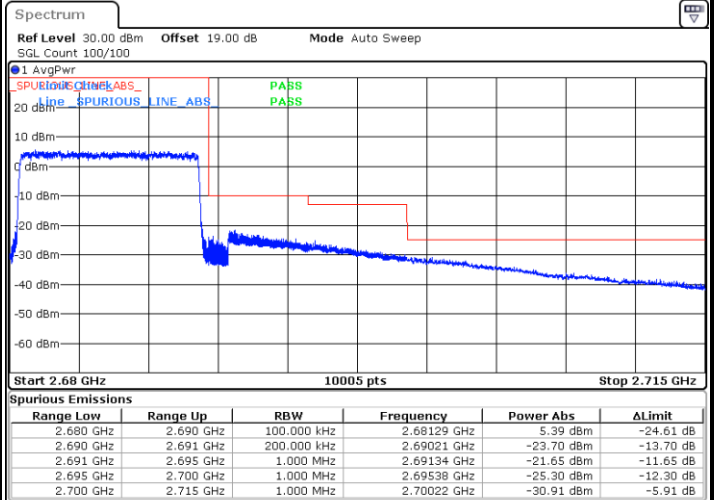

Date: 12.DEC.2023 15:16:11





LTE Band 41 / 15MHz / QPSK

Lowest Band Edge / 1 RB

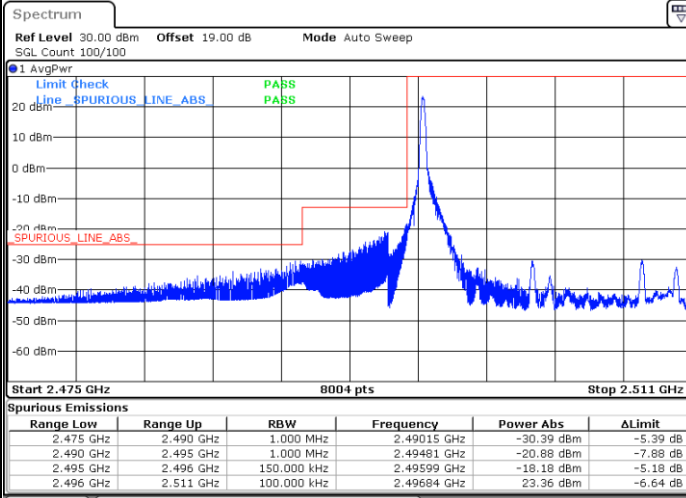

Date: 12.DEC.2023 15:29:18

Highest Band Edge / 1 RB

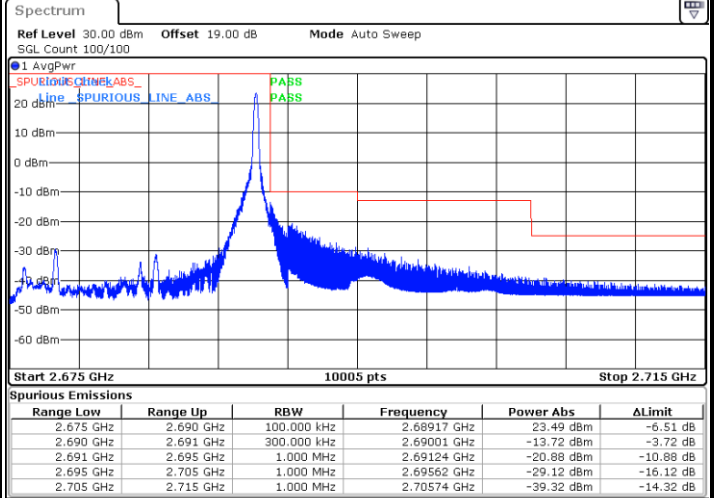

Date: 12.DEC.2023 15:42:12

Lowest Band Edge / Full RB

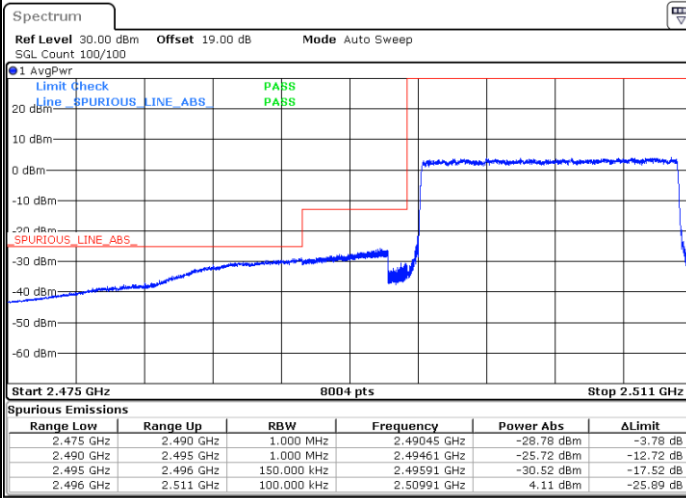

Date: 14.DEC.2023 13:07:58

Highest Band Edge / Full RB

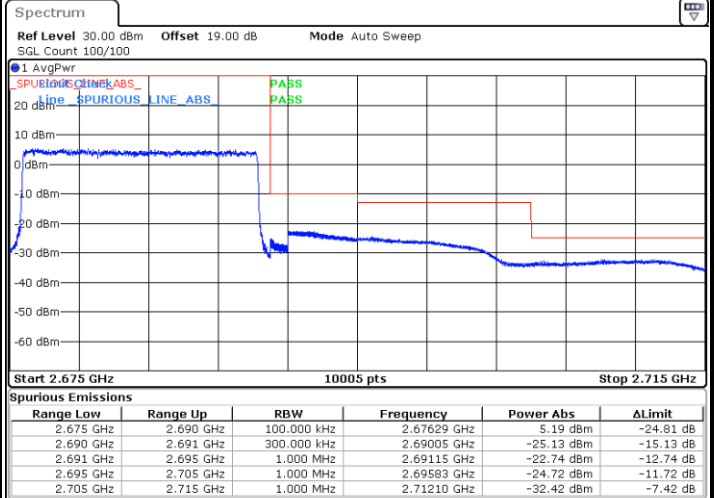

Date: 12.DEC.2023 15:36:20



LTE Band 41 / 15MHz / 16QAM

Lowest Band Edge / 1RB

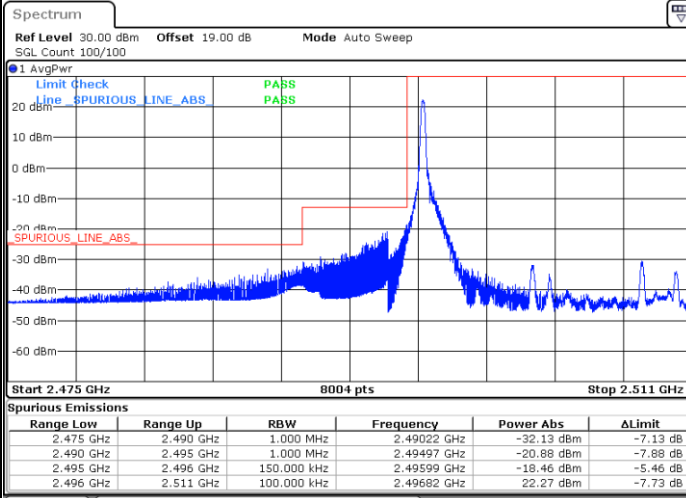

Date: 12.DEC.2023 15:30:28

Highest Band Edge / 1 RB

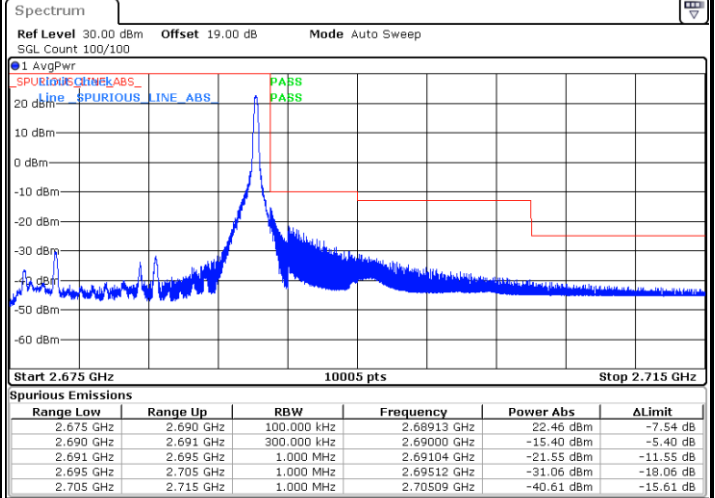

Date: 12.DEC.2023 15:41:02

Lowest Band Edge / Full RB

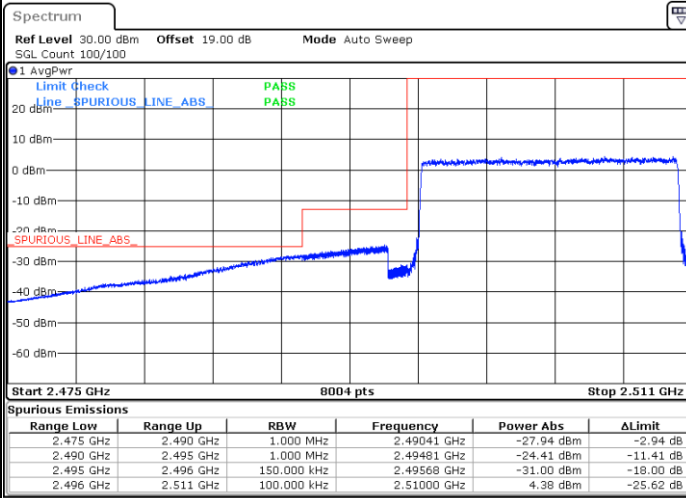

Date: 12.DEC.2023 15:34:00

Highest Band Edge / Full RB

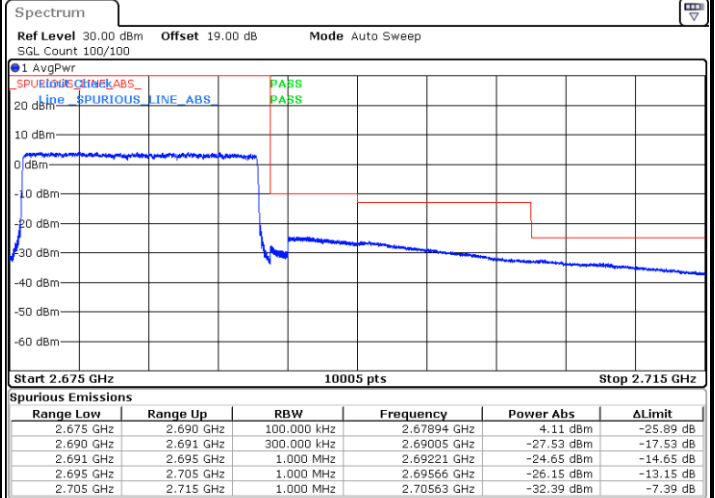

Date: 12.DEC.2023 15:37:31



LTE Band 41 / 15MHz / 64QAM

Lowest Band Edge / 1RB

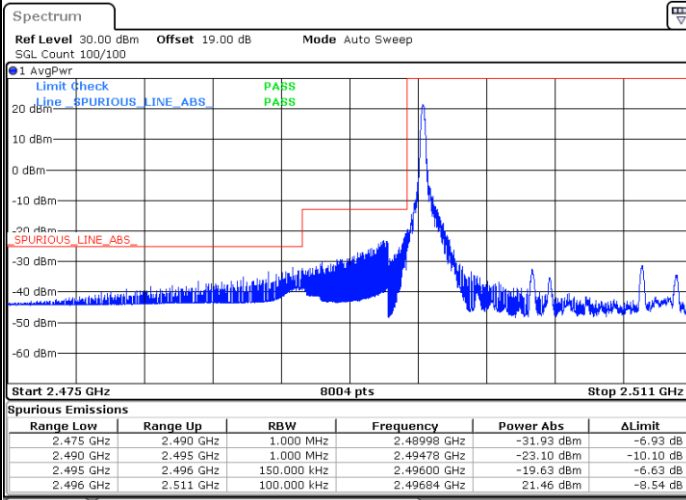

Date: 12.DEC.2023 15:31:39

Highest Band Edge / 1 RB

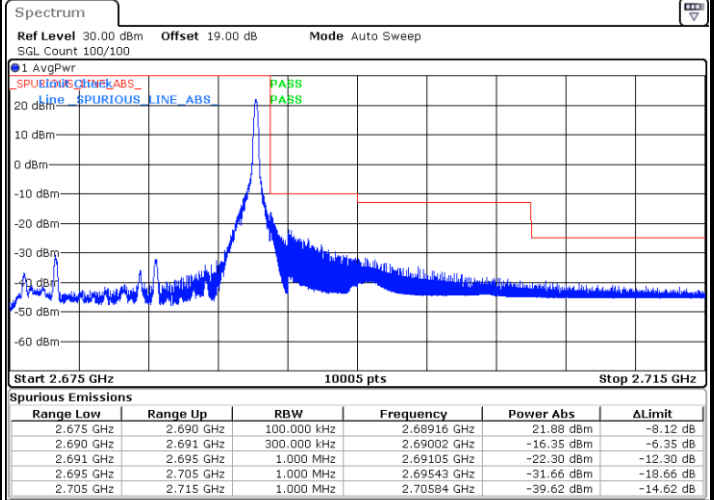

Date: 12.DEC.2023 15:39:51

Lowest Band Edge / Full RB

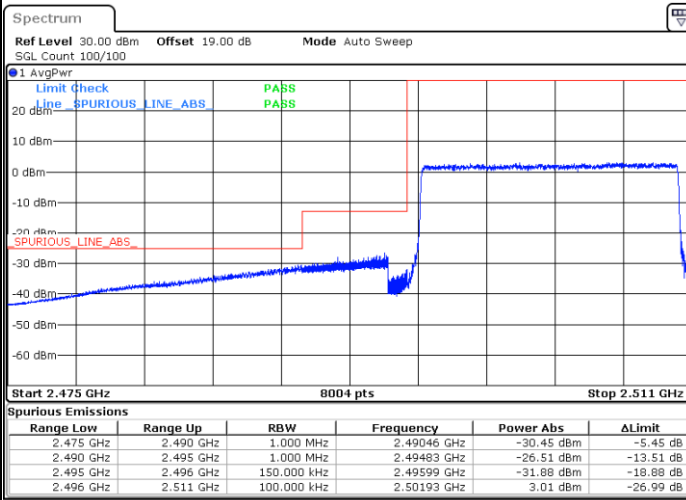

Date: 12.DEC.2023 15:32:49

Highest Band Edge / Full RB

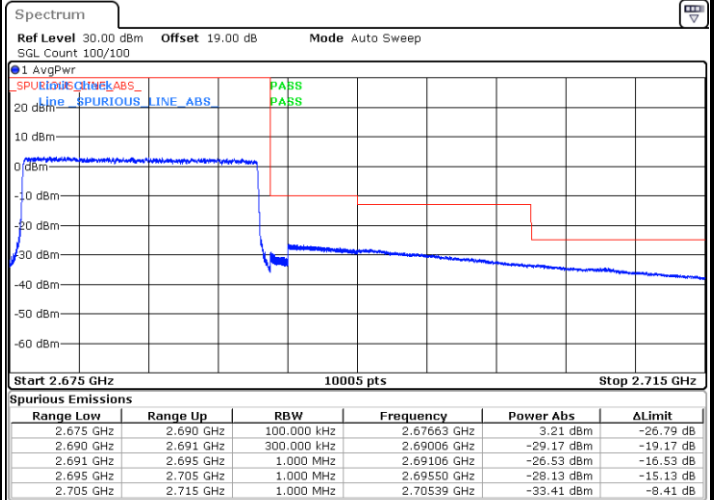

Date: 12.DEC.2023 15:38:41



LTE Band 41 / 20MHz / QPSK

Lowest Band Edge / 1 RB

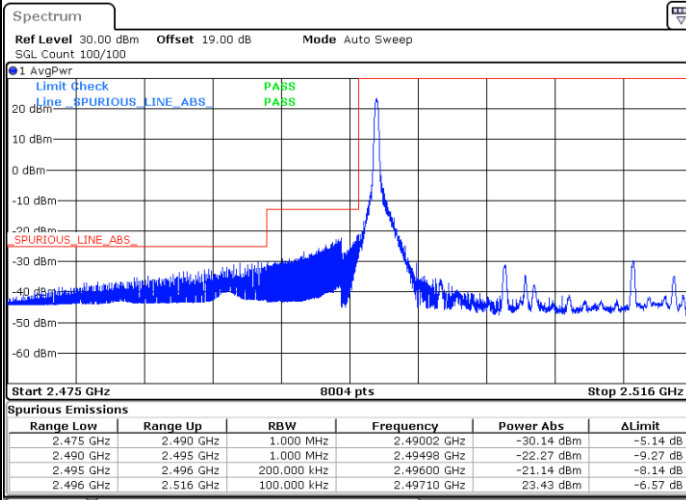

Date: 12.DEC.2023 15:44:38

Highest Band Edge / 1 RB

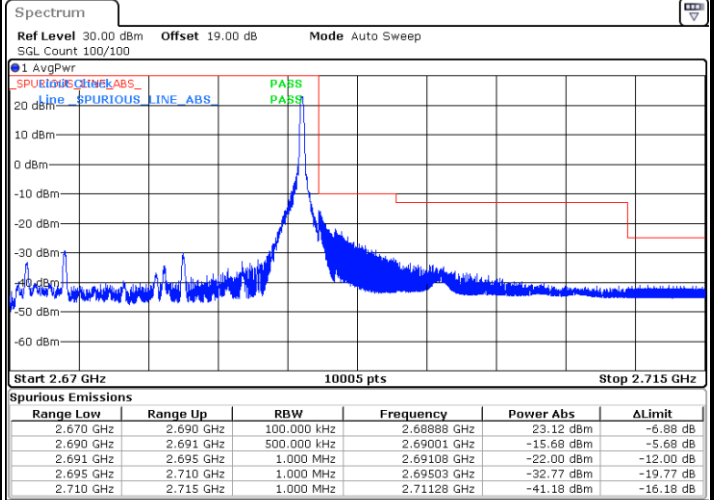

Date: 12.DEC.2023 15:51:20

Lowest Band Edge / Full RB

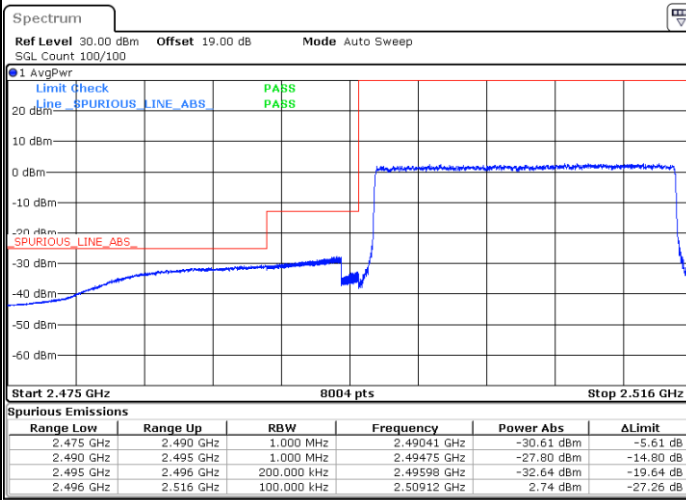

Date: 14.DEC.2023 13:09:37

Highest Band Edge / Full RB

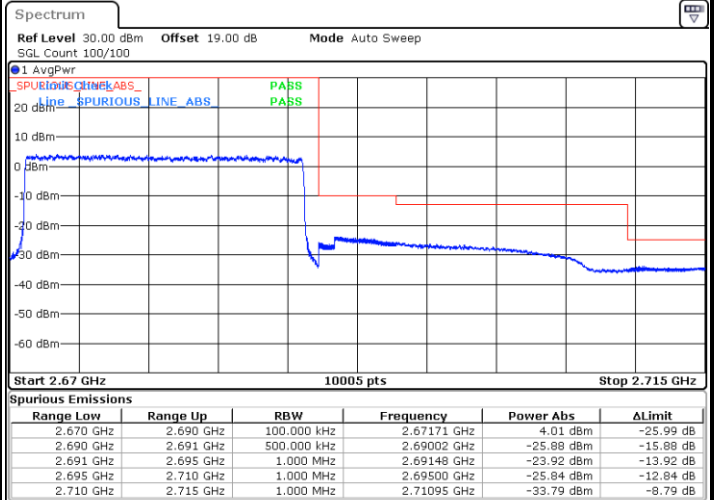

Date: 12.DEC.2023 15:56:47



LTE Band 41 / 20MHz / 16QAM

Lowest Band Edge / 1RB

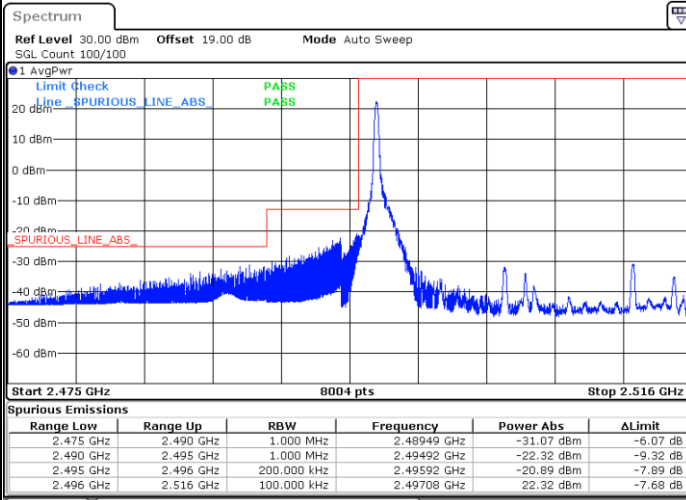

Date: 12.DEC.2023 15:45:48

Highest Band Edge / 1 RB

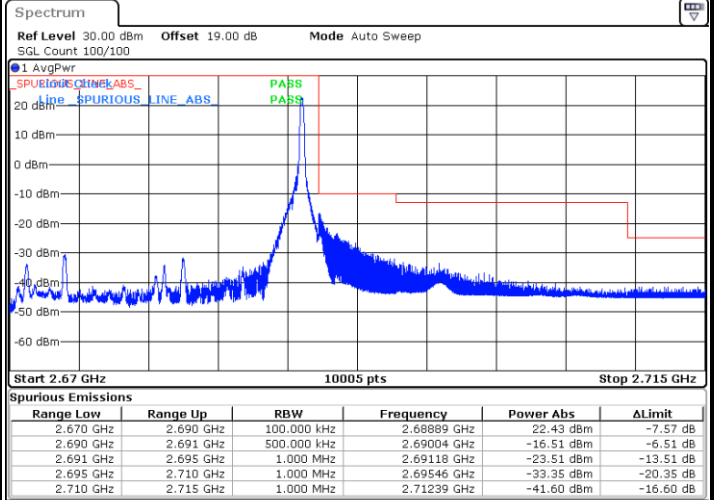

Date: 12.DEC.2023 15:52:26

Lowest Band Edge / Full RB

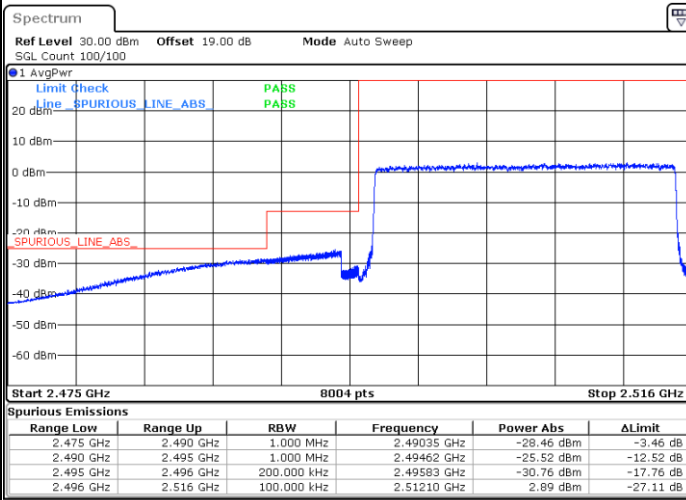

Date: 12.DEC.2023 15:49:09

Highest Band Edge / Full RB

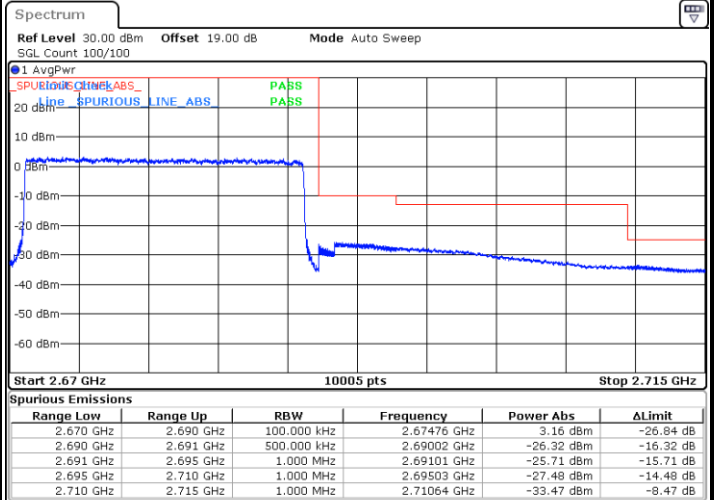

Date: 12.DEC.2023 15:55:42



LTE Band 41 / 20MHz / 64QAM

Lowest Band Edge / 1RB

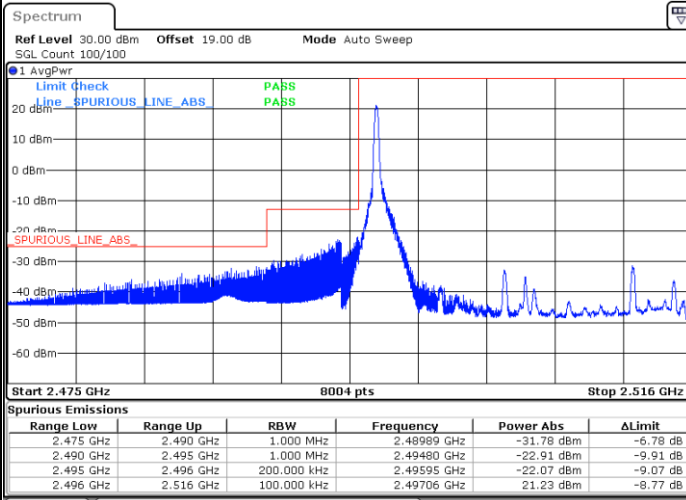

Date: 12.DEC.2023 15:46:58

Highest Band Edge / 1 RB

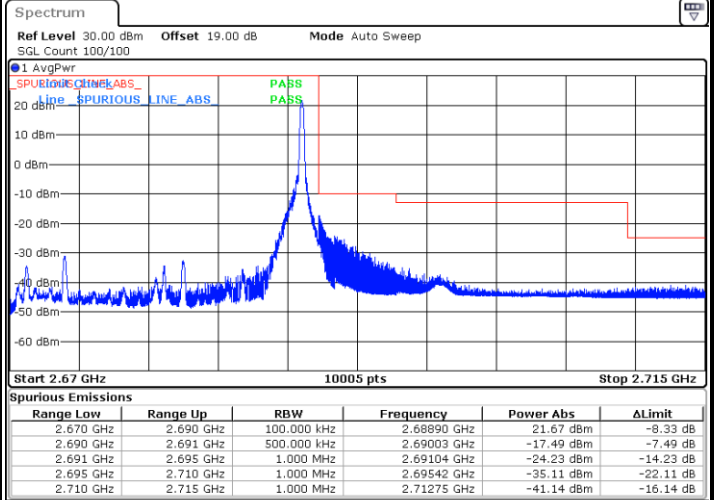

Date: 12.DEC.2023 15:53:31

Lowest Band Edge / Full RB

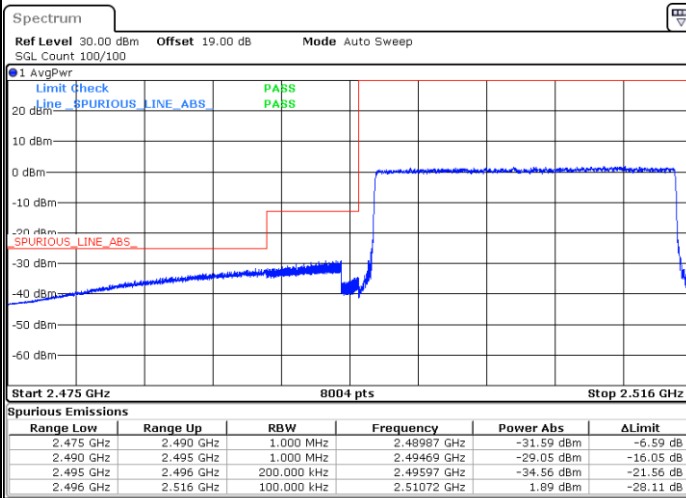

Date: 12.DEC.2023 15:48:04

Highest Band Edge / Full RB

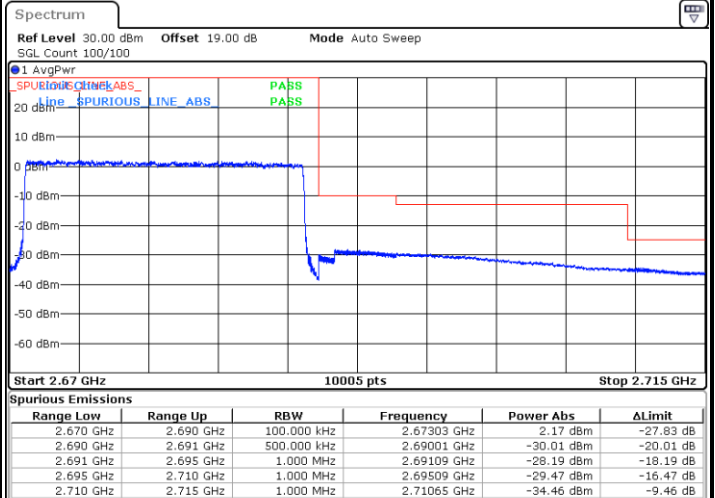

Date: 12.DEC.2023 15:54:36



# Conducted Spurious Emission

## LTE Band 41 / 5MHz

### Lowest Channel / QPSK

### Middle Channel / QPSK

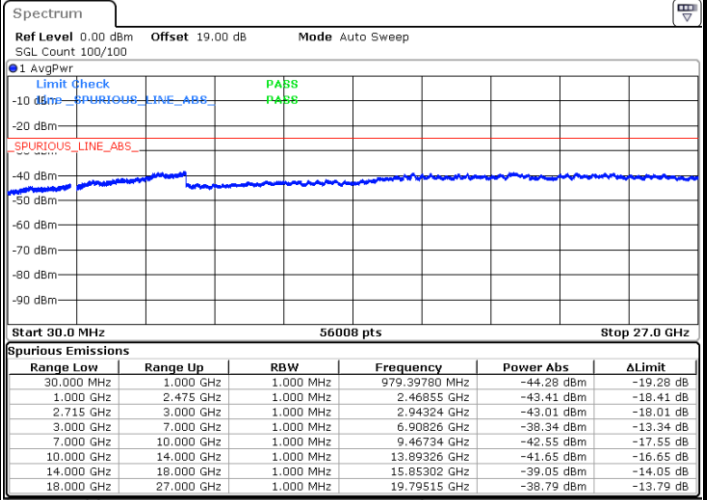
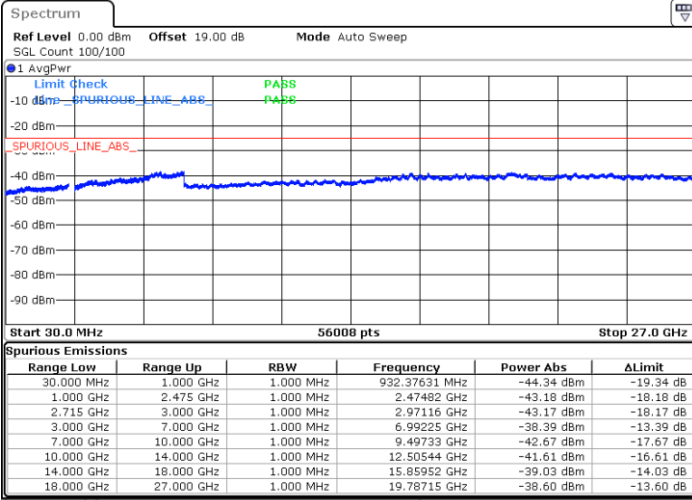

Date: 12.DEC.2023 17:58:14

Date: 12.DEC.2023 17:59:29

### Highest Channel / QPSK

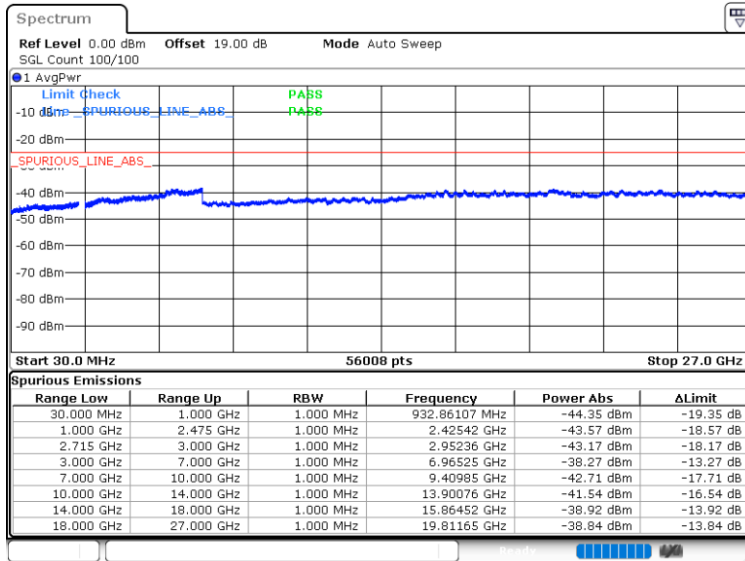

Date: 12.DEC.2023 18:02:03



LTE Band 41 / 10MHz

Lowest Channel / QPSK

Middle Channel / QPSK

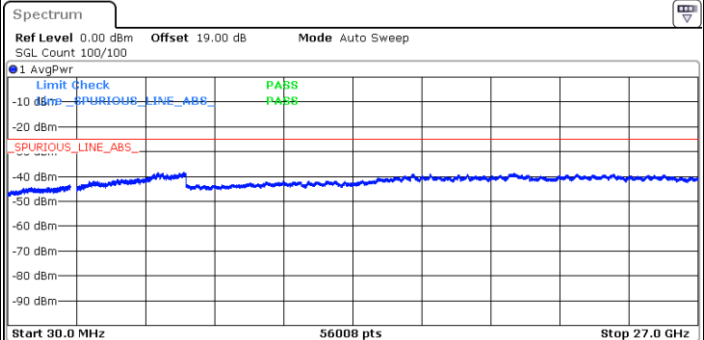
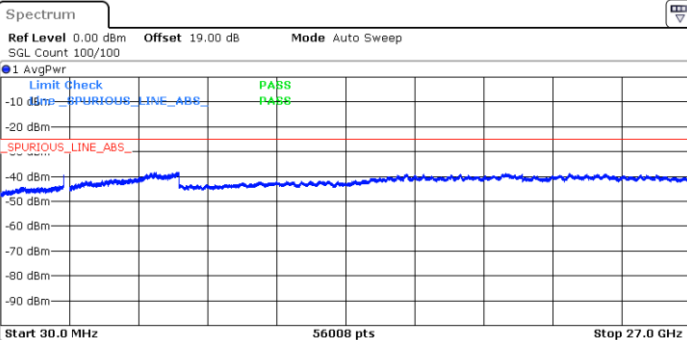

| Range Low  | Range Up   | RBW       | Frequency     | Power Abs  | ΔLimit    |
|------------|------------|-----------|---------------|------------|-----------|
| 30.000 MHz | 1.000 GHz  | 1.000 MHz | 969.21789 MHz | -44.33 dBm | -19.33 dB |
| 1.000 GHz  | 2.475 GHz  | 1.000 MHz | 2.47371 GHz   | -39.46 dBm | -14.46 dB |
| 2.715 GHz  | 3.000 GHz  | 1.000 MHz | 2.95763 GHz   | -43.05 dBm | -18.05 dB |
| 3.000 GHz  | 7.000 GHz  | 1.000 MHz | 6.94526 GHz   | -38.24 dBm | -13.24 dB |
| 7.000 GHz  | 10.000 GHz | 1.000 MHz | 9.46734 GHz   | -42.71 dBm | -17.71 dB |
| 10.000 GHz | 14.000 GHz | 1.000 MHz | 13.88626 GHz  | -41.39 dBm | -16.39 dB |
| 14.000 GHz | 18.000 GHz | 1.000 MHz | 15.85602 GHz  | -39.02 dBm | -14.02 dB |
| 18.000 GHz | 27.000 GHz | 1.000 MHz | 19.77615 GHz  | -38.83 dBm | -13.83 dB |

| Range Low  | Range Up   | RBW       | Frequency     | Power Abs  | ΔLimit    |
|------------|------------|-----------|---------------|------------|-----------|
| 30.000 MHz | 1.000 GHz  | 1.000 MHz | 942.55622 MHz | -44.26 dBm | -19.26 dB |
| 1.000 GHz  | 2.475 GHz  | 1.000 MHz | 2.46929 GHz   | -43.16 dBm | -18.16 dB |
| 2.715 GHz  | 3.000 GHz  | 1.000 MHz | 2.95492 GHz   | -43.18 dBm | -18.18 dB |
| 3.000 GHz  | 7.000 GHz  | 1.000 MHz | 6.91776 GHz   | -38.37 dBm | -13.37 dB |
| 7.000 GHz  | 10.000 GHz | 1.000 MHz | 9.47484 GHz   | -42.67 dBm | -17.67 dB |
| 10.000 GHz | 14.000 GHz | 1.000 MHz | 13.90076 GHz  | -41.58 dBm | -16.58 dB |
| 14.000 GHz | 18.000 GHz | 1.000 MHz | 16.55193 GHz  | -39.04 dBm | -14.04 dB |
| 18.000 GHz | 27.000 GHz | 1.000 MHz | 19.79565 GHz  | -38.64 dBm | -13.64 dB |

Date: 12.DEC.2023 18:39:07

Date: 12.DEC.2023 18:40:23

Highest Channel / QPSK

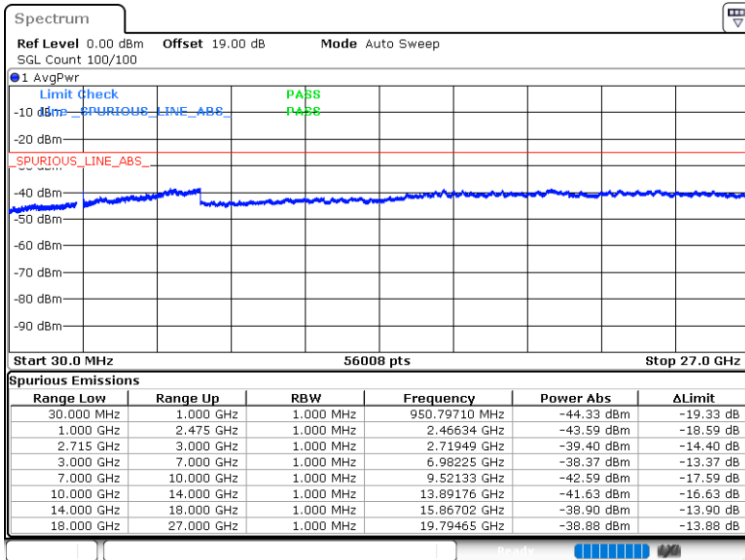

| Range Low  | Range Up   | RBW       | Frequency     | Power Abs  | ΔLimit    |
|------------|------------|-----------|---------------|------------|-----------|
| 30.000 MHz | 1.000 GHz  | 1.000 MHz | 950.79710 MHz | -44.33 dBm | -19.33 dB |
| 1.000 GHz  | 2.475 GHz  | 1.000 MHz | 2.46634 GHz   | -43.59 dBm | -18.59 dB |
| 2.715 GHz  | 3.000 GHz  | 1.000 MHz | 2.71949 GHz   | -39.40 dBm | -14.40 dB |
| 3.000 GHz  | 7.000 GHz  | 1.000 MHz | 6.98225 GHz   | -38.37 dBm | -13.37 dB |
| 7.000 GHz  | 10.000 GHz | 1.000 MHz | 9.52133 GHz   | -42.59 dBm | -17.59 dB |
| 10.000 GHz | 14.000 GHz | 1.000 MHz | 13.89176 GHz  | -41.63 dBm | -16.63 dB |
| 14.000 GHz | 18.000 GHz | 1.000 MHz | 15.86702 GHz  | -38.90 dBm | -13.90 dB |
| 18.000 GHz | 27.000 GHz | 1.000 MHz | 19.79465 GHz  | -38.88 dBm | -13.88 dB |

Date: 12.DEC.2023 18:42:59





LTE Band 41 / 15MHz

Lowest Channel / QPSK

Middle Channel / QPSK

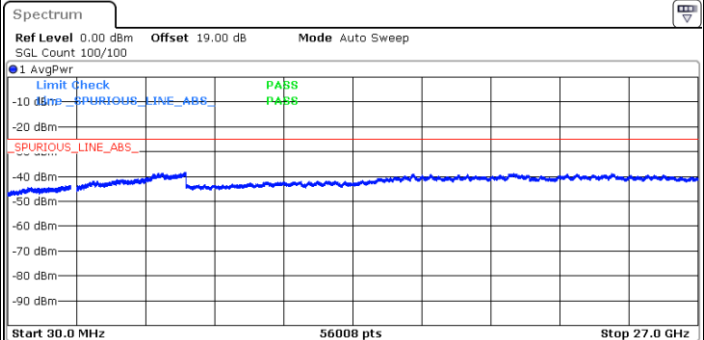
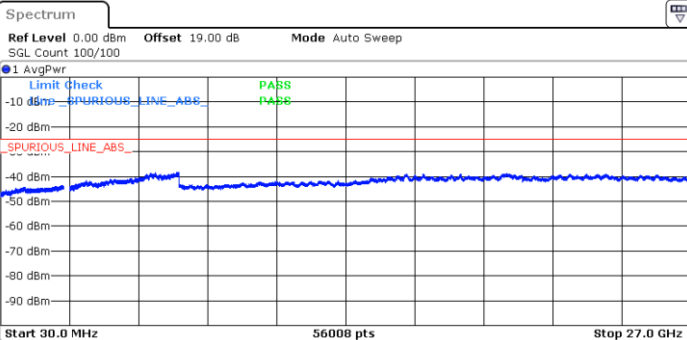

| Range Low  | Range Up   | RBW       | Frequency     | Power Abs  | ΔLimit    |
|------------|------------|-----------|---------------|------------|-----------|
| 30.000 MHz | 1.000 GHz  | 1.000 MHz | 956.12944 MHz | -44.31 dBm | -19.31 dB |
| 1.000 GHz  | 2.475 GHz  | 1.000 MHz | 2.46671 GHz   | -43.64 dBm | -18.64 dB |
| 2.715 GHz  | 3.000 GHz  | 1.000 MHz | 2.96332 GHz   | -42.83 dBm | -17.83 dB |
| 3.000 GHz  | 7.000 GHz  | 1.000 MHz | 6.08136 GHz   | -38.31 dBm | -13.31 dB |
| 7.000 GHz  | 10.000 GHz | 1.000 MHz | 9.50193 GHz   | -42.65 dBm | -17.65 dB |
| 10.000 GHz | 14.000 GHz | 1.000 MHz | 13.88326 GHz  | -41.63 dBm | -16.63 dB |
| 14.000 GHz | 18.000 GHz | 1.000 MHz | 17.98425 GHz  | -38.99 dBm | -13.99 dB |
| 18.000 GHz | 27.000 GHz | 1.000 MHz | 19.79065 GHz  | -38.57 dBm | -13.57 dB |

| Range Low  | Range Up   | RBW       | Frequency     | Power Abs  | ΔLimit    |
|------------|------------|-----------|---------------|------------|-----------|
| 30.000 MHz | 1.000 GHz  | 1.000 MHz | 806.82409 MHz | -44.28 dBm | -19.28 dB |
| 1.000 GHz  | 2.475 GHz  | 1.000 MHz | 2.46671 GHz   | -43.57 dBm | -18.57 dB |
| 2.715 GHz  | 3.000 GHz  | 1.000 MHz | 2.95677 GHz   | -43.14 dBm | -18.14 dB |
| 3.000 GHz  | 7.000 GHz  | 1.000 MHz | 6.93776 GHz   | -38.25 dBm | -13.25 dB |
| 7.000 GHz  | 10.000 GHz | 1.000 MHz | 9.49333 GHz   | -42.66 dBm | -17.66 dB |
| 10.000 GHz | 14.000 GHz | 1.000 MHz | 13.88226 GHz  | -41.59 dBm | -16.59 dB |
| 14.000 GHz | 18.000 GHz | 1.000 MHz | 15.84352 GHz  | -38.99 dBm | -13.99 dB |
| 18.000 GHz | 27.000 GHz | 1.000 MHz | 23.63494 GHz  | -38.78 dBm | -13.78 dB |

Date: 12.DEC.2023 20:52:24

Date: 12.DEC.2023 20:53:39

Highest Channel / QPSK

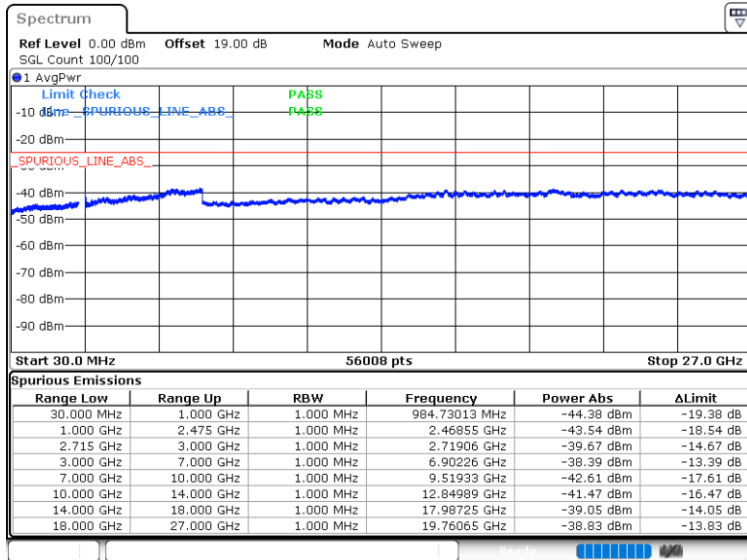

| Range Low  | Range Up   | RBW       | Frequency     | Power Abs  | ΔLimit    |
|------------|------------|-----------|---------------|------------|-----------|
| 30.000 MHz | 1.000 GHz  | 1.000 MHz | 984.73013 MHz | -44.38 dBm | -19.38 dB |
| 1.000 GHz  | 2.475 GHz  | 1.000 MHz | 2.46855 GHz   | -43.54 dBm | -18.54 dB |
| 2.715 GHz  | 3.000 GHz  | 1.000 MHz | 2.71906 GHz   | -39.67 dBm | -14.67 dB |
| 3.000 GHz  | 7.000 GHz  | 1.000 MHz | 6.90226 GHz   | -38.39 dBm | -13.39 dB |
| 7.000 GHz  | 10.000 GHz | 1.000 MHz | 9.51933 GHz   | -42.61 dBm | -17.61 dB |
| 10.000 GHz | 14.000 GHz | 1.000 MHz | 12.84989 GHz  | -41.47 dBm | -16.47 dB |
| 14.000 GHz | 18.000 GHz | 1.000 MHz | 17.98725 GHz  | -39.05 dBm | -14.05 dB |
| 18.000 GHz | 27.000 GHz | 1.000 MHz | 19.76065 GHz  | -38.83 dBm | -13.83 dB |

Date: 12.DEC.2023 20:56:15



LTE Band 41 / 20MHz

Lowest Channel / QPSK

Middle Channel / QPSK

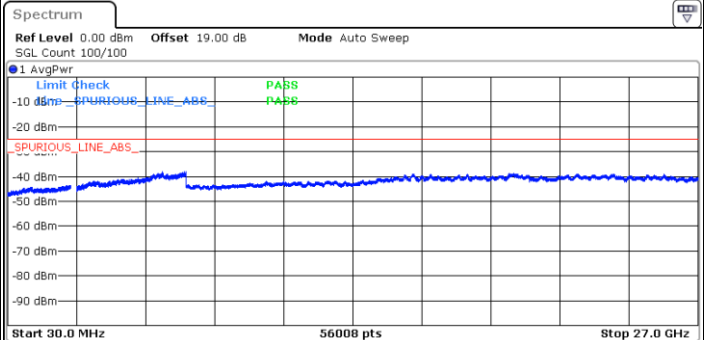
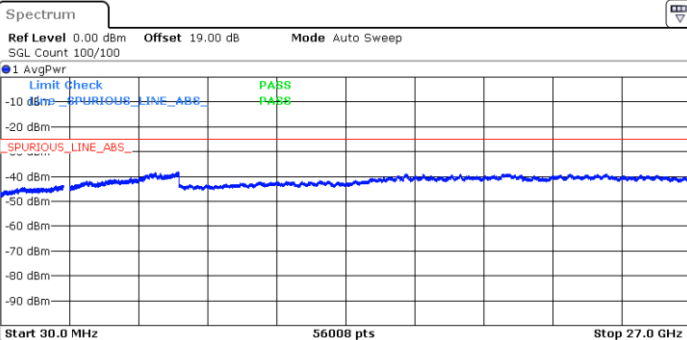

| Range Low  | Range Up   | RBW       | Frequency     | Power Abs  | ΔLimit    |
|------------|------------|-----------|---------------|------------|-----------|
| 30.000 MHz | 1.000 GHz  | 1.000 MHz | 967.27886 MHz | -44.33 dBm | -19.33 dB |
| 1.000 GHz  | 2.475 GHz  | 1.000 MHz | 2.46228 GHz   | -43.53 dBm | -18.53 dB |
| 2.715 GHz  | 3.000 GHz  | 1.000 MHz | 2.99950 GHz   | -43.29 dBm | -18.29 dB |
| 3.000 GHz  | 7.000 GHz  | 1.000 MHz | 6.97725 GHz   | -38.19 dBm | -13.19 dB |
| 7.000 GHz  | 10.000 GHz | 1.000 MHz | 9.50283 GHz   | -42.65 dBm | -17.65 dB |
| 10.000 GHz | 14.000 GHz | 1.000 MHz | 12.48944 GHz  | -41.69 dBm | -16.69 dB |
| 14.000 GHz | 18.000 GHz | 1.000 MHz | 15.89551 GHz  | -38.99 dBm | -13.99 dB |
| 18.000 GHz | 27.000 GHz | 1.000 MHz | 19.76865 GHz  | -39.00 dBm | -14.00 dB |

| Range Low  | Range Up   | RBW       | Frequency     | Power Abs  | ΔLimit    |
|------------|------------|-----------|---------------|------------|-----------|
| 30.000 MHz | 1.000 GHz  | 1.000 MHz | 947.88856 MHz | -44.27 dBm | -19.27 dB |
| 1.000 GHz  | 2.475 GHz  | 1.000 MHz | 2.42320 GHz   | -43.56 dBm | -18.56 dB |
| 2.715 GHz  | 3.000 GHz  | 1.000 MHz | 2.96033 GHz   | -42.90 dBm | -17.90 dB |
| 3.000 GHz  | 7.000 GHz  | 1.000 MHz | 6.98075 GHz   | -38.04 dBm | -13.04 dB |
| 7.000 GHz  | 10.000 GHz | 1.000 MHz | 9.47584 GHz   | -42.56 dBm | -17.56 dB |
| 10.000 GHz | 14.000 GHz | 1.000 MHz | 13.92126 GHz  | -41.63 dBm | -16.63 dB |
| 14.000 GHz | 18.000 GHz | 1.000 MHz | 15.86902 GHz  | -38.96 dBm | -13.96 dB |
| 18.000 GHz | 27.000 GHz | 1.000 MHz | 19.63866 GHz  | -38.87 dBm | -13.87 dB |

Date: 12.DEC.2023 21:04:01

Date: 12.DEC.2023 21:05:16

Highest Channel / QPSK

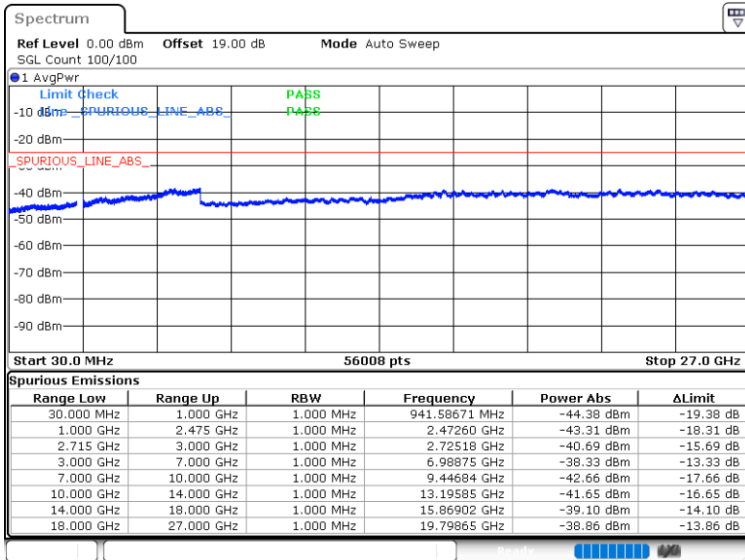

Date: 12.DEC.2023 21:09:16



### Frequency Stability

| Test Conditions  |                   | LTE Band 41 (QPSK) / Middle Channel | Limit   |
|------------------|-------------------|-------------------------------------|---------|
| Temperature (°C) | Voltage (Volt)    | BW 10MHz                            | Note 2. |
|                  |                   | Deviation (ppm)                     | Result  |
| 50               | Normal Voltage    | 0.0014                              | PASS    |
| 40               | Normal Voltage    | 0.0012                              |         |
| 30               | Normal Voltage    | 0.0002                              |         |
| 20(Ref.)         | Normal Voltage    | 0.0000                              |         |
| 10               | Normal Voltage    | 0.0032                              |         |
| 0                | Normal Voltage    | 0.0005                              |         |
| -10              | Normal Voltage    | 0.0017                              |         |
| -20              | Normal Voltage    | 0.0013                              |         |
| -30              | Normal Voltage    | 0.0008                              |         |
| 20               | Maximum Voltage   | 0.0017                              |         |
| 20               | Normal Voltage    | 0.0000                              |         |
| 20               | Battery End Point | 0.0013                              |         |

**Note:**

1. Normal Voltage = 3.91 V. ; Battery End Point (BEP) = 3.6 V. ; Maximum Voltage = 4.45 V.
2. The frequency fundamental emissions stay within the authorized frequency block.



# LTE Band 41C

## 26dB Bandwidth

| Mode      | LTE Band 41C : 26dB BW(MHz) |             |             |             |             |
|-----------|-----------------------------|-------------|-------------|-------------|-------------|
| QPSK      |                             |             |             |             |             |
| BW        | 5MHz+20MHz                  | 10MHz+15MHz | 10MHz+20MHz | 15MHz+10MHz | 15MHz+15MHz |
| Middle CH | 24.73                       | 25.03       | 29.73       | 25.13       | 30.51       |
| BW        | 15MHz+20MHz                 | 20MHz+5MHz  | 20MHz+10MHz | 20MHz+15MHz | 20MHz+20MHz |
| Middle CH | 34.62                       | 24.98       | 29.97       | 34.90       | 39.88       |

| Mode      | LTE Band 41C : 26dB BW(MHz) |             |             |             |             |
|-----------|-----------------------------|-------------|-------------|-------------|-------------|
| 16QAM     |                             |             |             |             |             |
| BW        | 5MHz+20MHz                  | 10MHz+15MHz | 10MHz+20MHz | 15MHz+10MHz | 15MHz+15MHz |
| Middle CH | 24.63                       | 24.88       | 29.73       | 25.13       | 30.51       |
| BW        | 15MHz+20MHz                 | 20MHz+5MHz  | 20MHz+10MHz | 20MHz+15MHz | 20MHz+20MHz |
| Middle CH | 34.90                       | 24.98       | 29.97       | 34.83       | 39.80       |



LTE Band 41C

QPSK

Middle Channel / 5MHz+20MHz

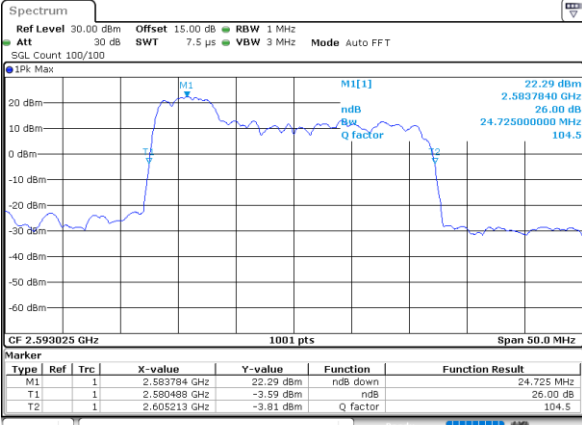

Date: 13, DEC, 2023 19:17:44

Middle Channel / 10MHz+15MHz

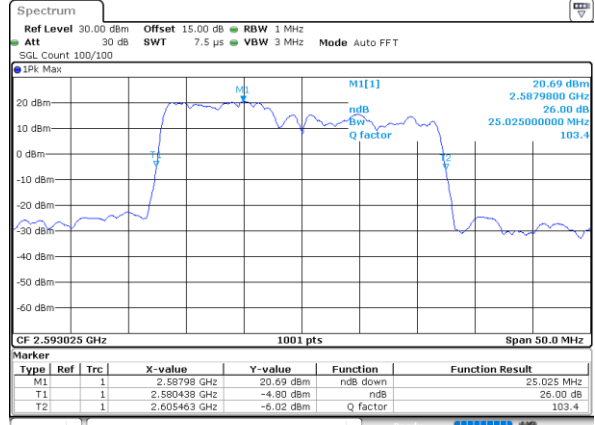

Date: 13, DEC, 2023 21:43:52

Middle Channel / 10MHz+20MHz

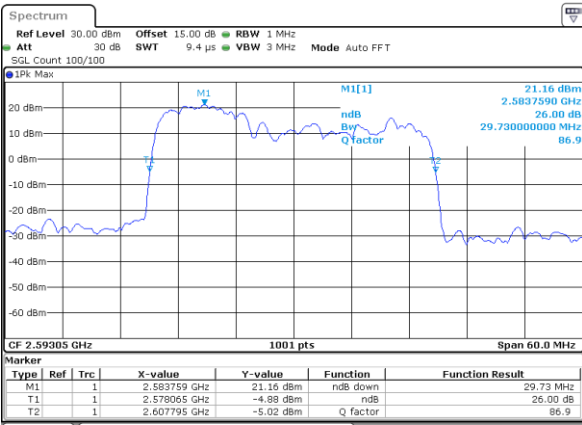

Date: 13, DEC, 2023 22:38:32

Middle Channel / 15MHz+10MHz

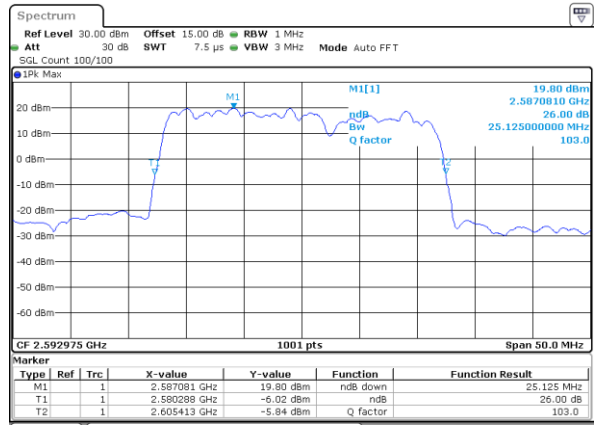

Date: 13, DEC, 2023 22:11:15

Middle Channel / 15MHz+15MHz

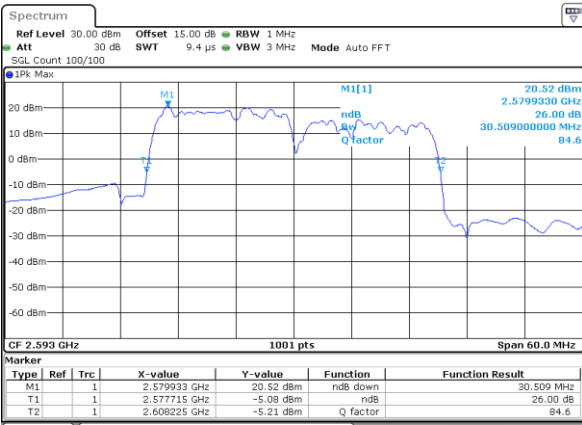

Date: 13, DEC, 2023 23:33:05

Middle Channel / 15MHz+20MHz

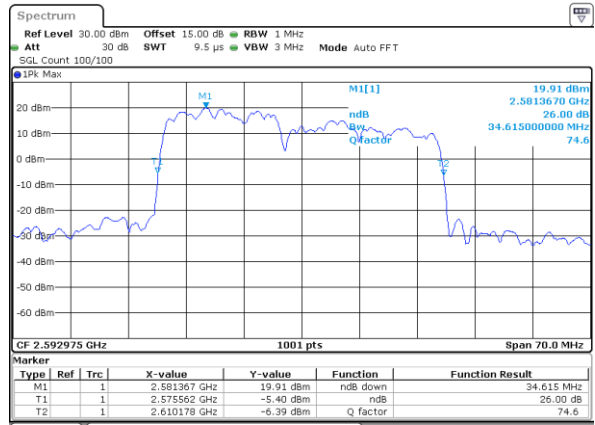

Date: 13, DEC, 2023 23:58:37



LTE Band 41C

QPSK

Middle Channel / 20MHz+5MHz

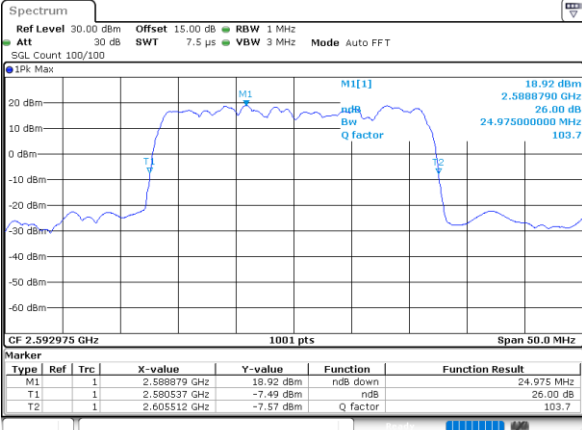

Date: 13, DEC, 2023 21:16:38

Middle Channel / 20MHz+10MHz

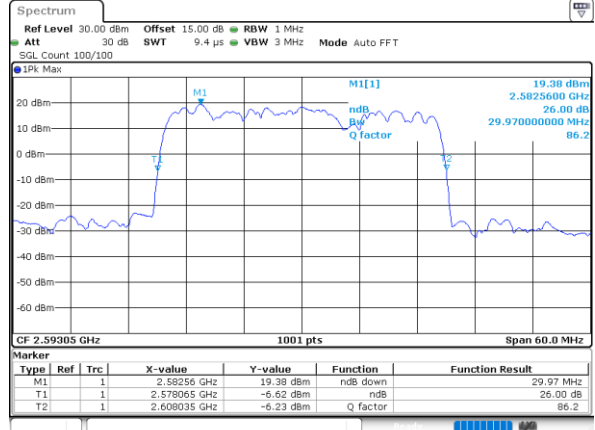

Date: 13, DEC, 2023 23:05:57

Middle Channel / 20MHz+15MHz

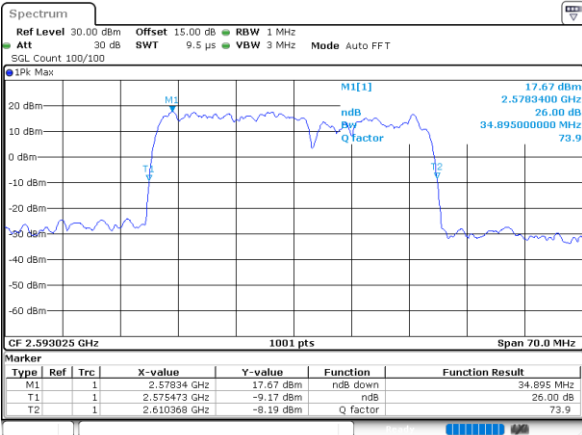

Date: 14, DEC, 2023 00:26:11

Middle Channel / 20MHz+20MHz

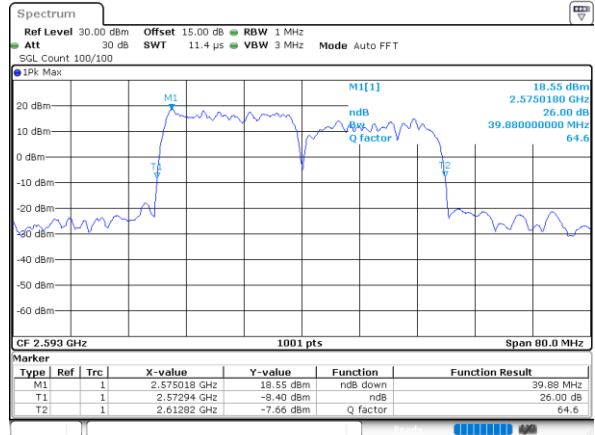

Date: 14, DEC, 2023 00:53:20



LTE Band 41C

16QAM

Middle Channel / 5MHz+20MHz

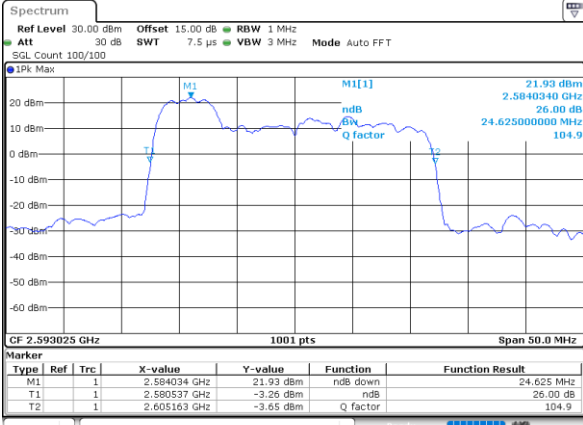

Date: 13, DEC, 2023 19:18:14

Middle Channel / 10MHz+15MHz

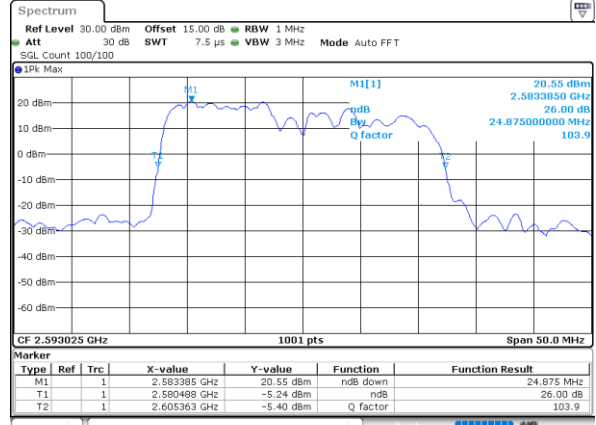

Date: 13, DEC, 2023 21:44:28

Middle Channel / 10MHz+20MHz

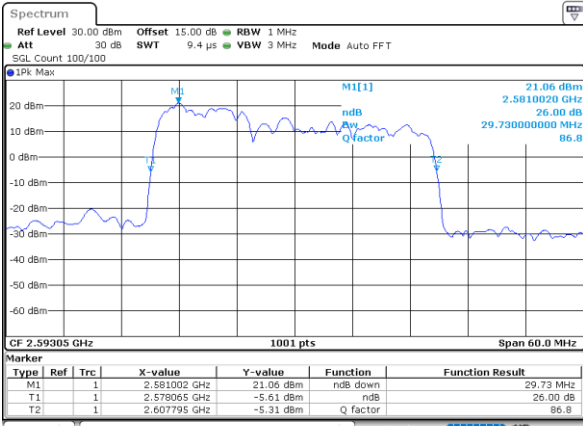

Date: 13, DEC, 2023 22:39:09

Middle Channel / 15MHz+10MHz

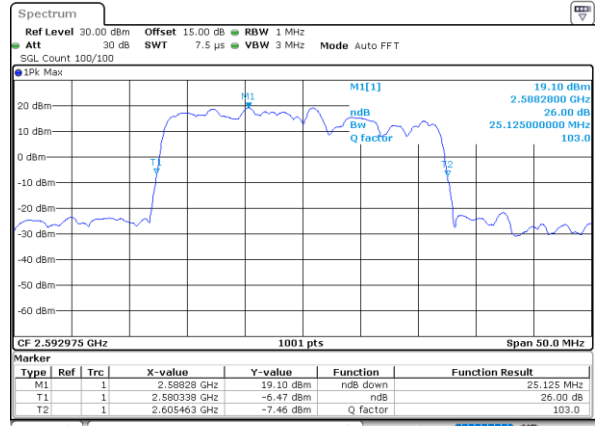

Date: 13, DEC, 2023 22:11:52

Middle Channel / 15MHz+15MHz

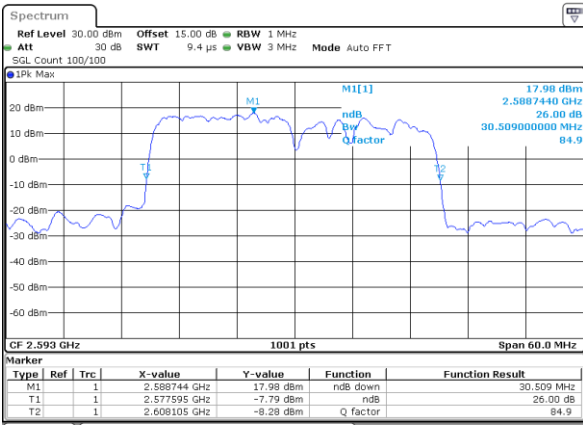

Date: 13, DEC, 2023 23:33:36

Middle Channel / 15MHz+20MHz

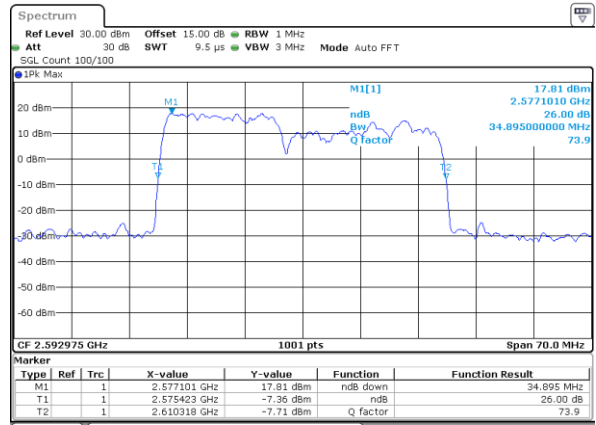

Date: 13, DEC, 2023 23:59:13