



FCC RF Test Report

APPLICANT : Motorola Mobility LLC
EQUIPMENT : Mobile Cellular Phone
BRAND NAME : Motorola
MODEL NAME : XT2343-1
FCC ID : IHDT56AM4
STANDARD : 47 CFR Part 2, 27(M), 27(H), 27(F)
CLASSIFICATION : PCS Licensed Transmitter Held to Ear (PCE)
TEST DATE(S) : Jun. 25, 2023 ~ Jun. 29, 2023

We, Sporton International Inc. (Kunshan), would like to declare that the tested sample has been evaluated in accordance with the procedures given in ANSI C63.26-2015 and shown compliance with the applicable technical standards.

The test results in this report apply exclusively to the tested model / sample. Without written approval of Sporton International Inc. (Kunshan), the test report shall not be reproduced except in full.

Jason Jia

Approved by: Jason Jia



Sporton International Inc. (Kunshan)

**No. 1098, Pengxi North Road, Kunshan Economic Development Zone Jiangsu Province 215300
People's Republic of China**



TABLE OF CONTENTS

REVISION HISTORY... 3
SUMMARY OF TEST RESULT ... 4
1 GENERAL DESCRIPTION ... 5
1.1 Applicant ... 5
1.2 Manufacturer ... 5
1.3 Product Feature of Equipment Under Test ... 5
1.4 Product Specification of Equipment Under Test ... 5
1.5 Specification of Accessory ... 6
1.6 Modification of EUT ... 6
1.7 Maximum ERP/EIRP Power and Emission Designator ... 7
1.8 Testing Location ... 8
1.9 Test Software ... 8
1.10 Applicable Standards ... 8
2 TEST CONFIGURATION OF EQUIPMENT UNDER TEST ... 9
2.1 Test Mode ... 9
2.2 Connection Diagram of Test System ... 12
2.3 Support Unit used in test configuration and system ... 12
2.4 Measurement Results Explanation Example ... 12
2.5 Frequency List of Low/Middle/High Channels ... 13
3 CONDUCTED TEST ITEMS ... 18
3.1 Measuring Instruments ... 18
3.2 Test Setup ... 18
3.3 Test Result of Conducted Test ... 18
3.4 Conducted Output Power and ERP/EIRP ... 19
3.5 Peak-to-Average Ratio ... 20
3.6 Occupied Bandwidth ... 21
3.7 Conducted Band Edge ... 22
3.8 Conducted Spurious Emission ... 24
3.9 Frequency Stability ... 25
4 RADIATED TEST ITEMS ... 26
4.1 Measuring Instruments ... 26
4.2 Test Setup ... 26
4.3 Test Result of Radiated Test ... 27
4.4 Radiated Spurious Emission ... 28
5 LIST OF MEASURING EQUIPMENT ... 29
6 MEASUREMENT UNCERTAINTY ... 30
APPENDIX A. TEST RESULTS OF CONDUCTED TEST
APPENDIX B. TEST RESULTS OF RADIATED TEST
APPENDIX C. TEST SETUP PHOTOGRAPHS



REVISION HISTORY

REPORT NO.	VERSION	DESCRIPTION	ISSUED DATE
FG352916C	Rev. 01	Initial issue of report	Jul. 20, 2023



SUMMARY OF TEST RESULT

Report Section	FCC Rule	Description	Limit	Result	Remark
3.4	§2.1046	Conducted Output Power	-	Report Only	-
	§27.50(b)(10) §27.50(c)(10)	Effective Radiated Power (Band 12) (Band 13) (Band 17)	ERP < 3 Watt	PASS	-
	§27.50(h)(2)	Equivalent Isotropic Radiated Power (Band 7) (Band 38) (Band 41)	EIRP < 2Watt		-
3.5	N/A	Peak-to-Average Ratio	<13 dB	PASS	-
3.6	§2.1049	Occupied Bandwidth	-	Report Only	-
3.7	§2.1051 §27.53(c)(2)(4) §27.53(g)	Conducted Band Edge Measurement (Band 12) (Band 13) (Band 17)	< 43+10log ₁₀ (P[Watts])	PASS	-
	§27.53(m)(4)	Conducted Band Edge Measurement (Band 7) (Band 38) (Band 41)	§27.53(m)(4)		
3.8	§2.1051 §27.53(c)(2) §27.53(g)	Conducted Spurious Emission (Band 12) (Band 13) (Band 17)	< 43+10log ₁₀ (P[Watts])	PASS	-
	§2.1051 §27.53(m)(4)	Conducted Spurious Emission (Band 7) (Band 38) (Band 41)	< 55+10log ₁₀ (P[Watts])		
3.9	§2.1055 §27.54	Frequency Stability Temperature & Voltage	Within Authorized Band	PASS	-
4.4	§2.1053 §27.53(c)(2) §27.53(f) §27.53(g)	Radiated Spurious Emission (Band 12) (Band 13) (Band 17)	< 43+10log ₁₀ (P[Watts])	PASS	Under limit 15.76 dB at 5050.00 MHz
	§2.1053 §27.53(m)(4)	Radiated Spurious Emission (Band 7) (Band 38) (Band 41)	< 55+10log ₁₀ (P[Watts])		

Conformity Assessment Condition:

- The test results (PASS/FAIL) with all measurement uncertainty excluded are presented against the regulation limits or in accordance with the requirements stipulated by the applicant/manufacturer who shall bear all the risks of non-compliance that may potentially occur if measurement uncertainty is taken into account.
- The measurement uncertainty please refer to each test result in the section "Measurement Uncertainty"

Disclaimer:

The product specifications of the EUT presented in the test report that may affect the test assessments are declared by the manufacturer who shall take full responsibility for the authenticity.



1 General Description

1.1 Applicant

Motorola Mobility LLC
222 W, Merchandise Mart Plaza, Chicago IL 60654 USA

1.2 Manufacturer

Motorola Mobility LLC
222 W, Merchandise Mart Plaza, Chicago IL 60654 USA

1.3 Product Feature of Equipment Under Test

Product Feature	
Equipment	Mobile Cellular Phone
Brand Name	Motorola
Model Name	XT2343-1
FCC ID	IHDT56AM4
IMEI Code	Conducted: 352326290031213/352326290031221 Radiation: 352326290030496/352326290030504
HW Version	DVT2
SW Version	TTD33.32
EUT Stage	Identical Prototype

1.4 Product Specification of Equipment Under Test

Standards-related Product Specification	
Tx Frequency	LTE Band 7 : 2500 MHz ~ 2570 MHz LTE Band 12 : 699 MHz ~ 716 MHz LTE Band 13 : 777 MHz ~ 787 MHz LTE Band 17 : 704 MHz ~ 716 MHz LTE Band 38 : 2570 MHz ~ 2620 MHz LTE Band 41 : 2496 MHz ~ 2690 MHz
Rx Frequency	LTE Band 7 : 2620 MHz ~ 2690 MHz LTE Band 12 : 729 MHz ~ 746 MHz LTE Band 13 : 746 MHz ~ 756 MHz LTE Band 17 : 734 MHz ~ 746 MHz LTE Band 38 : 2570 MHz ~ 2620 MHz LTE Band 41 : 2496 MHz ~ 2690 MHz
Bandwidth	LTE Band 7 : 5MHz/ 10MHz / 15MHz / 20MHz LTE Band 12 : 1.4MHz / 3MHz / 5MHz / 10MHz LTE Band 13 : 5MHz / 10MHz LTE Band 17 : 5MHz / 10MHz LTE Band 38 : 5MHz / 10MHz / 15MHz / 20MHz LTE Band 41 : 5MHz / 10MHz / 15MHz / 20MHz
Maximum Output Power to Antenna	<Ant. 0> LTE Band 12 : 22.68 dBm LTE Band 13 : 22.73 dBm



	LTE Band 17 : 22.62 dBm <Ant. 1> LTE Band 7 : 23.04 dBm / LTE Band 7C : 22.81 dBm LTE Band 38 : 22.88 dBm / LTE Band 38C : 22.60 dBm LTE Band 41 : 22.97 dBm / LTE Band 41C : 22.64 dBm <Ant. 4> LTE Band 7 : 22.93 dBm
Antenna Gain	<Ant. 0> LTE Band 12 : -3.60 dBi LTE Band 13 : -4.60 dBi LTE Band 17 : -3.60 dBi <Ant. 1> LTE Band 7 : -3.80 dBi LTE Band 38 : -4.20 dBi LTE Band 41 : -4.10 dBi <Ant. 4> LTE Band 7 : -4.40 dBi
Type of Modulation	QPSK / 16QAM / 64QAM

Remark:

1. The maximum ERP/EIRP is calculated from max output power and max antenna gain, so only the maximum ERP/EIRP of Ant.0 for LTE Band 12/13/17 and Ant.1 for Band 7/38/41/7C/38C/41C are shown in the report.
2. LTE Band 7 support other PA for Inter band ULCA mode, both main PA and other PA modes are full tested, only the worst mode are shown in the report.

1.5 Specification of Accessory

Specification of Accessory				
AC Adapter 1 (US)	Brand Name	Motorola(Salcomp)	Model Name	MC-201L
AC Adapter 1 (EU)	Brand Name	Motorola(Salcomp)	Model Name	MC-202L
AC Adapter 1 (AR)	Brand Name	Motorola(Salcomp)	Model Name	MC-206L
AC Adapter 1 (BR)	Brand Name	Motorola(Salcomp)	Model Name	MC-207L
AC Adapter 1 (CHILE)	Brand Name	Motorola(Salcomp)	Model Name	MC-209L
AC Adapter 2 (US)	Brand Name	Motorola(AOHAI)	Model Name	MC-201L
AC Adapter 2 (EU)	Brand Name	Motorola(AOHAI)	Model Name	MC-202L
AC Adapter 2 (AR)	Brand Name	Motorola(AOHAI)	Model Name	MC-206L
AC Adapter 3 (BR)	Brand Name	Motorola(Cliptech)	Model Name	MC-207L
AC Adapter 4 (BR)	Brand Name	Motorola(Chenyang)	Model Name	MC-207L
Battery 1	Brand Name	Motorola (ATL)	Model Name	PC50
Battery 2	Brand Name	Motorola (SCUD)	Model Name	PC50
USB Cable 1	Brand Name	Motorola (WASHIN)	Model Name	S928D92375
USB Cable 2	Brand Name	Motorola (Saibao)	Model Name	S928D95755
USB Cable 3	Brand Name	Motorola (ISHENG)	Model Name	SC18D38574

1.6 Modification of EUT

No modifications are made to the EUT during all test items.



1.7 Maximum ERP/EIRP Power and Emission Designator

LTE Band 7		QPSK		16QAM/64QAM	
BW (MHz)	Frequency Range (MHz)	Maximum EIRP(W)	Emission Designator (99%OBW)	Maximum EIRP(W)	Emission Designator (99%OBW)
20	2510.0 ~ 2560.0	0.0839	17M9G7D	0.0671	18M0W7D
LTE Band 12		QPSK		16QAM/64QAM	
BW (MHz)	Frequency Range (MHz)	Maximum ERP(W)	Emission Designator (99%OBW)	Maximum ERP(W)	Emission Designator (99%OBW)
10	704.0 ~ 711.0	0.0493	9M01G7D	0.0378	8M99W7D
LTE Band 13		QPSK		16QAM/64QAM	
BW (MHz)	Frequency Range (MHz)	Maximum ERP(W)	Emission Designator (99%OBW)	Maximum ERP(W)	Emission Designator (99%OBW)
10	782.0	0.0396	9M01G7D	0.0303	9M01W7D
LTE Band 17		QPSK		16QAM/64QAM	
BW (MHz)	Frequency Range (MHz)	Maximum ERP(W)	Emission Designator (99%OBW)	Maximum ERP(W)	Emission Designator (99%OBW)
10	709.0 ~ 711.0	0.0486	9M01G7D	0.0370	8M99W7D
LTE Band 38		QPSK		16QAM/64QAM	
BW (MHz)	Frequency Range (MHz)	Maximum EIRP(W)	Emission Designator (99%OBW)	Maximum EIRP(W)	Emission Designator (99%OBW)
20	2580.0 ~ 2610.0	0.0738	17M9G7D	0.0582	17M9W7D
LTE Band 41		QPSK		16QAM/64QAM	
BW (MHz)	Frequency Range (MHz)	Maximum EIRP(W)	Emission Designator (99%OBW)	Maximum EIRP(W)	Emission Designator (99%OBW)
20	2506.0 ~ 2680.0	0.0771	17M9G7D	0.0612	17M9W7D

LTE Band 7 CA		QPSK		16QAM/64QAM	
BW (MHz)		Maximum EIRP(W)	Emission Designator (99%OBW)	Maximum EIRP(W)	Emission Designator (99%OBW)
20MHz+20MHz		0.0796	37M6G7D	0.0649	38M0W7D
LTE Band 38 CA		QPSK		16QAM/64QAM	
BW (MHz)		Maximum EIRP(W)	Emission Designator (99%OBW)	Maximum EIRP(W)	Emission Designator (99%OBW)
20MHz+20MHz		0.0692	37M7G7D	0.0541	37M5W7D
LTE Band 41 CA		QPSK		16QAM/64QAM	
BW (MHz)		Maximum EIRP(W)	Emission Designator (99%OBW)	Maximum EIRP(W)	Emission Designator (99%OBW)
20MHz+20MHz		0.0714	37M7G7D	0.0553	37M5W7D

Note:

1. LTE Band 12 overlaps the entire frequency range of LTE Band 17. Therefore, the test results provided in this report covers Band 12 as well as Band 17.
2. LTE Band 41/41C overlaps the entire frequency range of LTE Band 38/38C. Therefore, the test results provided in this report covers Band 41/41C as well as Band 38/38C.
3. All modulations have been tested, and only the worst test results of PSK & QAM are shown in the report.



1.8 Testing Location

Sporton International Inc. (Kunshan) is accredited to ISO/IEC 17025:2017 by American Association for Laboratory Accreditation with Certificate Number 5145.02.

Test Firm	Sporton International Inc. (Kunshan)		
Test Site Location	No. 1098, Pengxi North Road, Kunshan Economic Development Zone Jiangsu Province 215300 People's Republic of China TEL : +86-512-57900158		
Test Site No.	Sporton Site No.	FCC Designation No.	FCC Test Firm Registration No.
	03CH04-KS TH01-KS	CN1257	314309

1.9 Test Software

Item	Site	Manufacture	Name	Version
1.	03CH04-KS	AUDIX	E3	6.2009-8-24al

1.10 Applicable Standards

According to the specifications of the manufacturer, the EUT must comply with the requirements of the following standards:

- 47 CFR Part 2, 27(M), 27(H), 27(F)
- ANSI C63.26-2015
- FCC KDB 971168 D01 Power Meas License Digital Systems v03r01
- FCC KDB 412172 D01 Determining ERP and EIRP v01r01

Remark:

1. All test items were verified and recorded according to the standards and without any deviation during the test.
2. This EUT has also been tested and complied with the requirements of FCC Part 15, Subpart B, recorded in a separate test report.



2 Test Configuration of Equipment Under Test

2.1 Test Mode

Antenna port conducted and radiated test items listed below are performed according to KDB 971168 D01 Power Meas License Digital Systems v03r01 with maximum output power.

Radiated measurements are performed by rotating the EUT in three different orthogonal test planes to find the maximum emission (X/Z Plane).

Test Items	Band	Bandwidth (MHz)						Modulation				RB #			Test Channel		
		1.4	3	5	10	15	20	QPSK	16QAM	64QAM	256QAM	1	Half	Full	L	M	H
Max. Output Power	7	-	-	v	v	v	v	v	v	v	-	v		v	v	v	v
	12	v	v	v	v	-	-	v	v	v	-	v		v	v	v	v
	13	-	-	v	v	-	-	v	v	v	-	v		v	v	v	v
	17	-	-	v	v	-	-	v	v	v	-	v		v	v	v	v
	38	-	-	v	v	v	v	v	v	v	-	v		v	v	v	v
	41	-	-	v	v	v	v	v	v	v	-	v		v	v	v	v
Peak-to-Average Ratio	7	-	-				v	v	v	v	-			v		v	
	12				v	-	-	v	v	v	-			v		v	
	13	-	-		v	-	-	v	v	v	-			v		v	
	41	-	-				v	v	v	v	-			v		v	
26dB and 99% Bandwidth	7	-	-	v	v	v	v	v	v		-			v		v	
	12	v	v	v	v	-	-	v	v		-			v		v	
	13	-	-	v	v	-	-	v	v		-			v		v	
	41	-	-	v	v	v	v	v	v		-			v		v	
Conducted Band Edge	7	-	-	v	v	v	v	v	v	v	-	v		v	v		v
	12	v	v	v	v	-	-	v	v	v	-	v		v	v		v
	13	-	-	v	v	-	-	v	v	v	-	v		v	v		v
	41	-	-	v	v	v	v	v	v	v	-	v		v	v		v



Test Items	Band	Bandwidth (MHz)						Modulation				RB #			Test Channel			
		1.4	3	5	10	15	20	QPSK	16QAM	64QAM	256QAM	1	Half	Full	L	M	H	
Conducted Spurious Emission	7	-	-	v	v	v	v	v			-	v			v	v	v	
	12	v	v	v	v	-	-	v			-	v			v	v	v	
	13	-	-	v	v	-	-	v			-	v			v	v	v	
	41	-	-	v	v	v	v	v			-	v			v	v	v	
Frequency Stability	7	-	-		v			v			-			v		v		
	12				v	-	-	v			-			v		v		
	13	-	-		v	-	-	v			-			v		v		
	41	-	-		v			v			-			v		v		
E.R.P / E.I.R.P	7	-	-	v	v	v	v	v	v	v	-	v		v	v	v	v	
	12	v	v	v	v	-	-	v	v	v	-	v		v	v	v	v	
	13	-	-	v	v	-	-	v	v	v	-	v		v	v	v	v	
	17	-	-	v	v	-	-	v	v	v	-	v		v	v	v	v	
	38	-	-	v	v	v	v	v	v	v	-	v		v	v	v	v	
	41	-	-	v	v	v	v	v	v	v	-	v		v	v	v	v	
Radiated Spurious Emission	7	Worst Case															v	
	12	Worst Case															v	
	13	Worst Case															v	
	41	Worst Case															v	
Note	1. The mark "v" means that this configuration is chosen for testing 2. The mark "-" means that this bandwidth is not supported. 3. The device is investigated from 30MHz to 10 times of fundamental signal for radiated spurious emission test under different RB size/offset and modulations in exploratory test. Subsequently, only the worst case emissions are reported.																	



Test Items	Band	Bandwidth (MHz)										Modulation				RB #			Test Channel		
		20+20	20+15	15+20	20+10	10+20	20+5	5+20	15+15	15+10	10+15	QPSK	16QAM	64QAM	256QAM	1	Half	Full	L	M	H
Max. Output Power	7C_CA	v	v	v	v	v	-	-	v	v	-	v	v	v	-	v			v	v	v
	38C_CA	v	-	-	-	-	-	-	v	-	-	v	v	v	-	v			v	v	v
	41C_CA	v	v	v	v	v	v	v	v	v	v	v	v	v	-	v			v	v	v
26dB and 99% Bandwidth	7C_CA	v	v	v	v	v	-	-	v	v	-	v	v		-			v			v
	41C_CA	v	v	v	v	v	v	v	v	v	v	v	v		-			v			v
Conducted Band Edge	7C_CA	v	v	v	v	v	-	-	v	v	-	v	v	v	-	v		v	v		v
	41C_CA	v	v	v	v	v	v	v	v	v	v	v	v	v	-	v		v	v		v
Conducted Spurious Emission	7C_CA	v	v	v	v	v	-	-	v	v	-	v			-	v			v	v	v
	41C_CA	v	v	v	v	v	v	v	v	v	v	v			-	v			v	v	v
Frequency Stability	7C_CA	v					-	-			-	v			-	v					v
	41C_CA	v										v			-	v					v
E.I.R.P.	7C_CA	v	v	v	v	v	-	-	v	v	-	v	v	v	-	v			v	v	v
	38C_CA	v	-	-	-	-	-	-	v	-	-	v	v	v	-	v			v	v	v
	41C_CA	v	v	v	v	v	v	v	v	v	v	v	v	v	-	v			v	v	v
Radiated Spurious Emission	7C_CA	Worst Case																			v
	41C_CA	Worst Case																			v
Note	1. The mark "v" means that this configuration is chosen for testing 2. The mark "-" means that this bandwidth is not supported. 3. The device is investigated from 30MHz to 10 times of fundamental signal for radiated spurious emission test under different RB size/offset and modulations in exploratory test. Subsequently, only the worst case emissions are reported.																				

2.2 Connection Diagram of Test System

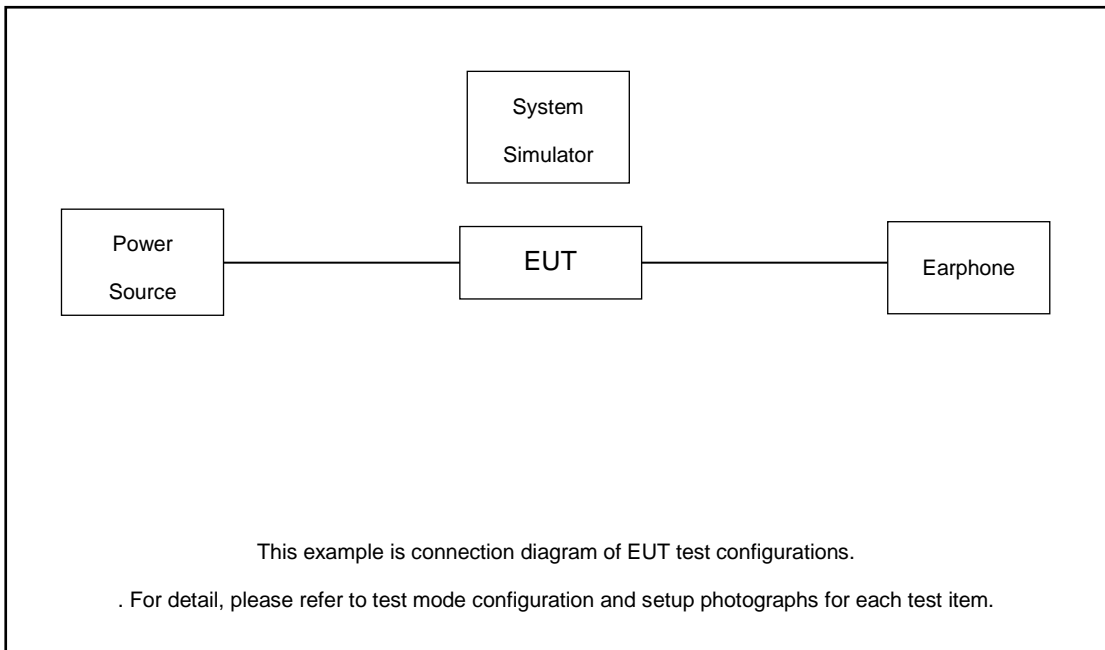

2.3 Support Unit used in test configuration and system

Item	Equipment	Trade Name	Model No.	FCC ID	Data Cable	Power Cord
1.	Power Supply	GWINSTEK	PSS-2002	N/A	N/A	Unshielded, 1.8 m
2.	LTE Base Station	Anritsu	MT8820/8821	N/A	N/A	Unshielded, 1.8 m
3.	Earphone	N/A	N/A	N/A	N/A	N/A

2.4 Measurement Results Explanation Example

For all conducted test items:

The offset level is set in the spectrum analyzer to compensate the RF cable loss between EUT conducted output port and spectrum analyzer. With the offset compensation, the spectrum analyzer reading level is exactly the EUT RF output level.

The spectrum analyzer offset is derived from RF cable loss.

$$\text{Offset} = \text{RF cable loss.}$$

Following shows an offset computation example with cable loss 6.0 dB.

Example :

$$\begin{aligned} \text{Offset(dB)} &= \text{RF cable loss(dB)}. \\ &= 6.0 \text{ (dB)} \end{aligned}$$



2.5 Frequency List of Low/Middle/High Channels

LTE Band 7 Channel and Frequency List				
BW [MHz]	Channel/Frequency(MHz)	Lowest	Middle	Highest
20	Channel	20850	21100	21350
	Frequency	2510	2535	2560
15	Channel	20825	21100	21375
	Frequency	2507.5	2535	2562.5
10	Channel	20800	21100	21400
	Frequency	2505	2535	2565
5	Channel	20775	21100	21425
	Frequency	2502.5	2535	2567.5

LTE Band 12 Channel and Frequency List				
BW [MHz]	Channel/Frequency(MHz)	Lowest	Middle	Highest
10	Channel	23060	23095	23130
	Frequency	704	707.5	711
5	Channel	23035	23095	23155
	Frequency	701.5	707.5	713.5
3	Channel	23025	23095	23165
	Frequency	700.5	707.5	714.5
1.4	Channel	23017	23095	23173
	Frequency	699.7	707.5	715.3

LTE Band 13 Channel and Frequency List				
BW [MHz]	Channel/Frequency(MHz)	Lowest	Middle	Highest
10	Channel	-	23230	-
	Frequency	-	782	-
5	Channel	23205	23230	23255
	Frequency	779.5	782	784.5

LTE Band 17 Channel and Frequency List				
BW [MHz]	Channel/Frequency(MHz)	Lowest	Middle	Highest
10	Channel	23780	23790	23800
	Frequency	709	710	711
5	Channel	23755	23790	23825
	Frequency	706.5	710	713.5



LTE Band 38 Channel and Frequency List				
BW [MHz]	Channel/Frequency(MHz)	Lowest	Middle	Highest
20	Channel	37850	38000	38150
	Frequency	2580	2595	2610
15	Channel	37825	38000	38175
	Frequency	2577.5	2595	2612.5
10	Channel	37800	38000	38200
	Frequency	2575	2595	2615
5	Channel	37775	38000	38225
	Frequency	2572.5	2595	2617.5

LTE Band 41 Channel and Frequency List				
BW [MHz]	Channel/Frequency(MHz)	Lowest	Middle	Highest
20	Channel	39750	40620	41490
	Frequency	2506	2593	2680
15	Channel	39725	40620	41515
	Frequency	2503.5	2593	2682.5
10	Channel	39700	40620	41540
	Frequency	2501	2593	2685
5	Channel	39675	40620	41565
	Frequency	2498.5	2593	2687.5



LTE Band 7C_CA Channel and Frequency List					
BW [MHz]	Channel/Frequency(MHz)		Lowest	Middle	Highest
20 + 20	PCC	Channel	20850	21001	21152
		Frequency	2510.0	2525.1	2540.2
	SCC	Channel	21048	21199	21350
		Frequency	2529.8	2544.9	2560.0
20 + 15	PCC	Channel	20850	21026	21201
		Frequency	2510.0	2527.6	2545.1
	SCC	Channel	21021	21197	21372
		Frequency	2527.1	2544.7	2562.2
15 + 20	PCC	Channel	20828	21003	21179
		Frequency	2507.8	2525.3	2542.9
	SCC	Channel	20999	21174	21350
		Frequency	2524.9	2542.4	2560.0
20 + 10	PCC	Channel	20850	21051	21251
		Frequency	2510.0	2530.1	2550.1
	SCC	Channel	20994	21195	21395
		Frequency	2524.4	2544.5	2564.5
10 + 20	PCC	Channel	20805	21006	21206
		Frequency	2505.5	2525.6	2545.6
	SCC	Channel	20949	21150	21350
		Frequency	2519.9	2540.0	2560.0
15 + 15	PCC	Channel	20825	21025	21225
		Frequency	2507.5	2527.5	2547.5
	SCC	Channel	20975	21175	21375
		Frequency	2522.5	2542.5	2562.5
15 + 10	PCC	Channel	20825	21051	21277
		Frequency	2507.5	2530.1	2552.7
	SCC	Channel	20945	21171	21397
		Frequency	2519.5	2542.1	2564.7



LTE Band 38C_CA Channel and Frequency List					
BW [MHz]	Channel/Frequency(MHz)		Lowest	Middle	Highest
20 + 20	PCC	Channel	37850	37901	37952
		Frequency	2580.0	2585.1	2590.2
	SCC	Channel	38048	38099	38150
		Frequency	2599.8	2604.9	2610.0
15+ 15	PCC	Channel	37825	37925	38025
		Frequency	2577.5	2587.5	2597.5
	SCC	Channel	37975	38075	38175
		Frequency	2592.5	2602.5	2612.5

LTE Band 41C_CA Channel and Frequency List					
BW [MHz]	Channel/Frequency(MHz)		Lowest	Middle	Highest
20 + 20	PCC	Channel	39750	40521	41292
		Frequency	2506.0	2583.1	2660.2
	SCC	Channel	39948	40719	41490
		Frequency	2525.8	2602.9	2680.0
20 + 15	PCC	Channel	39750	40546	41341
		Frequency	2506.0	2585.6	2665.1
	SCC	Channel	39921	40717	41512
		Frequency	2523.1	2602.7	2682.2
15 + 20	PCC	Channel	39728	40523	41319
		Frequency	2503.8	2593.3	2662.9
	SCC	Channel	39899	40694	41490
		Frequency	2520.9	2600.4	2680.0
20 + 10	PCC	Channel	39750	40571	41391
		Frequency	2506.0	2588.1	2670.1
	SCC	Channel	39894	40715	41535
		Frequency	2520.4	2602.5	2684.5
10 + 20	PCC	Channel	39705	40526	41346
		Frequency	2501.5	2583.6	2665.6
	SCC	Channel	39849	40670	41490
		Frequency	2515.9	2598.0	2680.0



LTE Band 41C_CA Channel and Frequency List					
20 + 5	PCC	Channel	39750	40595	41440
		Frequency	2506.0	2590.5	2675.0
	SCC	Channel	39867	40712	41557
		Frequency	2517.7	2602.2	2686.7
5 + 20	PCC	Channel	39683	40528	41373
		Frequency	2499.3	2583.8	2668.3
	SCC	Channel	39800	40645	41490
		Frequency	2511.0	2595.5	2680.0
15 + 15	PCC	Channel	39725	40545	41365
		Frequency	2503.5	2585.5	2667.5
	SCC	Channel	39875	40695	41515
		Frequency	2518.5	2600.5	2682.5
10 + 15	PCC	Channel	39703	40549	41395
		Frequency	2501.3	2585.9	2670.5
	SCC	Channel	39823	40669	41515
		Frequency	2513.3	2597.9	2682.5
15 + 10	PCC	Channel	39725	40571	41417
		Frequency	2503.5	2588.1	2672.7
	SCC	Channel	39845	40691	41537
		Frequency	2515.5	2600.1	2684.7

3 Conducted Test Items

3.1 Measuring Instruments

See list of measuring instruments of this test report.

3.2 Test Setup

3.2.1 Conducted Output Power



3.2.2 Peak-to-Average Ratio, Occupied Bandwidth, Conducted Band-Edge and Conducted Spurious Emission



3.2.3 Frequency Stability

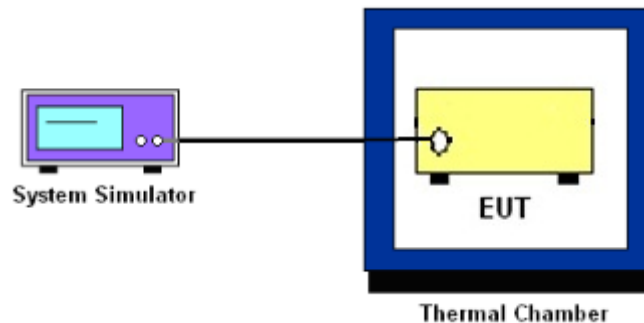

3.3 Test Result of Conducted Test

Please refer to Appendix A.



3.4 Conducted Output Power and ERP/EIRP

3.4.1 Description of the Conducted Output Power Measurement and ERP/EIRP Measurement

A system simulator was used to establish communication with the EUT. Its parameters were set to force the EUT transmitting at maximum output power. The measured power in the radio frequency on the transmitter output terminals shall be reported.

The ERP of mobile transmitters must not exceed 3 Watts for LTE Band 12, Band 13 and Band 17.

The EIRP of mobile transmitters must not exceed 2 Watts for LTE Band 7 and Band 38 and Band 41.

According to KDB 412172 D01 Power Approach,

$EIRP = P_T + G_T - L_C$, $ERP = EIRP - 2.15$, where

P_T = transmitter output power in dBm

G_T = gain of the transmitting antenna in dBi

L_C = signal attenuation in the connecting cable between the transmitter and antenna in dB

3.4.2 Test Procedures

1. The testing follows ANSI C63.26 Section 5.2
2. The transmitter output port was connected to the system simulator.
3. Set EUT at maximum power through the system simulator.
4. Select lowest, middle, and highest channels for each band and different modulation.
5. Measure and record the power level from the system simulator.



3.5 Peak-to-Average Ratio

3.5.1 Description of the PAR Measurement

Power Complementary Cumulative Distribution Function (CCDF) curves provide a means for characterizing the power peaks of a digitally modulated signal on a statistical basis. A CCDF curve depicts the probability of the peak signal amplitude exceeding the average power level. Most contemporary measurement instrumentation include the capability to produce CCDF curves for an input signal provided that the instrument's resolution bandwidth can be set wide enough to accommodate the entire input signal bandwidth. In measuring transmissions in this band using an average power technique, the peak-to-average ratio (PAR) of the transmission may not exceed 13 dB.

3.5.2 Test Procedures

1. The testing follows ANSI C63.26 Section 5.2.3.4 (CCDF).
2. The EUT was connected to spectrum and system simulator via a power divider.
3. Set the CCDF (Complementary Cumulative Distribution Function) option in spectrum analyzer.
4. The highest RF powers were measured and recorded the maximum PAPR level associated with a probability of 0.1 %.
5. Record the deviation as Peak to Average Ratio.



3.6 Occupied Bandwidth

3.6.1 Description of Occupied Bandwidth Measurement

The occupied bandwidth is the width of a frequency band such that, below the lower and above the upper frequency limits, the mean powers emitted are each equal to a specified percentage 0.5% of the total mean transmitted power.

The 26 dB emission bandwidth is defined as the frequency range between two points, one above and one below the carrier frequency, at which the spectral density of the emission is attenuated 26 dB below the maximum in-band spectral density of the modulated signal. Spectral density (power per unit bandwidth) is to be measured with a detector of resolution bandwidth equal to approximately 1.0% of the emission bandwidth.

3.6.2 Test Procedures

1. The testing follows ANSI C63.26 Section 5.4
2. The EUT was connected to spectrum analyzer and system simulator via a power divider.
3. The spectrum analyzer center frequency is set to the nominal EUT channel center frequency. The span range for the spectrum analyzer shall be between two and five times the anticipated OBW.
4. The nominal resolution bandwidth (RBW) shall be in the range of 1 to 5 % of the anticipated OBW, and the VBW shall be at least 3 times the RBW.
5. Set the detection mode to peak, and the trace mode to max hold.
6. Determine the reference value: Set the EUT to transmit a modulated signal. Allow the trace to stabilize. Set the spectrum analyzer marker to the highest level of the displayed trace.
(this is the reference value)
7. Determine the “-26 dB down amplitude” as equal to (Reference Value – X).
8. Place two markers, one at the lowest and the other at the highest frequency of the envelope of the spectral display such that each marker is at or slightly below the “-X dB down amplitude” determined in step 6. If a marker is below this “-X dB down amplitude” value it shall be placed as close as possible to this value. The OBW is the positive frequency difference between the two markers.
9. Use the 99 % power bandwidth function of the spectrum analyzer and report the measured bandwidth.



3.7 Conducted Band Edge

3.7.1 Description of Conducted Band Edge Measurement

27.53 (c)

For operations in the 776-788 MHz band, the FCC limit is $43 + 10\log_{10}(P[\text{Watts}])$ dB below the transmitter power P(Watts) in a 100 kHz bandwidth. However, in the 100 kHz bands immediately outside and adjacent to the frequency block, a resolution bandwidth of at least 30 kHz may be employed. In addition, the power of any unwanted emissions in any 6.25 kHz bandwidth for all frequencies between 763-775 MHz and 793-806 MHz shall be attenuated below the transmitter power, P (dBW), by at least $65 + 10 \log_{10} p(\text{watts})$, dB, for mobile and portable equipment.

27.53 (g)

For operations in the 600MHz band and 698 -746 MHz band, the FCC limit is $43 + 10\log_{10}(P[\text{Watts}])$ dB below the transmitter power P(Watts) in a 100 kHz bandwidth. However, in the 100 kilohertz bands immediately outside and adjacent to a licensee's frequency block, a resolution bandwidth of at least 30 kHz may be employed.

27.53(m)(4)

For mobile digital stations, the attenuation factor shall be not less than $40 + 10 \log (P)$ dB on all frequencies between the channel edge and 5 megahertz from the channel edge, $43 + 10 \log (P)$ dB on all frequencies between 5 megahertz and X megahertz from the channel edge, and $55 + 10 \log (P)$ dB on all frequencies more than X megahertz from the channel edge, where X is the greater of 6 megahertz or the actual emission bandwidth as defined in paragraph (m)(6) of this section. In addition, the attenuation factor shall not be less that $43 + 10 \log (P)$ dB on all frequencies between 2490.5 MHz and 2496 MHz and $55 + 10 \log (P)$ dB at or below 2490.5 MHz. Mobile Satellite Service licensees operating on frequencies below 2495 MHz may also submit a documented interference complaint against BRS licensees operating on channel BRS Channel 1 on the same terms and conditions as adjacent channel BRS or EBS licensees.



3.7.2 Test Procedures

1. The testing follows ANSI C63.26 section 5.7
2. The EUT was connected to spectrum analyzer and system simulator via a power divider.
3. The band edges of low and high channels for the highest RF powers were measured.
4. Set RBW \geq 1% EBW in the 1MHz band immediately outside and adjacent to the band edge.
5. Beyond the 1 MHz band from the band edge, RBW=1MHz was used.
6. Set spectrum analyzer with RMS detector.
7. The RF fundamental frequency should be excluded against the limit line in the operating frequency band.
8. Checked that all the results comply with the emission limit line.

Example:

The limit line is derived from $43 + 10\log(P)$ dB below the transmitter power P(Watts)
= P(W)- [43 + 10log(P)] (dB)
= [30 + 10log(P)] (dBm) - [43 + 10log(P)] (dB) = -13dBm.

9. For LTE Band 7, 38, 41, the other 40 dB, and 55 dB have additionally applied same calculation above.
10. When using the integration method, the starting frequency of the integration shall be centered at one-half of the RBW away from the band edge.



3.8 Conducted Spurious Emission

3.8.1 Description of Conducted Spurious Emission Measurement

The power of any emission outside of the authorized operating frequency ranges must be lower than the transmitter power (P) by a factor of at least $43 + 10 \log (P)$ dB.

For Band 7,38,41:

The power of any emission outside of the authorized operating frequency ranges must be lower than the transmitter power (P) by a factor of at least $55 + 10 \log (P)$ dB.

It is measured by means of a calibrated spectrum analyzer and scanned from 30 MHz up to a frequency including its 10th harmonic.

3.8.2 Test Procedures

11. The testing follows ANSI C63.26 section 5.7
12. The EUT was connected to spectrum analyzer and system simulator via a power divider.
13. The RF output of EUT was connected to the spectrum analyzer by RF cable and attenuator. The path loss was compensated to the results for each measurement.
14. The middle channel for the highest RF power within the transmitting frequency was measured.
15. The conducted spurious emission for the whole frequency range was taken.
16. Make the measurement with the spectrum analyzer's RBW = 1MHz, VBW = 3MHz.
17. Set spectrum analyzer with RMS detector.
18. Taking the record of maximum spurious emission.
19. The RF fundamental frequency should be excluded against the limit line in the operating frequency band.
20. The limit line is derived from $43 + 10\log(P)$ dB below the transmitter power P(Watts)
= $P(W) - [43 + 10\log(P)]$ (dB)
= $[30 + 10\log(P)]$ (dBm) - $[43 + 10\log(P)]$ (dB)
= -13dBm.
21. For Band 7, 38, 41
The limit line is derived from $55 + 10\log(P)$ dB below the transmitter power P(Watts)
= $P(W) - [55 + 10\log(P)]$ (dB)
= $[30 + 10\log(P)]$ (dBm) - $[55 + 10\log(P)]$ (dB)
= -25dBm.



3.9 Frequency Stability

3.9.1 Description of Frequency Stability Measurement

The frequency stability shall be measured by variation of ambient temperature and variation of primary supply voltage to ensure that the fundamental emission stays within the authorized frequency block. The frequency stability of the transmitter shall be maintained within $\pm 0.00025\%$ ($\pm 2.5\text{ppm}$) of the center frequency.

3.9.2 Test Procedures for Temperature Variation

22. The testing follows ANSI C63.26 section 5.6.4
23. The EUT was set up in the thermal chamber and connected with the system simulator.
24. With power OFF, the temperature was decreased to -30°C and the EUT was stabilized before testing. Power was applied and the maximum change in frequency was recorded within one minute.
25. With power OFF, the temperature was raised in 10°C step up to 50°C . The EUT was stabilized at each step for at least half an hour. Power was applied and the maximum frequency change was recorded within one minute.

3.9.3 Test Procedures for Voltage Variation

26. The testing follows ANSI C63.26 section 5.6.5
27. The EUT was placed in a temperature chamber at $20\pm 5^{\circ}\text{C}$ and connected with the system simulator.
28. The power supply voltage to the EUT was varied from 85% to 115% of the nominal value for other than hand carried battery equipment.
29. For hand carried, battery powered equipment, reduce the primary ac or dc supply voltage to the battery operating end point, which shall be specified by the manufacturer.
30. The variation in frequency was measured for the worst case.

4 Radiated Test Items

4.1 Measuring Instruments

See list of measuring instruments of this test report.

4.2 Test Setup

4.2.1 For radiated test below 30MHz

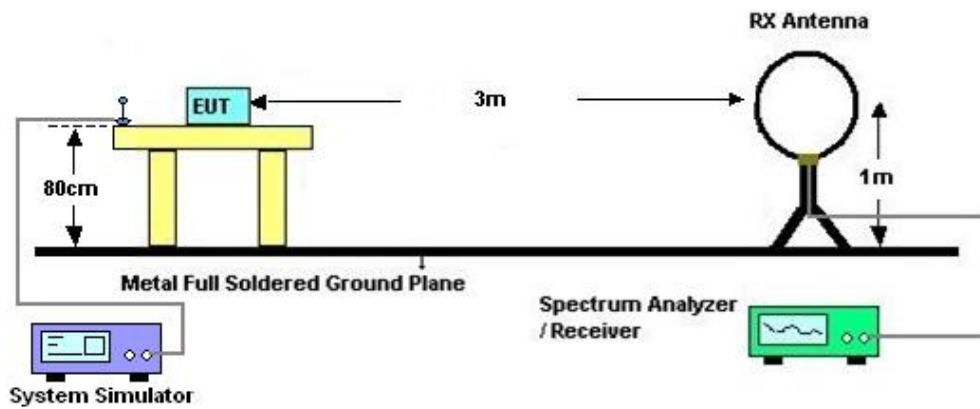

4.2.2 For radiated test from 30MHz to 1GHz

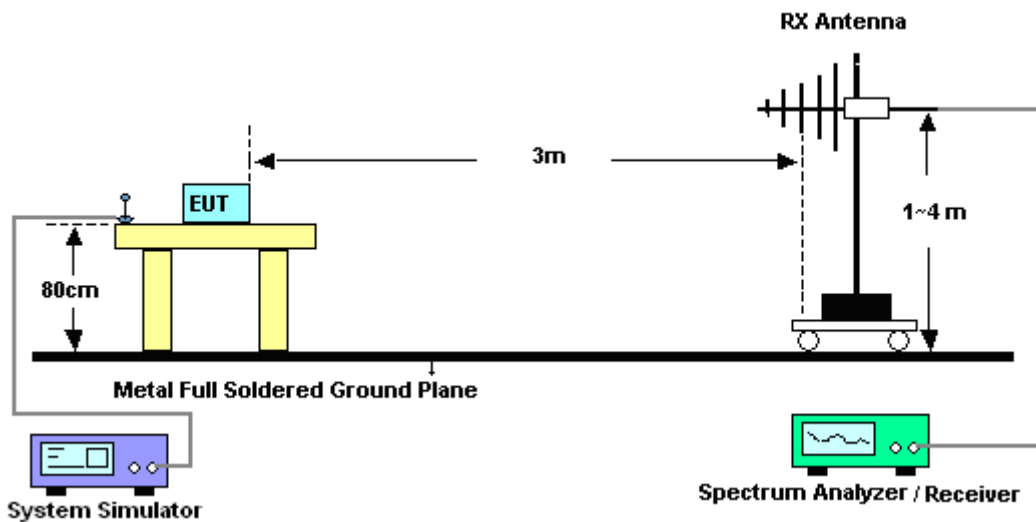

4.2.3 For radiated test above 1GHz

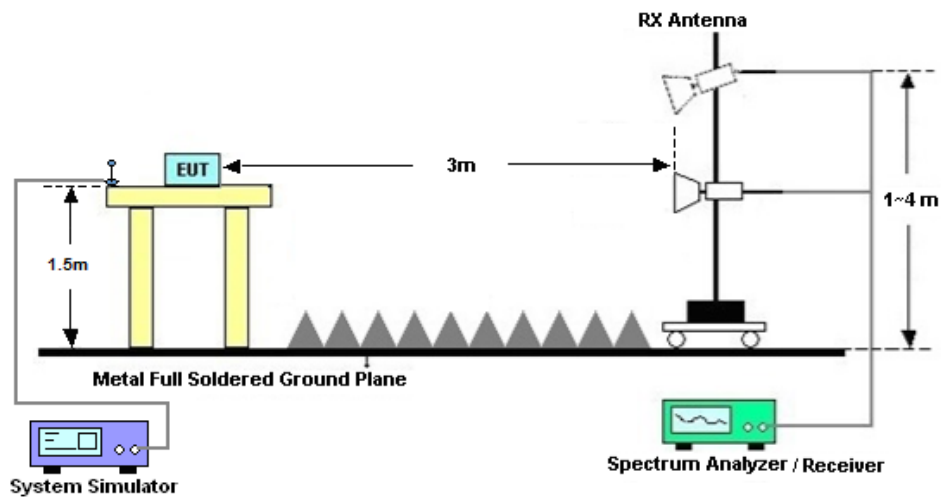

4.3 Test Result of Radiated Test

The low frequency, which started from 9 kHz to 30MHz, was pre-scanned and the result which was 20dB lower than the limit line was not reported.

Please refer to Appendix B.



4.4 Radiated Spurious Emission

4.4.1 Description of Radiated Spurious Emission

The radiated spurious emission was measured by substitution method according to ANSI C63.26. The power of any emission outside of the authorized operating frequency ranges must be attenuated below the transmitter power (P) by a factor of at least $43 + 10 \log (P)$ dB.

For Band 7, 38, 41

The power of any emission outside of the authorized operating frequency ranges must be attenuated below the transmitter power (P) by a factor of at least $55 + 10 \log (P)$ dB.

For LTE Band 13

For operations in the 746-758 MHz, 775-788 MHz, and 805-806 MHz bands, emissions in the band 1559-1610 MHz shall be limited to -70 dBW/MHz equivalent isotropically radiated power (EIRP) for wideband signals, and -80 dBW EIRP for discrete emissions of less than 700 Hz bandwidth.

The spectrum is scanned from 30 MHz up to a frequency including its 10th harmonic.

4.4.2 Test Procedures

31. The testing follows ANSI C63.26 Section 5.5
32. The EUT was placed on a turntable with 0.8 meter height for frequency below 1GHz and 1.5 meter height for frequency above 1GHz respectively above ground.
33. The EUT was set 3 meters from the receiving antenna mounted on the antenna tower.
34. The table was rotated 360 degrees to determine the position of the highest spurious emission.
35. The height of the receiving antenna is varied between 1m to 4m to search the maximum spurious emission for both horizontal and vertical polarizations.
36. During the measurement, the system simulator parameters were set to force the EUT transmitting at maximum output power.
37. Make the measurement with the spectrum analyzer's RBW = 1MHz, VBW = 3MHz, taking the record of maximum spurious emission.
38. A horn antenna was substituted in place of the EUT and was driven by a signal generator.
39. Tune the output power of signal generator to the same emission level with EUT maximum spurious emission.
40. $EIRP (dBm) = S.G. Power - Tx Cable Loss + Tx Antenna Gain$
41. $ERP (dBm) = EIRP - 2.15$
42. The RF fundamental frequency should be excluded against the limit line in the operating frequency band.
The limit line is derived from $43 + 10\log(P)$ dB below the transmitter power P(Watts)
 $= P(W) - [43 + 10\log(P)] (dB)$
 $= [30 + 10\log(P)] (dBm) - [43 + 10\log(P)] (dB)$
 $= -13dBm.$
43. For Band 7, 38, 41:
The limit line is derived from $55 + 10\log(P)$ dB below the transmitter power P(Watts)



5 List of Measuring Equipment

Instrument	Manufacturer	Model No.	Serial No.	Characteristics	Calibration Date	Test Date	Due Date	Remark
Spectrum Analyzer	R&S	FSV40	101040	10Hz~40GHz	Oct. 12, 2022	Jun. 25, 2023~ Jun. 29, 2023	Oct. 11, 2023	Conducted (TH01-KS)
Power divider	STI	STI08-0055	-	0.5~40GHz	Aug. 25, 2022	Jun. 25, 2023~ Jun. 29, 2023	Aug. 24, 2023	Conducted (TH01-KS)
Temperature & humidity chamber	Hongzhan	LP-150U	H2014011440	-40~+150°C 20%~95%RH	Jul. 15, 2022	Jun. 25, 2023~ Jun. 29, 2023	Jul. 14, 2023	Conducted (TH01-KS)
EXA Spectrum Analyzer	Keysight	N9010B	MY57471079	10Hz-44G,MAX 30dB	Oct. 12, 2022	Jun. 25, 2023	Oct. 11, 2023	Radiation (03CH04-KS)
Loop Antenna	R&S	HFH2-Z2	100321	9kHz~30MHz	Oct. 29, 2022	Jun. 25, 2023	Oct. 28, 2023	Radiation (03CH04-KS)
Bilog Antenna	TeseQ	CBL6111D	49922	30MHz-1GHz	Apr. 09, 2023	Jun. 25, 2023	Apr. 08, 2024	Radiation (03CH04-KS)
Horn Antenna	Schwarzbeck	BBHA9120D	1284	1GHz~18GHz	Oct. 16, 2022	Jun. 25, 2023	Oct. 15, 2023	Radiation (03CH04-KS)
SHF-EHF Horn	Com-power	AH-840	101070	18GHz~40GHz	Jan. 08, 2023	Jun. 25, 2023	Jan. 07, 2024	Radiation (03CH04-KS)
Amplifier	SONOMA	310N	187289	9KHz-1GHz	Jul. 11, 2022	Jun. 25, 2023	Jul. 10, 2023	Radiation (03CH04-KS)
Amplifier	MITEQ	EM18G40G GA	060728	18~40GHz	Jan. 05, 2023	Jun. 25, 2023	Jan. 04, 2024	Radiation (03CH04-KS)
high gain Amplifier	EM	EM01G18G A	060840	1Ghz-18Ghz	Oct. 12, 2022	Jun. 25, 2023	Oct. 11, 2023	Radiation (03CH04-KS)
Amplifier	Agilent	8449B	3008A02370	1Ghz-18Ghz	Oct. 12, 2022	Jun. 25, 2023	Oct. 11, 2023	Radiation (03CH04-KS)
AC Power Source	Chroma	61601	F104090004	N/A	NCR	Jun. 25, 2023	NCR	Radiation (03CH04-KS)
Turn Table	ChamPro	EM 1000-T	060762-T	0~360 degree	NCR	Jun. 25, 2023	NCR	Radiation (03CH04-KS)
Antenna Mast	ChamPro	EM 1000-A	060762-A	1 m~4 m	NCR	Jun. 25, 2023	NCR	Radiation (03CH04-KS)

NCR: No Calibration Required



6 Measurement Uncertainty

The measurement uncertainties shown below were calculated in accordance with the requirements of ANSI 63.26-2015. All the measurement uncertainty value were shown with a coverage K=2 to indicate 95% level of confidence. The measurement data show herein meets or exceeds the CISPR measurement uncertainty values specified in CISPR 16-4-2 and can be compared directly to specified limit to determine compliance.

Uncertainty of Conducted Measurement

Test Item	Uncertainty
Conducted Power	±0.46 dB
Conducted Emissions	±2.26 dB
Occupied Channel Bandwidth	±0.1 %

Uncertainty of Radiated Emission Measurement (30 MHz ~ 1000 MHz)

Measuring Uncertainty for a Level of Confidence of 95% (U = 2Uc(y))	3.82dB
---------------------------------------------------------------------	--------

Uncertainty of Radiated Emission Measurement (1 GHz ~ 18 GHz)

Measuring Uncertainty for a Level of Confidence of 95% (U = 2Uc(y))	3.56dB
---------------------------------------------------------------------	--------

Uncertainty of Radiated Emission Measurement (18 GHz ~ 40 GHz)

Measuring Uncertainty for a Level of Confidence of 95% (U = 2Uc(y))	3.54dB
---------------------------------------------------------------------	--------

----- THE END -----



Appendix A. Test Results of Conducted Test

Test Engineer :	Lex Wu	Temperature :	22~23°C
		Relative Humidity :	40~42%

Conducted Output Power(Average power) and ERP/EIRP

LTE Band 7_Ant.1:

BW [MHz]	Modulation	RB Size	RB Offset	Power Low Ch. / Freq.	Power Middle Ch. / Freq.	Power High Ch. / Freq.	EIRP(W)		
Channel				20850	20850	21350	EIRP(W)		
Frequency (MHz)				2510	2535	2560	L	M	H
20	QPSK	1	0	22.93	23.04	22.97	0.0818	0.0839	0.0826
20	QPSK	1	99	22.76	22.91	22.77	0.0787	0.0815	0.0789
20	QPSK	100	0	21.86	21.96	21.90	0.0640	0.0655	0.0646
20	16QAM	1	0	21.99	22.07	21.98	0.0659	0.0671	0.0658
20	64QAM	1	0	20.98	21.03	20.93	0.0522	0.0528	0.0516
Channel				20825	21100	21375	EIRP(W)		
Frequency (MHz)				2507.5	2535	2562.5	L	M	H
15	QPSK	1	0	22.82	22.93	22.89	0.0798	0.0818	0.0811
15	16QAM	1	0	21.95	21.99	21.89	0.0653	0.0659	0.0644
Channel				20800	21100	21400	EIRP(W)		
Frequency (MHz)				2505	2535	2565	L	M	H
10	QPSK	1	0	22.81	22.94	22.92	0.0796	0.0820	0.0817
10	16QAM	1	0	21.92	22.01	21.92	0.0649	0.0662	0.0649
Channel				20775	21100	21425	EIRP(W)		
Frequency (MHz)				2502.5	2535	2567.5	L	M	H
5	QPSK	1	0	22.85	22.96	22.93	0.0804	0.0824	0.0818
5	16QAM	1	0	21.94	21.97	21.89	0.0652	0.0656	0.0644



LTE Band 12_Ant.0:

BW [MHz]	Modulation	RB Size	RB Offset	Power Low Ch. / Freq.	Power Middle Ch. / Freq.	Power High Ch. / Freq.	ERP(W)		
Channel				23060	23095	23130	ERP(W)		
Frequency (MHz)				704	707.5	711	L	M	H
10	QPSK	1	0	22.59	22.68	22.64	0.0483	0.0493	0.0489
10	QPSK	1	49	22.40	22.55	22.48	0.0462	0.0479	0.0471
10	QPSK	50	0	21.55	21.59	21.49	0.0380	0.0384	0.0375
10	16QAM	1	0	21.47	21.52	21.47	0.0373	0.0378	0.0373
10	64QAM	1	0	20.56	20.67	20.55	0.0303	0.0310	0.0302
Channel				23035	23095	23155	ERP(W)		
Frequency (MHz)				701.5	707.5	713.5	L	M	H
5	QPSK	1	0	22.55	22.62	22.57	0.0479	0.0486	0.0481
5	16QAM	1	0	21.36	21.44	21.38	0.0364	0.0371	0.0366
Channel				23025	23095	23165	ERP(W)		
Frequency (MHz)				700.5	707.5	714.5	L	M	H
3	QPSK	1	0	22.48	22.56	22.52	0.0471	0.0480	0.0475
3	16QAM	1	0	21.38	21.45	21.35	0.0366	0.0372	0.0363
Channel				23017	23095	23173	ERP(W)		
Frequency (MHz)				699.7	707.5	715.3	L	M	H
1.4	QPSK	1	0	22.55	22.64	22.57	0.0479	0.0489	0.0481
1.4	16QAM	1	0	21.41	21.50	21.35	0.0368	0.0376	0.0363

LTE Band 13_Ant.0:

BW [MHz]	Modulation	RB Size	RB Offset	Power Low Ch. / Freq.	Power Middle Ch. / Freq.	Power High Ch. / Freq.	ERP(W)		
Channel				23230			ERP(W)		
Frequency (MHz)				782				M	
10	QPSK	1	0		22.73			0.0396	
10	QPSK	1	49		22.64			0.0388	
10	QPSK	50	0		21.62			0.0307	
10	16QAM	1	0		21.56			0.0303	
10	64QAM	1	0		20.67			0.0247	
Channel				23205	23230	23255	ERP(W)		
Frequency (MHz)				779.5	782	784.5	L	M	H
5	QPSK	1	0	22.61	22.69	22.55	0.0385	0.0393	0.0380
5	16QAM	1	0	21.38	21.49	21.40	0.0290	0.0298	0.0292



LTE Band 17_Ant.0:

BW [MHz]	Modulation	RB Size	RB Offset	Power Low Ch. / Freq.	Power Middle Ch. / Freq.	Power High Ch. / Freq.	ERP(W)		
Channel				23780	23790	23800			
Frequency (MHz)				709	710	711	L	M	H
10	QPSK	1	0	22.51	22.62	22.58	0.0474	0.0486	0.0482
10	QPSK	1	49	22.36	22.50	22.43	0.0458	0.0473	0.0466
10	QPSK	50	0	21.42	21.52	21.36	0.0369	0.0378	0.0364
10	16QAM	1	0	21.43	21.41	21.41	0.0370	0.0368	0.0368
10	64QAM	1	0	20.44	20.57	20.41	0.0294	0.0303	0.0292
Channel				23755	23790	23825	ERP(W)		
Frequency (MHz)				706.5	710	713.5	L	M	H
5	QPSK	1	0	22.47	22.54	22.50	0.0470	0.0478	0.0473
5	16QAM	1	0	21.31	21.29	21.30	0.0360	0.0358	0.0359

LTE Band 38_Ant.1:

BW [MHz]	Modulation	RB Size	RB Offset	Power Low Ch. / Freq.	Power Middle Ch. / Freq.	Power High Ch. / Freq.	EIRP(W)		
Channel				37850	38000	38150			
Frequency (MHz)				2580	2595	2610	L	M	H
20	QPSK	1	0	22.78	22.88	22.81	0.0721	0.0738	0.0726
20	QPSK	1	99	22.69	22.75	22.63	0.0706	0.0716	0.0697
20	QPSK	100	0	21.63	21.75	21.69	0.0553	0.0569	0.0561
20	16QAM	1	0	21.78	21.85	21.84	0.0573	0.0582	0.0581
20	64QAM	1	0	20.80	20.87	20.68	0.0457	0.0465	0.0445
Channel				37825	38000	38175	EIRP(W)		
Frequency (MHz)				2577.5	2595	2612.5	L	M	H
15	QPSK	1	0	22.69	22.84	22.73	0.0706	0.0731	0.0713
15	16QAM	1	0	21.75	21.79	21.73	0.0569	0.0574	0.0566
Channel				37800	38000	38200	EIRP(W)		
Frequency (MHz)				2575	2595	2615	L	M	H
10	QPSK	1	0	22.66	22.81	22.70	0.0701	0.0726	0.0708
10	16QAM	1	0	21.63	21.81	21.80	0.0553	0.0577	0.0575
Channel				37775	38000	38225	EIRP(W)		
Frequency (MHz)				2572.5	2595	2617.5	L	M	H
5	QPSK	1	0	22.72	22.84	22.74	0.0711	0.0731	0.0714
5	16QAM	1	0	21.70	21.74	21.71	0.0562	0.0568	0.0564



LTE Band 41_Ant.1:

BW [MHz]	Modulation	RB Size	RB Offset	Power Low Ch. / Freq.	Power Middle Ch. / Freq.	Power High Ch. / Freq.	EIRP(W)		
Channel				39750	40620	41490	EIRP(W)		
Frequency (MHz)				2506	2593	2680	L	M	H
20	QPSK	1	0	22.93	22.97	22.79	0.0764	0.0771	0.0740
20	QPSK	1	99	22.71	22.83	22.66	0.0726	0.0746	0.0718
20	QPSK	100	0	21.87	21.91	21.73	0.0598	0.0604	0.0579
20	16QAM	1	0	21.93	21.97	21.82	0.0607	0.0612	0.0592
20	64QAM	1	0	20.79	20.92	20.73	0.0467	0.0481	0.0460
Channel				39725	40620	41515	EIRP(W)		
Frequency (MHz)				2503.5	2593	2682.5	L	M	H
15	QPSK	1	0	22.85	22.93	22.65	0.0750	0.0764	0.0716
15	16QAM	1	0	21.81	21.83	21.75	0.0590	0.0593	0.0582
Channel				39700	40620	41540	EIRP(W)		
Frequency (MHz)				2501	2593	2685	L	M	H
10	QPSK	1	0	22.85	22.88	22.70	0.0750	0.0755	0.0724
10	16QAM	1	0	21.88	21.82	21.69	0.0600	0.0592	0.0574
Channel				39675	40620	41565	EIRP(W)		
Frequency (MHz)				2498.5	2593	2687.5	L	M	H
5	QPSK	1	0	22.79	22.91	22.71	0.0740	0.0760	0.0726
5	16QAM	1	0	21.84	21.90	21.72	0.0594	0.0603	0.0578



LTE Band 7C_CA_Ant.1:

Combination 20MHz+20MHz (100RB+100RB)							
Channel	Modulation	PCC		SCC		Measured Power	EIRP(W)
		RB Size	RB offset	RB Size	RB offset		
L	QPSK	1	Max	1	0	22.77	0.0789
M	QPSK	1	Max	1	0	22.81	0.0796
H	QPSK	1	Max	1	0	22.68	0.0773
L	16QAM	1	Max	1	0	21.92	0.0649
M	16QAM	1	Max	1	0	21.86	0.0640
H	16QAM	1	Max	1	0	21.89	0.0644
L	64QAM	1	Max	1	0	20.77	0.0498
M	64QAM	1	Max	1	0	20.72	0.0492
H	64QAM	1	Max	1	0	20.75	0.0495
Combination 20MHz+15MHz (100RB+75RB)							
Channel	Modulation	PCC		SCC		Measured Power	EIRP(W)
		RB Size	RB offset	RB Size	RB offset		
M	QPSK	1	Max	1	0	22.73	0.0782
L	16QAM	1	Max	1	0	21.82	0.0634
Combination 15MHz+20MHz (75RB+100RB)							
Channel	Modulation	PCC		SCC		Measured Power	EIRP(W)
		RB Size	RB offset	RB Size	RB offset		
M	QPSK	1	Max	1	0	22.75	0.0785
L	16QAM	1	Max	1	0	21.80	0.0631
Combination 15MHz+15MHz (75RB+75RB)							
Channel	Modulation	PCC		SCC		Measured Power	EIRP(W)
		RB Size	RB offset	RB Size	RB offset		
M	QPSK	1	Max	1	0	22.73	0.0782
L	16QAM	1	Max	1	0	21.79	0.0630
Combination 20MHz+10MHz (100RB+50RB)							
Channel	Modulation	PCC		SCC		Measured Power	EIRP(W)
		RB Size	RB offset	RB Size	RB offset		
M	QPSK	1	Max	1	0	22.72	0.0780
L	16QAM	1	Max	1	0	21.85	0.0638
Combination 10MHz+20MHz (50RB+100RB)							
Channel	Modulation	PCC		SCC		Measured Power	EIRP(W)
		RB Size	RB offset	RB Size	RB offset		
M	QPSK	1	Max	1	0	22.70	0.0776
L	16QAM	1	Max	1	0	21.81	0.0632
Combination 15MHz+10MHz (75RB+50RB)							
Channel	Modulation	PCC		SCC		Measured Power	EIRP(W)
		RB Size	RB offset	RB Size	RB offset		
M	QPSK	1	Max	1	0	22.68	0.0773
L	16QAM	1	Max	1	0	21.73	0.0621



LTE Band 38C_CA_Ant.1:

Combination 20MHz+20MHz (100RB+100RB)							
Channel	Modulation	PCC		SCC		Measured Power	EIRP(W)
		RB Size	RB offset	RB Size	RB offset		
L	QPSK	1	Max	1	0	22.52	0.0679
M	QPSK	1	Max	1	0	22.60	0.0692
H	QPSK	1	Max	1	0	22.55	0.0684
L	16QAM	1	Max	1	0	21.53	0.0541
M	16QAM	1	Max	1	0	21.47	0.0533
H	16QAM	1	Max	1	0	21.49	0.0536
L	64QAM	1	Max	1	0	20.55	0.0432
M	64QAM	1	Max	1	0	20.43	0.0420
H	64QAM	1	Max	1	0	20.49	0.0426
Combination 15MHz+15MHz (75RB+75RB)							
Channel	Modulation	PCC		SCC		Measured Power	EIRP(W)
		RB Size	RB offset	RB Size	RB offset		
M	QPSK	1	Max	1	0	22.54	0.0682
L	16QAM	1	Max	1	0	21.47	0.0533



LTE Band 41C_CA_Ant.1:

Combination 20MHz+20MHz (100RB+100RB)							
Channel	Modulation	PCC		SCC		Measured Power	EIRP(W)
		RB Size	RB offset	RB Size	RB offset		
L	QPSK	1	Max	1	0	22.53	0.0697
M	QPSK	1	Max	1	0	22.59	0.0706
H	QPSK	1	Max	1	0	22.64	0.0714
L	16QAM	1	Max	1	0	21.50	0.0550
M	16QAM	1	Max	1	0	21.53	0.0553
H	16QAM	1	Max	1	0	21.47	0.0546
L	64QAM	1	Max	1	0	20.46	0.0433
M	64QAM	1	Max	1	0	20.52	0.0439
H	64QAM	1	Max	1	0	20.49	0.0436
Combination 20MHz+15MHz (100RB+75RB)							
Channel	Modulation	PCC		SCC		Measured Power	EIRP(W)
		RB Size	RB offset	RB Size	RB offset		
H	QPSK	1	Max	1	0	22.56	0.0701
M	16QAM	1	Max	1	0	21.43	0.0541
Combination 15MHz+20MHz (75RB+100RB)							
Channel	Modulation	PCC		SCC		Measured Power	EIRP(W)
		RB Size	RB offset	RB Size	RB offset		
H	QPSK	1	Max	1	0	22.49	0.0690
M	16QAM	1	Max	1	0	21.43	0.0541
Combination 15MHz+15MHz (75RB+75RB)							
Channel	Modulation	PCC		SCC		Measured Power	EIRP(W)
		RB Size	RB offset	RB Size	RB offset		
H	QPSK	1	Max	1	0	22.52	0.0695
M	16QAM	1	Max	1	0	21.49	0.0548
Combination 20MHz+10MHz (100RB+50RB)							
Channel	Modulation	PCC		SCC		Measured Power	EIRP(W)
		RB Size	RB offset	RB Size	RB offset		
H	QPSK	1	Max	1	0	22.47	0.0687
M	16QAM	1	Max	1	0	21.50	0.0550
Combination 10MHz+20MHz (50RB+100RB)							
Channel	Modulation	PCC		SCC		Measured Power	EIRP(W)
		RB Size	RB offset	RB Size	RB offset		
H	QPSK	1	Max	1	0	22.53	0.0697
M	16QAM	1	Max	1	0	21.45	0.0543
Combination 15MHz+10MHz (75RB+50RB)							
Channel	Modulation	PCC		SCC		Measured Power	EIRP(W)
		RB Size	RB offset	RB Size	RB offset		
H	QPSK	1	Max	1	0	22.57	0.0703
M	16QAM	1	Max	1	0	21.50	0.0550



Combination 10MHz+15MHz (50RB+75RB)							
Channel	Modulation	PCC		SCC		Measured Power	EIRP(W)
		RB Size	RB offset	RB Size	RB offset		
H	QPSK	1	Max	1	0	22.55	0.0700
M	16QAM	1	Max	1	0	21.49	0.0548
Combination 20MHz+5MHz (100RB+25RB)							
Channel	Modulation	PCC		SCC		Measured Power	EIRP(W)
		RB Size	RB offset	RB Size	RB offset		
H	QPSK	1	Max	1	0	22.43	0.0681
M	16QAM	1	Max	1	0	21.51	0.0551
Combination 5MHz+20MHz (25RB+100RB)							
Channel	Modulation	PCC		SCC		Measured Power	EIRP(W)
		RB Size	RB offset	RB Size	RB offset		
H	QPSK	1	Max	1	0	22.49	0.0690
M	16QAM	1	Max	1	0	21.49	0.0548



LTE Band 7_Main PA

Peak-to-Average Ratio

Mode	LTE Band 7 / 20MHz			
Mod.	QPSK	16QAM	64QAM	Limit: 13dB
RB Size	Full RB	Full RB	Full RB	Result
Middle CH	5.07	6.00	5.97	PASS

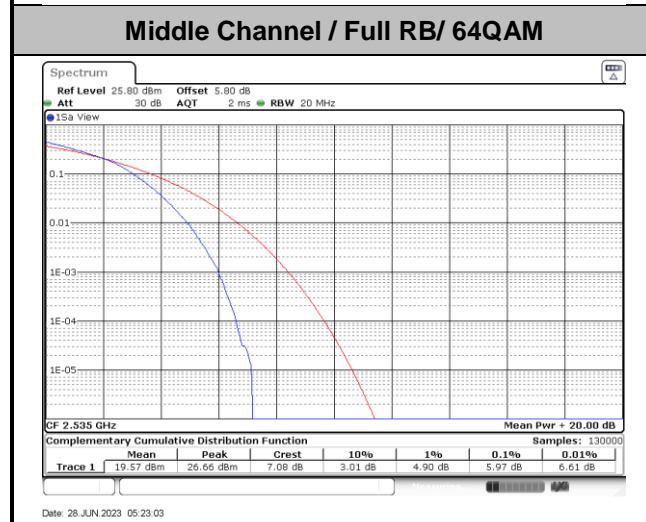
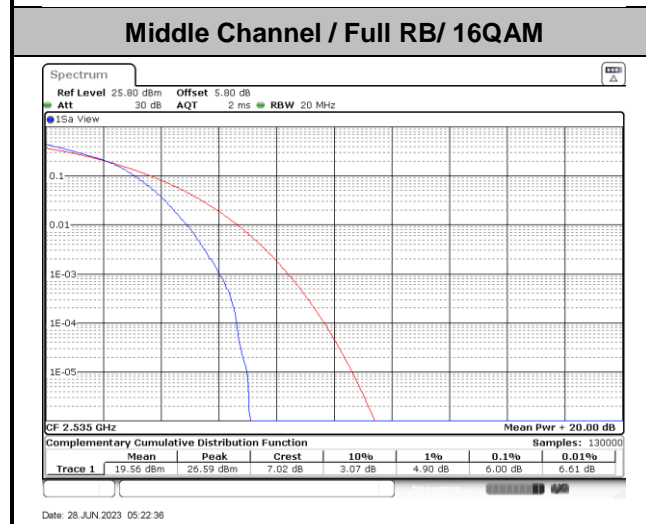
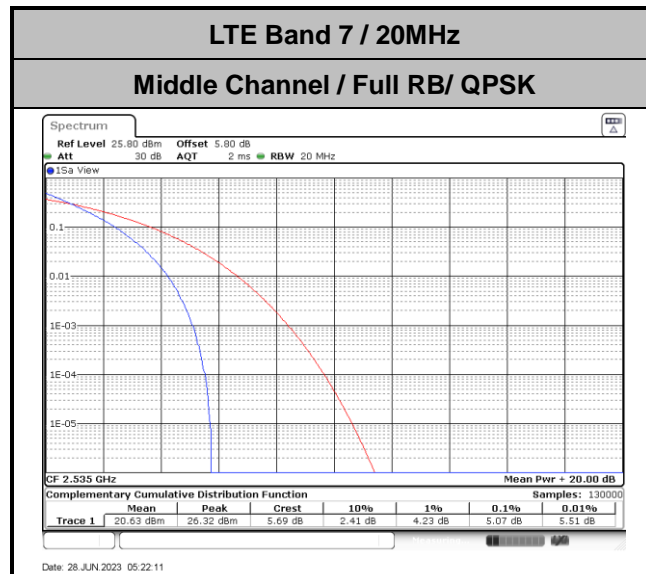



26dB Bandwidth

Mode	LTE Band 7 : 26dB BW(MHz)	
BW	5MHz	
Mod.	QPSK	16QAM
Middle CH	4.82	4.86
BW	10MHz	
Mod.	QPSK	16QAM
Middle CH	9.75	9.75
BW	15MHz	
Mod.	QPSK	16QAM
Middle CH	14.57	14.33
BW	20MHz	
Mod.	QPSK	16QAM
Middle CH	18.66	18.78

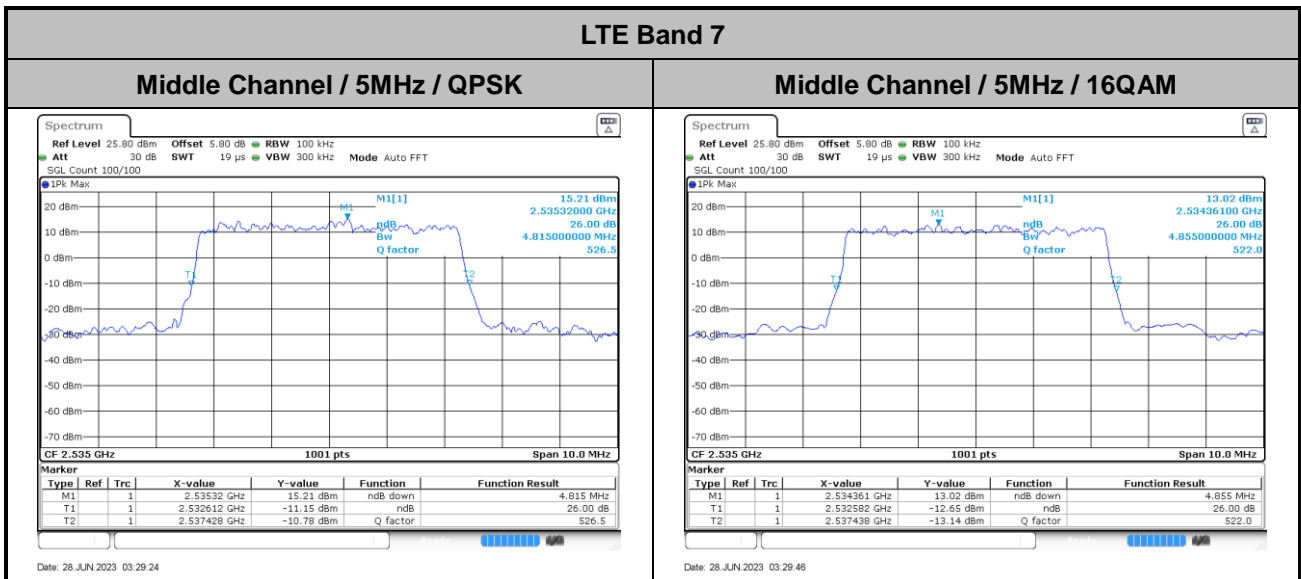



LTE Band 7

Middle Channel / 10MHz / QPSK

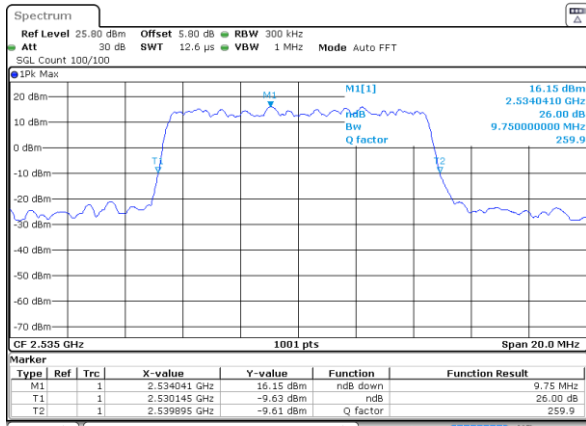

Date: 28 JUN 2023 03:30:30

Middle Channel / 10MHz / 16QAM

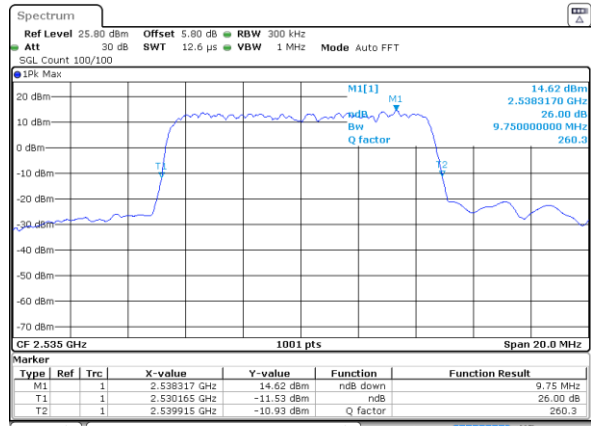

Date: 28 JUN 2023 03:30:08

LTE Band 7

Middle Channel / 15MHz / QPSK

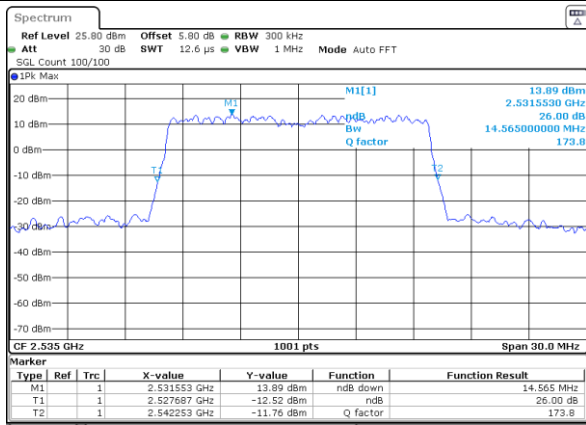

Date: 28 JUN 2023 03:30:52

Middle Channel / 15MHz / 16QAM

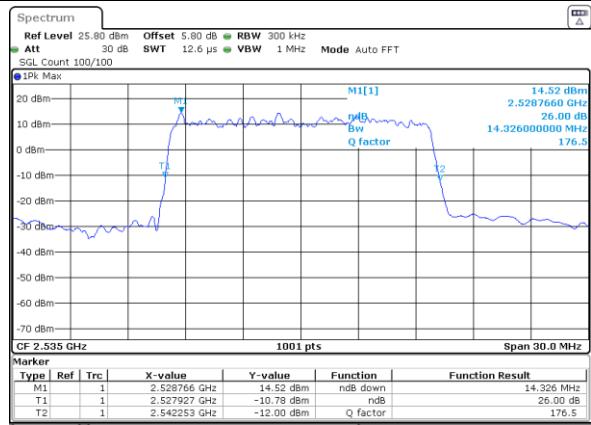

Date: 28 JUN 2023 03:31:14

LTE Band 7

Middle Channel / 20MHz / QPSK

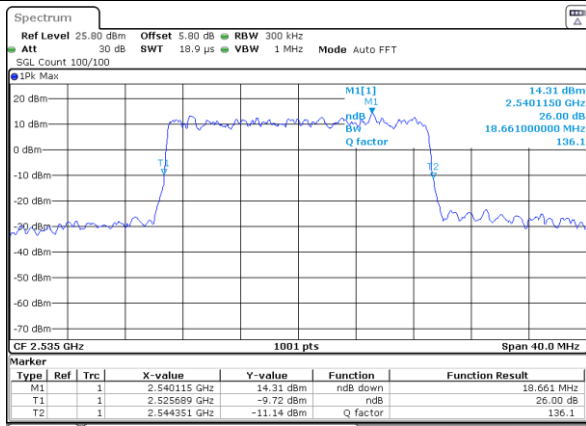

Date: 28 JUN 2023 03:31:59

Middle Channel / 20MHz / 16QAM

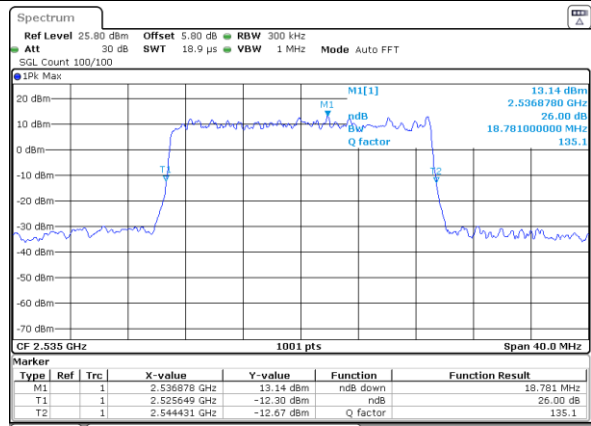

Date: 28 JUN 2023 03:31:37



Occupied Bandwidth

Mode	LTE Band 7 : 99%OBW(MHz)	
BW	5MHz	
Mod.	QPSK	16QAM
Middle CH	4.50	4.48
BW	10MHz	
Mod.	QPSK	16QAM
Middle CH	9.05	9.03
BW	15MHz	
Mod.	QPSK	16QAM
Middle CH	13.43	13.49
BW	20MHz	
Mod.	QPSK	16QAM
Middle CH	17.90	17.90

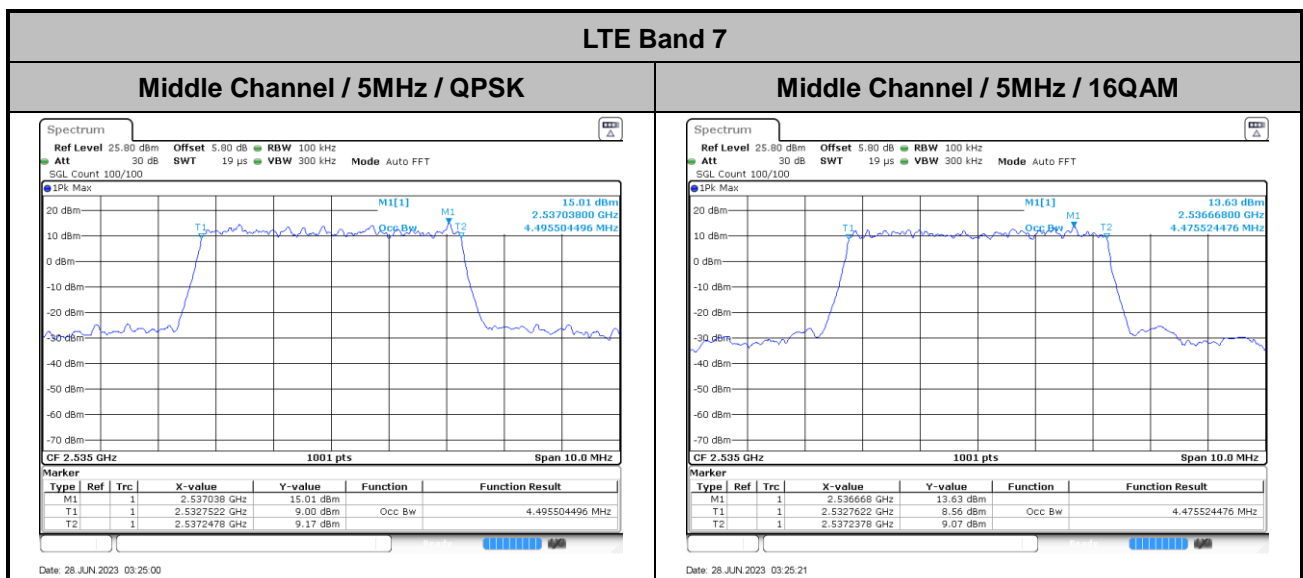



LTE Band 7

Middle Channel / 10MHz / QPSK

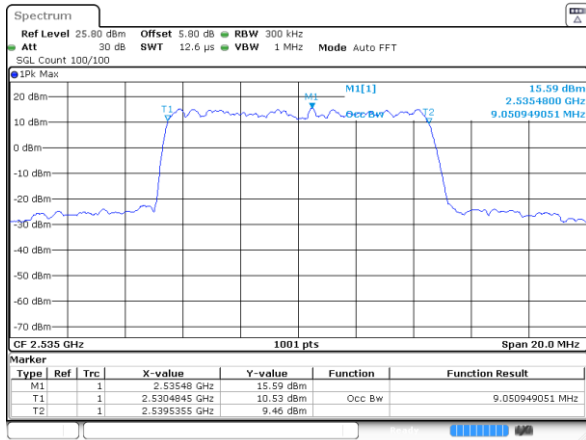

Date: 28 JUN 2023 03:25:43

Middle Channel / 10MHz / 16QAM

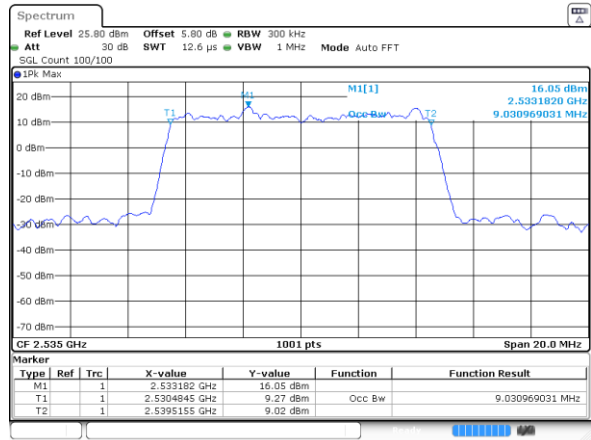

Date: 28 JUN 2023 03:26:04

LTE Band 7

Middle Channel / 15MHz / QPSK

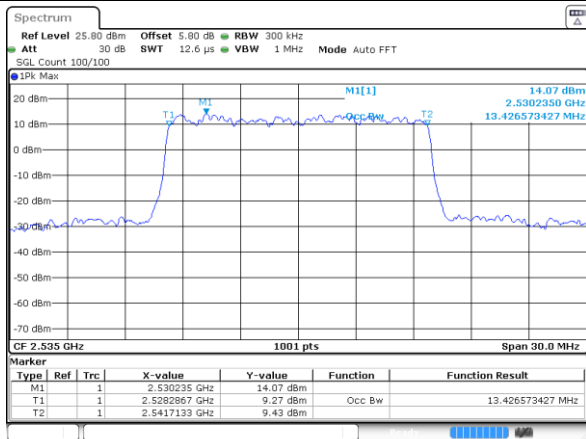

Date: 28 JUN 2023 03:26:26

Middle Channel / 15MHz / 16QAM

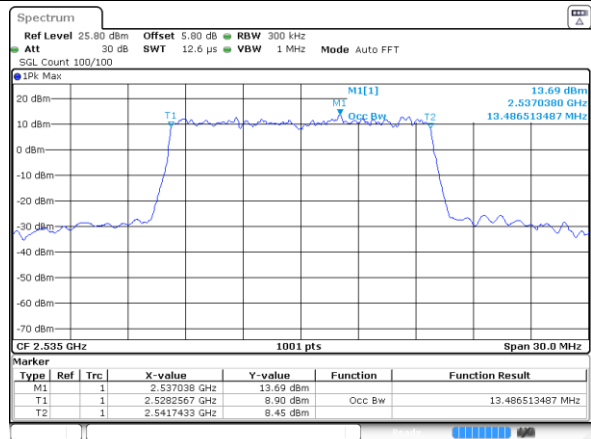

Date: 28 JUN 2023 03:26:48

LTE Band 7

Middle Channel / 20MHz / QPSK

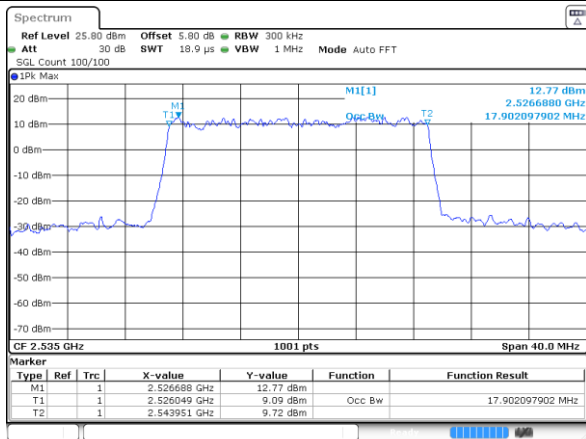

Date: 28 JUN 2023 03:27:10

Middle Channel / 20MHz / 16QAM

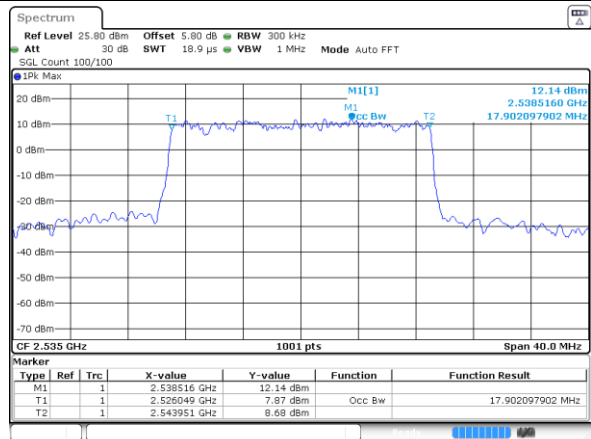

Date: 28 JUN 2023 03:27:34



Conducted Band Edge

LTE Band 7 / 5MHz / QPSK

Lowest Band Edge / 1 RB

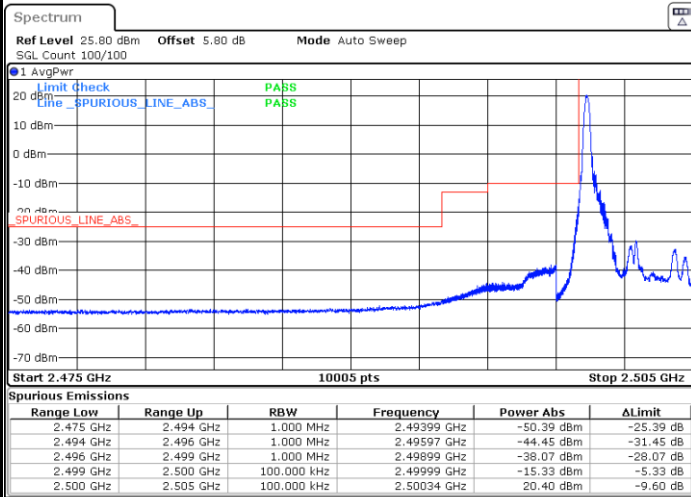

Date: 28 JUN 2023 02:23:36

Highest Band Edge / 1 RB

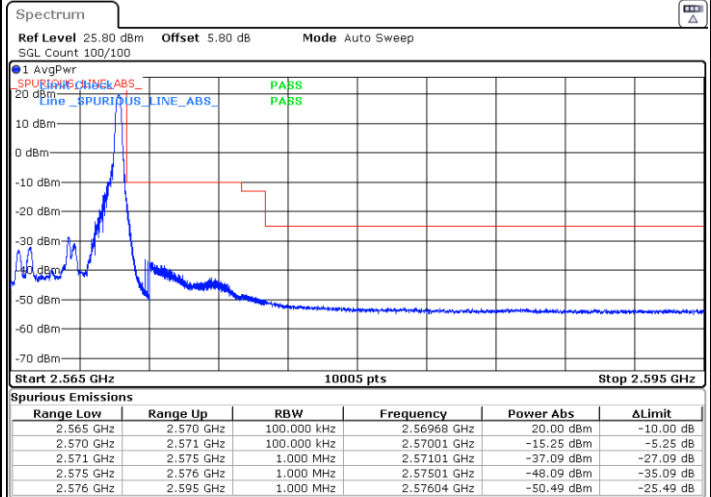

Date: 28 JUN 2023 02:29:59

Lowest Band Edge / Full RB

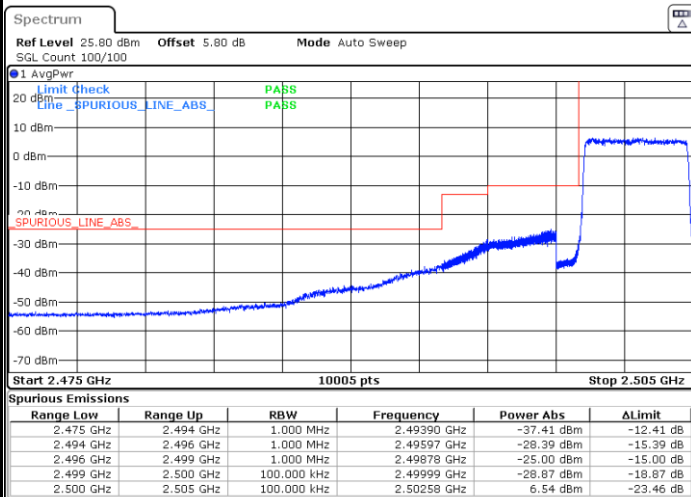

Date: 28 JUN 2023 02:21:15

Highest Band Edge / Full RB

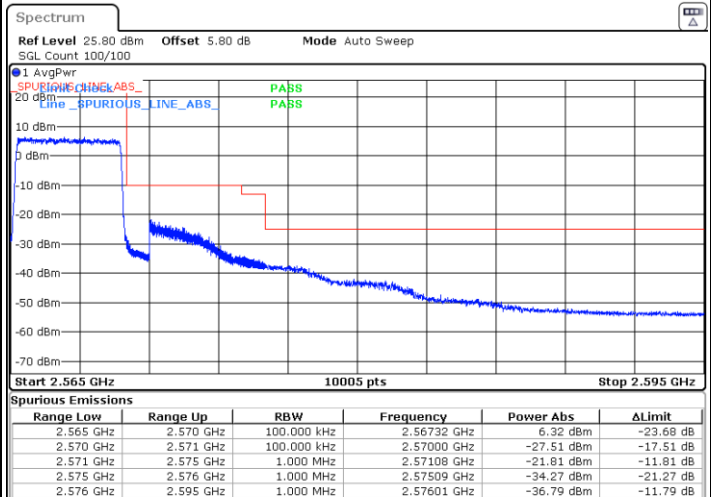

Date: 28 JUN 2023 02:32:17



LTE Band 7 / 5MHz / 16QAM

Lowest Band Edge / 1RB

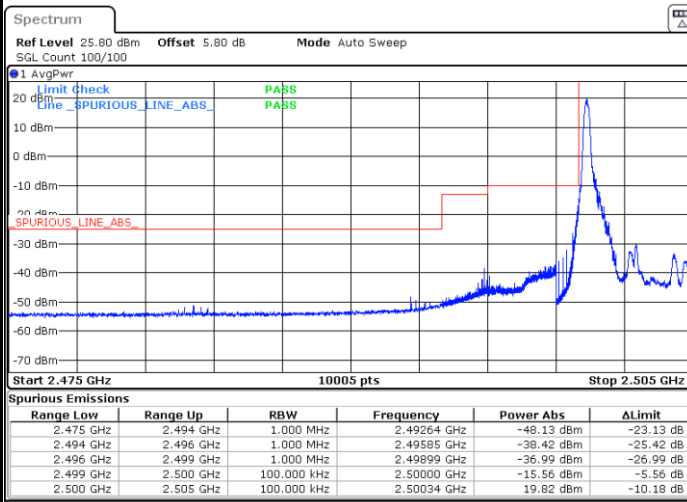

Date: 28 JUN 2023 02:24:22

Highest Band Edge / 1 RB

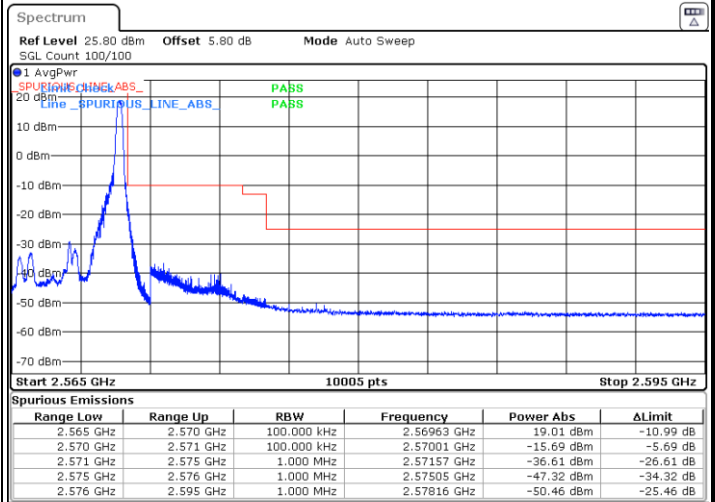

Date: 28 JUN 2023 02:30:45

Lowest Band Edge / Full RB

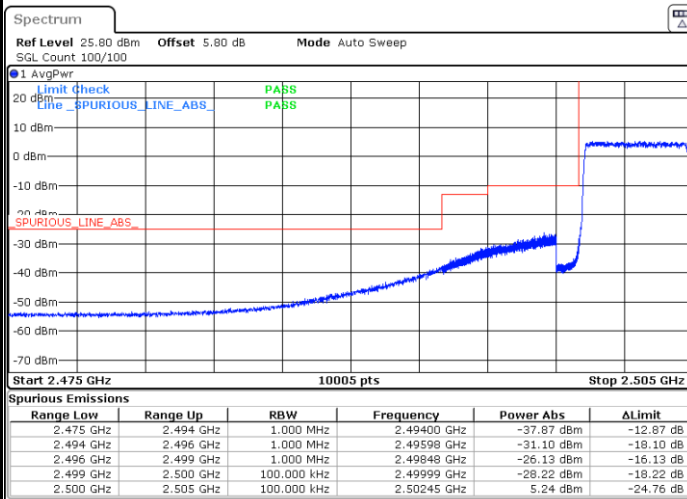

Date: 28 JUN 2023 02:22:03

Highest Band Edge / Full RB

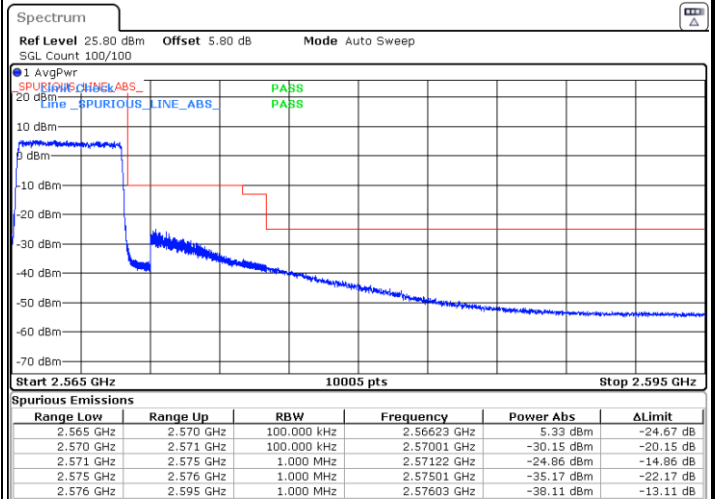

Date: 28 JUN 2023 02:33:03



LTE Band 7 / 5MHz / 64QAM

Lowest Band Edge / 1RB

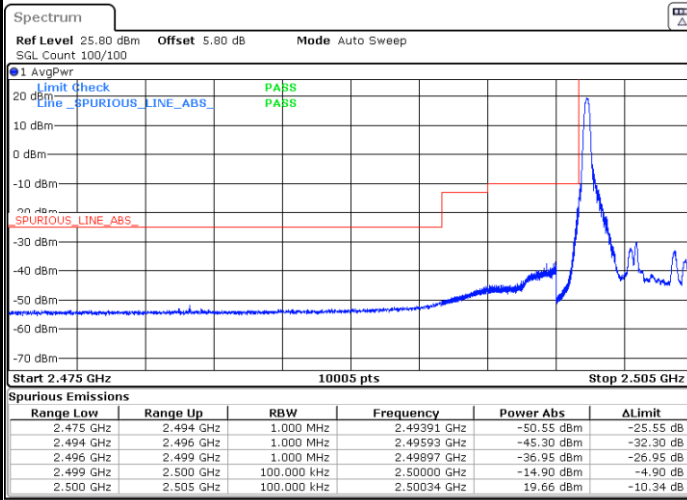

Date: 28 JUN 2023 02:25:08

Highest Band Edge / 1 RB

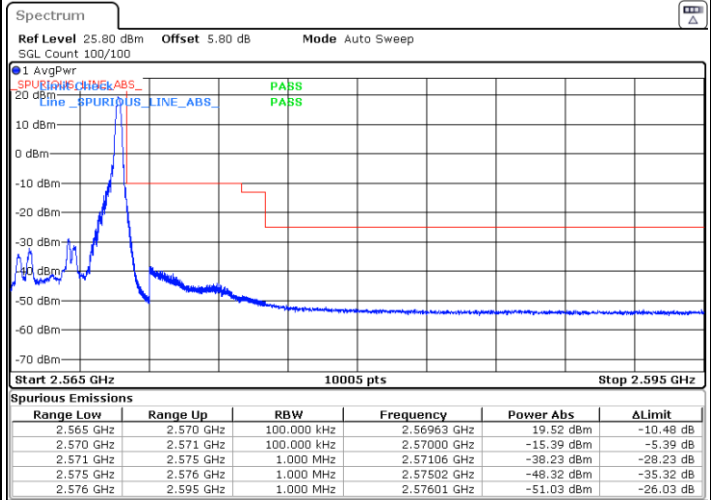

Date: 28 JUN 2023 02:31:31

Lowest Band Edge / Full RB

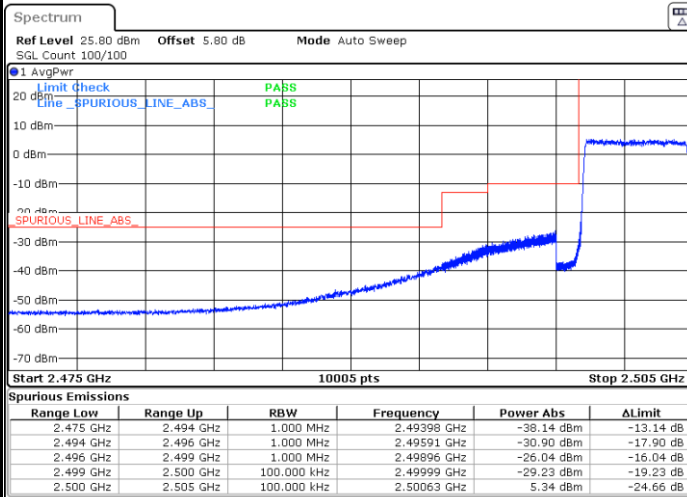

Date: 28 JUN 2023 02:22:50

Highest Band Edge / Full RB

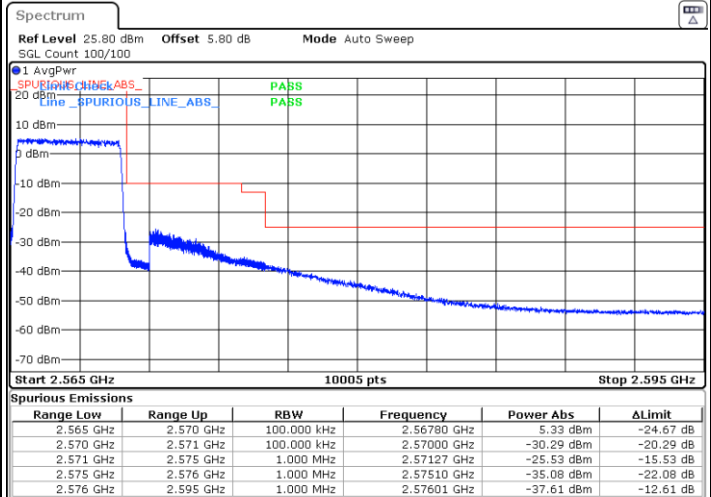

Date: 28 JUN 2023 02:33:48



LTE Band 7 / 10MHz / QPSK

Lowest Band Edge / 1 RB

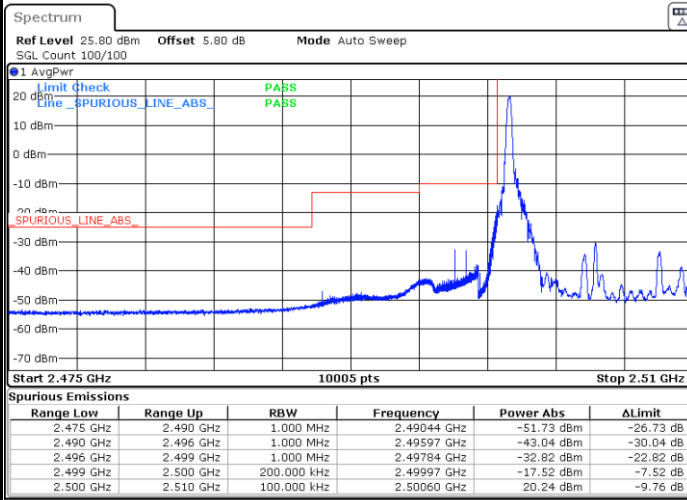

Date: 28 JUN 2023 02:36:50

Highest Band Edge / 1 RB

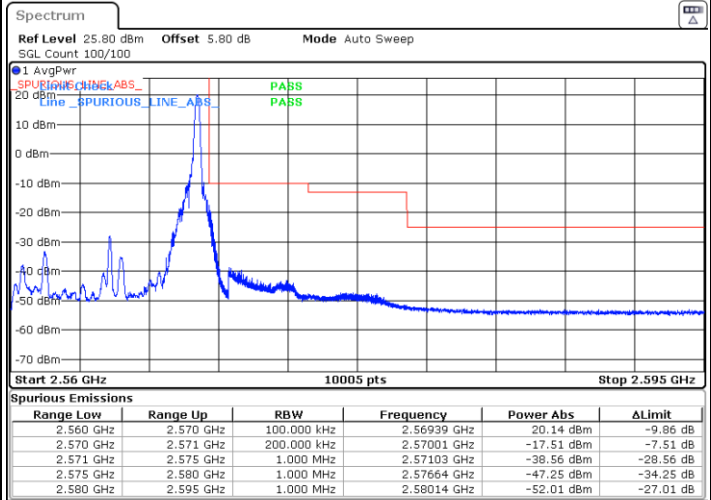

Date: 28 JUN 2023 02:43:03

Lowest Band Edge / Full RB

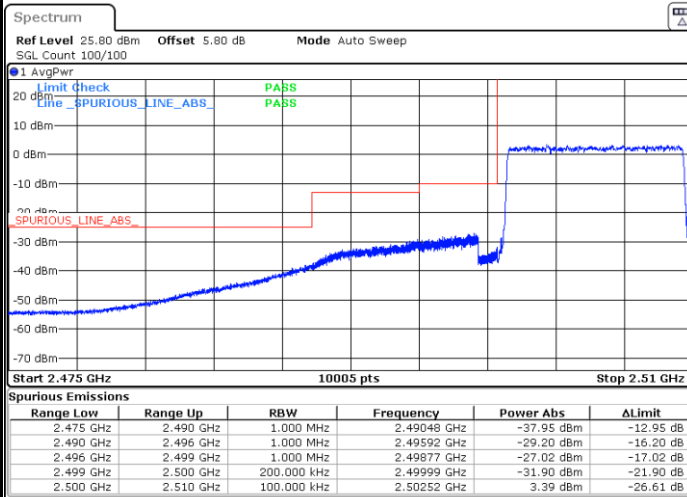

Date: 28 JUN 2023 02:34:34

Highest Band Edge / Full RB

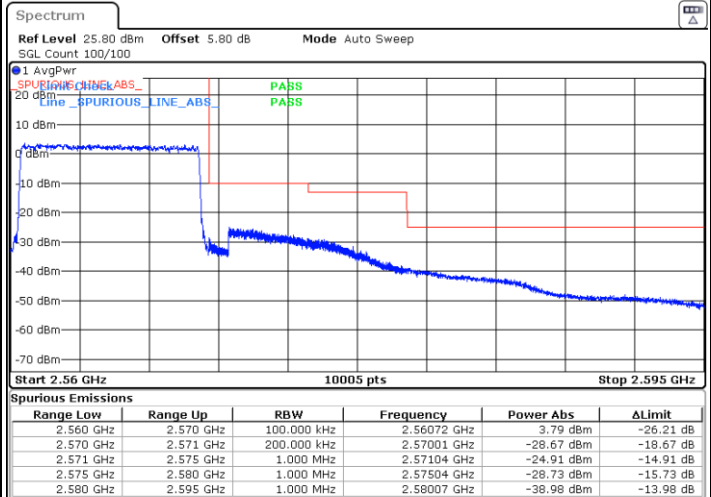

Date: 28 JUN 2023 02:45:18



LTE Band 7 / 10MHz / 16QAM

Lowest Band Edge / 1 RB

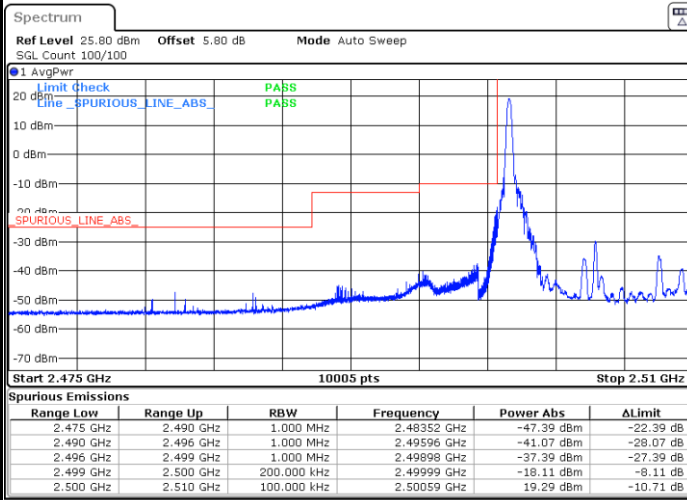

Date: 28 JUN 2023 02:37:35

Highest Band Edge / 1 RB

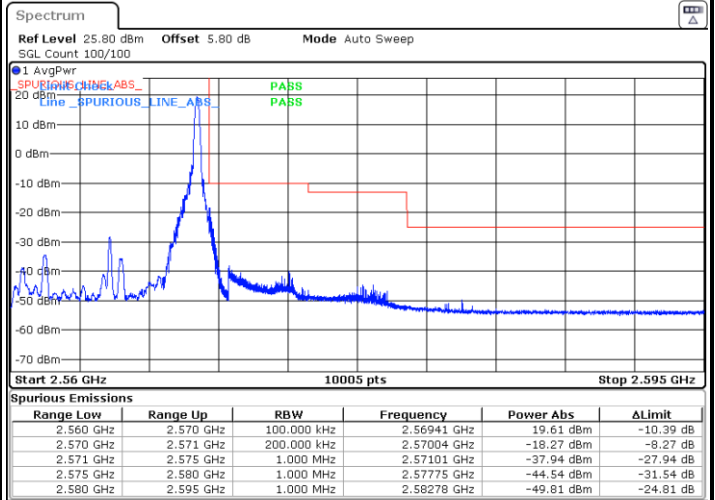

Date: 28 JUN 2023 02:43:48

Lowest Band Edge / Full RB

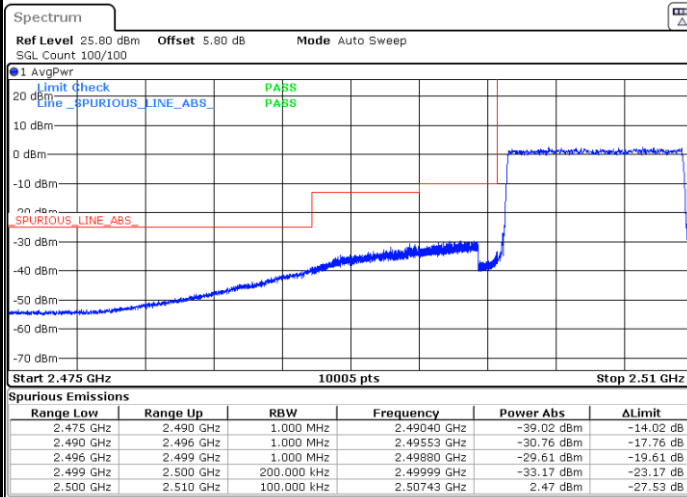

Date: 28 JUN 2023 02:35:20

Highest Band Edge / Full RB

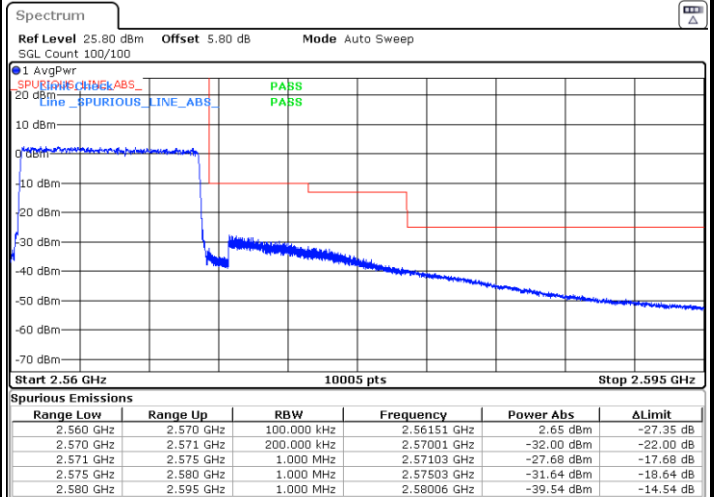

Date: 28 JUN 2023 02:46:03



LTE Band 7 / 10MHz / 64QAM

Lowest Band Edge / 1 RB

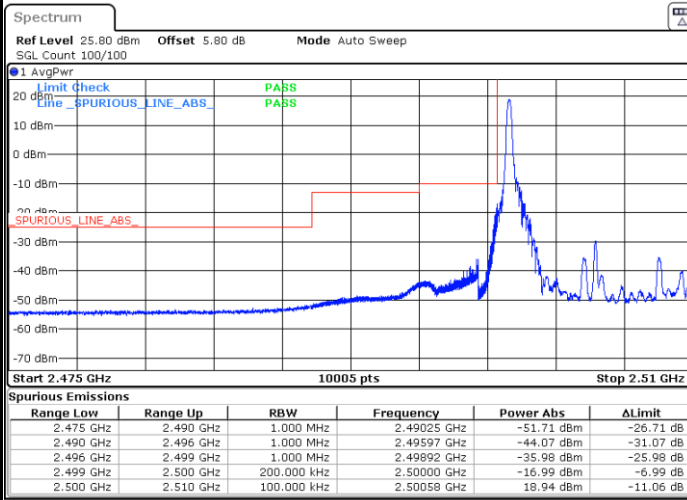

Date: 28 JUN 2023 02:38:20

Highest Band Edge / 1 RB

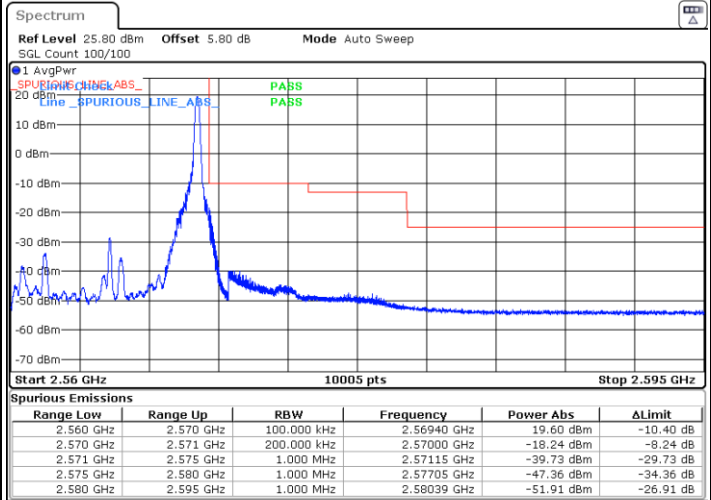

Date: 28 JUN 2023 02:44:33

Lowest Band Edge / Full RB

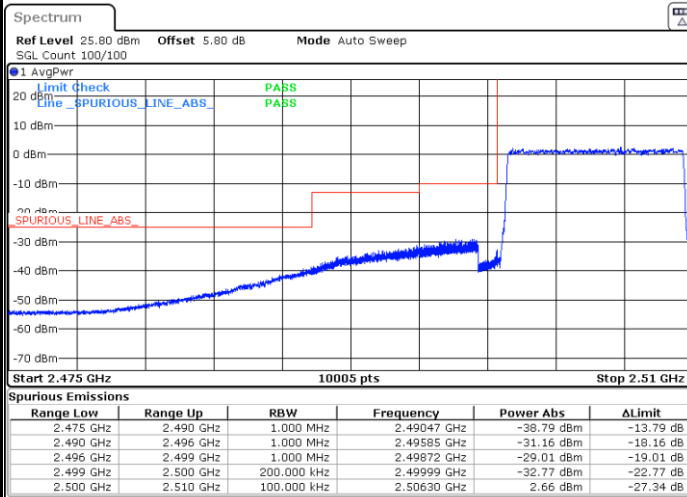

Date: 28 JUN 2023 02:36:05

Highest Band Edge / Full RB

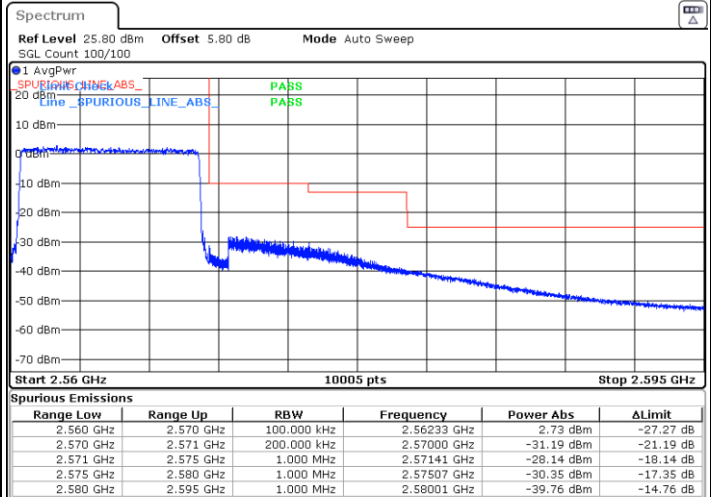

Date: 28 JUN 2023 02:46:49



LTE Band 7 / 15MHz / QPSK

Lowest Band Edge / 1 RB

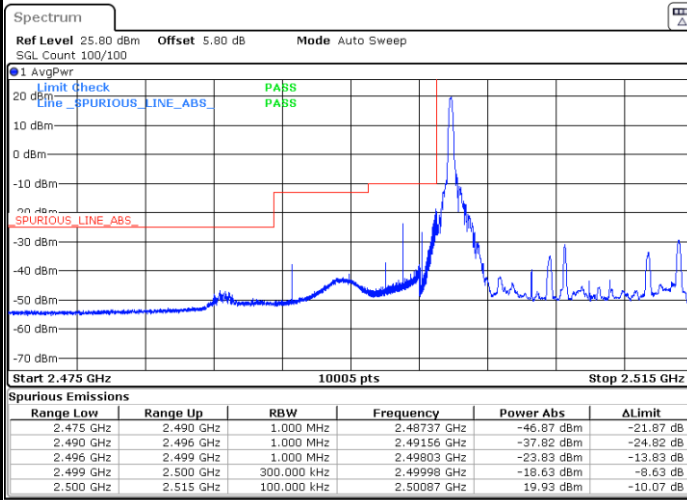

Date: 28 JUN 2023 02:49:51

Highest Band Edge / 1 RB

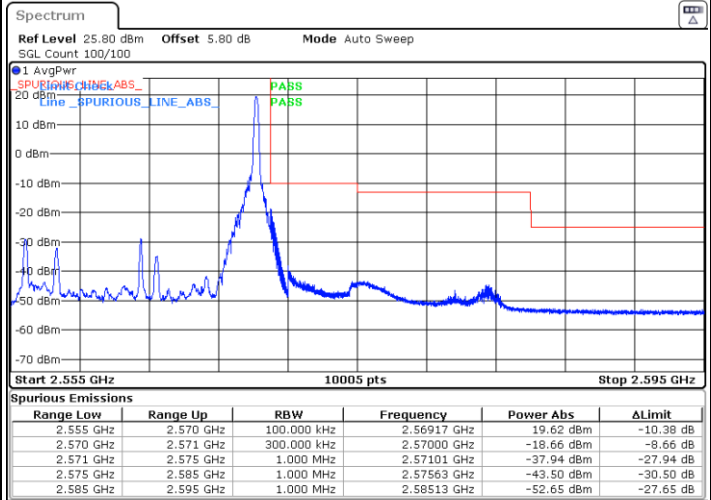

Date: 28 JUN 2023 02:56:05

Lowest Band Edge / Full RB

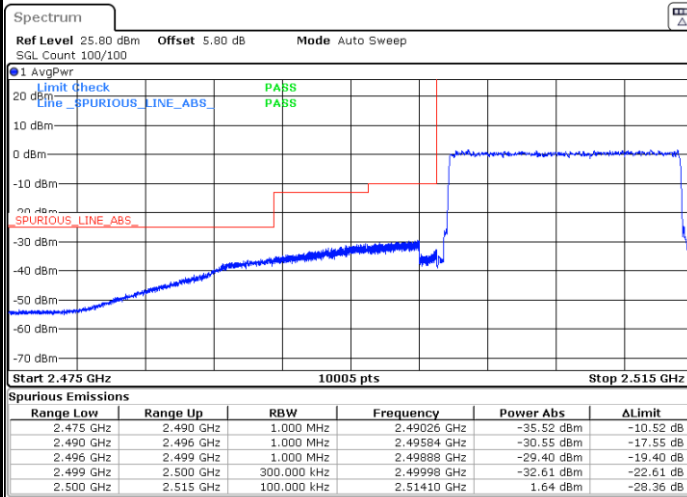

Date: 28 JUN 2023 02:47:35

Highest Band Edge / Full RB

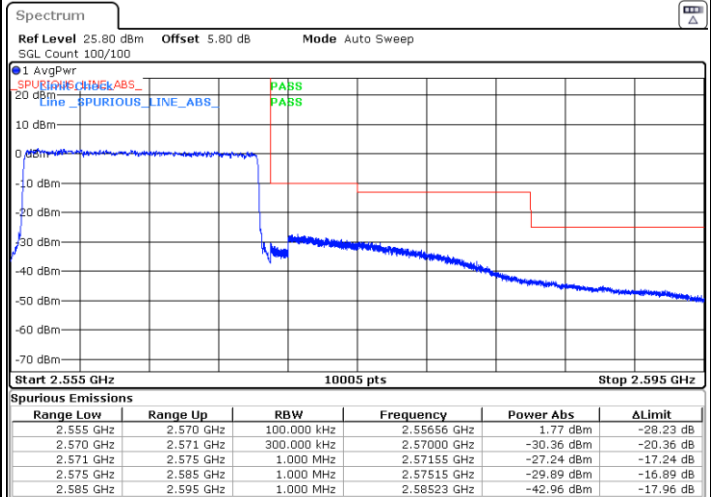

Date: 28 JUN 2023 02:58:21



LTE Band 7 / 15MHz / 16QAM

Lowest Band Edge / 1 RB

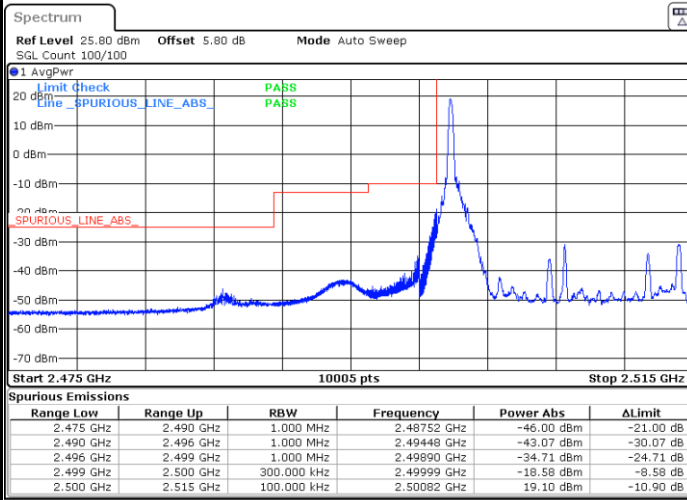

Date: 28 JUN 2023 02:50:36

Highest Band Edge / 1 RB

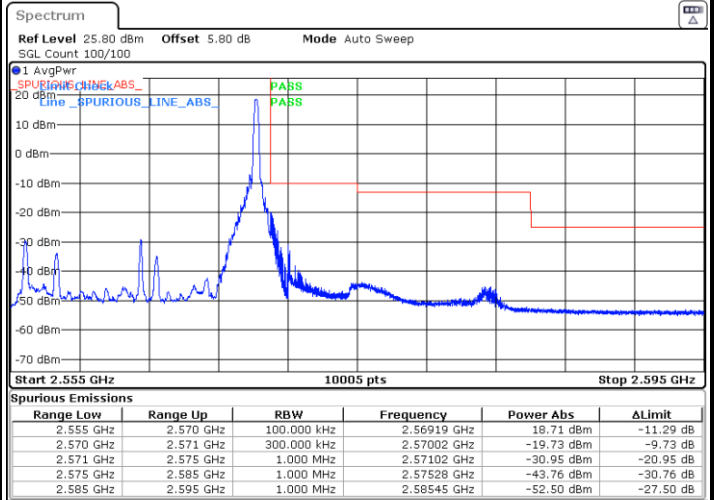

Date: 28 JUN 2023 02:56:50

Lowest Band Edge / Full RB

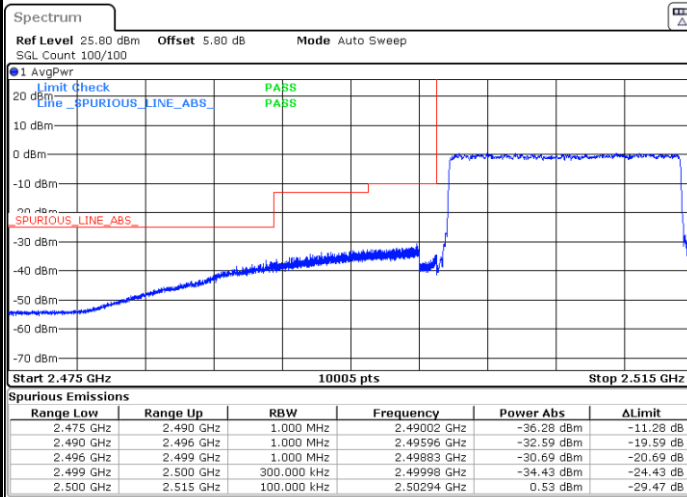

Date: 28 JUN 2023 02:48:20

Highest Band Edge / Full RB

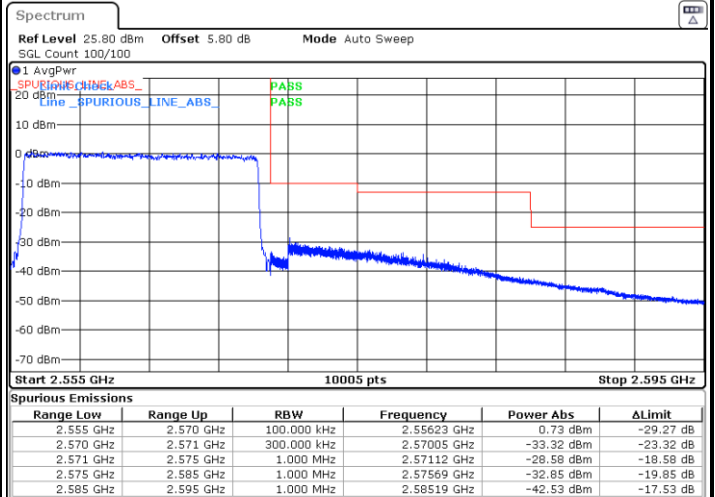

Date: 28 JUN 2023 02:59:06



LTE Band 7 / 15MHz / 64QAM

Lowest Band Edge / 1 RB

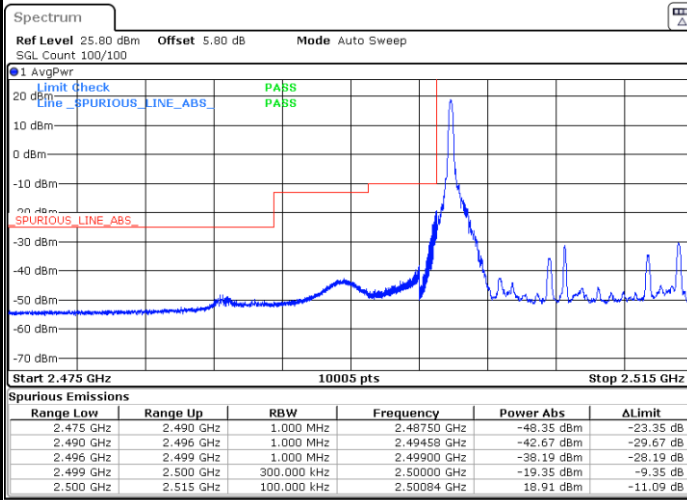

Date: 28 JUN 2023 02:51:22

Highest Band Edge / 1 RB

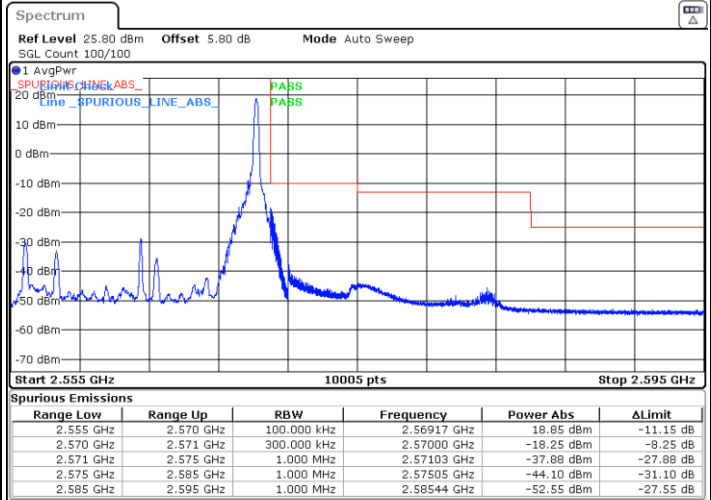

Date: 28 JUN 2023 02:57:35

Lowest Band Edge / Full RB

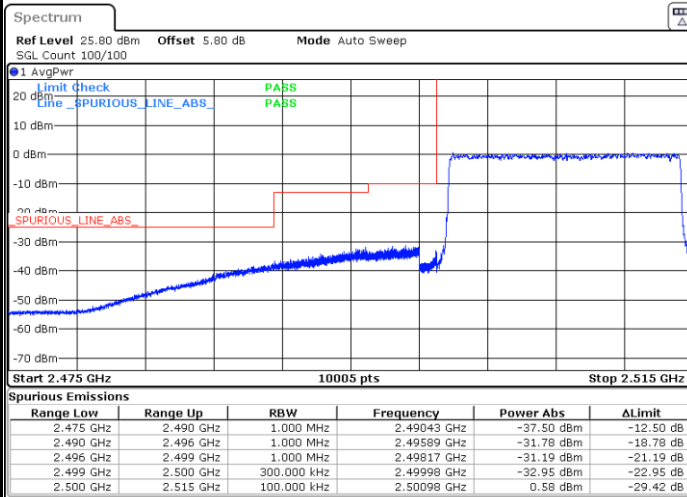

Date: 28 JUN 2023 02:49:05

Highest Band Edge / Full RB

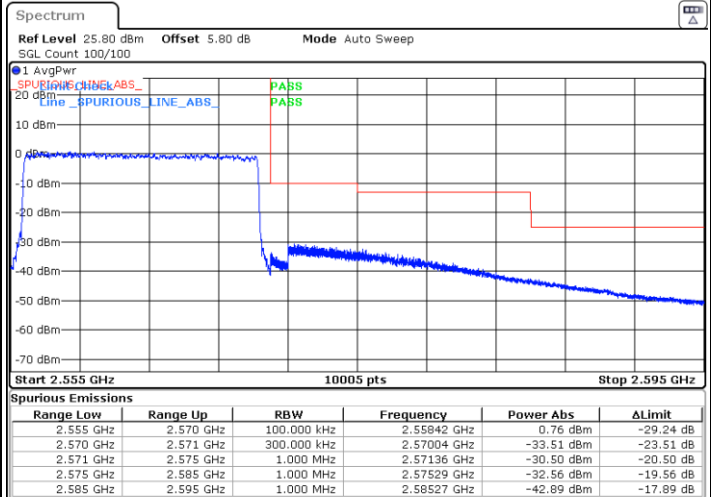

Date: 28 JUN 2023 02:59:51



LTE Band 7 / 20MHz / QPSK

Lowest Band Edge / 1 RB

Highest Band Edge / 1 RB

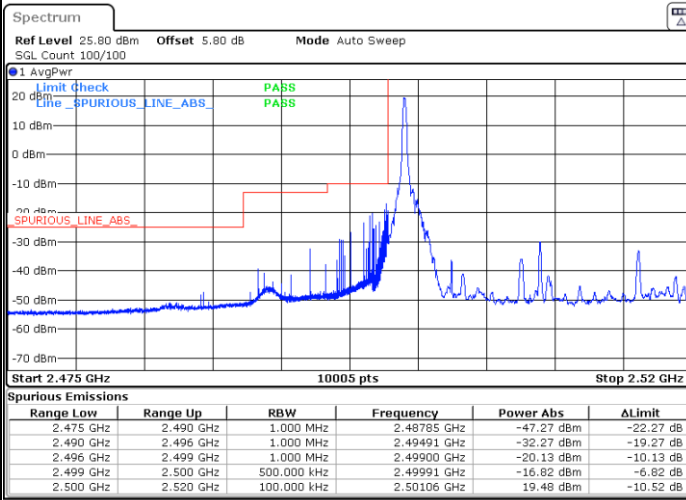

Date: 28 JUN 2023 03:02:53

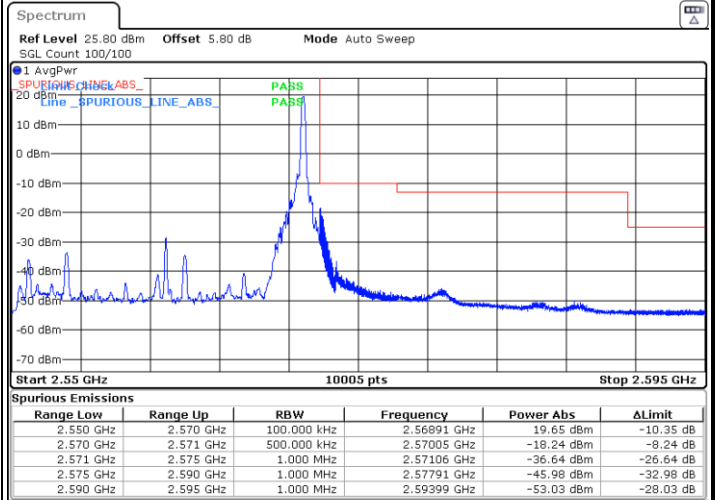

Date: 28 JUN 2023 03:09:07

Lowest Band Edge / Full RB

Highest Band Edge / Full RB

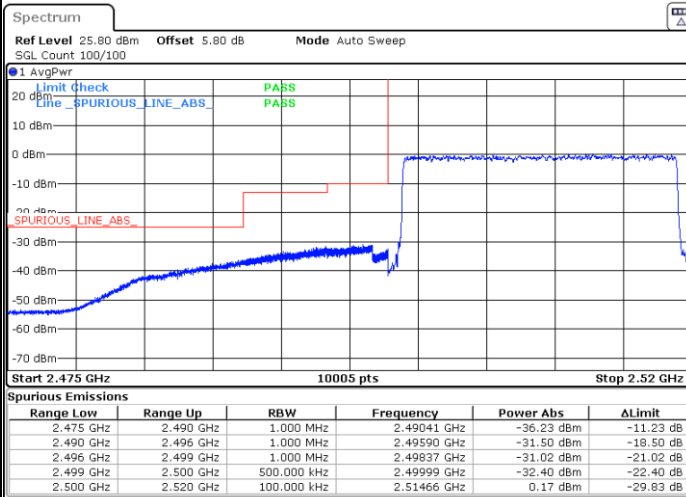

Date: 28 JUN 2023 03:00:36

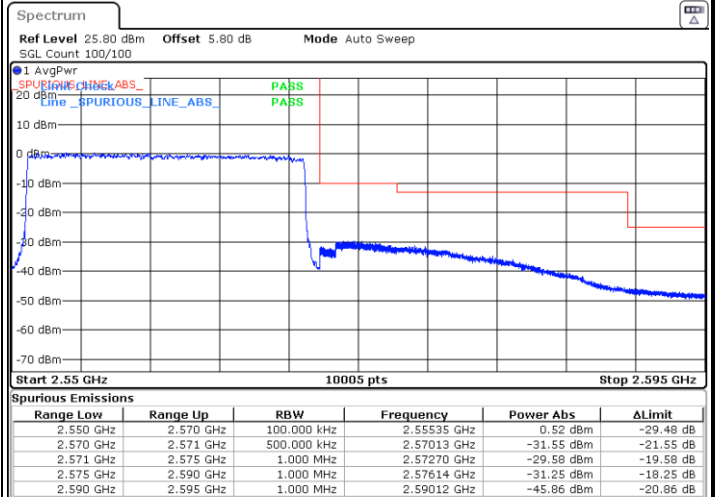

Date: 28 JUN 2023 03:11:23



LTE Band 7 / 20MHz / 16QAM

Lowest Band Edge / 1 RB

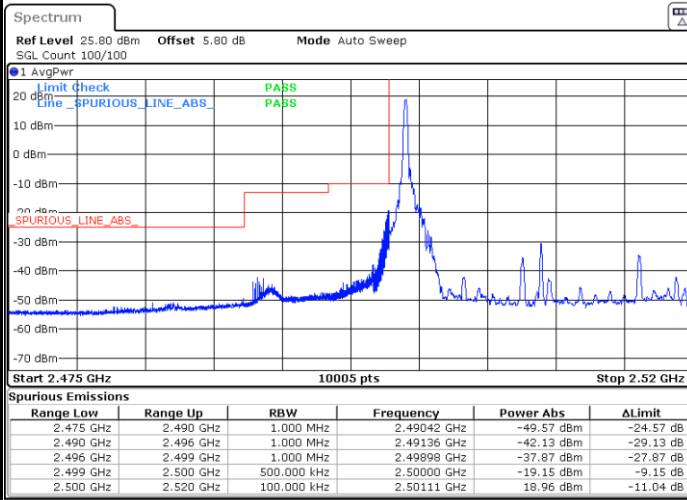

Date: 28 JUN 2023 03:03:38

Highest Band Edge / 1 RB

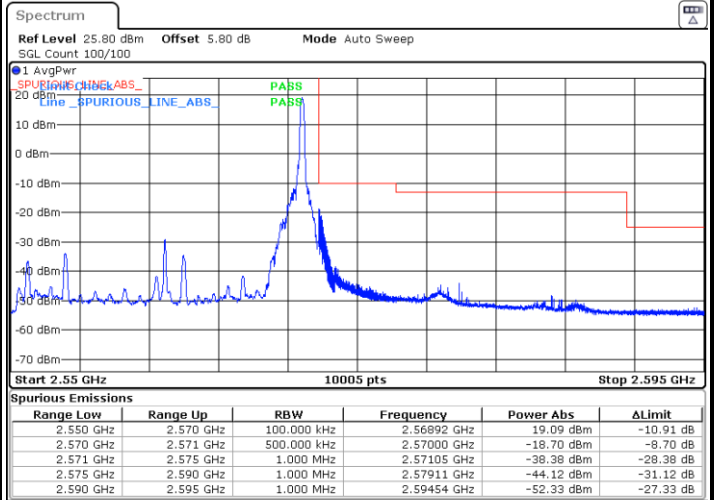

Date: 28 JUN 2023 03:09:53

Lowest Band Edge / Full RB

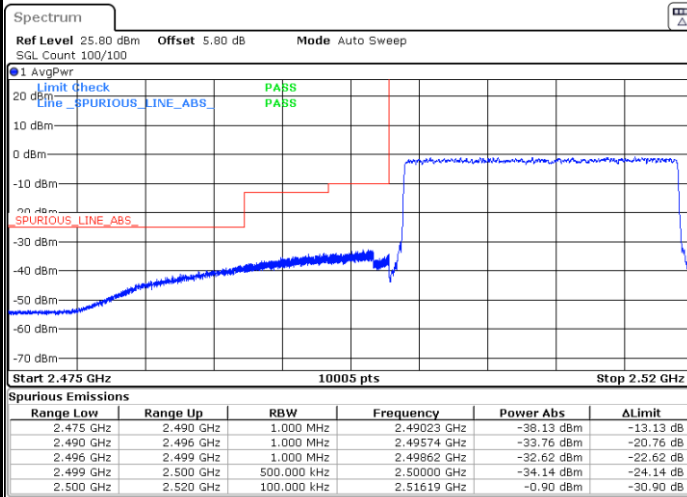

Date: 28 JUN 2023 03:01:22

Highest Band Edge / Full RB

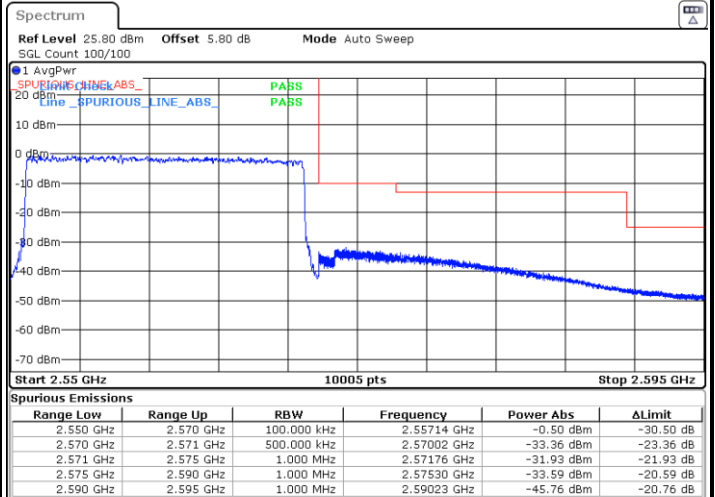

Date: 28 JUN 2023 03:12:08



LTE Band 7 / 20MHz / 64QAM

Lowest Band Edge / 1 RB

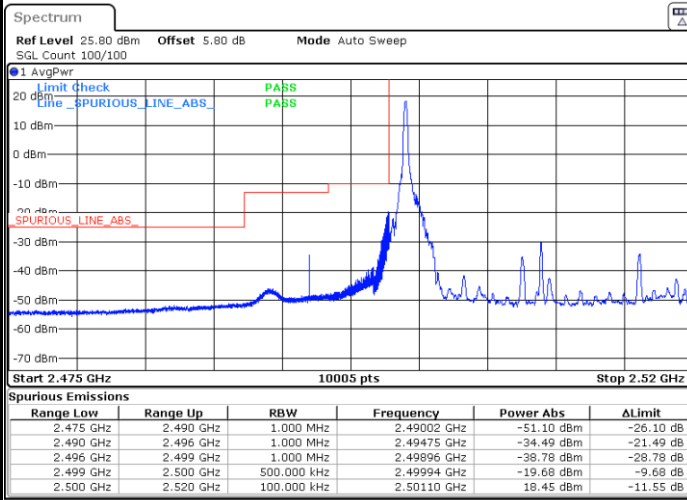

Date: 28 JUN 2023 03:04:24

Highest Band Edge / 1 RB

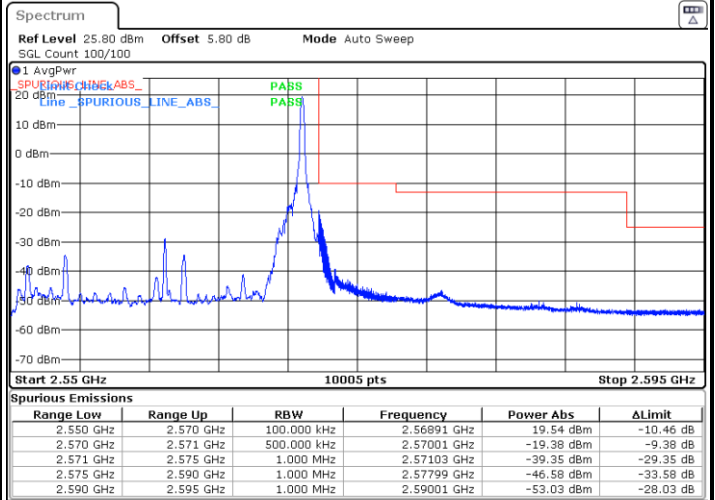

Date: 28 JUN 2023 03:10:38

Lowest Band Edge / Full RB

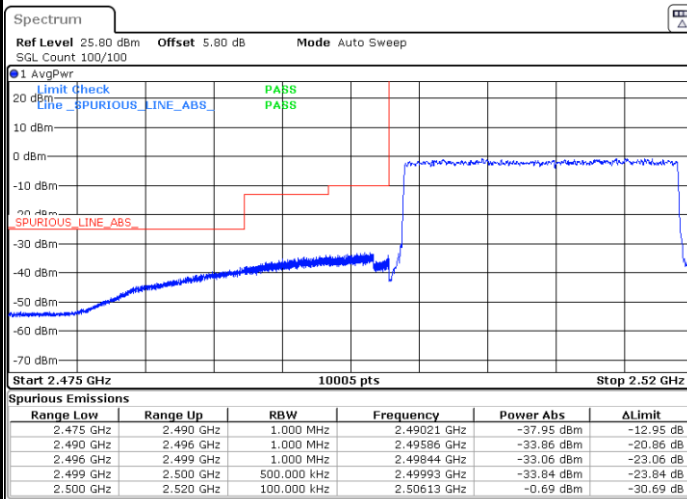

Date: 28 JUN 2023 03:02:08

Highest Band Edge / Full RB

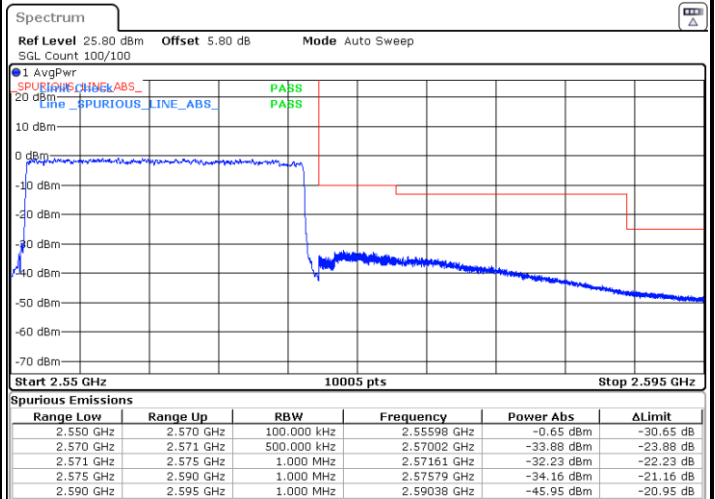

Date: 28 JUN 2023 03:12:53



Conducted Spurious Emission

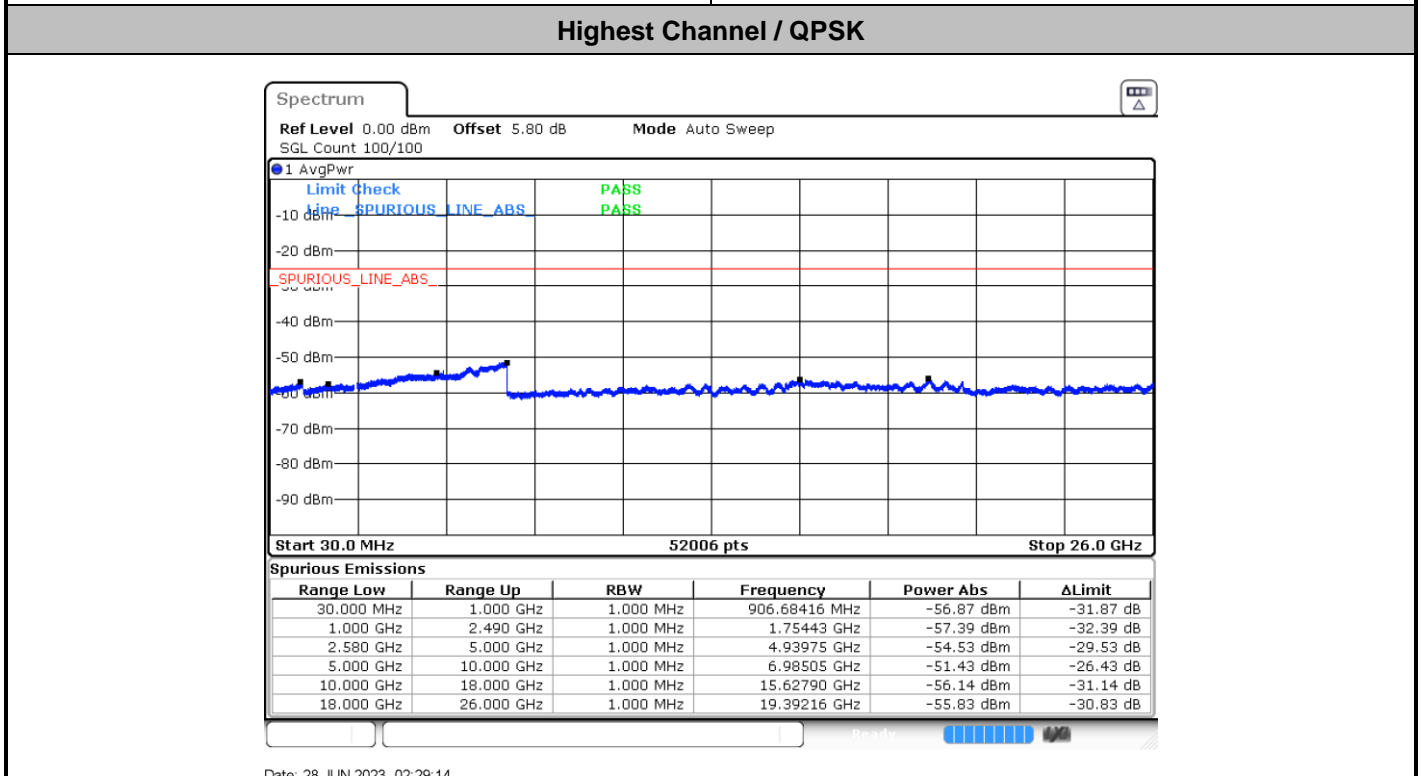
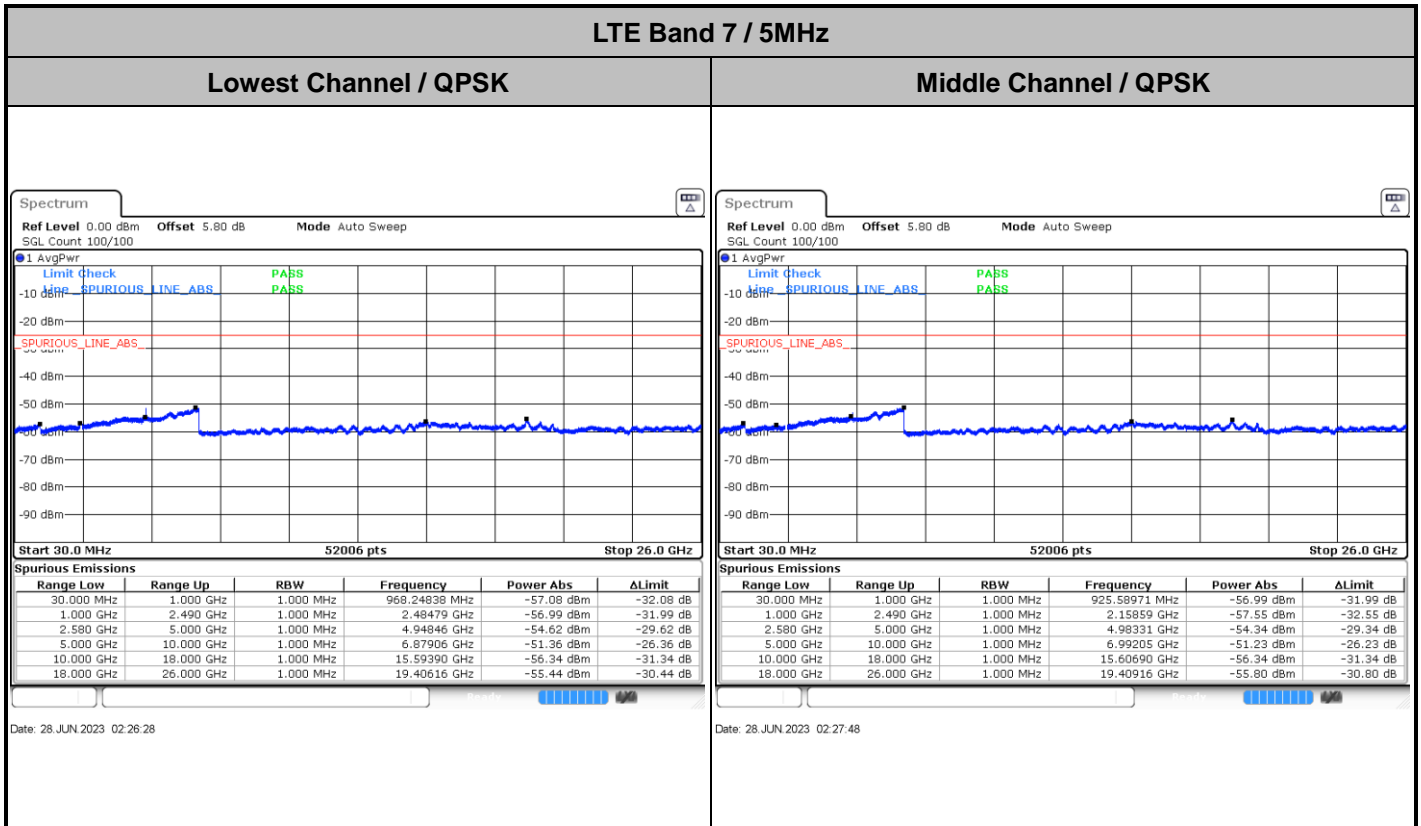



LTE Band 7 / 10MHz

Lowest Channel / QPSK

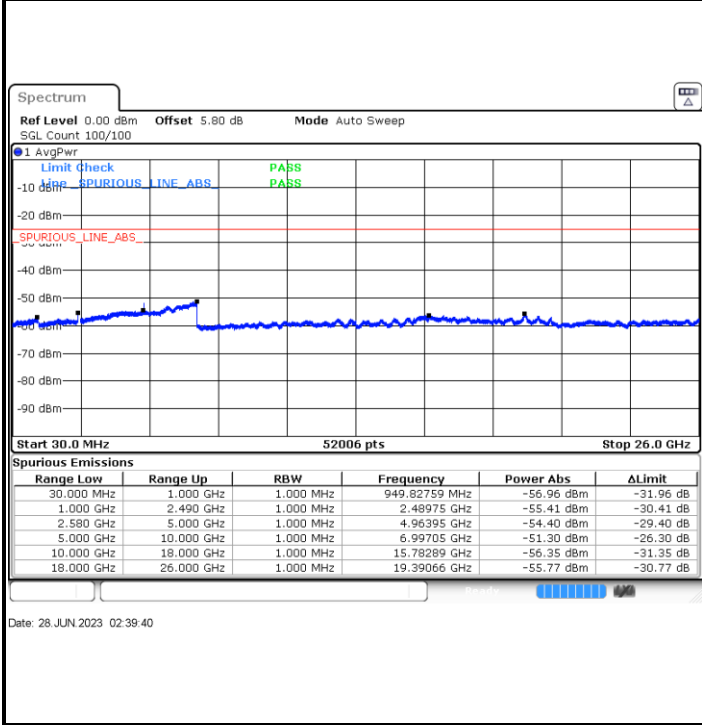

Middle Channel / QPSK

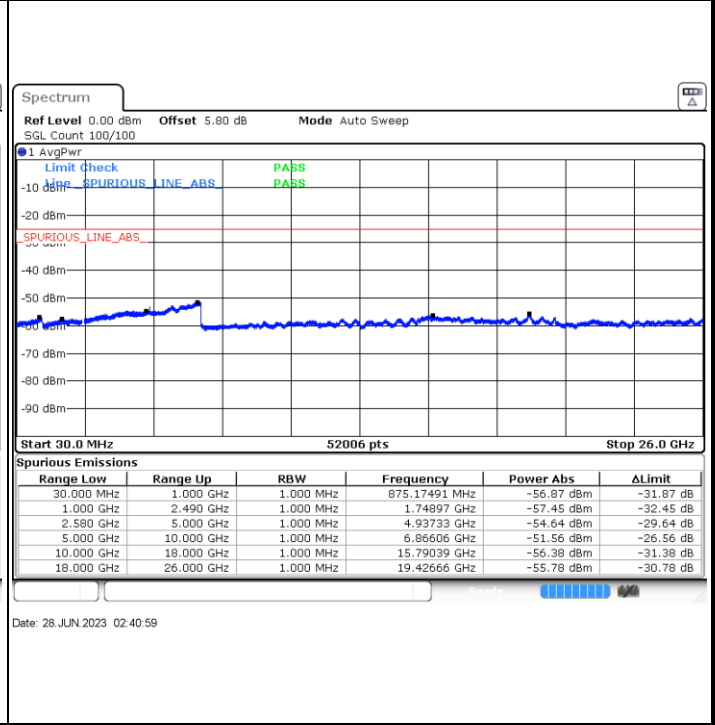

Highest Channel / QPSK

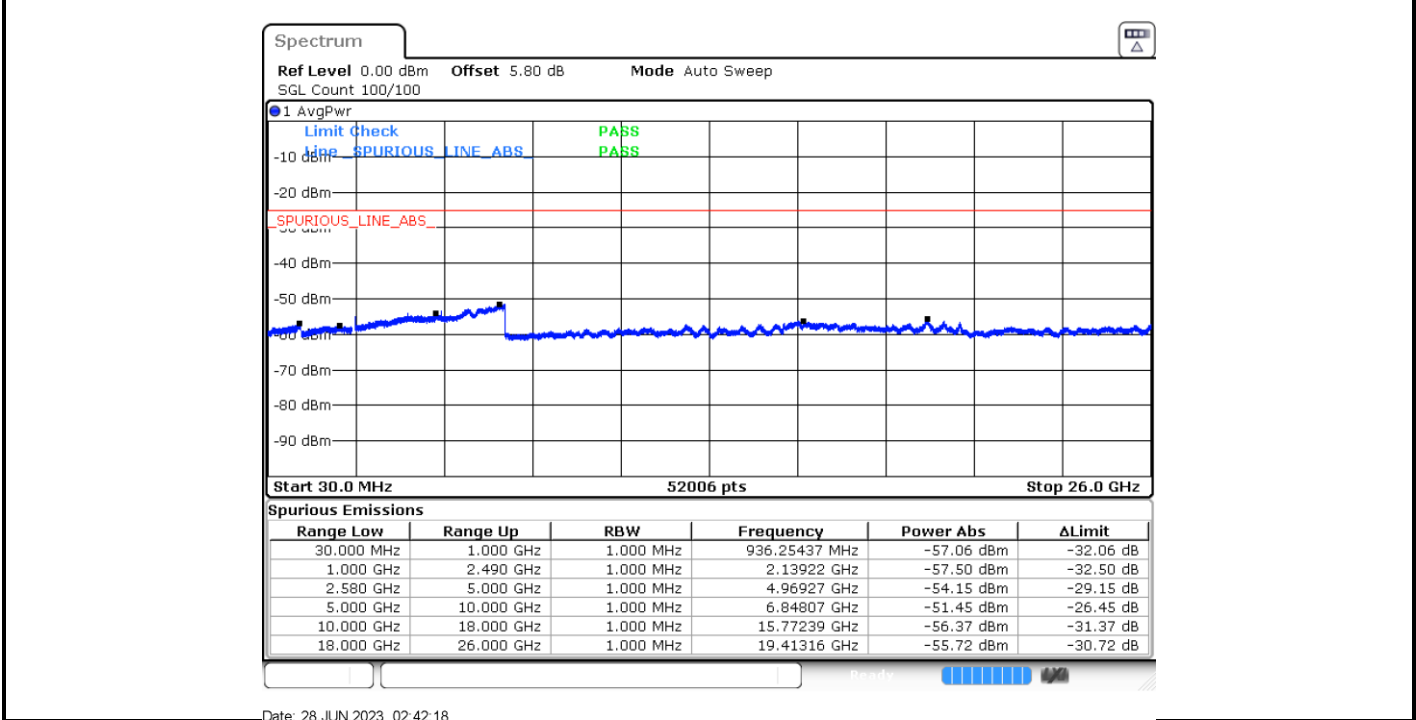



LTE Band 7 / 15MHz

Lowest Channel / QPSK

Middle Channel / QPSK

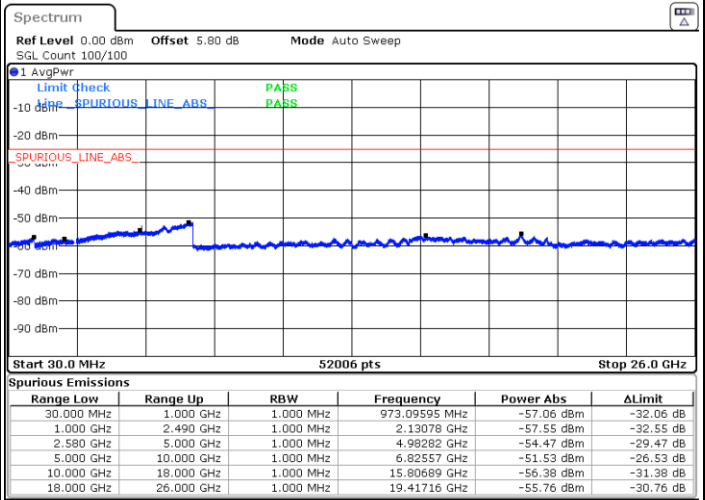
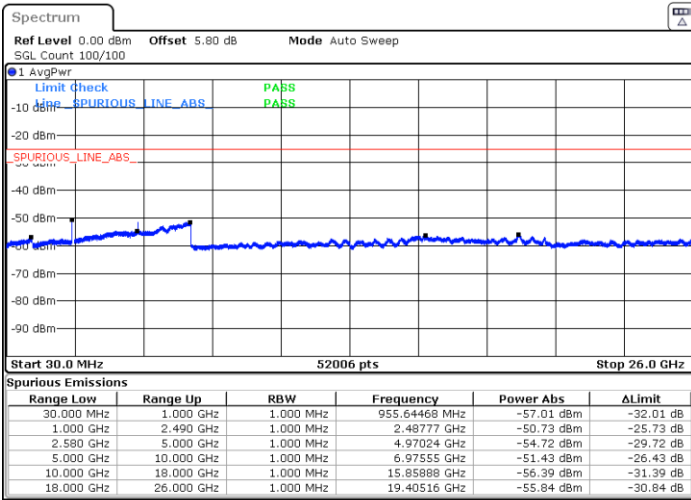

Date: 28 JUN 2023 02:52:41

Date: 28 JUN 2023 02:54:00

Highest Channel / QPSK

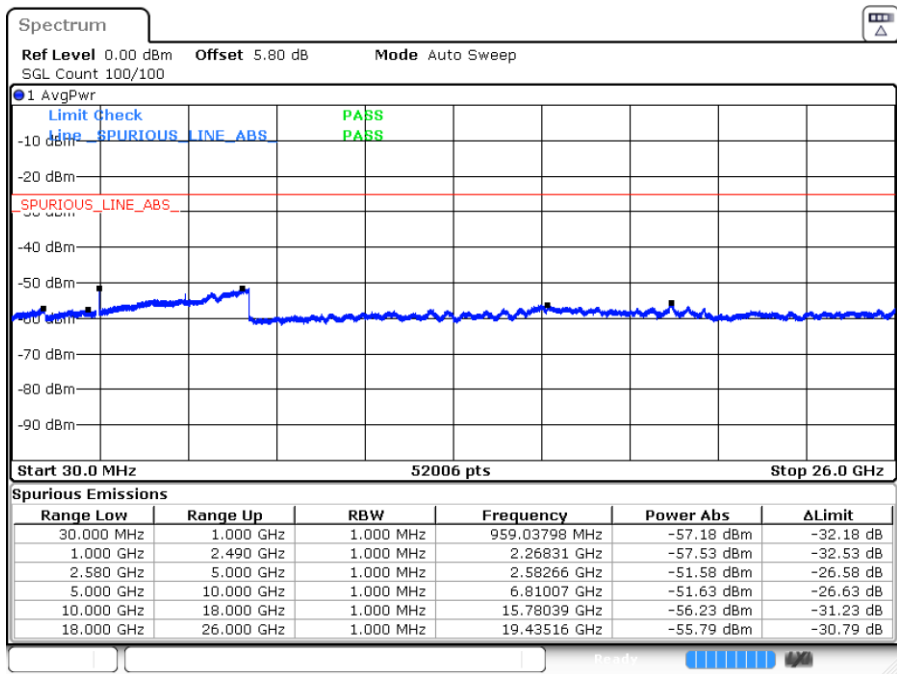

Date: 28 JUN 2023 02:55:19



LTE Band 7 / 20MHz

Lowest Channel / QPSK

Middle Channel / QPSK

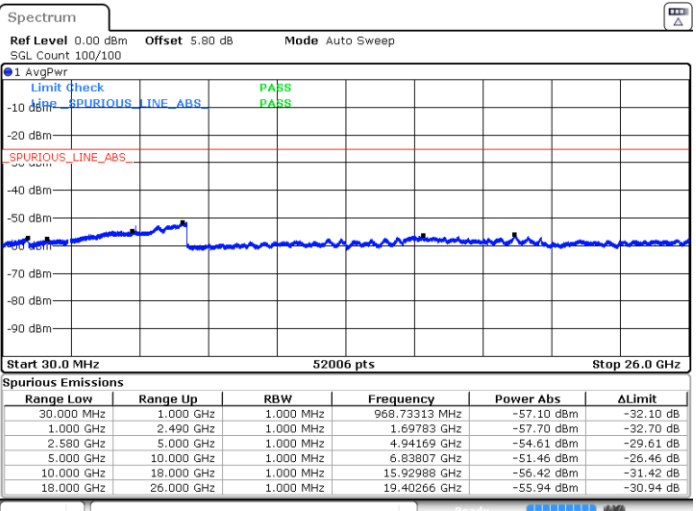
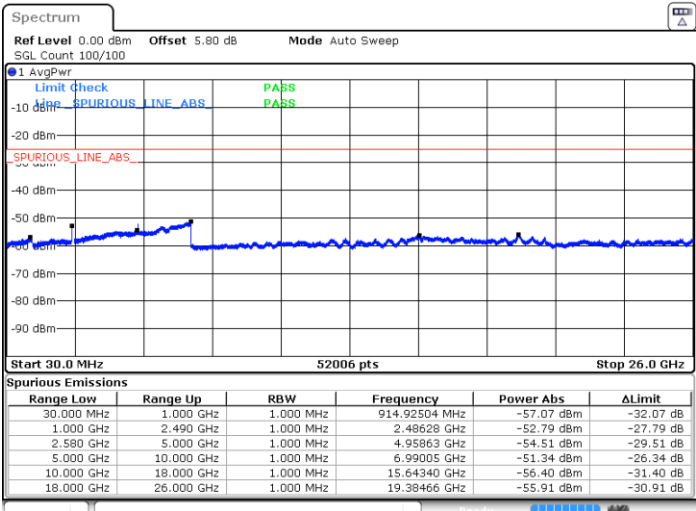

Date: 28 JUN 2023 03:05:43

Date: 28 JUN 2023 03:07:02

Highest Channel / QPSK

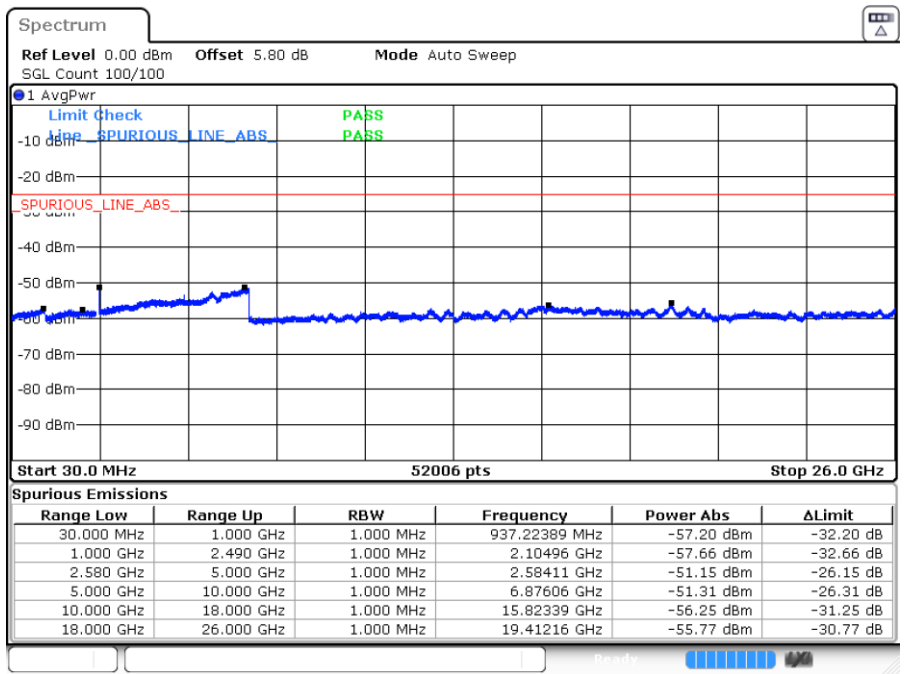

Date: 28 JUN 2023 03:08:22



Frequency Stability

Test Conditions		LTE Band 7 (QPSK) / Middle Channel	Limit
Temperature (°C)	Voltage (Volt)	BW 10MHz	Note 2.
		Deviation (ppm)	Result
50	Normal Voltage	0.0023	PASS
40	Normal Voltage	0.0019	
30	Normal Voltage	0.0014	
20(Ref.)	Normal Voltage	0.0000	
10	Normal Voltage	0.0013	
0	Normal Voltage	0.0010	
-10	Normal Voltage	0.0029	
-20	Normal Voltage	0.0023	
-30	Normal Voltage	0.0017	
20	Maximum Voltage	0.0012	
20	Normal Voltage	0.0005	
20	Battery End Point	0.0016	

Note:

1. Normal Voltage =3.91 V. ; Battery End Point (BEP) =3.6 V. ; Maximum Voltage =4.45 V.
2. Note: The frequency fundamental emissions stay within the authorized frequency block.



LTE Band 7_Other PA

Peak-to-Average Ratio

Mode	LTE Band 7 / 20MHz			
Mod.	QPSK	16QAM	64QAM	Limit: 13dB
RB Size	Full RB	Full RB	Full RB	Result
Middle CH	4.96	4.96	5.01	PASS

