



# FCC RF Test Report

APPLICANT : Motorola Mobility LLC  
EQUIPMENT : Mobile Cellular Phone  
BRAND NAME : Motorola  
MODEL NAME : XT2343-2  
FCC ID : IHDT56AM5  
STANDARD : 47 CFR Part 2, 24(E)  
CLASSIFICATION : PCS Licensed Transmitter Held to Ear (PCE)  
TEST DATE(S) : Jun. 26, 2023 ~ Jul. 17, 2023

We, Sporton International Inc. (Kunshan), would like to declare that the tested sample has been evaluated in accordance with the procedures given in ANSI C63.26-2015 and shown compliance with the applicable technical standards.

The test results in this report apply exclusively to the tested model / sample. Without written approval of Sporton International Inc. (Kunshan), the test report shall not be reproduced except in full.

Jason Jia

Approved by: Jason Jia



**Sporton International Inc. (Kunshan)**

**No. 1098, Pengxi North Road, Kunshan Economic Development Zone Jiangsu Province 215300  
People's Republic of China**



# TABLE OF CONTENTS

**REVISION HISTORY..... 3**

**SUMMARY OF TEST RESULT ..... 4**

**1 GENERAL DESCRIPTION ..... 5**

    1.1 Applicant..... 5

    1.2 Manufacturer ..... 5

    1.3 Product Feature of Equipment Under Test ..... 5

    1.4 Product Specification of Equipment Under Test ..... 5

    1.5 Modification of EUT ..... 6

    1.6 Maximum EIRP Power, and Emission Designator ..... 6

    1.7 Specification of Accessory ..... 6

    1.8 Testing Location ..... 7

    1.9 Test Software ..... 7

    1.10 Applicable Standards ..... 7

**2 TEST CONFIGURATION OF EQUIPMENT UNDER TEST ..... 8**

    2.1 Test Mode..... 8

    2.2 Connection Diagram of Test System ..... 8

    2.3 Support Unit used in test configuration ..... 9

    2.4 Measurement Results Explanation Example ..... 9

    2.5 Frequency List of Low/Middle/High Channels..... 9

**3 CONDUCTED TEST RESULT..... 10**

    3.1 Measuring Instruments..... 10

    3.2 Test Setup ..... 10

    3.3 Test Result of Conducted Test..... 10

    3.4 Conducted Output Power and EIRP ..... 11

    3.5 Peak-to-Average Ratio ..... 12

    3.6 99% Occupied Bandwidth and 26dB Bandwidth Measurement..... 13

    3.7 Conducted Band Edge ..... 14

    3.8 Conducted Spurious Emission ..... 15

    3.9 Frequency Stability..... 16

**4 RADIATED TEST ITEMS ..... 17**

    4.1 Measuring Instruments..... 17

    4.2 Test Setup ..... 17

    4.3 Test Result of Radiated Test..... 18

    4.4 Field Strength of Spurious Radiation Measurement ..... 19

**5 LIST OF MEASURING EQUIPMENT ..... 20**

**6 MEASUREMENT UNCERTAINTY ..... 21**

**APPENDIX A. TEST RESULTS OF CONDUCTED TEST**

**APPENDIX B. TEST RESULTS OF RADIATED TEST**

**APPENDIX C. TEST SETUP PHOTOGRAPHS**



### REVISION HISTORY

REPORT NO.	VERSION	DESCRIPTION	ISSUED DATE
FG352916-01A	Rev. 01	Initial issue of report	Jul. 25, 2023



### SUMMARY OF TEST RESULT

Report Section	FCC Rule	Description	Limit	Result	Remark
3.4	§2.1046	Conducted Output Power	-	Report Only	-
	§24.232(c)	Equivalent Isotropic Radiated Power	< 2 Watts	PASS	-
3.5	§24.232(d)	Peak-to-Average Ratio	< 13 dB	PASS	-
3.6	§2.1049	Occupied Bandwidth	Reporting Only	PASS	-
3.7	§2.1051 §24.238(a)	Band Edge Measurement	< 43+10log10(P[Watts])	PASS	-
3.8	§2.1051 §24.238(a)	Conducted Emission	< 43+10log10(P[Watts])	PASS	-
3.9	§2.1055 §24.235	Frequency Stability for Temperature & Voltage	Within Authorized Band		
4.4	§2.1053; §24.238(a);	Field Strength of Spurious Radiation	< 43+10log10(P[Watts])	PASS	Under limit 39.51 dB at 7515.000 MHz

**Conformity Assessment Condition:**

- The test results (PASS/FAIL) with all measurement uncertainty excluded are presented against the regulation limits or in accordance with the requirements stipulated by the applicant/manufacturer who shall bear all the risks of non-compliance that may potentially occur if measurement uncertainty is taken into account.
- The measurement uncertainty please refer to each test result in the section "Measurement Uncertainty"

**Disclaimer:**

The product specifications of the EUT presented in the test report that may affect the test assessments are declared by the manufacturer who shall take full responsibility for the authenticity.



# 1 General Description

## 1.1 Applicant

Motorola Mobility LLC  
222 W, Merchandise Mart Plaza, Chicago IL 60654 USA

## 1.2 Manufacturer

Motorola Mobility LLC  
222 W, Merchandise Mart Plaza, Chicago IL 60654 USA

## 1.3 Product Feature of Equipment Under Test

Product Feature	
Equipment	Mobile Cellular Phone
Brand Name	Motorola
Model Name	XT2343-2
FCC ID	IHDT56AM5
IMEI Code	Conducted: 353361230010276/353361230010284 Radiation: 353361260011019/353361260011027
HW Version	DVT2
SW Version	TTD33.32
EUT Stage	Identical Prototype

Remark: The above EUT's information was declared by manufacturer. Please refer to the specifications or user's manual for more detailed description.

## 1.4 Product Specification of Equipment Under Test

Standards-related Product Specification	
Tx Frequency	<b>WCDMA:</b> Band II: 1850 MHz ~ 1910 MHz
Rx Frequency	<b>WCDMA:</b> Band II: 1930 MHz ~ 1990 MHz
Maximum Output Power to Antenna	<b>WCDMA:</b> Band II: 22.64 dBm
Antenna Type	PIFA Antenna
Antenna Gain	PCS Band: -4.10 dBi
Type of Modulation	WCDMA: BPSK (Uplink) HSDPA: QPSK (Uplink) HSUPA: QPSK (Uplink) HSPA+ : 16QAM



### 1.5 Modification of EUT

No modifications are made to the EUT during all test items.

### 1.6 Maximum EIRP Power, and Emission Designator

FCC Rule	Frequency Band	Frequency Range (MHz)	Type of Modulation	Maximum EIRP (W)	Emission Designator
Part 24	WCDMA Band II	1852.4 ~ 1907.6	BPSK	0.0714	4M15F9W

### 1.7 Specification of Accessory

Specification of Accessory				
AC Adapter 1 (US)	Brand Name	Motorola(AOHAI)	Model Name	MC-101
AC Adapter 1 (EU)	Brand Name	Motorola(AOHAI)	Model Name	MC-102
AC Adapter 1 (UK)	Brand Name	Motorola(AOHAI)	Model Name	MC-103
AC Adapter 1 (AU)	Brand Name	Motorola(AOHAI)	Model Name	MC-105
AC Adapter 2 (US)	Brand Name	Motorola(Chenyang)	Model Name	MC-101
AC Adapter 2 (EU)	Brand Name	Motorola(Chenyang)	Model Name	MC-102
AC Adapter 2 (UK)	Brand Name	Motorola(Chenyang)	Model Name	MC-103
AC Adapter 2 (AU)	Brand Name	Motorola(Chenyang)	Model Name	MC-105
AC Adapter 3 (US)	Brand Name	Motorola(Salcomp)	Model Name	MC-101
AC Adapter 3 (EU)	Brand Name	Motorola(Salcomp)	Model Name	MC-102
AC Adapter 3 (UK)	Brand Name	Motorola(Salcomp)	Model Name	MC-103
AC Adapter 3 (AU)	Brand Name	Motorola(Salcomp)	Model Name	MC-105
AC Adapter 4 (US)	Brand Name	Motorola(Salcomp)	Model Name	MC-201L
AC Adapter 4 (EU)	Brand Name	Motorola(Salcomp)	Model Name	MC-202L
AC Adapter 4 (UK)	Brand Name	Motorola(Salcomp)	Model Name	MC-203L
AC Adapter 4 (AU)	Brand Name	Motorola(Salcomp)	Model Name	MC-205L
AC Adapter 5 (US)	Brand Name	Motorola(AOHAI)	Model Name	MC-201L
AC Adapter 5 (EU)	Brand Name	Motorola(AOHAI)	Model Name	MC-202L
AC Adapter 5 (UK)	Brand Name	Motorola(AOHAI)	Model Name	MC-203L
AC Adapter 5 (AU)	Brand Name	Motorola(AOHAI)	Model Name	MC-205L
AC Adapter 6 (US)	Brand Name	Motorola(Chenyang)	Model Name	MC-201L
AC Adapter 6 (EU)	Brand Name	Motorola(Chenyang)	Model Name	MC-202L
Battery 1	Brand Name	Motorola(ATL)	Model Name	PC50
Battery 2	Brand Name	Motorola (SCUD)	Model Name	PC50
USB Cable 1	Brand Name	Motorola (WASHIN)	Model Name	S928D92375
USB Cable 2	Brand Name	Motorola (Saibao)	Model Name	S928D95755



### 1.8 Testing Location

Sporton International Inc. (Kunshan) is accredited to ISO/IEC 17025:2017 by American Association for Laboratory Accreditation with Certificate Number 5145.02.

<b>Test Firm</b>	Sporton International Inc. (Kunshan)		
<b>Test Site Location</b>	No. 1098, Pengxi North Road, Kunshan Economic Development Zone Jiangsu Province 215300 People’s Republic of China TEL : +86-512-57900158		
<b>Test Site No.</b>	<b>Sporton Site No.</b>	<b>FCC Designation No.</b>	<b>FCC Test Firm Registration No.</b>
	CO01-KS 03CH04-KS	CN1257	314309

### 1.9 Test Software

Item	Site	Manufacturer	Name	Version
1.	03CH04-KS	AUDIX	E3	6.2009-8-24al

### 1.10 Applicable Standards

According to the specifications of the manufacturer, the EUT must comply with the requirements of the following standards:

- 47 CFR Part 2, 24(E)
- ANSI C63.26-2015
- FCC KDB 971168 D01 Power Meas. License Digital Systems v03r01
- FCC KDB 412172 D01 Determining ERP and EIRP v01r01

**Remark:**

1. All test items were verified and recorded according to the standards and without any deviation during the test.
2. This EUT has also been tested and complied with the requirements of FCC Part 15, Subpart B, recorded in a separate test report.

## 2 Test Configuration of Equipment Under Test

### 2.1 Test Mode

Antenna port conducted and radiated test items were performed according to KDB 971168 D01 Power Meas. License Digital Systems v03r01 with maximum output power.

Radiated measurements were performed with rotating EUT in different three orthogonal test planes to find the maximum emission.

Radiated emissions were investigated as following frequency range:

1. 30 MHz to 19100 MHz for WCDMA Band II

All modes and data rates and positions were investigated.

Test modes are chosen to be reported as the worst case configuration below:

Test Modes		
Band	Radiated TCs	Conducted TCs
WCDMA Band II	■ RMC 12.2Kbps Link	■ RMC 12.2Kbps Link

### 2.2 Connection Diagram of Test System

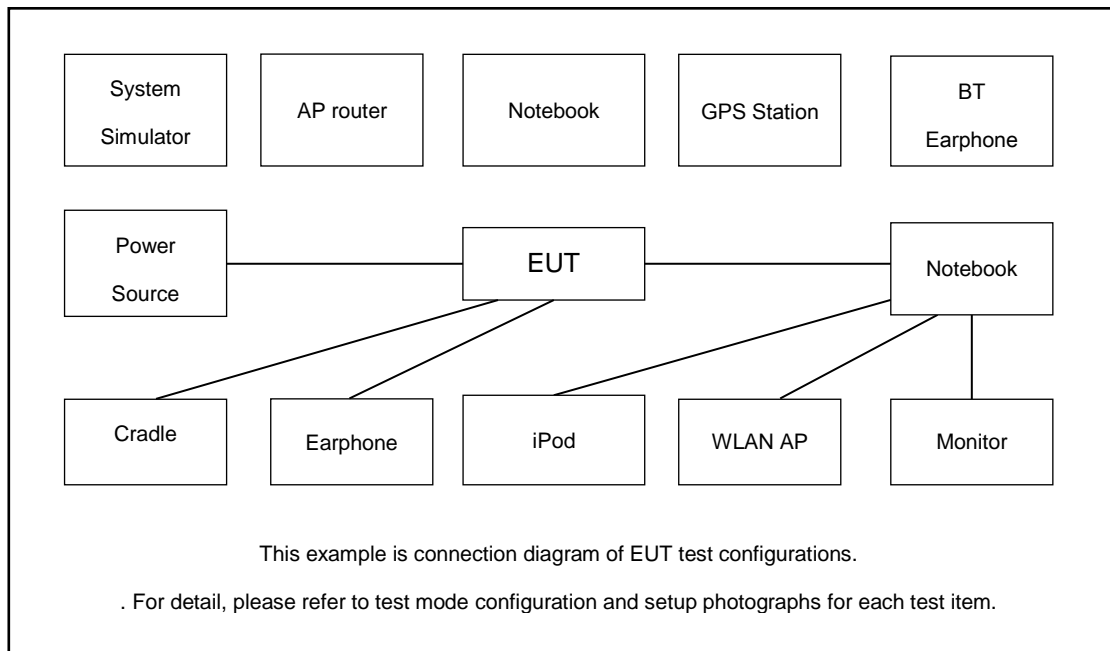

The EUT has been configuration operated in a manner tended to maximize its emission characteristics in a typical application.





### 2.3 Support Unit used in test configuration

Item	Equipment	Trade Name	Model No.	FCC ID	Data Cable	Power Cord
1.	LTE Base Station	Anritsu	MT8820/8821	N/A	N/A	Unshielded,1.8m
2.	Earphone	Motorola	N/A	N/A	Unshielded, 1.2m	N/A

### 2.4 Measurement Results Explanation Example

**For all conducted test items:**

The offset level is set in the spectrum analyzer to compensate the RF cable loss and attenuator factor between RF conducted output port and spectrum analyzer. With the offset compensation, the spectrum analyzer reading level will be exactly the RF output level.

The spectrum analyzer offset is derived from RF cable loss and attenuator factor.

$$\text{Offset} = \text{RF cable loss} + \text{attenuator factor}.$$

The following shows an offset computation example with RF cable loss 5.4 dB and a 10dB attenuator.

Example :

$$\begin{aligned} \text{Offset}(dB) &= \text{RF cable loss}(dB) + \text{attenuator factor}(dB). \\ &= 5.4 + 10 = 15.4 \text{ (dB)} \end{aligned}$$

### 2.5 Frequency List of Low/Middle/High Channels

Frequency List				
Band	Channel/Frequency(MHz)	Lowest	Middle	Highest
WCDMA Band II	Channel	9262	9400	9538
	Frequency	1852.4	1880.0	1907.6

### 3 Conducted Test Result

#### 3.1 Measuring Instruments

See list of measuring instruments of this test report.

#### 3.2 Test Setup

##### 3.2.1 Conducted Output Power

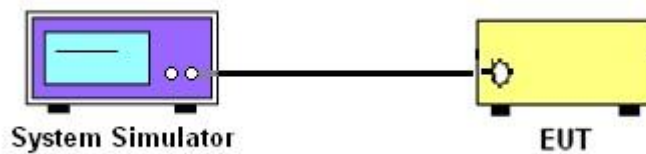

##### 3.2.2 Peak-to-Average Ratio, Occupied Bandwidth, Conducted Band-Edge and Conducted Spurious Emission

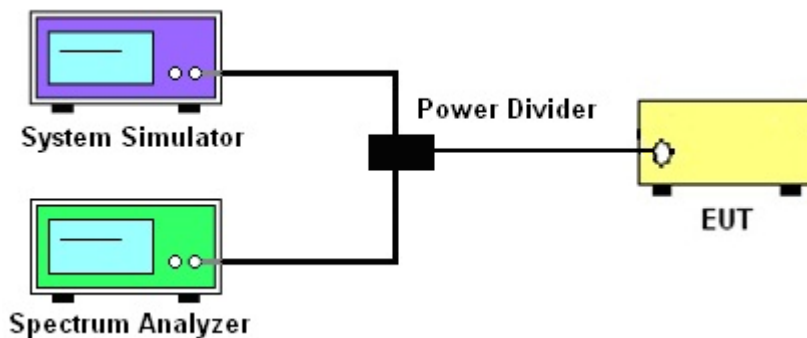

##### 3.2.3 Frequency Stability

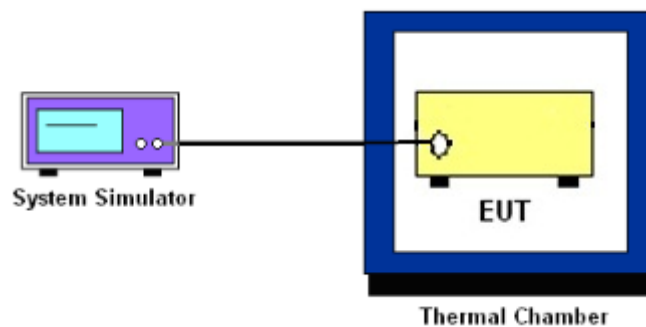

### 3.3 Test Result of Conducted Test

Please refer to Appendix A.



### 3.4 Conducted Output Power and EIRP

#### 3.4.1 Description of the Conducted Output Power and EIRP

A system simulator was used to establish communication with the EUT. Its parameters were set to enforce EUT transmitting at the maximum power. The measured power in the radio frequency on the transmitter output terminals shall be reported.

The EIRP of mobile transmitters must not exceed 2 Watts for WCDMA Band II.

According to KDB 412172 D01 Power Approach,

$EIRP = P_T + G_T - L_C$ ,  $ERP = EIRP - 2.15$ , where

$P_T$  = transmitter output power in dBm

$G_T$  = gain of the transmitting antenna in dBi

$L_C$  = signal attenuation in the connecting cable between the transmitter and antenna in dB

#### 3.4.2 Test Procedures

1. The testing follows ANSI C63.26 Section 5.2
2. The transmitter output port was connected to the system simulator.
3. Set EUT at maximum power through the system simulator.
4. Select lowest, middle, and highest channels for each band and different modulation.
5. Measure and record the power level from the system simulator.



## **3.5 Peak-to-Average Ratio**

### **3.5.1 Description of the PAR Measurement**

The peak-to-average ratio (PAR) of the transmission may not exceed 13 dB.

### **3.5.2 Test Procedures**

1. The testing follows ANSI C63.26 Section 5.2.3.4 (CCDF).
2. The EUT was connected to spectrum and system simulator via a power divider.
3. Set the CCDF (Complementary Cumulative Distribution Function) option in spectrum analyzer.
4. The highest RF powers were measured and recorded the maximum PAPR level associated with a probability of 0.1 %.
5. Record the deviation as Peak to Average Ratio.



### 3.6 99% Occupied Bandwidth and 26dB Bandwidth Measurement

#### 3.6.1 Description of 99% Occupied Bandwidth and 26dB Bandwidth Measurement

The occupied bandwidth is the width of a frequency band such that, below the lower and above the upper frequency limits, the mean powers emitted are each equal to a specified percentage 0.5% of the total mean transmitted power.

The 26 dB emission bandwidth is defined as the frequency range between two points, one above and one below the carrier frequency, at which the spectral density of the emission is attenuated 26 dB below the maximum in-band spectral density of the modulated signal. Spectral density (power per unit bandwidth) is to be measured with a detector of resolution bandwidth equal to approximately 1.0% of the emission bandwidth.

#### 3.6.2 Test Procedures

1. The testing follows ANSI C63.26 Section 5.4
2. The EUT was connected to spectrum analyzer and system simulator via a power divider.
3. The spectrum analyzer center frequency is set to the nominal EUT channel center frequency. The span range for the spectrum analyzer shall be between two and five times the anticipated OBW.
4. The nominal resolution bandwidth (RBW) shall be in the range of 1 to 5 % of the anticipated OBW, and the VBW shall be at least 3 times the RBW.
5. Set the detection mode to peak, and the trace mode to max hold.
6. Determine the reference value: Set the EUT to transmit a modulated signal. Allow the trace to stabilize. Set the spectrum analyzer marker to the highest level of the displayed trace. (this is the reference value)
7. Determine the “-26 dB down amplitude” as equal to (Reference Value – X).
8. Place two markers, one at the lowest and the other at the highest frequency of the envelope of the spectral display such that each marker is at or slightly below the “-X dB down amplitude” determined in step 6. If a marker is below this “-X dB down amplitude” value it shall be placed as close as possible to this value. The OBW is the positive frequency difference between the two markers.
9. Use the 99 % power bandwidth function of the spectrum analyzer and report the measured bandwidth.



## 3.7 Conducted Band Edge

### 3.7.1 Description of Conducted Band Edge Measurement

The power of any emission outside of the authorized operating frequency ranges must be lower than the transmitter power (P) by a factor of at least  $43 + 10 \log (P)$  dB.

### 3.7.2 Test Procedures

1. The testing follows ANSI C63.26 section 5.7
2. The EUT was connected to the spectrum analyzer and system simulator via a power divider.
3. The RF output of EUT was connected to the spectrum analyzer by an RF cable and attenuator. The path loss was compensated to the results for each measurement.
4. The band edges of low and high channels for the highest RF powers were measured.
5. The RF fundamental frequency should be excluded against the limit line in the operating frequency band.
6. The limit line is derived from  $43 + 10\log(P)$  dB below the transmitter power P(Watts)



## 3.8 Conducted Spurious Emission

### 3.8.1 Description of Conducted Spurious Emission Measurement

The power of any emission outside of the authorized operating frequency ranges must be lower than the transmitter power (P) by a factor of at least  $43 + 10 \log (P)$  dB.

It is measured by means of a calibrated spectrum analyzer and scanned from 30 MHz up to a frequency including its 10<sup>th</sup> harmonic.

### 3.8.2 Test Procedures

1. The testing follows ANSI C63.26 section 5.7
2. The EUT was connected to the spectrum analyzer and system simulator via a power divider.
3. The RF output of EUT was connected to the spectrum analyzer by an RF cable and attenuator. The path loss was compensated to the results for each measurement.
4. The middle channel for the highest RF power within the transmitting frequency was measured.
5. The conducted spurious emission for the whole frequency range was taken.
6. The RF fundamental frequency should be excluded against the limit line in the operating frequency band.
7. The limit line is derived from  $43 + 10\log(P)$  dB below the transmitter power P(Watts)



### 3.9 Frequency Stability

#### 3.9.1 Description of Frequency Stability Measurement

The frequency stability shall be measured by variation of ambient temperature and variation of primary supply voltage to ensure that the fundamental emission stays within the authorized frequency block. The frequency stability of the transmitter shall be maintained within  $\pm 0.00025\%$  ( $\pm 2.5\text{ppm}$ ) of the center frequency.

#### 3.9.2 Test Procedures for Temperature Variation

1. The testing follows ANSI C63.26 section 5.6.4
2. The EUT was set up in the thermal chamber and connected with the system simulator.
3. With power OFF, the temperature was decreased to  $-30^{\circ}\text{C}$  and the EUT was stabilized before testing. Power was applied and the maximum change in frequency was recorded within one minute.
4. With power OFF, the temperature was raised in  $10^{\circ}\text{C}$  step up to  $50^{\circ}\text{C}$ . The EUT was stabilized at each step for at least half an hour. Power was applied and the maximum frequency change was recorded within one minute.

#### 3.9.3 Test Procedures for Voltage Variation

1. The testing follows ANSI C63.26 section 5.6.5
2. The EUT was placed in a temperature chamber at  $20\pm 5^{\circ}\text{C}$  and connected with the system simulator.
3. The power supply voltage to the EUT was varied from 85% to 115% of the nominal value for other than hand carried battery equipment.
4. For hand carried, battery powered equipment, reduce the primary ac or dc supply voltage to the battery operating end point, which shall be specified by the manufacturer.
5. The variation in frequency was measured for the worst case.



## 4 Radiated Test Items

### 4.1 Measuring Instruments

See list of measuring instruments of this test report.

### 4.2 Test Setup

#### 4.2.1 For radiated test below 30MHz

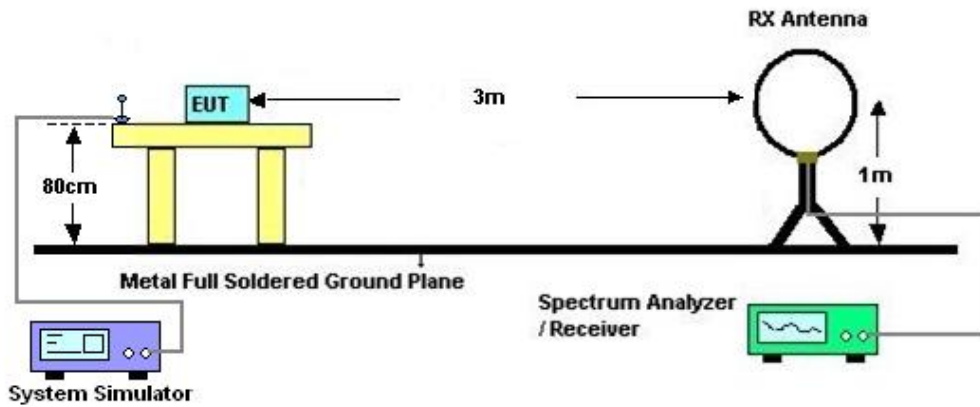

#### 4.2.2 For radiated test from 30MHz to 1GHz

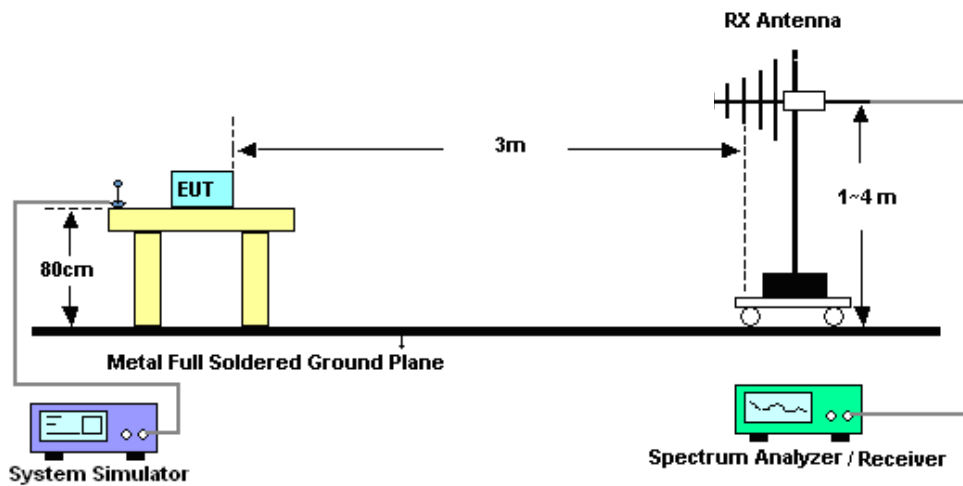

### 4.2.3 For radiated test above 1GHz

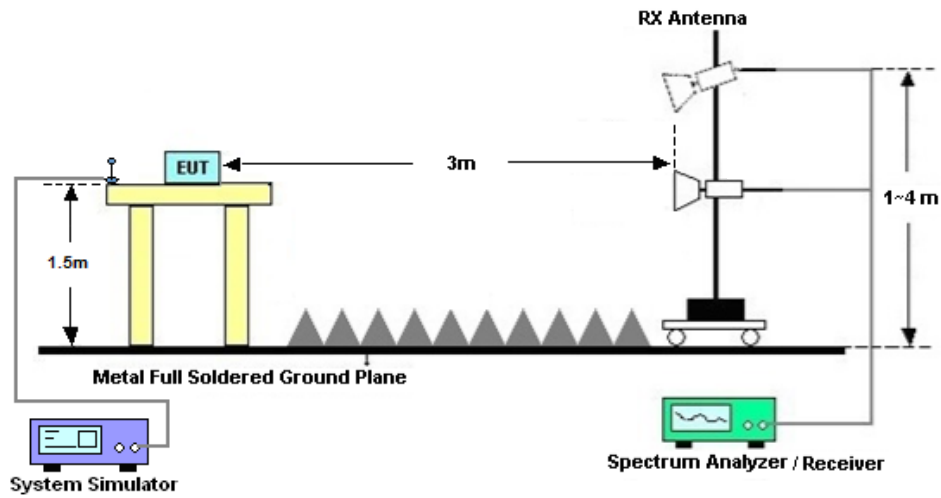

## 4.3 Test Result of Radiated Test

The low frequency, which started from 9 kHz to 30MHz, was pre-scanned and the result which was 20dB lower than the limit line was not reported.

Please refer to Appendix B.



## 4.4 Field Strength of Spurious Radiation Measurement

### 4.4.1 Description of Field Strength of Spurious Radiated Measurement

The power of any emission outside of the authorized operating frequency ranges must be attenuated below the transmitter power (P) by a factor of at least  $43 + 10 \log (P)$  dB. The spectrum is scanned from 30 MHz up to a frequency including its 10th harmonic.

### 4.4.2 Test Procedures

1. The testing follows ANSI C63.26 Section 5.5
2. The EUT was placed on a rotatable wooden table 0.8 meters for frequency below 1GHz and 1.5 meter for frequency above 1GHz above the ground.
3. The EUT was set 3 meters from the receiving antenna, which was mounted on the antenna tower.
4. The table was rotated 360 degrees to determine the position of the highest spurious emission.
5. The height of the receiving antenna is varied between one meter and four meters to search for the maximum spurious emission for both horizontal and vertical polarizations.
6. Make the measurement with the spectrum analyzer's RBW = 1MHz, VBW = 3MHz, taking record of maximum spurious emission.
7. A horn antenna was substituted in place of the EUT and was driven by a signal generator.
8. Tune the output power of signal generator to the same emission level with EUT maximum spurious emission.
9. Taking the record of output power at antenna port.
10. Repeat step 7 to step 8 for another polarization.
11.  $EIRP (dBm) = S.G. Power - Tx Cable Loss + Tx Antenna Gain$
12.  $ERP (dBm) = EIRP - 2.15$
13. The RF fundamental frequency should be excluded against the limit line in the operating frequency band.
14. The limit line is derived from  $43 + 10\log(P)$  dB below the transmitter power P(Watts)



## 5 List of Measuring Equipment

Instrument	Manufacturer	Model No.	Serial No.	Characteristics	Calibration Date	Test Date	Due Date	Remark
Spectrum Analyzer	R&S	FSV40	101040	10Hz~40GHz	Oct. 12, 2022	Jun. 26, 2023 ~Jun. 30, 2023	Oct. 11, 2023	Conducted (TH01-KS)
Power divider	STI	STI08-0055	-	0.5~40GHz	NCR	Jun. 26, 2023 ~Jun. 30, 2023	NCR	Conducted (TH01-KS)
Temperature & humidity	Hongzhan	LP-150U	H2014011440	-40~+150°C 20%~95%RH	Jul. 15, 2022	Jun. 26, 2023 ~Jun. 30, 2023	Jul. 14, 2023	Conducted (TH01-KS)
Temperature & humidity	Hongzhan	LP-150U	H2014011440	-40~+150°C 20%~95%RH	Jul. 06, 2023		Jul. 05, 2024	Conducted (TH01-KS)
EXA Spectrum Analyzer	Keysight	N9010B	MY57471079	10Hz~44G,MAX 30dB	Oct. 12, 2022	Jun. 29, 2023 ~Jul. 17, 2023	Oct. 11, 2023	Radiation (03CH04-KS)
Loop Antenna	R&S	HFH2-Z2E	101125	9kHz~30MHz	Sep. 22, 2022	Jun. 29, 2023 ~Jul. 17, 2023	Sep. 21, 2023	Radiation (03CH04-KS)
Bilog Antenna	TeseQ	CBL6111D	49922	30MHz-1GHz	Apr. 09, 2023	Jun. 29, 2023 ~Jul. 17, 2023	Apr. 08, 2024	Radiation (03CH04-KS)
Horn Antenna	Schwarzbeck	BBHA9120D	1284	1GHz~18GHz	Oct. 16, 2022	Jun. 29, 2023 ~Jul. 17, 2023	Oct. 15, 2023	Radiation (03CH04-KS)
SHF-EHF Horn	Com-power	AH-840	101070	18GHz~40GHz	Jan. 08, 2023	Jun. 29, 2023 ~Jul. 17, 2023	Jan. 07, 2024	Radiation (03CH04-KS)
Amplifier	SONOMA	310N	413740	9KHz-1GHz	Jan. 05, 2023	Jun. 29, 2023 ~Jul. 17, 2023	Jan. 04, 2024	Radiation (03CH04-KS)
Amplifier	MITEQ	EM18G40G GA	060728	18~40GHz	Jan. 05, 2023	Jun. 29, 2023 ~Jul. 17, 2023	Jan. 04, 2024	Radiation (03CH04-KS)
high gain Amplifier	EM	EM01G18G A	060840	1Ghz-18Ghz	Oct. 12, 2022	Jun. 29, 2023 ~Jul. 17, 2023	Oct. 11, 2023	Radiation (03CH04-KS)
Amplifier	Agilent	8449B	3008A02370	1Ghz-18Ghz	Oct. 12, 2022	Jun. 29, 2023 ~Jul. 17, 2023	Oct. 11, 2023	Radiation (03CH04-KS)
AC Power Source	Chroma	61601	F104090004	N/A	NCR	Jun. 29, 2023 ~Jul. 17, 2023	NCR	Radiation (03CH04-KS)
Turn Table	ChamPro	EM 1000-T	060762-T	0~360 degree	NCR	Jun. 29, 2023 ~Jul. 17, 2023	NCR	Radiation (03CH04-KS)
Antenna Mast	ChamPro	EM 1000-A	060762-A	1 m~4 m	NCR	Jun. 29, 2023 ~Jul. 17, 2023	NCR	Radiation (03CH04-KS)

NCR: No Calibration Required



## 6 Measurement Uncertainty

The measurement uncertainties shown below were calculated in accordance with the requirements of ANSI 63.26-2015. All the measurement uncertainty value were shown with a coverage K=2 to indicate 95% level of confidence. The measurement data show herein meets or exceeds the CISPR measurement uncertainty values specified in CISPR 16-4-2 and can be compared directly to specified limit to determine compliance.

### Uncertainty of Conducted Measurement

Test Item	Uncertainty
Conducted Power	±0.46 dB
Conducted Emissions	±0.48 dB
Occupied Channel Bandwidth	±0.1 %

### Uncertainty of Radiated Emission Measurement (30 MHz ~ 1000 MHz)

Measuring Uncertainty for a Level of Confidence of 95% (U = 2Uc(y))	6.3dB
---	-------

### Uncertainty of Radiated Emission Measurement (1 GHz ~ 18 GHz)

Measuring Uncertainty for a Level of Confidence of 95% (U = 2Uc(y))	4.9dB
---	-------

### Uncertainty of Radiated Emission Measurement (18 GHz ~ 40 GHz)

Measuring Uncertainty for a Level of Confidence of 95% (U = 2Uc(y))	5.3dB
---	-------

----- THE END -----



### Appendix A. Test Results of Conducted Test

Test Engineer :	Simle Wang	Temperature :	22~23°C
		Relative Humidity :	40~42%

#### Conducted Output Power(Average power)

Band		WCDMA II			EIRP(W)		
TX Channel		9262	9400	9538			
Rx Channel		9662	9800	9938			
Frequency (MHz)		1852.4	1880	1907.6	L	M	H
3GPP Rel 99	AMR 12.2Kbps	22.54	22.61	22.52	0.0698	0.0710	0.0695
3GPP Rel 99	RMC 12.2Kbps	22.57	22.64	22.62	0.0703	0.0714	0.0711
3GPP Rel 6	HSDPA Subtest-1	21.56	21.71	21.59	0.0557	0.0577	0.0561
3GPP Rel 6	HSDPA Subtest-2	21.56	21.57	21.54	0.0557	0.0558	0.0555
3GPP Rel 6	HSDPA Subtest-3	21.08	21.19	21.11	0.0499	0.0512	0.0502
3GPP Rel 6	HSDPA Subtest-4	21.00	21.06	21.06	0.0490	0.0497	0.0497
3GPP Rel 8	DC-HSDPA Subtest-1	21.55	21.65	21.57	0.0556	0.0569	0.0558
3GPP Rel 8	DC-HSDPA Subtest-2	21.44	21.63	21.47	0.0542	0.0566	0.0546
3GPP Rel 8	DC-HSDPA Subtest-3	20.99	21.17	21.06	0.0489	0.0509	0.0497
3GPP Rel 8	DC-HSDPA Subtest-4	20.97	21.07	20.98	0.0486	0.0498	0.0488
3GPP Rel 6	HSUPA Subtest-1	21.44	21.59	21.54	0.0542	0.0561	0.0555
3GPP Rel 6	HSUPA Subtest-2	19.57	19.69	19.58	0.0352	0.0362	0.0353
3GPP Rel 6	HSUPA Subtest-3	20.70	20.73	20.68	0.0457	0.0460	0.0455
3GPP Rel 6	HSUPA Subtest-4	19.48	19.60	19.47	0.0345	0.0355	0.0344
3GPP Rel 6	HSUPA Subtest-5	21.47	21.64	21.52	0.0546	0.0568	0.0552
3GPP Rel 7	HSPA+ (16QAM) Subtest-1	19.11	19.31	19.13	0.0317	0.0332	0.0318



## WCDMA

### Peak-to-Average Ratio

Mode	WCDMA Band II	Limit: 13dB
Mod.	RMC 12.2Kbps	Result
Lowest CH	3.07	<b>PASS</b>
Middle CH	3.07	
Highest CH	2.96	



WCDMA Band II (RMC 12.2Kbps)

Lowest Channel

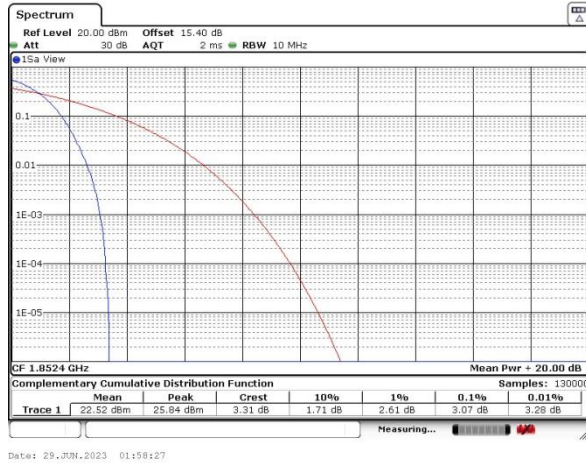

Date: 29 JUN 2023 01:58:27

Middle Channel



Date: 29 JUN 2023 01:58:34

Highest Channel



Date: 29 JUN 2023 01:58:42





**26dB Bandwidth**

Mode	WCDMA Band II (MHz)
Mod.	RMC 12.2Kbps
Lowest CH	4.685
Middle CH	4.685
Highest CH	4.685



WCDMA Band II (RMC 12.2Kbps)

Lowest Channel

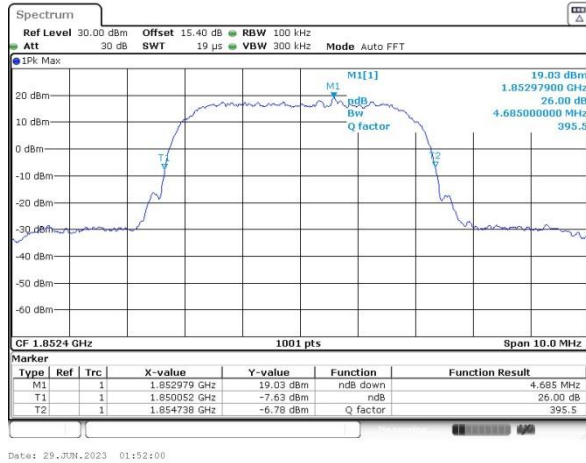

Middle Channel

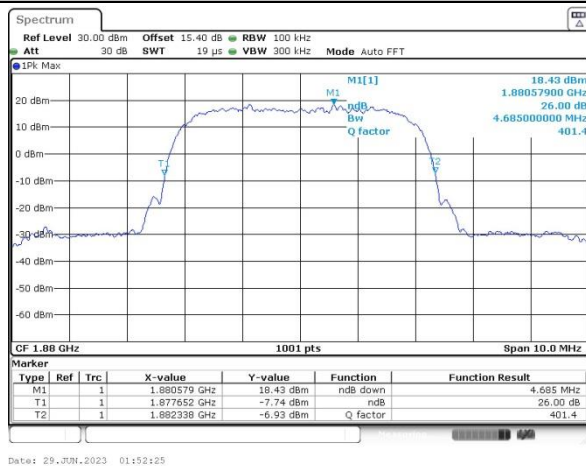

Highest Channel

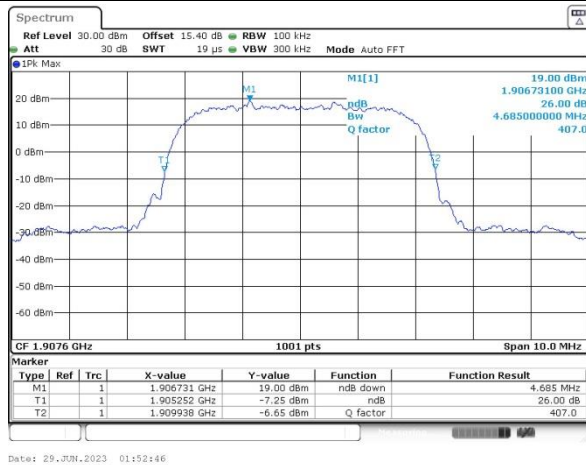



## Occupied Bandwidth

Mode	WCDMA Band II (MHz)
Mod.	RMC 12.2Kbps
Lowest CH	4.146
Middle CH	4.146
Highest CH	4.136



### WCDMA Band II (RMC 12.2Kbps)

#### Lowest Channel

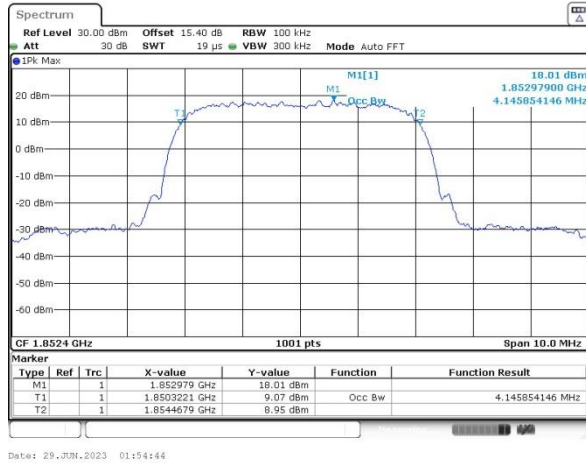

Date: 29 JUN 2023 01:54:44

#### Middle Channel

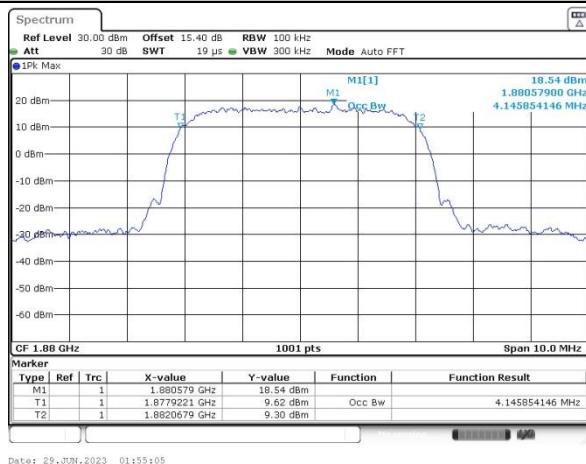

Date: 29 JUN 2023 01:55:05

#### Highest Channel

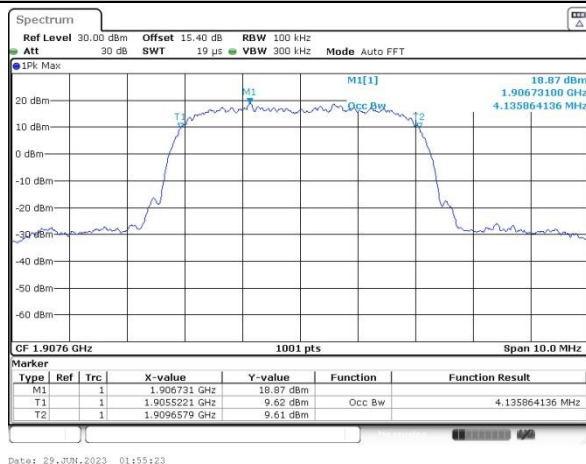

Date: 29 JUN 2023 01:55:23



# Conducted Band Edge

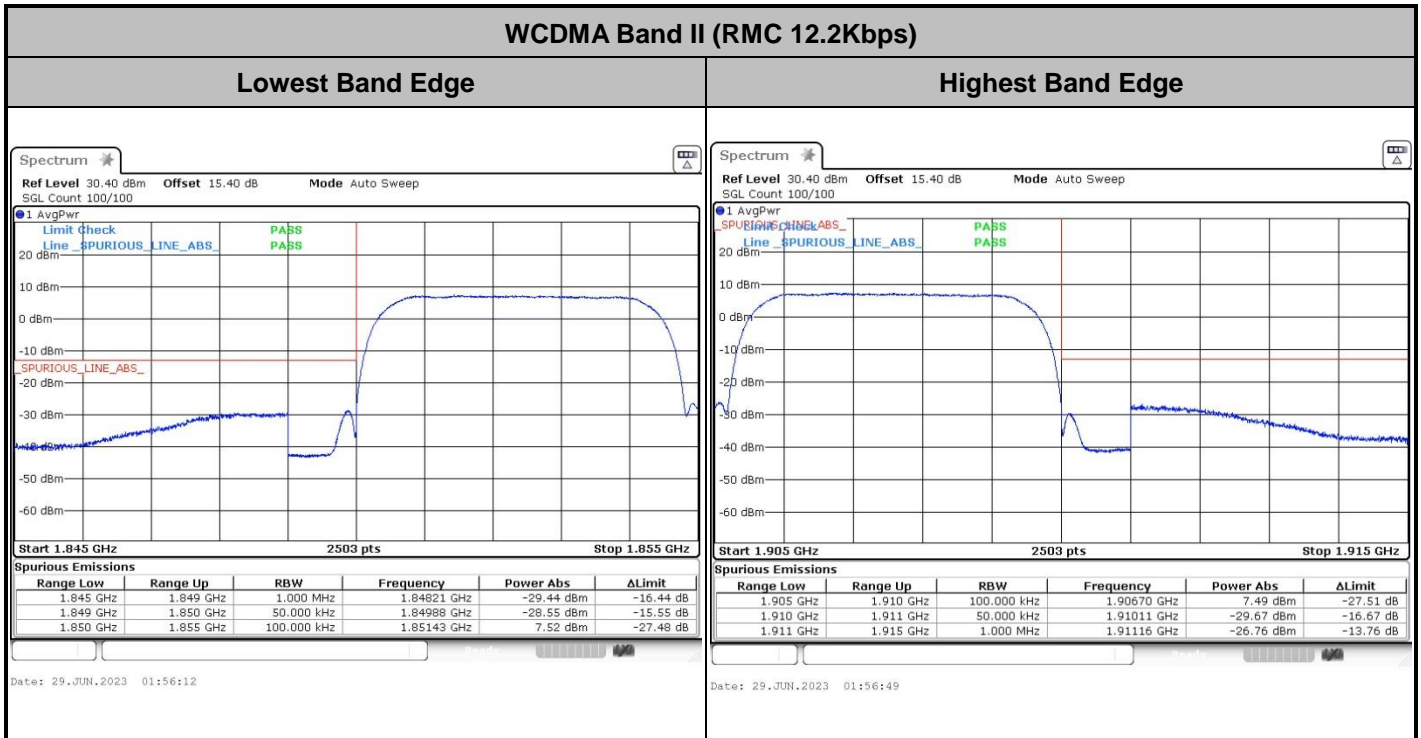



# Conducted Spurious Emission

## WCDMA Band II (RMC 12.2Kbps)

### Lowest Channel

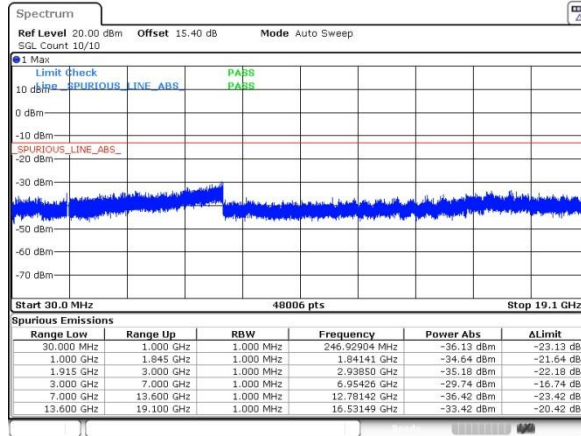

Date: 29 JUN 2023 01:57:22

### Middle Channel

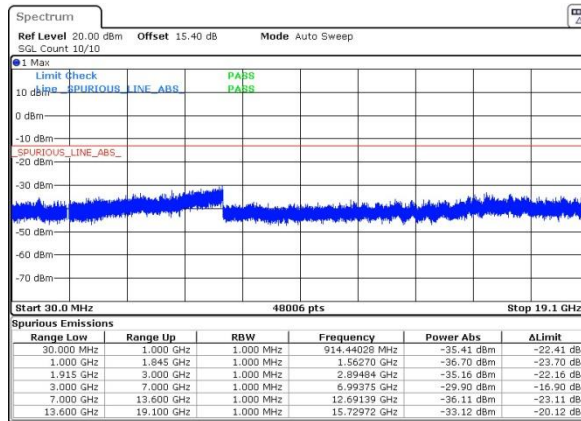

Date: 29 JUN 2023 01:57:45

### Highest Channel

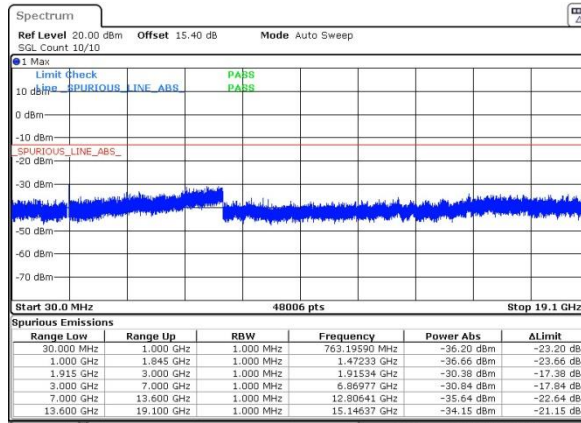

Date: 29 JUN 2023 01:58:09



### Frequency Stability

Test Conditions	Middle Channel	WCDMA Band II (RMC 12.2Kbps)	Limit Note 2.
Temperature (°C)	Voltage (Volt)	Deviation (ppm)	Result
50	Normal Voltage	0.0032	PASS
40	Normal Voltage	0.0034	
30	Normal Voltage	0.0058	
20(Ref.)	Normal Voltage	0.0000	
10	Normal Voltage	0.0069	
0	Normal Voltage	0.0012	
-10	Normal Voltage	0.0026	
-20	Normal Voltage	0.0048	
-30	Normal Voltage	0.0086	
20	Maximum Voltage	0.0091	
20	Normal Voltage	0.0025	
20	Battery End Point	0.0062	

**Note:**

1. Normal Voltage = 3.91V ; Battery End Point (BEP) =3.60V ; Maximum Voltage =4.45V
2. The frequency fundamental emissions stay within the authorized frequency block based on the frequency deviation measured is small.



## Appendix B. Test Results of Radiated Test

### Radiated Spurious Emission

Test Engineer :	Simle Wang	Temperature :	22~23°C
		Relative Humidity :	40~42%

WCDMA Band II(RMC 12.2Kbps)								
Channel	Frequency ( MHz )	EIRP ( dBm )	Limit ( dBm )	Over Limit ( dB )	S.G. Power ( dBm )	TX Cable loss ( dB )	TX Antenna Gain (dBi)	Polarization (H/V)
Middle	3765	-57.60	-13	-44.60	-69.86	2.64	14.90	H
	5640	-55.49	-13	-42.49	-67.35	2.94	14.80	H
	7515	-52.77	-13	-39.77	-62.54	3.39	13.16	H
	3765	-57.48	-13	-44.48	-69.74	2.64	14.90	V
	5640	-56.03	-13	-43.03	-67.89	2.94	14.80	V
	7515	-52.51	-13	-39.51	-62.28	3.39	13.16	V

Remark: Spurious emissions within 30-1000MHz were found more than 20dB below limit line.