



Accredited by the Swiss Accreditation Service (SAS)  
The Swiss Accreditation Service is one of the signatories to the EA  
Multilateral Agreement for the recognition of calibration certificates

Accreditation No.: **SCS 0108**

Client **Sporton**

Certificate No: **D750V3-1087\_Feb22**

## CALIBRATION CERTIFICATE

Object **D750V3 - SN:1087**

Calibration procedure(s) **QA CAL-05.v11  
Calibration Procedure for SAR Validation Sources between 0.7-3 GHz**

Calibration date: **February 24, 2022**

This calibration certificate documents the traceability to national standards, which realize the physical units of measurements (SI).  
The measurements and the uncertainties with confidence probability are given on the following pages and are part of the certificate.

All calibrations have been conducted in the closed laboratory facility: environment temperature ( $22 \pm 3$ )°C and humidity < 70%.

Calibration Equipment used (M&TE critical for calibration)

| Primary Standards               | ID #               | Cal Date (Certificate No.)        | Scheduled Calibration  |
|---------------------------------|--------------------|-----------------------------------|------------------------|
| Power meter NRP                 | SN: 104778         | 09-Apr-21 (No. 217-03291/03292)   | Apr-22                 |
| Power sensor NRP-Z91            | SN: 103244         | 09-Apr-21 (No. 217-03291)         | Apr-22                 |
| Power sensor NRP-Z91            | SN: 103245         | 09-Apr-21 (No. 217-03292)         | Apr-22                 |
| Reference 20 dB Attenuator      | SN: BH9394 (20k)   | 09-Apr-21 (No. 217-03343)         | Apr-22                 |
| Type-N mismatch combination     | SN: 310982 / 06327 | 09-Apr-21 (No. 217-03344)         | Apr-22                 |
| Reference Probe EX3DV4          | SN: 7349           | 31-Dec-21 (No. EX3-7349_Dec21)    | Dec-22                 |
| DAE4                            | SN: 601            | 01-Nov-21 (No. DAE4-601_Nov21)    | Nov-22                 |
| Secondary Standards             | ID #               | Check Date (in house)             | Scheduled Check        |
| Power meter E4419B              | SN: GB39512475     | 30-Oct-14 (in house check Oct-20) | In house check: Oct-22 |
| Power sensor HP 8481A           | SN: US37292783     | 07-Oct-15 (in house check Oct-20) | In house check: Oct-22 |
| Power sensor HP 8481A           | SN: MY41093315     | 07-Oct-15 (in house check Oct-20) | In house check: Oct-22 |
| RF generator R&S SMT-06         | SN: 100972         | 15-Jun-15 (in house check Oct-20) | In house check: Oct-22 |
| Network Analyzer Agilent E8358A | SN: US41080477     | 31-Mar-14 (in house check Oct-20) | In house check: Oct-22 |

Calibrated by: **Joanna Lleshaj** Laboratory Technician

Approved by: **Niels Kuster** Quality Manager

Issued: March 2, 2022

This calibration certificate shall not be reproduced except in full without written approval of the laboratory.



Accredited by the Swiss Accreditation Service (SAS)

The Swiss Accreditation Service is one of the signatories to the EA Multilateral Agreement for the recognition of calibration certificates

Accreditation No.: **SCS 0108**

### Glossary:

|       |                                 |
|-------|---------------------------------|
| TSL   | tissue simulating liquid        |
| ConvF | sensitivity in TSL / NORM x,y,z |
| N/A   | not applicable or not measured  |

### Calibration is Performed According to the Following Standards:

- a) IEC/IEEE 62209-1528, "Measurement Procedure For The Assessment Of Specific Absorption Rate Of Human Exposure To Radio Frequency Fields From Hand-Held And Body-Worn Wireless Communication Devices - Part 1528: Human Models, Instrumentation And Procedures (Frequency Range of 4 MHz to 10 GHz)", October 2020.
- b) KDB 865664, "SAR Measurement Requirements for 100 MHz to 6 GHz"

### Additional Documentation:

- c) DASY System Handbook

### Methods Applied and Interpretation of Parameters:

- *Measurement Conditions:* Further details are available from the Validation Report at the end of the certificate. All figures stated in the certificate are valid at the frequency indicated.
- *Antenna Parameters with TSL:* The source is mounted in a touch configuration below the center marking of the flat phantom.
- *Return Loss:* This parameter is measured with the source positioned under the liquid filled phantom (as described in the measurement condition clause). The Return Loss ensures low reflected power. No uncertainty required.
- *SAR measured:* SAR measured at the stated antenna input power.
- *SAR normalized:* SAR as measured, normalized to an input power of 1 W at the antenna connector.
- *SAR for nominal TSL parameters:* The measured TSL parameters are used to calculate the nominal SAR result.

The reported uncertainty of measurement is stated as the standard uncertainty of measurement multiplied by the coverage factor  $k=2$ , which for a normal distribution corresponds to a coverage probability of approximately 95%.

## Measurement Conditions

DASY system configuration, as far as not given on page 1.

|                              |                        |             |
|------------------------------|------------------------|-------------|
| DASY Version                 | DASY52                 | V52.10.4    |
| Extrapolation                | Advanced Extrapolation |             |
| Phantom                      | Modular Flat Phantom   |             |
| Distance Dipole Center - TSL | 15 mm                  | with Spacer |
| Zoom Scan Resolution         | dx, dy, dz = 5 mm      |             |
| Frequency                    | 750 MHz $\pm$ 1 MHz    |             |

## Head TSL parameters

The following parameters and calculations were applied.

|   | Temperature         | Permittivity   | Conductivity         |
|---|---------------------|----------------|----------------------|
| Nominal Head TSL parameters             | 22.0 °C             | 41.9           | 0.89 mho/m           |
| Measured Head TSL parameters            | (22.0 $\pm$ 0.2) °C | 42.4 $\pm$ 6 % | 0.89 mho/m $\pm$ 6 % |
| Head TSL temperature change during test | < 0.5 °C            | ----           | ----                 |

## SAR result with Head TSL

| SAR averaged over 1 cm <sup>3</sup> (1 g) of Head TSL | Condition          |  |
|---|--------------------|--|
| SAR measured  | 250 mW input power | 2.14 W/kg                                      |
| SAR for nominal Head TSL parameters                   | normalized to 1W   | <b>8.58 W/kg <math>\pm</math> 17.0 % (k=2)</b> |

| SAR averaged over 10 cm <sup>3</sup> (10 g) of Head TSL | condition          |  |
|---|--------------------|--|
| SAR measured  | 250 mW input power | 1.41 W/kg                                      |
| SAR for nominal Head TSL parameters                     | normalized to 1W   | <b>5.65 W/kg <math>\pm</math> 16.5 % (k=2)</b> |

## Appendix (Additional assessments outside the scope of SCS 0108)

### Antenna Parameters with Head TSL

|                                      |                                |
|--------------------------------------|--------------------------------|
| Impedance, transformed to feed point | 52.6 $\Omega$ - 2.5 j $\Omega$ |
| Return Loss                          | - 29.1 dB                      |

### General Antenna Parameters and Design

|                                  |          |
|----------------------------------|----------|
| Electrical Delay (one direction) | 1.034 ns |
|----------------------------------|----------|

After long term use with 100W radiated power, only a slight warming of the dipole near the feedpoint can be measured.

The dipole is made of standard semirigid coaxial cable. The center conductor of the feeding line is directly connected to the second arm of the dipole. The antenna is therefore short-circuited for DC-signals. On some of the dipoles, small end caps are added to the dipole arms in order to improve matching when loaded according to the position as explained in the "Measurement Conditions" paragraph. The SAR data are not affected by this change. The overall dipole length is still according to the Standard.

No excessive force must be applied to the dipole arms, because they might bend or the soldered connections near the feedpoint may be damaged.

### Additional EUT Data

|                 |       |
|-----------------|-------|
| Manufactured by | SPEAG |
|-----------------|-------|

## DASY5 Validation Report for Head TSL

Date: 24.02.2022

Test Laboratory: SPEAG, Zurich, Switzerland

**DUT: Dipole 750 MHz; Type: D750V3; Serial: D750V3 - SN:1087**

Communication System: UID 0 - CW; Frequency: 750 MHz

Medium parameters used:  $f = 750$  MHz;  $\sigma = 0.89$  S/m;  $\epsilon_r = 42.4$ ;  $\rho = 1000$  kg/m<sup>3</sup>

Phantom section: Flat Section

Measurement Standard: DASY5 (IEEE/IEC/ANSI C63.19-2011)

DASY52 Configuration:

- Probe: EX3DV4 - SN7349; ConvF(10.11, 10.11, 10.11) @ 750 MHz; Calibrated: 31.12.2021
- Sensor-Surface: 1.4mm (Mechanical Surface Detection)
- Electronics: DAE4 Sn601; Calibrated: 01.11.2021
- Phantom: Flat Phantom 4.9 (front); Type: QD 00L P49 AA; Serial: 1001
- DASY52 52.10.4(1535); SEMCAD X 14.6.14(7501)

**Dipole Calibration for Head Tissue/Pin=250 mW, d=15mm/Zoom Scan (7x7x7)/Cube 0:**

Measurement grid: dx=5mm, dy=5mm, dz=5mm

Reference Value = 59.64 V/m; Power Drift = -0.03 dB

Peak SAR (extrapolated) = 3.22 W/kg

SAR(1 g) = 2.14 W/kg; SAR(10 g) = 1.41 W/kg

Smallest distance from peaks to all points 3 dB below = 17 mm

Ratio of SAR at M2 to SAR at M1 = 66.5%

Maximum value of SAR (measured) = 2.83 W/kg

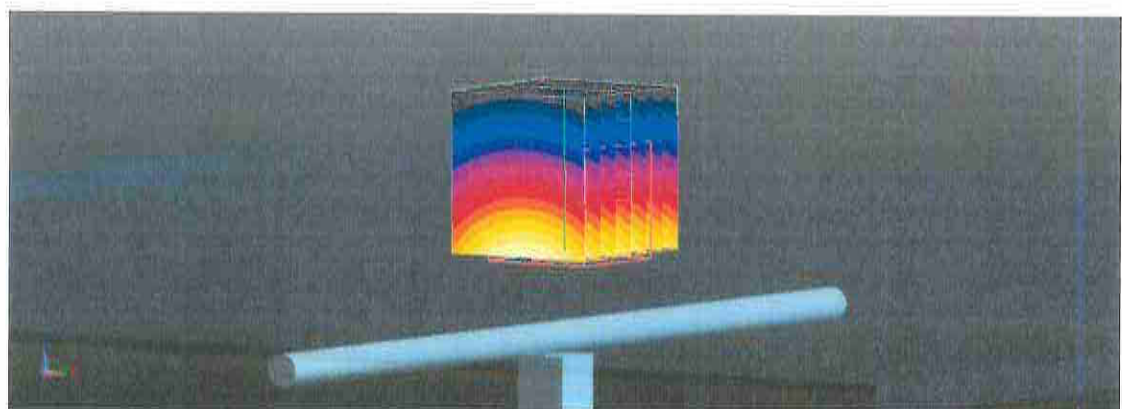
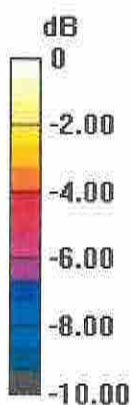

0 dB = 2.83 W/kg = 4.52 dBW/kg

# Impedance Measurement Plot for Head TSL

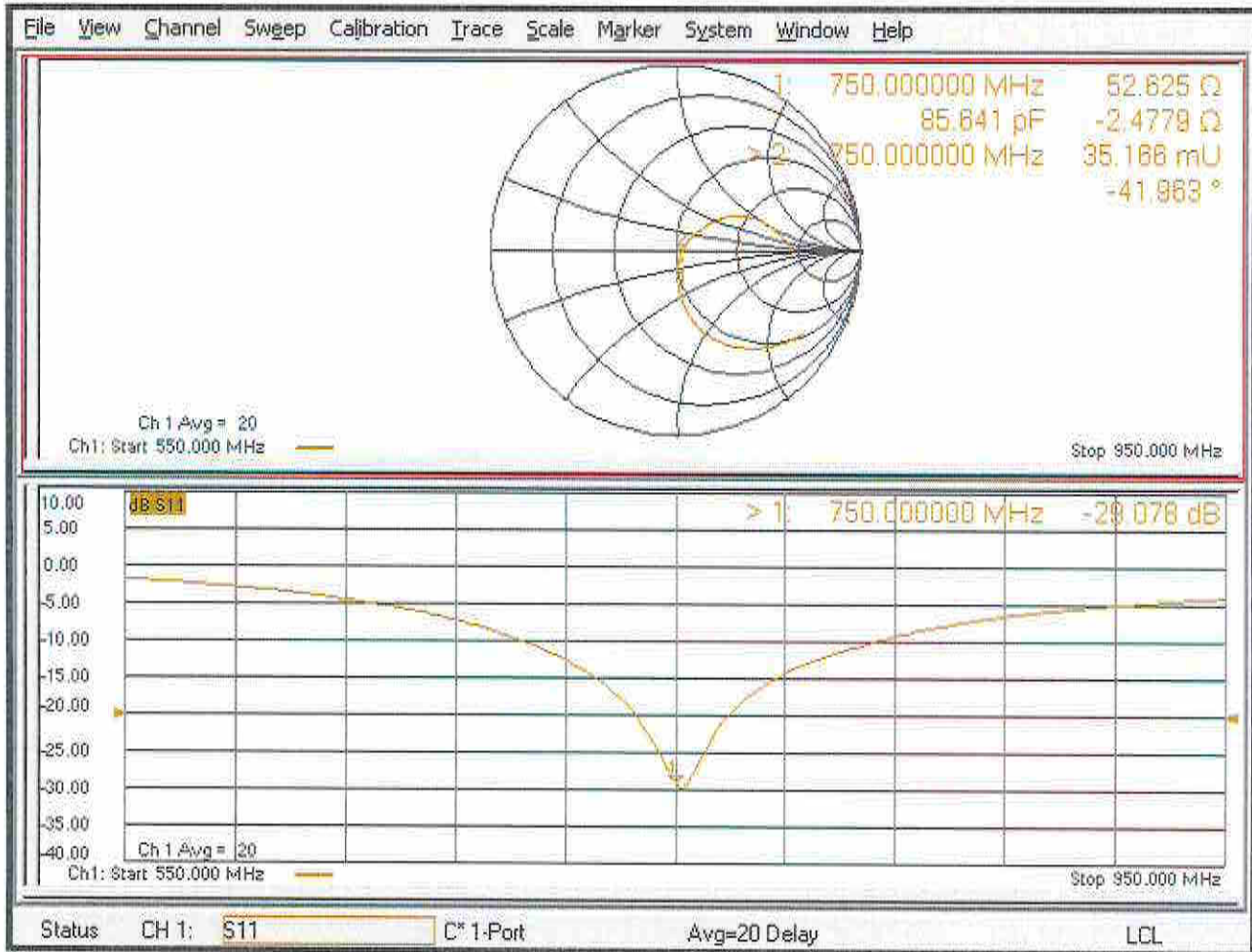

## D750V3, Serial No. 1087 Extended Dipole Calibrations

Referring to KDB 865664 D01 v01r02, if dipoles are verified in return loss (<-20dB, within 20% of prior calibration), and in impedance (within 5 ohm of prior calibration), the annual calibration is not necessary and the calibration interval can be extended.

| D750V3 – serial no. 1087 |                  |           |                      |             |                           |             |
|--------------------------|------------------|-----------|----------------------|-------------|---------------------------|-------------|
| 750 Head                 |                  |           |                      |             |                           |             |
| Date of Measurement      | Return-Loss (dB) | Delta (%) | Real Impedance (ohm) | Delta (ohm) | Imaginary Impedance (ohm) | Delta (ohm) |
| 2022.2.24                | -29.078          |           | 52.625               |             | -2.4779                   |             |
| 2023.2.23                | -25.021          | -13.95    | 49.974               | 2.651       | -5.5764                   | 3.0985      |

### <Justification of the extended calibration>

The return loss is < -20dB, within 20% of prior calibration; the impedance is within 5 ohm of prior calibration. Therefore the verification result should support extended calibration.

### Dipole Verification Data> D750V3, serial no. 1087

#### 750MHz - Head

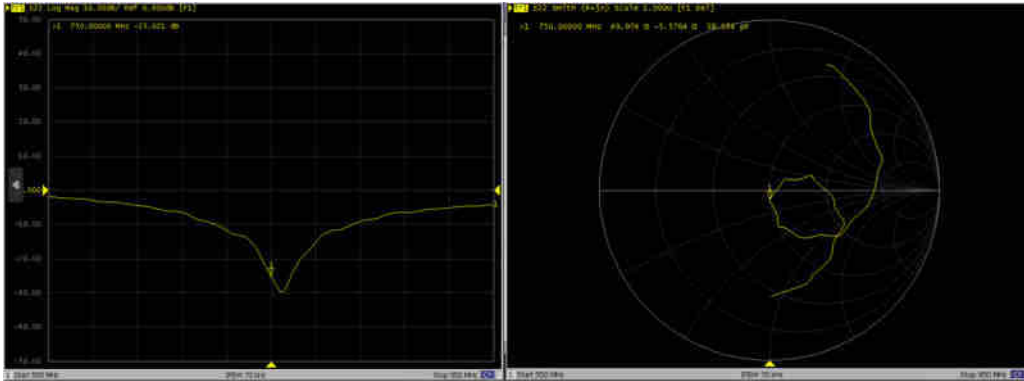

Add: No.52 HuaYuanBei Road, Haidian District, Beijing, 100191  
Tel: +86-10-62304633-2117  
E-mail: emf@caict.ac.cn http://www.caict.ac.cn

Client **Sporton**

Certificate No: **Z22-60301**

## CALIBRATION CERTIFICATE

Object **D835V2 - SN: 4d091**

Calibration Procedure(s) **FF-Z11-003-01**  
Calibration Procedures for dipole validation kits



Calibration date: **August 19, 2022**

This calibration Certificate documents the traceability to national standards, which realize the physical units of measurements (SI). The measurements and the uncertainties with confidence probability are given on the following pages and are part of the certificate.

All calibrations have been conducted in the closed laboratory facility: environment temperature (22±3)°C and humidity<70%.

Calibration Equipment used (M&TE critical for calibration)

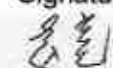
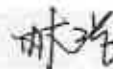
| Primary Standards       | ID #       | Cal Date (Calibrated by, Certificate No.) | Scheduled Calibration |
|-------------------------|------------|---|-----------------------|
| Power Meter NRP2        | 106277     | 24-Sep-21 (CTTL, No.J21X08326)            | Sep-22                |
| Power sensor NRP8S      | 104291     | 24-Sep-21 (CTTL, No.J21X08326)            | Sep-22                |
| Reference Probe EX3DV4  | SN 7464    | 26-Jan-22(SPEAG,No.EX3-7464_Jan22)        | Jan-23                |
| DAE4                    | SN 1556    | 12-Jan-22(CTTL-SPEAG,No.Z22-60007)        | Jan-23                |
| Secondary Standards     | ID #       | Cal Date (Calibrated by, Certificate No.) | Scheduled Calibration |
| Signal Generator E4438C | MY49071430 | 13-Jan-22 (CTTL, No.J22X00409)            | Jan-23                |
| Network Analyzer E5071C | MY46110673 | 14-Jan-22 (CTTL, No.J22X00406)            | Jan-23                |

|                | Name        | Function           | Signature   |
|----------------|-------------|--------------------|---|
| Calibrated by: | Zhao Jing   | SAR Test Engineer  |  |
| Reviewed by:   | Lin Hao     | SAR Test Engineer  |  |
| Approved by:   | Qi Dianyuan | SAR Project Leader |  |

Issued: August 23, 2022

This calibration certificate shall not be reproduced except in full without written approval of the laboratory.





Add: No.52 HuaYuanBei Road, Haidian District, Beijing, 100191, China  
Tel: +86-10-62304633-2117  
E-mail: emf@caict.ac.cn <http://www.caict.ac.cn>

### Glossary:

|       |  |
|-------|--|
| TSL   | tissue simulating liquid                   |
| ConvF | sensitivity in TSL / NORM <sub>x,y,z</sub> |
| N/A   | not applicable or not measured             |

### Calibration is Performed According to the Following Standards:

- IEC/IEEE 62209-1528, "Measurement Procedure for The Assessment of Specific Absorption Rate of Human Exposure to Radio Frequency Fields from Hand-held and Body-mounted Wireless Communication Devices- Part 1528: Human Models, Instrumentation and Procedures (Frequency range of 4 MHz to 10 GHz)", October 2020
- KDB 865664, "SAR Measurement Requirements for 100 MHz to 6 GHz"

### Additional Documentation:

- DASY4/5 System Handbook

### Methods Applied and Interpretation of Parameters:

- Measurement Conditions:** Further details are available from the Validation Report at the end of the certificate. All figures stated in the certificate are valid at the frequency indicated.
- Antenna Parameters with TSL:** The dipole is mounted with the spacer to position its feed point exactly below the center marking of the flat phantom section, with the arms oriented parallel to the body axis.
- Feed Point Impedance and Return Loss:** These parameters are measured with the dipole positioned under the liquid filled phantom. The impedance stated is transformed from the measurement at the SMA connector to the feed point. The Return Loss ensures low reflected power. No uncertainty required.
- Electrical Delay:** One-way delay between the SMA connector and the antenna feed point. No uncertainty required.
- SAR measured:** SAR measured at the stated antenna input power.
- SAR normalized:** SAR as measured, normalized to an input power of 1 W at the antenna connector.
- SAR for nominal TSL parameters:** The measured TSL parameters are used to calculate the nominal SAR result.

The reported uncertainty of measurement is stated as the standard uncertainty of Measurement multiplied by the coverage factor  $k=2$ , which for a normal distribution Corresponds to a coverage probability of approximately 95%.



Add: No.52 HuaYuanBei Road, Haidian District, Beijing, 100191, China  
Tel: +86-10-62304633-2117  
E-mail: emf@caict.ac.cn <http://www.caict.ac.cn>

### Measurement Conditions

DASY system configuration, as far as not given on page 1.

|                              |                          |             |
|------------------------------|--------------------------|-------------|
| DASY Version                 | DASY52                   | V52.10.4    |
| Extrapolation                | Advanced Extrapolation   |             |
| Phantom                      | Triple Flat Phantom 5.1C |             |
| Distance Dipole Center - TSL | 15 mm                    | with Spacer |
| Zoom Scan Resolution         | dx, dy, dz = 5 mm        |             |
| Frequency                    | 835 MHz $\pm$ 1 MHz      |             |

### Head TSL parameters

The following parameters and calculations were applied.

|   | Temperature         | Permittivity   | Conductivity         |
|---|---------------------|----------------|----------------------|
| Nominal Head TSL parameters             | 22.0 °C             | 41.5           | 0.90 mho/m           |
| Measured Head TSL parameters            | (22.0 $\pm$ 0.2) °C | 41.3 $\pm$ 6 % | 0.92 mho/m $\pm$ 6 % |
| Head TSL temperature change during test | <1.0 °C             | —              | —                    |

### SAR result with Head TSL

|   |                    |  |
|---|--------------------|--|
| <b>SAR averaged over 1 cm<sup>3</sup> (1 g) of Head TSL</b>   | Condition          |  |
| SAR measured  | 250 mW input power | 2.41 W/kg                                      |
| SAR for nominal Head TSL parameters                           | normalized to 1W   | <b>9.45 W/kg <math>\pm</math> 18.8 % (k=2)</b> |
| <b>SAR averaged over 10 cm<sup>3</sup> (10 g) of Head TSL</b> | Condition          |  |
| SAR measured  | 250 mW input power | 1.58 W/kg                                      |
| SAR for nominal Head TSL parameters                           | normalized to 1W   | <b>6.22 W/kg <math>\pm</math> 18.7 % (k=2)</b> |



Add: No.52 HuaYuanBei Road, Haidian District, Beijing, 100191, China  
Tel: +86-10-62304633-2117  
E-mail: emf@caict.ac.cn      <http://www.caict.ac.cn>

## Appendix (Additional assessments outside the scope of CNAS L0570)

### Antenna Parameters with Head TSL

|                                      |                                |
|--------------------------------------|--------------------------------|
| Impedance, transformed to feed point | 46.7 $\Omega$ - 8.91j $\Omega$ |
| Return Loss                          | - 20.2dB                       |

### General Antenna Parameters and Design

|                                  |          |
|----------------------------------|----------|
| Electrical Delay (one direction) | 1.303 ns |
|----------------------------------|----------|

After long term use with 100W radiated power, only a slight warming of the dipole near the feed-point can be measured.

The dipole is made of standard semirigid coaxial cable. The center conductor of the feeding line is directly connected to the second arm of the dipole. The antenna is therefore short-circuited for DC-signals. On some of the dipoles, small end caps are added to the dipole arms in order to improve matching when loaded according to the position as explained in the "Measurement Conditions" paragraph. The SAR data are not affected by this change. The overall dipole length is still according to the Standard.

No excessive force must be applied to the dipole arms, because they might bend or the soldered connections near the feed-point may be damaged.

### Additional EUT Data

|                 |       |
|-----------------|-------|
| Manufactured by | SPEAG |
|-----------------|-------|

Add: No.52 HuaYuanBei Road, Haidian District, Beijing, 100191, China  
Tel: +86-10-62304633-2117  
E-mail: emf@caict.ac.cn      <http://www.caict.ac.cn>

### DASY5 Validation Report for Head TSL

Date: 2022-08-19

Test Laboratory: CTTL, Beijing, China

**DUT: Dipole 835 MHz; Type: D835V2; Serial: D835V2 - SN: 4d091**

Communication System: UID 0, CW; Frequency: 835 MHz; Duty Cycle: 1:1

Medium parameters used:  $f = 835$  MHz;  $\sigma = 0.922$  S/m;  $\epsilon_r = 41.25$ ;  $\rho = 1000$  kg/m<sup>3</sup>

Phantom section: Right Section

Measurement Standard: DASY5 (IEEE/IEC/ANSI C63.19-2007)

#### DASY5 Configuration:

- Probe: EX3DV4 - SN7464; ConvF(9.96, 9.96, 9.96) @ 835 MHz; Calibrated: 2022-01-26
- Sensor-Surface: 1.4mm (Mechanical Surface Detection)
- Electronics: DAE4 Sn1556; Calibrated: 2022-01-12
- Phantom: MFP\_V5.1C (20deg probe tilt); Type: QD 000 P51 Cx; Serial: 1062
- DASY52 52.10.4(1535); SEMCAD X 14.6.14(7501)

**Dipole Calibration/Zoom Scan (7x7x7) (7x7x7)/Cube 0:** Measurement grid: dx=5mm, dy=5mm, dz=5mm

Reference Value = 56.54 V/m; Power Drift = 0.01 dB

Peak SAR (extrapolated) = 3.60 W/kg

**SAR(1 g) = 2.41 W/kg; SAR(10 g) = 1.58 W/kg**

Smallest distance from peaks to all points 3 dB below = 18.6 mm

Ratio of SAR at M2 to SAR at M1 = 67%

Maximum value of SAR (measured) = 3.20 W/kg

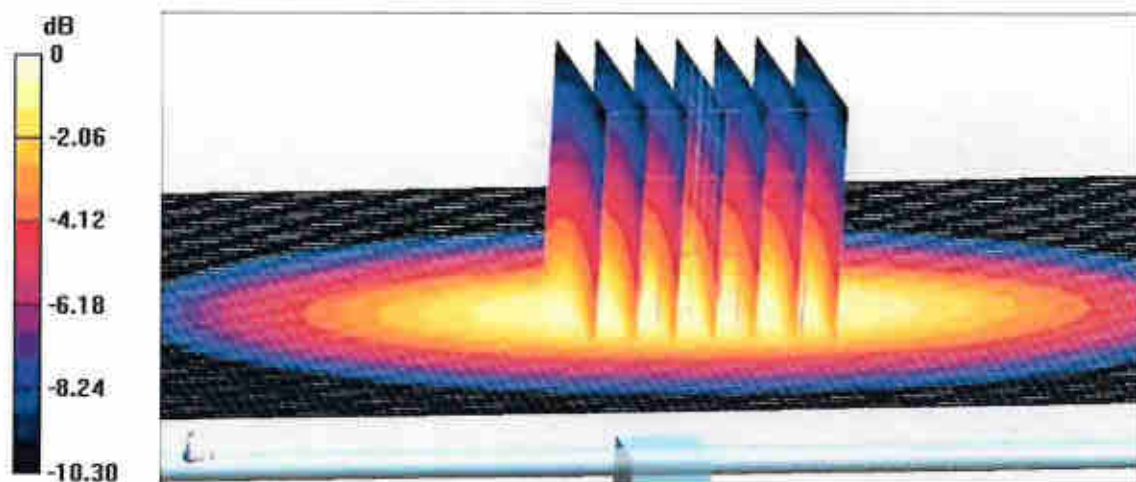

**0 dB = 3.20 W/kg = 5.05 dBW/kg**



Add: No.52 HuaYuanBei Road, Haidian District, Beijing, 100191, China  
Tel: +86-10-62304633-2117  
E-mail: emf@caict.ac.cn      <http://www.caict.ac.cn>

### Impedance Measurement Plot for Head TSL

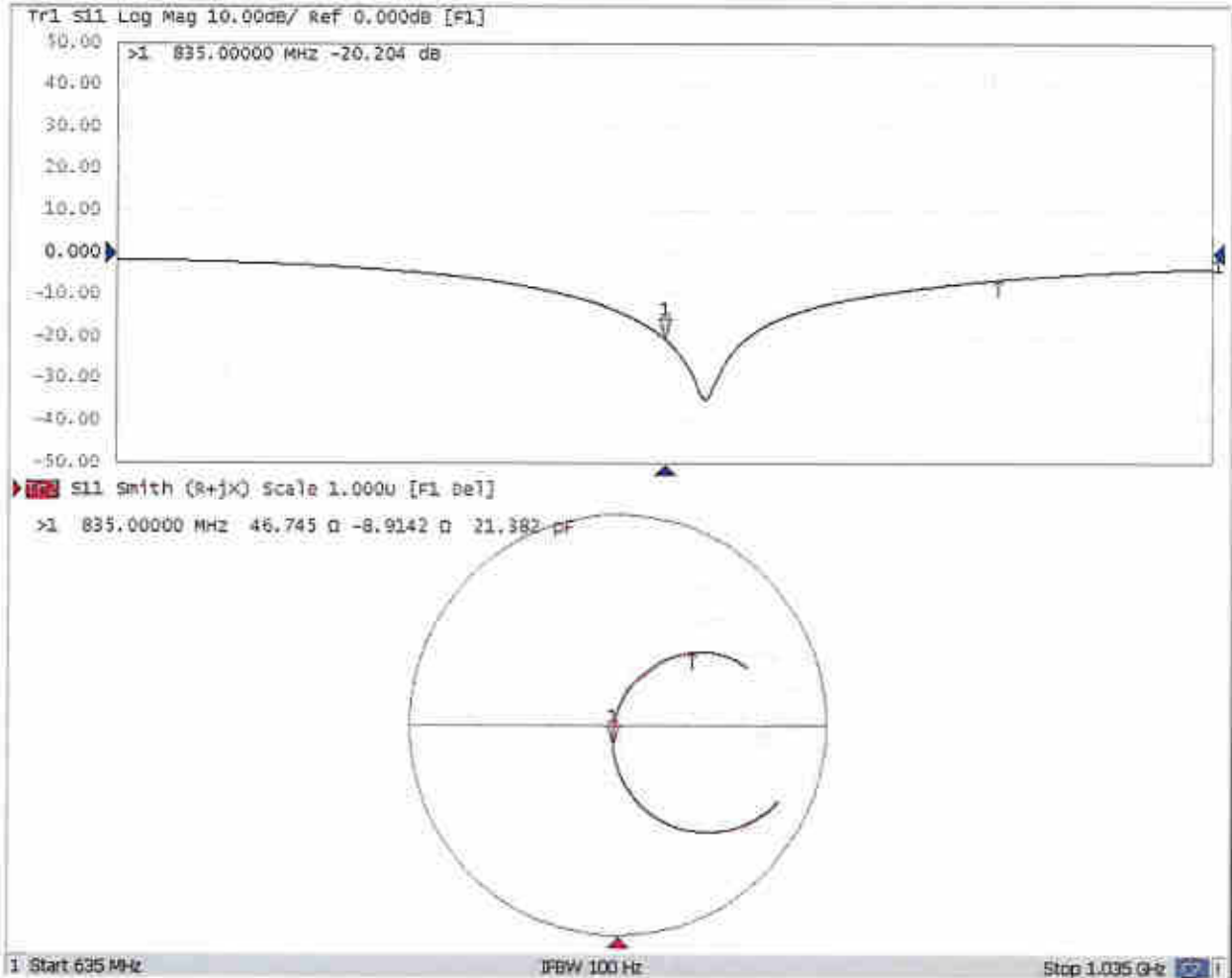



Accredited by the Swiss Accreditation Service (SAS)  
The Swiss Accreditation Service is one of the signatories to the EA  
Multilateral Agreement for the recognition of calibration certificates

Accreditation No.: **SCS 0108**

Client **Sporton**

Certificate No: **D1750V2-1090\_Feb22**

## CALIBRATION CERTIFICATE

Object **D1750V2 - SN:1090**

Calibration procedure(s) **QA CAL-05.v11  
Calibration Procedure for SAR Validation Sources between 0.7-3 GHz**

Calibration date: **February 24, 2022**

This calibration certificate documents the traceability to national standards, which realize the physical units of measurements (SI).  
The measurements and the uncertainties with confidence probability are given on the following pages and are part of the certificate.

All calibrations have been conducted in the closed laboratory facility: environment temperature ( $22 \pm 3$ )°C and humidity < 70%.

Calibration Equipment used (M&TE critical for calibration)

| Primary Standards           | ID #               | Cal Date (Certificate No.)      | Scheduled Calibration |
|-----------------------------|--------------------|---------------------------------|-----------------------|
| Power meter NRP             | SN: 104778         | 09-Apr-21 (No. 217-03291/03292) | Apr-22                |
| Power sensor NRP-Z91        | SN: 103244         | 09-Apr-21 (No. 217-03291)       | Apr-22                |
| Power sensor NRP-Z91        | SN: 103245         | 09-Apr-21 (No. 217-03292)       | Apr-22                |
| Reference 20 dB Attenuator  | SN: BH9394 (20k)   | 09-Apr-21 (No. 217-03343)       | Apr-22                |
| Type-N mismatch combination | SN: 310982 / 06327 | 09-Apr-21 (No. 217-03344)       | Apr-22                |
| Reference Probe EX3DV4      | SN: 7349           | 31-Dec-21 (No. EX3-7349_Dec21)  | Dec-22                |
| DAE4                        | SN: 601            | 01-Nov-21 (No. DAE4-601_Nov21)  | Nov-22                |

| Secondary Standards             | ID #           | Check Date (in house)             | Scheduled Check        |
|---------------------------------|----------------|-----------------------------------|------------------------|
| Power meter E4419B              | SN: GB39512475 | 30-Oct-14 (in house check Oct-20) | In house check: Oct-22 |
| Power sensor HP 8481A           | SN: US37292783 | 07-Oct-15 (in house check Oct-20) | In house check: Oct-22 |
| Power sensor HP 8481A           | SN: MY41093315 | 07-Oct-15 (in house check Oct-20) | In house check: Oct-22 |
| RF generator R&S SMT-06         | SN: 100972     | 15-Jun-15 (in house check Oct-20) | In house check: Oct-22 |
| Network Analyzer Agilent E8358A | SN: US41080477 | 31-Mar-14 (in house check Oct-20) | In house check: Oct-22 |

Calibrated by: **Joanna Lleshaj** Laboratory Technician

Approved by: **Niels Kuster** Quality Manager

Signature

Issued: March 3, 2022

This calibration certificate shall not be reproduced except in full without written approval of the laboratory.



Accredited by the Swiss Accreditation Service (SAS)

Accreditation No.: **SCS 0108**

The Swiss Accreditation Service is one of the signatories to the EA  
Multilateral Agreement for the recognition of calibration certificates

### Glossary:

|       |                                 |
|-------|---------------------------------|
| TSL   | tissue simulating liquid        |
| ConvF | sensitivity in TSL / NORM x,y,z |
| N/A   | not applicable or not measured  |

### Calibration is Performed According to the Following Standards:

- IEC/IEEE 62209-1528, "Measurement Procedure For The Assessment Of Specific Absorption Rate Of Human Exposure To Radio Frequency Fields From Hand-Held And Body-Worn Wireless Communication Devices - Part 1528: Human Models, Instrumentation And Procedures (Frequency Range of 4 MHz to 10 GHz)", October 2020.
- KDB 865664, "SAR Measurement Requirements for 100 MHz to 6 GHz"

### Additional Documentation:

- DASY System Handbook

### Methods Applied and Interpretation of Parameters:

- Measurement Conditions:** Further details are available from the Validation Report at the end of the certificate. All figures stated in the certificate are valid at the frequency indicated.
- Antenna Parameters with TSL:** The source is mounted in a touch configuration below the center marking of the flat phantom.
- Return Loss:** This parameter is measured with the source positioned under the liquid filled phantom (as described in the measurement condition clause). The Return Loss ensures low reflected power. No uncertainty required.
- SAR measured:** SAR measured at the stated antenna input power.
- SAR normalized:** SAR as measured, normalized to an input power of 1 W at the antenna connector.
- SAR for nominal TSL parameters:** The measured TSL parameters are used to calculate the nominal SAR result.

The reported uncertainty of measurement is stated as the standard uncertainty of measurement multiplied by the coverage factor  $k=2$ , which for a normal distribution corresponds to a coverage probability of approximately 95%.

## Measurement Conditions

DASY system configuration, as far as not given on page 1.

|                              |                        |             |
|------------------------------|------------------------|-------------|
| DASY Version                 | DASY52                 | V52.10.4    |
| Extrapolation                | Advanced Extrapolation |             |
| Phantom                      | Modular Flat Phantom   |             |
| Distance Dipole Center - TSL | 10 mm                  | with Spacer |
| Zoom Scan Resolution         | dx, dy, dz = 5 mm      |             |
| Frequency                    | 1750 MHz $\pm$ 1 MHz   |             |

## Head TSL parameters

The following parameters and calculations were applied.

|   | Temperature         | Permittivity   | Conductivity         |
|---|---------------------|----------------|----------------------|
| Nominal Head TSL parameters             | 22.0 °C             | 40.1           | 1.37 mho/m           |
| Measured Head TSL parameters            | (22.0 $\pm$ 0.2) °C | 40.4 $\pm$ 6 % | 1.35 mho/m $\pm$ 6 % |
| Head TSL temperature change during test | < 0.5 °C            | ----           | ----                 |

## SAR result with Head TSL

| SAR averaged over 1 cm <sup>3</sup> (1 g) of Head TSL | Condition          |  |
|---|--------------------|--|
| SAR measured  | 250 mW input power | 9.14 W/kg                                      |
| SAR for nominal Head TSL parameters                   | normalized to 1W   | <b>37.0 W/kg <math>\pm</math> 17.0 % (k=2)</b> |

| SAR averaged over 10 cm <sup>3</sup> (10 g) of Head TSL | condition          |  |
|---|--------------------|--|
| SAR measured  | 250 mW input power | 4.84 W/kg                                      |
| SAR for nominal Head TSL parameters                     | normalized to 1W   | <b>19.5 W/kg <math>\pm</math> 16.5 % (k=2)</b> |



## Appendix (Additional assessments outside the scope of SCS 0108)

### Antenna Parameters with Head TSL

|                                      |                                |
|--------------------------------------|--------------------------------|
| Impedance, transformed to feed point | 49.9 $\Omega$ - 1.4 j $\Omega$ |
| Return Loss                          | - 37.1 dB                      |

### General Antenna Parameters and Design

|                                  |          |
|----------------------------------|----------|
| Electrical Delay (one direction) | 1.221 ns |
|----------------------------------|----------|

After long term use with 100W radiated power, only a slight warming of the dipole near the feedpoint can be measured.

The dipole is made of standard semirigid coaxial cable. The center conductor of the feeding line is directly connected to the second arm of the dipole. The antenna is therefore short-circuited for DC-signals. On some of the dipoles, small end caps are added to the dipole arms in order to improve matching when loaded according to the position as explained in the "Measurement Conditions" paragraph. The SAR data are not affected by this change. The overall dipole length is still according to the Standard.

No excessive force must be applied to the dipole arms, because they might bend or the soldered connections near the feedpoint may be damaged.

### Additional EUT Data

|                 |       |
|-----------------|-------|
| Manufactured by | SPEAG |
|-----------------|-------|

## DASY5 Validation Report for Head TSL

Date: 24.02.2022

Test Laboratory: SPEAG, Zurich, Switzerland

**DUT: Dipole 1750 MHz; Type: D1750V2; Serial: D1750V2 - SN:1090**

Communication System: UID 0 - CW; Frequency: 1750 MHz

Medium parameters used:  $f = 1750$  MHz;  $\sigma = 1.35$  S/m;  $\epsilon_r = 40.4$ ;  $\rho = 1000$  kg/m<sup>3</sup>

Phantom section: Flat Section

Measurement Standard: DASY5 (IEEE/IEC/ANSI C63.19-2011)

DASY52 Configuration:

- Probe: EX3DV4 - SN7349; ConvF(8.67, 8.67, 8.67) @ 1750 MHz; Calibrated: 31.12.2021
- Sensor-Surface: 1.4mm (Mechanical Surface Detection)
- Electronics: DAE4 Sn601; Calibrated: 01.11.2021
- Phantom: Flat Phantom 5.0 (front); Type: QD 000 P50 AA; Serial: 1001
- DASY52 52.10.4(1535); SEMCAD X 14.6.14(7501)

### Dipole Calibration for Head Tissue/ $P_{in}=250$ mW, $d=10$ mm/Zoom Scan (7x7x7)/Cube 0:

Measurement grid:  $dx=5$ mm,  $dy=5$ mm,  $dz=5$ mm

Reference Value = 106.9 V/m; Power Drift = 0.03 dB

Peak SAR (extrapolated) = 16.7 W/kg

**SAR(1 g) = 9.14 W/kg; SAR(10 g) = 4.84 W/kg**

Smallest distance from peaks to all points 3 dB below = 10 mm

Ratio of SAR at M2 to SAR at M1 = 55%

Maximum value of SAR (measured) = 14.1 W/kg

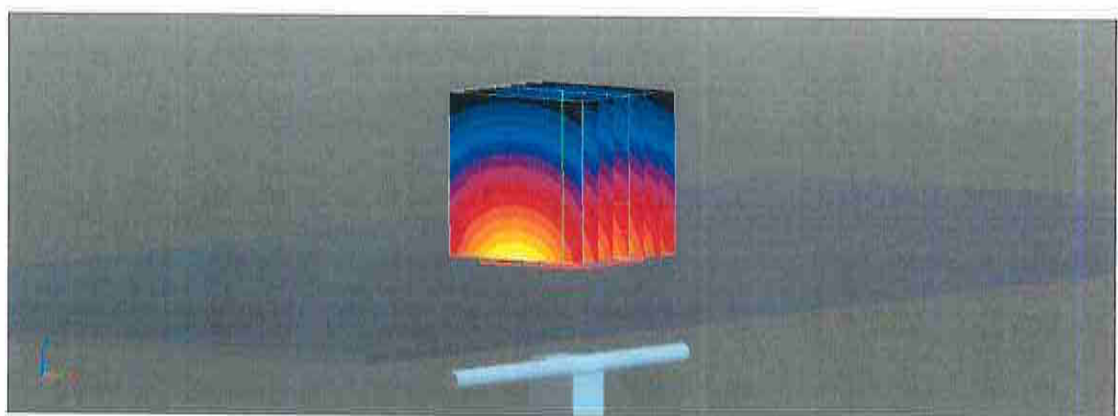
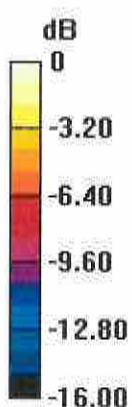

0 dB = 14.1 W/kg = 11.50 dBW/kg

# Impedance Measurement Plot for Head TSL

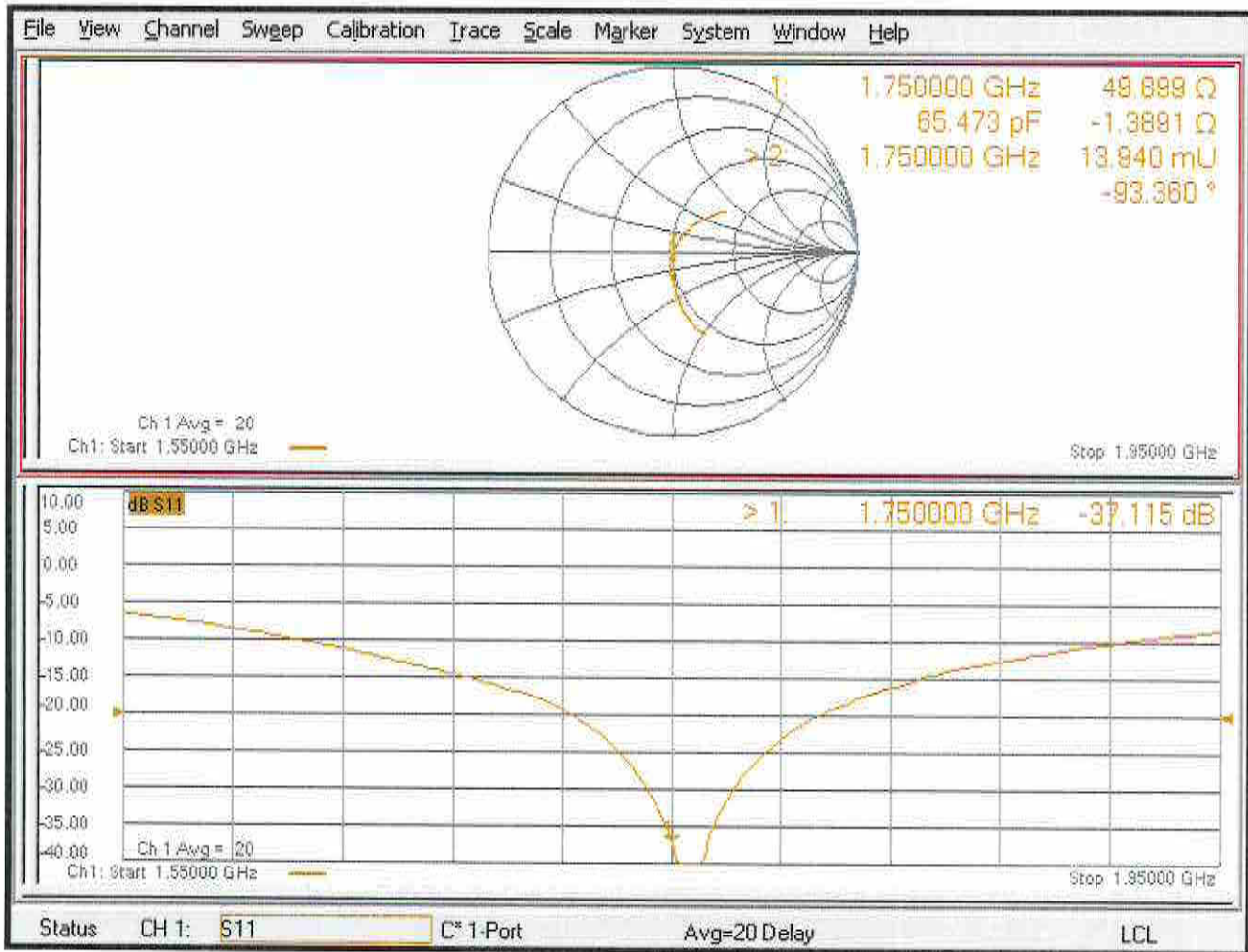

## D1750V2, Serial No. 1090 Extended Dipole Calibrations

Referring to KDB 865664 D01 v01r02, if dipoles are verified in return loss (<-20dB, within 20% of prior calibration), and in impedance (within 5 ohm of prior calibration), the annual calibration is not necessary and the calibration interval can be extended.

| D1750V2 – serial no. 1090 |                  |           |                      |             |                           |             |
|---------------------------|------------------|-----------|----------------------|-------------|---------------------------|-------------|
| 1750 Head                 |                  |           |                      |             |                           |             |
| Date of Measurement       | Return-Loss (dB) | Delta (%) | Real Impedance (ohm) | Delta (ohm) | Imaginary Impedance (ohm) | Delta (ohm) |
| 2022.2.24                 | -37.115          |           | 49.899               |             | -1.3891                   |             |
| 2023.2.23                 | -35.184          | -5.2      | 49.092               | 0.807       | -2.9814                   | 1.5923      |

### <Justification of the extended calibration>

The return loss is < -20dB, within 20% of prior calibration; the impedance is within 5 ohm of prior calibration. Therefore the verification result should support extended calibration.

### Dipole Verification Data> D1750V2, serial no. 1090

#### 1750MHz – Head - 2023-2-23

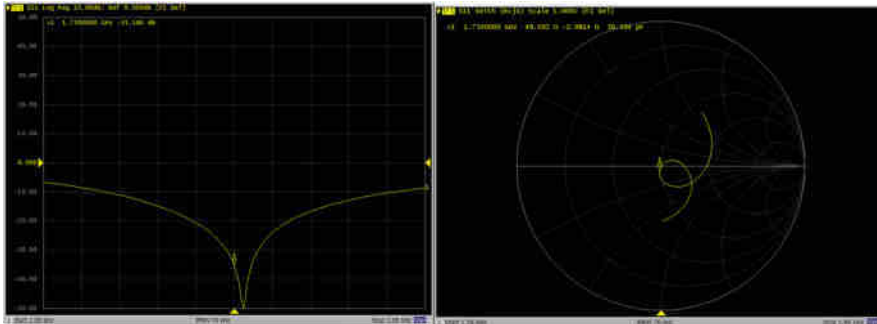



In Collaboration with  
**s p e a g**  
CALIBRATION LABORATORY



中国认可  
国际互认  
校准  
CALIBRATION  
CNAS L0570

Add: No.52 HuaYuanBei Road, Haidian District, Beijing, 100191, Chi  
Tel: +86-10-62304633-2079 Fax: +86-10-62304633-2504  
E-mail: cttl@chinattl.com http://www.chinattl.cn

Client **Sporton**

Certificate No: **Z21-60553**

## CALIBRATION CERTIFICATE

Object **D1900V2 - SN: 5d182**

Calibration Procedure(s) **FF-Z11-003-01**  
Calibration Procedures for dipole validation kits

Calibration date: **December 20, 2021**

This calibration Certificate documents the traceability to national standards, which realize the physical units of measurements (SI). The measurements and the uncertainties with confidence probability are given on the following pages and are part of the certificate.

All calibrations have been conducted in the closed laboratory facility: environment temperature (22±3)°C and humidity<70%.

Calibration Equipment used (M&TE critical for calibration)

| Primary Standards       | ID #       | Cal Date (Calibrated by, Certificate No.) | Scheduled Calibration |
|-------------------------|------------|---|-----------------------|
| Power Meter NRP2        | 106277     | 24-Sep-21 (CTTL, No.J21X08326)            | Sep-22                |
| Power sensor NRP8S      | 104291     | 24-Sep-21 (CTTL, No.J21X08326)            | Sep-22                |
| Reference Probe EX3DV4  | SN 7307    | 26-May-21(SPEAG,No.EX3-7307_May21)        | May-22                |
| DAE4                    | SN 1556    | 15-Jan-21(SPEAG,No.DAE4-1556_Jan21)       | Jan-22                |
| Secondary Standards     | ID #       | Cal Date (Calibrated by, Certificate No.) | Scheduled Calibration |
| Signal Generator E4438C | MY49071430 | 01-Feb-21 (CTTL, No.J21X00593)            | Jan-22                |
| NetworkAnalyzer E5071C  | MY46110673 | 14-Jan-21 (CTTL, No.J21X00232)            | Jan-22                |

|                | Name        | Function           | Signature |
|----------------|-------------|--------------------|-----------|
| Calibrated by: | Zhao Jing   | SAR Test Engineer  |           |
| Reviewed by:   | Lin Hao     | SAR Test Engineer  |           |
| Approved by:   | Qi Dianyuan | SAR Project Leader |           |

Issued: December 27, 2021

This calibration certificate shall not be reproduced except in full without written approval of the laboratory.



**Glossary:**

|       |  |
|-------|--|
| TSL   | tissue simulating liquid                   |
| ConvF | sensitivity in TSL / NORM <sub>x,y,z</sub> |
| N/A   | not applicable or not measured             |

**Calibration is Performed According to the Following Standards:**

- IEEE Std 1528-2013, "IEEE Recommended Practice for Determining the Peak Spatial-Averaged Specific Absorption Rate (SAR) in the Human Head from Wireless Communications Devices: Measurement Techniques", June 2013
- IEC 62209-1, "Measurement procedure for assessment of specific absorption rate of human exposure to radio frequency fields from hand-held and body-mounted wireless communication devices- Part 1: Device used next to the ear (Frequency range of 300MHz to 6GHz)", July 2016
- IEC 62209-2, "Procedure to measure the Specific Absorption Rate (SAR) For wireless communication devices used in close proximity to the human body (frequency range of 30MHz to 6GHz)", March 2010
- KDB865664, SAR Measurement Requirements for 100 MHz to 6 GHz

**Additional Documentation:**

- DASY4/5 System Handbook

**Methods Applied and Interpretation of Parameters:**

- Measurement Conditions:** Further details are available from the Validation Report at the end of the certificate. All figures stated in the certificate are valid at the frequency indicated.
- Antenna Parameters with TSL:** The dipole is mounted with the spacer to position its feed point exactly below the center marking of the flat phantom section, with the arms oriented parallel to the body axis.
- Feed Point Impedance and Return Loss:** These parameters are measured with the dipole positioned under the liquid filled phantom. The impedance stated is transformed from the measurement at the SMA connector to the feed point. The Return Loss ensures low reflected power. No uncertainty required.
- Electrical Delay:** One-way delay between the SMA connector and the antenna feed point. No uncertainty required.
- SAR measured:** SAR measured at the stated antenna input power.
- SAR normalized:** SAR as measured, normalized to an input power of 1 W at the antenna connector.
- SAR for nominal TSL parameters:** The measured TSL parameters are used to calculate the nominal SAR result.

The reported uncertainty of measurement is stated as the standard uncertainty of Measurement multiplied by the coverage factor  $k=2$ , which for a normal distribution Corresponds to a coverage probability of approximately 95%.



### Measurement Conditions

DASY system configuration, as far as not given on page 1.

|                              |                          |             |
|------------------------------|--------------------------|-------------|
| DASY Version                 | DASY52                   | V52.10.4    |
| Extrapolation                | Advanced Extrapolation   |             |
| Phantom                      | Triple Flat Phantom 5.1C |             |
| Distance Dipole Center - TSL | 10 mm                    | with Spacer |
| Zoom Scan Resolution         | dx, dy, dz = 5 mm        |             |
| Frequency                    | 1900 MHz $\pm$ 1 MHz     |             |

### Head TSL parameters

The following parameters and calculations were applied.

|   | Temperature         | Permittivity   | Conductivity         |
|---|---------------------|----------------|----------------------|
| Nominal Head TSL parameters             | 22.0 °C             | 40.0           | 1.40 mho/m           |
| Measured Head TSL parameters            | (22.0 $\pm$ 0.2) °C | 39.4 $\pm$ 6 % | 1.41 mho/m $\pm$ 6 % |
| Head TSL temperature change during test | <1.0 °C             | ----           | ----                 |

### SAR result with Head TSL

|   |                    |  |
|---|--------------------|--|
| <b>SAR averaged over 1 cm<sup>3</sup> (1 g) of Head TSL</b>   | Condition          |  |
| SAR measured  | 250 mW input power | 10.0 W/kg                                      |
| SAR for nominal Head TSL parameters                           | normalized to 1W   | <b>39.6 W/kg <math>\pm</math> 18.8 % (k=2)</b> |
| <b>SAR averaged over 10 cm<sup>3</sup> (10 g) of Head TSL</b> | Condition          |  |
| SAR measured  | 250 mW input power | 5.07 W/kg                                      |
| SAR for nominal Head TSL parameters                           | normalized to 1W   | <b>20.2 W/kg <math>\pm</math> 18.7 % (k=2)</b> |



Add: No.52 HuaYuanBei Road, Haidian District, Beijing, 100191, China  
Tel: +86-10-62304633-2079 Fax: +86-10-62304633-2504  
E-mail: cttl@chinattl.com http://www.chinattl.cn

### Appendix (Additional assessments outside the scope of CNAS L0570)

#### Antenna Parameters with Head TSL

|                                      |               |
|--------------------------------------|---------------|
| Impedance, transformed to feed point | 54.3Ω+ 6.57jΩ |
| Return Loss                          | - 22.5dB      |

#### General Antenna Parameters and Design

|                                  |          |
|----------------------------------|----------|
| Electrical Delay (one direction) | 1.112 ns |
|----------------------------------|----------|

After long term use with 100W radiated power, only a slight warming of the dipole near the feedpoint can be measured.

The dipole is made of standard semirigid coaxial cable. The center conductor of the feeding line is directly connected to the second arm of the dipole. The antenna is therefore short-circuited for DC-signals. On some of the dipoles, small end caps are added to the dipole arms in order to improve matching when loaded according to the position as explained in the "Measurement Conditions" paragraph. The SAR data are not affected by this change. The overall dipole length is still according to the Standard. No excessive force must be applied to the dipole arms, because they might bend or the soldered connections near the feedpoint may be damaged.

#### Additional EUT Data

|                 |       |
|-----------------|-------|
| Manufactured by | SPEAG |
|-----------------|-------|





Add: No.52 HuaYuanBei Road, Haidian District, Beijing, 100191, China  
Tel: +86-10-62304633-2079 Fax: +86-10-62304633-2504  
E-mail: cttl@chinattl.com http://www.chinattl.cn

**DASY5 Validation Report for Head TSL**

Date: 2021-12-20

Test Laboratory: CTTL, Beijing, China

**DUT: Dipole 1900 MHz; Type: D1900V2; Serial: D1900V2 - SN: 5d182**

Communication System: UID 0, CW; Frequency: 1900 MHz; Duty Cycle: 1:1

Medium parameters used:  $f = 1900$  MHz;  $\sigma = 1.414$  S/m;  $\epsilon_r = 39.36$ ;  $\rho = 1000$  kg/m<sup>3</sup>

Phantom section: Right Section

Measurement Standard: DASY5 (IEEE/IEC/ANSI C63.19-2007)

DASY5 Configuration:

- Probe: EX3DV4 - SN7307; ConvF(8.32, 8.32, 8.32) @ 1900 MHz; Calibrated: 2021-05-26
- Sensor-Surface: 1.4mm (Mechanical Surface Detection)
- Electronics: DAE4 Sn1556; Calibrated: 2021-01-15
- Phantom: MFP\_V5.1C (20deg probe tilt); Type: QD 000 P51 Cx; Serial: 1062
- DASY52 52.10.4(1535); SEMCAD X 14.6.14(7501)

**System Performance Check/Zoom Scan (7x7x7) (7x7x7)/Cube 0:** Measurement grid:  
dx=5mm, dy=5mm, dz=5mm

Reference Value = 101.3 V/m; Power Drift = -0.01 dB

Peak SAR (extrapolated) = 19.6 W/kg

**SAR(1 g) = 10 W/kg; SAR(10 g) = 5.07 W/kg**

Smallest distance from peaks to all points 3 dB below = 10 mm

Ratio of SAR at M2 to SAR at M1 = 51%

Maximum value of SAR (measured) = 15.9 W/kg

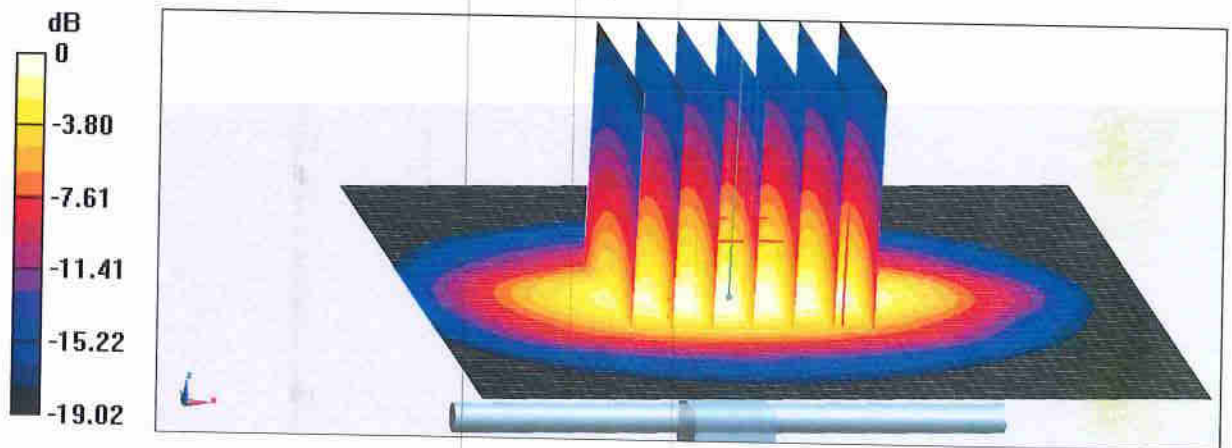

0 dB = 15.9 W/kg = 12.01 dBW/kg



In Collaboration with  
**s p e a g**  
CALIBRATION LABORATORY

Add: No.52 HuaYuanBei Road, Haidian District, Beijing, 100191, China  
Tel: +86-10-62304633-2079 Fax: +86-10-62304633-2504  
E-mail: cttl@chinattl.com http://www.chinattl.cn

### Impedance Measurement Plot for Head TSL

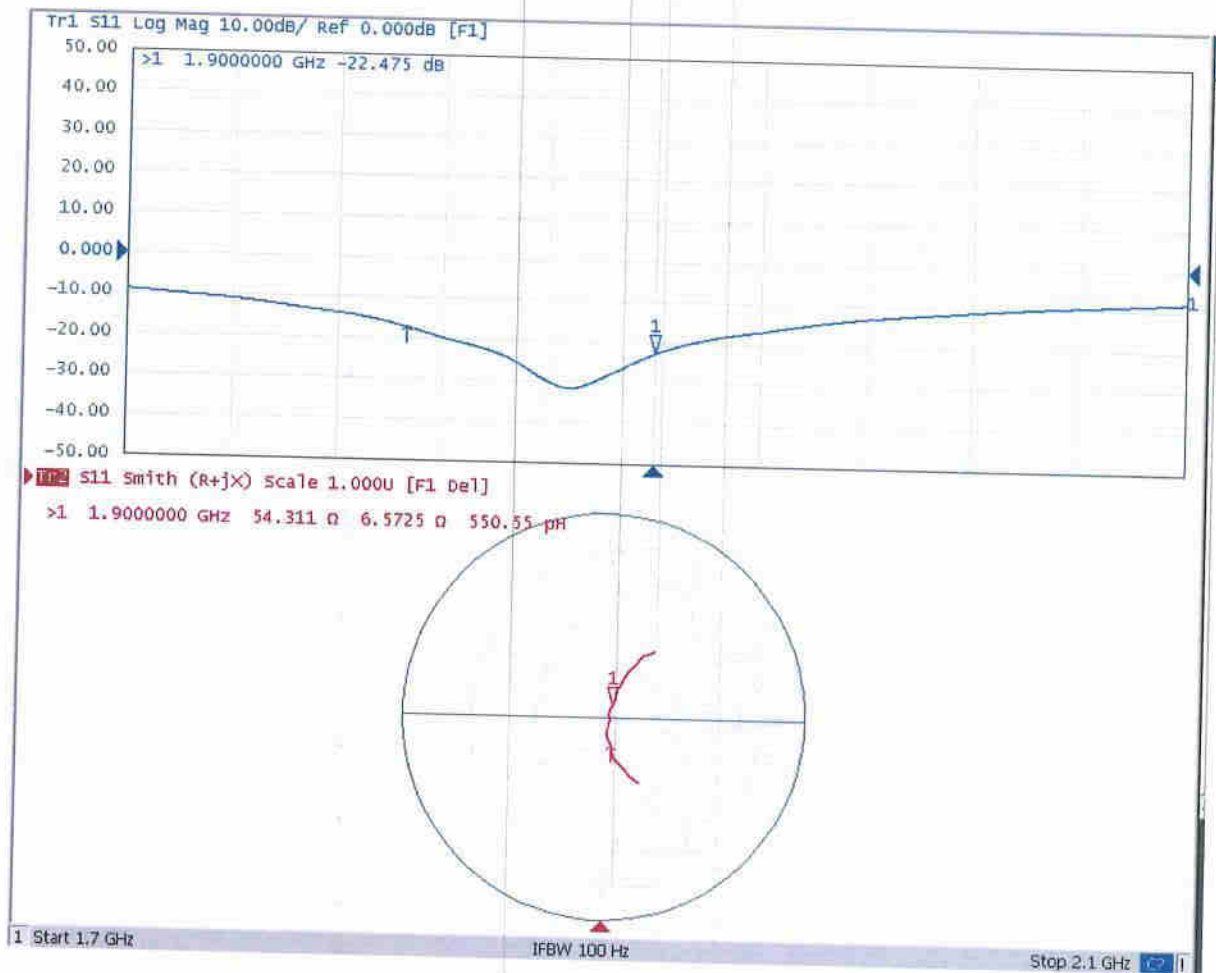



---

## D1900V2, Serial No. 5d182 Extended Dipole Calibrations

Referring to KDB 865664 D01, if dipoles are verified in return loss ( $< -20\text{dB}$ , within 20% of prior calibration), and in impedance (within 5 ohm of prior calibration), the annual calibration is not necessary and the calibration interval can be extended.

| D1900V2 – serial no. 5d182 |                  |           |                      |             |                           |             |
|----------------------------|------------------|-----------|----------------------|-------------|---------------------------|-------------|
| 1900 Head                  |                  |           |                      |             |                           |             |
| Date of Measurement        | Return-Loss (dB) | Delta (%) | Real Impedance (ohm) | Delta (ohm) | Imaginary Impedance (ohm) | Delta (ohm) |
| 2021.12.20                 | -22.5            |           | 54.3                 |             | 6.57                      |             |
| 2022.12.19                 | -22.5            | 0.0       | 53.7                 | 0.6         | 6.9                       | -0.33       |

### <Justification of the extended calibration>

The return loss is  $< -20\text{dB}$ , within 20% of prior calibration; the impedance is within 5 ohm of prior calibration. Therefore the verification result should support extended calibration.

---

Dipole Verification Data> D1900V2, serial no. 5d182

1900MHz – Head---2022.12.19

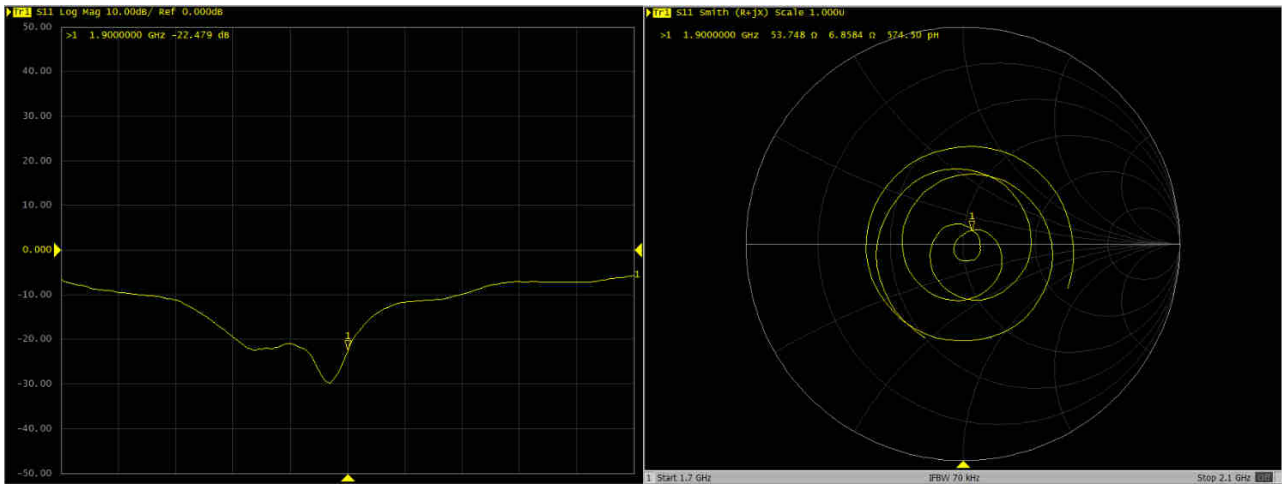



Accredited by the Swiss Accreditation Service (SAS)  
The Swiss Accreditation Service is one of the signatories to the EA  
Multilateral Agreement for the recognition of calibration certificates

Accreditation No.: **SCS 0108**

Client **Sporton**

Certificate No: **D2300V2-1055\_Sep20**

## CALIBRATION CERTIFICATE

Object **D2300V2 - SN:1055**

Calibration procedure(s) **QA CAL-05.v11  
Calibration Procedure for SAR Validation Sources between 0.7-3 GHz**

Calibration date: **September 15, 2020**

This calibration certificate documents the traceability to national standards, which realize the physical units of measurements (SI).  
The measurements and the uncertainties with confidence probability are given on the following pages and are part of the certificate.

All calibrations have been conducted in the closed laboratory facility: environment temperature ( $22 \pm 3$ )°C and humidity < 70%.

Calibration Equipment used (M&TE critical for calibration)

| Primary Standards               | ID #               | Cal Date (Certificate No.)        | Scheduled Calibration  |
|---------------------------------|--------------------|-----------------------------------|------------------------|
| Power meter NRP                 | SN: 104778         | 01-Apr-20 (No. 217-03100/03101)   | Apr-21                 |
| Power sensor NRP-Z91            | SN: 103244         | 01-Apr-20 (No. 217-03100)         | Apr-21                 |
| Power sensor NRP-Z91            | SN: 103245         | 01-Apr-20 (No. 217-03101)         | Apr-21                 |
| Reference 20 dB Attenuator      | SN: BH9394 (20k)   | 31-Mar-20 (No. 217-03106)         | Apr-21                 |
| Type-N mismatch combination     | SN: 310982 / 06327 | 31-Mar-20 (No. 217-03104)         | Apr-21                 |
| Reference Probe EX3DV4          | SN: 7405           | 29-Jun-20 (No. EX3-7405_Jun20)    | Jun-21                 |
| DAE4                            | SN: 601            | 27-Dec-19 (No. DAE4-601_Dec19)    | Dec-20                 |
| Secondary Standards             | ID #               | Check Date (in house)             | Scheduled Check        |
| Power meter E4419B              | SN: GB39512475     | 30-Oct-14 (in house check Feb-19) | In house check: Oct-20 |
| Power sensor HP 8481A           | SN: US37292783     | 07-Oct-15 (in house check Oct-18) | In house check: Oct-20 |
| Power sensor HP 8481A           | SN: MY41092317     | 07-Oct-15 (in house check Oct-18) | In house check: Oct-20 |
| RF generator R&S SMT-06         | SN: 100972         | 15-Jun-15 (in house check Oct-18) | In house check: Oct-20 |
| Network Analyzer Agilent E8358A | SN: US41080477     | 31-Mar-14 (in house check Oct-19) | In house check: Oct-20 |

|                |                       |                                   |               |
|----------------|-----------------------|-----------------------------------|---------------|
| Calibrated by: | Name<br>Michael Weber | Function<br>Laboratory Technician | Signature<br> |
| Approved by:   | Katja Pokovic         | Technical Manager                 |               |

Issued: September 17, 2020

This calibration certificate shall not be reproduced except in full without written approval of the laboratory.



Accredited by the Swiss Accreditation Service (SAS)

The Swiss Accreditation Service is one of the signatories to the EA  
Multilateral Agreement for the recognition of calibration certificates

Accreditation No.: **SCS 0108**

### Glossary:

|       |                                 |
|-------|---------------------------------|
| TSL   | tissue simulating liquid        |
| ConvF | sensitivity in TSL / NORM x,y,z |
| N/A   | not applicable or not measured  |

### Calibration is Performed According to the Following Standards:

- IEEE Std 1528-2013, "IEEE Recommended Practice for Determining the Peak Spatial-Averaged Specific Absorption Rate (SAR) in the Human Head from Wireless Communications Devices: Measurement Techniques", June 2013
- IEC 62209-1, "Measurement procedure for the assessment of Specific Absorption Rate (SAR) from hand-held and body-mounted devices used next to the ear (frequency range of 300 MHz to 6 GHz)", July 2016
- IEC 62209-2, "Procedure to determine the Specific Absorption Rate (SAR) for wireless communication devices used in close proximity to the human body (frequency range of 30 MHz to 6 GHz)", March 2010
- KDB 865664, "SAR Measurement Requirements for 100 MHz to 6 GHz"

### Additional Documentation:

- DASY4/5 System Handbook

### Methods Applied and Interpretation of Parameters:

- Measurement Conditions:** Further details are available from the Validation Report at the end of the certificate. All figures stated in the certificate are valid at the frequency indicated.
- Antenna Parameters with TSL:** The dipole is mounted with the spacer to position its feed point exactly below the center marking of the flat phantom section, with the arms oriented parallel to the body axis.
- Feed Point Impedance and Return Loss:** These parameters are measured with the dipole positioned under the liquid filled phantom. The impedance stated is transformed from the measurement at the SMA connector to the feed point. The Return Loss ensures low reflected power. No uncertainty required.
- Electrical Delay:** One-way delay between the SMA connector and the antenna feed point. No uncertainty required.
- SAR measured:** SAR measured at the stated antenna input power.
- SAR normalized:** SAR as measured, normalized to an input power of 1 W at the antenna connector.
- SAR for nominal TSL parameters:** The measured TSL parameters are used to calculate the nominal SAR result.

The reported uncertainty of measurement is stated as the standard uncertainty of measurement multiplied by the coverage factor  $k=2$ , which for a normal distribution corresponds to a coverage probability of approximately 95%.

## Measurement Conditions

DASY system configuration, as far as not given on page 1.

|                              |                        |             |
|------------------------------|------------------------|-------------|
| DASY Version                 | DASY5                  | V52.10.4    |
| Extrapolation                | Advanced Extrapolation |             |
| Phantom                      | Modular Flat Phantom   |             |
| Distance Dipole Center - TSL | 10 mm                  | with Spacer |
| Zoom Scan Resolution         | dx, dy, dz = 5 mm      |             |
| Frequency                    | 2300 MHz $\pm$ 1 MHz   |             |

## Head TSL parameters

The following parameters and calculations were applied.

|   | Temperature         | Permittivity   | Conductivity         |
|---|---------------------|----------------|----------------------|
| Nominal Head TSL parameters             | 22.0 °C             | 39.5           | 1.67 mho/m           |
| Measured Head TSL parameters            | (22.0 $\pm$ 0.2) °C | 38.8 $\pm$ 6 % | 1.68 mho/m $\pm$ 6 % |
| Head TSL temperature change during test | < 0.5 °C            | ----           | ----                 |

## SAR result with Head TSL

| SAR averaged over 1 cm <sup>3</sup> (1 g) of Head TSL | Condition          |  |
|---|--------------------|--|
| SAR measured  | 250 mW input power | 12.0 W/kg                                      |
| SAR for nominal Head TSL parameters                   | normalized to 1W   | <b>47.7 W/kg <math>\pm</math> 17.0 % (k=2)</b> |

| SAR averaged over 10 cm <sup>3</sup> (10 g) of Head TSL | condition          |  |
|---|--------------------|--|
| SAR measured  | 250 mW input power | 5.75 W/kg                                      |
| SAR for nominal Head TSL parameters                     | normalized to 1W   | <b>22.9 W/kg <math>\pm</math> 16.5 % (k=2)</b> |

## Appendix (Additional assessments outside the scope of SCS 0108)

### Antenna Parameters with Head TSL

|                                      |                                |
|--------------------------------------|--------------------------------|
| Impedance, transformed to feed point | 48.2 $\Omega$ - 2.7 j $\Omega$ |
| Return Loss                          | - 29.7 dB                      |

### General Antenna Parameters and Design

|                                  |          |
|----------------------------------|----------|
| Electrical Delay (one direction) | 1.168 ns |
|----------------------------------|----------|

After long term use with 100W radiated power, only a slight warming of the dipole near the feedpoint can be measured.

The dipole is made of standard semirigid coaxial cable. The center conductor of the feeding line is directly connected to the second arm of the dipole. The antenna is therefore short-circuited for DC-signals. On some of the dipoles, small end caps are added to the dipole arms in order to improve matching when loaded according to the position as explained in the "Measurement Conditions" paragraph. The SAR data are not affected by this change. The overall dipole length is still according to the Standard.

No excessive force must be applied to the dipole arms, because they might bend or the soldered connections near the feedpoint may be damaged.

### Additional EUT Data

|                 |       |
|-----------------|-------|
| Manufactured by | SPEAG |
|-----------------|-------|



## DASY5 Validation Report for Head TSL

Date: 15.09.2020

Test Laboratory: SPEAG, Zurich, Switzerland

**DUT: Dipole 2300 MHz; Type: D2300V2; Serial: D2300V2 - SN:1055**

Communication System: UID 0 - CW; Frequency: 2300 MHz

Medium parameters used:  $f = 2300$  MHz;  $\sigma = 1.68$  S/m;  $\epsilon_r = 38.8$ ;  $\rho = 1000$  kg/m<sup>3</sup>

Phantom section: Flat Section

Measurement Standard: DASY5 (IEEE/IEC/ANSI C63.19-2011)

DASY52 Configuration:

- Probe: EX3DV4 - SN7405; ConvF(8.03, 8.03, 8.03) @ 2300 MHz; Calibrated: 29.06.2020
- Sensor-Surface: 1.4mm (Mechanical Surface Detection)
- Electronics: DAE4 Sn601; Calibrated: 27.12.2019
- Phantom: Flat Phantom 5.0 (front); Type: QD 000 P50 AA; Serial: 1003
- DASY52 52.10.4(1527); SEMCAD X 14.6.14(7483)

### Dipole Calibration for Head Tissue/Pin=250 mW, d=10mm/Zoom Scan (7x7x7)/Cube 0:

Measurement grid: dx=5mm, dy=5mm, dz=5mm

Reference Value = 112.4 V/m; Power Drift = -0.02 dB

Peak SAR (extrapolated) = 23.2 W/kg

**SAR(1 g) = 12 W/kg; SAR(10 g) = 5.75 W/kg**

Smallest distance from peaks to all points 3 dB below = 9 mm

Ratio of SAR at M2 to SAR at M1 = 51.8%

Maximum value of SAR (measured) = 19.3 W/kg

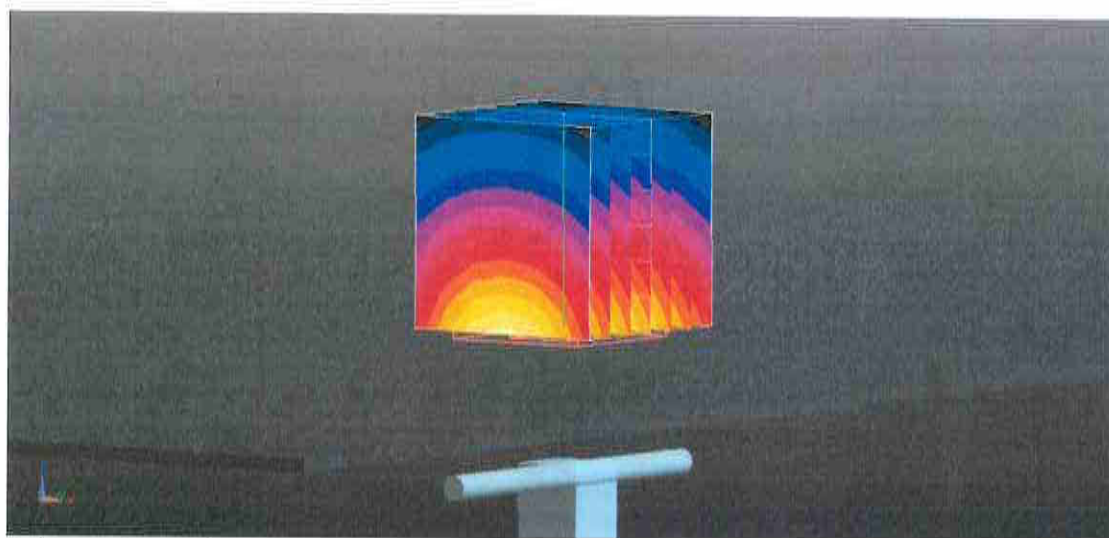
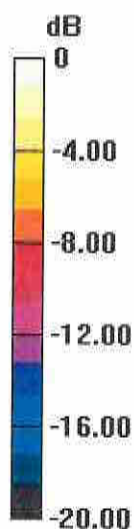

0 dB = 19.3 W/kg = 12.86 dBW/kg

# Impedance Measurement Plot for Head TSL

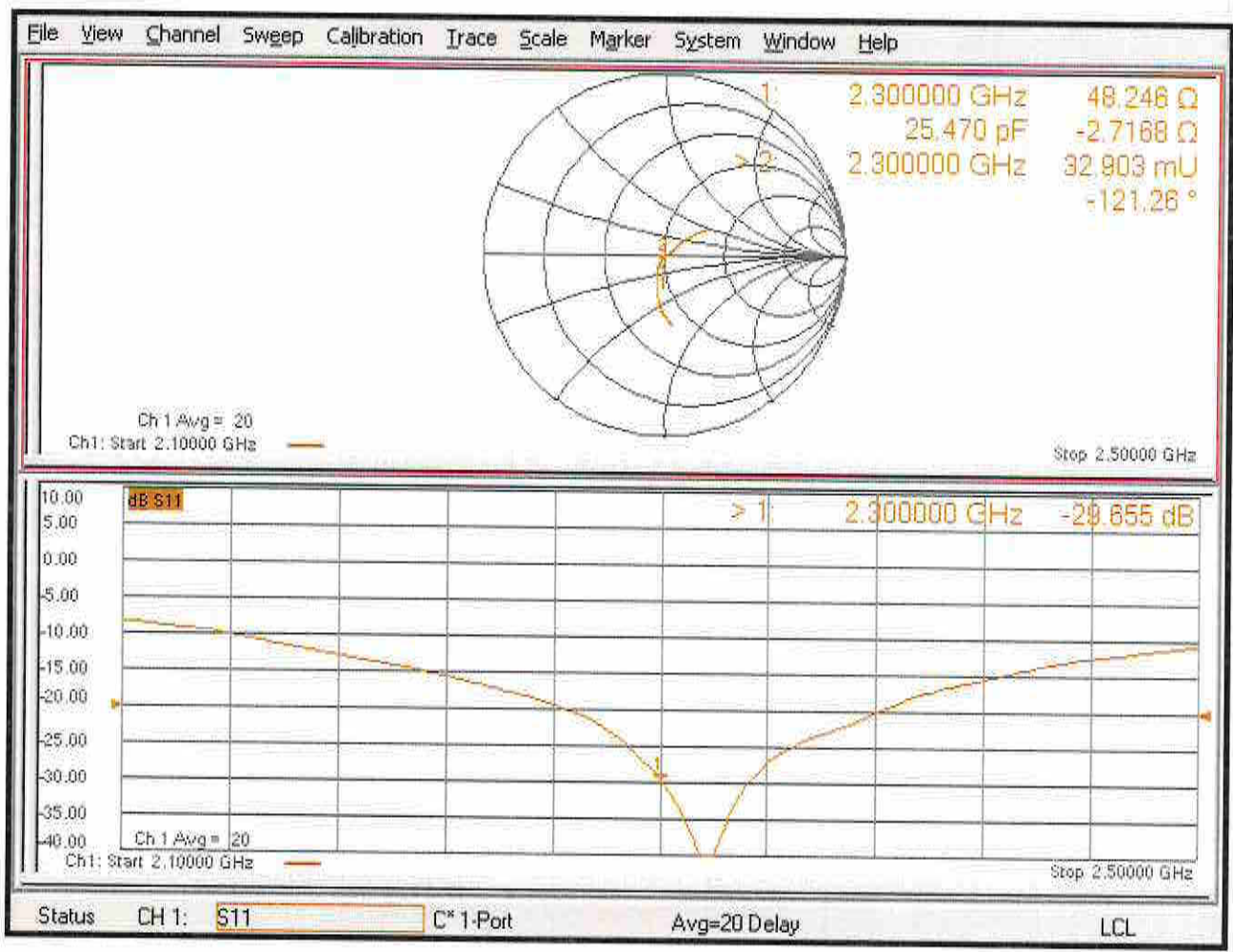



## D2300V2, Serial No. 1055 Extended Dipole Calibrations

Referring to KDB 865664 D01 v01r04, if dipoles are verified in return loss ( $< -20\text{dB}$ , within 20% of prior calibration), and in impedance (within 5 ohm of prior calibration), the annual calibration is not necessary and the calibration interval can be extended.

| D2300V2 – serial no. 1055 |                  |           |                      |             |                           |             |
|---------------------------|------------------|-----------|----------------------|-------------|---------------------------|-------------|
| 2300 Head                 |                  |           |                      |             |                           |             |
| Date of Measurement       | Return-Loss (dB) | Delta (%) | Real Impedance (ohm) | Delta (ohm) | Imaginary Impedance (ohm) | Delta (ohm) |
| 2020.9.15                 | -29.66           |           | 48.25                |             | -2.72                     |             |
| 2021.9.14                 | -29.19           | 0.02      | 48.88                | -0.63       | -1.28                     | -1.44       |
| 2022.9.14                 | -28.02           | -5.53     | 46.91                | 1.34        | -2.95                     | 0.23        |

### <Justification of the extended calibration>

The return loss is  $< -20\text{dB}$ , within 20% of prior calibration; the impedance is within 5 ohm of prior calibration. Therefore the verification result should support extended calibration.

### Dipole Verification Data> D2300V2, serial no. 1055

#### 2300MHz – Head – 2021.9.14

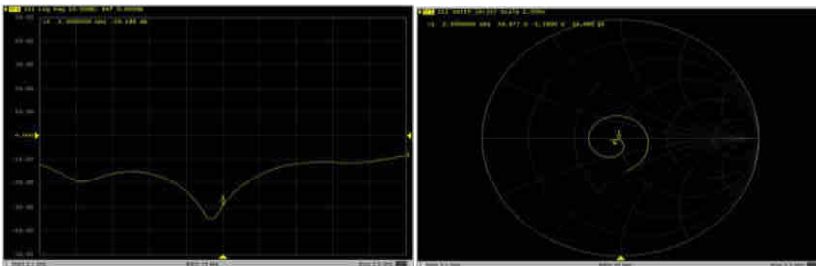

#### 2300MHz – Head – 2022.9.14

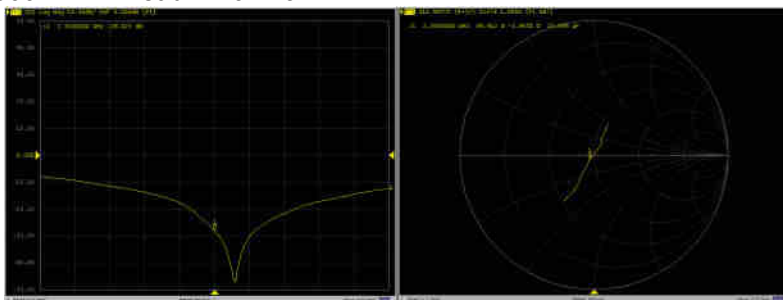



Accreditation No.: **SCS 0108**

Accredited by the Swiss Accreditation Service (SAS)  
The Swiss Accreditation Service is one of the signatories to the EA  
Multilateral Agreement for the recognition of calibration certificates

Client **Sporton**

Certificate No: **D2450V2-1095\_Dec22**

## CALIBRATION CERTIFICATE

Object **D2450V2 - SN:1095**

Calibration procedure(s) **QA CAL-05.v12  
Calibration Procedure for SAR Validation Sources between 0.7-3 GHz**

Calibration date: **December 07, 2022**

This calibration certificate documents the traceability to national standards, which realize the physical units of measurements (SI).  
The measurements and the uncertainties with confidence probability are given on the following pages and are part of the certificate.

All calibrations have been conducted in the closed laboratory facility: environment temperature ( $22 \pm 3$ )°C and humidity < 70%.

Calibration Equipment used (M&TE critical for calibration)

| Primary Standards               | ID #               | Cal Date (Certificate No.)        | Scheduled Calibration  |
|---------------------------------|--------------------|-----------------------------------|------------------------|
| Power meter NRP                 | SN: 104778         | 04-Apr-22 (No. 217-03525/03524)   | Apr-23                 |
| Power sensor NRP-Z91            | SN: 103244         | 04-Apr-22 (No. 217-03524)         | Apr-23                 |
| Power sensor NRP-Z91            | SN: 103245         | 04-Apr-22 (No. 217-03525)         | Apr-23                 |
| Reference 20 dB Attenuator      | SN: BH9394 (20k)   | 04-Apr-22 (No. 217-03527)         | Apr-23                 |
| Type-N mismatch combination     | SN: 310982 / 06327 | 04-Apr-22 (No. 217-03528)         | Apr-23                 |
| Reference Probe EX3DV4          | SN: 7349           | 31-Dec-21 (No. EX3-7349_Dec21)    | Dec-22                 |
| DAE4                            | SN: 601            | 31-Aug-22 (No. DAE4-601_Aug22)    | Aug-23                 |
| Secondary Standards             | ID #               | Check Date (in house)             | Scheduled Check        |
| Power meter E4419B              | SN: GB39512475     | 30-Oct-14 (in house check Oct-22) | In house check: Oct-24 |
| Power sensor HP 8481A           | SN: US37292783     | 07-Oct-15 (in house check Oct-22) | In house check: Oct-24 |
| Power sensor HP 8481A           | SN: MY41093315     | 07-Oct-15 (in house check Oct-22) | In house check: Oct-24 |
| RF generator R&S SMT-06         | SN: 100972         | 15-Jun-15 (in house check Oct-22) | In house check: Oct-24 |
| Network Analyzer Agilent E8358A | SN: US41080477     | 31-Mar-14 (in house check Oct-22) | In house check: Oct-24 |

|                |                |                       |           |
|----------------|----------------|-----------------------|-----------|
|                | Name           | Function              | Signature |
| Calibrated by: | Jeton Kastrati | Laboratory Technician |           |
| Approved by:   | Sven Kühn      | Technical Manager     |           |

Issued: December 7, 2022

This calibration certificate shall not be reproduced except in full without written approval of the laboratory.



Accredited by the Swiss Accreditation Service (SAS)

The Swiss Accreditation Service is one of the signatories to the EA  
Multilateral Agreement for the recognition of calibration certificates

Accreditation No.: **SCS 0108**

### Glossary:

|       |                                 |
|-------|---------------------------------|
| TSL   | tissue simulating liquid        |
| ConvF | sensitivity in TSL / NORM x,y,z |
| N/A   | not applicable or not measured  |

### Calibration is Performed According to the Following Standards:

- a) IEC/IEEE 62209-1528, "Measurement Procedure For The Assessment Of Specific Absorption Rate Of Human Exposure To Radio Frequency Fields From Hand-Held And Body-Worn Wireless Communication Devices - Part 1528: Human Models, Instrumentation And Procedures (Frequency Range of 4 MHz to 10 GHz)", October 2020.
- b) KDB 865664, "SAR Measurement Requirements for 100 MHz to 6 GHz"

### Additional Documentation:

- c) DASY System Handbook

### Methods Applied and Interpretation of Parameters:

- *Measurement Conditions:* Further details are available from the Validation Report at the end of the certificate. All figures stated in the certificate are valid at the frequency indicated.
- *Antenna Parameters with TSL:* The source is mounted in a touch configuration below the center marking of the flat phantom.
- *Return Loss:* This parameter is measured with the source positioned under the liquid filled phantom (as described in the measurement condition clause). The Return Loss ensures low reflected power. No uncertainty required.
- *SAR measured:* SAR measured at the stated antenna input power.
- *SAR normalized:* SAR as measured, normalized to an input power of 1 W at the antenna connector.
- *SAR for nominal TSL parameters:* The measured TSL parameters are used to calculate the nominal SAR result.

The reported uncertainty of measurement is stated as the standard uncertainty of measurement multiplied by the coverage factor  $k=2$ , which for a normal distribution corresponds to a coverage probability of approximately 95%.

## Measurement Conditions

DASY system configuration, as far as not given on page 1.

|                              |                        |             |
|------------------------------|------------------------|-------------|
| DASY Version                 | DASY52                 | V52.10.4    |
| Extrapolation                | Advanced Extrapolation |             |
| Phantom                      | Modular Flat Phantom   |             |
| Distance Dipole Center - TSL | 10 mm                  | with Spacer |
| Zoom Scan Resolution         | dx, dy, dz = 5 mm      |             |
| Frequency                    | 2450 MHz $\pm$ 1 MHz   |             |

## Head TSL parameters

The following parameters and calculations were applied.

|   | Temperature         | Permittivity   | Conductivity         |
|---|---------------------|----------------|----------------------|
| Nominal Head TSL parameters             | 22.0 °C             | 39.2           | 1.80 mho/m           |
| Measured Head TSL parameters            | (22.0 $\pm$ 0.2) °C | 38.4 $\pm$ 6 % | 1.87 mho/m $\pm$ 6 % |
| Head TSL temperature change during test | < 0.5 °C            | ----           | ----                 |

## SAR result with Head TSL

| SAR averaged over 1 cm <sup>3</sup> (1 g) of Head TSL | Condition          |  |
|---|--------------------|--|
| SAR measured  | 250 mW input power | 13.3 W/kg                                      |
| SAR for nominal Head TSL parameters                   | normalized to 1W   | <b>52.0 W/kg <math>\pm</math> 17.0 % (k=2)</b> |

| SAR averaged over 10 cm <sup>3</sup> (10 g) of Head TSL | condition          |  |
|---|--------------------|--|
| SAR measured  | 250 mW input power | 6.23 W/kg                                      |
| SAR for nominal Head TSL parameters                     | normalized to 1W   | <b>24.6 W/kg <math>\pm</math> 16.5 % (k=2)</b> |

## Appendix (Additional assessments outside the scope of SCS 0108)

### Antenna Parameters with Head TSL

|                                      |                                |
|--------------------------------------|--------------------------------|
| Impedance, transformed to feed point | 51.8 $\Omega$ + 6.6 j $\Omega$ |
| Return Loss                          | - 23.5 dB                      |

### General Antenna Parameters and Design

|                                  |          |
|----------------------------------|----------|
| Electrical Delay (one direction) | 1.149 ns |
|----------------------------------|----------|

After long term use with 100W radiated power, only a slight warming of the dipole near the feedpoint can be measured.

The dipole is made of standard semirigid coaxial cable. The center conductor of the feeding line is directly connected to the second arm of the dipole. The antenna is therefore short-circuited for DC-signals. On some of the dipoles, small end caps are added to the dipole arms in order to improve matching when loaded according to the position as explained in the "Measurement Conditions" paragraph. The SAR data are not affected by this change. The overall dipole length is still according to the Standard.

No excessive force must be applied to the dipole arms, because they might bend or the soldered connections near the feedpoint may be damaged.

### Additional EUT Data

|                 |       |
|-----------------|-------|
| Manufactured by | SPEAG |
|-----------------|-------|

## DASY5 Validation Report for Head TSL

Date: 07.12.2022

Test Laboratory: SPEAG, Zurich, Switzerland

**DUT: Dipole 2450 MHz; Type: D2450V2; Serial: D2450V2 - SN:1095**

Communication System: UID 0 - CW; Frequency: 2450 MHz

Medium parameters used:  $f = 2450$  MHz;  $\sigma = 1.87$  S/m;  $\epsilon_r = 38.4$ ;  $\rho = 1000$  kg/m<sup>3</sup>

Phantom section: Flat Section

Measurement Standard: DASY5 (IEEE/IEC/ANSI C63.19-2011)

DASY52 Configuration:

- Probe: EX3DV4 - SN7349; ConvF(7.96, 7.96, 7.96) @ 2450 MHz; Calibrated: 31.12.2021
- Sensor-Surface: 1.4mm (Mechanical Surface Detection)
- Electronics: DAE4 Sn601; Calibrated: 31.08.2022
- Phantom: Flat Phantom 5.0 (front); Type: QD 000 P50 AA; Serial: 1001
- DASY52 52.10.4(1535); SEMCAD X 14.6.14(7501)

### Dipole Calibration for Head Tissue/ $P_{in}=250$ mW, $d=10$ mm/Zoom Scan (7x7x7)/Cube 0:

Measurement grid:  $dx=5$ mm,  $dy=5$ mm,  $dz=5$ mm

Reference Value = 115.6 V/m; Power Drift = 0.01 dB

Peak SAR (extrapolated) = 26.0 W/kg

**SAR(1 g) = 13.3 W/kg; SAR(10 g) = 6.23 W/kg**

Smallest distance from peaks to all points 3 dB below = 9 mm

Ratio of SAR at M2 to SAR at M1 = 51.5%

Maximum value of SAR (measured) = 21.9 W/kg

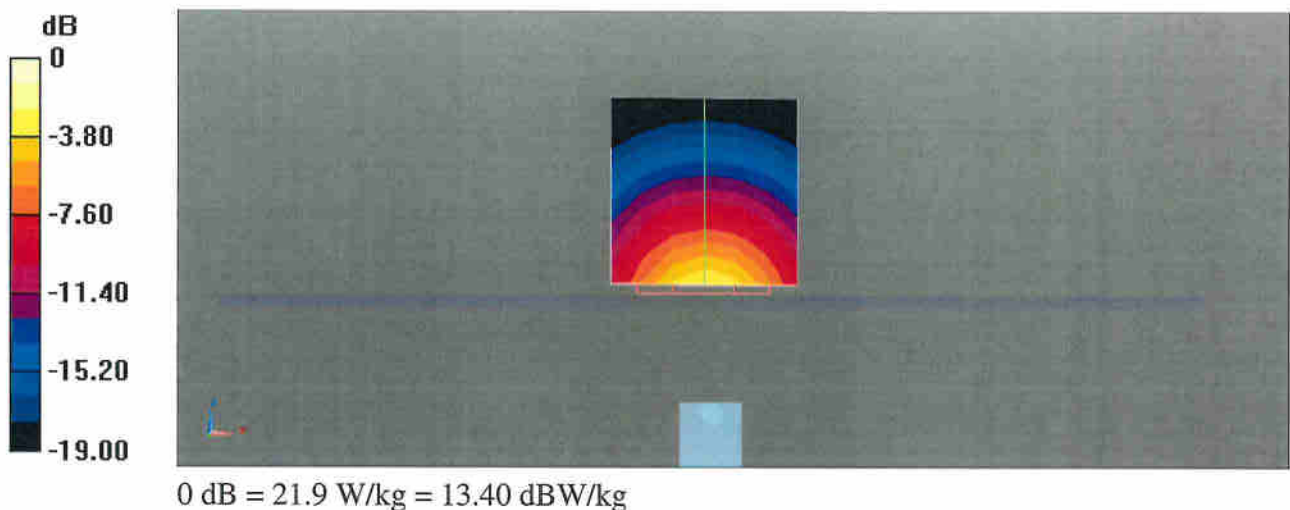



# Impedance Measurement Plot for Head TSL

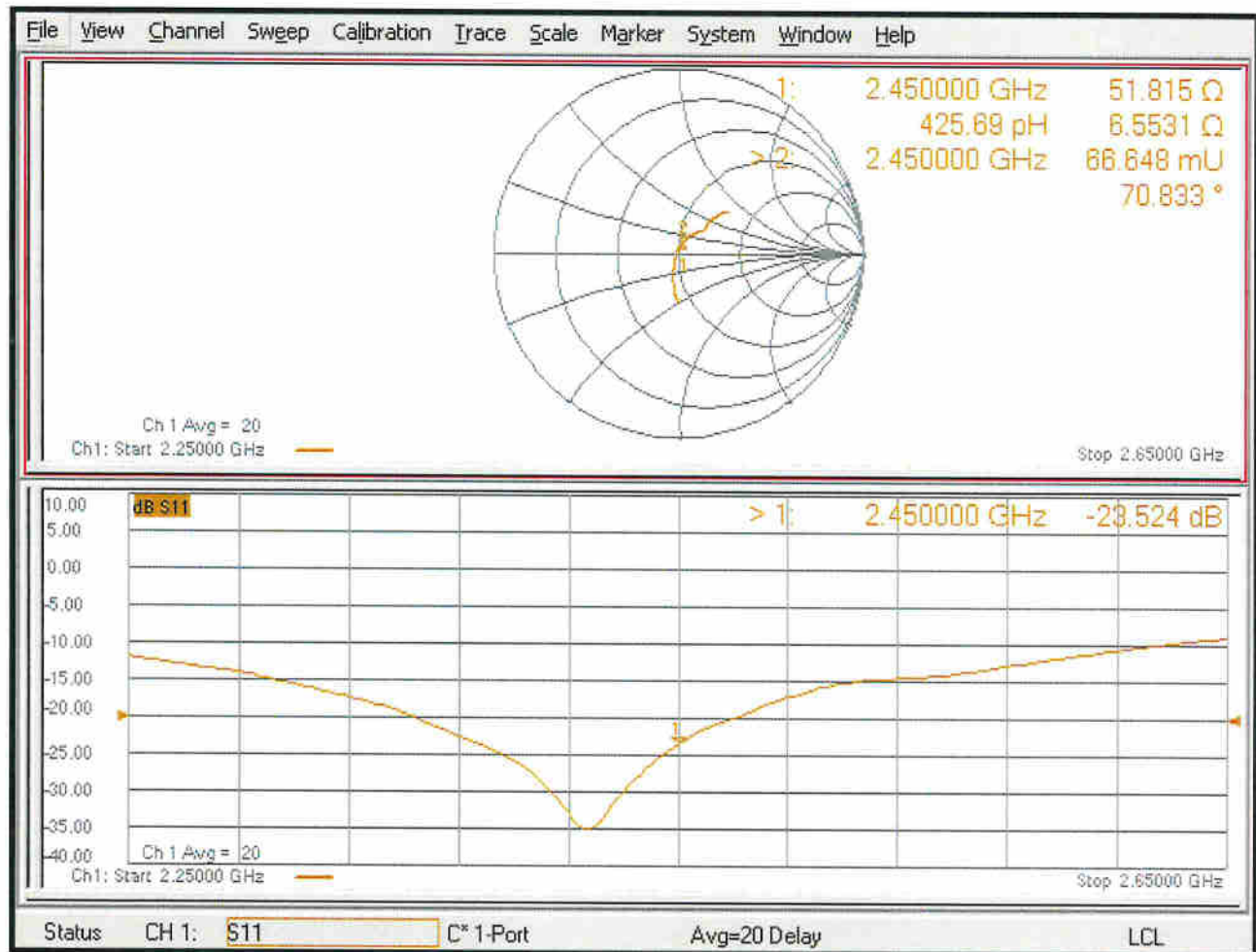

## Appendix: Transfer Calibration at Four Validation Locations on SAM Head<sup>1</sup>

### Evaluation Condition

|         |                  |                             |
|---------|------------------|-----------------------------|
| Phantom | SAM Head Phantom | For usage with cSAR3DV2-R/L |
|---------|------------------|-----------------------------|

### SAR result with SAM Head (Top $\cong$ C0)

|   |                  |  |
|---|------------------|--|
| SAR averaged over 1 cm <sup>3</sup> (1 g) of Head TSL | Condition        |  |
| SAR for nominal Head TSL parameters                   | normalized to 1W | <b>55.5 W/kg <math>\pm</math> 17.5 % (k=2)</b> |

|   |                  |  |
|---|------------------|--|
| SAR averaged over 10 cm <sup>3</sup> (10 g) of Head TSL | condition        |  |
| SAR for nominal Head TSL parameters                     | normalized to 1W | <b>26.1 W/kg <math>\pm</math> 16.9 % (k=2)</b> |

### SAR result with SAM Head (Mouth $\cong$ F90)

|   |                  |  |
|---|------------------|--|
| SAR averaged over 1 cm <sup>3</sup> (1 g) of Head TSL | Condition        |  |
| SAR for nominal Head TSL parameters                   | normalized to 1W | <b>56.6 W/kg <math>\pm</math> 17.5 % (k=2)</b> |

|   |                  |  |
|---|------------------|--|
| SAR averaged over 10 cm <sup>3</sup> (10 g) of Head TSL | condition        |  |
| SAR for nominal Head TSL parameters                     | normalized to 1W | <b>27.4 W/kg <math>\pm</math> 16.9 % (k=2)</b> |

### SAR result with SAM Head (Neck $\cong$ H0)

|   |                  |  |
|---|------------------|--|
| SAR averaged over 1 cm <sup>3</sup> (1 g) of Head TSL | Condition        |  |
| SAR for nominal Head TSL parameters                   | normalized to 1W | <b>53.3 W/kg <math>\pm</math> 17.5 % (k=2)</b> |

|   |                  |  |
|---|------------------|--|
| SAR averaged over 10 cm <sup>3</sup> (10 g) of Head TSL | condition        |  |
| SAR for nominal Head TSL parameters                     | normalized to 1W | <b>25.0 W/kg <math>\pm</math> 16.9 % (k=2)</b> |

### SAR result with SAM Head (Ear $\cong$ D90)

|   |                  |  |
|---|------------------|--|
| SAR averaged over 1 cm <sup>3</sup> (1 g) of Head TSL | Condition        |  |
| SAR for nominal Head TSL parameters                   | normalized to 1W | <b>34.1 W/kg <math>\pm</math> 17.5 % (k=2)</b> |

|   |                  |  |
|---|------------------|--|
| SAR averaged over 10 cm <sup>3</sup> (10 g) of Head TSL | condition        |  |
| SAR for nominal Head TSL parameters                     | normalized to 1W | <b>17.4 W/kg <math>\pm</math> 16.9 % (k=2)</b> |

<sup>1</sup> Additional assessments outside the current scope of SCS 0108



Accredited by the Swiss Accreditation Service (SAS)  
The Swiss Accreditation Service is one of the signatories to the EA  
Multilateral Agreement for the recognition of calibration certificates

Accreditation No.: **SCS 0108**

Client **Sporton**

Certificate No: **D2600V2-1061\_Nov20**

## CALIBRATION CERTIFICATE

Object **D2600V2 - SN:1061**

Calibration procedure(s) **QA CAL-05.v11  
Calibration Procedure for SAR Validation Sources between 0.7-3 GHz**

Calibration date: **November 26, 2020**

This calibration certificate documents the traceability to national standards, which realize the physical units of measurements (SI).  
The measurements and the uncertainties with confidence probability are given on the following pages and are part of the certificate.

All calibrations have been conducted in the closed laboratory facility: environment temperature ( $22 \pm 3$ )°C and humidity < 70%.

Calibration Equipment used (M&TE critical for calibration)

| Primary Standards               | ID #               | Cal Date (Certificate No.)        | Scheduled Calibration  |
|---------------------------------|--------------------|-----------------------------------|------------------------|
| Power meter NRP                 | SN: 104778         | 01-Apr-20 (No. 217-03100/03101)   | Apr-21                 |
| Power sensor NRP-Z91            | SN: 103244         | 01-Apr-20 (No. 217-03100)         | Apr-21                 |
| Power sensor NRP-Z91            | SN: 103245         | 01-Apr-20 (No. 217-03101)         | Apr-21                 |
| Reference 20 dB Attenuator      | SN: BH9394 (20k)   | 31-Mar-20 (No. 217-03106)         | Apr-21                 |
| Type-N mismatch combination     | SN: 310982 / 06327 | 31-Mar-20 (No. 217-03104)         | Apr-21                 |
| Reference Probe EX3DV4          | SN: 7405           | 29-Jun-20 (No. EX3-7405_Jun20)    | Jun-21                 |
| DAE4                            | SN: 601            | 02-Nov-20 (No. DAE4-601_Nov20)    | Nov-21                 |
| Secondary Standards             | ID #               | Check Date (in house)             | Scheduled Check        |
| Power meter E4419B              | SN: GB39512475     | 30-Oct-14 (in house check Oct-20) | In house check: Oct-22 |
| Power sensor HP 8481A           | SN: US37292783     | 07-Oct-15 (in house check Oct-20) | In house check: Oct-22 |
| Power sensor HP 8481A           | SN: MY41092317     | 07-Oct-15 (in house check Oct-20) | In house check: Oct-22 |
| RF generator R&S SMT-06         | SN: 100972         | 15-Jun-15 (in house check Oct-20) | In house check: Oct-22 |
| Network Analyzer Agilent E8358A | SN: US41080477     | 31-Mar-14 (in house check Oct-20) | In house check: Oct-21 |

Calibrated by: **Claudio Leubler**      Name: Claudio Leubler      Function: Laboratory Technician

Approved by: **Katja Pokovic**      Name: Katja Pokovic      Function: Technical Manager

Signature

Issued: November 26, 2020

This calibration certificate shall not be reproduced except in full without written approval of the laboratory.



Accredited by the Swiss Accreditation Service (SAS)  
The Swiss Accreditation Service is one of the signatories to the EA  
Multilateral Agreement for the recognition of calibration certificates

Accreditation No.: **SCS 0108**

### Glossary:

|       |                                 |
|-------|---------------------------------|
| TSL   | tissue simulating liquid        |
| ConvF | sensitivity in TSL / NORM x,y,z |
| N/A   | not applicable or not measured  |

### Calibration is Performed According to the Following Standards:

- IEEE Std 1528-2013, "IEEE Recommended Practice for Determining the Peak Spatial-Averaged Specific Absorption Rate (SAR) in the Human Head from Wireless Communications Devices: Measurement Techniques", June 2013
- IEC 62209-1, "Measurement procedure for the assessment of Specific Absorption Rate (SAR) from hand-held and body-mounted devices used next to the ear (frequency range of 300 MHz to 6 GHz)", July 2016
- IEC 62209-2, "Procedure to determine the Specific Absorption Rate (SAR) for wireless communication devices used in close proximity to the human body (frequency range of 30 MHz to 6 GHz)", March 2010
- KDB 865664, "SAR Measurement Requirements for 100 MHz to 6 GHz"

### Additional Documentation:

- DASY4/5 System Handbook

### Methods Applied and Interpretation of Parameters:

- Measurement Conditions:** Further details are available from the Validation Report at the end of the certificate. All figures stated in the certificate are valid at the frequency indicated.
- Antenna Parameters with TSL:** The dipole is mounted with the spacer to position its feed point exactly below the center marking of the flat phantom section, with the arms oriented parallel to the body axis.
- Feed Point Impedance and Return Loss:** These parameters are measured with the dipole positioned under the liquid filled phantom. The impedance stated is transformed from the measurement at the SMA connector to the feed point. The Return Loss ensures low reflected power. No uncertainty required.
- Electrical Delay:** One-way delay between the SMA connector and the antenna feed point. No uncertainty required.
- SAR measured:** SAR measured at the stated antenna input power.
- SAR normalized:** SAR as measured, normalized to an input power of 1 W at the antenna connector.
- SAR for nominal TSL parameters:** The measured TSL parameters are used to calculate the nominal SAR result.

The reported uncertainty of measurement is stated as the standard uncertainty of measurement multiplied by the coverage factor  $k=2$ , which for a normal distribution corresponds to a coverage probability of approximately 95%.

## Measurement Conditions

DASY system configuration, as far as not given on page 1.

|                                     |                        |             |
|-------------------------------------|------------------------|-------------|
| <b>DASY Version</b>                 | DASY5                  | V52.10.4    |
| <b>Extrapolation</b>                | Advanced Extrapolation |             |
| <b>Phantom</b>                      | Modular Flat Phantom   |             |
| <b>Distance Dipole Center - TSL</b> | 10 mm                  | with Spacer |
| <b>Zoom Scan Resolution</b>         | dx, dy, dz = 5 mm      |             |
| <b>Frequency</b>                    | 2600 MHz ± 1 MHz       |             |

## Head TSL parameters

The following parameters and calculations were applied.

|  | <b>Temperature</b> | <b>Permittivity</b> | <b>Conductivity</b> |
|--|--------------------|---------------------|---------------------|
| <b>Nominal Head TSL parameters</b>             | 22.0 °C            | 39.0                | 1.96 mho/m          |
| <b>Measured Head TSL parameters</b>            | (22.0 ± 0.2) °C    | 37.6 ± 6 %          | 2.03 mho/m ± 6 %    |
| <b>Head TSL temperature change during test</b> | < 0.5 °C           | ----                | ----                |

## SAR result with Head TSL

| <b>SAR averaged over 1 cm<sup>3</sup> (1 g) of Head TSL</b> | Condition          |                                 |
|---|--------------------|---------------------------------|
| SAR measured  | 250 mW input power | 14.5 W/kg                       |
| SAR for nominal Head TSL parameters                         | normalized to 1W   | <b>56.6 W/kg ± 17.0 % (k=2)</b> |

| <b>SAR averaged over 10 cm<sup>3</sup> (10 g) of Head TSL</b> | condition          |                                 |
|---|--------------------|---------------------------------|
| SAR measured  | 250 mW input power | 6.37 W/kg                       |
| SAR for nominal Head TSL parameters                           | normalized to 1W   | <b>25.1 W/kg ± 16.5 % (k=2)</b> |