



FCC RF Test Report

APPLICANT : Motorola Mobility LLC
EQUIPMENT : Mobile Cellular Phone
BRAND NAME : Motorola
MODEL NAME : XT2323-2, XT2323-5, XT2323-6
FCC ID : IHDT56AL9
STANDARD : 47 CFR Part 2, 96
CLASSIFICATION : Citizens Band End User Devices (CBE)
EQUIPMENT TYPE : End User Equipment
TEST DATE(S) : Apr. 25, 2023 ~ May 27, 2023

We, Sporton International Inc. (Kunshan), would like to declare that the tested sample has been evaluated in accordance with the procedures given in ANSI C63.26 and shown compliance with the applicable technical standards.

The test results in this report apply exclusively to the tested model / sample. Without written approval of Sporton International Inc. (Kunshan), the test report shall not be reproduced except in full.

Jason Jia

Approved by: Jason Jia



Sporton International Inc. (Kunshan)

**No. 1098, Pengxi North Road, Kunshan Economic Development Zone Jiangsu Province 215300
People's Republic of China**



Table of Contents

History of this test report..... 3

Summary of Test Result..... 4

1 General Description 5

 1.1 Applicant..... 5

 1.2 Manufacturer 5

 1.3 Feature of Equipment Under Test..... 5

 1.4 Specification of Accessory 6

 1.5 Re-use of Measured Data 6

 1.6 Maximum EIRP and Emission Designator 8

 1.7 Testing Site..... 8

 1.8 Test Software 8

 1.9 Applied Standards 9

2 Test Configuration of Equipment Under Test 10

 2.1 Test Mode..... 10

 2.2 Connection Diagram of Test System 11

 2.3 Support Unit used in test configuration 11

 2.4 Measurement Results Explanation Example 11

 2.5 Frequency List of Low/Middle/High Channels..... 12

3 Conducted Test Items..... 13

 3.1 Measuring Instruments..... 13

 3.2 Conducted Output Power 14

 3.3 EIRP 15

 3.4 Occupied Bandwidth 16

 3.5 Conducted Band Edge 17

 3.6 Conducted Spurious Emission 18

 3.7 Frequency Stability..... 19

4 Radiated Test Items 20

 4.1 Measuring Instruments..... 20

 4.2 Test Setup 20

 4.3 Test Result of Radiated Test..... 21

 4.4 Radiated Spurious Emission 22

5 List of Measuring Equipment..... 23

6 Uncertainty of Evaluation 24

Appendix A. Test Results of Conducted Test

Appendix B. Test Results of Radiated Test

Appendix C. Test Setup Photographs



Summary of Test Result

Report Clause	Ref Std. Clause	Test Items	Result (PASS/FAIL)	Remark
3.2	§2.1046	Conducted Output Power	Reporting only	-
-	§96.41	Peak-to-Average Ratio	Not Applicable	Not applicable for End User Devices
3.3	§96.41	Maximum E.I.R.P	Pass	-
		Maximum Power Spectral Density	Not Applicable	Not applicable for End User Devices
3.4	§2.1049 §96.41	Occupied Bandwidth	Reporting only	-
3.5	§2.1051 §96.41	Conducted Band Edge Measurement Adjacent Channel Leakage Ratio	Pass	-
3.6	§2.1051 §96.41	Conducted Spurious Emission	Pass	
3.7	§2.1055	Frequency Stability for Temperature & Voltage	Pass	-
4.4	§2.1051 §96.41	Radiated Spurious Emission	Pass	Under limit 7.68 dB at 10818.00 MHz

Conformity Assessment Condition:

1. The test results (PASS/FAIL) with all measurement uncertainty excluded are presented against the regulation limits or in accordance with the requirements stipulated by the applicant/manufacturer who shall bear all the risks of non-compliance that may potentially occur if measurement uncertainty is taken into account.
2. The measurement uncertainty please refer to each test result in the section "Measurement Uncertainty"

Disclaimer:

The product specifications of the EUT presented in the test report that may affect the test assessments are declared by the manufacturer who shall take full responsibility for the authenticity.



1 General Description

1.1 Applicant

Motorola Mobility LLC
222 W,Merchandise Mart Plaza, Chicago IL 60654 USA

1.2 Manufacturer

Motorola Mobility LLC
222 W,Merchandise Mart Plaza, Chicago IL 60654 USA

1.3 Feature of Equipment Under Test

Product Feature	
Equipment	Mobile Cellular Phone
Brand Name	Motorola
Model Name	XT2323-2, XT2323-5, XT2323-6
FCC ID	IHDT56AL9
Tx Frequency	LTE Band 48: 3550 MHz ~ 3700 MHz
Rx Frequency	LTE Band 48: 3550 MHz ~ 3700 MHz
Bandwidth	5MHz / 10MHz / 15MHz / 20MHz
Maximum Conducted Power	<Ant. 1> LTE Band 48C: 18.80 dBm <Ant. 2> LTE Band 48C: 19.26 dBm <Ant. 3> LTE Band 48C: 21.57 dBm <Ant. 5> LTE Band 48C: 22.33 dBm
Antenna Gain	<Ant. 1> LTE Band 48: -6.5 dBi <Ant. 2> LTE Band 48: -2.5 dBi <Ant. 3> LTE Band 48: -2.4 dBi <Ant. 5> LTE Band 48: -2.4 dBi
Type of Modulation	QPSK / 16QAM / 64QAM / 256QAM
IMEI Code	Conducted: 351606570017474/351606570017482 Radiation: 351606570016138/351606570016146
HW Version	DVT2
SW Version	T2TV33.23
EUT Stage	Identical Prototype

Remark:

1. The maximum EIRP is calculated from max output power and max antenna gain, so only the maximum EIRP of Ant.5 for LTE Band 48C is shown in the report.
2. The three models XT2323-2, XT2323-5, XT2323-6 are only for market differentiation, all the others are the same.



1.4 Specification of Accessory

Accessories Information				
AC Adapter	Brand Name	Motorola(Salom)	Model Name	MC-301
Base Battery	Brand Name	Motorola (ATL)	Model Name	PM29
Flip Battery	Brand Name	Motorola (ATL)	Model Name	PV11
USB Cable 1	Brand Name	Motorola(Cabletech)	Model Name	SC18D13216
USB Cable 2	Brand Name	Motorola(Luxshare)	Model Name	SC18D13217
USB Cable 3	Brand Name	Motorola(Saibao)	Model Name	SC18D13215
USB Cable 4	Brand Name	Motorola(Saibao)	Model Name	SC18D86732

1.5 Re-use of Measured Data

1.5.1 Introduction Section

This application re-uses data collected on a similar device. The subject device of this application (Model: XT2323-2, XT2323-5, XT2323-6, FCC ID: IHDT56AL9) is electrically identical to the reference device (Model: XT2323-1, FCC ID: IHDT56AL8) for the portions of the circuitry corresponding to the data being re-used. Based on their similarity, the FCC Part 96 for LTE B48 (equipment class: CBE) reuse the original model's result and do spot-check, following the FCC KDB 484596 D01 Referencing Test Data v01.

The applicant takes full responsibility that the test data as referenced in this report represent compliance for this FCC ID: IHDT56AL9.

1.5.2 Model Difference Information

The main difference between FCC ID: IHDT56AL8 and FCC ID: IHDT56AL9 is as below:

- Remove LTE B19/32/42/43/38C, 5G NR n8/n38/n40.
- Add LTE B14/29/30/46/71/5B/66B/48C, 5G NR n12/n14/n25/n29/n30/n48/n70/n71;

Other differences and all the details of similarity and difference can be found in the confidential documents (XT2323-2, XT2323-5, XT2323-6_Operational Description of Product Equality Declaration).

1.5.3 Reference detail Section:

Rule Part	Equipment Class	Frequency Band (MHz)	Reference FCC ID (Parent)	Type Grant/Permissive Change	Reference Title	FCC ID Filling (Variant)	Report Title/Section
96	CBE (LTE)	LTE B48 (Part96)	IHDT56AL8	Original Grant	FG340401F FG340401G	IHDT56AL9	All sections applicable



1.5.4 Spot Check Verification Data Section

Conducted power test and radiated spurious emission test against the variant model based on the worst-case condition from the original model was performed in this filing to demonstrate the test data from original model remains representative for the variant model.

All test procedures follow the related section of parent report.

Summary for power and RSE spot check for each rule entry and technology is listed as below:

Test Item	Mode	IHDT56AL8 Parent Worst mode Test Result	IHDT56AL9 Variant Check Test Result	Difference (dB)
Conducted Power (dBm)	LTE Band 48	23.56	22.63	0.93

Test Item	Mode	IHDT56AL8 Parent Worst Result	IHDT56AL9 Variant Check Result	Difference (dB)
Radiated Spurious Emission (dBm)	LTE Band 48	-3.50	-8.05	4.55

Conclusion:

Radiated spurious emission test against the variant model based on the worst-case condition from the original model was performed in this filing to demonstrate the test data from original model remains representative for the variant model.

Based on the spot check test result, the test data from the original model is representative for the variant model. The power level and RSE spot check are shown within expected level compliant to limit line.

We are using power and EIRP measurements from the original parent model reports to list on the grant.

The same Part 96 EUD mechanism/software is used in the variant. Hence, there is no spot check data for Part 96 EUD hand-shaking mechanism.

We confirm that the test data reuse policy of FCC KDB 484596 D01 Referencing Test Data v01 has been followed and the test data as referenced from the parent model report represents compliance with new FCC ID.



1.6 Maximum EIRP and Emission Designator

LTE Band 48C_CA	QPSK		16QAM/64QAM/256QAM	
BW (MHz) Frequency (MHz)	Maximum EIRP (W)	Emission Designator (99%OBW)	Maximum EIRP (W)	Emission Designator (99%OBW)
5MHz+20MHz	0.0966	23M3G7D	0.0918	23M4W7D
10MHz+20MHz	0.0973	28M4G7D	0.0927	28M0W7D
15MHz+20MHz	0.0966	32M9G7D	0.0916	32M9W7D
20MHz+5MHz	0.0979	23M3G7D	0.0942	23M5W7D
20MHz+10MHz	0.0964	28M1G7D	0.0918	28M0W7D
20MHz+15MHz	0.0977	32M7G7D	0.0940	32M8W7D
20MHz+20MHz	0.0984	38M0G7D	0.0953	37M7W7D

Note: All modulations have been tested, only the worst test results of PSK & QAM are shown in the report.

1.7 Testing Site

Sporton International Inc. (Kunshan) is accredited to ISO/IEC 17025:2017 by American Association for Laboratory Accreditation with Certificate Number 5145.02.

Test Firm	Sporton International Inc. (Kunshan)		
Test Site Location	No. 1098, Pengxi North Road, Kunshan Economic Development Zone Jiangsu Province 215300 People’s Republic of China TEL : +86-512-57900158		
Test Site No.	Sporton Site No.	FCC Designation No.	FCC Test Firm Registration No.
	03CH04-KS TH01-KS	CN1257	314309

1.8 Test Software

Item	Site	Manufacturer	Name	Version
1.	03CH04-KS	AUDIX	E3	6.2009-8-24al



1.9 Applied Standards

According to the specifications of the manufacturer, the EUT must comply with the requirements of the following standards:

- ♦ ANSI C63.26-2015
- ♦ 47 CFR Part 2, 96
- ♦ FCC KDB 971168 D01 Power Meas. License Digital Systems v03r01
- ♦ FCC KDB 940660 D01 Part 96 CBRS v03
- ♦ FCC KDB 412172 D01 Determining ERP and EIRP v01r01

Remark:

1. All test items were verified and recorded according to the standards and without any deviation during the test.
2. This EUT has also been tested and complied with the requirements of FCC Part 15, Subpart B, recorded in a separate test report.



2 Test Configuration of Equipment Under Test

2.1 Test Mode

Antenna port conducted and radiated test items listed below are performed according to KDB 971168 D01 Power Meas. License Digital Systems v03r01 with maximum output power.

For radiated measurement, pre-scanned flip open and close state in three orthogonal panels X, Y, Z. The worst cases (Z plane with flip open) were recorded in this report.

Test Items	Band	Bandwidth (MHz)										Modulation				RB #			Test Channel		
		20+20	20+15	15+20	20+10	10+20	20+5	5+20	15+15	15+10	10+15	QPSK	16QAM	64QAM	256QAM	1	Half	Full	L	M	H
Max. Output Power	48C_CA	v	v	v	v	v	v	v	-	-	-	v	v	v	v	v			v	v	v
Adjacent Channel Leakage Ratio	48C_CA	v	v	v	v	v	v	v	-	-	-	v	v	v	v	v		v	v	v	v
26dB and 99% Bandwidth	48C_CA	v	v	v	v	v	v	v	-	-	-	v	v					v		v	
Conducted Band Edge	48C_CA	v	v	v	v	v	v	v	-	-	-	v	v	v	v	v		v	v	v	v
Conducted Spurious Emission	48C_CA	v	v	v	v	v	v	v	-	-	-	v				v			v	v	v
E.I.R.P.	48C_CA	v	v	v	v	v	v	v	-	-	-	v	v	v	v	v			v	v	v
Frequency Stability	48C_CA	v							-	-	-	v						v		v	
Radiated Spurious Emission	48C_CA	Worst Case																v	v	v	
Note	<ol style="list-style-type: none"> The mark "v" means that this configuration is chosen for testing The mark "-" means that this bandwidth is not supported. The device is investigated from 30MHz to 10 times of fundamental signal for radiated spurious emission test under different RB size/offset and modulations in exploratory test. Subsequently, only the worst case emissions are reported. 																				

2.2 Connection Diagram of Test System

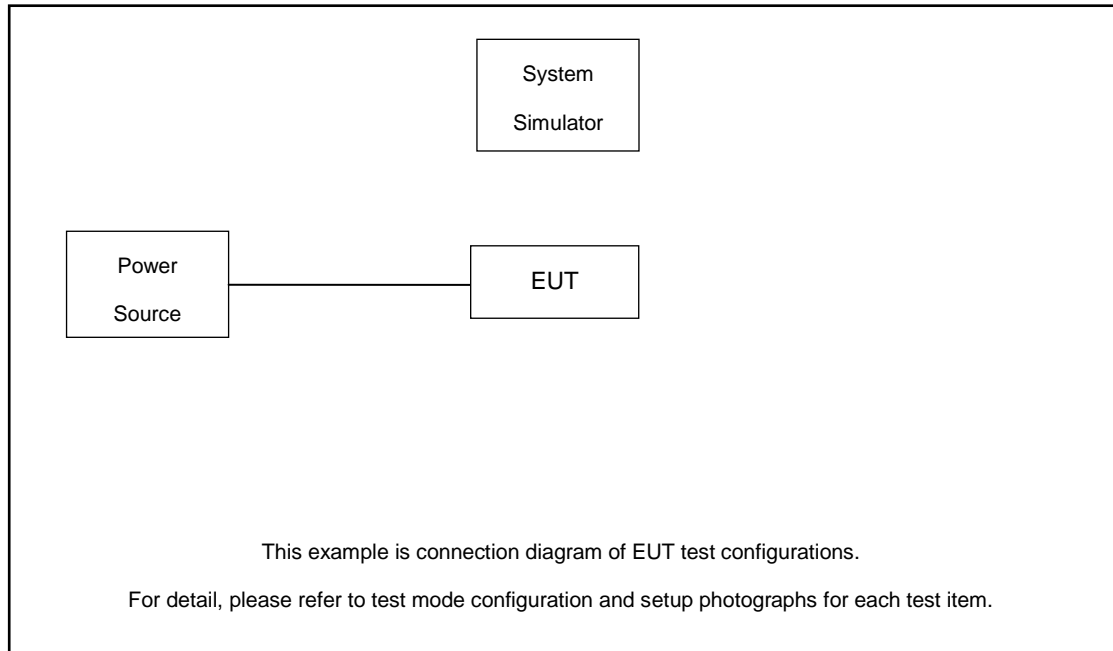

2.3 Support Unit used in test configuration

Item	Equipment	Trade Name	Model No.	FCC ID	Data Cable	Power Cord
1.	Power Supply	GWINSTEK	PSS-2002	N/A	N/A	Unshielded, 1.8 m
2.	System Simulator	Anritsu	MT8820C	N/A	N/A	Unshielded, 1.8 m

2.4 Measurement Results Explanation Example

For all conducted test items:

The offset level is set in the spectrum analyzer to compensate the RF cable loss between EUT conducted output port and spectrum analyzer. With the offset compensation, the spectrum analyzer reading level is exactly the EUT RF output level.

The spectrum analyzer offset is derived from RF cable loss.

Offset = RF cable loss.

Following shows an offset computation example with cable loss 6.6 dB.

Example :

Offset(dB) = RF cable loss(dB).

= 6.6 (dB)



2.5 Frequency List of Low/Middle/High Channels

LTE Band 48C_CA Channel and Frequency List					
BW [MHz]	Channel/Frequency(MHz)		Lowest	Middle	Highest
5 + 20	PCC	Channel	55273	55898	56523
		Frequency	3553.3	3615.8	3678.3
	SCC	Channel	55390	56015	56640
		Frequency	3565	3627.5	3690
20 + 5	PCC	Channel	55340	55965	56590
		Frequency	3560	3622.5	3685
	SCC	Channel	55457	56082	56707
		Frequency	3571.7	3634.2	3696.7
10 + 20	PCC	Channel	55295	55896	56496
		Frequency	3555.5	3615.6	3675.6
	SCC	Channel	55439	56040	56640
		Frequency	3569.9	3630	3690
20 + 10	PCC	Channel	55340	55941	56541
		Frequency	3560	3620.1	3680.1
	SCC	Channel	55484	56085	56685
		Frequency	3574.4	3634.5	3694.5
15 + 20	PCC	Channel	55318	55893	56469
		Frequency	3557.8	3615.3	3672.9
	SCC	Channel	55489	56064	56640
		Frequency	3574.9	3632.4	3690
20 + 15	PCC	Channel	55340	55916	56491
		Frequency	3560	3617.6	3675.1
	SCC	Channel	55511	56087	56662
		Frequency	3577.1	3634.7	3692.2
20 + 20	PCC	Channel	55340	55891	56442
		Frequency	3560	3615.1	3670.2
	SCC	Channel	55538	56089	56640
		Frequency	3579.8	3634.9	3690

3 Conducted Test Items

3.1 Measuring Instruments

See list of measuring instruments of this test report.

3.1.1 Test Setup

3.1.2 Conducted Output Power / ACLR

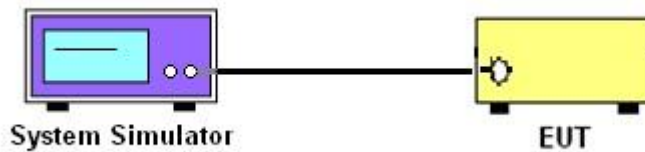

3.1.3 26dB & 99% Occupied Bandwidth, Conducted Band-Edge and Conducted Spurious Emission

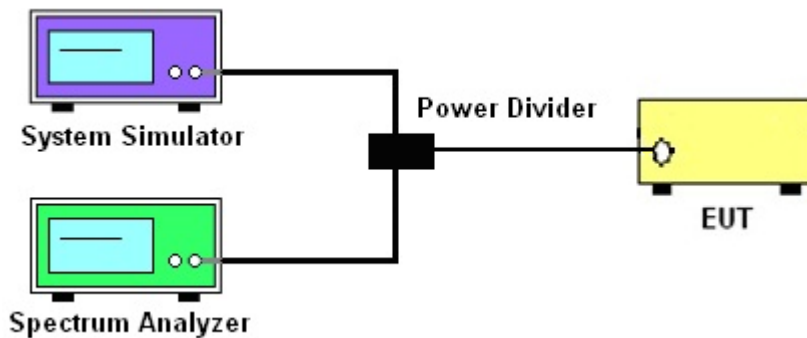

3.1.4 Frequency Stability

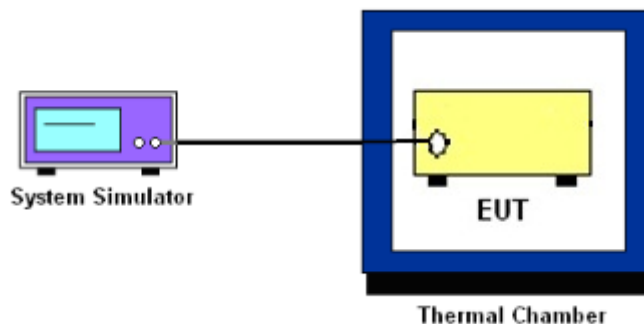

3.1.5 Test Result of Conducted Test

Please refer to Appendix A.



3.2 Conducted Output Power

3.2.1 Description of the Conducted Output Power Measurement

A system simulator was used to establish communication with the EUT. Its parameters were set to force the EUT transmitting at maximum output power. The measured power in the radio frequency on the transmitter output terminals shall be reported.

3.2.2 Test Procedures

1. The transmitter output port was connected to the system simulator.
2. Set EUT at maximum power through the system simulator.
3. Select lowest, middle, and highest channels for each band and different modulation.
4. Measure and record the power level from the system simulator.



3.3 EIRP

3.3.1 Description of the EIRP Measurement

EIRP and PSD limits for CBRS equipment as below table:

Device		Maximum EIRP (dBm/10 MHz)	Maximum PSD (dBm/MHz)
Applied	End User Device	23	N/A
<input type="checkbox"/>	Category A CBSD	30	20
<input type="checkbox"/>	Category B CBSD	47	37

Note: The total channel bandwidth EIRP comply with the limit, thus any 10MHz EIRP also comply.

3.3.2 Test Procedures for EIRP

1. Establishing a communications link with the call box (Base station) to measure the Maximum conducted power, the parameters were set to force the EUT transmitting at maximum output power level. Use the average power measurement function to measure total channel power of each channel bandwidth (per ANSI C63.26-2015 Section 5.2.1)
2. Determining ERP and/or EIRP from conducted RF output power measurements (Per ANSI C63.26-2015 Section 5.2.5.5)
 - EIRP = $P_T + G_T - L_C$, ERP = EIRP -2.15, where
 - P_T = transmitter output power in dBm
 - G_T = gain of the transmitting antenna in dBi
 - L_C = signal attenuation in the connecting cable between the transmitter and antenna in dB



3.4 Occupied Bandwidth

3.4.1 Description of Occupied Bandwidth Measurement

The occupied bandwidth is the width of a frequency band such that, below the lower and above the upper frequency limits, the mean powers emitted are each equal to a specified percentage 0.5% of the total mean transmitted power.

The 26 dB emission bandwidth is defined as the frequency range between two points, one above and one below the carrier frequency, at which the spectral density of the emission is attenuated 26 dB below the maximum in-band spectral density of the modulated signal. Spectral density (power per unit bandwidth) is to be measured with a detector of resolution bandwidth equal to approximately 1.0% of the emission bandwidth.

3.4.2 Test Procedures

The testing follows ANSI C63.26-2015 Section 5.4.3 (26dB) and Section 5.4.4 (99OB)

1. The EUT was connected to spectrum analyzer and system simulator via a power divider.
2. The spectrum analyzer center frequency is set to the nominal EUT channel center frequency. The span range for the spectrum analyzer shall be between two and five times the anticipated OBW.
3. The nominal resolution bandwidth (RBW) shall be in the range of 1 to 5 % of the anticipated OBW, and the VBW shall be at least 3 times the RBW.
4. Set the detection mode to peak, and the trace mode to max hold.
5. Determine the reference value: Set the EUT to transmit a modulated signal. Allow the trace to stabilize. Set the spectrum analyzer marker to the highest level of the displayed trace.
(this is the reference value)
6. Determine the “-26 dB down amplitude” as equal to (Reference Value – X).
7. Place two markers, one at the lowest and the other at the highest frequency of the envelope of the spectral display such that each marker is at or slightly below the “-X dB down amplitude” determined in step 6. If a marker is below this “-X dB down amplitude” value it shall be placed as close as possible to this value. The OBW is the positive frequency difference between the two markers.
8. Use the 99 % power bandwidth function of the spectrum analyzer and report the measured bandwidth.



3.5 Conducted Band Edge

3.5.1 Description of Conducted Band Edge Measurement

Part 96.41 (e) (1) (ii)

For End User Devices the emission limits outside the fundamental are as follows:

Within 0 MHz to B MHz above and below the assigned channel ≤ -13 dBm/MHz

Greater than B MHz above and below the assigned channel ≤ -25 dBm/MHz

where B is the bandwidth in megahertz of the assigned channel or multiple contiguous channels of the End User Device.

Notwithstanding the emission limits in this paragraph, the Adjacent Channel Leakage Ratio for End User Devices shall be at least 30 dB.

Part 96.41 (e) (2)

For CBSDs and End User Devices, the conducted power of emissions below 3540 MHz or above 3710 MHz shall not exceed -25 dBm/MHz, and the conducted power of emissions below 3530 MHz or above 3720 MHz shall not exceed -40 dBm/MHz

3.5.2 Test Procedures

The testing follows FCC KDB 971168 D01 v03r01 Section 6.1.

1. The EUT was connected to spectrum analyzer and system simulator via a power divider.
2. The band edges of low and high channels for the highest RF powers were measured.
3. Set RBW $\geq 1\%$ EBW in the 1MHz band immediately outside and adjacent to the band edge.
4. Beyond the 1 MHz band from the band edge, RBW=1MHz was used
5. Offset has included the duty factor for LTE Band 48. Duty factor $=10 \log (1/x)$, where x is the measured duty cycle.
6. Set spectrum analyzer with RMS detector.
7. The RF fundamental frequency should be excluded against the limit line in the operating frequency band.



3.6 Conducted Spurious Emission

3.6.1 Description of Conducted Spurious Emission Measurement

96.41 (e)(2)

The conducted power of any emissions below 3530 MHz or above 3720 MHz shall not exceed -40dBm/MHz.

3.6.2 Test Procedures

The testing follows FCC KDB 971168 D01 v03r01 Section 6.1.

1. The EUT was connected to spectrum analyzer and system simulator via a power divider.
2. The RF output of EUT was connected to the spectrum analyzer by RF cable and attenuator. The path loss was compensated to the results for each measurement.
3. The middle channel for the highest RF power within the transmitting frequency was measured.
4. The conducted spurious emission for the whole frequency range was taken.
5. Make the measurement with the spectrum analyzer's RBW = 1MHz, VBW = 3MHz.
6. Set spectrum analyzer with RMS detector.
7. Taking the record of maximum spurious emission.
8. The RF fundamental frequency should be excluded against the limit line in the operating frequency band.
9. The limit line is -40dBm/MHz.



3.7 Frequency Stability

3.7.1 Description of Frequency Stability Measurement

The frequency stability shall be measured by variation of ambient temperature and variation of primary supply voltage to ensure that the fundamental emission stays within the authorized frequency block. The frequency stability of the transmitter shall be maintained within $\pm 0.00025\%$ ($\pm 2.5\text{ppm}$) of the center frequency

3.7.2 Test Procedures for Temperature Variation

The testing follows FCC KDB 971168 D01 v03r01 Section 9.0.

1. The EUT was set up in the thermal chamber and connected with the system simulator.
2. With power OFF, the temperature was decreased to -30°C and the EUT was stabilized before testing. Power was applied and the maximum change in frequency was recorded within one minute.
3. With power OFF, the temperature was raised in 10°C step up to 50°C . The EUT was stabilized at each step for at least half an hour. Power was applied and the maximum frequency change was recorded within one minute.

3.7.3 Test Procedures for Voltage Variation

The testing follows FCC KDB 971168 D01 v03r01 Section 9.0.

1. The EUT was placed in a temperature chamber at $25\pm 5^{\circ}\text{C}$ and connected with the system simulator.
2. The power supply voltage to the EUT was varied from 85% to 115% of the nominal value measured at the input to the EUT.
3. The variation in frequency was measured for the worst case.

4 Radiated Test Items

4.1 Measuring Instruments

See list of measuring instruments of this test report.

4.2 Test Setup

4.2.1 For radiated test below 30MHz

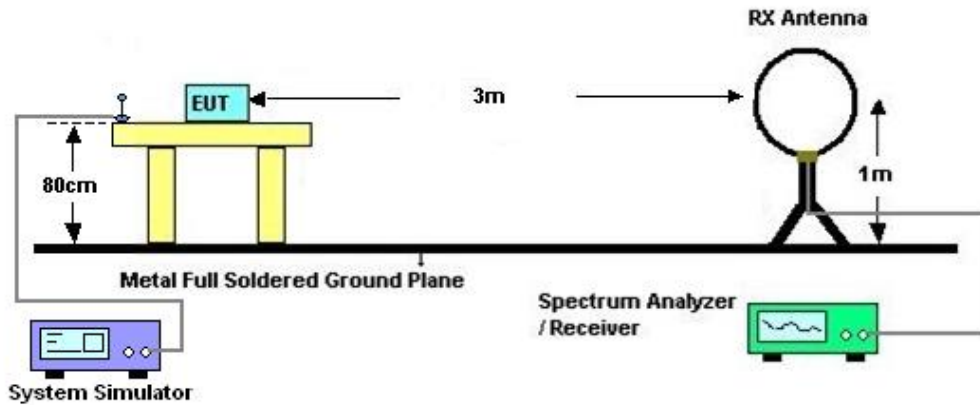

4.2.2 For radiated test from 30MHz to 1GHz

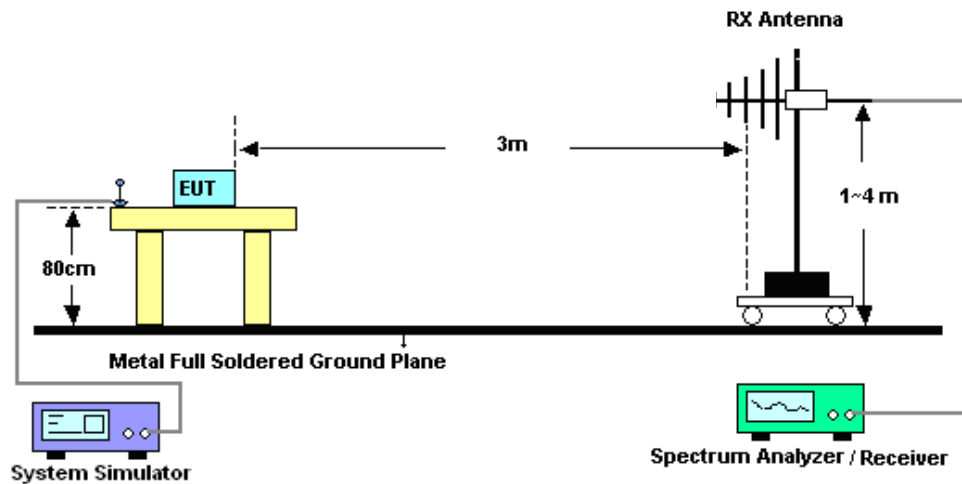

4.2.3 For radiated test above 1GHz

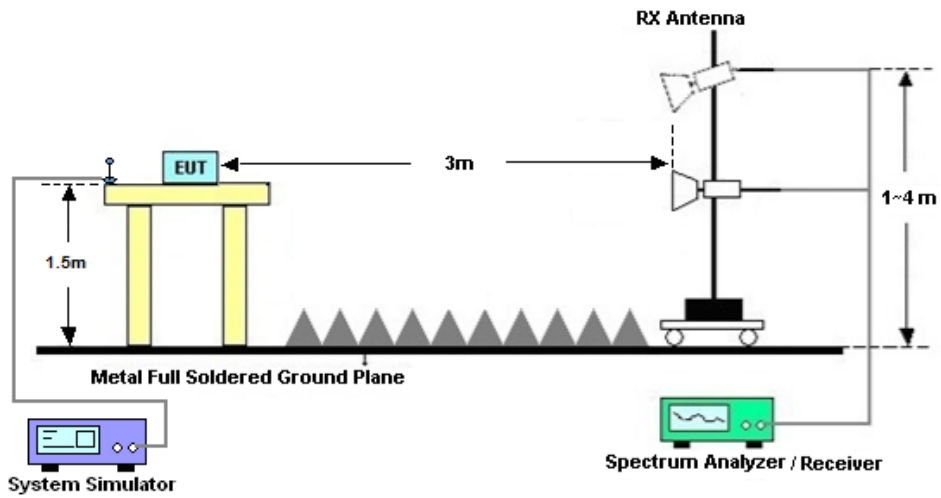

4.3 Test Result of Radiated Test

The low frequency, which started from 9 kHz to 30MHz, was pre-scanned and the result which was 20dB lower than the limit line was not reported.

Please refer to Appendix B.



4.4 Radiated Spurious Emission

4.4.1 Description of Radiated Spurious Emission Measurement

The radiated spurious emission was measured by substitution method according to ANSI C63.26-2015. The power of any emission outside of the authorized operating frequency ranges must be attenuated below the transmitter power (P) by a factor of at least -40dBm / MHz. The spectrum is scanned from 30 MHz up to a frequency including its 10th harmonic.

4.4.2 Test Procedures

1. The EUT was placed on a turntable with 0.8 meter height for frequency below 1GHz and 1.5 meter height for frequency above 1GHz respectively above ground.
2. The EUT was set 3 meters from the receiving antenna mounted on the antenna tower.
3. The table was rotated 360 degrees to determine the position of the highest spurious emission.
4. The height of the receiving antenna is varied between 1m to 4m to search the maximum spurious emission for both horizontal and vertical polarizations.
5. During the measurement, the system simulator parameters were set to force the EUT transmitting at maximum output power.
6. Make the measurement with the spectrum analyzer's RBW = 1MHz, VBW = 3MHz, taking the record of maximum spurious emission.
7. A horn antenna was substituted in place of the EUT and was driven by a signal generator. Tune the output power of signal generator to the same emission level with EUT maximum spurious emission.
$$\text{EIRP (dBm)} = \text{S.G. Power} - \text{Tx Cable Loss} + \text{Tx Antenna Gain}$$
$$\text{ERP (dBm)} = \text{EIRP} - 2.15$$
8. The RF fundamental frequency should be excluded against the limit line in the operating frequency band.
The limit line is -40dBm/MHz



5 List of Measuring Equipment

Instrument	Manufacturer	Model No.	Serial No.	Characteristics	Calibration Date	Test Date	Due Date	Remark
Spectrum Analyzer	R&S	FSV40	101040	10Hz~40GHz	Oct. 12, 2022	Apr. 25, 2023~ May 27, 2023	Oct. 11, 2023	Conducted (TH01-KS)
Power divider	STI	STI08-0055	-	0.5~40GHz	NCR	Apr. 25, 2023~ May 27, 2023	NCR	Conducted (TH01-KS)
Temperature & humidity chamber	Hongzhan	LP-150U	H2014011 440	-40~+150°C 20%~95%RH	Jul. 15, 2022	Apr. 25, 2023~ May 27, 2023	Jul. 14, 2023	Conducted (TH01-KS)
EXA Spectrum Analyzer	Keysight	N9010B	MY574710 79	10Hz-44G,MAX 30dB	Oct. 12, 2022	May 25, 2023	Oct. 11, 2023	Radiation (03CH04-KS)
Loop Antenna	R&S	HFH2-Z2	100321	9kHz~30MHz	Oct. 16, 2022	May 25, 2023	Oct. 15, 2023	Radiation (03CH04-KS)
Bilog Antenna	TeseQ	CBL6111D	49922	30MHz-1GHz	Apr. 09, 2023	May 25, 2023	Apr. 08, 2024	Radiation (03CH04-KS)
Horn Antenna	Schwarzbeck	BBHA9120D	1284	1GHz~18GHz	Oct. 16, 2022	May 25, 2023	Oct. 15, 2023	Radiation (03CH04-KS)
SHF-EHF Horn	Com-power	AH-840	101070	18GHz~40GHz	Jan. 08, 2023	May 25, 2023	Jan. 07, 2024	Radiation (03CH04-KS)
Amplifier	SONOMA	310N	380827	9KHz-1GHz	Jul. 11, 2022	May 25, 2023	Jul. 10, 2023	Radiation (03CH04-KS)
Amplifier	MITEQ	EM18G40GG A	060728	18~40GHz	Jan. 05, 2023	May 25, 2023	Jan. 04, 2024	Radiation (03CH04-KS)
high gain Amplifier	EM	EM01G18GA	060840	1Ghz-18Ghz	Oct. 12, 2022	May 25, 2023	Oct. 11, 2023	Radiation (03CH04-KS)
Amplifier	Agilent	8449B	3008A023 70	1Ghz-18Ghz	Oct. 12, 2022	May 25, 2023	Oct. 11, 2023	Radiation (03CH04-KS)
AC Power Source	Chroma	61601	F1040900 04	N/A	NCR	May 25, 2023	NCR	Radiation (03CH04-KS)
Turn Table	ChamPro	EM 1000-T	060762-T	0~360 degree	NCR	May 25, 2023	NCR	Radiation (03CH04-KS)
Antenna Mast	ChamPro	EM 1000-A	060762-A	1 m~4 m	NCR	May 25, 2023	NCR	Radiation (03CH04-KS)

NCR: No Calibration Required



6 Uncertainty of Evaluation

Uncertainty of Conducted Measurement

Test Item	Uncertainty
Conducted Power	±0.46 dB
Conducted Emissions	±0.48 dB
Occupied Channel Bandwidth	±0.1 %

Uncertainty of Radiated Emission Measurement (30 MHz ~ 1000 MHz)

Measuring Uncertainty for a Level of Confidence of 95% (U = 2Uc(y))	3.82 dB
---	---------

Uncertainty of Radiated Emission Measurement (1 GHz ~ 18 GHz)

Measuring Uncertainty for a Level of Confidence of 95% (U = 2Uc(y))	3.56 dB
---	---------

Uncertainty of Radiated Emission Measurement (18 GHz ~ 40 GHz)

Measuring Uncertainty for a Level of Confidence of 95% (U = 2Uc(y))	3.54 dB
---	---------

----- THE END -----



Appendix A. Test Results of Conducted Test

Test Engineer :	Simle Wang	Temperature :	22~23°C
		Relative Humidity :	40~42%

Conducted Output Power(Average power) and EIRP

LTE Band 48C (Ant.5):

Combination 20MHz+20MHz (100RB+100RB)							
Channel	Modulation	PCC		SCC		Measured Power	EIRP(W)
		RB Size	RB offset	RB Size	RB offset		
L	QPSK	1	Max	1	0	22.30	0.0977
M	QPSK	1	Max	1	0	22.33	0.0984
H	QPSK	1	Max	1	0	22.25	0.0966
L	16QAM	1	Max	1	0	22.19	0.0953
M	16QAM	1	Max	1	0	22.14	0.0942
H	16QAM	1	Max	1	0	22.16	0.0946
L	64QAM	1	Max	1	0	22.09	0.0931
M	64QAM	1	Max	1	0	22.05	0.0923
H	64QAM	1	Max	1	0	22.01	0.0914
L	256QAM	1	Max	1	0	20.87	0.0703
M	256QAM	1	Max	1	0	20.85	0.0700
H	256QAM	1	Max	1	0	20.83	0.0697
Combination 20MHz+15MHz (100RB+75RB)							
Channel	Modulation	PCC		SCC		Measured Power	EIRP(W)
		RB Size	RB offset	RB Size	RB offset		
M	QPSK	1	Max	1	0	22.30	0.0977
L	16QAM	1	Max	1	0	22.13	0.0940
Combination 15MHz+20MHz (100RB+75RB)							
Channel	Modulation	PCC		SCC		Measured Power	EIRP(W)
		RB Size	RB offset	RB Size	RB offset		
M	QPSK	1	Max	1	0	22.25	0.0966
L	16QAM	1	Max	1	0	22.02	0.0916
Combination 20MHz+10MHz (100RB+50RB)							
Channel	Modulation	PCC		SCC		Measured Power	EIRP(W)
		RB Size	RB offset	RB Size	RB offset		
M	QPSK	1	Max	1	0	22.24	0.0964
L	16QAM	1	Max	1	0	22.03	0.0918
Combination 10MHz+20MHz (50RB+100RB)							
Channel	Modulation	PCC		SCC		Measured Power	EIRP(W)
		RB Size	RB offset	RB Size	RB offset		
M	QPSK	1	Max	1	0	22.28	0.0973
L	16QAM	1	Max	1	0	22.07	0.0927



Combination 20MHz+5MHz (100RB+25RB)							
Channel	Modulation	PCC		SCC		Measured Power	EIRP(W)
		RB Size	RB offset	RB Size	RB offset		
M	QPSK	1	Max	1	0	22.31	0.0979
L	16QAM	1	Max	1	0	22.14	0.0942
Combination 5MHz+20MHz (25RB+100RB)							
Channel	Modulation	PCC		SCC		Measured Power	EIRP(W)
		RB Size	RB offset	RB Size	RB offset		
M	QPSK	1	Max	1	0	22.25	0.0966
L	16QAM	1	Max	1	0	22.03	0.0918



LTE Band 48C

26dB Bandwidth

Mode	LTE Band 48C : 26dB BW(MHz)	
Modulation	QPSK	16QAM
BW	5MHz+20MHz	5MHz+20MHz
Middle CH	25.03	24.93
BW	10MHz+20MHz	10MHz+20MHz
Middle CH	29.91	29.97
BW	15MHz+20MHz	15MHz+20MHz
Middle CH	34.97	34.97
BW	20MHz+5MHz	20MHz+5MHz
Middle CH	24.88	24.93
BW	20MHz+10MHz	20MHz+10MHz
Middle CH	29.91	30.03
BW	20MHz+15MHz	20MHz+15MHz
Middle CH	35.11	34.83
BW	20MHz+20MHz	20MHz+20MHz
Middle CH	39.90	39.96

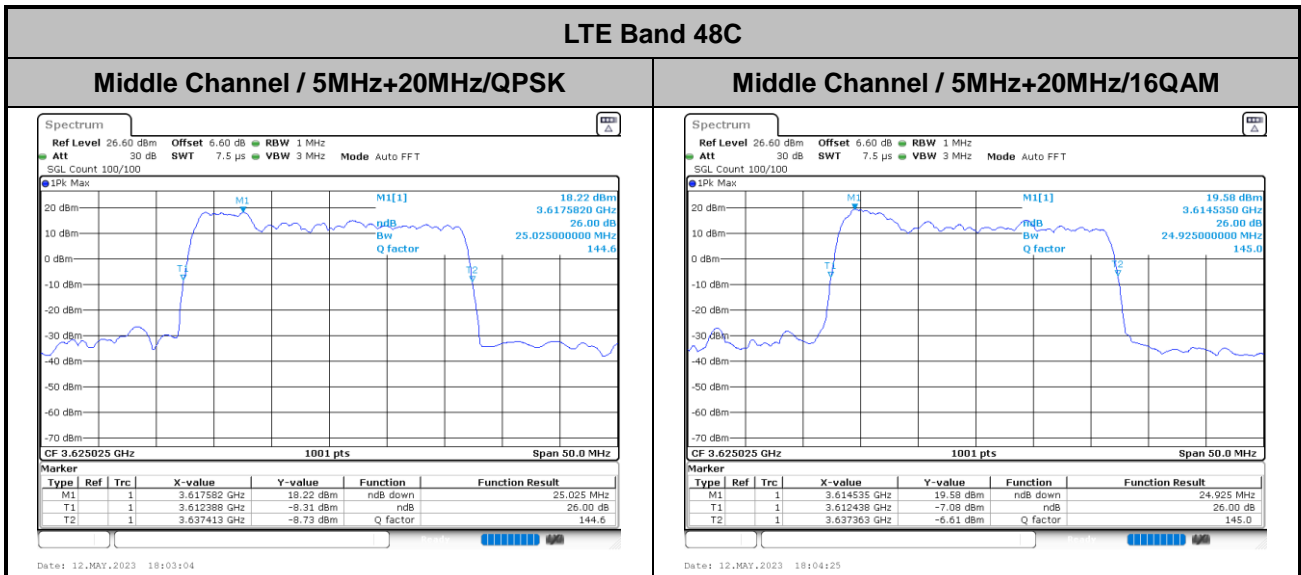



LTE Band 48C

Middle Channel / 10MHz+20MHz/QPSK

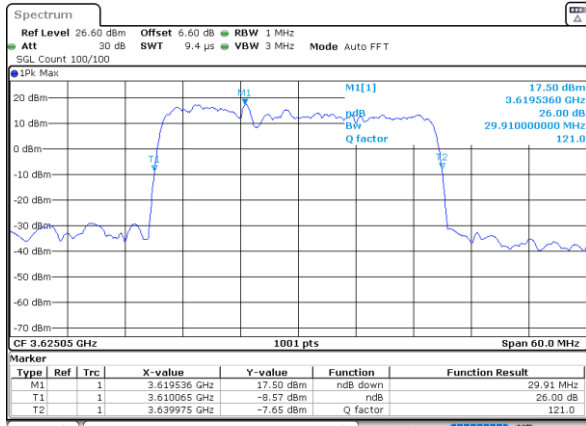

Date: 12.MAY.2023 18:05:33

Middle Channel / 10MHz+20MHz/16QAM

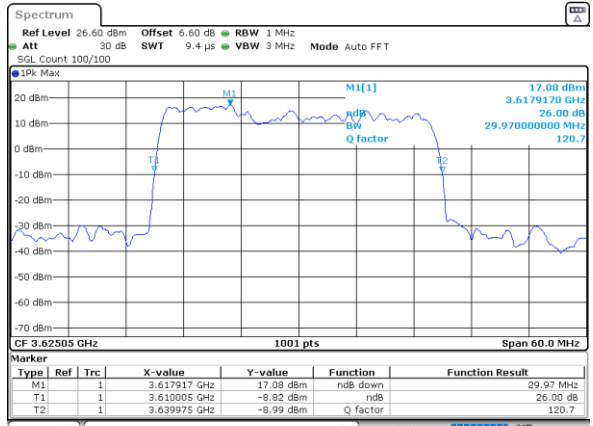

Date: 12.MAY.2023 18:06:53

LTE Band 48C

Middle Channel / 15MHz+20MHz/QPSK

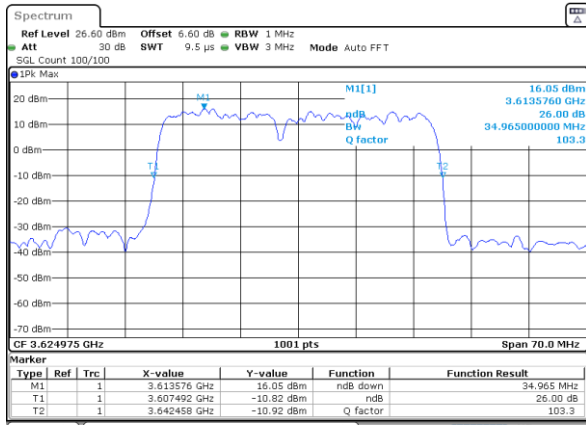

Date: 12.MAY.2023 18:07:50

Middle Channel / 15MHz+20MHz/16QAM

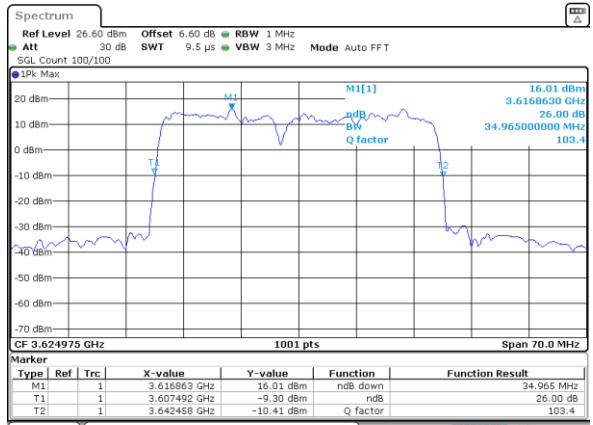

Date: 12.MAY.2023 18:09:12

LTE Band 48C

Middle Channel / 20MHz+5MHz/QPSK

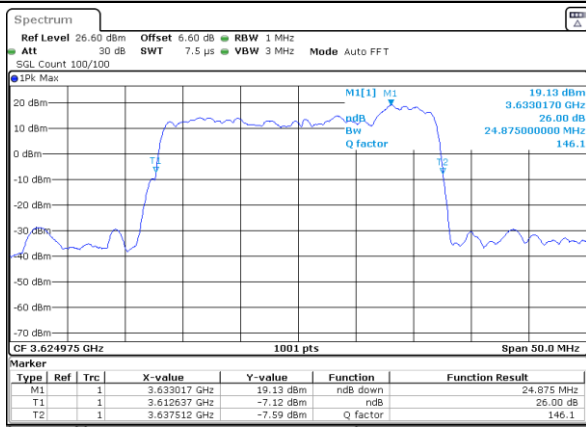

Date: 12.MAY.2023 18:10:26

Middle Channel / 20MHz+5MHz/16QAM

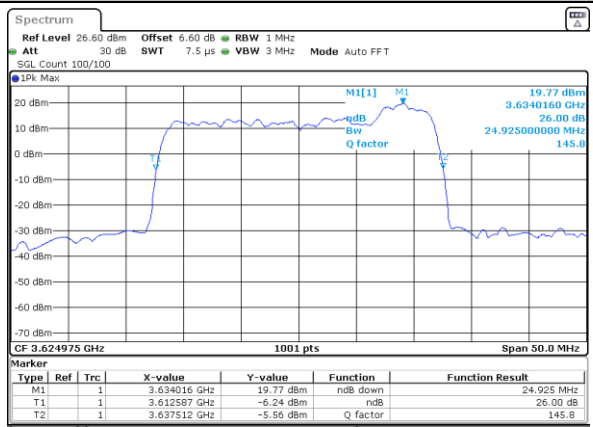

Date: 12.MAY.2023 18:11:48



LTE Band 48C

Middle Channel / 20MHz+10MHz/QPSK

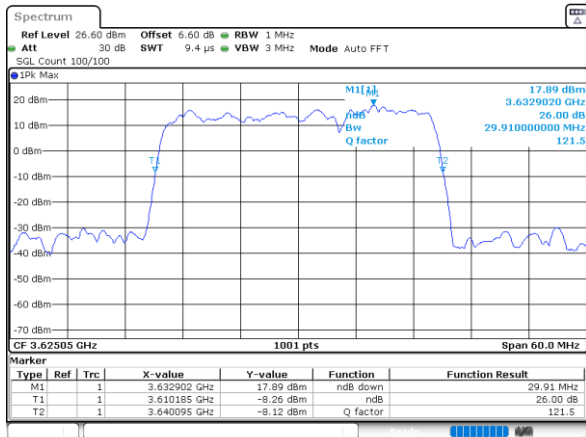

Middle Channel / 20MHz+10MHz/16QAM

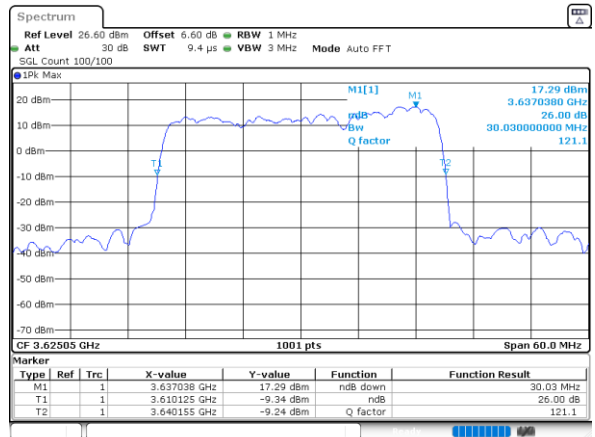

LTE Band 48C

Middle Channel / 20MHz+15MHz/QPSK

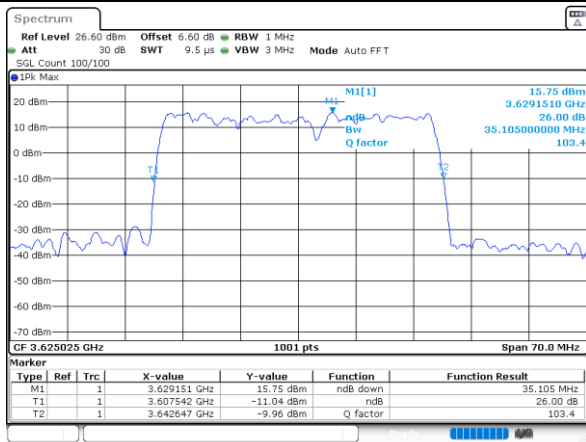

Middle Channel / 20MHz+15MHz/16QAM

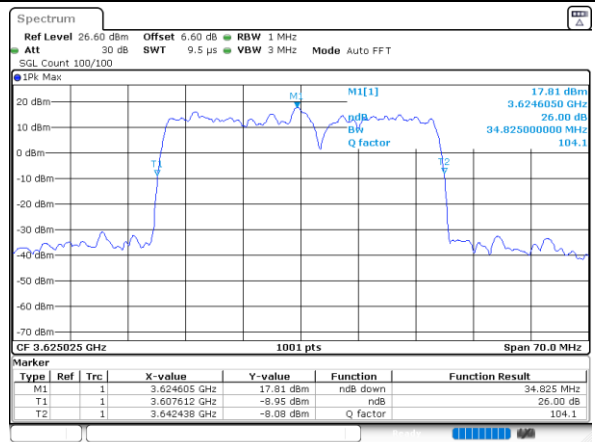

LTE Band 48C

Middle Channel / 20MHz+20MHz/QPSK

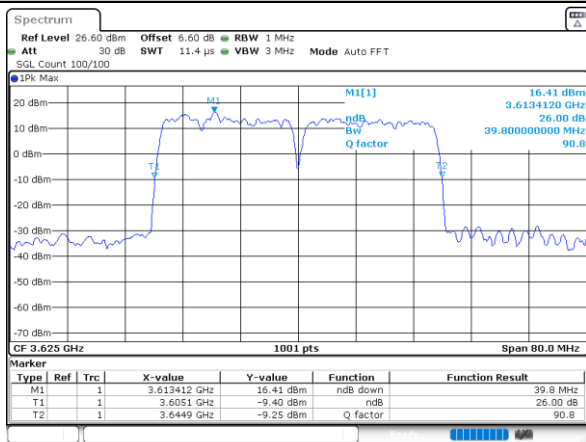

Middle Channel / 20MHz+20MHz/16QAM

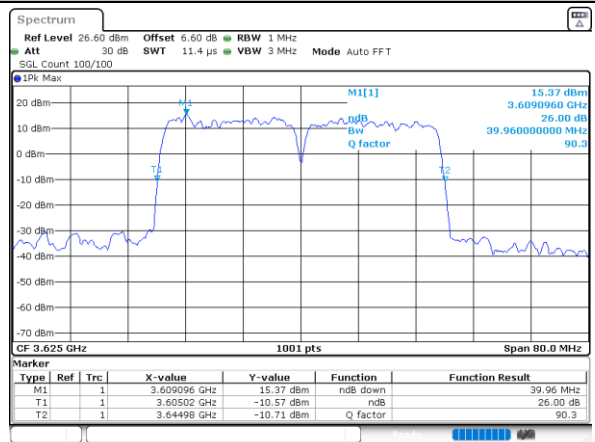



Occupied Bandwidth

Mode	LTE Band 48C : OBW(MHz)	
Modulation	QPSK	16QAM
BW	5MHz+20MHz	5MHz+20MHz
Middle CH	23.33	23.43
BW	10MHz+20MHz	10MHz+20MHz
Middle CH	28.35	27.99
BW	15MHz+20MHz	15MHz+20MHz
Middle CH	32.87	32.94
BW	20MHz+5MHz	20MHz+5MHz
Middle CH	23.28	23.53
BW	20MHz+10MHz	20MHz+10MHz
Middle CH	28.11	27.99
BW	20MHz+15MHz	20MHz+15MHz
Middle CH	32.73	32.80
BW	20MHz+20MHz	20MHz+20MHz
Middle CH	38.04	37.72

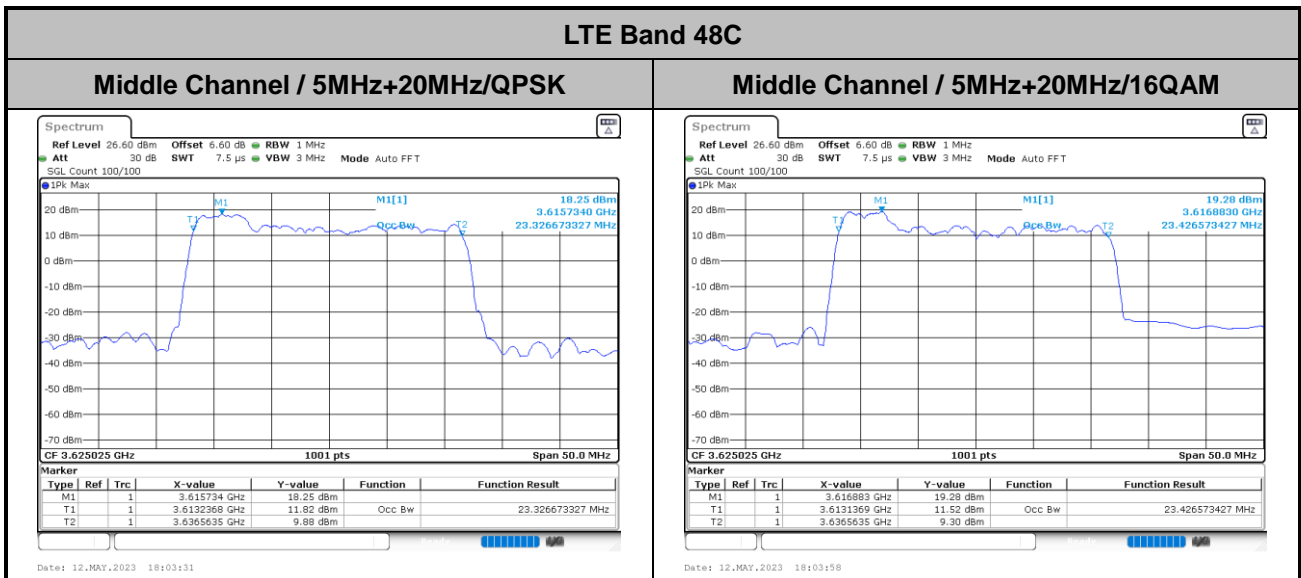



LTE Band 48C

Middle Channel / 10MHz+20MHz/QPSK

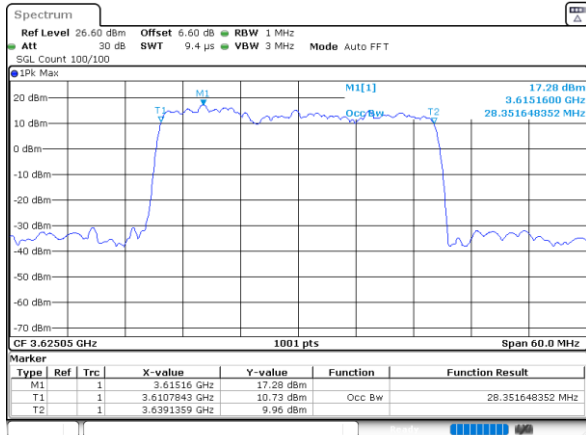

Date: 12.MAY.2023 18:05:58

Middle Channel / 10MHz+20MHz/16QAM

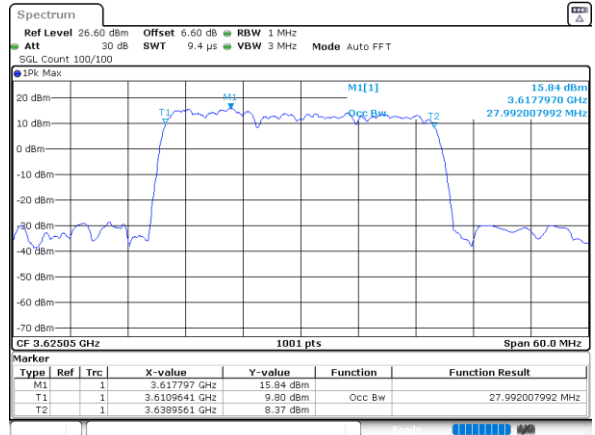

Date: 12.MAY.2023 18:06:26

LTE Band 48C

Middle Channel / 15MHz+20MHz/QPSK

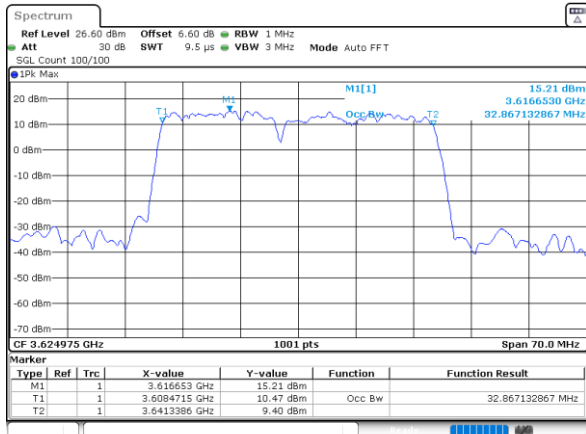

Date: 12.MAY.2023 18:08:17

Middle Channel / 15MHz+20MHz/16QAM

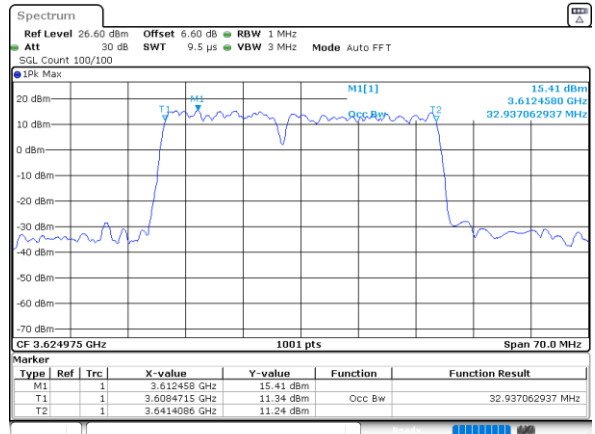

Date: 12.MAY.2023 18:08:45

LTE Band 48C

Middle Channel / 20MHz+5MHz/QPSK

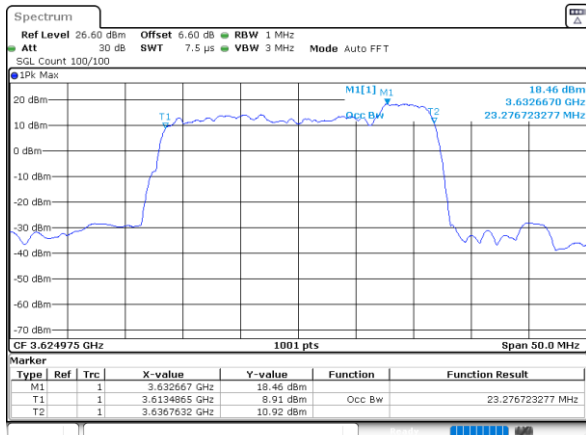

Date: 12.MAY.2023 18:10:53

Middle Channel / 20MHz+5MHz/16QAM

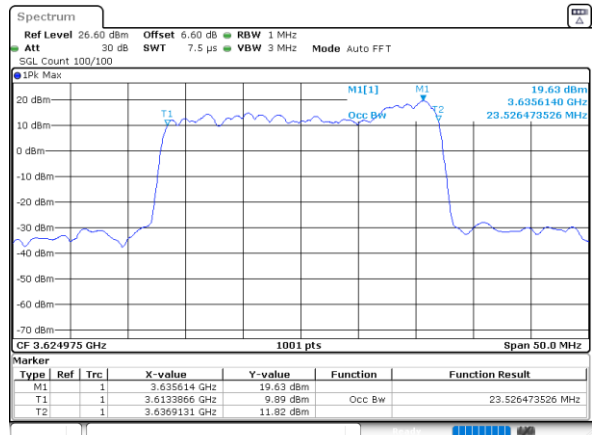

Date: 12.MAY.2023 18:11:21



LTE Band 48C

Middle Channel / 20MHz+10MHz/QPSK

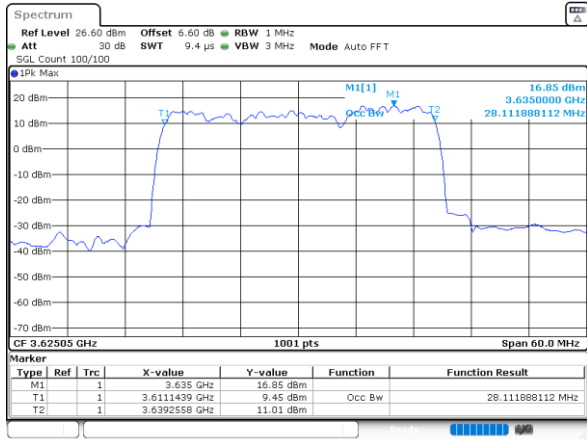

Date: 12.MAY.2023 18:12:49

Middle Channel / 20MHz+10MHz/16QAM

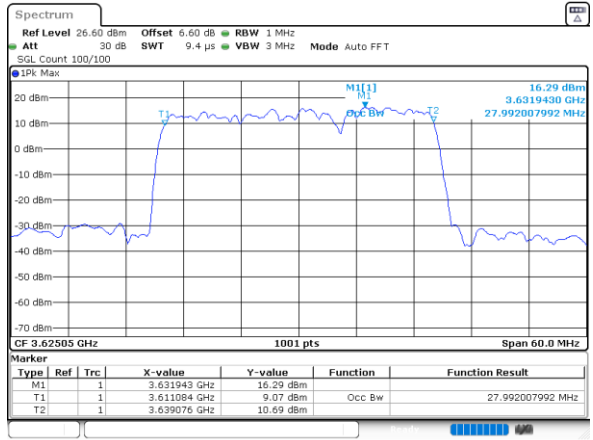

Date: 12.MAY.2023 18:13:17

LTE Band 48C

Middle Channel / 20MHz+15MHz/QPSK

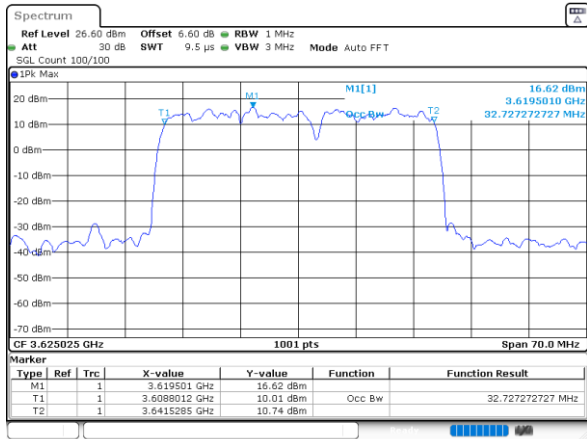

Date: 12.MAY.2023 18:14:45

Middle Channel / 20MHz+15MHz/16QAM

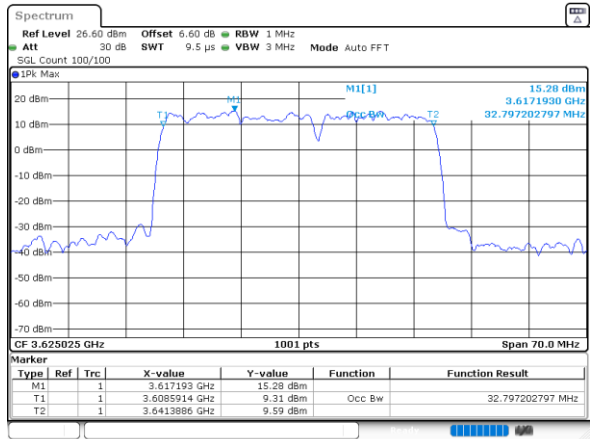

Date: 12.MAY.2023 18:15:12

LTE Band 48C

Middle Channel / 20MHz+20MHz/QPSK

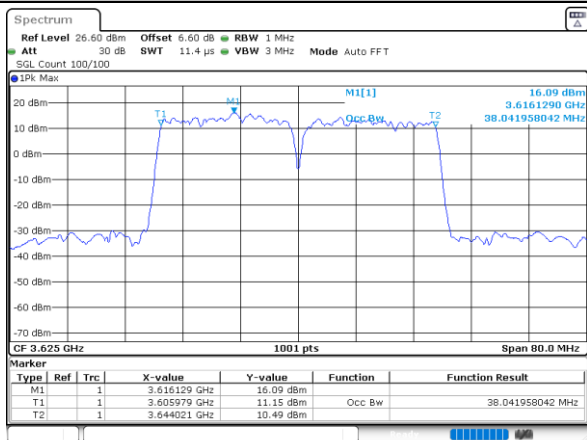

Date: 12.MAY.2023 18:16:40

Middle Channel / 20MHz+20MHz/16QAM

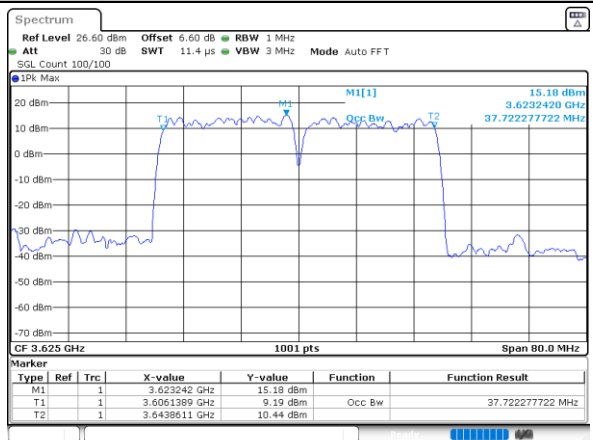

Date: 12.MAY.2023 18:17:08



Conducted Band Edge

LTE Band 48C / 5MHz+20MHz

QPSK

Lowest Band Edge / 1RB0 and 1RB99

Middle Band Edge / 1RB0 and 1RB99

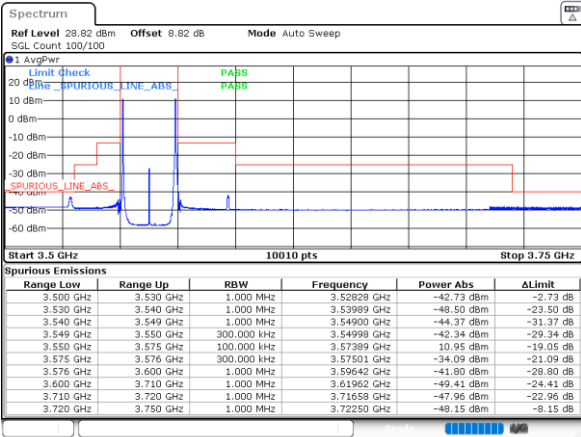

Date: 12.MAY.2023 00:35:27

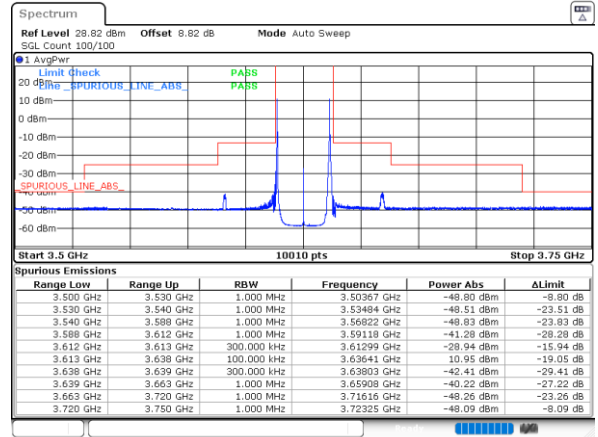

Date: 11.MAY.2023 23:47:05

Lowest Band Edge / 1RB24 and 1RB0

Middle Band Edge / 1RB24 and 1RB0

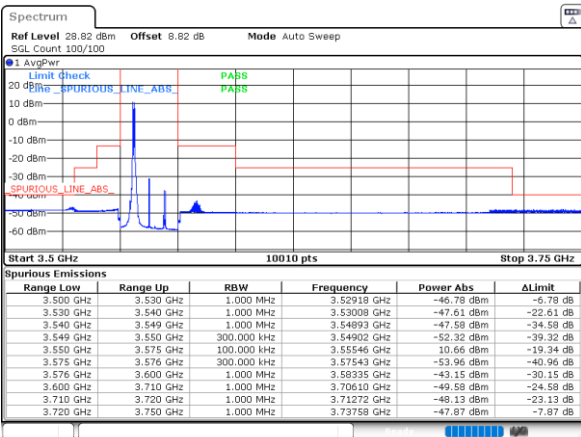

Date: 12.MAY.2023 00:44:04

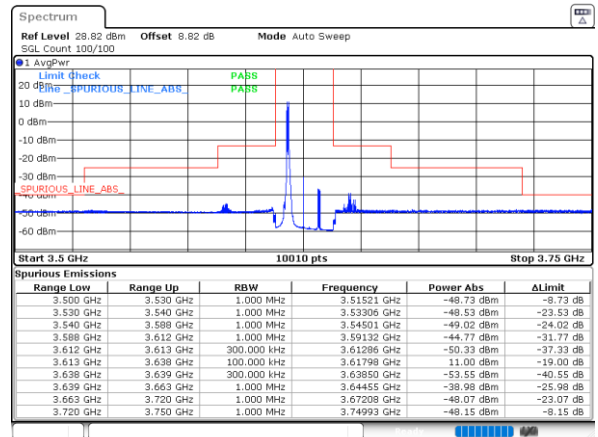

Date: 12.MAY.2023 00:27:08



Lowest Band Edge / Full RB

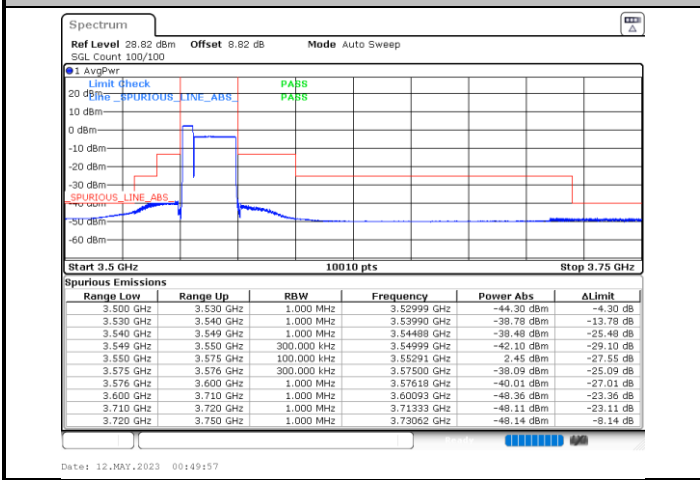

Middle Band Edge / Full RB

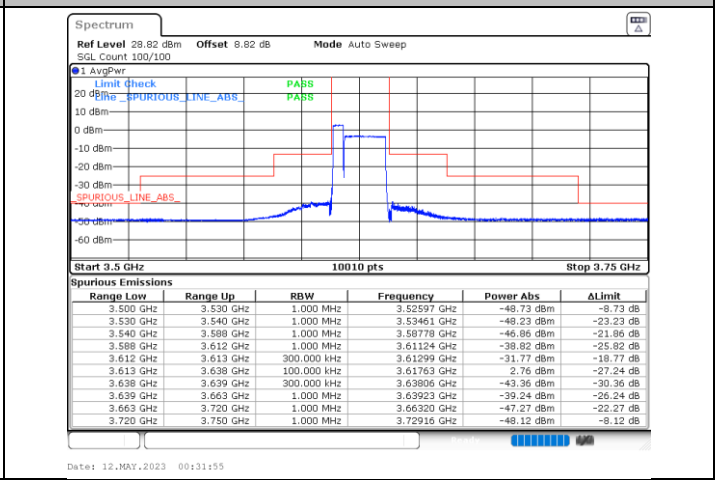



LTE Band 48C / 5MHz+20MHz

QPSK

Highest Band Edge / 1RB0 and 1RB99

Channel Power

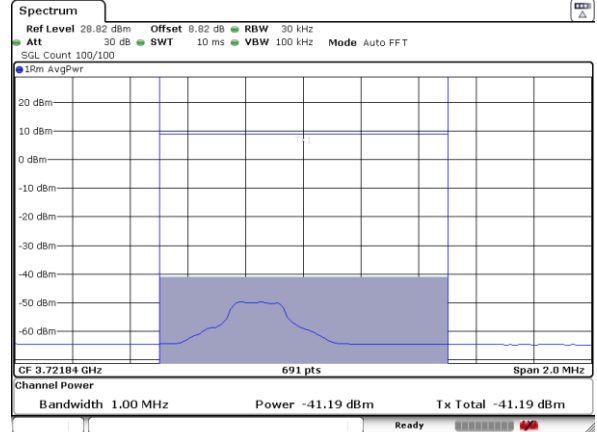
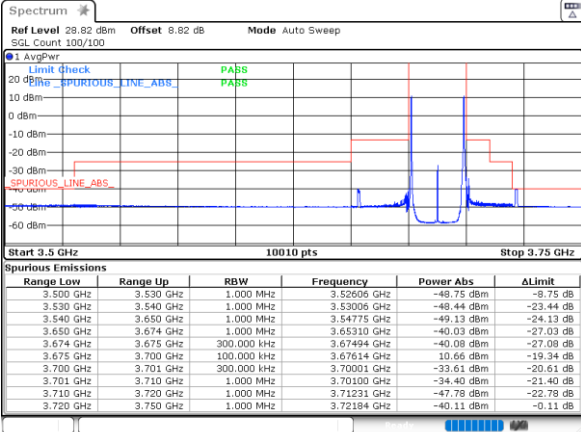

Date: 12.MAY.2023 04:24:00

Date: 12.MAY.2023 06:01:07

Highest Band Edge / 1RB24 and 1RB0

N/A

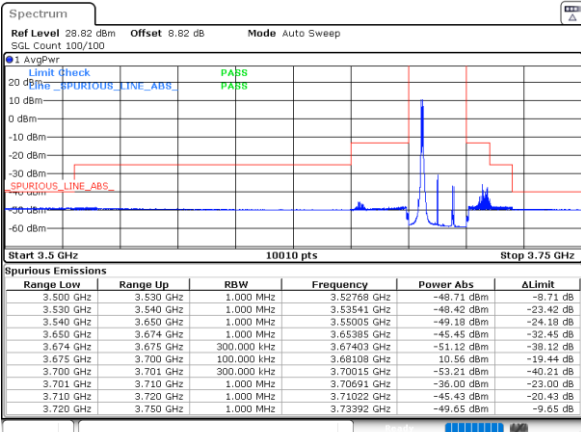

Date: 11.MAY.2023 23:14:07

Highest Band Edge / Full RB

N/A

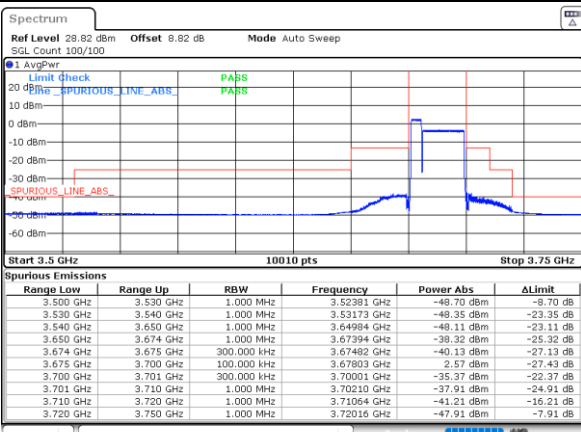

Date: 11.MAY.2023 23:40:07



LTE Band 48C / 10MHz+20MHz

QPSK

Lowest Band Edge / 1RB0 and 1RB99

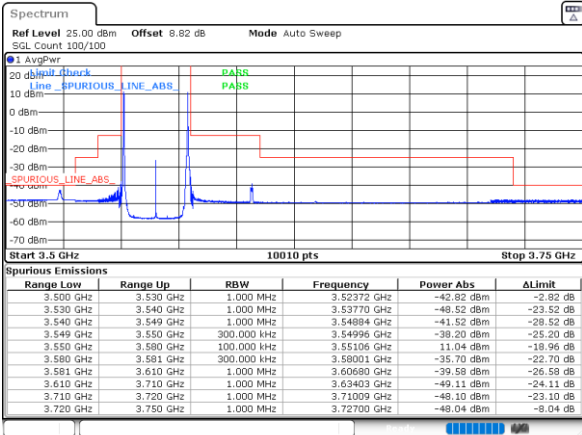

Date: 11.MAY.2023 19:06:11

Middle Band Edge / 1RB0 and 1RB99

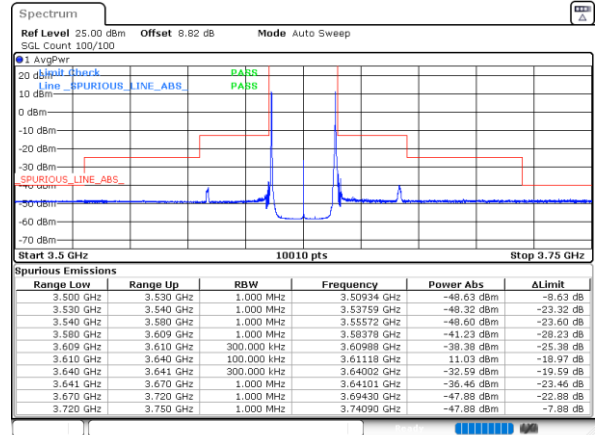

Date: 11.MAY.2023 19:14:45

Lowest Band Edge / 1RB49 and 1RB0

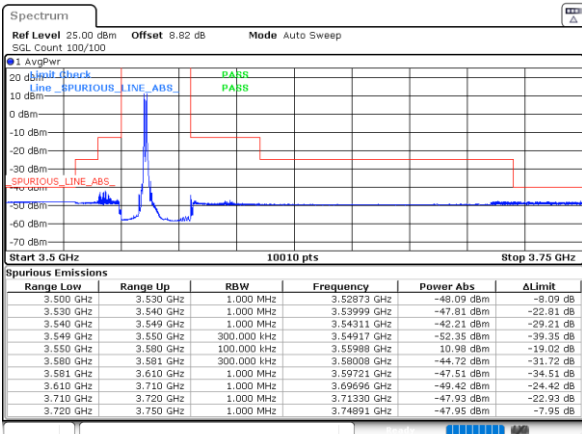

Date: 12.MAY.2023 02:26:23

Middle Band Edge / 1RB49 and 1RB0

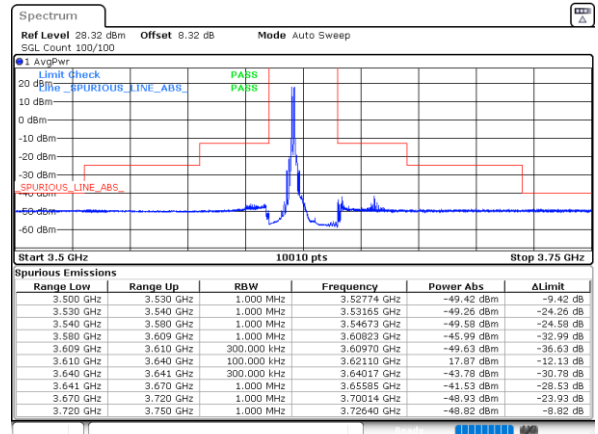

Date: 26.APR.2023 00:51:25

Lowest Band Edge / Full RB

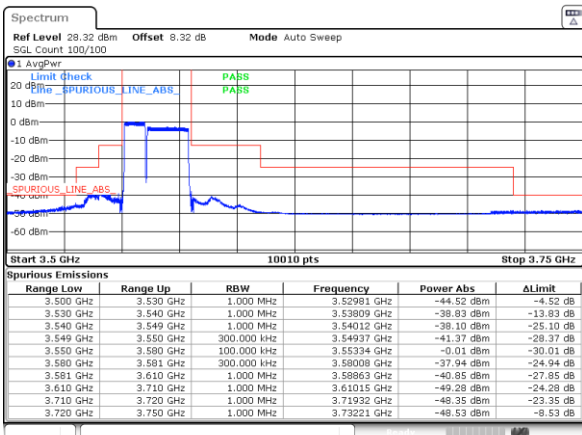

Date: 12.MAY.2023 02:26:23

Middle Band Edge / Full RB

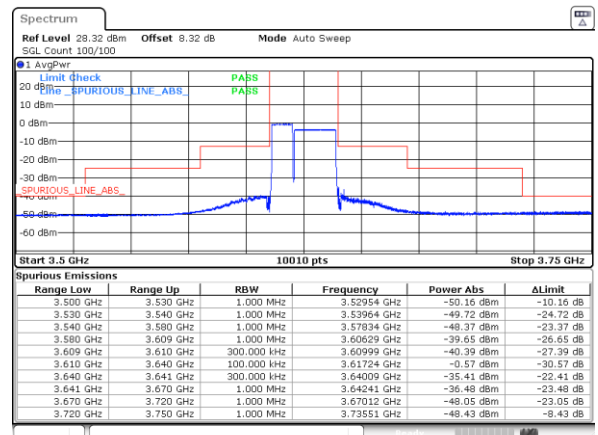

Date: 26.APR.2023 00:51:25



LTE Band 48C / 10MHz+20MHz

QPSK

Highest Band Edge / 1RB0 and 1RB9

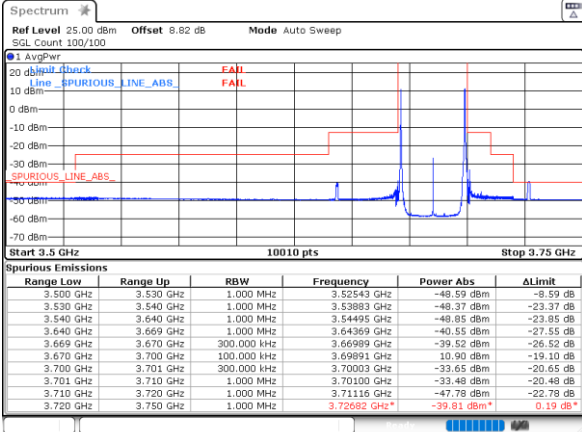

Date: 11.MAY.2023 19:36:01

Channel Power

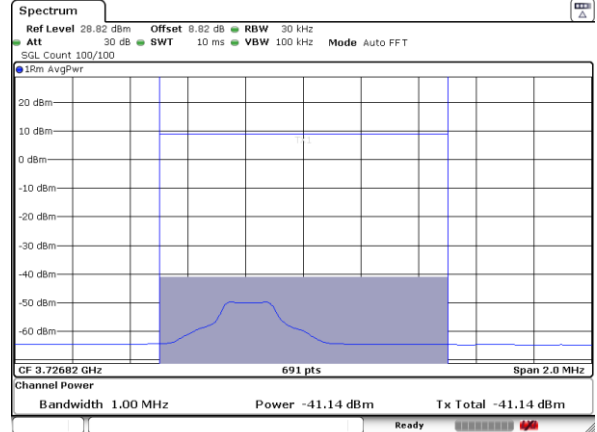

Date: 12.MAY.2023 05:57:22

Highest Band Edge / 1RB49 and 1RB0

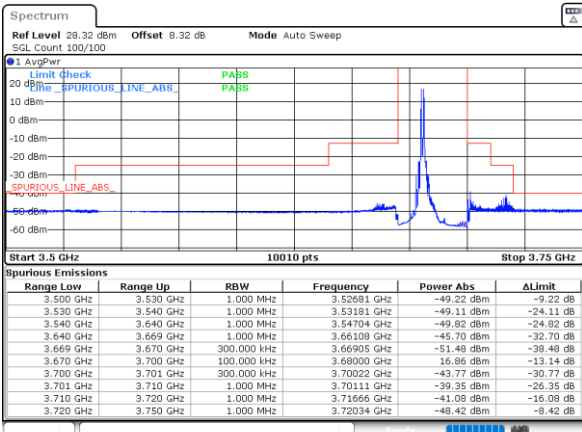

Date: 25.APR.2023 21:17:27

N/A

Highest Band Edge / Full RB

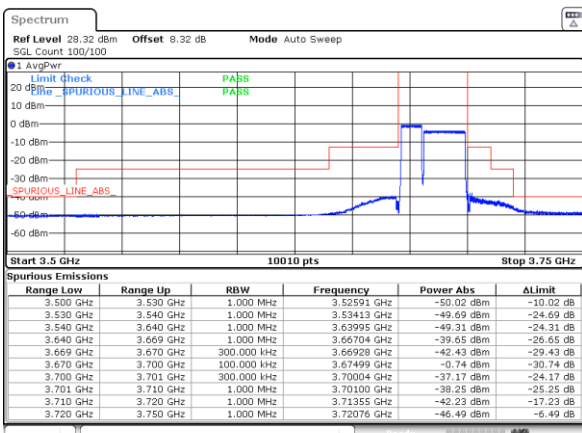

N/A



LTE Band 48C / 15MHz+20MHz

QPSK

Lowest Band Edge / 1RB0 and 1RB9

Middle Band Edge / 1RB0 and 1RB9

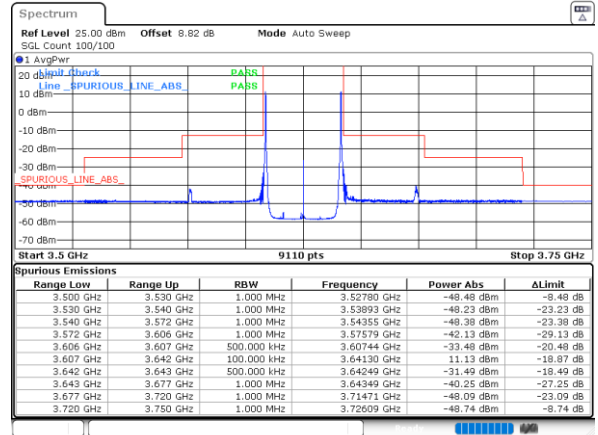
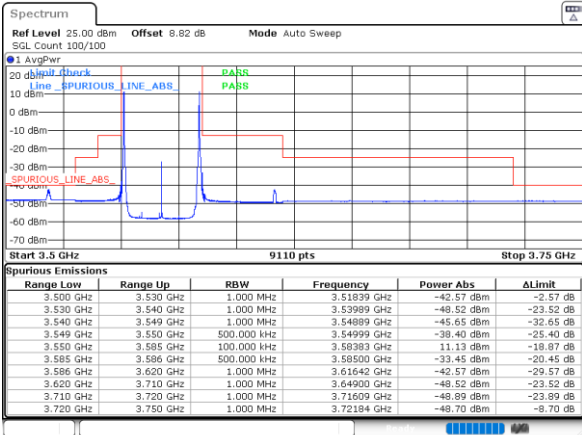

Date: 12.MAY.2023 01:55:36

Date: 12.MAY.2023 01:32:12

Lowest Band Edge / 1RB74 and 1RB0

Middle Band Edge / 1RB74 and 1RB0

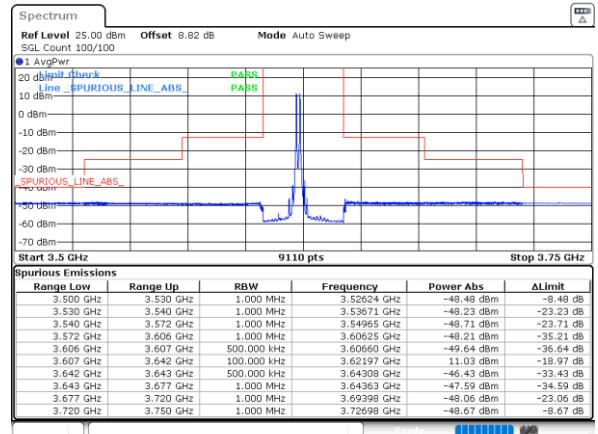
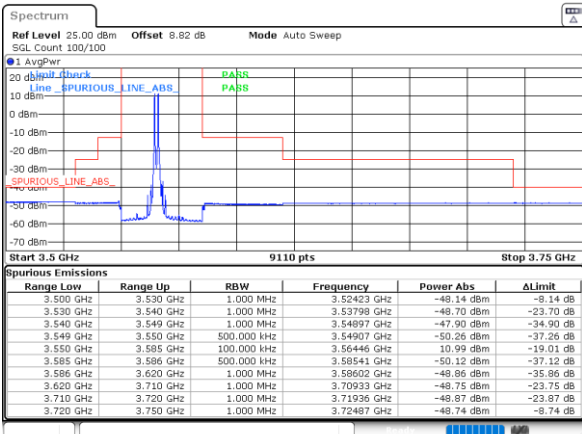

Date: 12.MAY.2023 01:45:51

Date: 12.MAY.2023 01:38:13

Lowest Band Edge / Full RB

Middle Band Edge / Full RB

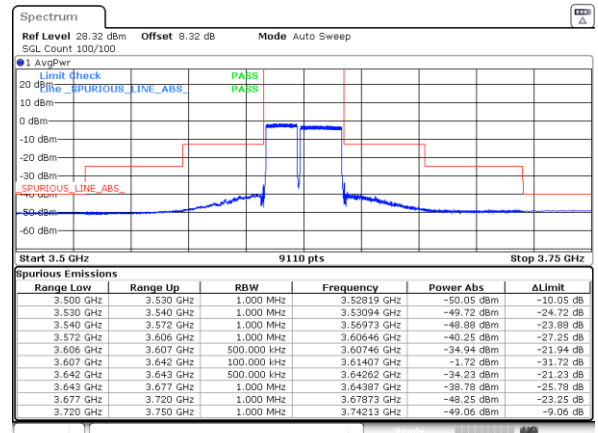
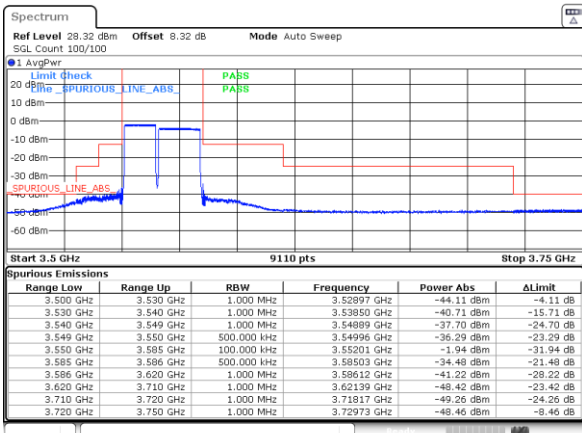



LTE Band 48C / 15MHz+20MHz

QPSK

Highest Band Edge / 1RB0 and 1RB99

N/A

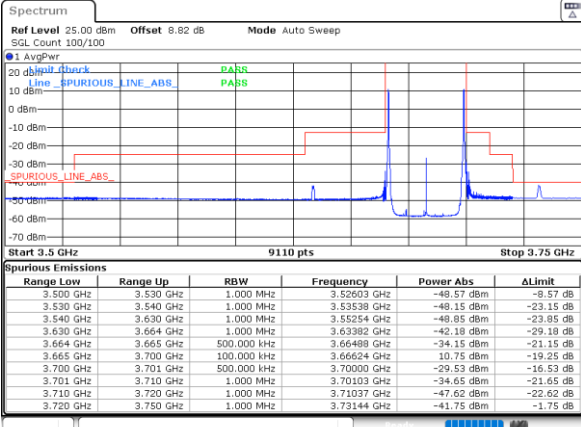

Date: 12.MAY.2023 02:04:56

Highest Band Edge / 1RB74 and 1RB0

N/A

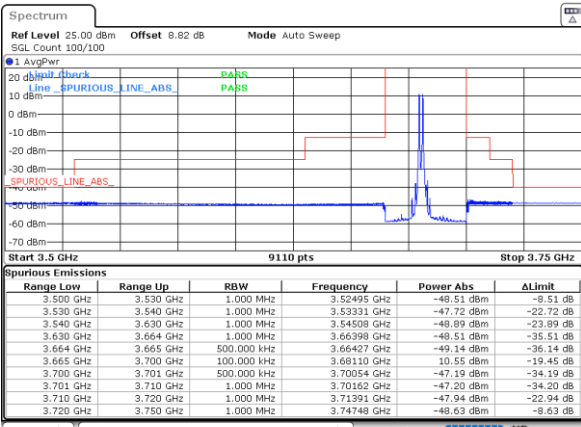

Date: 12.MAY.2023 02:13:01

Highest Band Edge / Full RB

N/A

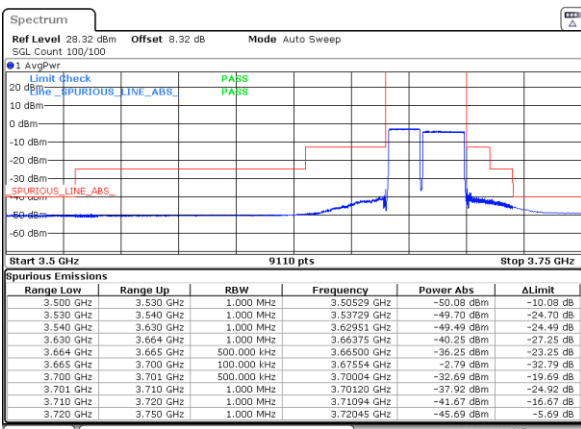



LTE Band 48C/ 20MHz+5MHz

QPSK

Lowest Band Edge / 1RB0 and 1RB24

Middle Band Edge / 1RB0 and 1RB24

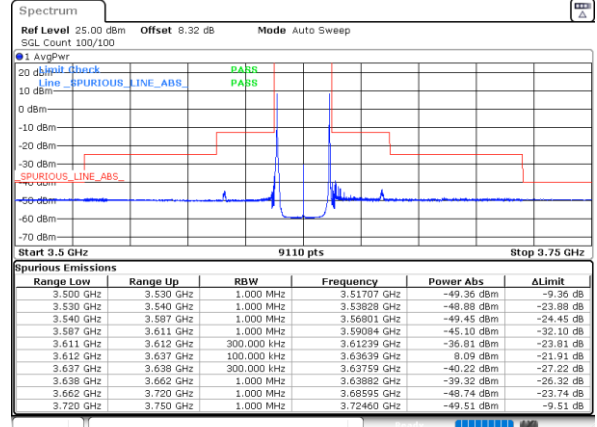
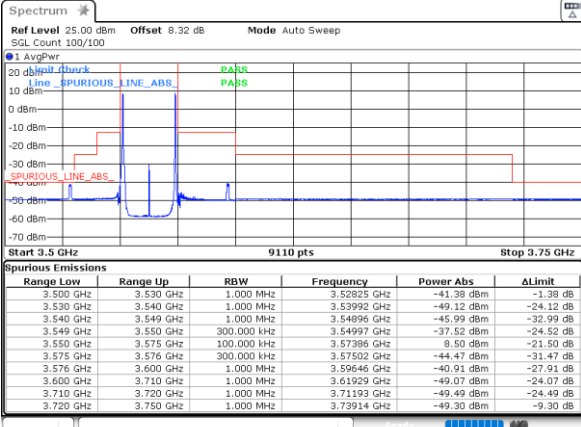

Date: 12.MAY.2023 15:42:22

Date: 10.MAY.2023 14:46:25

Lowest Band Edge / 1RB99 and 1RB0

Middle Band Edge / 1RB99 and 1RB0

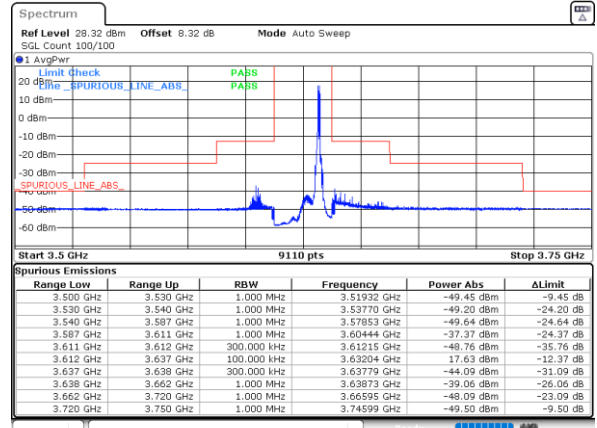
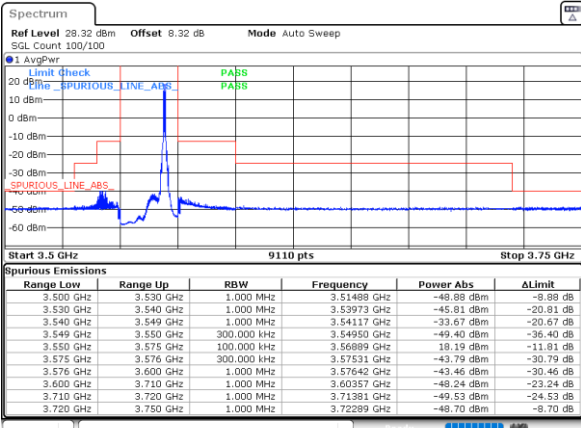

Date: 25.APR.2023 22:49:54

Date: 25.APR.2023 23:11:26

Lowest Band Edge / Full RB

Middle Band Edge / Full RB

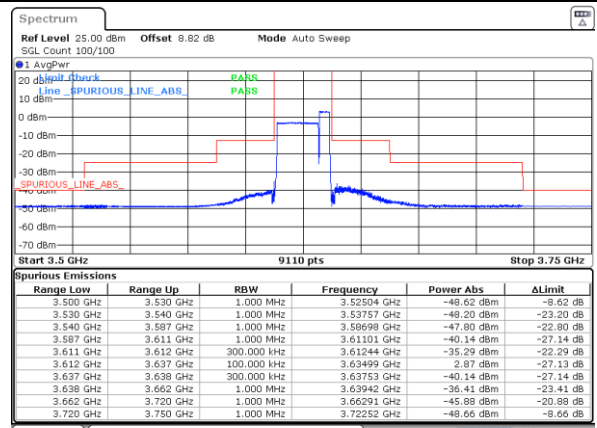
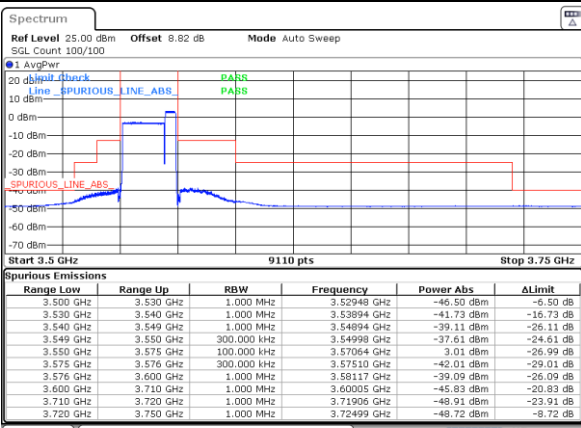

Date: 12.MAY.2023 03:59:33

Date: 12.MAY.2023 04:07:18



LTE Band 48C / 20MHz+5MHz

QPSK

Highest Band Edge / 1RB0 and 1RB24

N/A

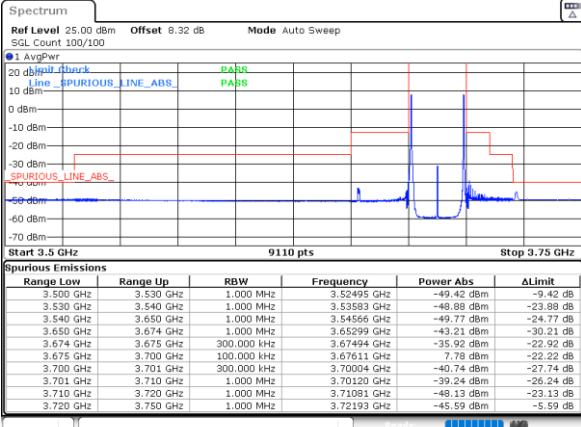

Date: 10, MAY, 2023 14:48:58

Highest Band Edge / 1RB99 and 1RB0

N/A

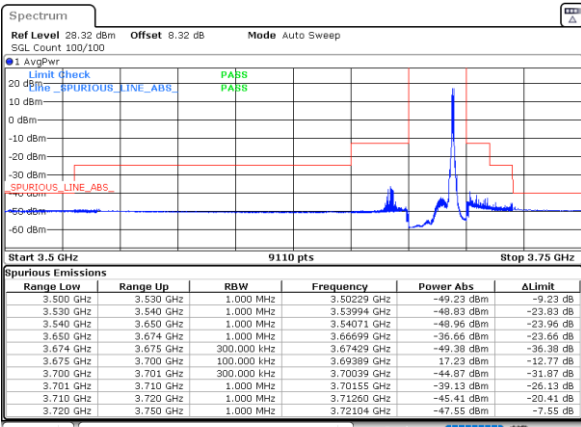

Date: 25, APR, 2023 23:32:57

Highest Band Edge / Full RB

N/A

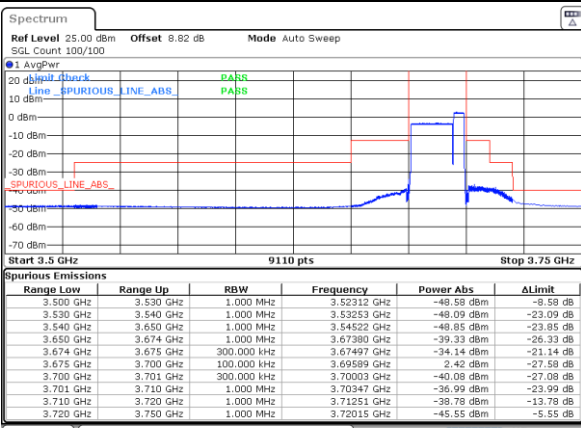

Date: 12, MAY, 2023 04:10:34



LTE Band 48C / 20MHz+10MHz

QPSK

Lowest Band Edge / 1RB0 and 1RB49

Middle Band Edge / 1RB0 and 1RB49

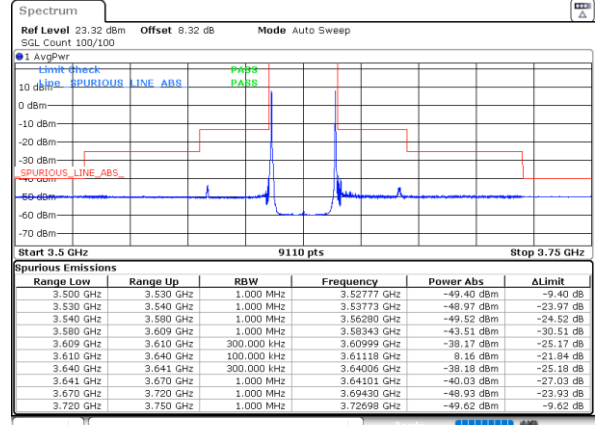
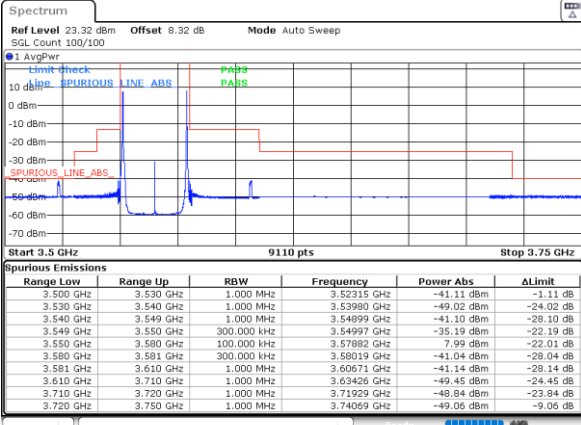

Date: 10.MAY.2023 13:56:49

Date: 10.MAY.2023 14:04:17

Lowest Band Edge / 1RB99 and 1RB0

Middle Band Edge / 1RB99 and 1RB0

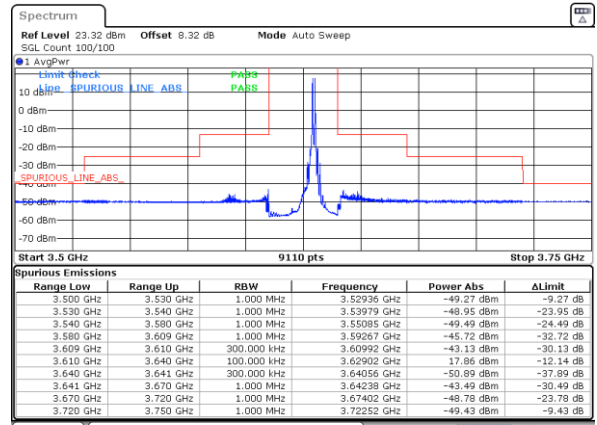
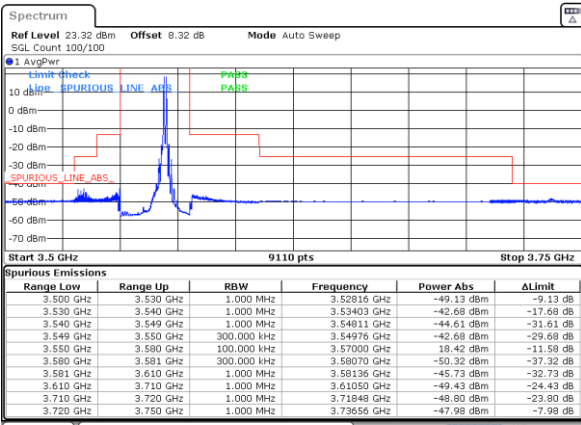

Date: 25.APR.2023 23:54:31

Date: 26.APR.2023 00:16:03

Lowest Band Edge / Full RB

Middle Band Edge / Full RB

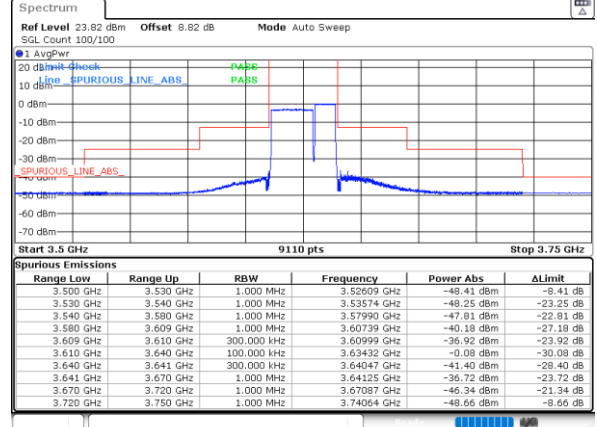
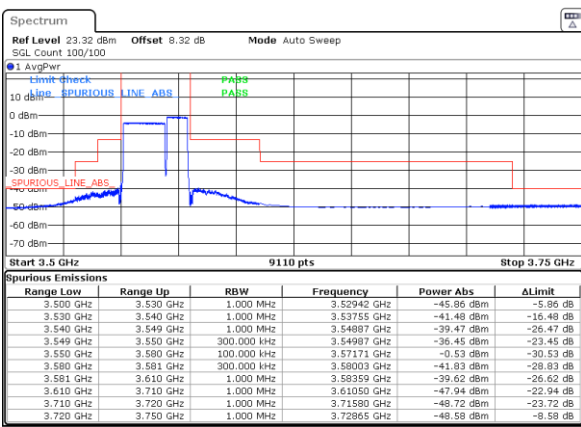

Date: 12.MAY.2023 03:36:38



LTE Band 48C / 20MHz+10MHz

QPSK

Highest Band Edge / 1RB0 and 1RB49

N/A

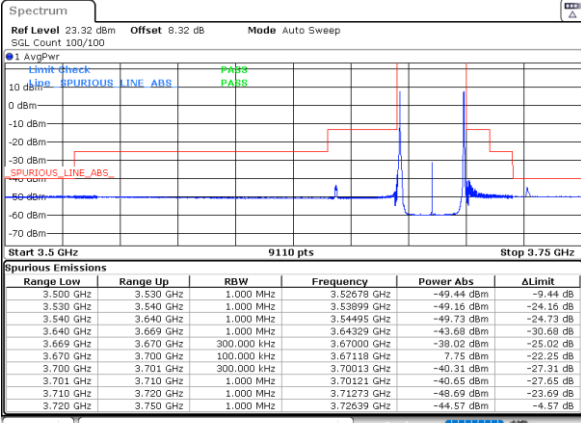

Date: 10.MAY.2023 14:06:50

Highest Band Edge / 1RB99 and 1RB0

N/A

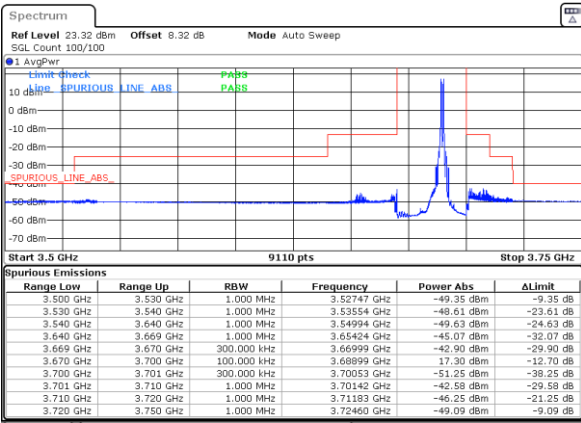

Date: 26.APR.2023 00:37:35

Highest Band Edge / Full RB

N/A

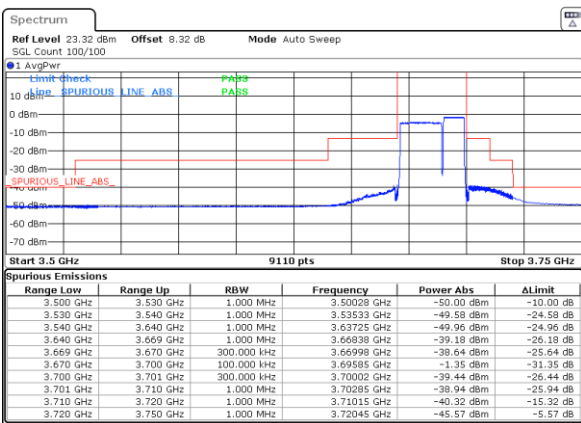



LTE Band 48C / 20MHz+15MHz

QPSK

Lowest Band Edge / 1RB0 and 1RB74

Middle Band Edge / 1RB0 and 1RB74

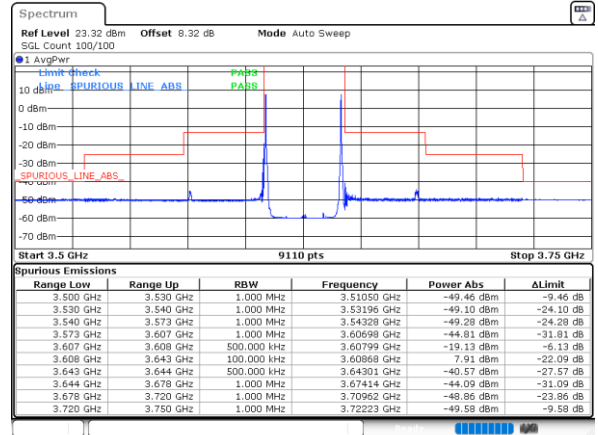
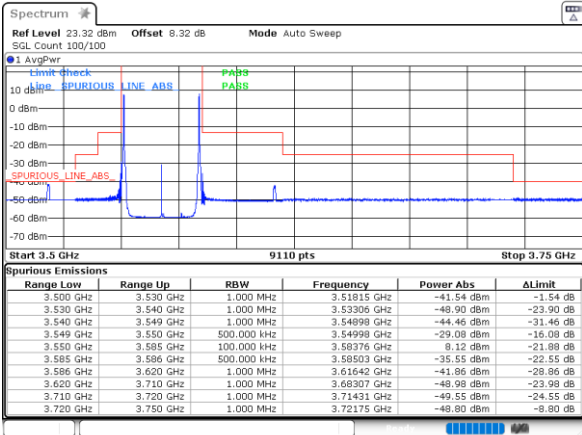

Date: 10, MAY, 2023 15:33:41

Date: 10, MAY, 2023 13:27:25

Lowest Band Edge / 1RB99 and 1RB0

Middle Band Edge / 1RB99 and 1RB0

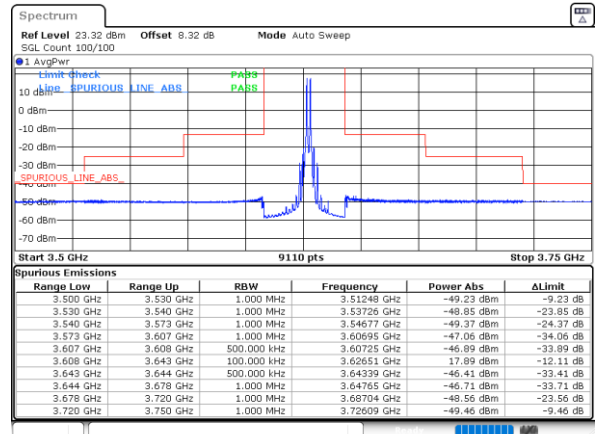
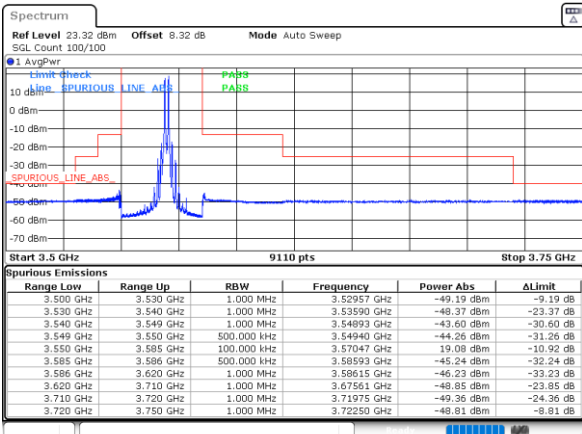

Date: 26, APR, 2023 01:01:59

Date: 26, APR, 2023 01:23:13

Lowest Band Edge / Full RB

Middle Band Edge / Full RB

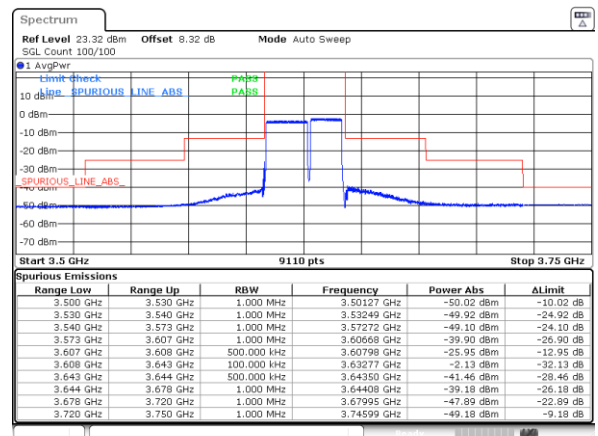
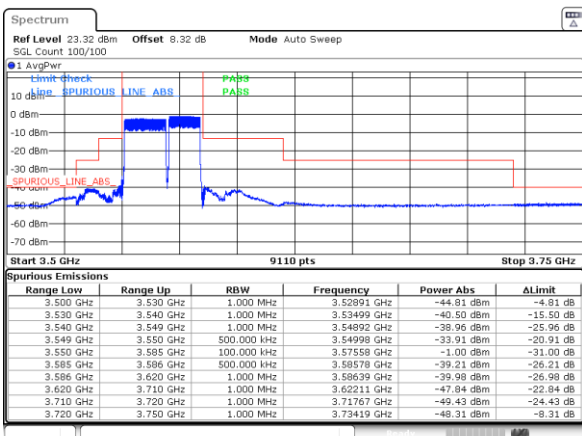



LTE Band 48C / 20MHz+15MHz

QPSK

Highest Band Edge / 1RB0 and 1RB74

N/A

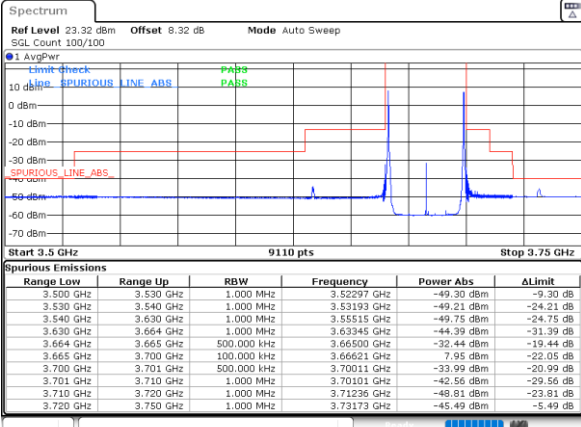

Date: 10.MAY.2023 13:29:58

Highest Band Edge / 1RB99 and 1RB0

N/A

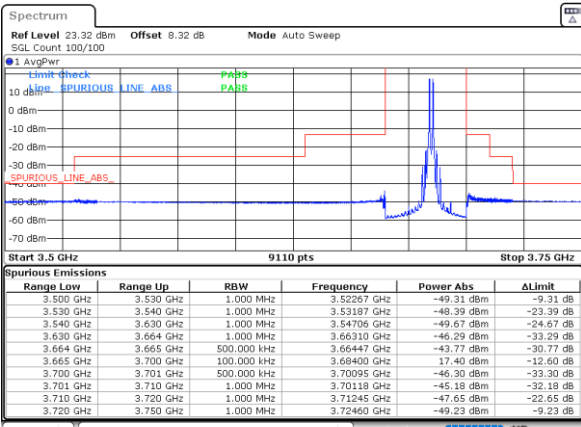

Date: 26.APR.2023 01:44:49

Highest Band Edge / Full RB

N/A

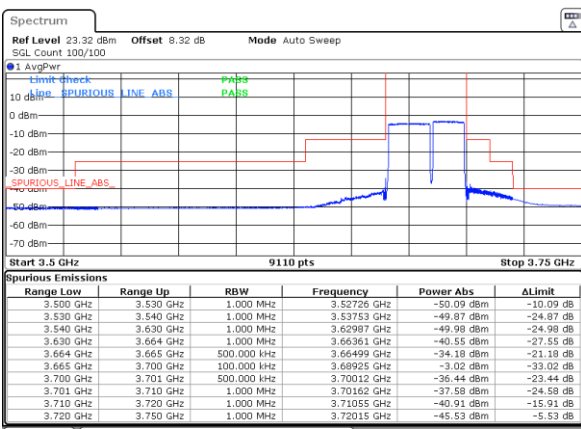



LTE Band 48C / 20MHz+20MHz

QPSK

Lowest Band Edge / 1RB0 and 1RB99

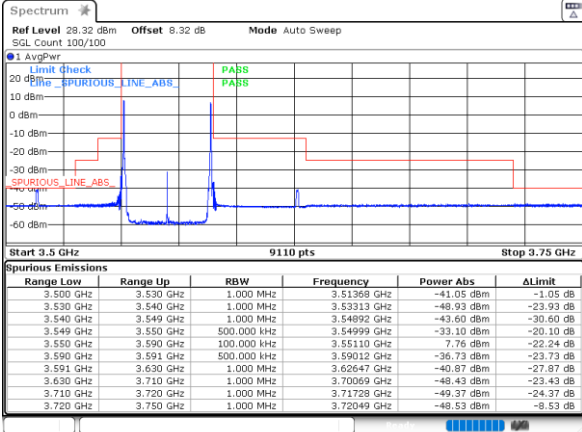

Date: 12, MAY, 2023 15:30:28

Middle Band Edge / 1RB0 and 1RB99

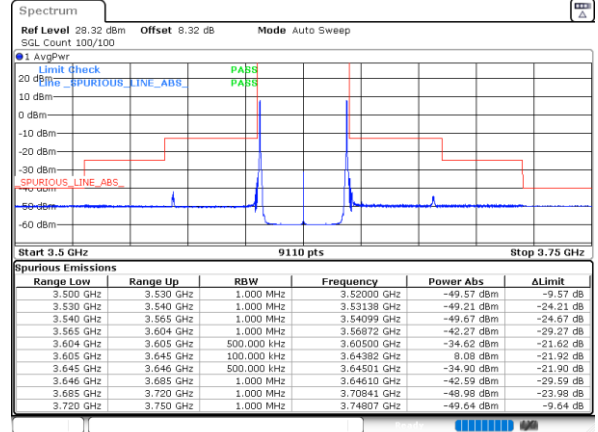

Date: 10, MAY, 2023 11:48:42

Lowest Band Edge / 1RB99 and 1RB0

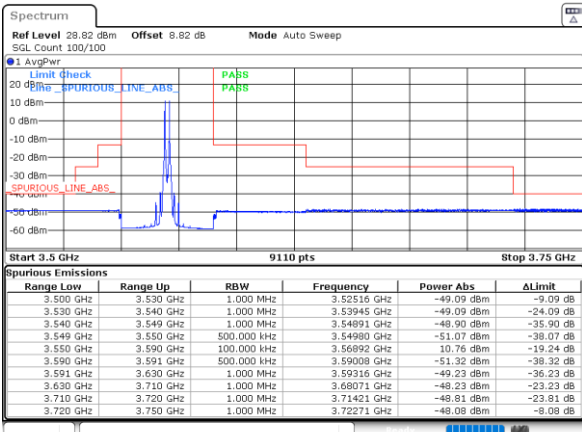

Date: 12, MAY, 2023 02:41:18

Middle Band Edge / 1RB99 and 1RB0

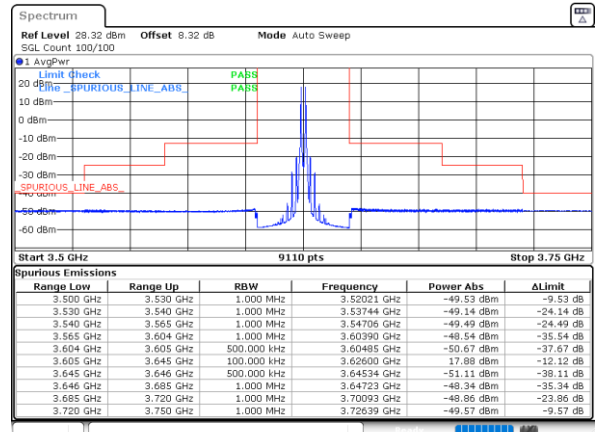

Date: 26, APR, 2023 02:33:22

Lowest Band Edge / Full RB

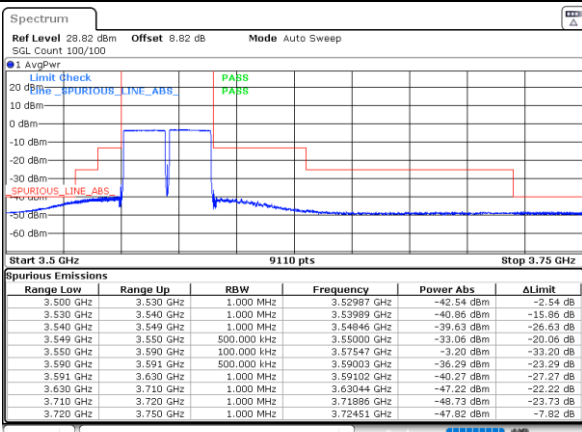

Date: 12, MAY, 2023 02:54:39

Middle Band Edge / Full RB

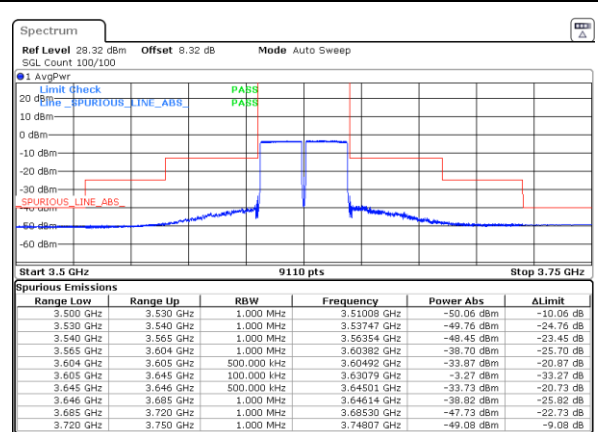

Date: 12, MAY, 2023 02:54:39



LTE Band 48C / 20MHz+20MHz

QPSK

Highest Band Edge / 1RB0 and 1RB99

N/A

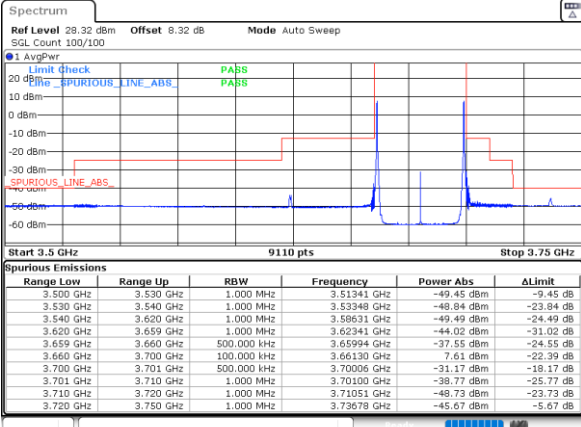

Date: 10, MAY, 2023 11:51:16

Highest Band Edge / 1RB99 and 1RB0

N/A

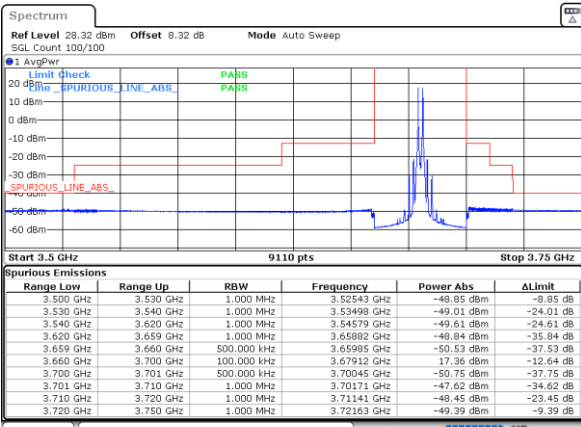

Date: 26, APR, 2023 03:22:33

Highest Band Edge / Full RB

N/A

