



# FCC RF Test Report

**APPLICANT** : Motorola Mobility LLC  
**EQUIPMENT** : Mobile Cellular Phone  
**BRAND NAME** : Motorola  
**MODEL NAME** : XT2323-2, XT2323-5, XT2323-6  
**FCC ID** : IHDT56AL9  
**STANDARD** : 47 CFR Part 2, Part 27 Subpart Q  
**CLASSIFICATION** : PCS Licensed Transmitter Held to Ear (PCE)  
**TEST DATE(S)** : May 12, 2023 ~ Jun. 02, 2023

We, Sporton International Inc. (KunShan), would like to declare that the tested sample has been evaluated in accordance with the procedures given in ANSI C63.26-2015 and shown compliance with the applicable technical standards.

This report contains data that were produced under subcontract by Sporton International Inc. (Shenzhen).

The test results in this report apply exclusively to the tested model / sample. Without written approval of Sporton International Inc. (KunShan), the test report shall not be reproduced except in full.

Jason Jia



Approved by: Jason Jia

**Sporton International Inc. (Kunshan)**

**No. 1098, Pengxi North Road, Kunshan Economic Development Zone Jiangsu Province 215300  
People's Republic of China**



TABLE OF CONTENTS

REVISION HISTORY..... 3
SUMMARY OF TEST RESULT ..... 4
1 GENERAL DESCRIPTION ..... 5
1.1 Applicant ..... 5
1.2 Manufacturer ..... 5
1.3 Product Feature of Equipment Under Test ..... 5
1.4 Product Specification of Equipment Under Test ..... 6
1.5 Specification of Accessory ..... 7
1.6 Modification of EUT ..... 7
1.7 Maximum EIRP Power and Emission Designator ..... 7
1.8 Testing Site ..... 8
1.9 Test Software ..... 9
1.10 Applied Standards ..... 9
2 TEST CONFIGURATION OF EQUIPMENT UNDER TEST ..... 10
2.1 Test Mode ..... 10
2.2 Connection Diagram of Test System ..... 11
2.3 Support Unit used in test configuration and system ..... 11
2.4 Measurement Results Explanation Example ..... 11
2.5 Frequency List of Low/Middle/High Channels ..... 12
3 CONDUCTED TEST ITEMS ..... 13
3.1 Measuring Instruments ..... 13
3.2 Test Setup ..... 13
3.3 Test Result of Conducted Test ..... 13
3.4 Conducted Output Power Measurement ..... 14
3.5 Peak-to-Average Ratio ..... 15
3.6 EIRP ..... 16
3.7 Occupied Bandwidth ..... 17
3.8 Conducted Band Edge Measurement ..... 18
3.9 Conducted Spurious Emission Measurement ..... 19
3.10 Frequency Stability Measurement ..... 20
4 RADIATED TEST ITEMS ..... 21
4.1 Measuring Instruments ..... 21
4.2 Test Setup ..... 21
4.3 Test Result of Radiated Test ..... 22
4.4 Radiated Spurious Emission Measurement ..... 23
5 LIST OF MEASURING EQUIPMENT ..... 24
6 MEASUREMENT UNCERTAINTY ..... 25
APPENDIX A. TEST RESULTS OF CONDUCTED TEST
APPENDIX B. TEST RESULTS OF RADIATED TEST
APPENDIX C. TEST SETUP PHOTOGRAPHS





### SUMMARY OF TEST RESULT

Report Section	FCC Rule	Description	Limit	Result	Remark
3.4	§2.1046	Conducted Output Power	—	Report Only	-
3.5	§27.50 (k)(4)	Peak-to-Average Ratio	<13dB	PASS	
3.6	§27.50 (k)(3)	EIRP	EIRP < 1W (30dBm)	PASS	-
3.7	§2.1049	Occupied Bandwidth	—	Report Only	-
3.8	§2.1051 §27.53 (n)(2)	Conducted Band Edge Measurement	-13dBm/MHz	PASS	-
3.9	§2.1051 §27.53 (n)(2)	Conducted Spurious Emission	-13dBm/MHz	PASS	-
3.10	§2.1055 §27.54	Frequency Stability Temperature & Voltage	Within the band	PASS	-
4.4	§2.1053 §27.53 (n)(2)	Radiated Spurious Emission	-13dBm/MHz	PASS	Under limit 30.53 dB at 10356.00 MHz

**Conformity Assessment Condition:**

- The test results (PASS/FAIL) with all measurement uncertainty excluded are presented against the regulation limits or in accordance with the requirements stipulated by the applicant/manufacturer who shall bear all the risks of non-compliance that may potentially occur if measurement uncertainty is taken into account.
- The measurement uncertainty please refer to each test result in the section "Measurement Uncertainty"

**Disclaimer:**

The product specifications of the EUT presented in the test report that may affect the test assessments are declared by the manufacturer who shall take full responsibility for the authenticity.



# 1 General Description

## 1.1 Applicant

**Motorola Mobility LLC**  
222 W,Merchandise Mart Plaza, Chicago IL 60654 USA

## 1.2 Manufacturer

**Motorola Mobility LLC**  
222 W,Merchandise Mart Plaza, Chicago IL 60654 USA

## 1.3 Product Feature of Equipment Under Test

Product Feature	
<b>Equipment</b>	Mobile Cellular Phone
<b>Brand Name</b>	Motorola
<b>Model Name</b>	XT2323-2, XT2323-5, XT2323-6
<b>FCC ID</b>	IHDT56AL9
<b>IMEI Code</b>	Conducted : 351606570017474/351606570017482 Radiation : 351606570016138/351606570016146
<b>HW Version</b>	DVT2
<b>SW Version</b>	T2TV33.23
<b>EUT Stage</b>	Identical Prototype

**Remark:** The three models XT2323-2, XT2323-5, XT2323-6 are only for market differentiation, all the others are the same.

### 1.4 Product Specification of Equipment Under Test

Product Feature	
<b>Tx/Rx Frequency</b>	5G NR n77: 3450 MHz ~ 3550 MHz 5G NR n78: 3450 MHz ~ 3550 MHz
<b>SCS</b>	30kHz
<b>Bandwidth</b>	10 / 15 / 20 / 30 / 40 / 50 / 60 / 70 / 80 / 90 / 100MHz
<b>Antenna Gain</b>	<p><b>&lt;Ant. 1&gt;</b> 5G NR n77: -6.5 dBi 5G NR n78: -6.5 dBi</p> <p><b>&lt;Ant. 2&gt;</b> 5G NR n77: -2.5 dBi 5G NR n78: -2.5 dBi</p> <p><b>&lt;Ant. 3&gt;</b> 5G NR n77: -2.4 dBi 5G NR n78: -2.4 dBi</p> <p><b>&lt;Ant. 5&gt;</b> 5G NR n77: -2.4 dBi 5G NR n78: -2.4 dBi</p>
<b>Type of Modulation</b>	CP-OFDM: QPSK / 16QAM / 64QAM / 256QAM DFT-s-OFDM: PI/2 BPSK / QPSK / 16QAM / 64QAM / 256QAM

**Remark:**

1. The maximum EIRP is calculated from max output power and max antenna gain, only the maximum EIRP is shown in the report, 5G NR n77/n78 SISO mode for Ant.3, MIMO mode for Ant(3+2).
2. The device supports two PAs for 5G NR n77(main PA and other PA for ENDC\_30A\_n77A), the maximum power of main PA is higher than the other PA, therefore, we chose higher power of main PA to calculate the EIRP and show in the report.
3. 5G NR n77/n78 support UL MIMO mode for Ant(3+2) / Ant(5+1), only the worst test data of Ant(3+2) for n77 is shown in the report by referring to the higher conducted power.
4. 5G NR n77/n78 supports SA and NSA mode. According to the maximum power between SA and NSA mode, SA covers NSA mode and 5G NR n77 covers n78.
5. The device supports HPUE mode for 5G NR n77. (Power class 2 for SISO mode & Power class 1.5 for MIMO mode)
6. 5G NR n77/n78 UL\_MIMO mode is completely uncorrelated, so the directional gain is selected the maximum gain among all antennas.
7. 5G NR n78 only supports CP-OFDM modulation in UL MIMO mode.
8. For UL MIMO mode, the conducted BE/Spurious are tested at single antenna port and add 10\*log(NANT) according to KDB 662911 D01.
9. All the supported EN-DC combinations are verified conducted power, only the EN-DC combination with highest power are shown in the report.
10. The EN-DC mode combination could be referred to the product spec.

### 1.5 Specification of Accessory

Accessories Information				
AC Adapter	Brand Name	Motorola(Salom)	Model Name	MC-301
Base Battery	Brand Name	Motorola (ATL)	Model Name	PM29
Flip Battery	Brand Name	Motorola (ATL)	Model Name	PV11
USB Cable 1	Brand Name	Motorola(Cabletech)	Model Name	SC18D13216
USB Cable 2	Brand Name	Motorola(Luxshare)	Model Name	SC18D13217
USB Cable 3	Brand Name	Motorola(Saibao)	Model Name	SC18D13215
USB Cable 4	Brand Name	Motorola(Saibao)	Model Name	SC18D86732

### 1.6 Modification of EUT

No modifications are made to the EUT during all test items.

### 1.7 Maximum EIRP Power and Emission Designator

5G NR n77		PI/2 BPSK / QPSK		16QAM/64QAM/256QAM	
BW (MHz)	Frequency Range (MHz)	Maximum EIRP(W)	Emission Designator (99%OBW)	Maximum EIRP(W)	Emission Designator (99%OBW)
10	3455.01 ~ 3544.98	0.5754	8M61G7D	0.4457	8M60W7D
15	3457.50 ~ 3542.49	0.5943	13M6G7D	0.4797	13M6W7D
20	3460.02 ~ 3540.00	0.5929	18M2G7D	0.4909	18M2W7D
30	3465.00 ~ 3534.99	0.6180	27M9G7D	0.4808	27M9W7D
40	3470.01 ~ 3529.98	0.6152	37M8G7D	0.4955	38M0W7D
50	3475.02 ~ 3525.00	0.5821	47M6G7D	0.4592	47M6W7D
60	3480.00 ~ 3519.99	0.6012	58M0G7D	0.4656	58M0W7D
70	3485.01 ~ 3514.98	0.5702	67M5G7D	0.4477	67M5W7D
80	3490.02 ~ 3510.00	0.5675	77M5G7D	0.4508	77M6W7D
90	3495.00 ~ 3504.99	0.5794	87M6G7D	0.4487	87M5W7D
100	3500.01	0.6209	97M3G7D	0.4571	97M6W7D

5G NR n78		PI/2 BPSK / QPSK		16QAM/64QAM/256QAM	
BW (MHz)	Frequency Range (MHz)	Maximum EIRP(W)	Emission Designator (99%OBW)	Maximum EIRP(W)	Emission Designator (99%OBW)
10	3455.01 ~ 3544.98	0.1589	8M61G7D	0.1486	8M60W7D
15	3457.50 ~ 3542.49	0.1750	13M6G7D	0.1337	13M6W7D
20	3460.02 ~ 3540.00	0.1742	18M2G7D	0.1618	18M2W7D
30	3465.00 ~ 3534.99	0.1795	27M9G7D	0.1730	27M9W7D
40	3470.01 ~ 3529.98	0.1816	37M8G7D	0.1413	38M0W7D
50	3475.02 ~ 3525.00	0.1667	47M6G7D	0.1652	47M6W7D
60	3480.00 ~ 3519.99	0.1746	58M0G7D	0.1714	58M0W7D
70	3485.01 ~ 3514.98	0.1718	67M5G7D	0.1675	67M5W7D
80	3490.02 ~ 3510.00	0.1702	77M5G7D	0.1656	77M6W7D
90	3495.00 ~ 3504.99	0.1698	87M6G7D	0.1641	87M5W7D
100	3500.01	0.1556	97M3G7D	0.1194	97M6W7D

**Note:**

1. 5G NR Band n77 overlaps the entire frequency range of Band n78, and n77 power > n78 power, therefore the conducted test results of n77 provided in this report cover n78.
2. 5G NR n77 SISO power is lower than UL MIMO mode, thus not show SISO power here.
3. 5G NR n78 UL MIMO power is lower than SISO mode, thus not show MIMO power here.
4. All modulations have been tested, and only the worst test results of PSK & QAM are shown in the report.

### 1.8 Testing Site

Sporton International Inc. (Kunshan) is accredited to ISO/IEC 17025:2017 by American Association for Laboratory Accreditation with Certificate Number 5145.02.

<b>Test Firm</b>	Sporton International Inc. (Kunshan)		
<b>Test Site Location</b>	No. 1098, Pengxi North Road, Kunshan Economic Development Zone Jiangsu Province 215300 People's Republic of China TEL : +86-512-57900158		
<b>Test Site No.</b>	<b>Sporton Site No.</b>	<b>FCC Designation No.</b>	<b>FCC Test Firm Registration No.</b>
	03CH04-KS TH01-KS	CN1257	314309



Sporton International Inc. (ShenZhen) is accredited to ISO/IEC 17025:2017 by American Association for Laboratory Accreditation with Certificate Number 5145.01.

<b>Test Firm</b>	Sporton International Inc. (ShenZhen)		
<b>Test Site Location</b>	1/F, 2/F, Bldg 5, Shiling Industrial Zone, Xinwei Village, Xili, Nanshan, Shenzhen, 518055 People's Republic of China TEL: +86-755-86379589 FAX: +86-755-86379595		
<b>Test Site No.</b>	<b>Sporton Site No.</b>	<b>FCC Designation No.</b>	<b>FCC Test Firm Registration No.</b>
	TH01-SZ	CN1256	421272

Test data subcontracted: Conducted test cases for n77/n78 MIMO mode in section 3 of this report

### 1.9 Test Software

Item	Site	Manufacturer	Name	Version
1.	03CH04-KS	AUDIX	E3	6.2009-8-24al

### 1.10 Applied Standards

According to the specifications of the manufacturer, the EUT must comply with the requirements of the following standards:

- 47 CFR Part 2, Part 27 Subpart Q
- ANSI C63.26-2015
- FCC KDB 971168 Power Meas License Digital Systems D01 v03r01
- FCC KDB 412172 D01 Determining ERP and EIRP v01r01

**Remark:**

1. All test items were verified and recorded according to the standards and without any deviation during the test.
2. This EUT has also been tested and complied with the requirements of FCC Part 15, Subpart B, recorded in a separate test report.

## 2 Test Configuration of Equipment Under Test

### 2.1 Test Mode

Antenna port conducted and radiated test items listed below are performed according to KDB 971168 D01 Power Meas. License Digital Systems v03r01 with maximum output power.

For radiated measurement, pre-scanned flip open and close state in three orthogonal panels X, Y, Z.

The worst cases (Z plane with flip open) were recorded in this report

Test Cases	Band	Bandwidth (MHz)	Modulation	RB #	Test Channel
		eg. 5M, 10M, 15M, 20M	eg. PI/2 BPSK, QPSK, 16QAM, 64QAM, 256QAM	1RB, Partial RB, Full RB	L/M/H
Max. Output Power	5G n77	10M, 15M, 20M, 30M, 40M, 50M, 60M, 70M, 80M, 90M, 100M	All Modulations	1RB, Full RB	L, M, H
	5G n78	10M, 15M, 20M, 30M, 40M, 50M, 60M, 70M, 80M, 90M, 100M	All Modulations	1RB, Full RB	L, M, H
Peak-to-Average Ratio	5G n77	20M, 100M	PI/2 BPSK, QPSK	1RB, Full RB	L, M, H
E.I.R.P	5G n77	10M, 15M, 20M, 30M, 40M, 50M, 60M, 70M, 80M, 90M, 100M	All Modulations	1RB, Full RB	L, M, H
26dB and 99% Bandwidth	5G n77	10M, 15M, 20M, 25M, 30M, 40M, 50M, 60M, 70M, 80M, 90M, 100M	All Modulations	Full RB	M
Conducted Band Edge	5G n77	10M, 50M, 100M	PI/2 BPSK, QPSK	1RB, Full RB	L, H
Conducted Spurious Emission	5G n77	10M, 50M, 100M	PI/2 BPSK, QPSK	1RB	L, M, H
Frequency Stability	5G n77	10M, 20M	QPSK	Full RB	M
Radiated Spurious Emission	5G n77	Worst case from maximum power			M

**Note:**

- The device is investigated from 30MHz to 10 times of fundamental signal for radiated spurious emission test under different RB size/offset and modulations in exploratory test. Subsequently, only the worst case emissions are reported.
- Frequency Stability: Normal Voltage = 3.91V; Low Voltage =3.4V; High Voltage =4.5V.
- All test items are based on engineering evaluation.

## 2.2 Connection Diagram of Test System

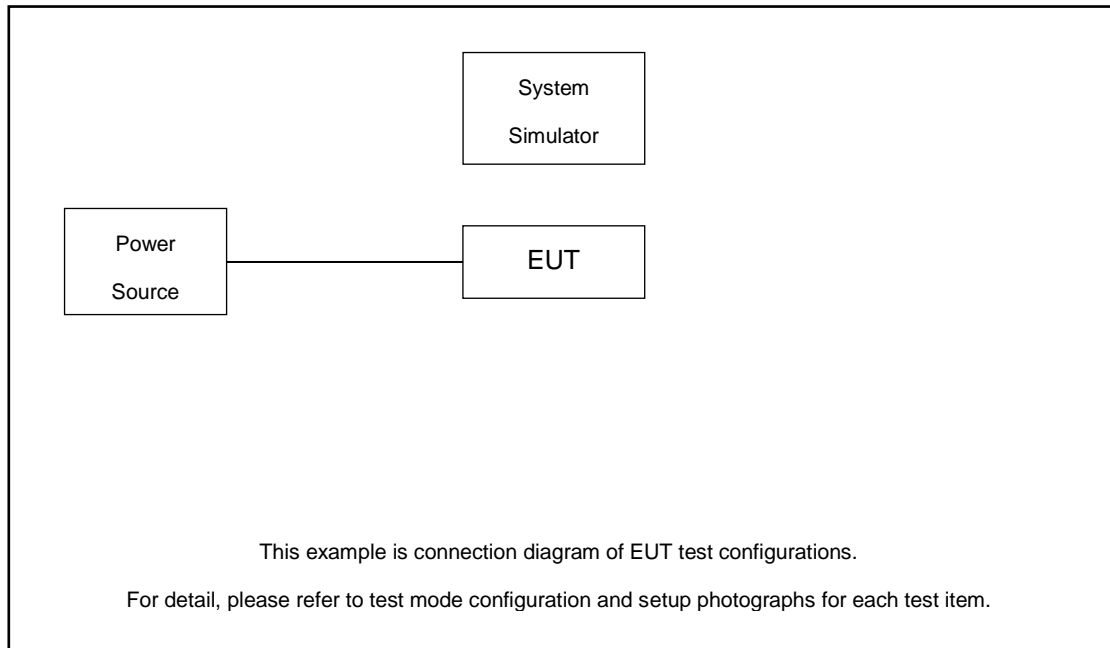

## 2.3 Support Unit used in test configuration and system

Item	Equipment	Trade Name	Model No.	FCC ID	Data Cable	Power Cord
1.	Power Supply	GWINSTEK	PSS-2002	N/A	N/A	Unshielded, 1.8 m
2.	LTE Base Station	Anritsu	MT8820C	N/A	N/A	Unshielded, 1.8 m
3.	NR Base Station	Anritsu	MT8000A	N/A	N/A	Unshielded, 1.8 m

## 2.4 Measurement Results Explanation Example

### For all conducted test items:

The offset level is set in the spectrum analyzer to compensate the RF cable loss and attenuator factor between EUT conducted output port and spectrum analyzer. With the offset compensation, the spectrum analyzer reading level is exactly the EUT RF output level.

The spectrum analyzer offset is derived from RF cable loss and attenuator factor.

*Offset = RF cable loss + attenuator factor.*

Following shows an offset computation example with cable loss 6.5 dB and 20dB attenuator.

Example :

$$\begin{aligned} \text{Offset(dB)} &= \text{RF cable loss(dB)} + \text{attenuator factor(dB)}. \\ &= 6.5 + 10 = 26.5 \text{ (dB)} \end{aligned}$$

## 2.5 Frequency List of Low/Middle/High Channels

5G n77/n78 Channel and Frequency List				
BW [MHz]	Channel/Frequency(MHz)	Lowest	Middle	Highest
100	Channel	-	633334	-
	Frequency	-	3500.01	-
90	Channel	633000	633334	633666
	Frequency	3495	3500.01	3504.99
80	Channel	632668	633334	634000
	Frequency	3490.02	3500.01	3510
70	Channel	632334	633334	634332
	Frequency	3485.01	3500.01	3514.98
60	Channel	632000	633334	634666
	Frequency	3480	3500.01	3519.99
50	Channel	631668	633334	635000
	Frequency	3475.02	3500.01	3525
40	Channel	631334	633334	635332
	Frequency	3470.01	3500.01	3529.98
30	Channel	631000	633334	635666
	Frequency	3465	3500.01	3534.99
20	Channel	630668	633334	636000
	Frequency	3460.02	3500.01	3540
15	Channel	630500	633334	636166
	Frequency	3457.5	3500.01	3542.49
10	Channel	630334	633334	636332
	Frequency	3455.01	3500.01	3544.98

### 3 Conducted Test Items

#### 3.1 Measuring Instruments

See list of measuring instruments of this test report.

#### 3.2 Test Setup

##### 3.2.1 Conducted Output Power

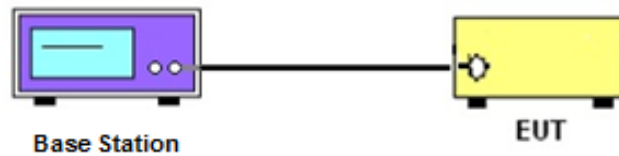

##### 3.2.2 Peak-to-Average Ratio, Occupied / 26dB Bandwidth, Band-Edge and Conducted Spurious Emission

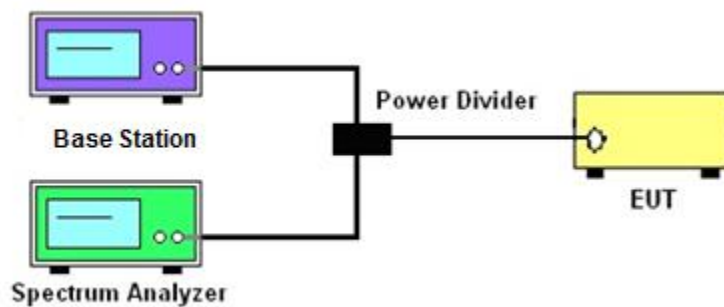

##### 3.2.3 Frequency Stability

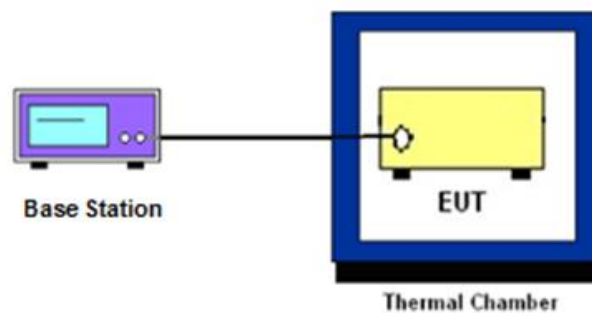

### 3.3 Test Result of Conducted Test

Please refer to Appendix A.



## 3.4 Conducted Output Power Measurement

### 3.4.1 Description of the Conducted Output Power Measurement

A base station simulator was used to establish communication with the EUT. Its parameters were set to transmit the maximum power on the EUT. The measured power in the radio frequency on the transmitter output terminals shall be reported.

### 3.4.2 Test Procedures

1. The testing follows ANSI C63.26 Section 5.2
2. The transmitter output port was connected to the system simulator.
3. Set EUT at maximum power through the system simulator.
4. Select lowest, middle, and highest channels for each band and different modulation.
5. Measure and record the power level from the system simulator.

## 3.5 Peak-to-Average Ratio

### 3.5.1 Description of the PAR Measurement

Power Complementary Cumulative Distribution Function (CCDF) curves provide a means for characterizing the power peaks of a digitally modulated signal on a statistical basis. A CCDF curve depicts the probability of the peak signal amplitude exceeding the average power level. Most contemporary measurement instrumentation include the capability to produce CCDF curves for an input signal provided that the instrument's resolution bandwidth can be set wide enough to accommodate the entire input signal bandwidth. In measuring transmissions in this band using an average power technique, the peak-to-average ratio (PAR) of the transmission may not exceed 13 dB.

### 3.5.2 Test Procedures

1. The testing follows ANSI C63.26 Section 5.2.3.4 (CCDF).
2. The EUT was connected to spectrum and system simulator via a power divider.
3. Set the CCDF (Complementary Cumulative Distribution Function) option in spectrum analyzer.
4. The highest RF powers were measured and recorded the maximum PAPR level associated with a probability of 0.1 %.
5. Record the deviation as Peak to Average Ratio.

## 3.6 EIRP

### 3.6.1 Description of EIRP Limit

#### § 27.50 (k)(3)

Mobile devices are limited to 1Watt (30 dBm) EIRP. Mobile devices operating in these bands must employ a means for limiting power to the minimum necessary for successful communications

### 3.6.2 Test Procedures

1. According to KDB 412172 D01 Power Approach,
2.  $EIRP = P_T + G_T - L_C$ ,  $ERP = EIRP - 2.15$ , where  
 $P_T$  = transmitter output power in dBm  
 $G_T$  = gain of the transmitting antenna in dBi  
 $L_C$  = signal attenuation in the connecting cable between the transmitter and antenna in dB



## 3.7 Occupied Bandwidth

### 3.7.1 Description of Occupied Bandwidth Measurement

The occupied bandwidth is the width of a frequency band such that, below the lower and above the upper frequency limits, the mean powers emitted are each equal to a specified percentage 0.5% of the total mean transmitted power.

The 26 dB emission bandwidth is defined as the frequency range between two points, one above and one below the carrier frequency, at which the spectral density of the emission is attenuated 26 dB below the maximum in-band spectral density of the modulated signal. Spectral density (power per unit bandwidth) is to be measured with a detector of resolution bandwidth equal to approximately 1.0% of the emission bandwidth.

### 3.7.2 Test Procedures

1. The testing follows ANSI C63.26 Section 5.4
2. The EUT was connected to spectrum analyzer and system simulator via a power divider.
3. The spectrum analyzer center frequency is set to the nominal EUT channel center frequency. The span range for the spectrum analyzer shall be between two and five times the anticipated OBW.
4. The nominal resolution bandwidth (RBW) shall be in the range of 1 to 5 % of the anticipated OBW, and the VBW shall be at least 3 times the RBW.
5. Set the detection mode to peak, and the trace mode to max hold.
6. Determine the reference value: Set the EUT to transmit a modulated signal. Allow the trace to stabilize. Set the spectrum analyzer marker to the highest level of the displayed trace.  
(this is the reference value)
7. Determine the “-26 dB down amplitude” as equal to (Reference Value – X).
8. Place two markers, one at the lowest and the other at the highest frequency of the envelope of the spectral display such that each marker is at or slightly below the “-X dB down amplitude” determined in step 6. If a marker is below this “-X dB down amplitude” value it shall be placed as close as possible to this value. The OBW is the positive frequency difference between the two markers.
9. Use the 99 % power bandwidth function of the spectrum analyzer and report the measured bandwidth.

## 3.8 Conducted Band Edge Measurement

### 3.8.1 Description of Conducted Band Edge Measurement

#### § 27.53 (n)(2)

For mobile operations in the 3450-3550 MHz band, the conducted power of any emission outside the licensee's authorized bandwidth shall not exceed  $-13$  dBm/MHz.

Compliance with this paragraph is based on the use of measurement instrumentation employing a resolution bandwidth of 1 megahertz or greater. However, in the 1 megahertz bands immediately outside and adjacent to the licensee's frequency block, a resolution bandwidth of at least one percent of the emission bandwidth of the fundamental emission of the transmitter may be employed, but limited to a maximum of 200 kHz. In the bands between 1 and 5 MHz removed from the licensee's frequency block, the minimum resolution bandwidth for the measurement shall be 500 kHz.

### 3.8.2 Test Procedures

1. The testing follows ANSI C63.26 section 5.7
2. The EUT was connected to spectrum analyzer and system simulator via a power divider.
3. The band edges of low and high channels for the highest RF powers were measured.
4. Set RBW  $\geq 1\%$  EBW but limited to a maximum of 200 kHz in the 1MHz band immediately outside and adjacent to the band edge.
5. Beyond the 1 MHz and 5 MHz removed from the band edge, set RBW  $\geq 500$ KHz.
6. Beyond the 5 MHz removed from the band edge, set RBW = 1MHz.
7. Set spectrum analyzer with RMS detector.
8. The RF fundamental frequency should be excluded against the limit line in the operating frequency band.
9. Checked that all the results comply with the emission limit line.

## 3.9 Conducted Spurious Emission Measurement

### 3.9.1 Description of Conducted Spurious Emission Measurement

The power of any emission outside of the authorized operating frequency ranges shall not exceed -13 dBm/MHz.

It is measured by means of a calibrated spectrum analyzer and scanned from 9 kHz up to a frequency including its 10<sup>th</sup> harmonic.

### 3.9.2 Test Procedures

1. The testing follows ANSI C63.26 section 5.7
2. The EUT was connected to spectrum analyzer and system simulator via a power divider.
3. The RF output of EUT was connected to the spectrum analyzer by RF cable and attenuator. The path loss was compensated to the results for each measurement.
4. The middle channel for the highest RF power within the transmitting frequency was measured.
5. The conducted spurious emission for the whole frequency range was taken.
6. Make the measurement with the spectrum analyzer's RBW = 1MHz, VBW = 3MHz.
7. Set spectrum analyzer with RMS detector.
8. Taking the record of maximum spurious emission.
9. The RF fundamental frequency should be excluded against the limit line in the operating frequency band.
10. Checked that all the results comply with the emission limit line.

## 3.10 Frequency Stability Measurement

### 3.10.1 Description of Frequency Stability Measurement

The frequency stability shall be measured by variation of ambient temperature and variation of primary supply voltage to ensure that the fundamental emission stays within the authorized frequency block.

### 3.10.2 Test Procedures for Temperature Variation

1. The testing follows ANSI C63.26 section 5.6.4
2. The EUT was set up in the thermal chamber and connected with the system simulator.
3. With power OFF, the temperature was decreased to -30°C and the EUT was stabilized before testing. Power was applied and the maximum change in frequency was recorded within one minute.
4. With power OFF, the temperature was raised in 10°C step up to 50°C. The EUT was stabilized at each step for at least half an hour. Power was applied and the maximum frequency change was recorded within one minute.

### 3.10.3 Test Procedures for Voltage Variation

1. The testing follows ANSI C63.26 section 5.6.5.
2. The EUT was placed in a temperature chamber at 20±5°C and connected with the system simulator.
3. The power supply voltage to the EUT was varied from 85% to 115% of the nominal value for other than hand carried battery equipment.
4. For hand carried, battery powered equipment, reduce the primary ac or dc supply voltage to the battery operating end point, which shall be specified by the manufacturer.
5. The variation in frequency was measured for the worst case.

## 4 Radiated Test Items

### 4.1 Measuring Instruments

See list of measuring instruments of this test report.

### 4.2 Test Setup

#### 4.2.1 For radiated test below 30MHz

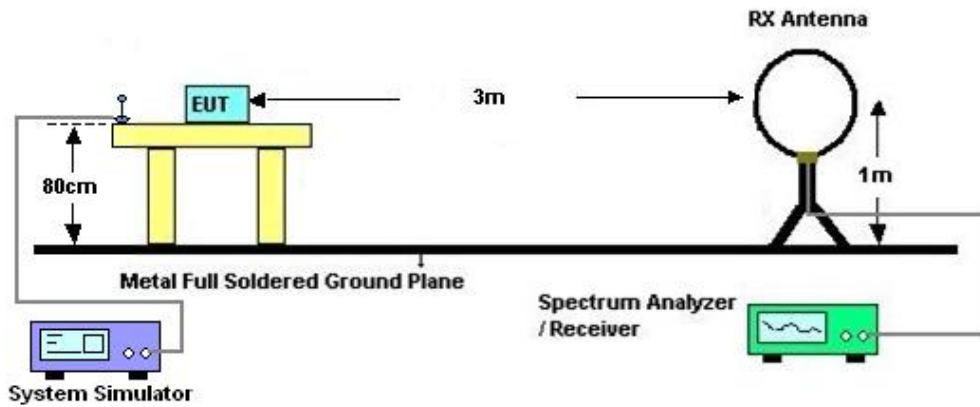

#### 4.2.2 For radiated test from 30MHz to 1GHz

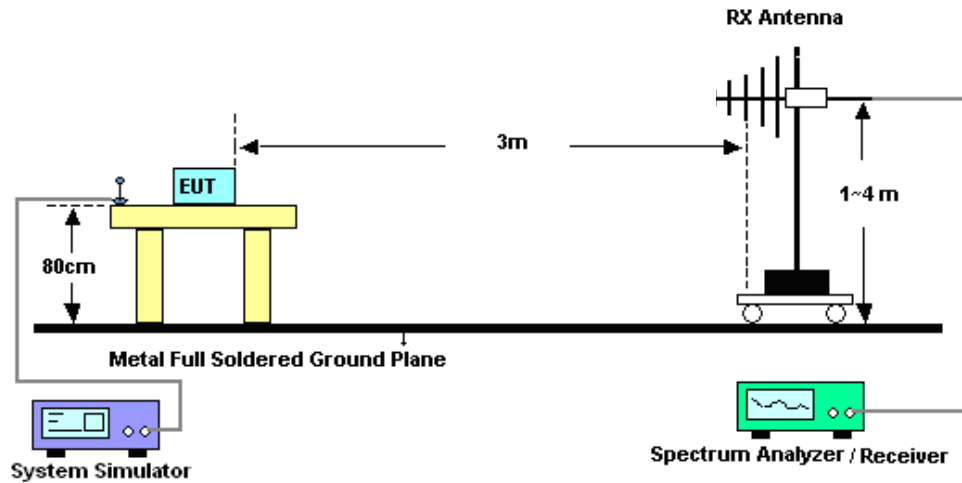

### 4.2.3 For radiated test above 1GHz

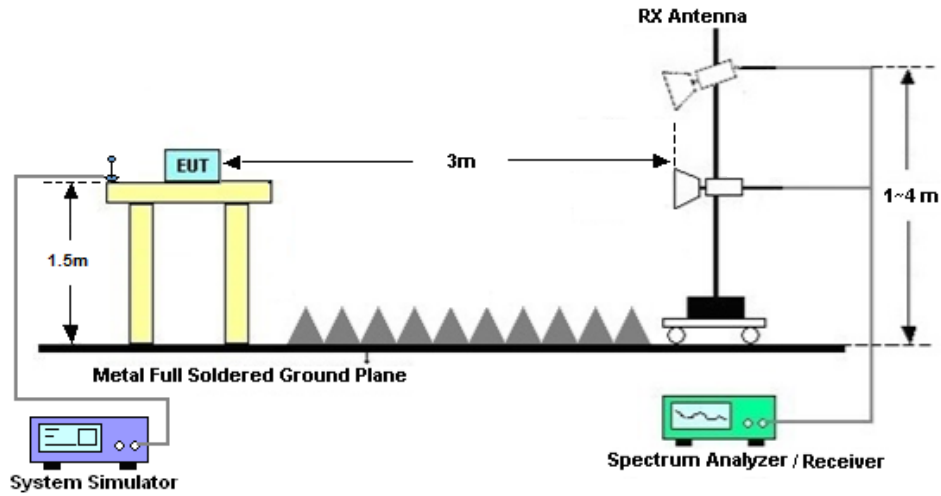

### 4.3 Test Result of Radiated Test

The low frequency, which started from 9 kHz to 30MHz, was pre-scanned and the result which was 20dB lower than the limit line was not reported.

Please refer to Appendix B.

## 4.4 Radiated Spurious Emission Measurement

### 4.4.1 Description of Radiated Spurious Emission

The radiated spurious emission was measured by substitution method according to ANSI/TIA-603-E. The power of any emission outside of the authorized operating frequency ranges shall not exceed -13 dBm/MHz.

The spectrum is scanned from 30 MHz up to a frequency including its 10th harmonic.

### 4.4.2 Test Procedures

1. The testing follows ANSI C63.26 Section 5.5
2. The EUT was placed on a turntable with 0.8 meter height for frequency below 1GHz and 1.5 meter height for frequency above 1GHz respectively above ground.
3. The EUT was set 3 meters from the receiving antenna mounted on the antenna tower.
4. The table was rotated 360 degrees to determine the position of the highest spurious emission.
5. The height of the receiving antenna is varied between 1m to 4m to search the maximum spurious emission for both horizontal and vertical polarizations.
6. During the measurement, the system simulator parameters were set to force the EUT transmitting at maximum output power.
7. Make the measurement with the spectrum analyzer's RBW = 1MHz, VBW = 3MHz, taking the record of maximum spurious emission.
8. A horn antenna was substituted in place of the EUT and was driven by a signal generator.
9. Tune the output power of signal generator to the same emission level with EUT maximum spurious emission.  
$$\text{EIRP (dBm)} = \text{S.G. Power} - \text{Tx Cable Loss} + \text{Tx Antenna Gain}$$
$$\text{ERP (dBm)} = \text{EIRP} - 2.15$$
10. The RF fundamental frequency should be excluded against the limit line in the operating frequency band.



## 5 List of Measuring Equipment

Instrument	Manufacturer	Model No.	Serial No.	Characteristics	Calibration Date	Test Date	Due Date	Remark
EXA Spectrum Analyzer	Keysight	N9010B	MY57471079	10Hz~44G,MAX 30dB	Oct. 12, 2022	May 20, 2023~Jun. 01, 2023	Oct. 11, 2023	Conducted (TH01-KS)
Power divider	STI	STI08-0055	-	0.5~40GHz	NCR	May 20, 2023~Jun. 01, 2023	NCR	Conducted (TH01-KS)
Temperature & humidity chamber	Hongzhan	LP-150U	H2014011440	-40~+150°C 20%~95%RH	Jul. 15, 2022	May 20, 2023~Jun. 01, 2023	Jul. 14, 2023	Conducted (TH01-KS)
EXA Spectrum Analyzer	KEYSIGHT	N9010A	MY55150213	10Hz~44GHz	Jul. 07, 2022	May 12, 2023~Jun. 02, 2023	Jul. 06, 2023	Conducted (TH01-SZ)
Power Divider	TOJOIN	PS-2SM-04 265	60.06.020.0077	0.4GHz~26.5GHz	Dec. 25, 2022	May 12, 2023~Jun. 02, 2023	Dec. 24, 2023	Conducted (TH01-SZ)
Thermal Chamber	Ten Billion Hongzhangroup	LP-150U	H2014081803	-40~+150°C	Jul. 07, 2022	May 12, 2023~Jun. 02, 2023	Jul. 06, 2023	Conducted (TH01-SZ)
EXA Spectrum Analyzer	Keysight	N9010B	MY57471079	10Hz~44G,MAX 30dB	Oct. 12, 2022	May 24, 2023	Oct. 11, 2023	Radiation (03CH04-KS)
Loop Antenna	R&S	HFH2-Z2	100321	9kHz~30MHz	Oct. 16, 2022	May 24, 2023	Oct. 15, 2023	Radiation (03CH04-KS)
Bilog Antenna	TeseQ	CBL6111D	49922	30MHz-1GHz	Apr. 09, 2023	May 24, 2023	Apr. 08, 2024	Radiation (03CH04-KS)
Horn Antenna	Schwarzbeck	BBHA9120D	1284	1GHz~18GHz	Oct. 16, 2022	May 24, 2023	Oct. 15, 2023	Radiation (03CH04-KS)
SHF-EHF Horn	Com-power	AH-840	101070	18GHz~40GHz	Jan. 08, 2023	May 24, 2023	Jan. 07, 2024	Radiation (03CH04-KS)
Amplifier	SONOMA	310N	380827	9KHz-1GHz	Jul. 11, 2022	May 24, 2023	Jul. 10, 2023	Radiation (03CH04-KS)
Amplifier	MITEQ	EM18G40G GA	060728	18~40GHz	Jan. 05, 2023	May 24, 2023	Jan. 04, 2024	Radiation (03CH04-KS)
high gain Amplifier	EM	EM01G18G A	060840	1Ghz-18Ghz	Oct. 12, 2022	May 24, 2023	Oct. 11, 2023	Radiation (03CH04-KS)
Amplifier	Agilent	8449B	3008A02370	1Ghz-18Ghz	Oct. 12, 2022	May 24, 2023	Oct. 11, 2023	Radiation (03CH04-KS)
AC Power Source	Chroma	61601	F104090004	N/A	NCR	May 24, 2023	NCR	Radiation (03CH04-KS)
Turn Table	ChamPro	EM 1000-T	060762-T	0~360 degree	NCR	May 24, 2023	NCR	Radiation (03CH04-KS)
Antenna Mast	ChamPro	EM 1000-A	060762-A	1 m~4 m	NCR	May 24, 2023	NCR	Radiation (03CH04-KS)

NCR: No Calibration Required



## 6 Measurement Uncertainty

The measurement uncertainties shown below were calculated in accordance with the requirements of ANSI 63.26-2015. All the measurement uncertainty value were shown with a coverage K=2 to indicate 95% level of confidence. The measurement data show herein meets or exceeds the CISPR measurement uncertainty values specified in CISPR 16-4-2 and can be compared directly to specified limit to determine compliance.

### Uncertainty of Conducted Measurement <TH01-KS>

Test Item	Uncertainty
Conducted Power	±0.46 dB
Conducted Emissions	±0.48 dB
Occupied Channel Bandwidth	±0.1 %

### Uncertainty of Conducted Measurement <TH01-SZ>

Test Item	Uncertainty
Conducted Power	±1.34 dB
Conducted Emissions	±1.34 dB
Occupied Channel Bandwidth	±0.13 %

### Uncertainty of Radiated Emission Measurement (30 MHz ~ 1000 MHz)

Measuring Uncertainty for a Level of Confidence of 95% (U = 2Uc(y))	3.82 dB
---	---------

### Uncertainty of Radiated Emission Measurement (1 GHz ~ 18 GHz)

Measuring Uncertainty for a Level of Confidence of 95% (U = 2Uc(y))	3.56 dB
---	---------

### Uncertainty of Radiated Emission Measurement (18 GHz ~ 40 GHz)

Measuring Uncertainty for a Level of Confidence of 95% (U = 2Uc(y))	3.54 dB
---	---------

----- THE END -----



## Appendix A. Test Results of Conducted Test

Test Engineer :	Simle Wang	Temperature :	22~23°C
		Relative Humidity :	40~42%

# FR1 N77(ANT3)

## Transmitter Conducted Output Power And EIRP, (G<sub>T</sub> - L<sub>C</sub>)=-2.4dB

NR Band	SCS	BandWidth	Arfcn	Freq (MHz)	Modulation	RB	Conducted Power (dBm)	EIRP (dBm)	EIRP (W)
77	30	10	630334	3455.01	DFT-s-OFDM PI/2 BPSK	1@1	27.21	24.81	0.3027
77	30	10	630334	3455.01	DFT-s-OFDM QPSK	1@1	27.27	24.87	0.3069
77	30	10	630334	3455.01	DFT-s-OFDM 16 QAM	1@1	26.09	23.69	0.2339
77	30	10	633334	3500.01	DFT-s-OFDM PI/2 BPSK	1@1	27.08	24.68	0.2938
77	30	10	633334	3500.01	DFT-s-OFDM QPSK	1@1	27.14	24.74	0.2979
77	30	10	633334	3500.01	DFT-s-OFDM 16 QAM	1@1	26.14	23.74	0.2366
77	30	10	636332	3544.98	DFT-s-OFDM PI/2 BPSK	1@1	26.97	24.57	0.2864
77	30	10	636332	3544.98	DFT-s-OFDM QPSK	1@1	27.01	24.61	0.2891
77	30	10	636332	3544.98	DFT-s-OFDM 16 QAM	1@1	25.92	23.52	0.2249
77	30	15	630500	3457.5	DFT-s-OFDM PI/2 BPSK	1@1	27.42	25.02	0.3177
77	30	15	630500	3457.5	DFT-s-OFDM QPSK	1@1	27.57	25.17	0.3289
77	30	15	630500	3457.5	DFT-s-OFDM 16 QAM	1@1	26.35	23.95	0.2483
77	30	15	633334	3500.01	DFT-s-OFDM PI/2 BPSK	1@1	27.27	24.87	0.3069
77	30	15	633334	3500.01	DFT-s-OFDM QPSK	1@1	27.24	24.84	0.3048
77	30	15	633334	3500.01	DFT-s-OFDM 16 QAM	1@1	26.32	23.92	0.2466
77	30	15	636166	3542.49	DFT-s-OFDM PI/2 BPSK	1@1	27.15	24.75	0.2985
77	30	15	636166	3542.49	DFT-s-OFDM QPSK	1@1	27.2	24.8	0.3020
77	30	15	636166	3542.49	DFT-s-OFDM 16 QAM	1@1	26.07	23.67	0.2328
77	30	20	630668	3460.02	DFT-s-OFDM PI/2 BPSK	1@1	27.29	24.89	0.3083
77	30	20	630668	3460.02	DFT-s-OFDM QPSK	1@1	27.34	24.94	0.3119
77	30	20	630668	3460.02	DFT-s-OFDM 16 QAM	1@1	26.29	23.89	0.2449
77	30	20	633334	3500.01	DFT-s-OFDM PI/2 BPSK	1@1	27.28	24.88	0.3076
77	30	20	633334	3500.01	DFT-s-OFDM QPSK	1@1	27.14	24.74	0.2979
77	30	20	633334	3500.01	DFT-s-OFDM 16 QAM	1@1	26.35	23.95	0.2483
77	30	20	636000	3540	DFT-s-OFDM PI/2 BPSK	1@1	27.22	24.82	0.3034
77	30	20	636000	3540	DFT-s-OFDM QPSK	1@1	27.3	24.9	0.3090
77	30	20	636000	3540	DFT-s-OFDM 16 QAM	1@1	26.09	23.69	0.2339
77	30	30	631000	3465	DFT-s-OFDM PI/2 BPSK	1@1	27.44	25.04	0.3192
77	30	30	631000	3465	DFT-s-OFDM QPSK	1@1	27.59	25.19	0.3304
77	30	30	631000	3465	DFT-s-OFDM 16 QAM	1@1	26.29	23.89	0.2449
77	30	30	633334	3500.01	DFT-s-OFDM PI/2 BPSK	1@1	27.35	24.95	0.3126
77	30	30	633334	3500.01	DFT-s-OFDM QPSK	1@1	27.25	24.85	0.3055
77	30	30	633334	3500.01	DFT-s-OFDM 16 QAM	1@1	26.4	24	0.2512
77	30	30	635666	3534.99	DFT-s-OFDM PI/2 BPSK	1@1	27.34	24.94	0.3119
77	30	30	635666	3534.99	DFT-s-OFDM QPSK	1@1	27.35	24.95	0.3126
77	30	30	635666	3534.99	DFT-s-OFDM 16 QAM	1@1	26.16	23.76	0.2377
77	30	40	631334	3470.01	DFT-s-OFDM PI/2 BPSK	1@1	28.29	25.89	0.3882
77	30	40	631334	3470.01	DFT-s-OFDM QPSK	1@1	28.32	25.92	0.3908
77	30	40	631334	3470.01	DFT-s-OFDM 16 QAM	1@1	27.13	24.73	0.2972
77	30	40	633334	3500.01	DFT-s-OFDM PI/2 BPSK	1@1	28.42	26.02	0.3999

NR Band	SCS	BandWidth	Arfcn	Freq (MHz)	Modulation	RB	Conducted Power (dBm)	EIRP (dBm)	EIRP (W)
77	30	40	633334	3500.01	DFT-s-OFDM QPSK	1@1	28.39	25.99	0.3972
77	30	40	633334	3500.01	DFT-s-OFDM 16 QAM	1@1	27.29	24.89	0.3083
77	30	40	635332	3529.98	DFT-s-OFDM PI/2 BPSK	1@1	28.43	26.03	0.4009
77	30	40	635332	3529.98	DFT-s-OFDM QPSK	1@1	28.43	26.03	0.4009
77	30	40	635332	3529.98	DFT-s-OFDM 16 QAM	1@1	27.33	24.93	0.3112
77	30	50	631668	3475.02	DFT-s-OFDM PI/2 BPSK	1@1	28.36	25.96	0.3945
77	30	50	631668	3475.02	DFT-s-OFDM QPSK	1@1	28.39	25.99	0.3972
77	30	50	631668	3475.02	DFT-s-OFDM 16 QAM	1@1	27.54	25.14	0.3266
77	30	50	633334	3500.01	DFT-s-OFDM PI/2 BPSK	1@1	28.23	25.83	0.3828
77	30	50	633334	3500.01	DFT-s-OFDM QPSK	1@1	28.29	25.89	0.3882
77	30	50	633334	3500.01	DFT-s-OFDM 16 QAM	1@1	27.31	24.91	0.3097
77	30	50	635000	3525	DFT-s-OFDM PI/2 BPSK	1@1	28.3	25.9	0.3890
77	30	50	635000	3525	DFT-s-OFDM QPSK	1@1	28.31	25.91	0.3899
77	30	50	635000	3525	DFT-s-OFDM 16 QAM	1@1	27.13	24.73	0.2972
77	30	60	632000	3480	DFT-s-OFDM PI/2 BPSK	1@1	28.38	25.98	0.3963
77	30	60	632000	3480	DFT-s-OFDM QPSK	1@1	28.4	26	0.3981
77	30	60	632000	3480	DFT-s-OFDM 16 QAM	1@1	27.26	24.86	0.3062
77	30	60	633334	3500.01	DFT-s-OFDM PI/2 BPSK	1@1	28.18	25.78	0.3784
77	30	60	633334	3500.01	DFT-s-OFDM QPSK	1@1	28.2	25.8	0.3802
77	30	60	633334	3500.01	DFT-s-OFDM 16 QAM	1@1	27.37	24.97	0.3141
77	30	60	634666	3519.99	DFT-s-OFDM PI/2 BPSK	1@1	28.29	25.89	0.3882
77	30	60	634666	3519.99	DFT-s-OFDM QPSK	1@1	28.34	25.94	0.3926
77	30	60	634666	3519.99	DFT-s-OFDM 16 QAM	1@1	27.22	24.82	0.3034
77	30	70	632334	3485.01	DFT-s-OFDM PI/2 BPSK	1@1	28.31	25.91	0.3899
77	30	70	632334	3485.01	DFT-s-OFDM QPSK	1@1	28.28	25.88	0.3873
77	30	70	632334	3485.01	DFT-s-OFDM 16 QAM	1@1	27.2	24.8	0.3020
77	30	70	633334	3500.01	DFT-s-OFDM PI/2 BPSK	1@1	28.12	25.72	0.3733
77	30	70	633334	3500.01	DFT-s-OFDM QPSK	1@1	28.19	25.79	0.3793
77	30	70	633334	3500.01	DFT-s-OFDM 16 QAM	1@1	27.39	24.99	0.3155
77	30	70	634332	3514.98	DFT-s-OFDM PI/2 BPSK	1@1	28.14	25.74	0.3750
77	30	70	634332	3514.98	DFT-s-OFDM QPSK	1@1	28.13	25.73	0.3741
77	30	70	634332	3514.98	DFT-s-OFDM 16 QAM	1@1	27.42	25.02	0.3177
77	30	80	632668	3490.02	DFT-s-OFDM PI/2 BPSK	1@1	28.26	25.86	0.3855
77	30	80	632668	3490.02	DFT-s-OFDM QPSK	1@1	28.35	25.95	0.3936
77	30	80	632668	3490.02	DFT-s-OFDM 16 QAM	1@1	27.53	25.13	0.3258
77	30	80	633334	3500.01	DFT-s-OFDM PI/2 BPSK	1@1	28.12	25.72	0.3733
77	30	80	633334	3500.01	DFT-s-OFDM QPSK	1@1	28.17	25.77	0.3776
77	30	80	633334	3500.01	DFT-s-OFDM 16 QAM	1@1	27.02	24.62	0.2897
77	30	80	634000	3500.01	DFT-s-OFDM PI/2 BPSK	1@1	28.15	25.75	0.3758
77	30	80	634000	3510	DFT-s-OFDM QPSK	1@1	28.1	25.7	0.3715
77	30	80	634000	3510	DFT-s-OFDM 16 QAM	1@1	27.37	24.97	0.3141
77	30	90	633000	3495	DFT-s-OFDM PI/2 BPSK	1@1	28.25	25.85	0.3846
77	30	90	633000	3495	DFT-s-OFDM QPSK	1@1	28.29	25.89	0.3882
77	30	90	633000	3495	DFT-s-OFDM 16 QAM	1@1	27.48	25.08	0.3221
77	30	90	633334	3500.01	DFT-s-OFDM PI/2 BPSK	1@1	28.18	25.78	0.3784
77	30	90	633334	3500.01	DFT-s-OFDM QPSK	1@1	28.07	25.67	0.3690
77	30	90	633334	3500.01	DFT-s-OFDM 16 QAM	1@1	27.01	24.61	0.2891

NR Band	SCS	BandWidth	Arfcn	Freq (MHz)	Modulation	RB	Conducted Power (dBm)	EIRP (dBm)	EIRP (W)
77	30	90	633666	3504.99	DFT-s-OFDM PI/2 BPSK	1@1	28.11	25.71	0.3724
77	30	90	633666	3504.99	DFT-s-OFDM QPSK	1@1	28.21	25.81	0.3811
77	30	90	633666	3504.99	DFT-s-OFDM 16 QAM	1@1	27.06	24.66	0.2924
77	30	100	633334	3500.01	DFT-s-OFDM PI/2 BPSK	135@67	28.16	25.76	0.3767
77	30	100	633334	3500.01	DFT-s-OFDM PI/2 BPSK	1@1	28.45	26.05	0.4027
77	30	100	633334	3500.01	DFT-s-OFDM PI/2 BPSK	1@271	28.13	25.73	0.3741
77	30	100	633334	3500.01	DFT-s-OFDM QPSK	135@67	28.13	25.73	0.3741
77	30	100	633334	3500.01	DFT-s-OFDM QPSK	1@1	28.22	25.82	0.3819
77	30	100	633334	3500.01	DFT-s-OFDM QPSK	1@271	28.11	25.71	0.3724
77	30	100	633334	3500.01	DFT-s-OFDM 16 QAM	135@67	26.06	23.66	0.2323
77	30	100	633334	3500.01	DFT-s-OFDM 16 QAM	1@1	26.16	23.76	0.2377
77	30	100	633334	3500.01	DFT-s-OFDM 16 QAM	1@271	25.61	23.21	0.2094
77	30	100	633334	3500.01	DFT-s-OFDM 64 QAM	135@67	24.05	21.65	0.1462
77	30	100	633334	3500.01	DFT-s-OFDM 64 QAM	1@1	24.1	21.7	0.1479
77	30	100	633334	3500.01	DFT-s-OFDM 64 QAM	1@271	23.35	20.95	0.1245
77	30	100	633334	3500.01	DFT-s-OFDM 256 QAM	135@67	20.63	18.23	0.0665
77	30	100	633334	3500.01	DFT-s-OFDM 256 QAM	1@1	20.7	18.3	0.0676
77	30	100	633334	3500.01	DFT-s-OFDM 256 QAM	1@271	20.01	17.61	0.0577
77	30	100	633334	3500.01	CP-OFDM QPSK	137@68	25.05	22.65	0.1841
77	30	100	633334	3500.01	CP-OFDM QPSK	1@1	25.19	22.79	0.1901
77	30	100	633334	3500.01	CP-OFDM QPSK	1@271	24.66	22.26	0.1683

## Frequency Stability

NR Band	SCS (kHz)	Bandwidth (MHz)	Arfcn	Freq (MHz)	Modulation	RB	Deviation (ppm)	Verdict	Environment
77	30	10	633334	3500.01	DFT-s-OFDM QPSK	24@0	-0.0021	PASS	NV
77	30	10	633334	3500.01	DFT-s-OFDM QPSK	24@0	0.0015	PASS	LV
77	30	10	633334	3500.01	DFT-s-OFDM QPSK	24@0	0.0012	PASS	HV
77	30	10	633334	3500.01	DFT-s-OFDM QPSK	24@0	0.0013	PASS	-30°C
77	30	10	633334	3500.01	DFT-s-OFDM QPSK	24@0	0.0021	PASS	-20°C
77	30	10	633334	3500.01	DFT-s-OFDM QPSK	24@0	0.0032	PASS	-10°C
77	30	10	633334	3500.01	DFT-s-OFDM QPSK	24@0	-0.0026	PASS	0°C
77	30	10	633334	3500.01	DFT-s-OFDM QPSK	24@0	0.0021	PASS	10°C
77	30	10	633334	3500.01	DFT-s-OFDM QPSK	24@0	0.0031	PASS	20°C
77	30	10	633334	3500.01	DFT-s-OFDM QPSK	24@0	0.0029	PASS	30°C
77	30	10	633334	3500.01	DFT-s-OFDM QPSK	24@0	0.0011	PASS	40°C
77	30	10	633334	3500.01	DFT-s-OFDM QPSK	24@0	0.0036	PASS	50°C

## Peak to Average Ratio

NR Band	SCS (kHz)	Bandwidth (MHz)	Arfcn	Freq (MHz)	Modulation	RB	Result (dB)	Limit (dB)	Verdict
77	30	100	633334	3500.01	DFT-s-OFDM PI/2 BPSK	270@0	10.21	13	PASS
77	30	100	633334	3500.01	DFT-s-OFDM PI/2 BPSK	1@0	7.11	13	PASS
77	30	100	633334	3500.01	DFT-s-OFDM QPSK	270@0	10.45	13	PASS
77	30	100	633334	3500.01	DFT-s-OFDM QPSK	1@0	8.78	13	PASS

N77(100M)\_DFT-s-OFDM\_PI\_2-BPSK\_Outer\_Full\_Mid\_CH



N77(100M)\_DFT-s-OFDM\_PI\_2-BPSK\_Edge\_1RB\_Left\_Mid\_CH



N77(100M)\_DFT-s-OFDM\_QPSK\_Outer\_Full\_Mid\_CH

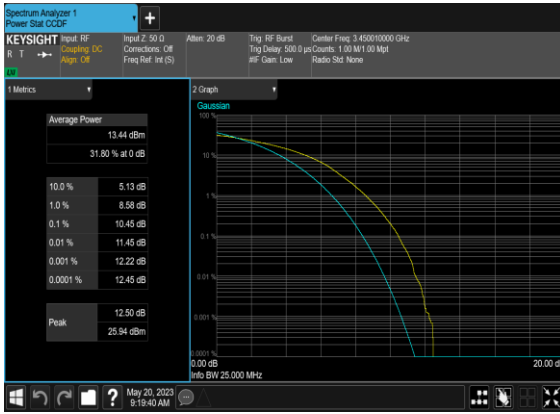

N77(100M)\_DFT-s-OFDM\_QPSK\_Edge\_1RB\_Left\_Mid\_CH

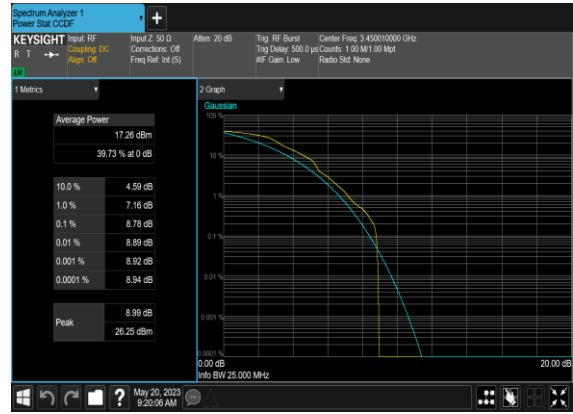



## Occupied Bandwidth

NR Band	SCS (kHz)	Bandwidth (MHz)	Arfcn	Freq (MHz)	Modulation	RB	OBW (MHz)	26dB BW (MHz)
77	30	10	633334	3500.01	CP-OFDM QPSK	24@0	8.5758	9.572
77	30	10	633334	3500.01	CP-OFDM 16 QAM	24@0	8.5688	9.497
77	30	10	633334	3500.01	CP-OFDM 64 QAM	24@0	8.5916	9.456
77	30	10	633334	3500.01	CP-OFDM 256 QAM	24@0	8.5612	9.281
77	30	15	633334	3500.01	CP-OFDM QPSK	38@0	13.549	14.67
77	30	15	633334	3500.01	CP-OFDM 16 QAM	38@0	13.573	14.78
77	30	15	633334	3500.01	CP-OFDM 64 QAM	38@0	13.525	14.99
77	30	15	633334	3500.01	CP-OFDM 256 QAM	38@0	13.556	14.86
77	30	20	633334	3500.01	CP-OFDM QPSK	51@0	18.217	19.09
77	30	20	633334	3500.01	CP-OFDM 16 QAM	51@0	18.182	19.3
77	30	20	633334	3500.01	CP-OFDM 64 QAM	51@0	18.234	19.33
77	30	20	633334	3500.01	CP-OFDM 256 QAM	51@0	18.21	19.22
77	30	30	633334	3500.01	CP-OFDM QPSK	78@0	27.711	29.21
77	30	30	633334	3500.01	CP-OFDM 16 QAM	78@0	27.863	29.06
77	30	30	633334	3500.01	CP-OFDM 64 QAM	78@0	27.815	29.24
77	30	30	633334	3500.01	CP-OFDM 256 QAM	78@0	27.823	29.49
77	30	40	633334	3500.01	CP-OFDM QPSK	106@0	37.843	39.17
77	30	40	633334	3500.01	CP-OFDM 16 QAM	106@0	37.785	39.46
77	30	40	633334	3500.01	CP-OFDM 64 QAM	106@0	37.757	39.09
77	30	40	633334	3500.01	CP-OFDM 256 QAM	106@0	37.952	39.23
77	30	50	633334	3500.01	CP-OFDM QPSK	133@0	47.385	49.29
77	30	50	633334	3500.01	CP-OFDM 16 QAM	133@0	47.533	49.07
77	30	50	633334	3500.01	CP-OFDM 64 QAM	133@0	47.438	49.01
77	30	50	633334	3500.01	CP-OFDM 256 QAM	133@0	47.379	49.58
77	30	60	633334	3500.01	CP-OFDM QPSK	162@0	57.873	59.77
77	30	60	633334	3500.01	CP-OFDM 16 QAM	162@0	57.574	59.71

77	30	60	633334	3500.01	CP-OFDM 64 QAM	162@0	57.773	59.69
77	30	60	633334	3500.01	CP-OFDM 256 QAM	162@0	57.854	59.63
77	30	70	633334	3500.01	CP-OFDM QPSK	189@0	67.338	69.55
77	30	70	633334	3500.01	CP-OFDM 16 QAM	189@0	67.383	69.71
77	30	70	633334	3500.01	CP-OFDM 64 QAM	189@0	67.51	69.55
77	30	70	633334	3500.01	CP-OFDM 256 QAM	189@0	67.289	69.72
77	30	80	633334	3500.01	CP-OFDM QPSK	217@0	77.153	79.99
77	30	80	633334	3500.01	CP-OFDM 16 QAM	217@0	77.441	79.92
77	30	80	633334	3500.01	CP-OFDM 64 QAM	217@0	77.403	79.98
77	30	80	633334	3500.01	CP-OFDM 256 QAM	217@0	77.307	79.9
77	30	90	633334	3500.01	CP-OFDM QPSK	245@0	87.219	90.4
77	30	90	633334	3500.01	CP-OFDM 16 QAM	245@0	87.405	90.54
77	30	90	633334	3500.01	CP-OFDM 64 QAM	245@0	87.329	90.46
77	30	90	633334	3500.01	CP-OFDM 256 QAM	245@0	87.316	90.17
77	30	100	633334	3500.01	CP-OFDM QPSK	273@0	97.208	100.5
77	30	100	633334	3500.01	CP-OFDM 16 QAM	273@0	97.132	100.4
77	30	100	633334	3500.01	CP-OFDM 64 QAM	273@0	97.263	100.4
77	30	100	633334	3500.01	CP-OFDM 256 QAM	273@0	97.265	100.5

### N77(10M)\_CP-OFDM\_QPSK\_Outer\_Full\_Mid\_CH

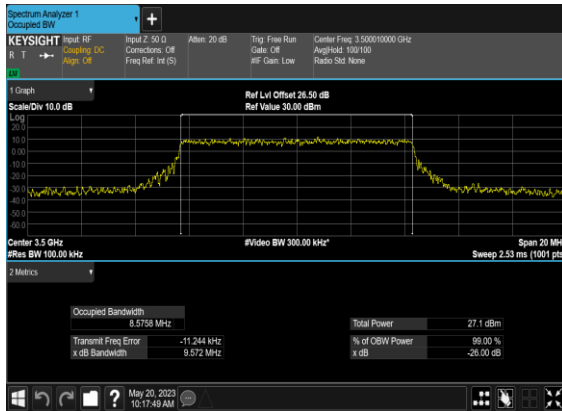

### N77(10M)\_CP-OFDM\_16QAM\_Outer\_Full\_Mid\_CH

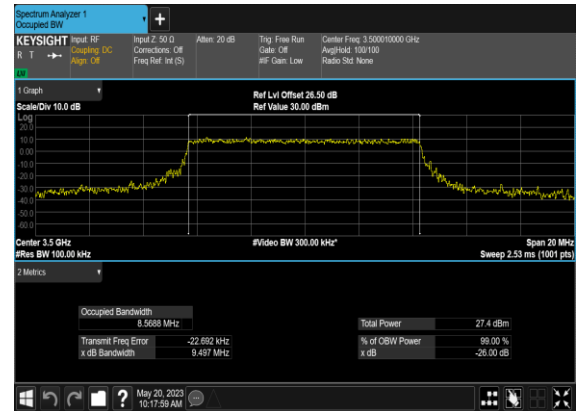

### N77(10M)\_CP-OFDM\_64QAM\_Outer\_Full\_Mid\_CH

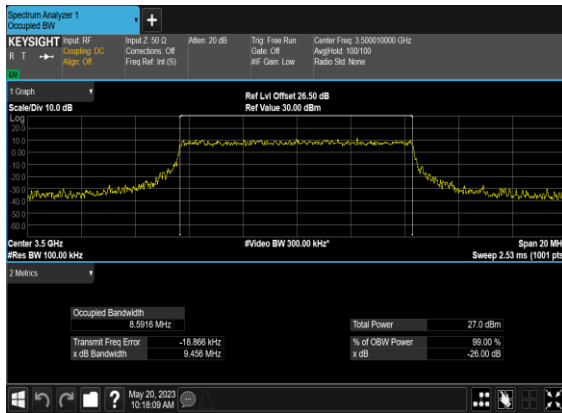

### N77(10M)\_CP-OFDM\_256QAM\_Outer\_Full\_Mid\_CH



### N77(15M)\_CP-OFDM\_QPSK\_Outer\_Full\_Mid\_CH

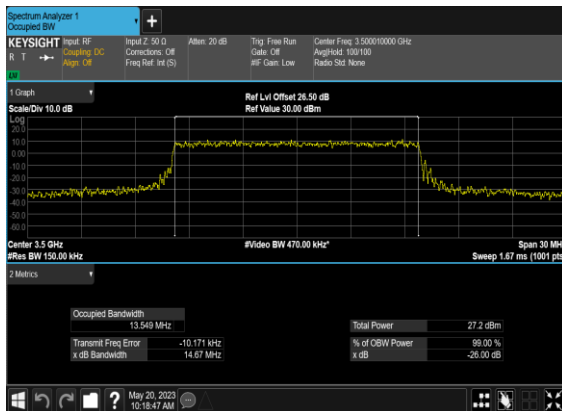

### N77(15M)\_CP-OFDM\_16QAM\_Outer\_Full\_Mid\_CH

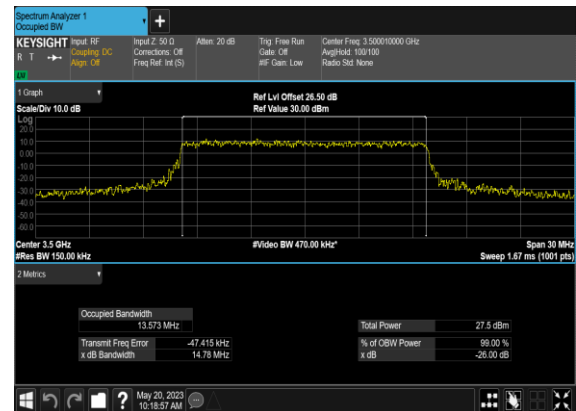

### N77(15M)\_CP-OFDM\_64 QAM\_Outer\_Full\_Mid\_CH

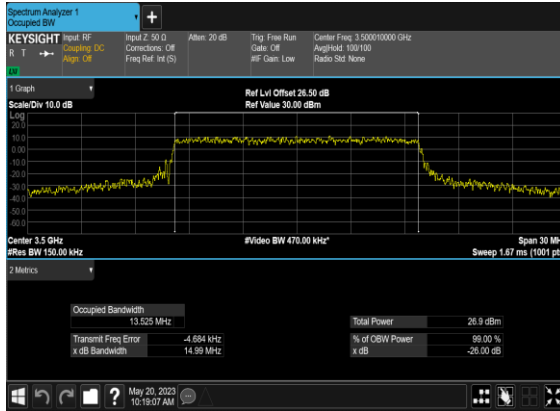

### N77(15M)\_CP-OFDM\_256 QAM\_Outer\_Full\_Mid\_CH

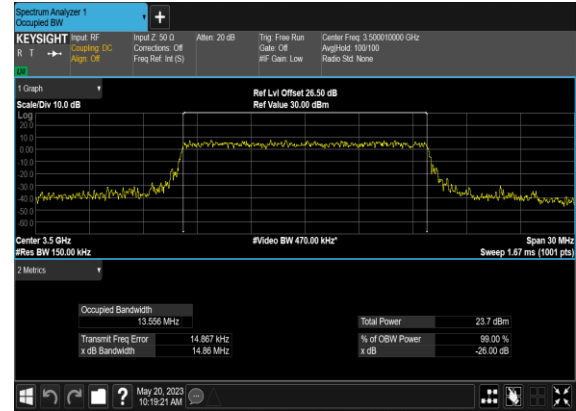

### N77(20M)\_CP- OFDM\_QPSK\_Outer\_Full\_Mid\_CH



### N77(20M)\_CP-OFDM\_16 QAM\_Outer\_Full\_Mid\_CH

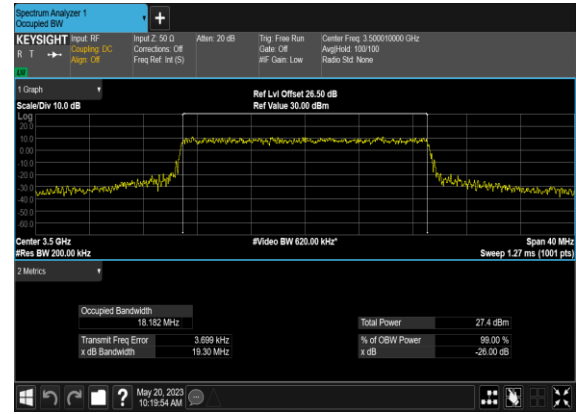

### N77(20M)\_CP-OFDM\_64 QAM\_Outer\_Full\_Mid\_CH

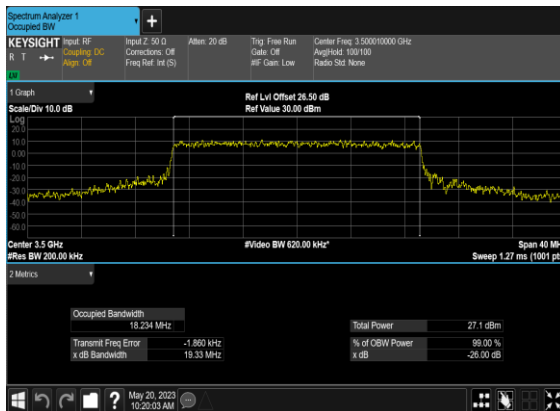

### N77(20M)\_CP-OFDM\_256 QAM\_Outer\_Full\_Mid\_CH

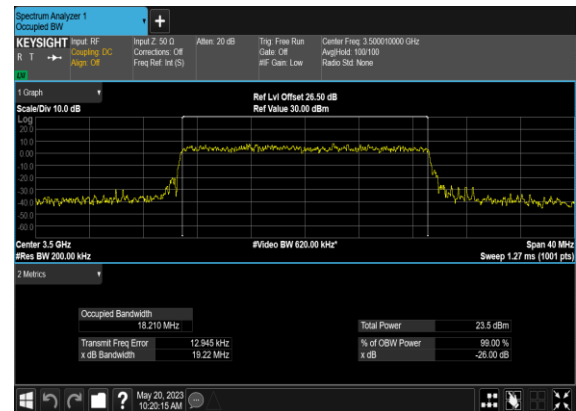

### N77(30M)\_CP-OFDM\_QPSK\_Outer\_Full\_Mid\_CH

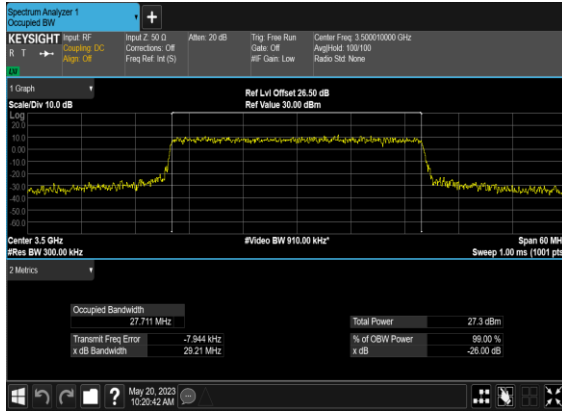

### N77(30M)\_CP-OFDM\_16QAM\_Outer\_Full\_Mid\_CH

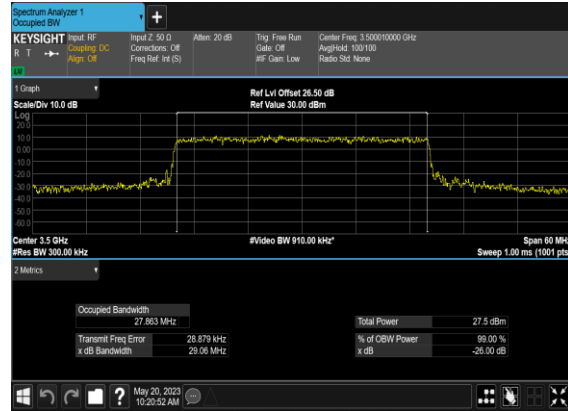

### N77(30M)\_CP-OFDM\_64QAM\_Outer\_Full\_Mid\_CH



### N77(30M)\_CP-OFDM\_256QAM\_Outer\_Full\_Mid\_CH

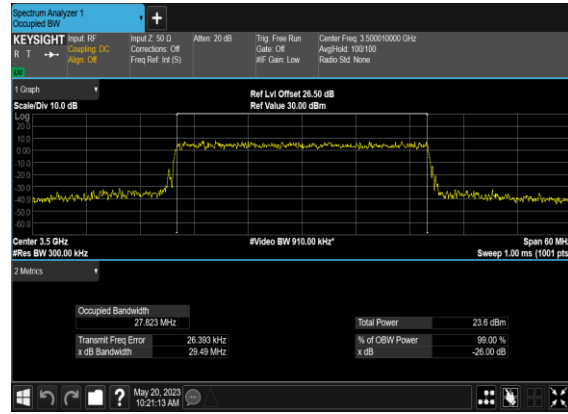

### N77(40M)\_CP-OFDM\_QPSK\_Outer\_Full\_Mid\_CH

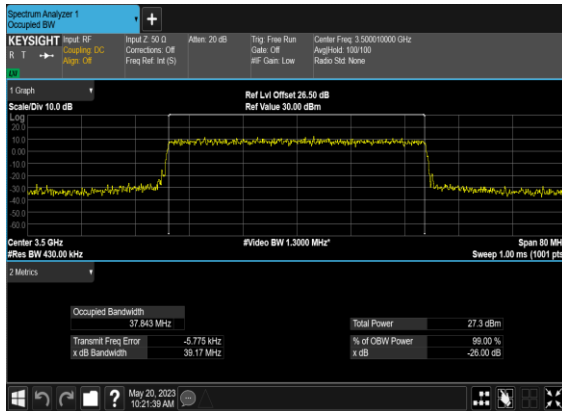

### N77(40M)\_CP-OFDM\_16QAM\_Outer\_Full\_Mid\_CH

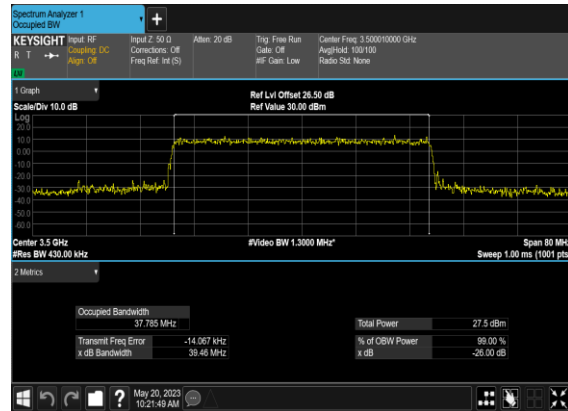

### N77(40M)\_CP-OFDM\_64 QAM\_Outer\_Full\_Mid\_CH

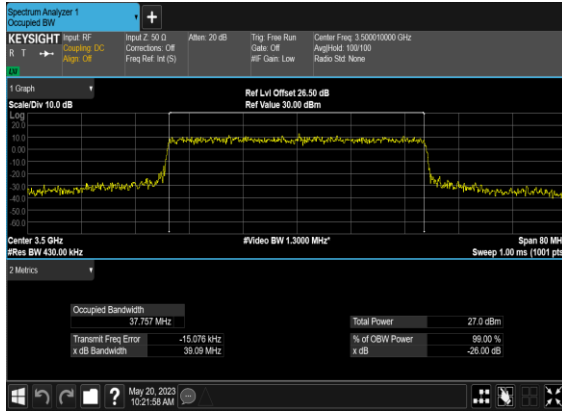

### N77(40M)\_CP-OFDM\_256 QAM\_Outer\_Full\_Mid\_CH

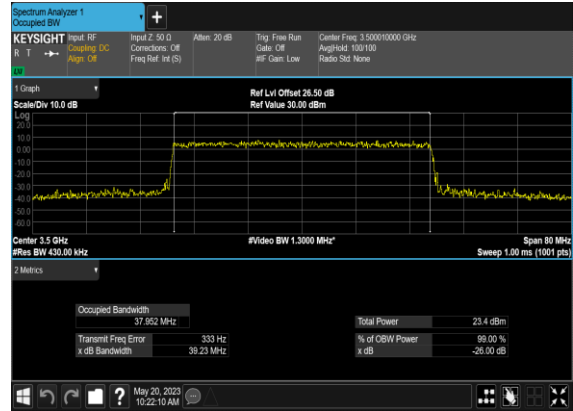

### N77(50M)\_CP- OFDM\_QPSK\_Outer\_Full\_Mid\_CH

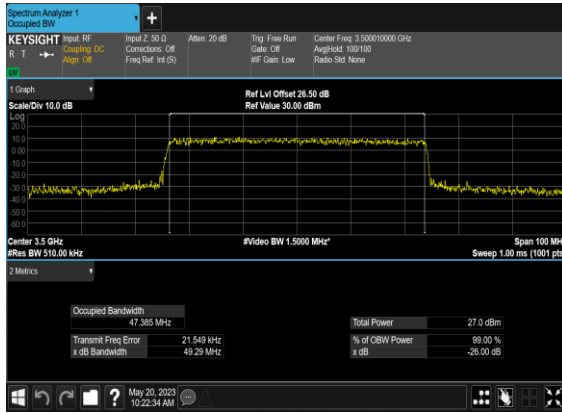

### N77(50M)\_CP-OFDM\_16 QAM\_Outer\_Full\_Mid\_CH

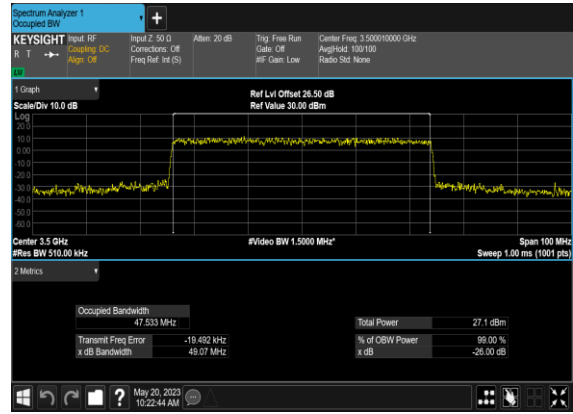

### N77(50M)\_CP-OFDM\_64 QAM\_Outer\_Full\_Mid\_CH

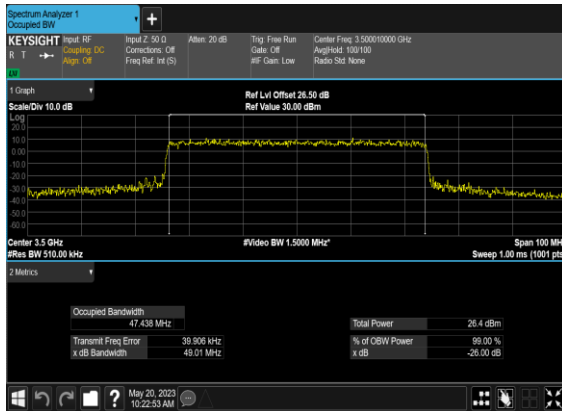

### N77(50M)\_CP-OFDM\_256 QAM\_Outer\_Full\_Mid\_CH

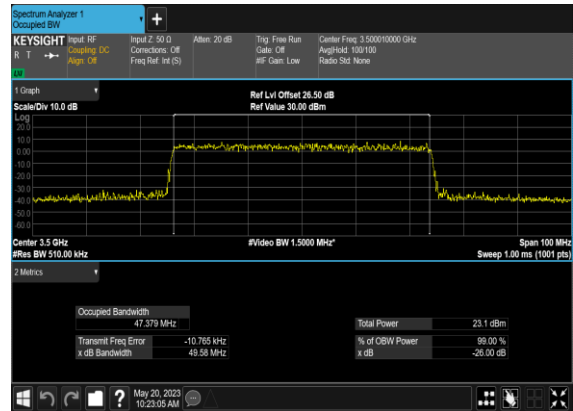

### N77(60M)\_CP-OFDM\_QPSK\_Outer\_Full\_Mid\_CH

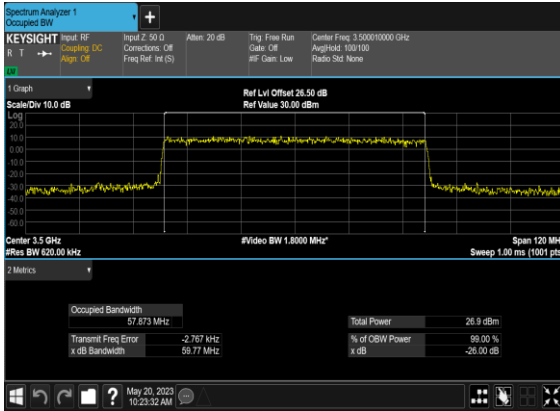

### N77(60M)\_CP-OFDM\_16QAM\_Outer\_Full\_Mid\_CH

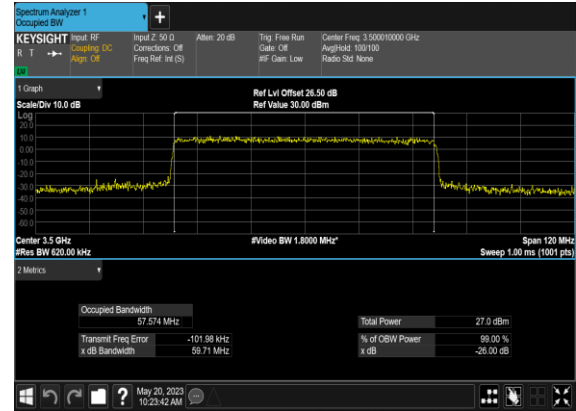

### N77(60M)\_CP-OFDM\_64QAM\_Outer\_Full\_Mid\_CH

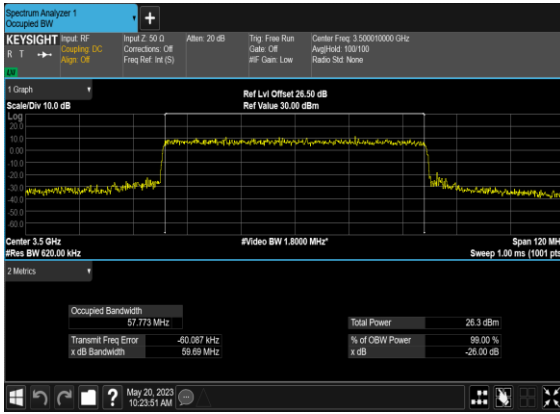

### N77(60M)\_CP-OFDM\_256QAM\_Outer\_Full\_Mid\_CH

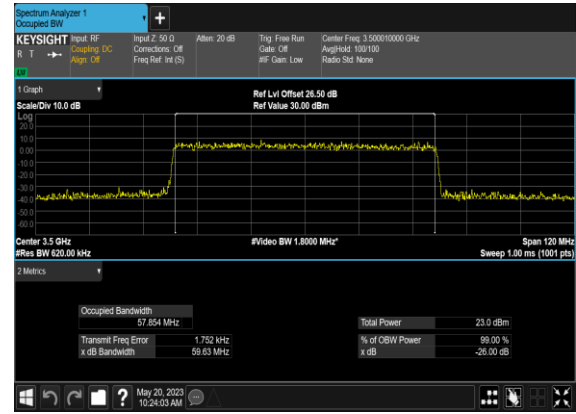

### N77(70M)\_CP-OFDM\_QPSK\_Outer\_Full\_Mid\_CH

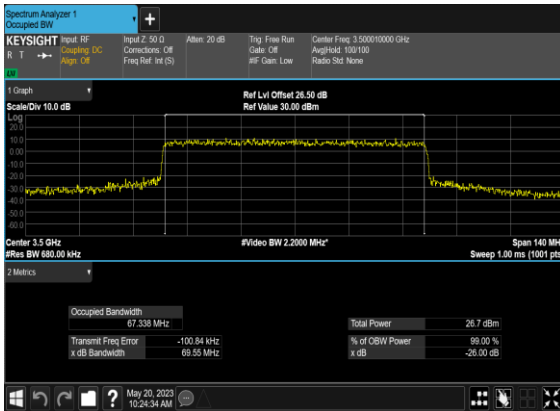

### N77(70M)\_CP-OFDM\_16QAM\_Outer\_Full\_Mid\_CH

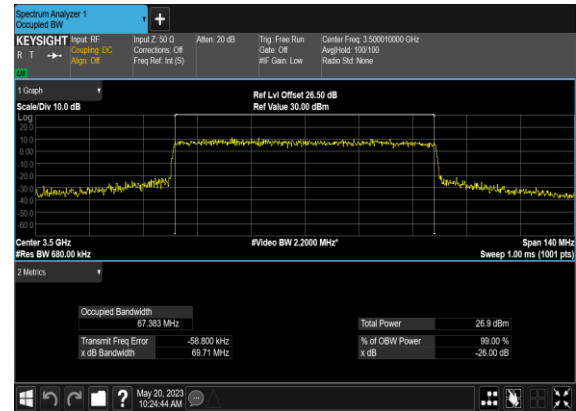

### N77(70M)\_CP-OFDM\_64 QAM\_Outer\_Full\_Mid\_CH

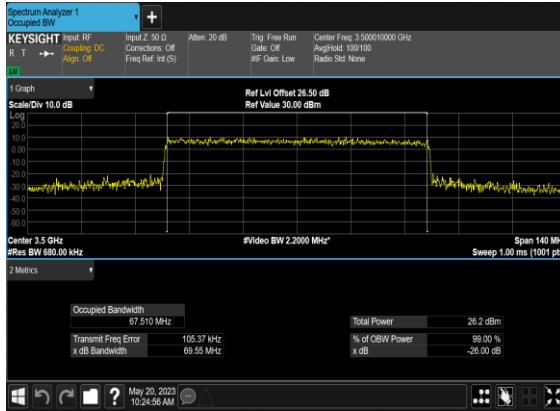

### N77(70M)\_CP-OFDM\_256 QAM\_Outer\_Full\_Mid\_CH

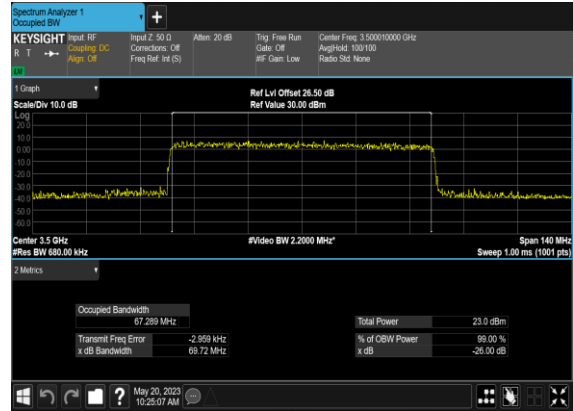

### N77(80M)\_CP- OFDM\_QPSK\_Outer\_Full\_Mid\_CH



### N77(80M)\_CP-OFDM\_16 QAM\_Outer\_Full\_Mid\_CH

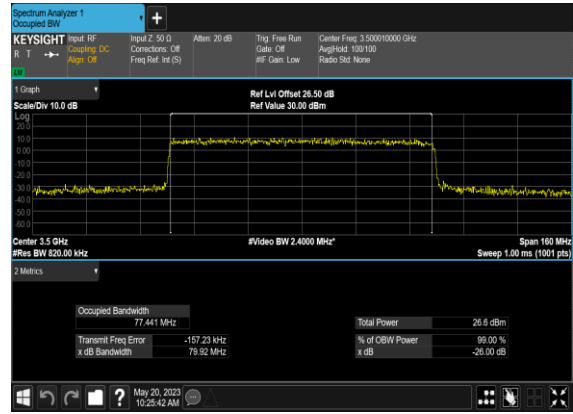

### N77(80M)\_CP-OFDM\_64 QAM\_Outer\_Full\_Mid\_CH

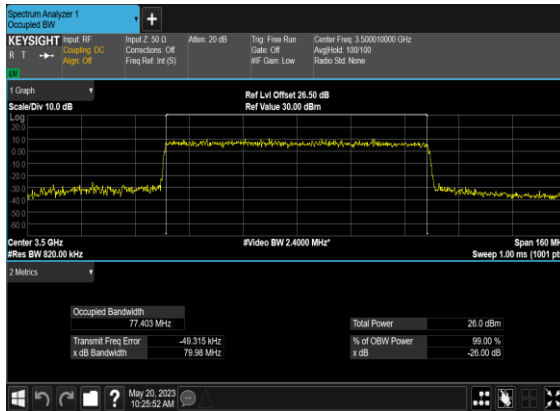

### N77(80M)\_CP-OFDM\_256 QAM\_Outer\_Full\_Mid\_CH

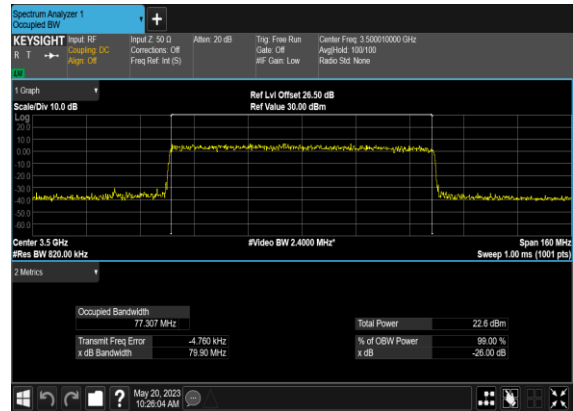



### N77(90M)\_CP-OFDM\_QPSK\_Outer\_Full\_Mid\_CH

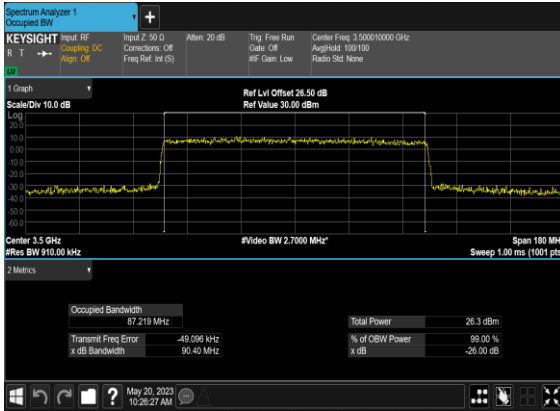

### N77(90M)\_CP-OFDM\_16 QAM\_Outer\_Full\_Mid\_CH

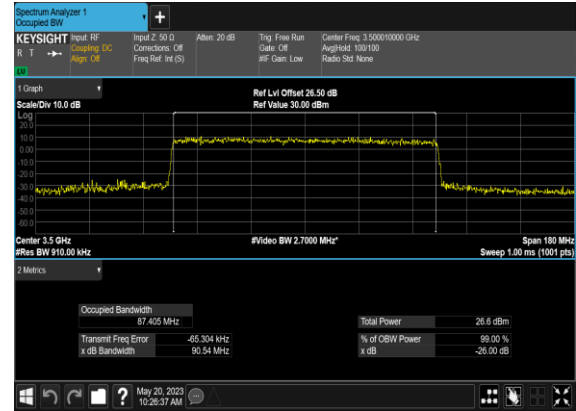

### N77(90M)\_CP-OFDM\_64 QAM\_Outer\_Full\_Mid\_CH

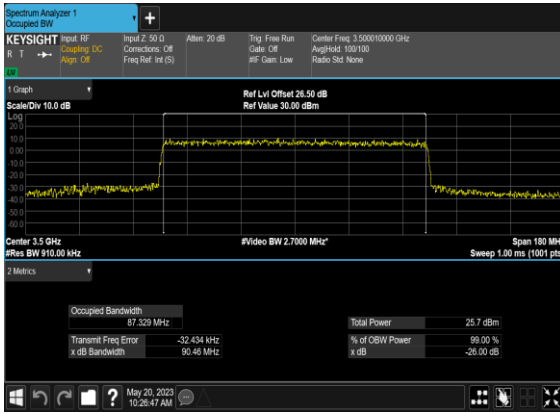

### N77(90M)\_CP-OFDM\_256 QAM\_Outer\_Full\_Mid\_CH

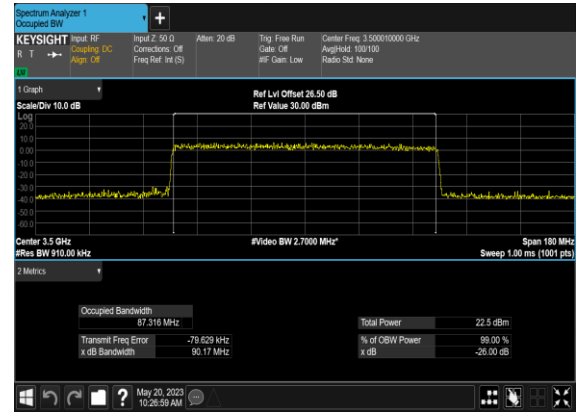

### N77(100M)\_CP-OFDM\_QPSK\_Outer\_Full\_Mid\_CH



### N77(100M)\_CP-OFDM\_16 QAM\_Outer\_Full\_Mid\_CH

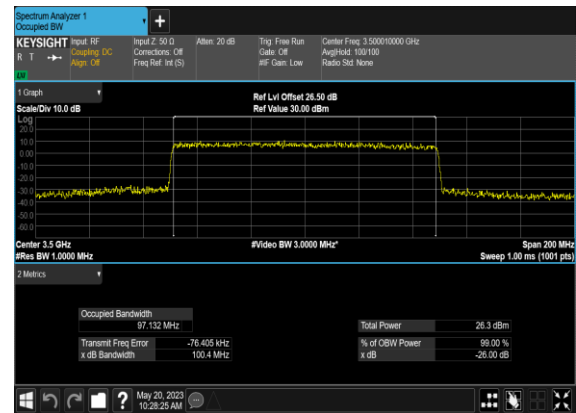

## N77(100M)\_CP-OFDM\_64 QAM\_Outer\_Full\_Mid\_CH

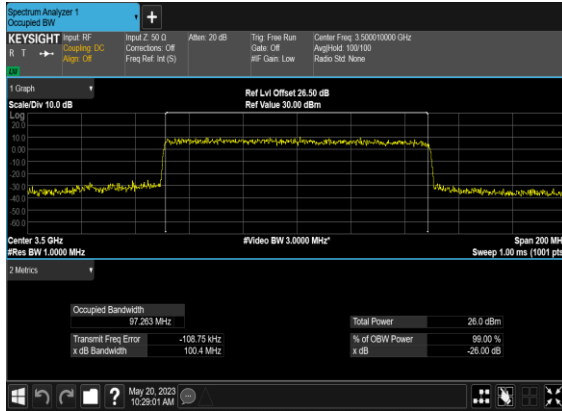

## N77(100M)\_CP-OFDM\_256 QAM\_Outer\_Full\_Mid\_CH

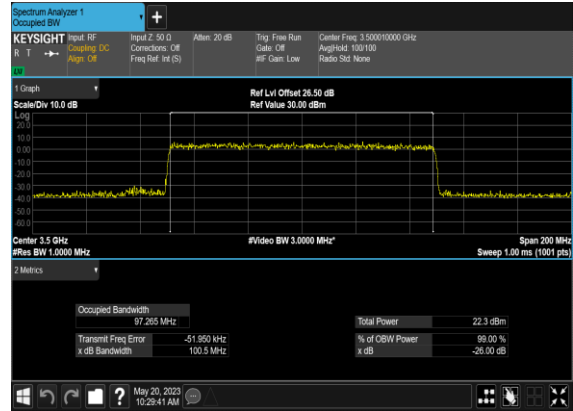

## Conducted Spurious Emissions

NR Band	SCS (kHz)	Bandwidth (MHz)	Arfcn	Freq (MHz)	Modulation	RB	Result	Verdict
77	30	10	630334	3455.01	DFT-s-OFDM BPSK	1@0	see graph	---
77	30	10	630334	3455.01	DFT-s-OFDM BPSK	1@0	see graph	PASS
77	30	10	630334	3455.01	DFT-s-OFDM BPSK	1@0	see graph	PASS
77	30	10	630334	3455.01	DFT-s-OFDM QPSK	1@0	see graph	---
77	30	10	630334	3455.01	DFT-s-OFDM QPSK	1@0	see graph	PASS
77	30	10	630334	3455.01	DFT-s-OFDM QPSK	1@0	see graph	PASS
77	30	10	633334	3500.01	DFT-s-OFDM BPSK	1@0	see graph	---
77	30	10	633334	3500.01	DFT-s-OFDM BPSK	1@0	see graph	PASS
77	30	10	633334	3500.01	DFT-s-OFDM BPSK	1@0	see graph	PASS
77	30	10	633334	3500.01	DFT-s-OFDM QPSK	1@0	see graph	---
77	30	10	633334	3500.01	DFT-s-OFDM QPSK	1@0	see graph	PASS
77	30	10	633334	3500.01	DFT-s-OFDM QPSK	1@0	see graph	PASS
77	30	10	636332	3544.98	DFT-s-OFDM BPSK	1@0	see graph	---
77	30	10	636332	3544.98	DFT-s-OFDM BPSK	1@0	see graph	PASS
77	30	10	636332	3544.98	DFT-s-OFDM BPSK	1@0	see graph	PASS
77	30	10	636332	3544.98	DFT-s-OFDM QPSK	1@0	see graph	---
77	30	10	636332	3544.98	DFT-s-OFDM QPSK	1@0	see graph	PASS
77	30	10	636332	3544.98	DFT-s-OFDM QPSK	1@0	see graph	PASS
77	30	50	631668	3475.02	DFT-s-OFDM BPSK	1@0	see graph	---
77	30	50	631668	3475.02	DFT-s-OFDM BPSK	1@0	see graph	PASS
77	30	50	631668	3475.02	DFT-s-OFDM BPSK	1@0	see graph	PASS
77	30	50	631668	3475.02	DFT-s-OFDM QPSK	1@0	see graph	---
77	30	50	631668	3475.02	DFT-s-OFDM QPSK	1@0	see graph	PASS

77	30	50	631668	3475.02	DFT-s-OFDM QPSK	1@0	see graph	PASS
77	30	50	633334	3500.01	DFT-s-OFDM BPSK	1@0	see graph	---
77	30	50	633334	3500.01	DFT-s-OFDM BPSK	1@0	see graph	PASS
77	30	50	633334	3500.01	DFT-s-OFDM BPSK	1@0	see graph	PASS
77	30	50	633334	3500.01	DFT-s-OFDM QPSK	1@0	see graph	---
77	30	50	633334	3500.01	DFT-s-OFDM QPSK	1@0	see graph	PASS
77	30	50	633334	3500.01	DFT-s-OFDM QPSK	1@0	see graph	PASS
77	30	50	635000	3525.0	DFT-s-OFDM BPSK	1@0	see graph	---
77	30	50	635000	3525.0	DFT-s-OFDM BPSK	1@0	see graph	PASS
77	30	50	635000	3525.0	DFT-s-OFDM BPSK	1@0	see graph	PASS
77	30	50	635000	3525.0	DFT-s-OFDM QPSK	1@0	see graph	---
77	30	50	635000	3525.0	DFT-s-OFDM QPSK	1@0	see graph	PASS
77	30	50	635000	3525.0	DFT-s-OFDM QPSK	1@0	see graph	PASS
77	30	100	633334	3500.01	DFT-s-OFDM BPSK	1@0	see graph	---
77	30	100	633334	3500.01	DFT-s-OFDM BPSK	1@0	see graph	PASS
77	30	100	633334	3500.01	DFT-s-OFDM BPSK	1@0	see graph	PASS
77	30	100	633334	3500.01	DFT-s-OFDM QPSK	1@0	see graph	---
77	30	100	633334	3500.01	DFT-s-OFDM QPSK	1@0	see graph	PASS
77	30	100	633334	3500.01	DFT-s-OFDM QPSK	1@0	see graph	PASS

### N77(10M)\_DFT-s-OFDM\_BPSK\_Edge\_1RB\_Left\_Low\_CH

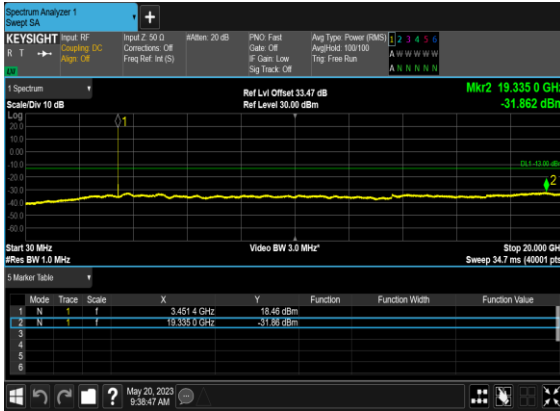

### N77(10M)\_DFT-s-OFDM\_BPSK\_Edge\_1RB\_Left\_Low\_CH

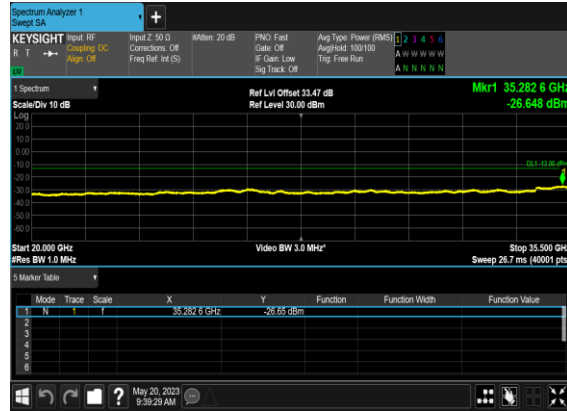

### N77(10M)\_DFT-s-OFDM\_QPSK\_Edge\_1RB\_Left\_Low\_CH

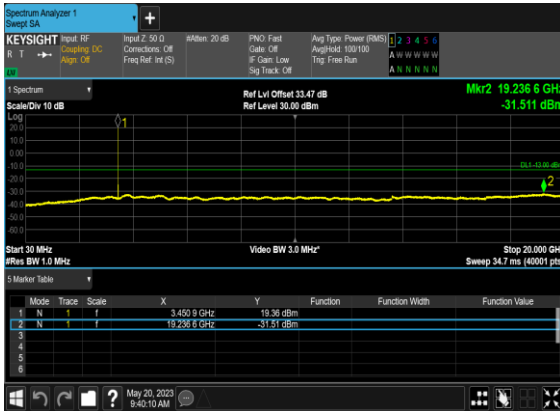

### N77(10M)\_DFT-s-OFDM\_QPSK\_Edge\_1RB\_Left\_Low\_CH

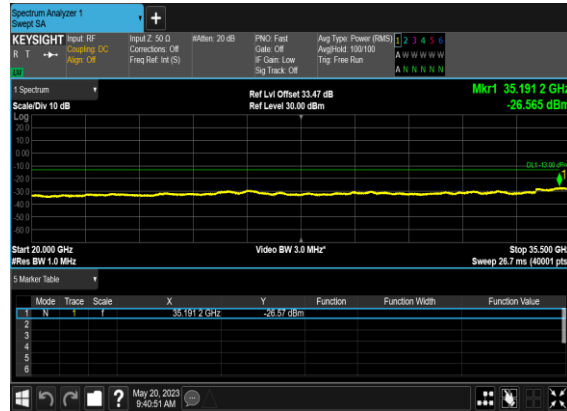

### N77(10M)\_DFT-s-OFDM\_BPSK\_Edge\_1RB\_Left\_Mid\_CH

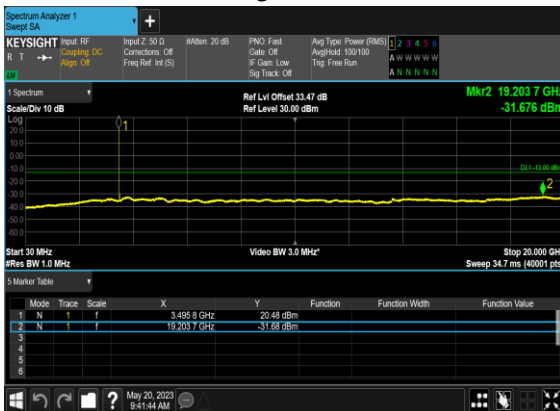

### N77(10M)\_DFT-s-OFDM\_BPSK\_Edge\_1RB\_Left\_Mid\_CH

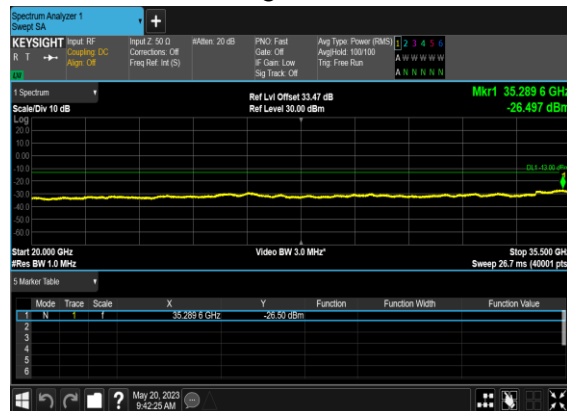

N77(10M)\_DFT-s-OFDM\_QPSK\_Edge\_1RB\_Left\_Mid\_CH

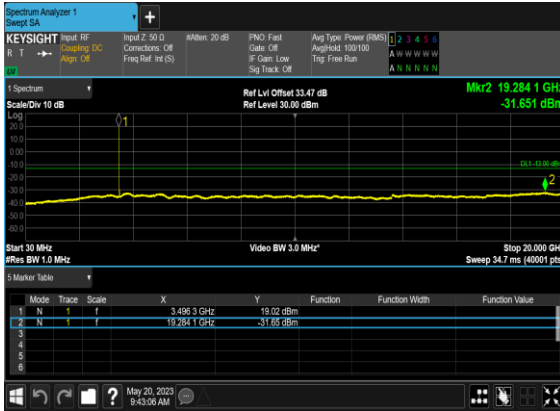

N77(10M)\_DFT-s-OFDM\_QPSK\_Edge\_1RB\_Left\_Mid\_CH

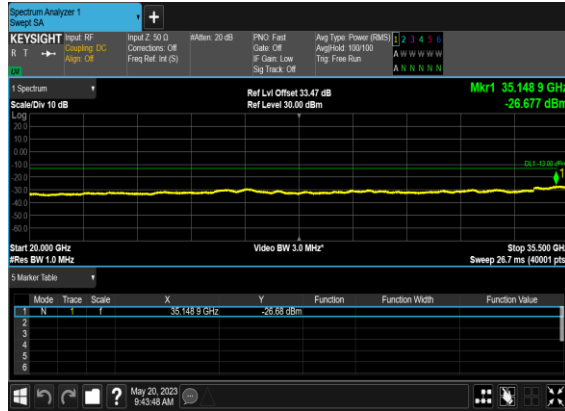

N77(10M)\_DFT-s-OFDM\_BPSK\_Edge\_1RB\_Left\_High\_CH

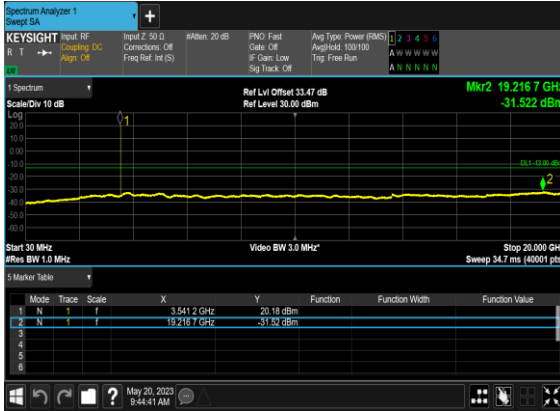

N77(10M)\_DFT-s-OFDM\_BPSK\_Edge\_1RB\_Left\_High\_CH

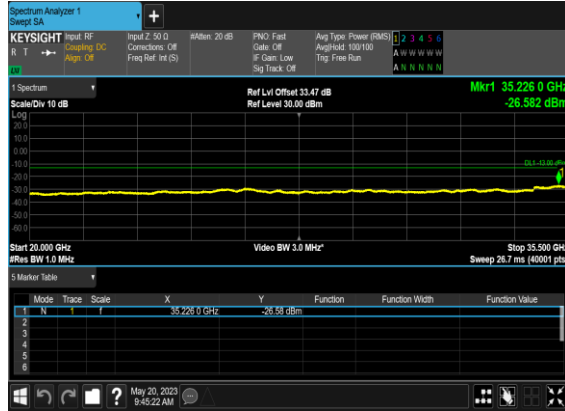

N77(10M)\_DFT-s-OFDM\_QPSK\_Edge\_1RB\_Left\_High\_CH

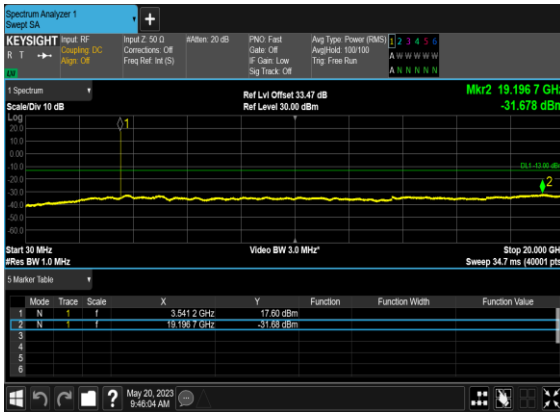

N77(10M)\_DFT-s-OFDM\_QPSK\_Edge\_1RB\_Left\_High\_CH

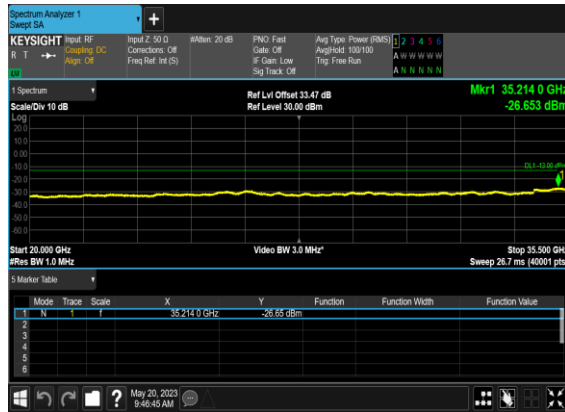

### N77(50M)\_DFT-s-OFDM\_BPSK\_Edge\_1RB\_Left\_Low\_CH

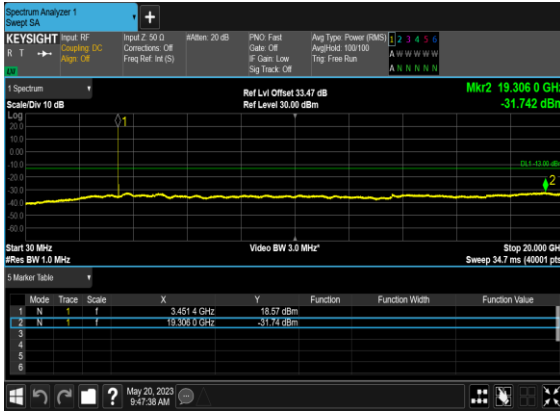

### N77(50M)\_DFT-s-OFDM\_BPSK\_Edge\_1RB\_Left\_Low\_CH

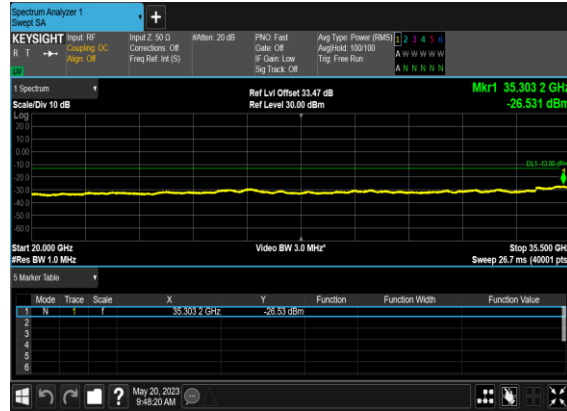

### N77(50M)\_DFT-s-OFDM\_QPSK\_Edge\_1RB\_Left\_Low\_CH

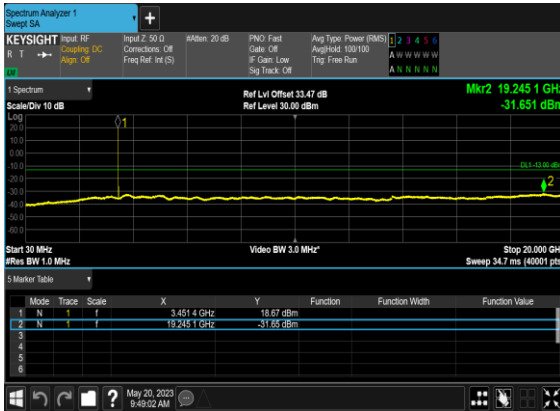

### N77(50M)\_DFT-s-OFDM\_QPSK\_Edge\_1RB\_Left\_Low\_CH

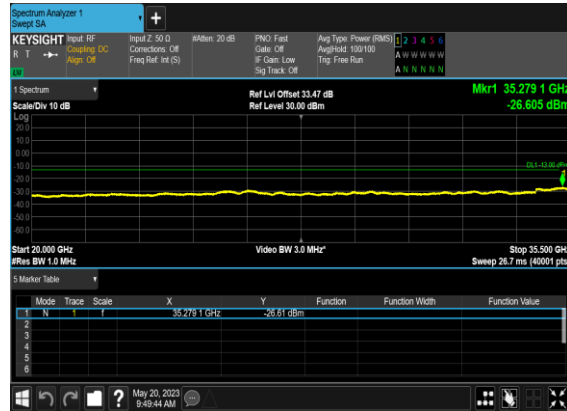

### N77(50M)\_DFT-s-OFDM\_BPSK\_Edge\_1RB\_Left\_Mid\_CH

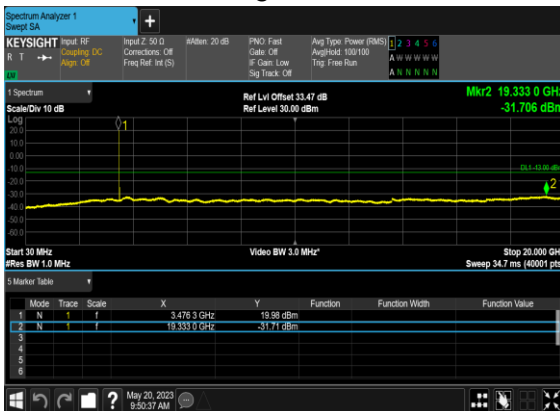

### N77(50M)\_DFT-s-OFDM\_BPSK\_Edge\_1RB\_Left\_Mid\_CH

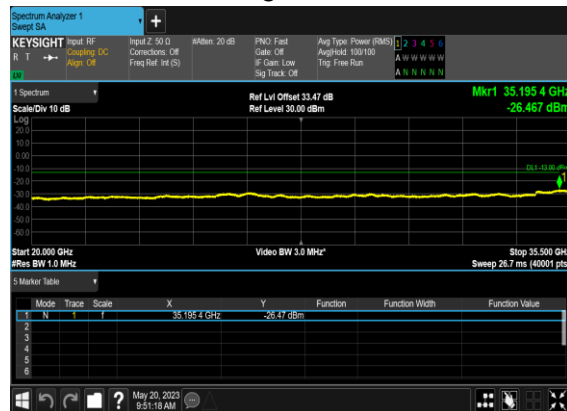

### N77(50M)\_DFT-s-OFDM\_QPSK\_Edge\_1RB\_Left\_Mid\_CH

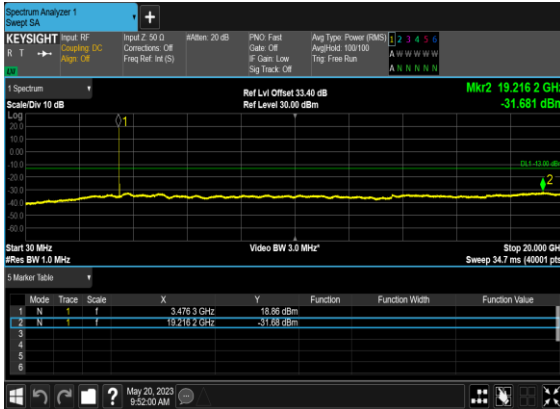

### N77(50M)\_DFT-s-OFDM\_QPSK\_Edge\_1RB\_Left\_Mid\_CH

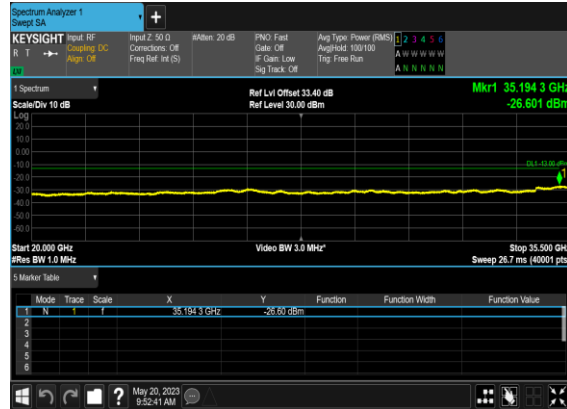

### N77(50M)\_DFT-s-OFDM\_BPSK\_Edge\_1RB\_Left\_High\_CH

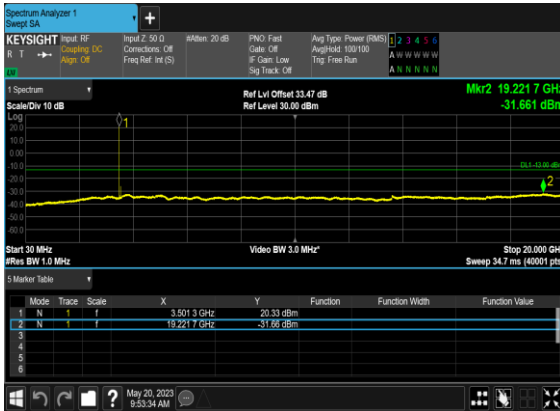

### N77(50M)\_DFT-s-OFDM\_BPSK\_Edge\_1RB\_Left\_High\_CH

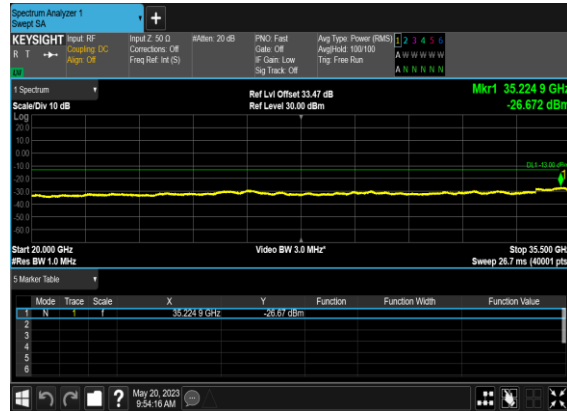

### N77(50M)\_DFT-s-OFDM\_QPSK\_Edge\_1RB\_Left\_High\_CH

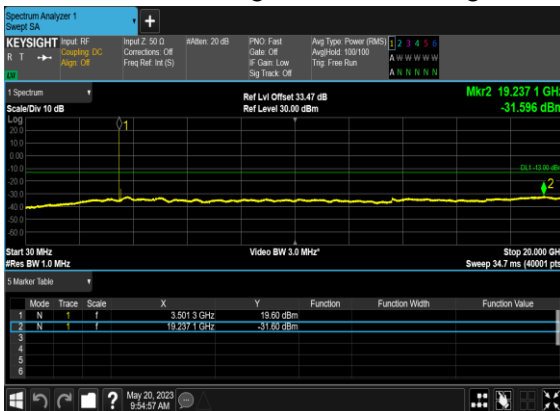

### N77(50M)\_DFT-s-OFDM\_QPSK\_Edge\_1RB\_Left\_High\_CH

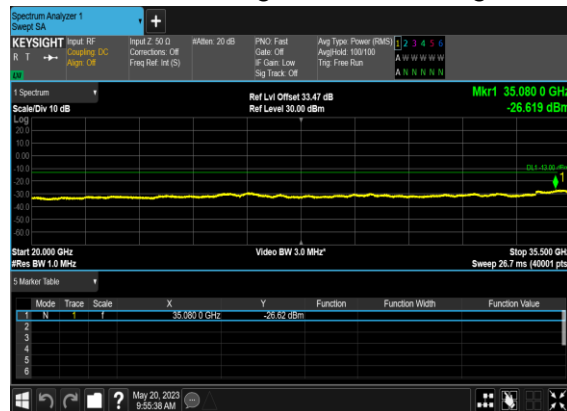



N77(100M)\_DFT-s-OFDM\_BPSK\_Edge\_1RB\_Left\_Mid\_CH

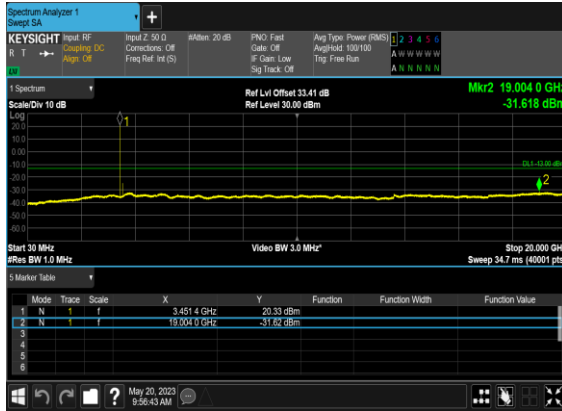

N77(100M)\_DFT-s-OFDM\_BPSK\_Edge\_1RB\_Left\_Mid\_CH

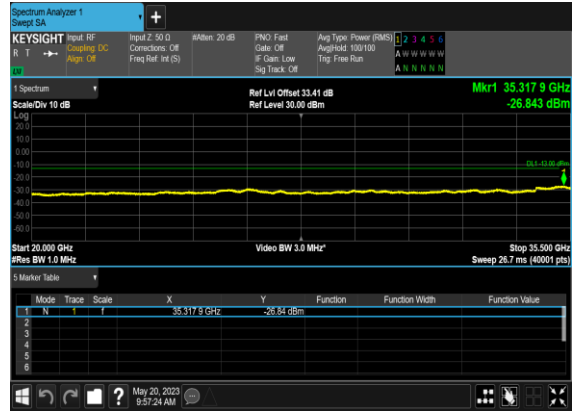

N77(100M)\_DFT-s-OFDM\_QPSK\_Edge\_1RB\_Left\_Mid\_CH

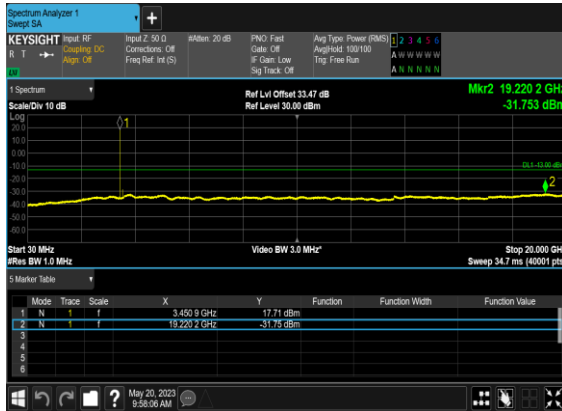

N77(100M)\_DFT-s-OFDM\_QPSK\_Edge\_1RB\_Left\_Mid\_CH

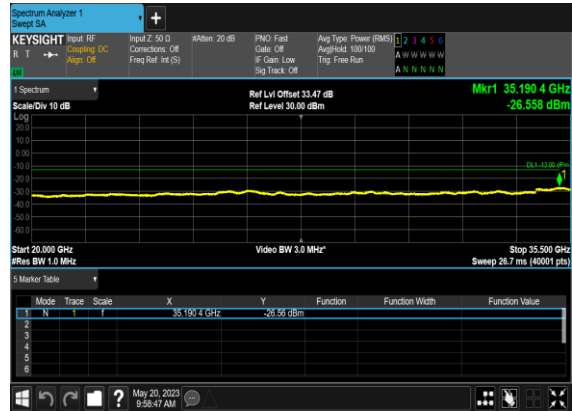

### Conducted Band Edge

NR Band	SCS (kHz)	Bandwidth (MHz)	Arfcn	Freq (MHz)	Modulation	RB	Result	Verdict
77	30	10	630334	3455.01	DFT-s-OFDM BPSK	1@0	see graph	PASS
77	30	10	630334	3455.01	DFT-s-OFDM QPSK	1@0	see graph	PASS
77	30	10	630334	3455.01	DFT-s-OFDM BPSK	24@0	see graph	PASS
77	30	10	630334	3455.01	DFT-s-OFDM QPSK	24@0	see graph	PASS
77	30	10	636332	3544.98	DFT-s-OFDM BPSK	1@23	see graph	PASS
77	30	10	636332	3544.98	DFT-s-OFDM QPSK	1@23	see graph	PASS

77	30	10	636332	3544.98	DFT-s-OFDM BPSK	24@0	see graph	PASS
77	30	10	636332	3544.98	DFT-s-OFDM QPSK	24@0	see graph	PASS
77	30	50	631668	3475.02	DFT-s-OFDM BPSK	1@0	see graph	PASS
77	30	50	631668	3475.02	DFT-s-OFDM QPSK	1@0	see graph	PASS
77	30	50	631668	3475.02	DFT-s-OFDM BPSK	128@0	see graph	PASS
77	30	50	631668	3475.02	DFT-s-OFDM QPSK	128@0	see graph	PASS
77	30	50	635000	3525.0	DFT-s-OFDM BPSK	1@132	see graph	PASS
77	30	50	635000	3525.0	DFT-s-OFDM QPSK	1@132	see graph	PASS
77	30	50	635000	3525.0	DFT-s-OFDM BPSK	128@0	see graph	PASS
77	30	50	635000	3525.0	DFT-s-OFDM QPSK	128@0	see graph	PASS
77	30	100	633334	3500.01	DFT-s-OFDM BPSK	1@0	see graph	PASS
77	30	100	633334	3500.01	DFT-s-OFDM QPSK	1@0	see graph	PASS
77	30	100	633334	3500.01	DFT-s-OFDM BPSK	1@272	see graph	PASS
77	30	100	633334	3500.01	DFT-s-OFDM QPSK	1@272	see graph	PASS
77	30	100	633334	3500.01	DFT-s-OFDM BPSK	270@0	see graph	PASS
77	30	100	633334	3500.01	DFT-s-OFDM QPSK	270@0	see graph	PASS

### N77(10M)\_DFT-s-OFDM\_BPSK\_Edge\_1RB\_Left\_Low\_CH



### N77(10M)\_DFT-s-OFDM\_QPSK\_Edge\_1RB\_Left\_Low\_CH

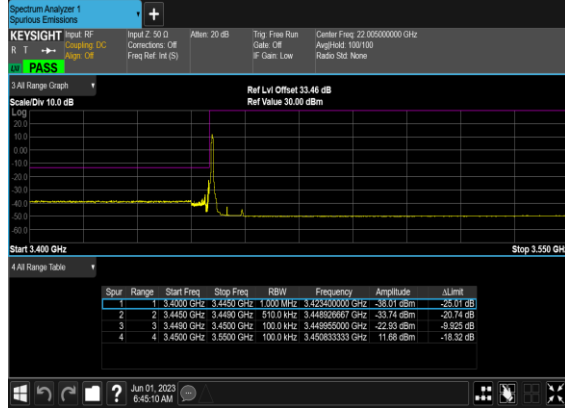

### N77(10M)\_DFT-s-OFDM\_BPSK\_Outer\_Full\_Low\_CH



### N77(10M)\_DFT-s-OFDM\_QPSK\_Outer\_Full\_Low\_CH

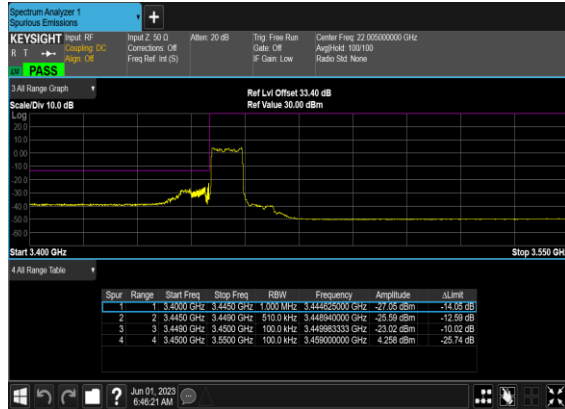

### N77(10M)\_DFT-s-OFDM\_BPSK\_Edge\_1RB\_Right\_High\_CH

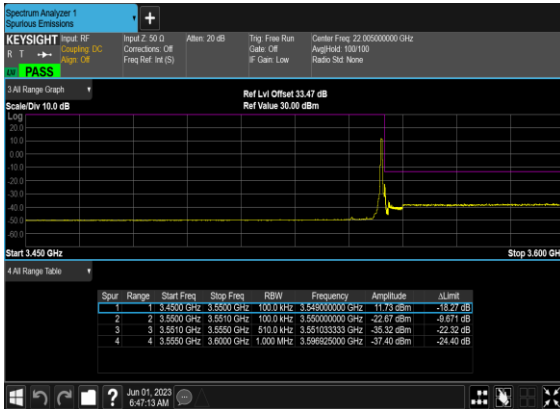

### N77(10M)\_DFT-s-OFDM\_QPSK\_Edge\_1RB\_Right\_High\_CH

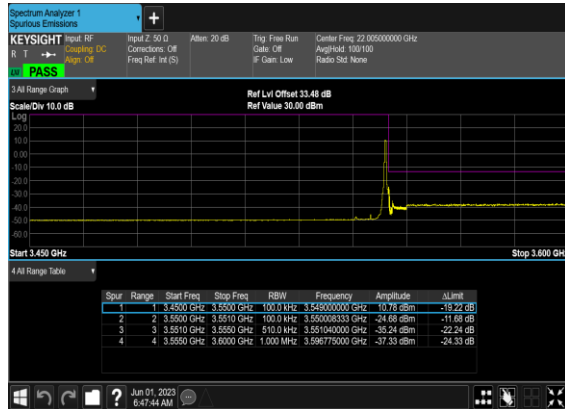

### N77(10M)\_DFT-s-OFDM\_BPSK\_Outer\_Full\_High\_CH

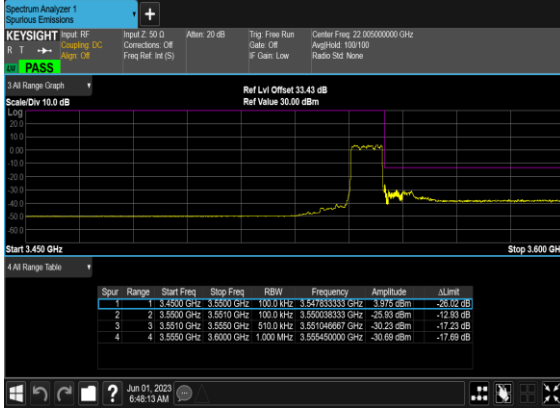

### N77(10M)\_DFT-s-OFDM\_QPSK\_Outer\_Full\_High\_CH

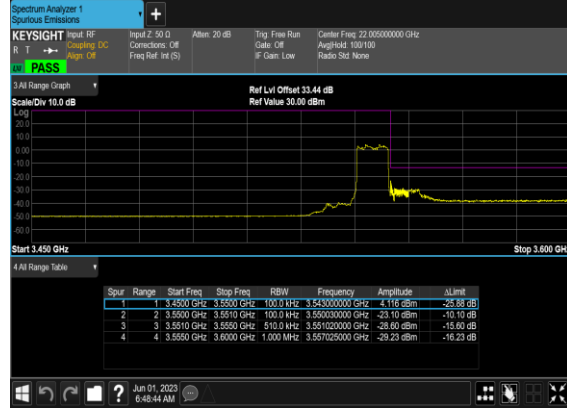

### N77(50M)\_DFT-s-OFDM\_BPSK\_Edge\_1RB\_Left\_Low\_CH

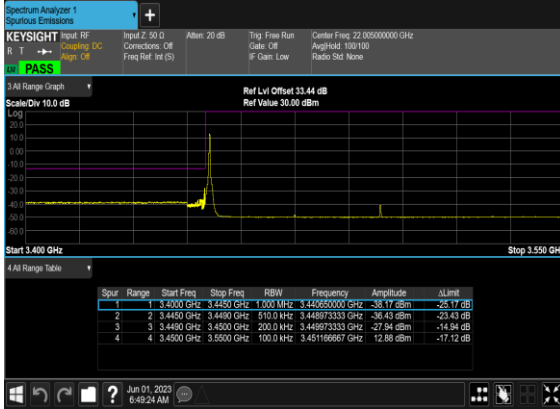

### N77(50M)\_DFT-s-OFDM\_QPSK\_Edge\_1RB\_Left\_Low\_CH

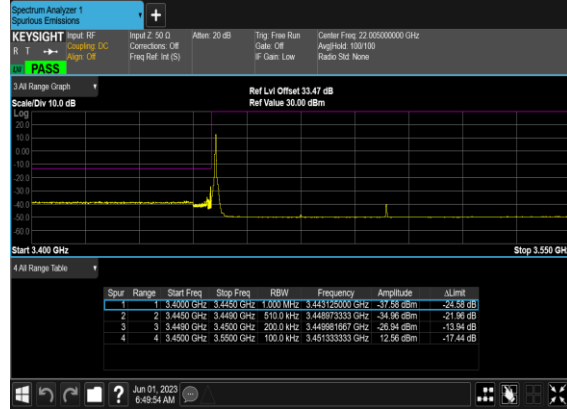

### N77(50M)\_DFT-s-OFDM\_BPSK\_Outer\_Full\_Low\_CH

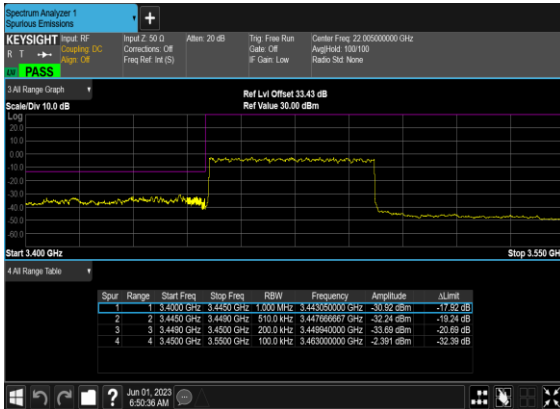

### N77(50M)\_DFT-s-OFDM\_QPSK\_Outer\_Full\_Low\_CH

