

FCC TAS validation – Part 2: Tests under dynamic transmit power scenarios

FCC ID : IHDT56AL5
Equipment : Mobile Cellular Phone
Brand Name : Motorola
Model Name : XT2305-1
Applicant : Motorola Mobility LLC
222 W,Merchandise Mart Plaza,
Chicago IL 60654 USA
Manufacturer : Motorola Mobility LLC
222 W,Merchandise Mart Plaza,
Chicago IL 60654 USA
Standard : FCC 47 CFR Part 2 (2.1093)

The product was received on Mar. 15, 2023 and testing was started from Apr. 17, 2023 and completed on Apr. 21, 2023. We, SPORTON INTERNATIONAL INC., would like to declare that the tested sample provide by manufacturer and the test data has been evaluated in accordance with the test procedures given in 47 CFR Part 2.1093 and FCC KDB and has been pass the FCC requirement.

The test results in this report apply exclusively to the tested model / sample. Without written approval of SPORTON INTERNATIONAL INC. Laboratory, the test report shall not be reproduced except in full.



Approved by: Cona Huang / Deputy Manager



Sporton International Inc. EMC & Wireless Communications Laboratory

No.52, Huaya 1st Rd., Guishan Dist., Taoyuan City 333, Taiwan



Table of Contents

1. Overview 4
2. Operating Parameters for Algorithm Validation 5
3. Overview of TA-SAR Test Proposal 6
4. TA-SAR Test Scenarios and Test Procedures 7
4.1 Test Sequences for All Scenarios 8
4.2 Test Configuration and Procedure for Scenario 1: Range of TA-SAR Parameters via Conducted Power Measurements 12
4.2.1 Configuration 12
4.2.2 Procedure 12
4.3 Test Configuration and Procedure for Scenario 1: Range of TA-SAR Parameters via Conducted Power Measurements 14
4.3.1 Configuration 14
4.3.2 Procedure 15
4.4 Test Configuration and Procedure for Scenario 3: Call Disconnection and Re-establishment via Conducted Power Measurements 17
4.4.1 Configuration 17
4.4.2 Procedure 17
4.5 Test Configuration and Procedure for Scenario 1: Range of TA-SAR Parameters via Conducted Power Measurements 19
4.5.1 Configuration 19
4.5.2 Procedure 19
4.6 Test Configuration and Procedure for Scenario 5: Exposure Condition Index (ECI) Change via Conducted Power Measurements 21
4.6.1 Configuration 21
4.6.2 Procedure 21
4.7 Test Configuration and Procedure for Scenario 6: Antenna Switching via Conducted Power Measurements 22
4.7.1 Configuration 22
4.7.2 Procedure 22
4.8 Test Configuration and Procedure for Scenario 7: Time Window Switching via Conducted Power Measurements 23
4.8.1 Configuration 23
4.8.2 Procedure 23
4.9 Test Configuration and Procedure for Scenario 8: SAR Exposure Switching via Conducted Power Measurements 26
4.9.1 Configuration 26
4.9.2 Procedure 27
4.10 Test Configuration and Procedure for Scenario 2: Time-Varying TX Power via SAR Measurements 29
4.10.1 Configuration 29
4.10.2 Procedure 29
5. TA-SAR Validation via Conducted Power Measurements 31
5.1 Measurement Setup 31
5.1.1 Test Bench Introduction 31
5.1.2 Sub6 NR/LTE/3G/2G Power Limit Table and Test Configurations 34
5.2 Conducted Power Measurement Results for Scenario1: Range of TA-SAR Parameters 40
5.3 Conducted Power Measurement Results for Scenario 2: Time-Varying TX Power 42
5.3.1 Measurement results for 2G 42
5.3.2 Measurement results for WCDMA 47
5.3.3 Measurement results for LTE 52
5.3.4 Measurement results for NR 57
5.4 Conducted Power Measurement Results for Scenario 3: Call Disconnection and Re-establishment 62
5.5 Conducted Power Measurement Results for Scenario Band Handover 64
5.6 Conducted Power Measurement Results for Scenario 5: ECI Change 66
5.7 Conducted Power Measurement Results for Scenario 7: Time Window Switching 68
5.7.1 Measurement results for Time window switching 60s-100s-60 68
5.7.2 Measurement results for Time window switching 100s-60s-100s 70
5.8 Conducted Power Measurement Results for Scenario 8: SAR Exposure Switching (EN-DC) 72
5.9 Conducted Power Measurement Results for Scenario 8: SAR Exposure Switching (UL CA) 74
6. TA-SAR Validation via SAR Measurements 76
6.1 Measurement Setup 76
6.2 SAR Measurement Results for Scenario 2: Time-Varying TX Power 77
6.2.1 SAR Measurement results for 2G 78
6.2.2 SAR Measurement results for 3G WCDMA 82
6.2.3 SAR Measurement results for LTE 86
6.2.4 SAR Measurement results for NR 90
7. Conclusions 94
8. cDASY6 System Verification 95
8.1 The system to be used for the near field power density measurement 95
8.2 Test Side Location 95
8.3 SAR E-Field Probe 96
8.4 Data Acquisition Electronics (DAE) 96
9. Test Equipment List 97
10. System verification and validation 98
10.1 Tissue Verification 98
10.2 System Verification 98
11. Uncertainty Assessment 99



1. Overview

FCC regulation allows time averaged RF power to demonstrate compliance to RF exposure safety limits. Because RF exposure is correlated to transmission power (TX power), e.g., lower RF exposure is correlated to lower TX power, the TX power can be controlled to meet FCC RF exposure limits defined specific absorption rate (SAR) limit for transmit frequencies < 6GHz. For SAR limit, the proposed Time-Averaged Specific Absorption Rate (TA-SAR) algorithm manages TX power to ensure that at all times the time-averaged RF exposure is compliant with the FCC SAR requirement. In the FCC regulation, the averaging window of SAR is 100 seconds for transmit frequencies less than 3GHz, 60 seconds for transmit frequencies between 3GHz and 6GHz.

This document describes the test plan, test procedures, measurement setup, and measurement results for the verification of the proposed TA-SAR algorithm being able to make RF exposure meet FCC requirement. The operating parameters for algorithm validation are described in Chapter 2. The overview of test proposal is given in Chapter 3. The test procedures for conducted power measurements and SAR measurements are described in Chapter 4. For TA-SAR validation, the measurement setup and results for conducted power are included in Chapter 5, while the measurement setup and results for SAR are included in Chapter 6. It is concluded in Chapter 7 that the proposed TA-SAR algorithm can apply dynamic power control to ensure FCC compliance in real-time.

2. Operating Parameters for Algorithm Validation

Mediatek developed the TA-SAR algorithm to control instantaneous TX power for transmit frequencies less and larger than 6GHz respectively, so that the total time-averaged RF exposures are less than FCC requirement.

TA-SAR algorithm validation has been performed for 2G, 3G, LTE, NR FR1 according to cases with different combinations of operating parameters listed in Table 2-1.

Table 2-1 TA-SAR operating parameters

Operating parameters	Description
P_{sub6_limit}	The time-averaged maximum power level limit for different bands for 2G, 3G, LTE, and NR FR1.
$P_{LowThresh_offset}$	To calculate $P_{LowThresh}$. ($P_{LowThresh} = P_{sub6_limit} - P_{LowThresh_offset}$)
$P_{UE_backoff_offset}$	To calculate $P_{UE_backoff}$. ($P_{UE_backoff} = P_{sub6_limit} - P_{UE_backoff_offset}$)
$P_{UE_max_cust_offset}$	To calculate $P_{UE_max_cust}$. P_{UE_max} is maximum TX power at which a UE can possibly transmit. $P_{UE_max_cust} = \min(P_{UE_max}, P_{sub6_limit} + P_{UE_max_cust_offset})$

3. Overview of TA-SAR Test Proposal

For the completeness of verifying that the proposed TA-SAR algorithm can realize FCC compliance regarding RF exposure, several test scenarios are constructed as below:

- **Scenario 1:** test under different TA-SAR parameters to verify that the TA-SAR algorithm meets compliance requirements with different combinations of operating parameters.
- **Scenario 2:** test under time-varying TX power to verify that the TA-SAR algorithm ensures SAR compliance through dynamic TX power.
- **Scenario 3:** test under call drop and re-establishment conditions to ensure the TA-SAR algorithm control continuity and SAR compliance.
- **Scenario 4:** test under RAT/band handover to ensure the TA-SAR algorithm control continuity and correctness.
- **Scenario 5:** test under different ECIs (Exposure Condition Index) to ensure the TA-SAR algorithm control behaves as expected during ECI switching from one ECI to another. (e.g., head→ body worn)
- **Scenario 6:** test under different transmission antennae to ensure the TA-SAR algorithm control works correctly during antenna switching from one antenna to another.
- **Scenario 7:** test under different time windows to ensure the TA-SAR algorithm control functions correctly during time window switching from one time window setting to another. (e.g., time window 100s→60s)
- **Scenario 8:** test under SAR exposure switching between two active radios (radio#1 only, radio#1+radio#2, and radio#2 only) to ensure the TA-SAR algorithm control continuity and SAR compliance.



4. TA-SAR Test Scenarios and Test Procedures

In order to demonstrate that TA-SAR algorithm performs as expected under various operating scenarios, Table 4-1 lists the test scenarios and expected test sequences to validate TA-SAR algorithm in these scenarios. The test sequences 0, 1, 2 are defined in section 4.1. The details of each test procedures via conducted power and SAR measurements are described in section 4.2~4.9 and section 4.10, respectively.

Table 4-1 Test scenario list of TA-SAR validation

Test scenario		Test sequences #	Description
1	Range of TA-SAR parameters	0	Adjust parameters
2	Time-varying TX power	1 and 2	Test under time-varying TX power
3	Call disconnection and re-establishment	0	Test call drop and re-establishment
4	Band handover	0	Test band change
5	ECI (Exposure Condition Index) change	0	Test under ECI transition (e.g., head→ body worn)
6	Antenna switching	0	Change antenna (cover by Band handover)
7	Time window switching	0	Switch frequency bands with larger frequency separation (e.g., time window 100s→60s)
8	SAR exposure switching	0	Switch RATs when testing (e.g., LTE→NR)

4.1 Test Sequences for All Scenarios

Three test sequences having possibly time-varying TX power are predefined for TA-SAR validation:

- **Test sequence 0:** EUT's TX power is requested to be maximum.
- **Test sequence 1:** EUT's TX power is requested to be at power less than $P_{LowThresh}$ for 300s, then at maximum power for 200s, and finally at $P_{LowThresh} - 2\text{dB}$ for the remaining time.
- **Test sequence 2:** EUT's TX power to vary with time. This sequence is generated relative to measured P_{UE_max} , measured P_{sub6_limit} and calculated $P_{UE_backoff}$ (= measured P_{sub6_limit} in dBm - $P_{UE_backoff_offset}$ in dB) of EUT based on measured P_{sub6_limit} .
- Test sequence is generated based on below parameters of the EUT:
 - A. Measured maximum power (P_{UE_max})
 - B. Measured Tx_power_at_SAR_design_limit (P_{sub6_limit})
 - C. Threshold of dynamic power reduction status determination: reserve hysteresis margin for instantaneous power ($P_{LowThresh}$)
 - D. SAR_time_window (FCC: 100s for $f < 3\text{GHz}$, 60s for $3\text{GHz} < f < 6\text{GHz}$)

The test sequence 0, 1, and 2 are illustrated in Figure 4-1, Figure 4-2, and Figure 4-3, respectively. The waveforms of the three test sequences are listed in Table 4-2, Table 4-3, and Table 4-4.

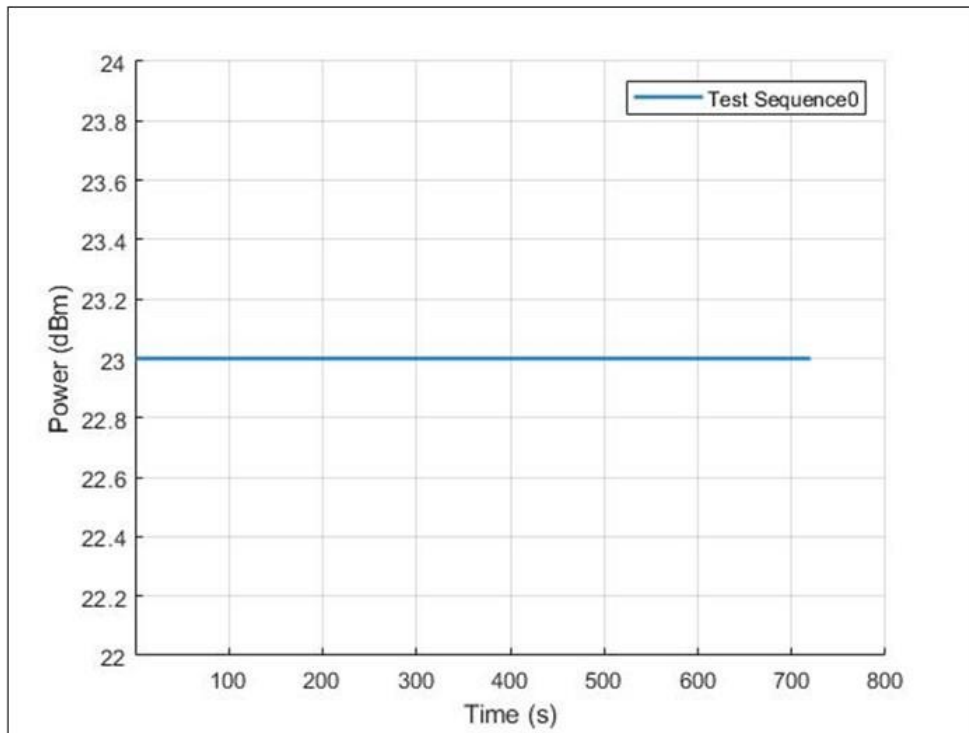

Figure 4-1 Test sequence 0

Table 4-2 Test sequence 0

Time	Duration	Power (dBm)	Note
720	720	23	P_{UE_max}

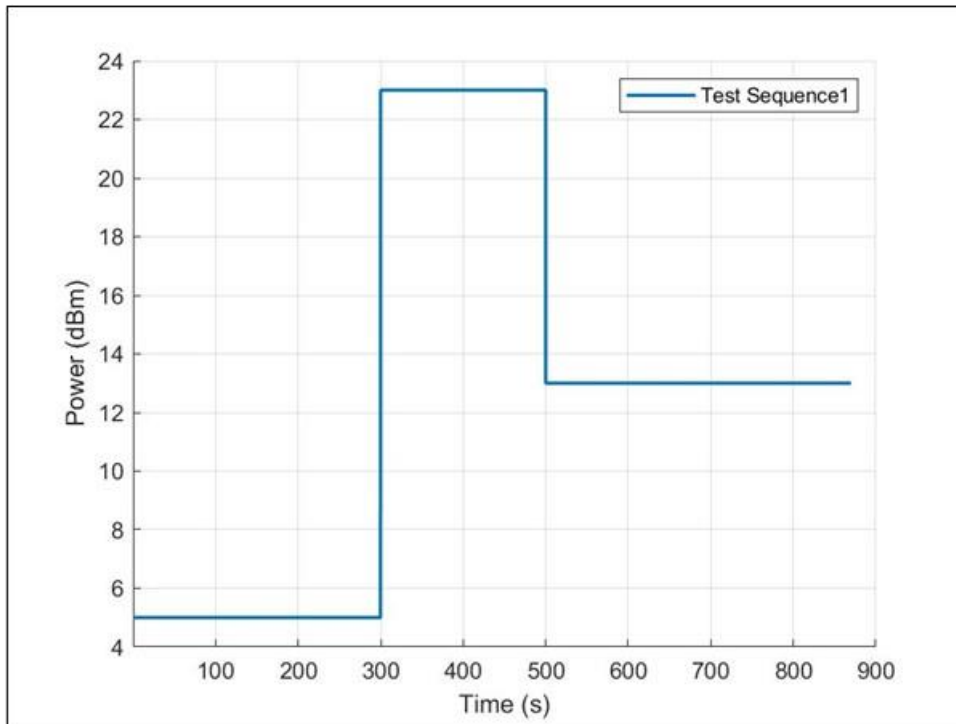

Figure 4-2 Test sequence 1

Table 4-3 Test sequence 1

Time	Duration	Power (dBm)	Note
300	300	5	$< P_{LowThresh}$
500	200	23	P_{UE_max}
870	370	13	$P_{LowThresh} - 2dB$

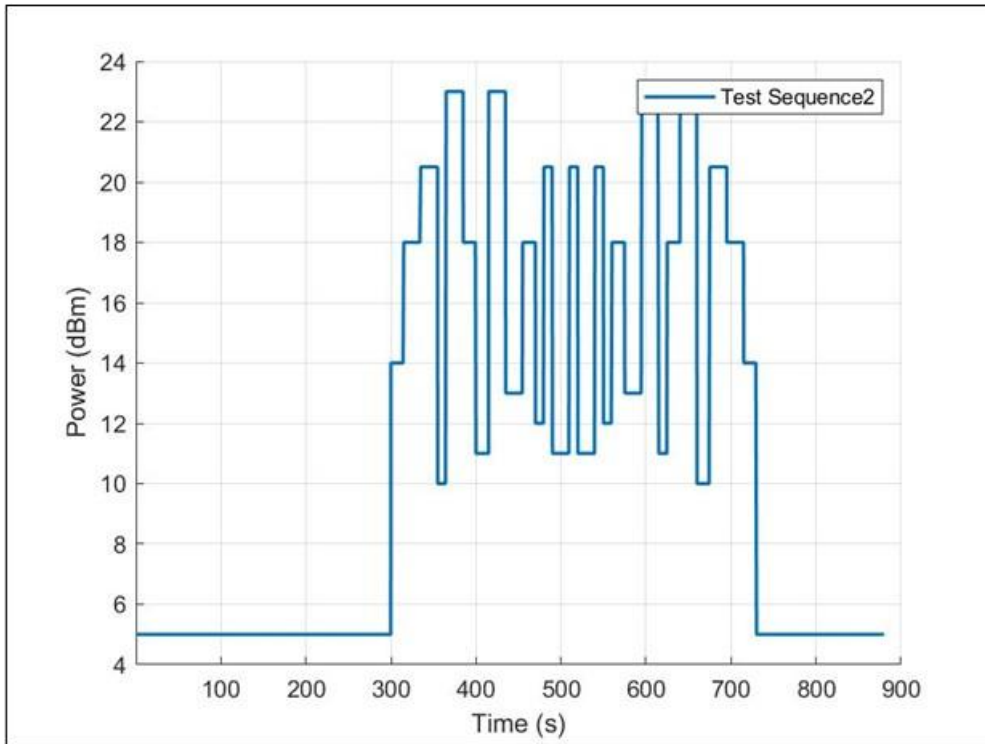

Figure 4-3 Test sequence 2

Table 4-4 Test sequence 2

Time	Duration	Power (dBm)	Note
300	300	5	$< P_{LowThresh}$
315	15	14	$P_{sub6_limit} - 4dB$
335	20	18	P_{sub6_limit}
355	20	20.5	$(P_{sub6_limit} + P_{UE_max})/2$
365	10	10	$P_{sub6_limit} - 8dB$
385	20	23	P_{UE_max}
400	15	18	P_{sub6_limit}
415	15	11	$P_{sub6_limit} - 7dB$
435	20	23	P_{UE_max}
455	20	13	$P_{sub6_limit} - 5dB$
470	15	18	P_{sub6_limit}
480	10	12	$P_{sub6_limit} - 6dB$
490	10	20.5	$(P_{sub6_limit} + P_{UE_max})/2$
510	20	11	$P_{sub6_limit} - 7dB$
520	10	20.5	$(P_{sub6_limit} + P_{UE_max})/2$
540	20	11	$P_{sub6_limit} - 7dB$
550	10	20.5	$(P_{sub6_limit} + P_{UE_max})/2$
560	10	12	$P_{sub6_limit} - 6dB$
575	15	18	P_{sub6_limit}
595	20	13	$P_{sub6_limit} - 5dB$
615	20	23	P_{UE_max}
625	10	11	$P_{sub6_limit} - 7dB$
640	15	18	P_{sub6_limit}
660	20	23	P_{UE_max}

675	15	10	$P_{sub6_limit} - 8dB$
695	20	20.5	$(P_{sub6_limit} + P_{UE_max})/2$
715	20	18	P_{sub6_limit}
730	15	14	$P_{sub6_limit} - 4dB$
870	140	5	$< P_{LowThresh}$

4.2 Test Configuration and Procedure for Scenario 1: Range of TA-SAR Parameters via Conducted Power Measurements

4.2.1 Configuration

This test is performed by changing the parameters ($P_{LowThresh_offset}$, $P_{UE_backoff_offset}$, $P_{UE_max_cust_offset}$) for the selected RAT (Radio Access Technologies) and band. Since Mediatek’s TA algorithm operation is independent of RATs/bands/channels, any one RAT can be selected for this test and the selected band of the RAT has the least P_{sub6_limit} . In principle, two sets of the parameters are determined for this test (if applicable). If the parameters of the EUT are fixed (without a support of dynamic change), only the set of the default parameters needs to be tested.

4.2.2 Procedure

TX power is measured, recorded, and processed by the following steps:

- Step 1~4: measure and record TX power versus time for test scenario 1

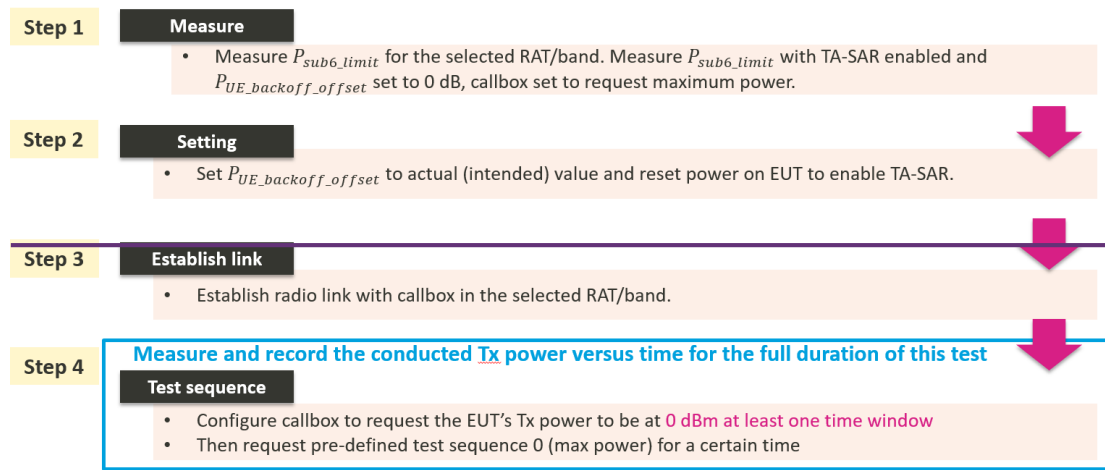

- Step 5: convert the measured conducted TX power into SAR

Convert the measured conducted TX power from step 4 into 1gSAR or 10gSAR value using the following equation.

Perform the running time average to power and 1gSAR or 10g SAR to determine time-averaged value versus time as follows,

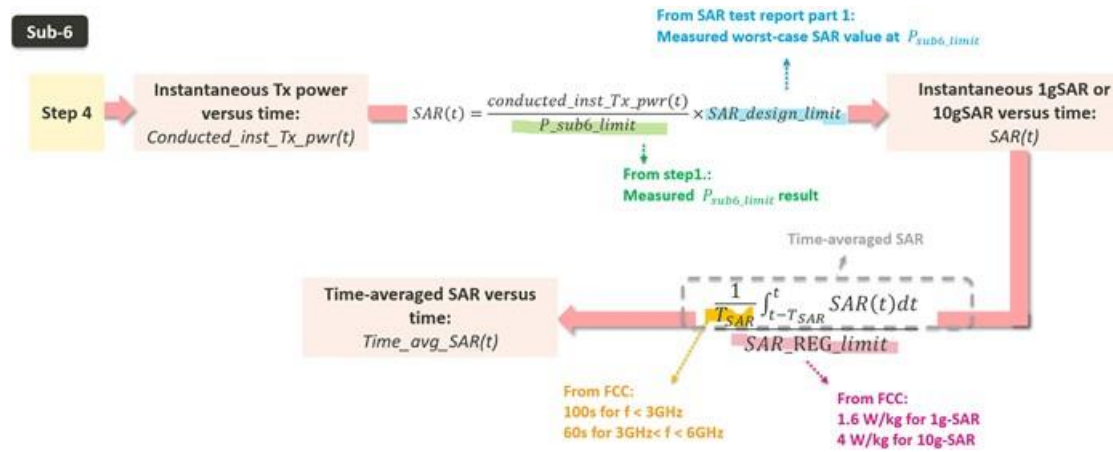

- Step 6: plot results
 - A. Make one power perspective plot containing
 1. Instantaneous TX power
 2. Requested power
 3. Calculated time-averaged power
 4. Calculated time-averaged power limits
 - B. Make one SAR perspective plot containing
 1. Calculated time-averaged 1gSAR or 10gSAR
 2. FCC limit of 1.6 W/kg (1gSAR) or 4.0 W/kg (10gSAR)

4.3 Test Configuration and Procedure for Scenario 1: Range of TA-SAR Parameters via Conducted Power Measurements

4.3.1 Configuration

Since Mediatek's TA-SAR feature operation is independent of bands and channels for a given RAT, selecting one band per RAT is sufficient to validate this feature. Two bands per RAT are proposed for this test. The criteria for band selection for each RAT is based on the P_{sub6_limit} values (corresponding to SAR_design_limit) and is described as below:

- Select two bands, among the ones whose P_{sub6_limit} values are below P_{UE_max} , which correspond to least and highest P_{sub6_limit} values respectively.
 - Only one band needs to be tested if all the bands have same P_{sub6_limit} .
 - Only one band needs to be tested if only the band has P_{sub6_limit} below P_{UE_max} .
 - If the same least P_{sub6_limit} applies to multiple bands, select the band with the highest measured 1gSAR at P_{sub6_limit} .
 - If P_{sub6_limit} values of all bands are all over P_{UE_max} (i.e., TA-SAR feature is not enabled), there is no need to test this RAT.

4.3.2 Procedure

TX power is measured, recorded, and processed by the following steps:

- Step 1~4: measure and record TX power versus time for test scenario 2

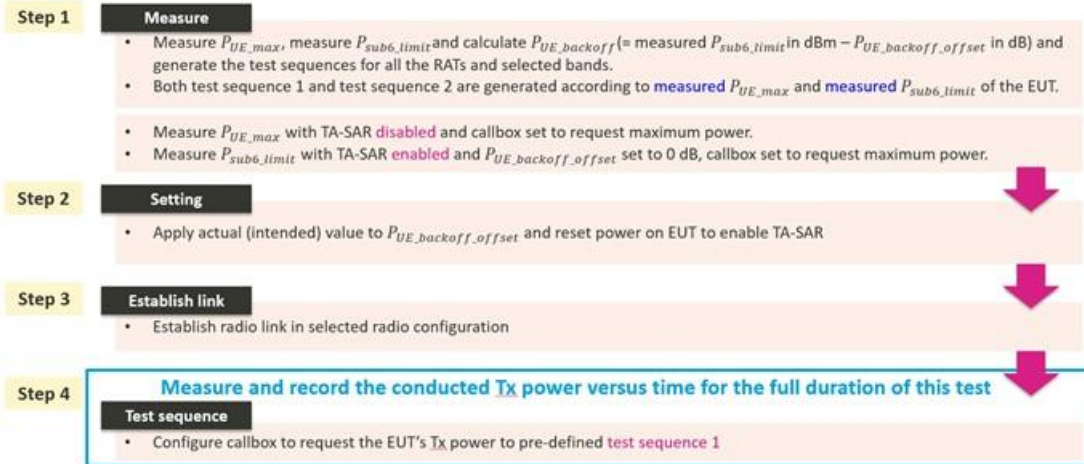

- Step 5: convert the measured conducted TX power into SAR

Convert the measured conducted TX power from step 4 into 1gSAR or 10gSAR value using the following equation.

Perform the running time average to power and 1gSAR or 10g SAR to determine time-averaged value versus time as below:

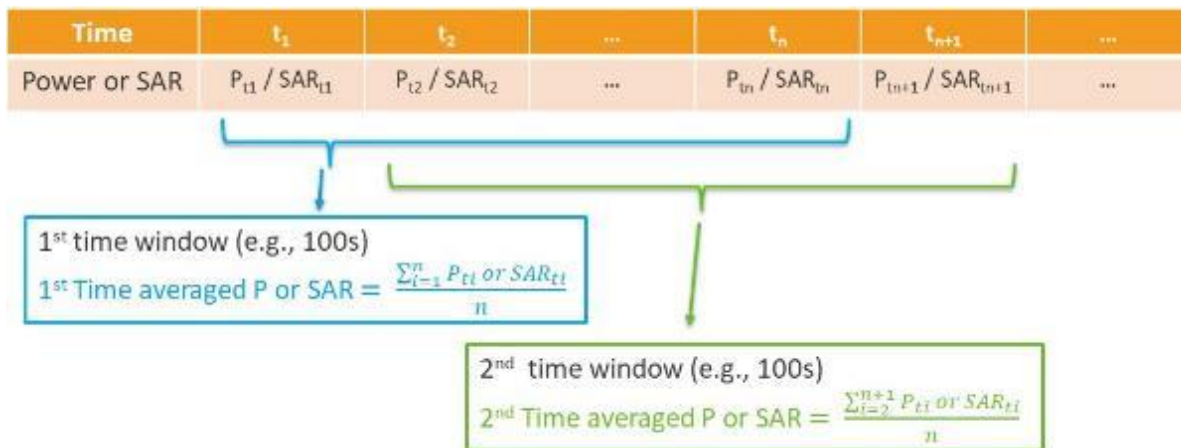

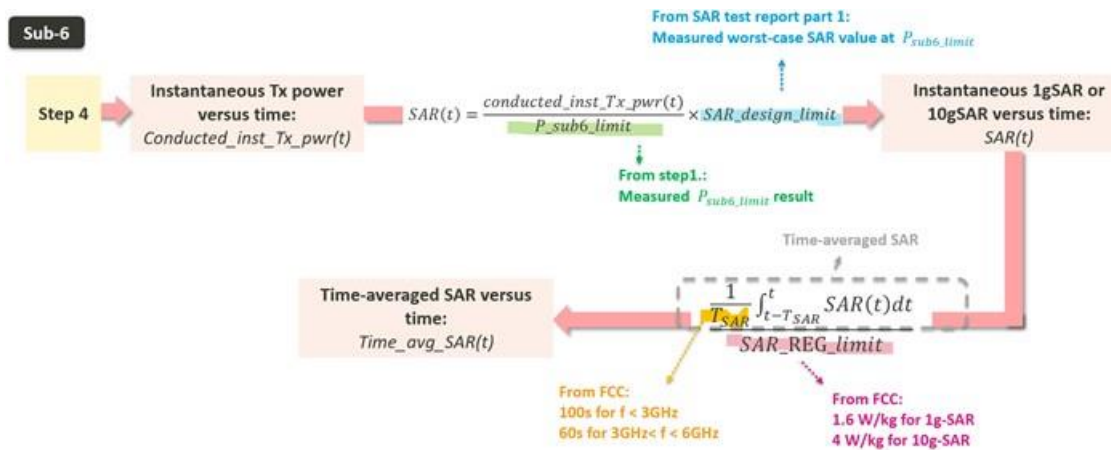

- Step 6: plot results
 - A. Make one power perspective plot containing
 1. Instantaneous TX power
 2. Requested power (test sequence1)
 3. Calculated time-averaged power
 4. Calculated time-averaged power limits
 - B. Make one SAR perspective plot containing
 1. Calculated time-averaged 1gSAR or 10gSAR
 2. FCC limit of 1.6 W/kg (1gSAR) or 4.0 W/kg (10gSAR)

- Step 7: repeat steps 2~6 for test sequence 2

Repeat steps 2 ~ 6 for pre-defined test sequence 2 and replace test sequence 1 in step 4 with test sequence 2.

- Step 8: repeat steps 2~7 for different bands

4.4 Test Configuration and Procedure for Scenario 3: Call Disconnection and Re-establishment via Conducted Power Measurements

4.4.1 Configuration

For call disconnection measurement, the criteria of selecting the test configuration is:

- Select the RAT/band with least P_{sub6_limit} among all supported RATs/bands.
- Select the RAT/band having the highest measured 1gSAR at P_{sub6_limit} if multiple RATs/bands having same least P_{sub6_limit} .
- Select the radio configuration in this RAT/band that corresponds to the highest measured 1gSAR at P_{sub6_limit} .

4.4.2 Procedure

TX power is measured, recorded, and processed by the following steps:

- Step 1~4: measure and record TX power versus time for test scenario 3

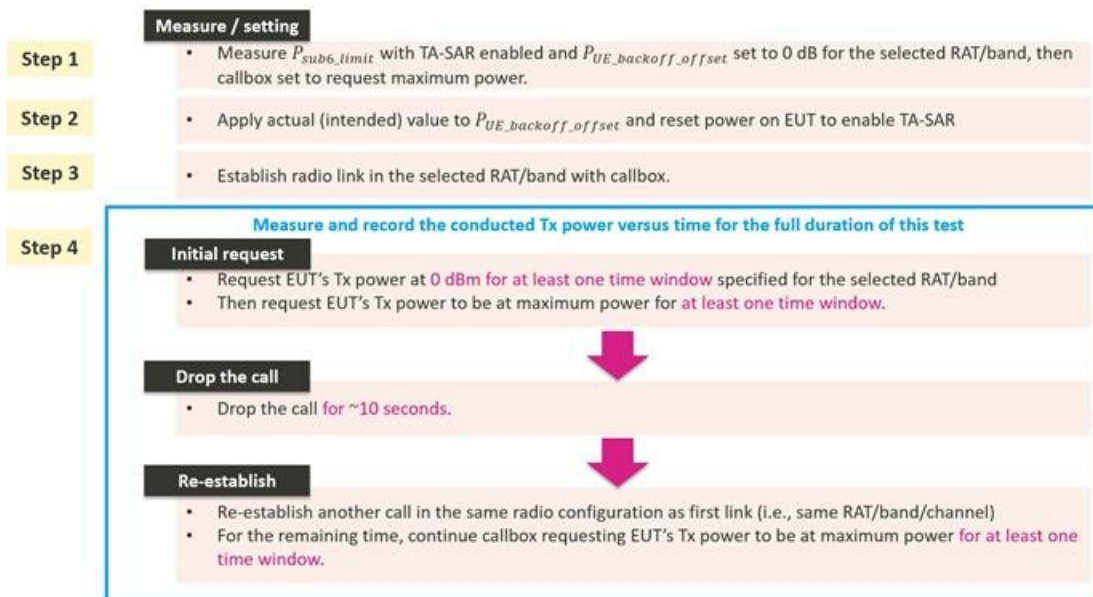

- Step 5: convert the measured conducted TX power into SAR

Convert the measured conducted TX power from step 4 into 1gSAR or 10gSAR value using the following equation.

Perform the running time average to power and 1gSAR or 10g SAR to determine time-averaged value versus time as follows,

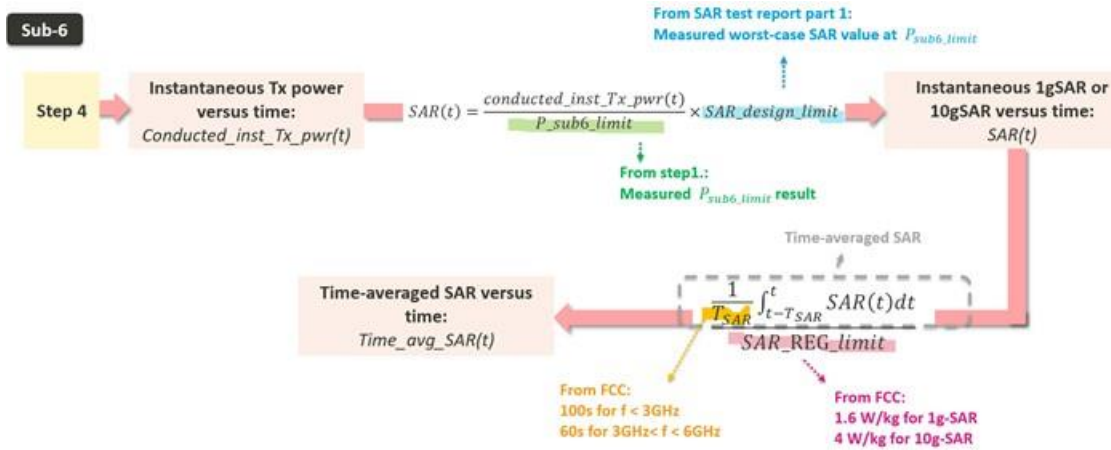

- Step 6: plot results
 - A. Make one power perspective plot containing
 1. Instantaneous TX power
 2. Requested power
 3. Calculated time-averaged power
 4. Calculated time-averaged power limits
 - B. Make one SAR perspective plot containing
 1. Calculated time-averaged 1gSAR or 10gSAR
 2. FCC limit of 1.6 W/kg (1gSAR) or 4.0 W/kg (10gSAR)

4.5 Test Configuration and Procedure for Scenario 1: Range of TA-SAR Parameters via Conducted Power Measurements

4.5.1 Configuration

For a given TX antenna, select a RAT/band with the lowest P_{sub6_limit} and the other RAT/band with the highest P_{sub6_limit} . Both of them have P_{sub6_limit} values less than P_{UE_max} if possible.

- Select the RAT/band having the highest measured 1gSAR at P_{sub6_limit} if multiple RATs/bands have the same lowest P_{sub6_limit} .
- Select the RAT/band having the lowest measured 1gSAR at P_{sub6_limit} if multiple RATs/bands have the same highest P_{sub6_limit} .

4.5.2 Procedure

TX power is measured, recorded, and processed by the following steps:

- Step 1~4: measure and record TX power versus time for test scenario 4

Step 1	Measure / setting <ul style="list-style-type: none"> • Measure P_{sub6_limit} for both the selected RATs and bands. Measure P_{sub6_limit} with TA-SAR enabled and $P_{UE_backoff_offset}$ set to 0 dB, callbox set to request maximum power.
Step 2	<ul style="list-style-type: none"> • Apply actual (intended) value to $P_{UE_backoff_offset}$ and reset power on EUT to enable TA-SAR.
Step 3	<ul style="list-style-type: none"> • Establish radio link in first selected RAT/band with callbox .
Step 4	<div style="border: 2px solid #00aaff; padding: 10px;"> <p style="text-align: center; color: #00aaff;">Measure and record the conducted Tx power versus time for the full duration of this test</p> <p>Initial request</p> <ul style="list-style-type: none"> • Request EUT's Tx power at 0 dBm for at least one time window specified for the selected RAT/band • Then request EUT's Tx power to be at maximum power for at least one time window. <p style="text-align: right; color: #cc0000; font-size: 2em;">↓</p> <p>RAT/Band switch</p> <ul style="list-style-type: none"> • Switch the radio link to second RAT/band selected. • For the remaining time, continue callbox requesting EUT's Tx power to be at maximum power for at least one time window. </div>

- Step 5: convert the measured conducted TX power into SAR

Convert the measured conducted TX power from step 4 into 1gSAR or 10gSAR value using the following equation. Perform the running time average to power and 1gSAR or 10g SAR to determine time-averaged value versus time as follows,

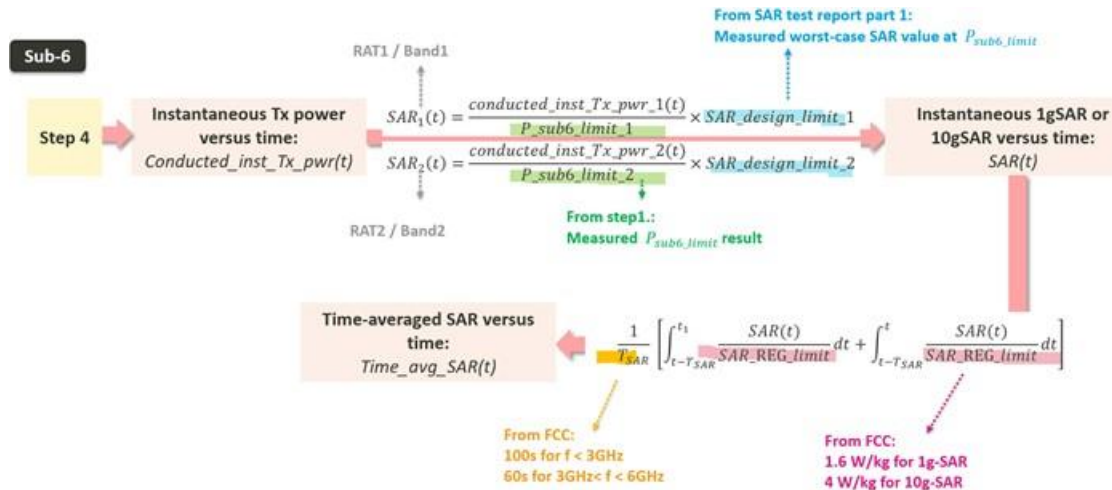

- Step 6: plot results
 - A. Make one power perspective plot containing
 1. Instantaneous TX power
 2. Requested power
 3. Calculated time-averaged power
 4. Calculated time-averaged power limits
 - B. Make one SAR perspective plot containing
 1. Calculated time-averaged 1gSAR or 10gSAR
 2. FCC limit of 1.6 W/kg (1gSAR) or 4.0 W/kg (10gSAR)
 3. Normalized time-averaged 1gSAR/1.6 or 10gSAR/4.0

4.6 Test Configuration and Procedure for Scenario 5: Exposure Condition Index (ECI) Change via Conducted Power Measurements

4.6.1 Configuration

Select any one RAT/band, which has at least two ECIs whose Psub6_limit values are different and are below PUE_max.

4.6.2 Procedure

The test procedure is identical to section 4.5.2 except the following 2 changes:

1. Replace band switch operation with ECI switch.
2. In Step 4, the second ECI switching is arranged after the first one lasts for at least one time window, i.e., switch the second ECI back to the first ECI, and then continue with callbox requesting EUT's Tx power to be at maximum power for at least one time window.

It is noted that the following operations are done as well for this scenario:

- The correct power control is controlled by TA_SAR during ECI switches from one ECI to another.
- The validation criteria are, at all times, the time-averaged 1gSAR or 10gSAR versus time shall not exceed FCC limit of 1.6 W/kg for 1gSAR or 4.0 W/kg for 10gSAR.

4.7 Test Configuration and Procedure for Scenario 6: Antenna Switching via Conducted Power Measurements

4.7.1 Configuration

Among RATs/bands supporting TX antenna switches, select the RAT/band with the highest Psub6_limit difference between a pair of supported TX antennas.

- Select the RAT/band having the highest measured 1gSAR at Psub6_limit if multiple RATs/bands having the same Psub6_limit difference between the supported TX antennas.
- Antenna selection order
 - Select the configuration with two antennas having P_{sub6_limit} values less than P_{UE_max} .
 - If the previous configuration does not exist, select the configuration with one antenna having P_{sub6_limit} value less than P_{UE_max} .
 - If the above two cannot be found, select one configuration with the two antennas having the least difference between their Psub6_limit and PUE_max (i.e., Psub6_limit can be greater than PUE_max).

4.7.2 Procedure

The test procedure is identical to section 4.5.2 except the following 2 changes:

1. Replace band switch operation with antenna switch.
2. In Step 4, the second antenna switching is arranged after the first one lasts for at least one time window, i.e., switch the second antenna back to the first antenna, and then continue with callbox requesting EUT's Tx power to be at maximum power for at least one time window.

It is noted that the following operations are done as well for this scenario:

- The correct power control is controlled by TA_SAR during antenna switches from one antenna to another.
- The validation criteria are, at all times, the time-averaged 1gSAR or 10gSAR versus time shall not exceed FCC limit of 1.6 W/kg for 1gSAR or 4.0 W/kg for 10gSAR.

4.8 Test Configuration and Procedure for Scenario 7: Time Window Switching via Conducted Power Measurements

4.8.1 Configuration

Select one RAT/band with 60-second time averaging window, and the other RAT/band with 100-second time averaging window. Both of them have P_{sub6_limit} values less than P_{UE_max} if possible.

- At least one of the selected RAT/band has its P_{sub6_limit} less than P_{UE_max} .

4.8.2 Procedure

TX power is measured, recorded, and processed by the following steps:

- Step 1~4: measure and record TX power versus time for test scenario 7

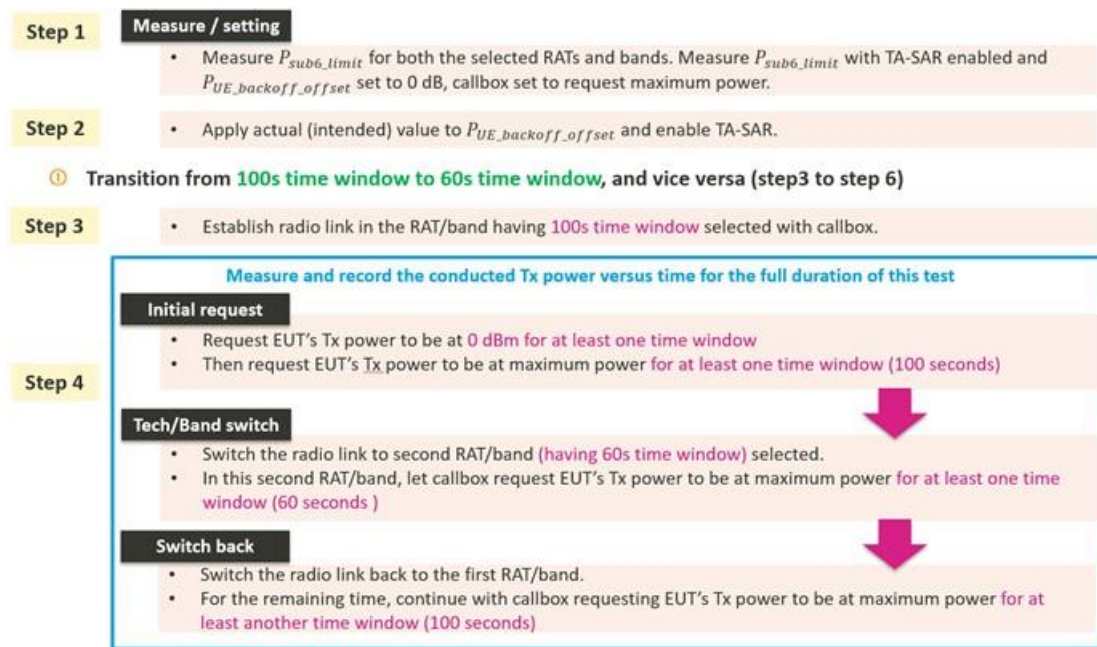

- Step 5: convert the measured conducted TX power into SAR

Convert the measured conducted TX power from step 4 into 1gSAR or 10gSAR value using the following equation.

Perform the running time average to power and 1gSAR or 10g SAR to determine time-averaged value versus time as follows,

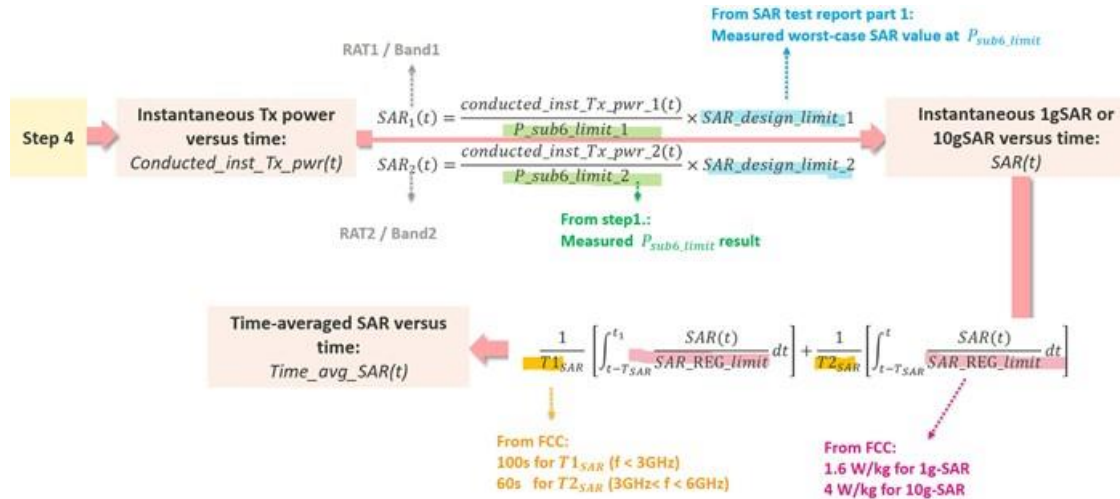

- Step 6: plot results
 - Make one power perspective plot containing
 - Instantaneous TX power
 - Requested power
 - Calculated time-averaged power
 - Calculated time-averaged power limits
 - Make one SAR perspective plot containing
 - Calculated time-averaged 1gSAR or 10gSAR
 - FCC limit of 1.6 W/kg (1gSAR) or 4.0 W/kg (10gSAR)
 - Normalized time-averaged 1gSAR/1.6 or 10gSAR/4.0

- Step 7~8: measure and record TX power versus time in another time window change

🕒 **Transition from 60s time window to 100s time window, and vice versa (step7 to step 9)**

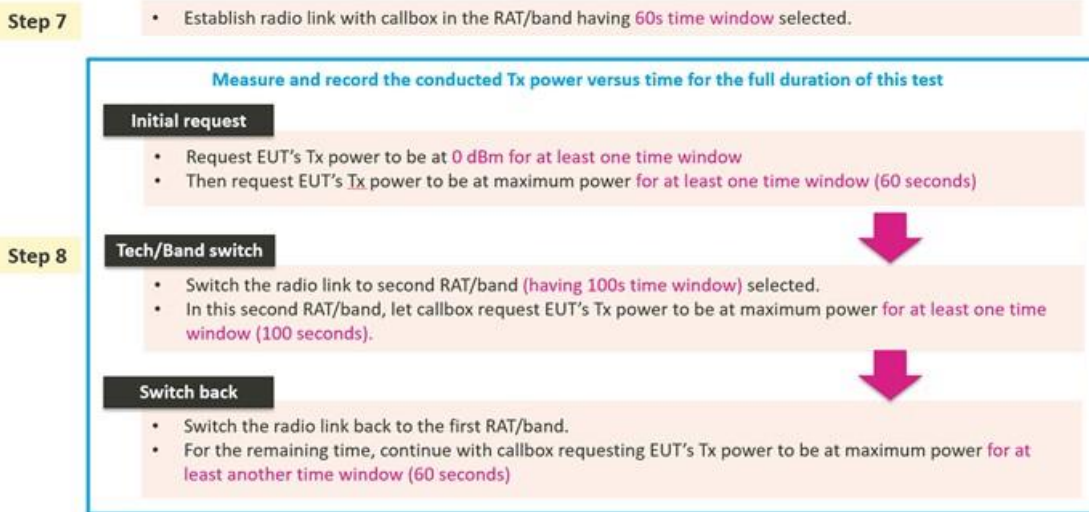

- Step 9: convert the measurement and plot results

Convert the measured conducted TX power from step 8 into 1gSAR or 10gSAR value using the equation in step 5.

Repeat step 6 to generate the plots.

4.9 Test Configuration and Procedure for Scenario 8: SAR Exposure Switching via Conducted Power Measurements

4.9.1 Configuration

If supported, SAR exposure switch with two active radios having the same and different time averaging windows should be covered in this test. TA algorithm operation is independent of the source of SAR exposure (e.g., LTE vs. NR FR1) and ensures total time-averaged RF exposure compliance for SAR exposure among the scenarios of radio 1 only, radio 1 + radio 2, and radio 2 only.

- Select any two < 6GHz RATs/bands that the EUT supports for simultaneous transmission (e.g., LTE+NR FR1).
- The selection order among all supported simultaneous transmission configurations is
 - Select one configuration with P_{sub6_limit} values of radio1 and radio2 less than their corresponding P_{UE_max} , and their P_{sub6_limit} values are different if possible.
 - If the previous configuration does not exist, at least one radio has its P_{sub6_limit} less than P_{UE_max} .
 - If above two cannot be found, select one configuration that has P_{sub6_limit} of radio1 and radio2 with the least difference between P_{sub6_limit} and P_{UE_max} (i.e., P_{sub6_limit} can be greater than P_{UE_max}).
- One test with two active radios in any two different time windows is sufficient to cover this scenario.
- One SAR switching is sufficient because the TA algorithm operation is the same.

4.9.2 Procedure

- Step 1~3: measure and record TX power versus time for test scenario 8
 - A. Measure conducted TX power corresponding to radio1 P_{sub6_limit}
 - Establish device in call with the callbox for radio1 band.
 - Measure conducted TX power corresponding to radio1 P_{sub6_limit} with TA_SAR enabled and $P_{UE_backoff_offset}$ set to 0 dB, callbox set to request maximum power.
 - B. measure conducted TX power corresponding to radio2 P_{sub6_limit}
 - Repeat above step to measure conducted TX power corresponding to radio2 P_{sub6_limit} .
 - If radio2 is dependent on radio1 (for example, non-standalone mode of NR FR1 requiring radio1 LTE as anchor), then establish radio1 + radio2 call with callbox, and request all down bits for radio1 LTE.
 - In this scenario, with callbox requesting maximum power from radio2 NR FR1, measured conducted TX power corresponds to radio2 P_{sub6_limit} (as radio1 LTE is at all-down bits)

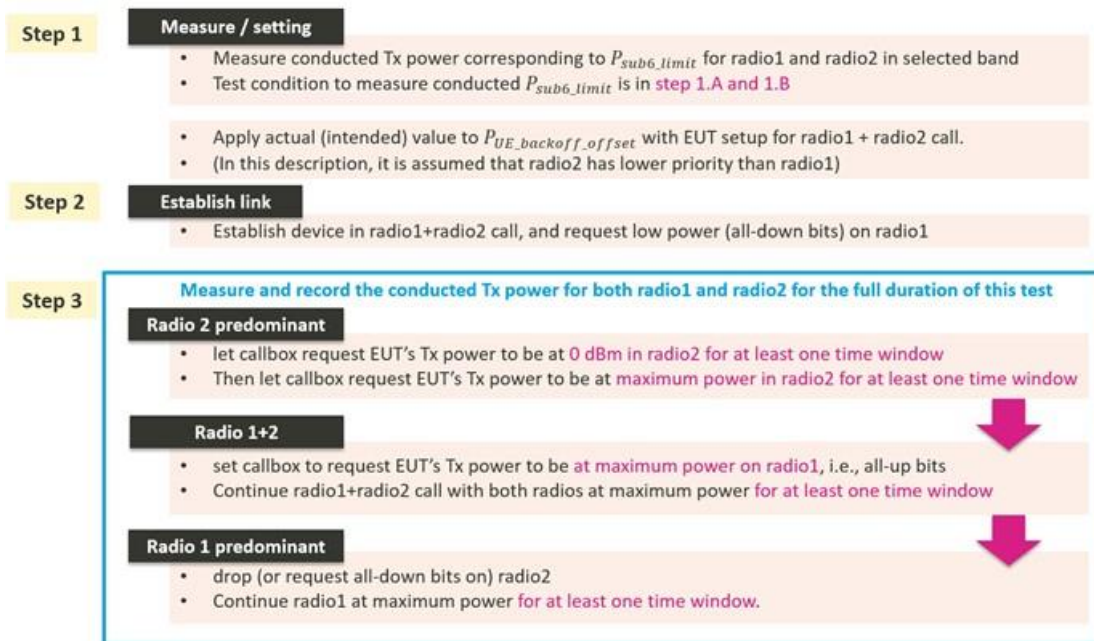

- Step 4: convert the measured conducted TX power into SAR

Convert the measured conducted TX power from step 3 into 1gSAR or 10gSAR value using the following equation.

Perform the running time average to power and 1gSAR or 10g SAR to determine time-averaged value versus time as follows,

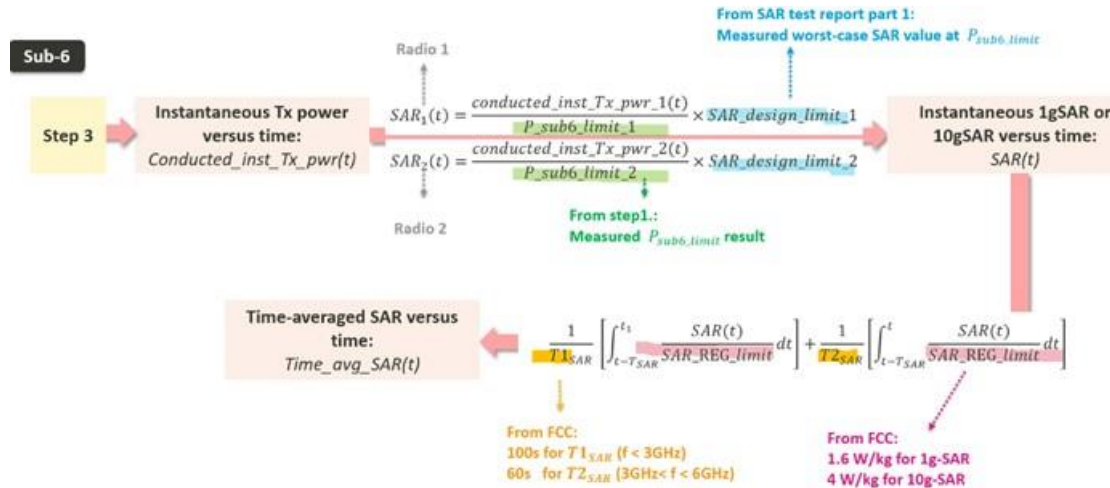

- Step 5: plot results
 - A. Make one power perspective plot containing
 1. Instantaneous TX power
 2. Requested power
 3. Calculated time-averaged power
 4. Calculated time-averaged power limits
 - B. Make one SAR perspective plot containing
 1. Calculated time-averaged 1gSAR or 10gSAR
 2. FCC limit of 1.6 W/kg (1gSAR) or 4.0 W/kg (10gSAR)
 3. Normalized time-averaged 1gSAR/1.6 or 10gSAR/4.0

4.10 Test Configuration and Procedure for Scenario 2: Time-Varying TX Power via SAR Measurements

4.10.1 Configuration

Sections 4.2 to 4.9 focus on Mediatek’s TA feature compliance validation via conducted TX power measurements. This section further provides a SAR measurement procedure for time-varying TX power scenario described in section 4.3. Hence, this section follows the test configuration of section 4.3, and uses test sequences 1 and 2 defined in section 4.1.

4.10.2 Procedure

SAR is measured and recorded by the following steps:

- Step 1~4: measure and record SAR versus time

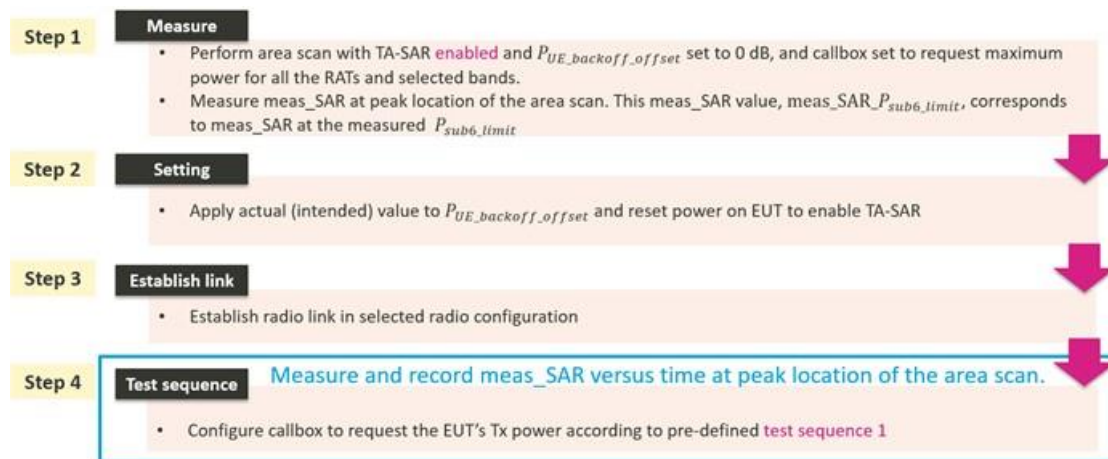

- Step 5: convert the measured SAR into time-averaged SAR

Convert the instantaneous measured SAR from step 4 into 1gSAR or 10gSAR value. Perform the running time average to 1gSAR or 10g SAR to determine time-averaged value versus time as follows,

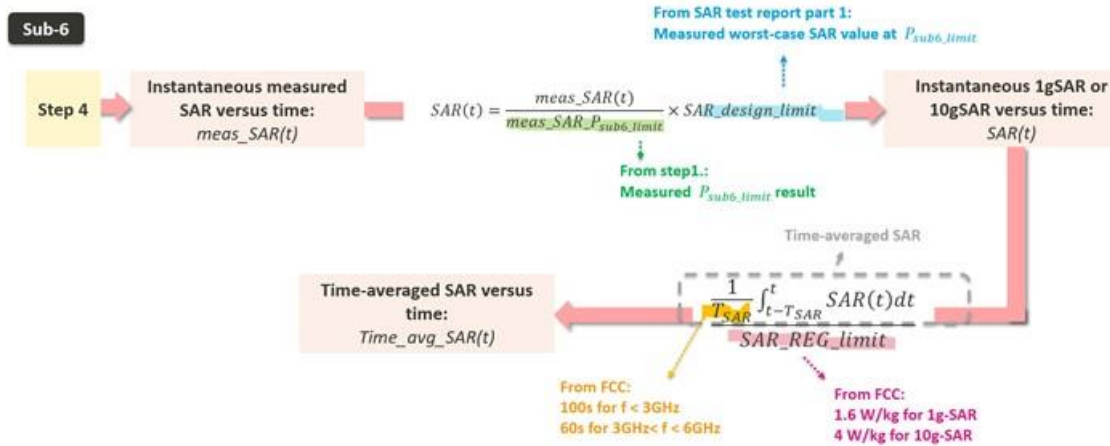

where, $meas_SAR_P_{sub6_limit}$ is the value determined in step 1, and $meas_SAR(t)$ is the instantaneous measured SAR measured in step 4.

- Step 6: plot result
 - A. Calculated time-averaged 1gSAR or 10gSAR
 - B. FCC limit of 1.6 W/kg (1gSAR) or 4.0 W/kg (10gSAR)
- Step 7: repeat steps 2 ~ 6 for pre-defined test sequence 2

Repeat steps 2 ~ 6 for pre-defined test sequence 2 and replace test sequence 1 in step 4 with test sequence 2.

- Step 8: repeat steps 2 ~ 7 for all the selected bands

The time-averaged SAR versus time shall not exceed FCC limit at all times.

5. TA-SAR Validation via Conducted Power Measurements

5.1 Measurement Setup

5.1.1 Test Bench Introduction

The call boxes KeySight UXM (supporting sub6 NR and LTE) and Rohde & Schwarz CMW500 (supporting LTE, WCDMA, C2K and 2G) are used to validate the proposed TA-SAR mechanism. Figure 6-2 shows the block diagram of the measurement bench, which supports the following test scenarios.

- Test scenario 1: range of TA-SAR parameters
- Test scenario 2: time-varying TX power
- Test scenario 3: call disconnection and re-establishment
- Test scenario 5: ECI change

For these measurements, RF port of the call box is connected to the EUT’s antenna port, and the call box establishes a connection link through the test script console tool and the power meter measures the conducted output power of the EUT.

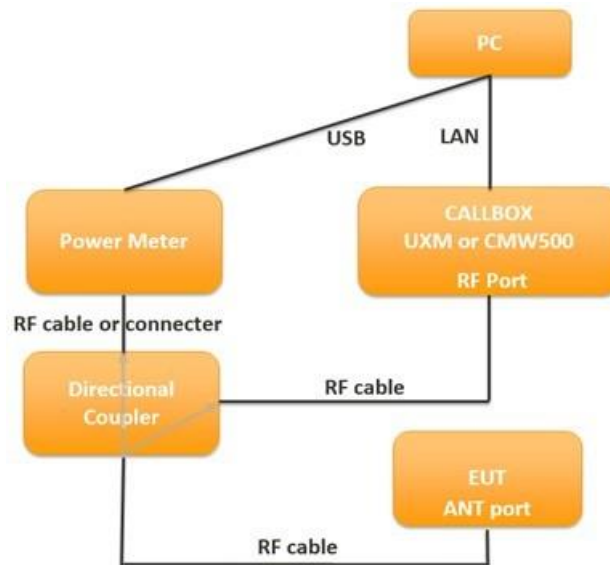

Figure 5- 1 TA-SAR conductive power test setup block diagram for scenarios 1/2/3/5

Figure 5-3 shows the block diagram of the measurement bench, which support test scenario 4 (band handover) and scenario 7 (time window switching). For these measurements, the RF port of the call box is connected with a 1-to-2 power divider, which allows the call box to transmit/receive signals from the two different system configurations set in these two test scenarios. Figure 5-4 shows the setup, which is highly similar to Figure 5-3, to support test scenario 6 (antenna switching); as seen in the figure, two EUT's antenna ports are individually connected with a RF cable.

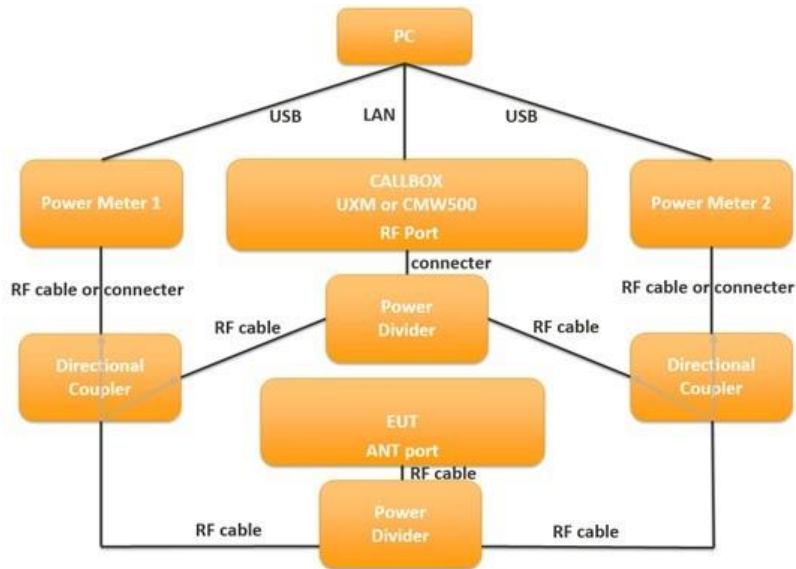

Figure 5- 2 TA-SAR conductive power test setup block diagram for scenarios 4 and 7

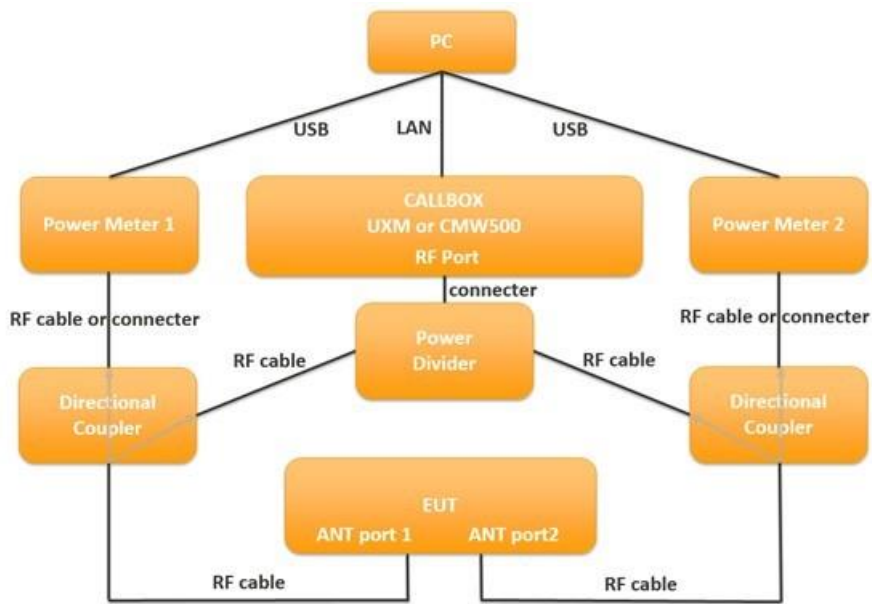

Figure 5- 3 TA-SAR conductive power test setup block diagram for scenario 6

Figure 5-5 shows the setup for test scenario 4 (RAT handover) and scenario 8 (SAR exposure switching). Since two RATs need to be controlled in these two scenarios, RF port of RAT #1 and RF port of RAT #2 of the call box are individually connected to an antenna port of the EUT through a directional coupler. It is noted that each of the two RATs individually transmit signals though one antenna port. The antenna port assignment of each RAT for these two scenarios is described in Figure 5-1.

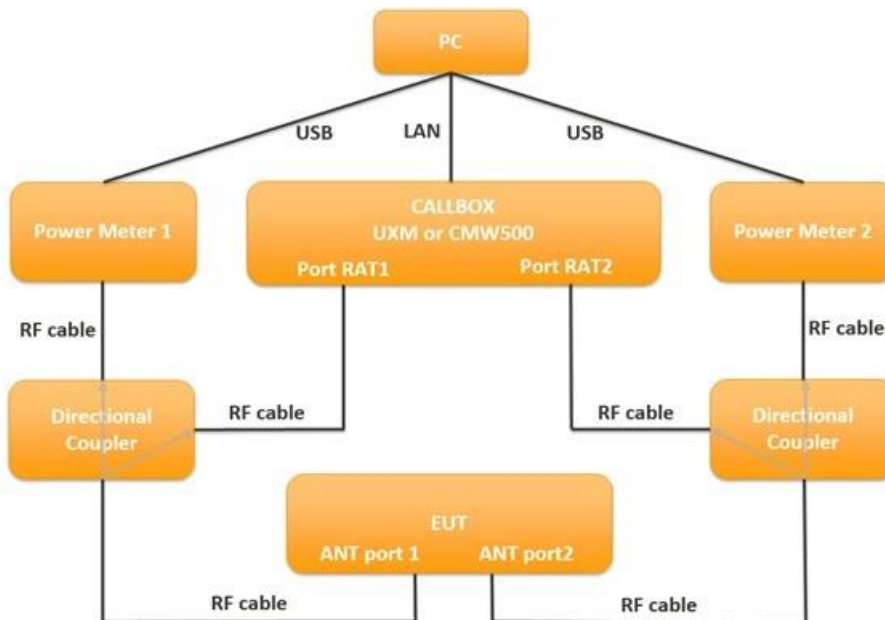

Figure 5- 4 TA-SAR conductive power test setup block diagram for scenarios 4/8



5.1.2 Sub6 NR/LTE/3G/2G Power Limit Table and Test Configurations

For the supported bands/channels/antennas of each technology, the measured power limit (P_{sub6_limit}), corresponding to SAR_design_limit , is listed in the table 6-1. The SAR_design_limit is determined by taking 1-dB device uncertainty into consideration. Please note that for TDD bands with TX duty cycles less than or equal to 100%, the measured power limit corresponds to the burst averaged power level which does not account for TX duty cycle.

Table 6-1 Summary table of power limit (P_{sub6_limit}) for all supported RAT

Band	Antenna	Head	Body Worn	Hotspot	Extremity	Sensor off	Pmax*
		(ECI:2)	(ECI3)	(ECI7) Simultaneous	(ECI6)	(ECI4)	
GSM850 (4 Tx slots)	Ant 0	27.80	22.00	22.00	25.50	25.50	25.50
GSM1900 (4 Tx slots)	Ant 0	32.20	15.00	13.00	20.50	22.50	22.50
WCDMA II	Ant 0	30.50	15.50	13.50	20.50	23.00	23.00
WCDMA IV	Ant 0	32.70	17.00	15.00	20.00	23.00	23.00
WCDMA V	Ant 0	27.40	21.50	21.50	26.00	23.00	23.00
LTE Band 7	Ant 0	35.20	17.00	16.00	20.00	23.00	23.00
LTE Band 7	Ant 1	13.50	13.00	10.50	16.50	23.00	23.00
LTE Band 12(17)	Ant 0	30.10	23.80	23.80	23.00	23.00	23.00
LTE Band 12(17)	Ant 1	20.00	22.00	20.50	23.00	23.00	23.00
LTE Band 13	Ant 0	29.40	23.00	23.00	28.60	23.00	23.00
LTE Band 13	Ant 1	21.00	23.00	21.00	23.00	23.00	23.00
LTE Band 14	Ant 0	29.10	22.50	22.50	25.40	23.00	23.00
LTE Band 14	Ant 1	21.00	23.00	20.50	23.00	23.00	23.00
LTE Band 25(2)	Ant 0	32.20	16.00	14.00	20.50	23.00	23.00
LTE Band 25(2)	Ant 1	15.50	16.50	14.00	19.00	23.00	23.00
LTE Band 26(5)	Ant 0	28.30	21.50	21.50	25.30	23.00	23.00
LTE Band 26(5)	Ant 1	20.00	21.50	19.50	22.00	23.00	23.00
LTE Band 30	Ant 0	35.40	17.00	14.00	21.00	23.00	23.00
LTE Band 30	Ant 1	15.00	16.00	13.00	18.00	23.00	23.00
LTE Band 41-HPUE	Ant 0	36.00	18.40	17.40	21.40	22.40	22.40
LTE Band 41(38)	Ant 0	36.00	18.40	17.40	21.40	22.40	21.00
LTE Band 41-HPUE	Ant 1	14.40	14.90	12.40	17.40	22.40	22.40
LTE Band 41(38)	Ant 1	14.40	14.90	12.40	17.40	22.40	21.00
LTE Band 41-HPUE	Ant 2	33.00	24.60	22.40	22.40	22.40	22.40
LTE Band 41	Ant 2	33.00	24.60	22.40	22.40	22.40	21.00
LTE Band 41-HPUE	Ant 6	20.90	20.40	16.40	22.40	22.40	22.40
LTE Band 41	Ant 6	20.90	20.40	16.40	22.40	22.40	21.00
LTE Band 48	Ant 4	16.00	16.00	12.50	18.50	21.00	21.00
LTE Band 48	Ant 2	24.20	19.00	15.00	18.00	21.00	21.00
LTE Band 48	Ant 7	15.50	16.50	14.00	18.50	21.00	21.00
LTE Band 48	Ant 5	29.00	21.00	17.50	20.00	20.00	21.00
LTE Band 66(4)	Ant 0	33.20	17.00	15.00	19.50	23.00	23.00
LTE Band 66(4)	Ant 1	15.00	17.00	14.00	18.50	23.00	23.00
LTE Band 71	Ant 0	29.10	24.90	24.90	23.00	23.00	23.00
LTE Band 71	Ant 1	19.50	23.00	21.00	23.00	23.00	23.00



Band	Antenna	Head	Body Worn	Hotspot	Extremity	Sensor off	Pmax*
		(ECI:2)	(ECI3)	(ECI7) Simultaneous	(ECI6)	(ECI4)	
5G NR n7	Ant 0	36.00	18.50	18.00	23.80	23.00	23.00
5G NR n7	Ant 1	15.00	15.50	13.50	18.00	23.00	23.00
5G NR n12	Ant 0	32.30	25.50	25.50	23.00	23.00	23.00
5G NR n12	Ant 1	21.00	25.30	23.00	23.00	23.00	23.00
5G NR n14	Ant 0	32.90	25.20	25.20	23.00	23.00	23.00
5G NR n14	Ant 1	22.00	24.70	23.50	23.00	23.00	23.00
5G NR n25(2)	Ant 0	32.70	18.00	16.00	23.60	23.00	23.00
5G NR n25(2)	Ant 1	18.00	18.00	16.50	21.50	23.00	23.00
5G NR n26(5)	Ant 0	30.60	24.20	24.20	23.00	23.00	23.00
5G NR n26(5)	Ant 1	22.00	23.50	22.00	23.00	23.00	23.00
5G NR n30	Ant 0	35.80	18.50	17.00	23.80	23.00	23.00
5G NR n30	Ant 1	17.00	18.00	15.00	20.00	23.00	23.00
5G NR n41-HPUE	Ant 0	37.10	19.00	17.50	23.00	26.00	26.00
5G NR n41(38)	Ant 0	37.10	19.00	17.50	23.00	26.00	23.00
5G NR n41-HPUE	Ant 1	16.50	16.00	12.50	18.50	26.00	26.00
5G NR n41(38)	Ant 1	16.50	16.00	12.50	18.50	26.00	23.00
5G NR n41-HPUE	Ant 2	33.50	25.00	23.00	22.00	26.00	26.00
5G NR n41	Ant 2	33.50	25.00	23.00	22.00	26.00	23.00
5G NR n41-HPUE	Ant 6	20.00	20.00	15.00	22.00	22.00	26.00
5G NR n41	Ant 6	20.00	20.00	15.00	22.00	22.00	23.00
5G NR n66	Ant 0	33.60	19.00	17.50	23.00	23.00	23.00
5G NR n66	Ant 1	19.00	20.00	17.00	21.50	23.00	23.00
5G NR n70	Ant 0	34.10	20.00	18.00	22.50	23.00	23.00
5G NR n70	Ant 1	19.00	20.50	19.00	21.00	23.00	23.00
5G NR n71	Ant 0	32.20	26.50	26.50	23.00	23.00	23.00
5G NR n71	Ant 1	22.00	25.80	25.00	23.00	23.00	23.00
5G NR n48	Ant 4	19.00	19.00	14.00	20.00	23.00	23.00
5G NR n48	Ant 2	26.10	22.00	18.00	21.00	23.00	23.00
5G NR n48	Ant 7	16.50	18.00	15.00	21.00	23.00	23.00
5G NR n48	Ant 5	28.50	23.00	21.00	24.80	23.00	23.00
5G NR n77-HPUE	Ant 4	20.00	20.00	15.50	20.00	26.00	26.00
5G NR n77(78)	Ant 4	20.00	20.00	15.50	20.00	26.00	23.00
5G NR n77-HPUE	Ant 2	29.00	22.00	17.50	20.50	26.00	26.00
5G NR n77(78)	Ant 2	29.00	22.00	17.50	20.50	26.00	23.00
5G NR n78	Ant 7	15.50	18.50	16.00	20.50	23.00	23.00
5G NR n77 PC2&PC3	Ant 7	15.80	18.80	16.30	20.80	23.30	23.30
5G NR n77-HPUE	Ant 5	30.60	24.50	19.50	23.50	23.50	26.00
5G NR n77(78)	Ant 5	30.60	24.50	19.50	23.50	23.50	23.00

Mediatek developed the TA-SAR algorithm to control instantaneous TX power for transmit frequencies less and larger than 6GHz respectively, so that the total time-averaged RF exposures are less than FCC requirement.

TA-SAR algorithm validation has been performed for 2G, 3G, LTE, NR FR1 according to cases with different combinations of operating parameters listed in Table 2-1.

Table 2-1 TA-SAR operating parameters

Operating parameters	Description
P_{sub6_limit}	The time-averaged maximum power level limit for different bands for 2G, 3G, LTE, and NR FR1.
$P_{LowThresh_offset}$	To calculate $P_{LowThresh}$. ($P_{LowThresh} = P_{sub6_limit} - P_{LowThresh_offset}$)
$P_{UE_backoff_offset}$	To calculate $P_{UE_backoff}$. ($P_{UE_backoff} = P_{sub6_limit} - P_{UE_backoff_offset}$)
$P_{UE_max_cust_offset}$	To calculate $P_{UE_max_cust}$. P_{UE_max} is maximum TX power at which a UE can possibly transmit. $P_{UE_max_cust} = \min(P_{UE_max}, P_{sub6_limit} + P_{UE_max_cust_offset})$



Table for Sub-6GHz TA-SAR validation test case list

Test Case #	Test Scenario	Test Configuration
1	1.Range of TA-SAR-parameters	LTE Band 7
2	2.Time-varting TX power	GSM850(4TX)
3		GSM1900(4TX)
4		WCDMA II
5		WCDMA V
6		LTE Band 7
7		LTE Band 26 / 5
8		FR1 n41
9		FR1 n26
10		3.Call disconnection and re-establishment
11	4.Band handover	LTE Band 7
		WCDMA II
12	5.ECI(Exposure Condition In dex)	LTE Band 7
		LTE Band 7
13	7.Time window switching 60s-100s-60s	LTE Band 7
		LTE Band 48
14	7.Time window switching 100s-60s-100s	LTE Band 48
		LTE Band 7
15	8.SAR exposure switching(ENDC)	LTE Band 48
		FR1 n66
15	8.SAR exposure switching(ULCA)	LTE Band 25 / 2
		LTE Band 26 / 5



Table 6-2 summarizes the test configurations of all RATs, and the corresponding worst-case measured SAR for each RAT under the power limit.

Table 6-2 Test configurations of radio technologies and worst-case measured SAR

Test Case #	Test Scenario	Test band	BW (MHz)	Modulation	RB size	RB offset	mode	Test Position	Gap (mm)	Antenna	ECI	Channel	Freq (MHz)	Part 1, SAR @Plimit 1-g SAR (W/kg)	Part 1, SAR @Plimit 10-g SAR (W/kg)
1	1.Range of TA-SAR-parameters	LTE Band 7	20M	QPSK	1	0	-	Top side	5	1	7	21100	2535	0.42	
2	2.Time-varting TX power	GSM850	-	-	-	-	GPRS (4 Tx slots)	Back	5	0	7	251	848.8	0.983	
3		GSM1900	-	-	-	-	GPRS (4 Tx slots)	Bottom Side	5	0	7	810	1909.8	1.05	
4		WCDMA II	-	-	-	-	RMC 12.2Kbps	Bottom Side	5	0	7	9538	1907.6	0.908	
5		WCDMA V	-	-	-	-	RMC 12.2Kbps	Back	5	0	7	4182	836.4	0.919	
6		LTE Band 7	20M	QPSK	1	0	-	Top side	5	1	7	21100	2535	0.42	
7		LTE Band 26/5	15M	QPSK	1	0	-	Top Side	0	1	6	26865	831.5		1.86
8		FR1 n41	100M	QPSK,DFT-30	135	69	-	Top Side	5	1	7	518598	2592.99	0.489	
9		FR1 n26	20M	QPSK,DFT-15	50	28	-	Top Side	5	1	7	166300	831.5	0.538	
10		3.Call disconnection and re-establishment	LTE Band 7	20M	QPSK	1	0	-	Top side	5	1	7	21100	2535	0.42
11	4.Band handover	LTE Band 7	20M	QPSK	1	0	-	Top side	5	1	7	21100	2535	0.42	
		WCDMA II	-	-	-	-	RMC 12.2Kbps	Bottom Side	5	0	7	9538	1907.6	0.908	
12	5.ECI(Exposure Condition In dex)	LTE Band 7	20M	QPSK	1	0	-	Top side	5	1	7	21100	2535	0.42	
		LTE Band 7	20M	QPSK	1	0	-	Right Tilted	0	1	2	21350	2560	0.682	
13	7.Time window switching 60s-100s-60s	LTE Band 7	20M	QPSK	1	0	-	Top side	5	1	7	21100	2535	0.42	
		LTE Band 48	20M	QPSK	1	0	-	Left Side	5	4	7	55830	3609	0.538	
14	7.Time window switching 100s-60s-100s	LTE Band 48	20M	QPSK	1	0	-	Left Side	5	4	7	55830	3609	0.538	
		LTE Band 7	20M	QPSK	1	0	-	Top side	5	1	7	21100	2535	0.42	
15	8.SAR exposure switching(ENDC)	LTE Band 48	20M	QPSK	1	0	-	Left Side	5	4	7	55830	3609	0.538	
		FR1 n66	40M	QPSK,DFT-15	108	54	-	Bottom Side	5	0	7	349000	1745	1.02	
15	8.SAR exposure switching(ULCA)	LTE Band 25 / 2	20M	QPSK	1	0	-	Bottom Side	5	0	7	26590	1905	1.06	
		LTE Band 26 / 5	15M	QPSK	1	0	-	Top Side	5	1	7	26865	831.5	0.42	



Table 6-3 Test configurations of radio technologies and worst-case measured Plimit and Pmax

Test case	RAT	Test band	Test seq.	Antenna	ECI	Pmax Setting (dBm)	Measurement Pmax (dBm)	Plimit setting (dBm)	Measurement Plimit (dBm)	PEU_backoff (dBm)	PEU_max_cust (dBm)	Pass /Fail SAR limit
1	1.Range of TA-SAR-parameters	LTE Band 7	0	1	7	23.00	23.76	10.50	11.16	3	9	Pass
2	2.Time-varying TX power	GSM850(4TX)	1 & 2	0	7	25.50	25.25	22.00	22.27	3	5	Pass
3		GSM1900(4TX)	1 & 2	0	7	22.50	22.47	13.00	13.18	3	6	Pass
4		WCDMA II	1 & 2	0	7	23.00	23.74	13.50	13.52	3	6	Pass
5		WCDMA V	1 & 2	0	7	23.00	23.84	21.50	22.27	3	3	Pass
6		LTE Band 7	1 & 2	1	7	23.00	23.76	10.50	11.16	3	9	Pass
7		LTE Band 26 / 5	1 & 2	1	6	23.00	23.87	22.00	22.87	3	3	Pass
8		FR1 n41	1 & 2	1	7	23.00	23.24	12.50	12.60	3	9	Pass
9		FR1 n26	1 & 2	1	7	23.00	22.47	22.00	21.53	3	5	Pass
10		3.Call disconnection and re-establishment	LTE Band 7	0	1	7	23.00	23.76	10.50	11.16	3	9
11	4.Band handover	LTE Band 7	0	1	7	23.00	23.76	10.50	11.16	3	9	Pass
		WCDMA II	0	0	7	23.00	22.40	13.50	13.41	3	6	Pass
12	5.ECI(Exposure Condition In dex)	LTE Band 7	0	1	7	23.00	23.76	10.50	11.16	3	9	Pass
		LTE Band 7	0	1	2	23.00	23.76	13.50	14.21	3	9	Pass
13	7.Time window switching 60s-100s-60s	LTE Band 7	0	1	7	23.00	23.76	10.50	11.16	3	9	Pass
		LTE Band 48	0	4	7	21.00	21.97	12.50	13.46	3	9	Pass
14	7.Time window switching 100s-60s-100s	LTE Band 48	0	4	7	21.00	21.97	12.50	13.46	3	9	Pass
		LTE Band 7	0	1	7	23.00	23.76	10.50	11.16	3	9	Pass
15	8.SAR exposure switching(ENDC)	LTE Band 48	0	4	7	21.00	21.97	12.50	13.46	3	9	Pass
		FR1 n66	0	0	7	23.00	23.38	17.50	18.01	3	6	Pass
15	8.SAR exposure switching(ULCA)	LTE Band 25 / 2	0	0	7	23.00	23.85	14.00	14.82	3	9	Pass
		LTE Band 26 / 5	0	1	7	23.00	23.89	19.50	20.36	3	3	Pass

5.2 Conducted Power Measurement Results for Scenario1: Range of TA-SAR Parameters

In this scenario, two TA-SAR parameters are swept to validate Mediatek’s TA-SAR algorithm. The parameter sets are summarized in Table 6-3, and the test procedure follows section 4.2.2. The measurement setup is shown in Figure 5-2. The high-level summary of the final validation results are also listed in the last column of the table, which concludes that Mediatek’s TA-SAR algorithm can maintain the time-averaged SAR is always below the FCC requirement for all test cases. The following section will demonstrate case-by-case to show how Mediatek’s TA-SAR algorithm behaves for different parameters.

- **Case1: LTE B7 result for Range of TA-SAR**

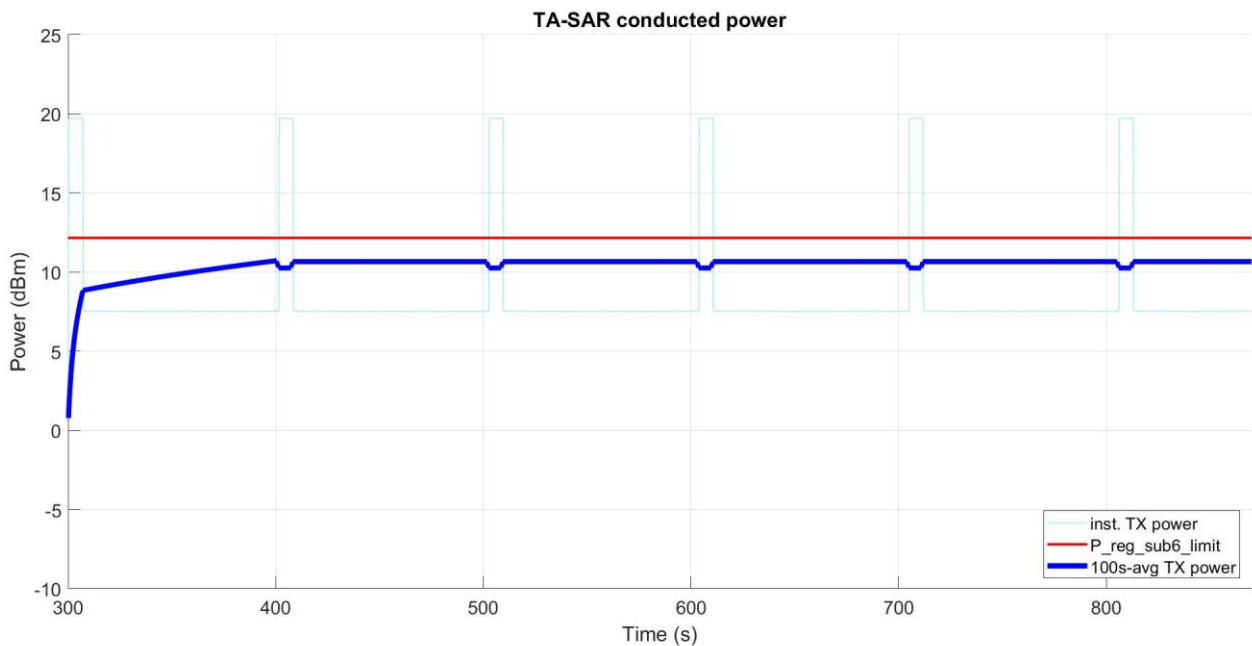

Figure 5- 5 Time-averaged conducted TX power over time

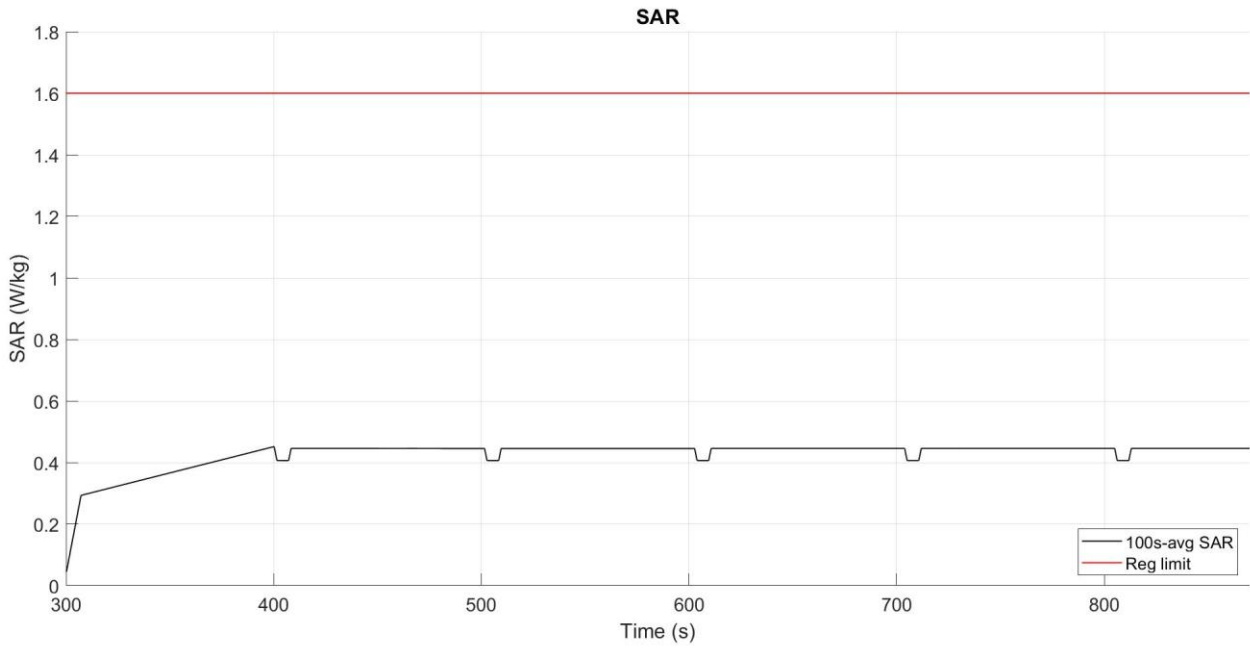

Figure 5- 6 Time-averaged SAR

FCC 1gSAR limit	1.6 W/kg
Max 100s-time averaged 1gSAR	0.452 W/kg
Validation result: pass	

5.3 Conducted Power Measurement Results for Scenario 2: Time-Varying TX Power

In this scenario, Mediatek’s TA-SAR algorithm is tested under more dynamic power test sequences. The test sequence #1 is shown in section 4.1 and test sequence #2 is tabulated in table 4.4. All of the test cases for this scenario are relegated in Table 6-3, and the test procedure follows section 4.3.2. The measurement setup is shown in Figure 5-2. The high-level summary of the final validation results are also listed in the last column of the table, which concludes that Mediatek’s TA-SAR algorithm can maintain the time-averaged SAR is always below the FCC requirement for all test cases. The following sections will demonstrate case-by-case to show how Mediatek’s TA-SAR algorithm behaves for each RAT.

5.3.1 Measurement results for 2G

The corresponding detailed test procedure is described in 4.3.2. For the figure set of each case, the first figure demonstrates the EUT’s instantaneous conducted TX power, the time-averaged conducted TX power behavior over time, and the power limit ($P_{reg_sub6_limit} = P_{sub6_limit} + 1\text{dB device uncertainty}$). The second figure illustrates the corresponding time-averaged SAR over time converted from the TX time-averaged power by using the equation listed in section 4.3.2.

- **Case2-1: GSM850 result for test sequence 1**

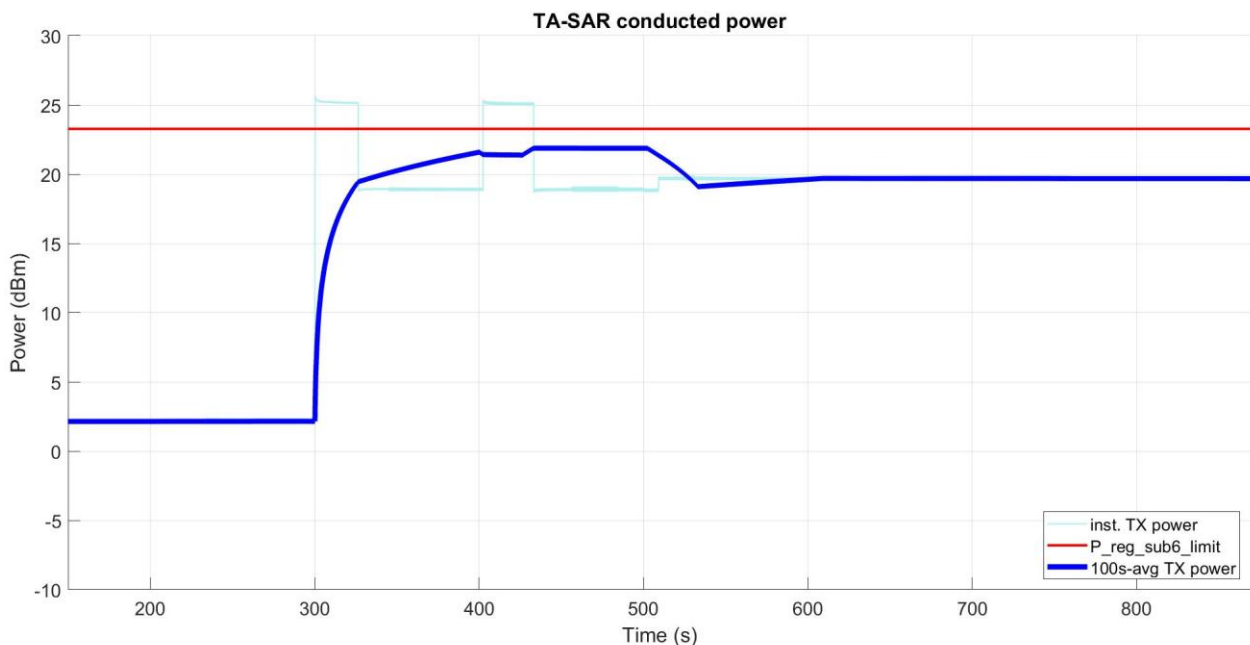

Figure 5- 7 Time-averaged conducted TX power over time

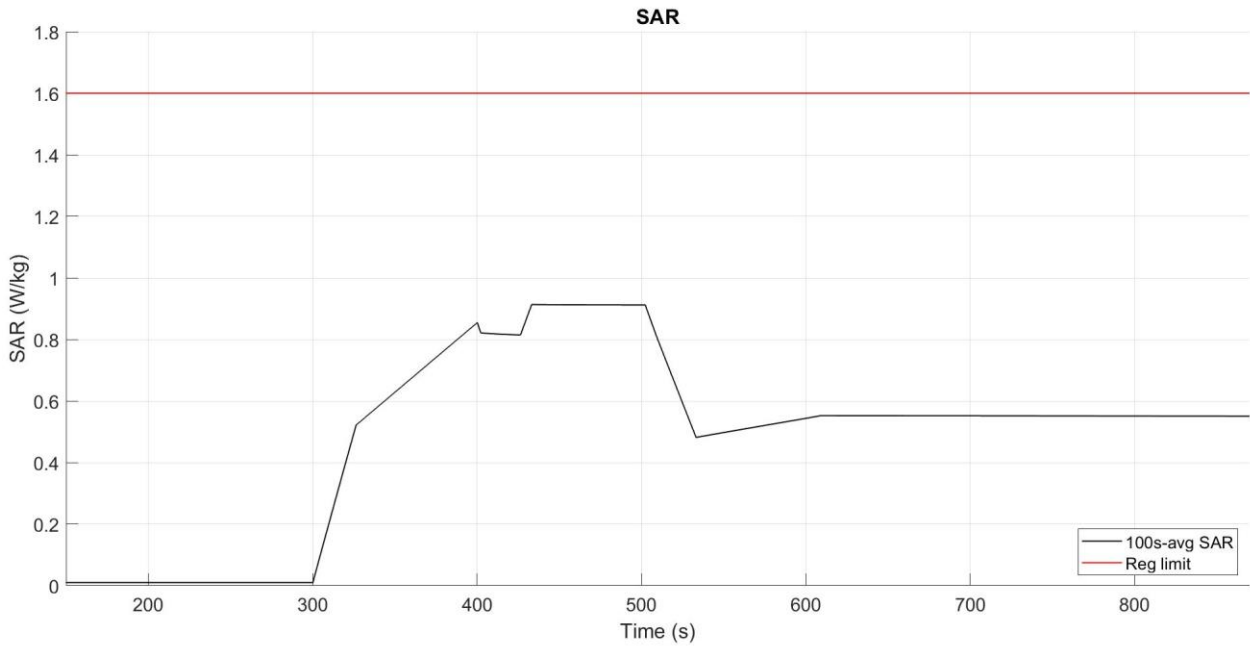

Figure 5- 8 Time-averaged SAR

FCC 1gSAR limit	1.6 W/kg
Max 100s-time averaged 1gSAR	0.913 W/kg
Validation result: pass	

● Case2-2: GSM850 result for test sequence 2

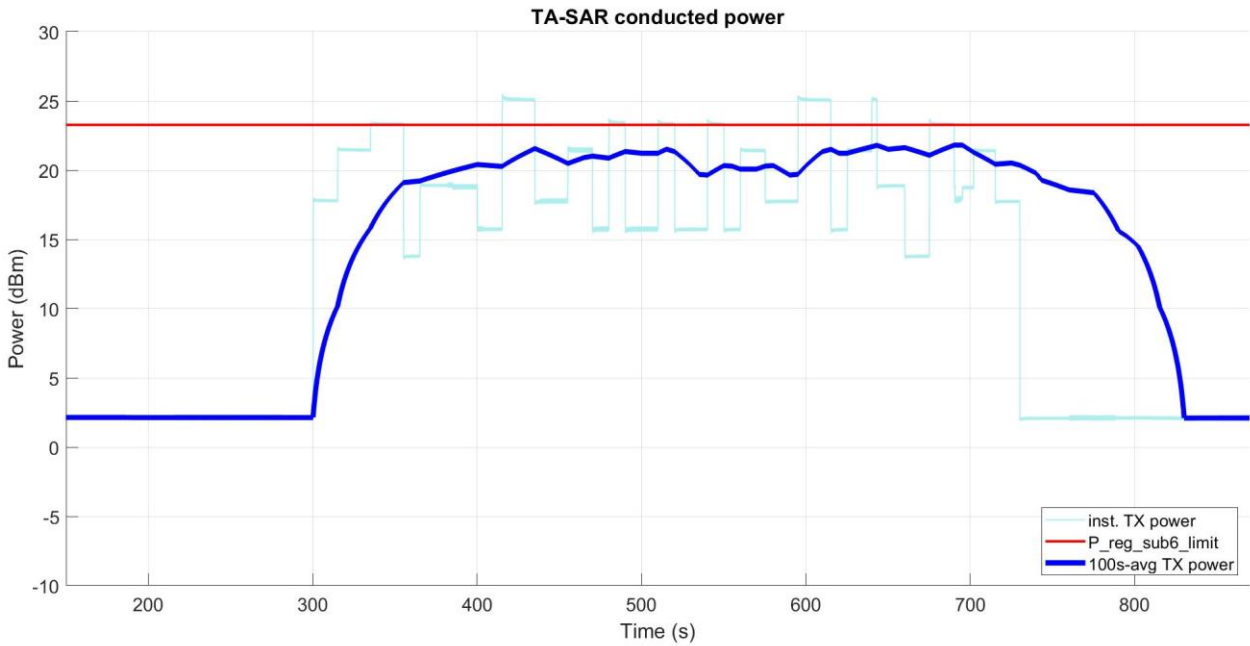

Figure 5- 9 Time-averaged conducted TX power over time

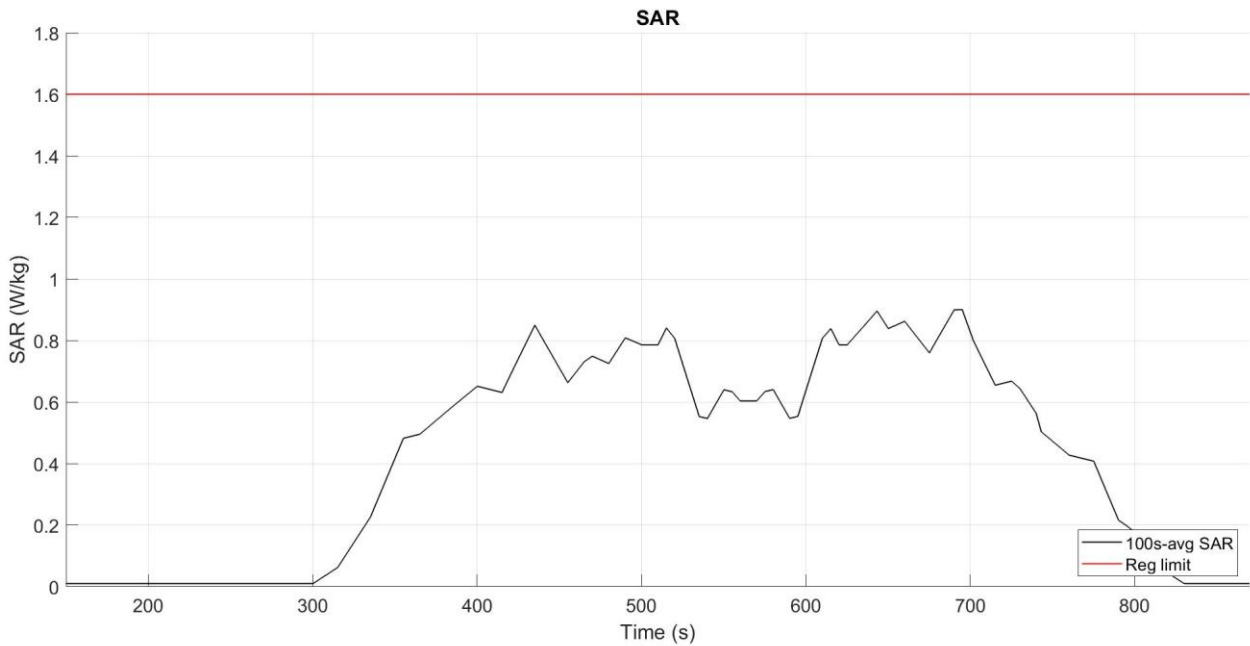

Figure 5- 10 Time-averaged SAR

FCC 1gSAR limit	1.6 W/kg
Max 100s-time averaged 1gSAR	0.900 W/kg
Validation result: pass	

● Case3-1: GSM1900 result for test sequence 1

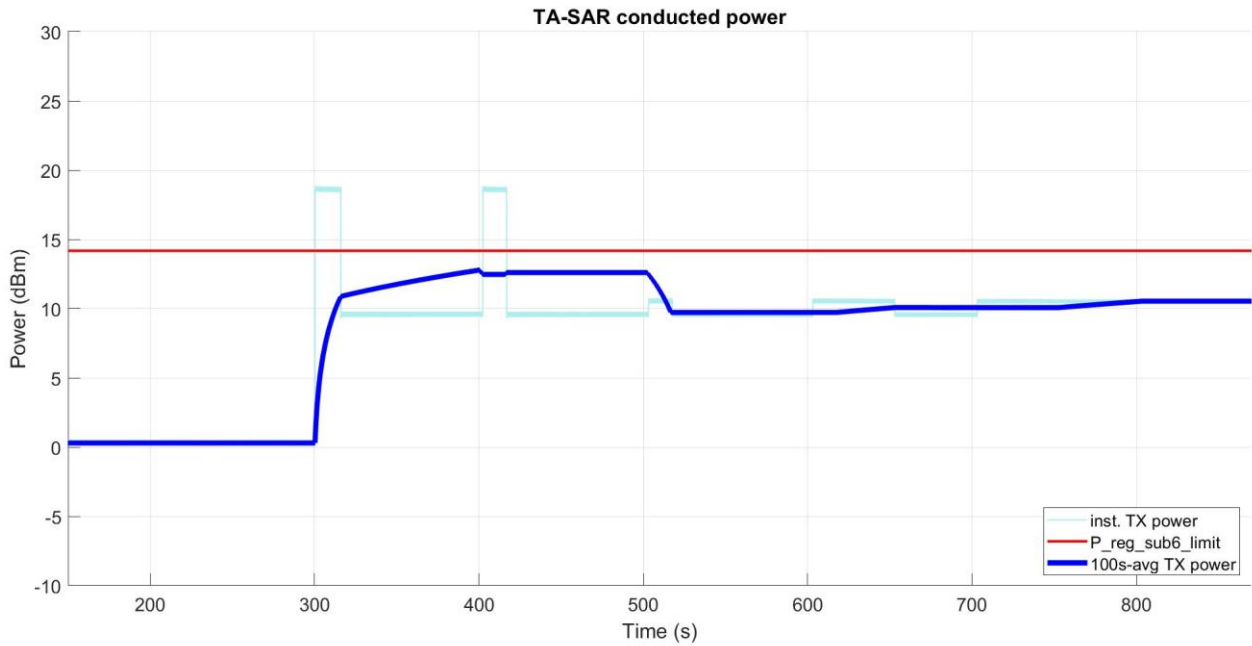

Figure 5- 11 Time-averaged conducted TX power over time

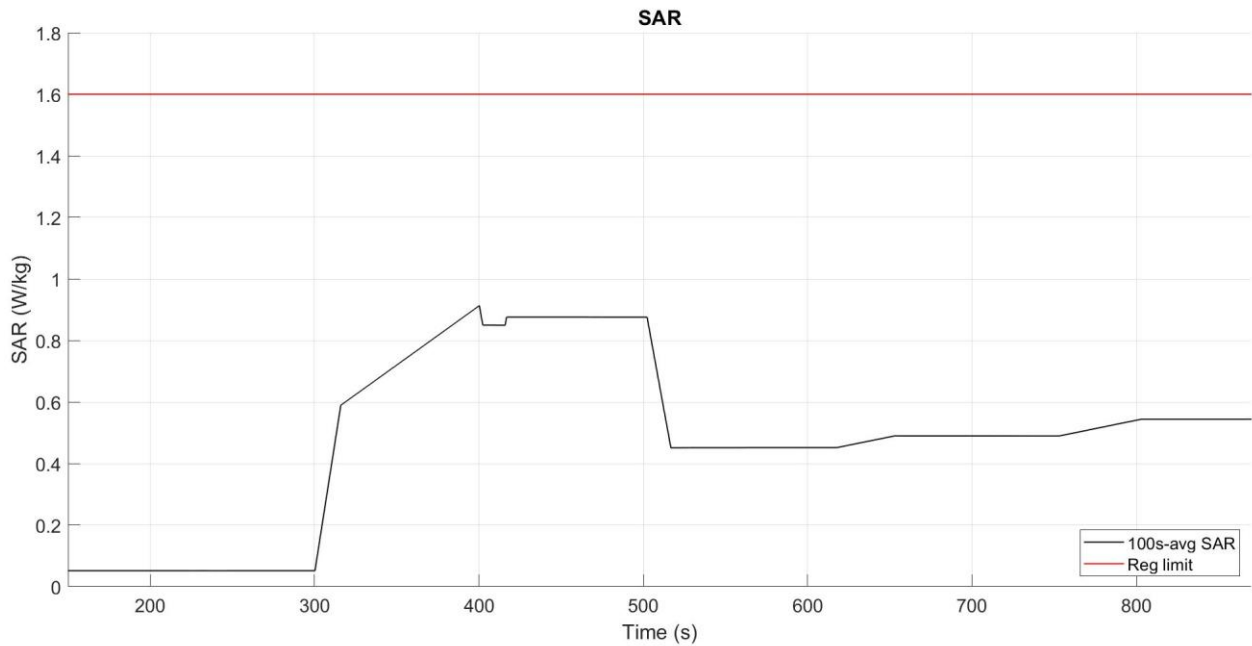

Figure 5- 12 Time-averaged SAR

FCC 1gSAR limit	1.6 W/kg
Max 100s-time averaged 1gSAR	0.913 W/kg
Validation result: pass	

● Case3-2: GSM1900 result for test sequence 2

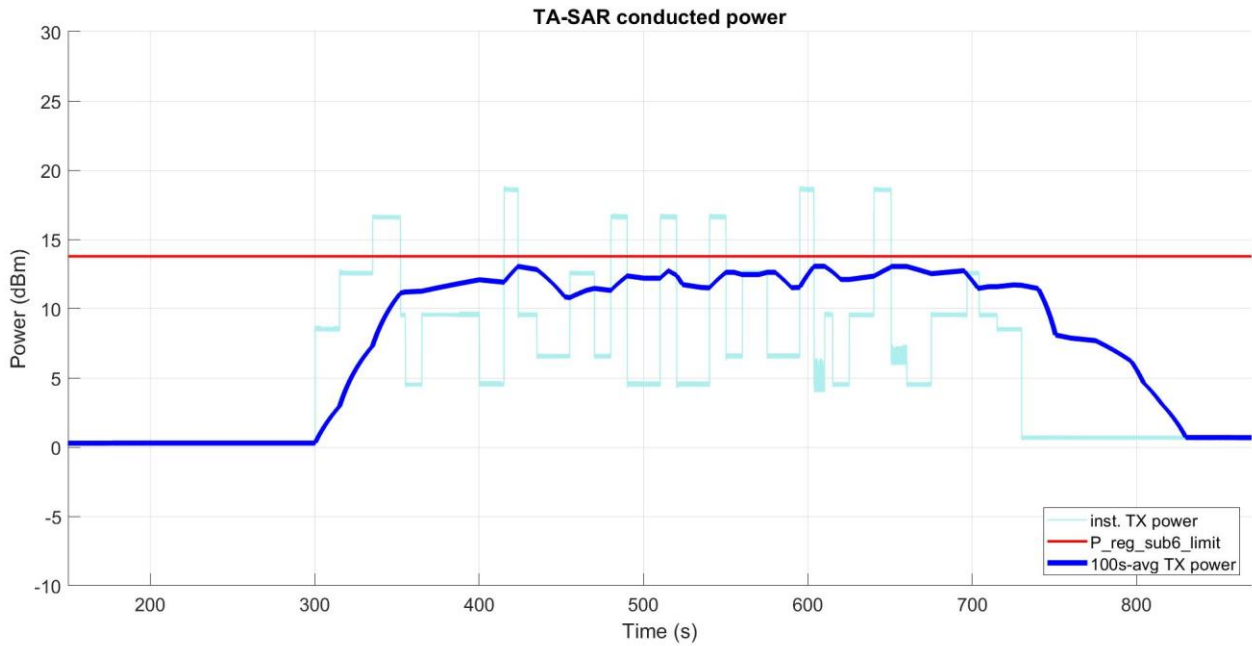

Figure 5- 13 Time-averaged conducted TX power over time

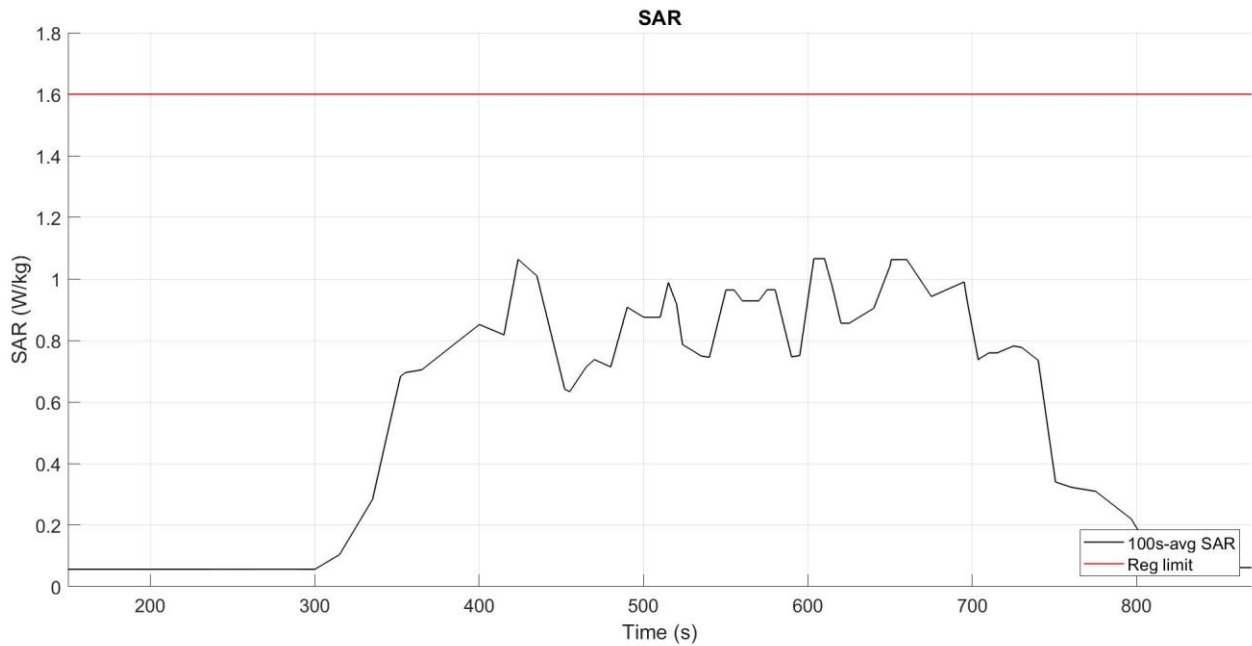

Figure 5- 14 Time-averaged SAR

FCC 1gSAR limit	1.6 W/kg
Max 100s-time averaged 1gSAR	1.066 W/kg
Validation result: pass	

5.3.2 Measurement results for WCDMA

The corresponding detailed test procedure is described in 4.3.2. For the figure set of each case, the first figure demonstrates the EUT's instantaneous conducted TX power, the time-averaged conducted TX power behavior over time, and the power limit ($P_{reg_sub6_limit} = P_{sub6_limit} + 1\text{dB device uncertainty}$). The second figure illustrates the corresponding time-averaged SAR over time converted from the TX time-averaged power by using the equation listed in section 4.3.2. For all test cases, the time-averaged SAR does not exceed the FCC limit.

- Case4-1: WCDMA B2 result for test sequence 1

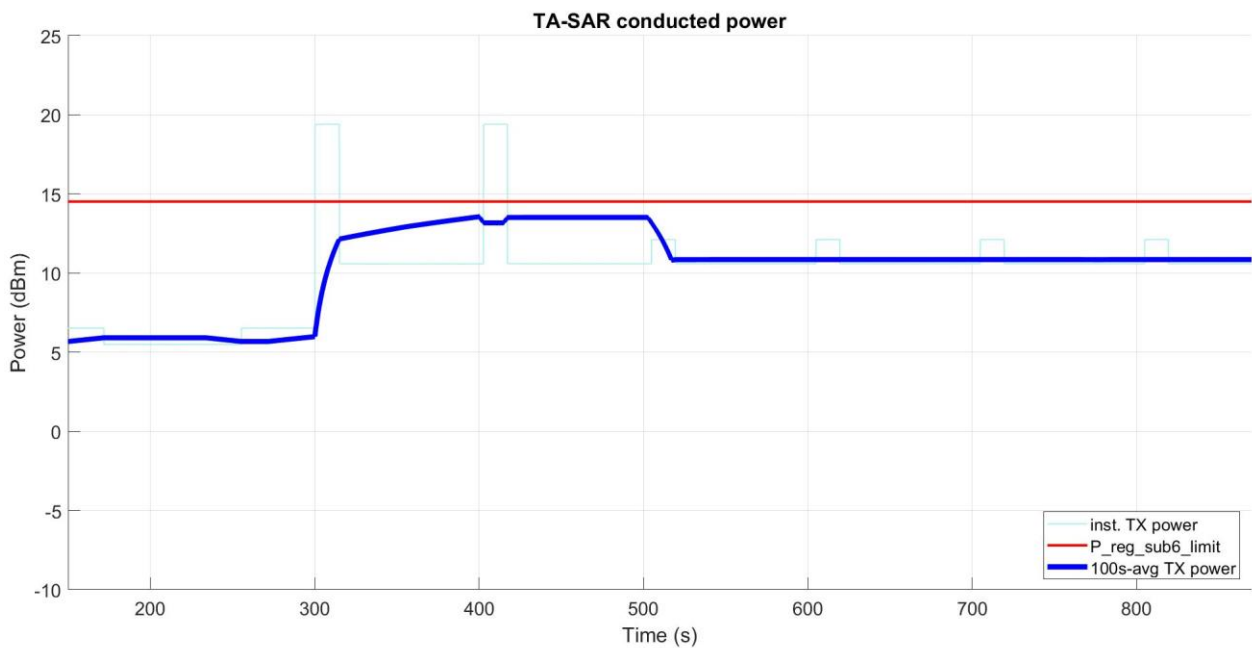

Figure 5- 15 Time-averaged conducted TX power over time

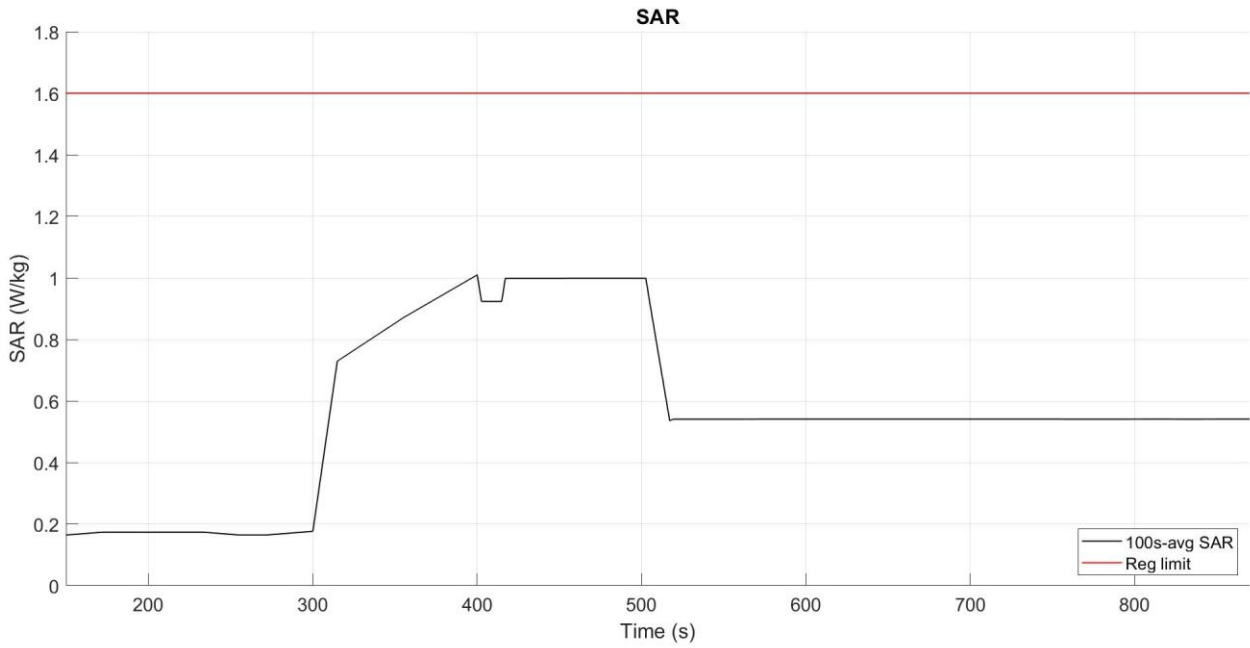

Figure 6- 16 Time-averaged SAR

FCC 1gSAR limit	1.6 W/kg
Max 100s-time averaged 1gSAR	1.010 W/kg
Validation result: pass	

● Case4-2: WCDMA B2 result for test sequence 2

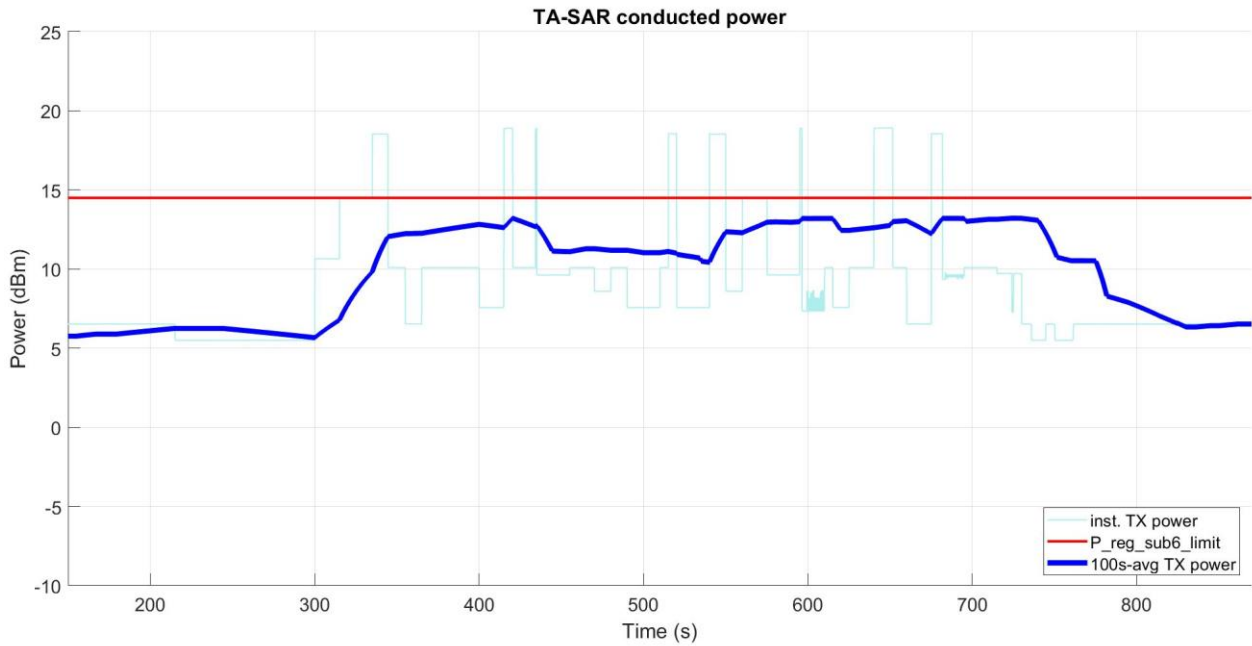

Figure 5- 28 Time-averaged conducted TX power over time

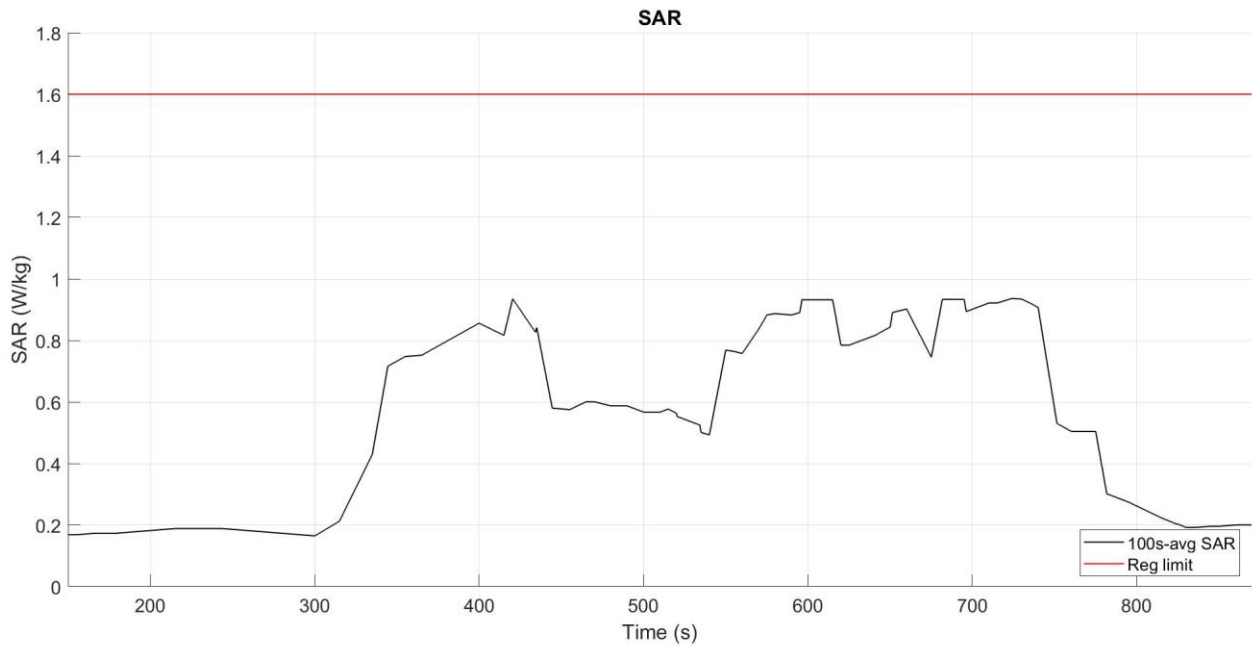

Figure 5- 17 Time-averaged SAR

FCC 1gSAR limit	1.6 W/kg
Max 100s-time averaged 1gSAR	0.936 W/kg
Validation result: pass	

● Case5-1: WCDMA B5 result for test sequence 1

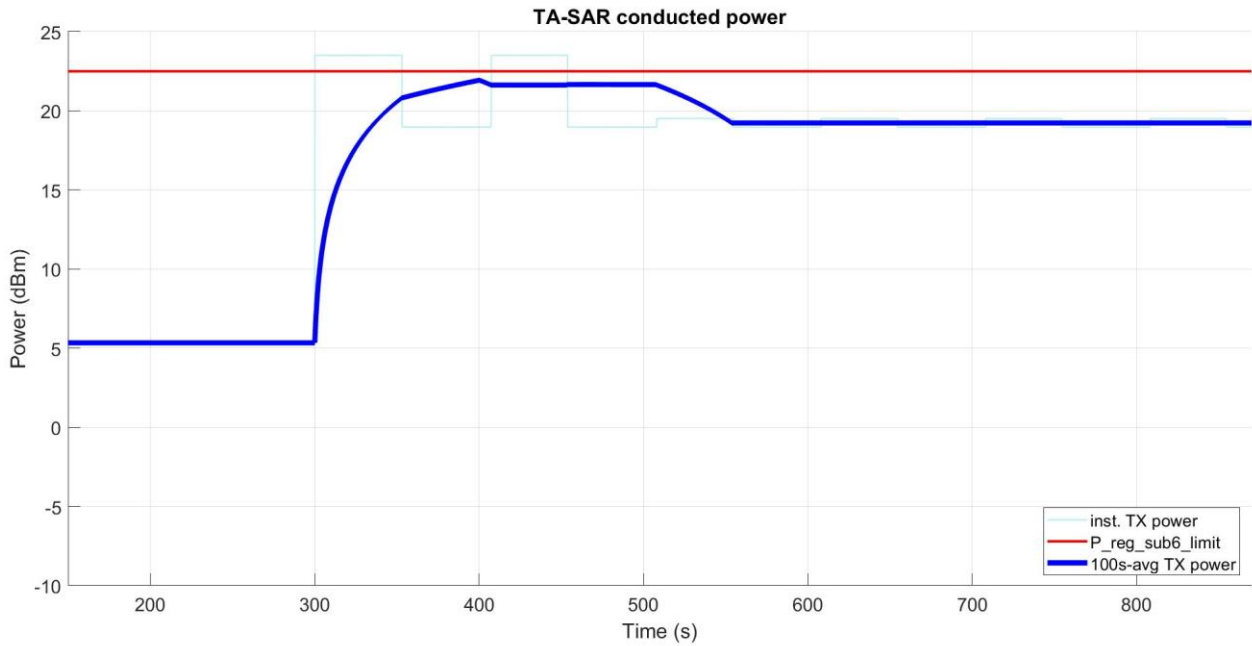

Figure 5- 18 Time-averaged conducted TX power over time

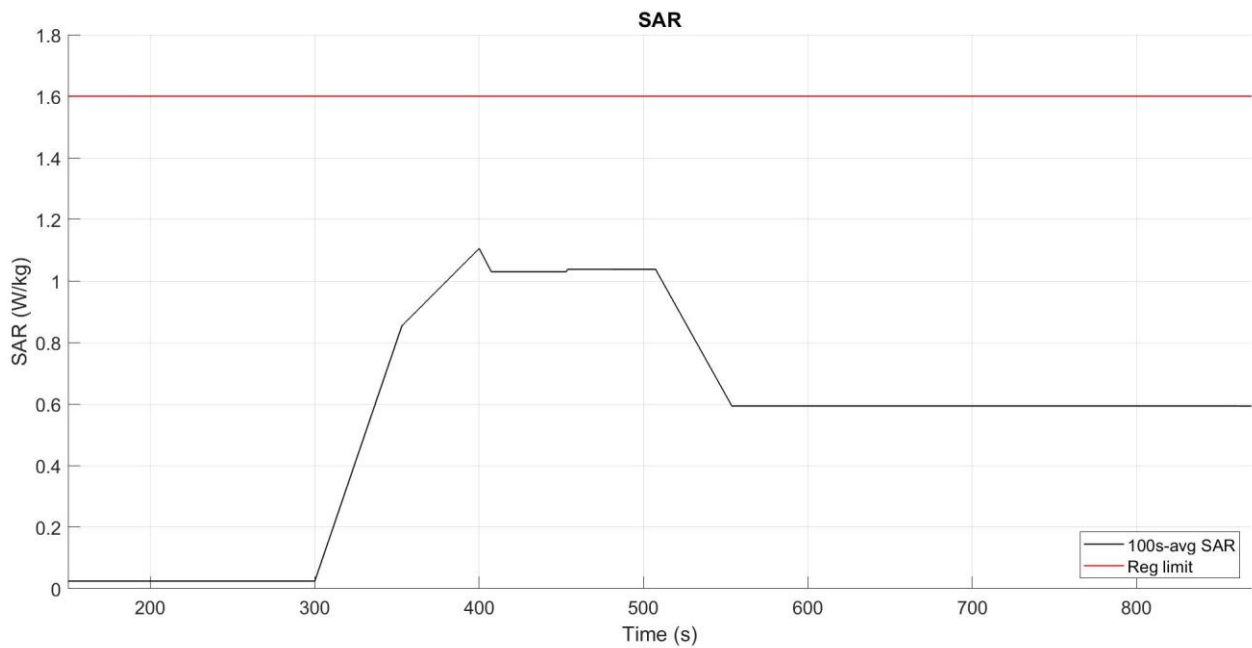

Figure 5- 19 Time-averaged SAR

FCC 1gSAR limit	1.6 W/kg
Max 100s-time averaged 1gSAR	1.105 W/kg
Validation result: pass	

● Case5-2: WCDMA B5 result for test sequence 2

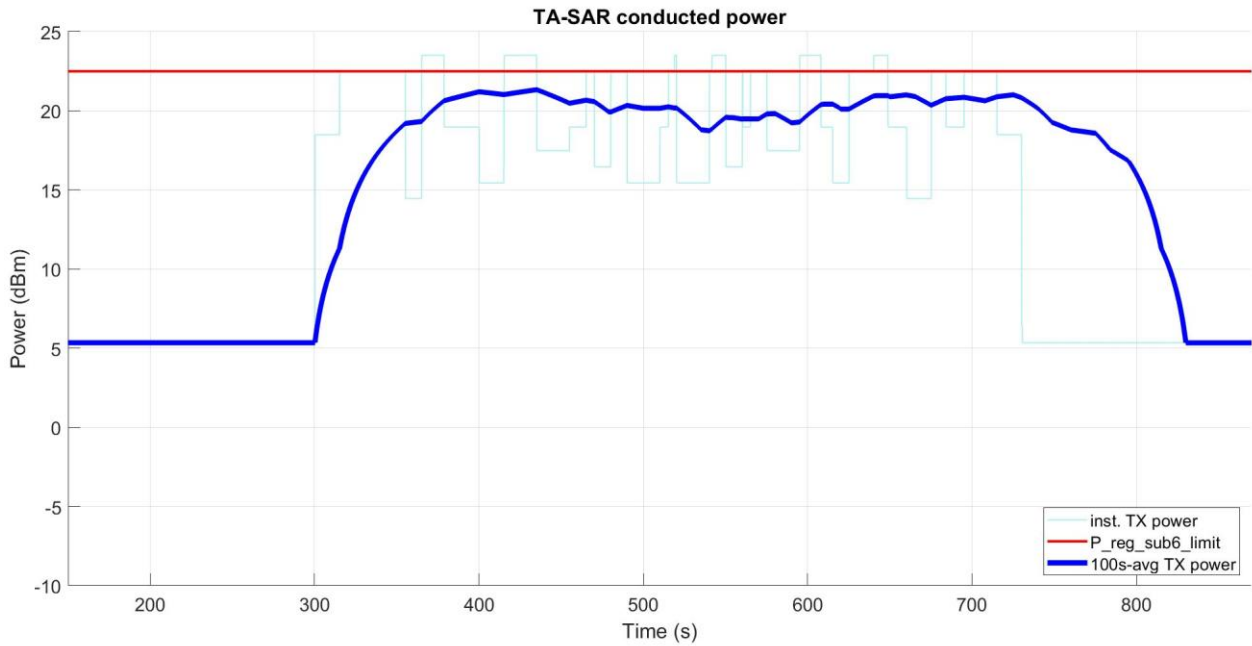

Figure 5- 20 Time-averaged conducted TX power over time

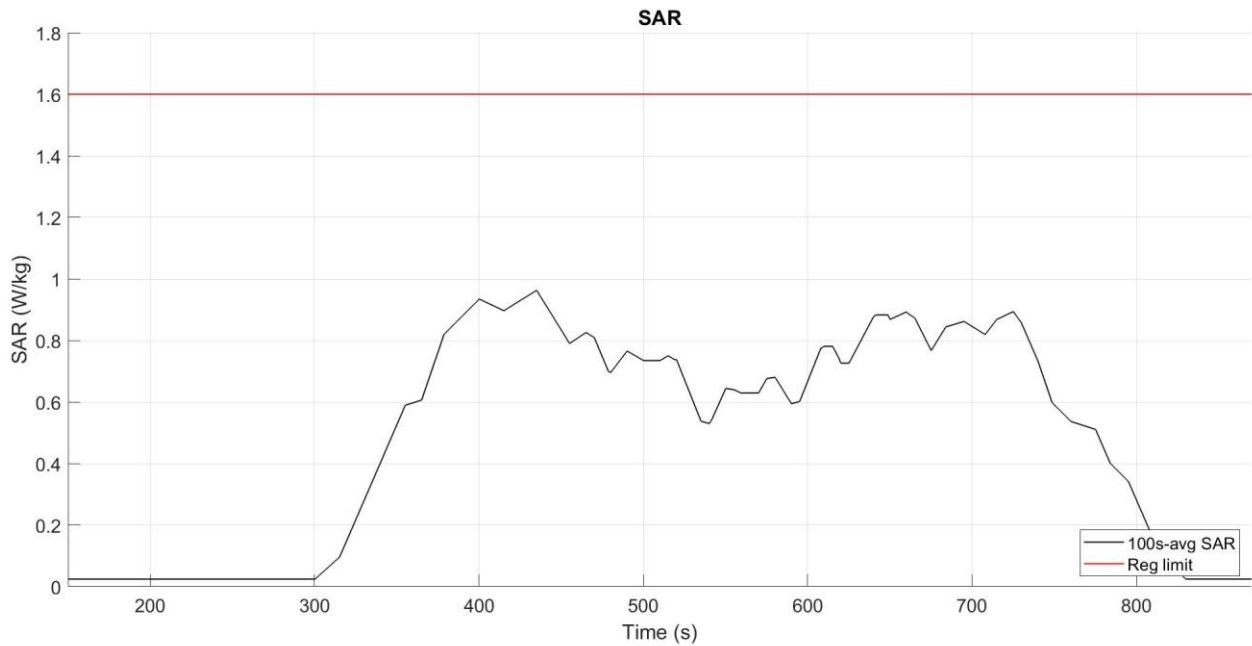

Figure 5- 21 Time-averaged SAR

FCC 1gSAR limit	1.6 W/kg
Max 100s-time averaged 1gSAR	0.963 W/kg
Validation result: pass	

5.3.3 Measurement results for LTE

The corresponding detailed test procedure is described in 4.3.2. For the figure set of each case, the first figure demonstrates the EUT's instantaneous conducted TX power, the time-averaged conducted TX power behavior over time, and the power limit ($P_{reg_sub6_limit} = P_{sub6_limit} + 1\text{dB device uncertainty}$). The second figure illustrates the corresponding time-averaged SAR over time converted from the TX time-averaged power by using the equation listed in section 4.3.2. For all test cases, the time-averaged SAR does not exceed the FCC limit.

- Case6-1: LTE B7 result for test sequence 1

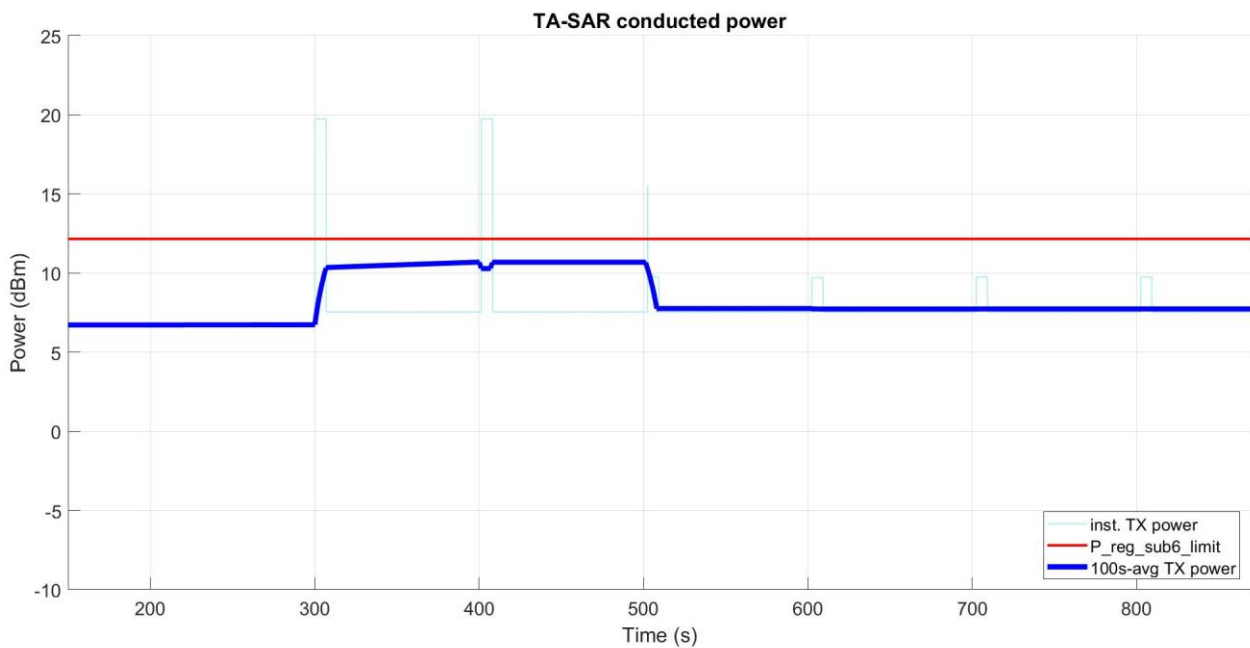

Figure 5- 22 Time-averaged conducted TX power over time

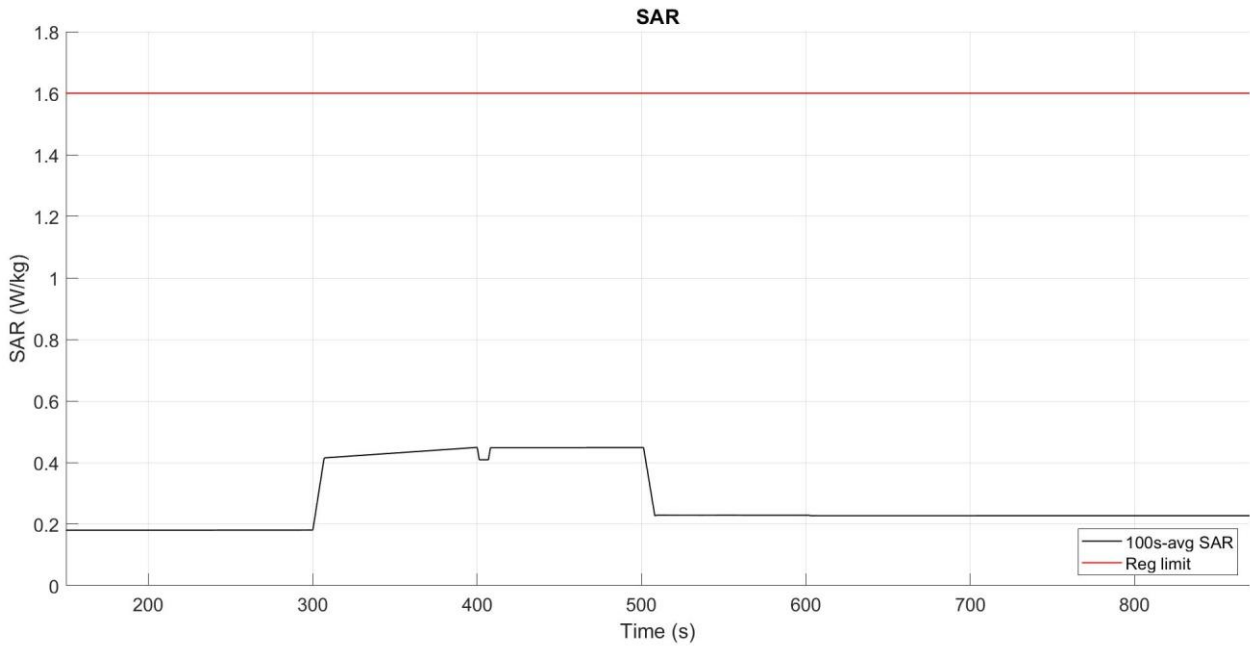

Figure 5- 23 Time-averaged SAR

FCC 1gSAR limit	1.6 W/kg
Max 60s-time averaged 1gSAR	0.449 W/kg
Validation result: pass	

● Case6-2: LTE B7 result for test sequence 2

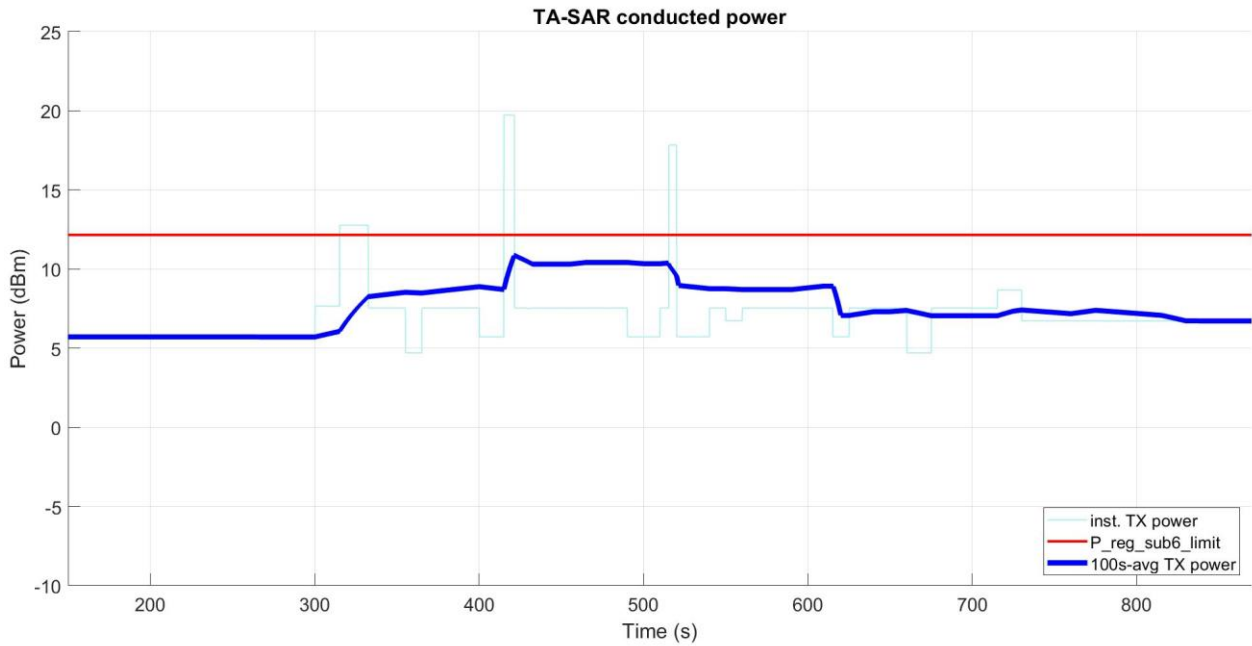

Figure 5- 20 Time-averaged conducted TX power over time

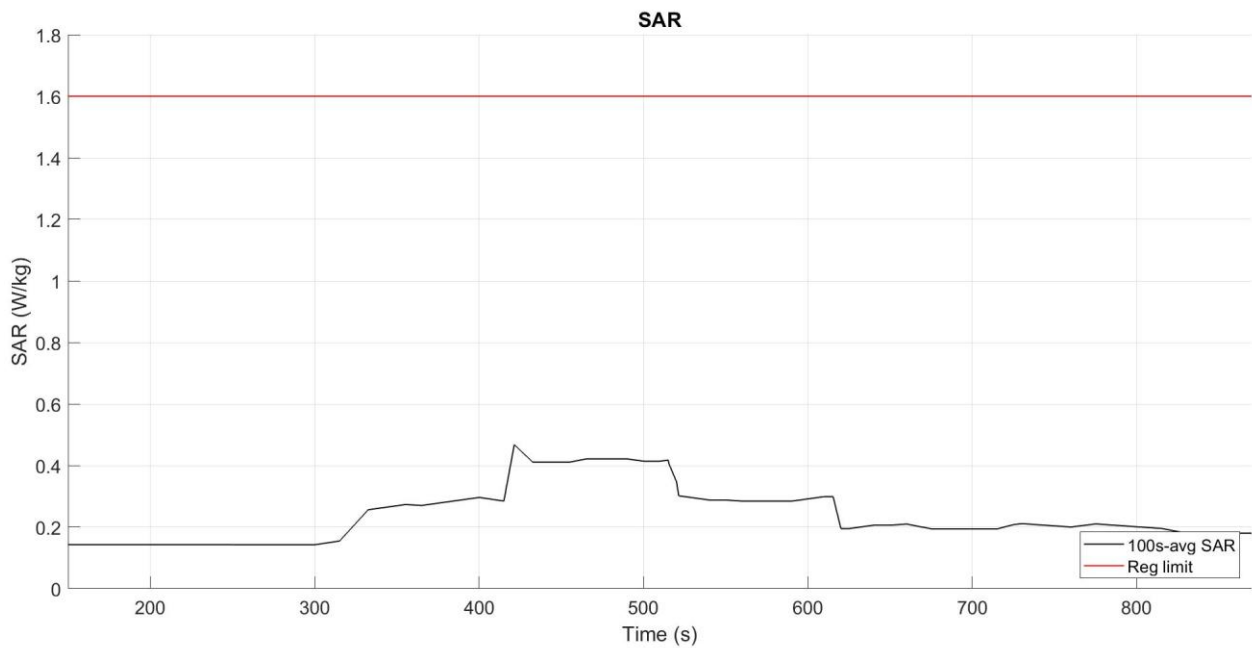

Figure 5- 24 Time-averaged SAR

FCC 1gSAR limit	1.6 W/kg
Max 60s-time averaged 1gSAR	0.467 W/kg
Validation result: pass	

● Case7-1: LTE B26 result for test sequence 1

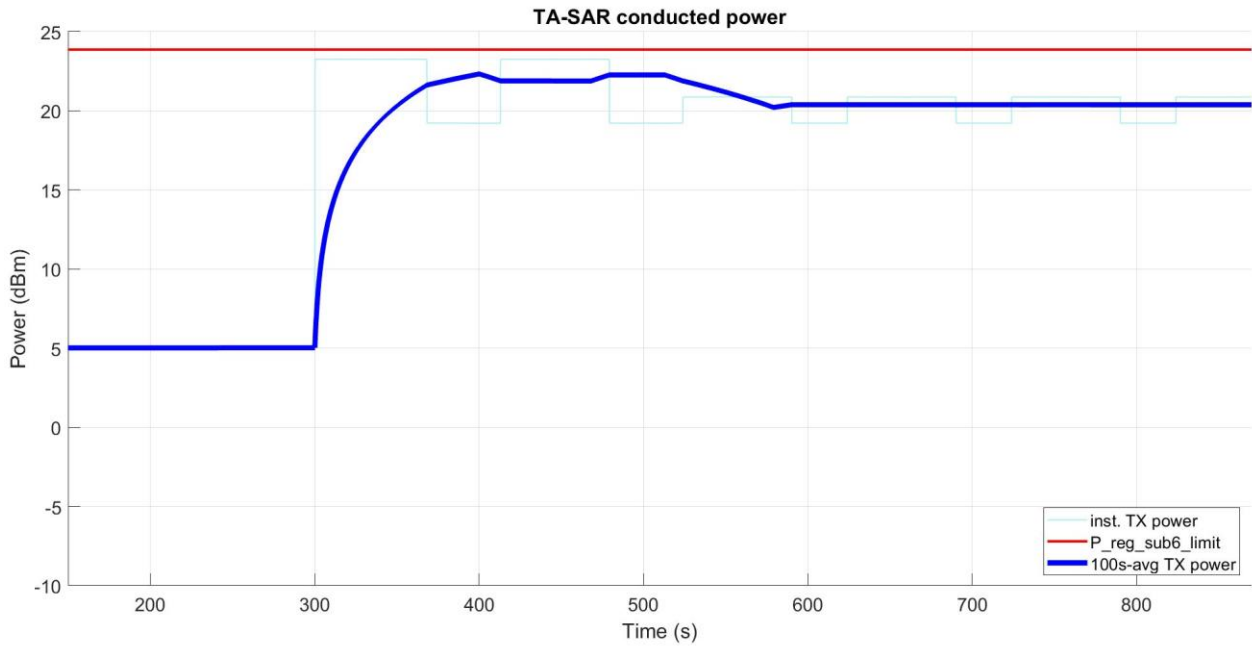

Figure 5- 25 Time-averaged conducted TX power over time

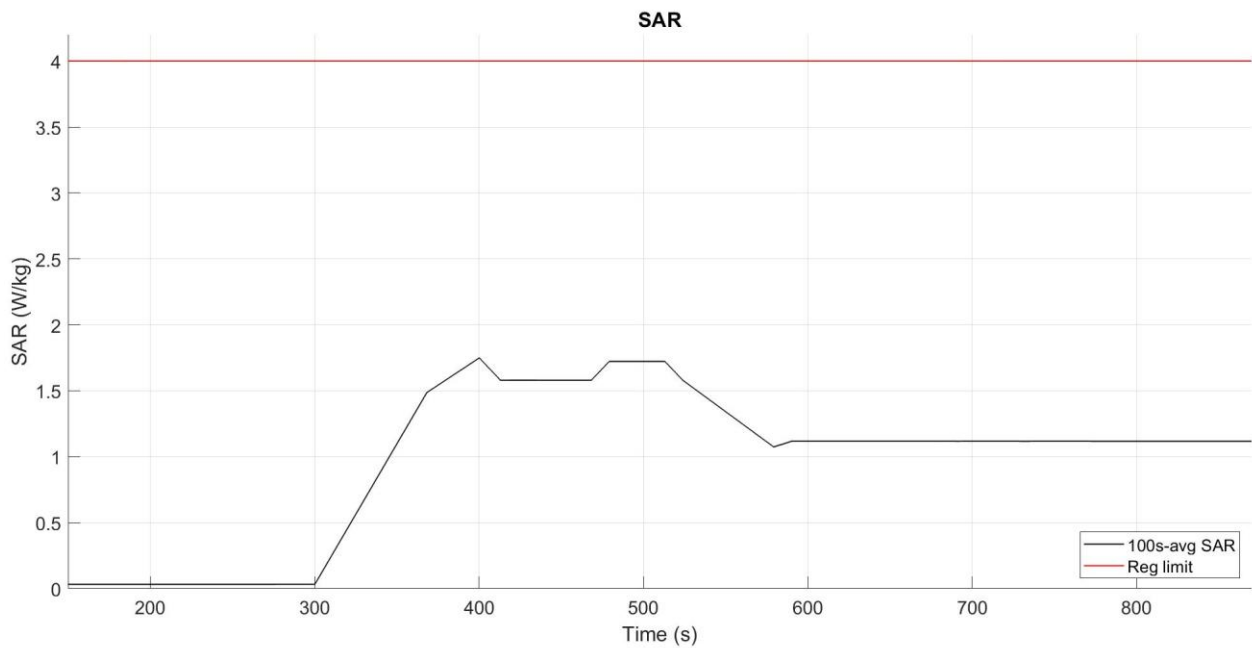

Figure 5- 26 Time-averaged SAR

FCC 10gSAR limit	4.0 W/kg
Max 100s-time averaged 10gSAR	1.749 W/kg
Validation result: pass	

● Case7-2: LTE B26 result for test sequence 2

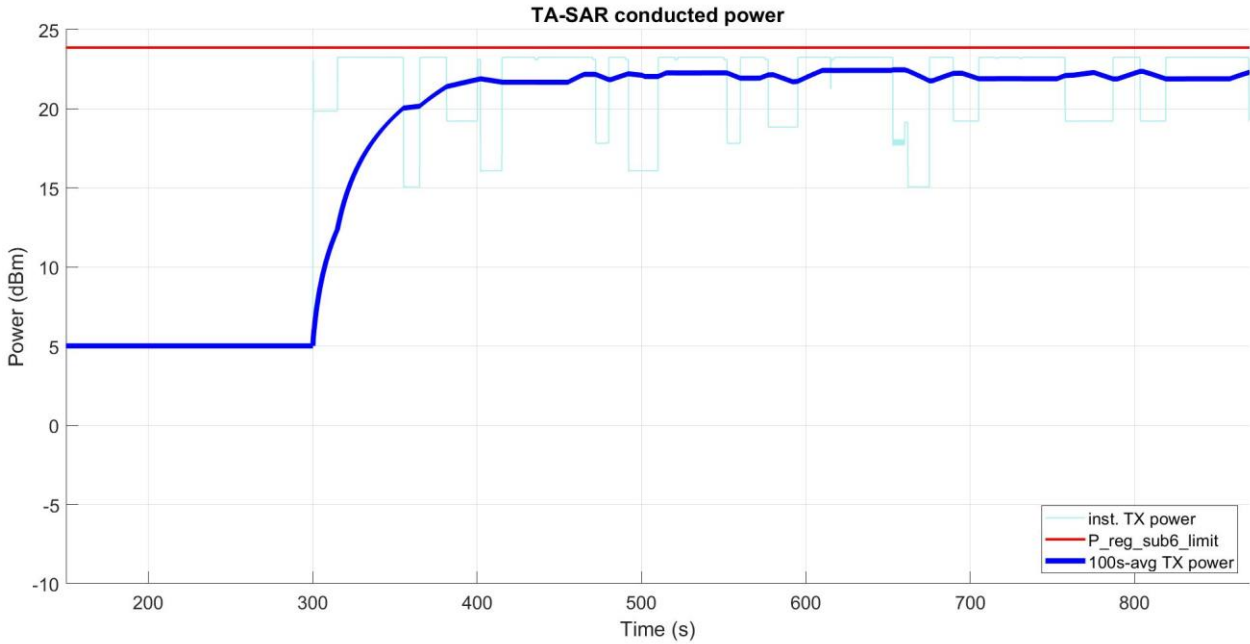

Figure 5- 27 Time-averaged conducted TX power over time

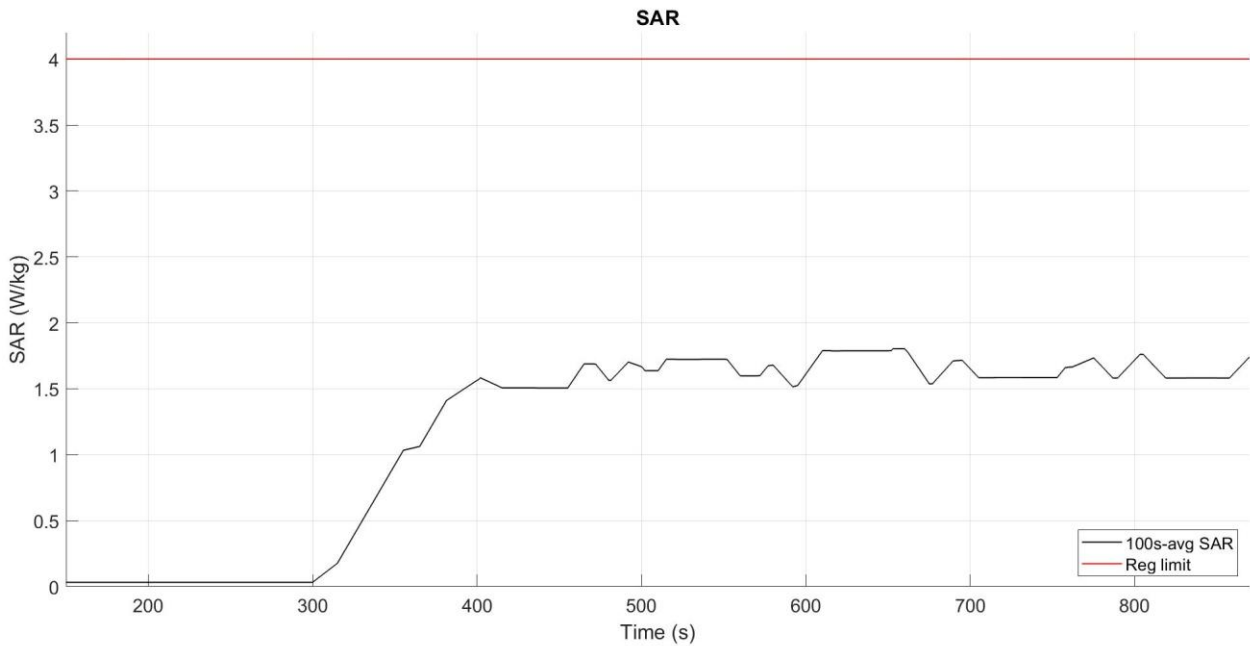

Figure 5- 28 Time-averaged SAR

FCC 10gSAR limit	4.0 W/kg
Max 100s-time averaged 10gSAR	1.804 W/kg
Validation result: pass	

5.3.4 Measurement results for NR

The corresponding detailed test procedure is described in 4.3.2. For the figure set of each case, the first figure demonstrates the EUT's instantaneous conducted TX power, the time-averaged conducted TX power behavior over time, and the power limit ($P_{reg_sub6_limit} = P_{sub6_limit} + 1\text{dB device uncertainty}$). The second figure illustrates the corresponding time-averaged SAR over time converted from the TX time-averaged power by using the equation listed in section 4.3.2. For all test cases, the time-averaged SAR does not exceed the FCC limit.

- **Case8-1: NR n41 result for test sequence 1**

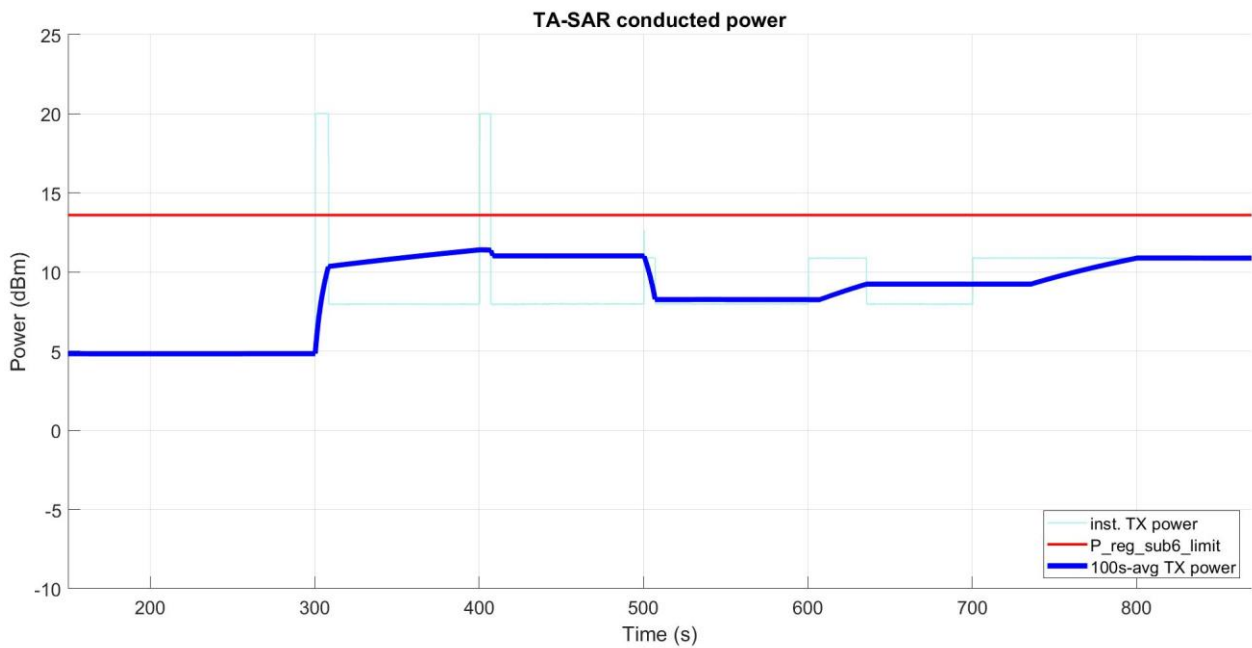

Figure 5- 29 Time-averaged conducted TX power over time

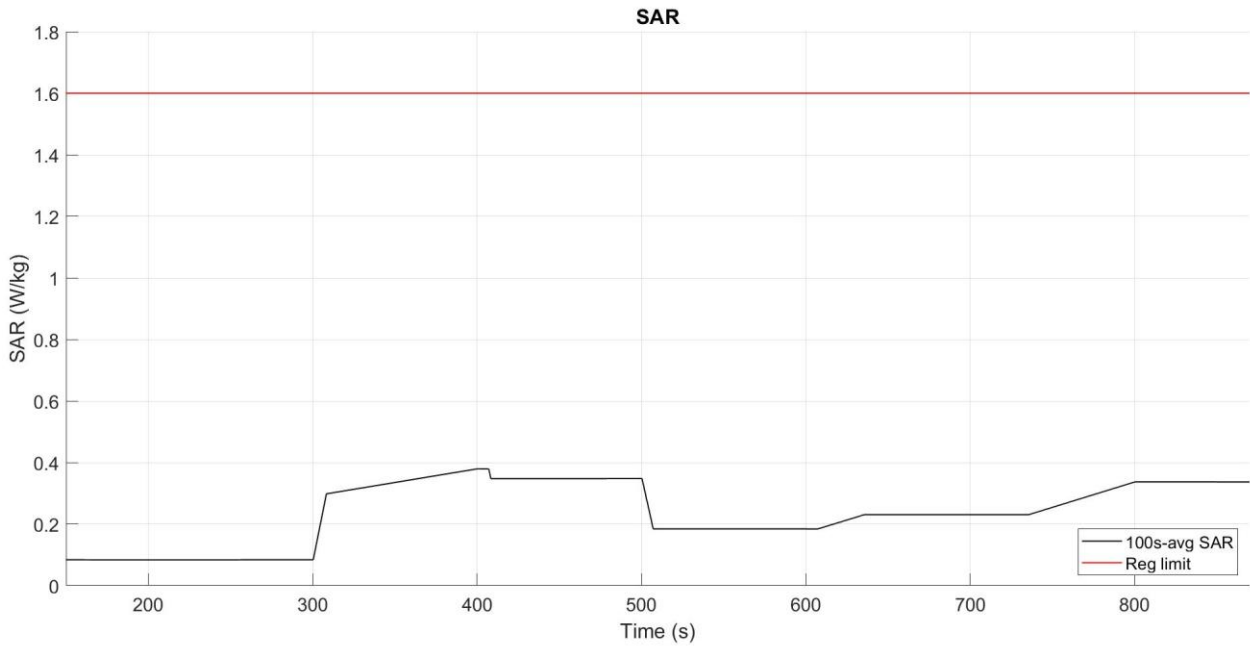

Figure 5- 30 Time-averaged SAR

FCC 1gSAR limit	1.6 W/kg
Max 60s-time averaged 1gSAR	0.380 W/kg
Validation result: pass	

● Case8-2: NR n41 result for test sequence 2

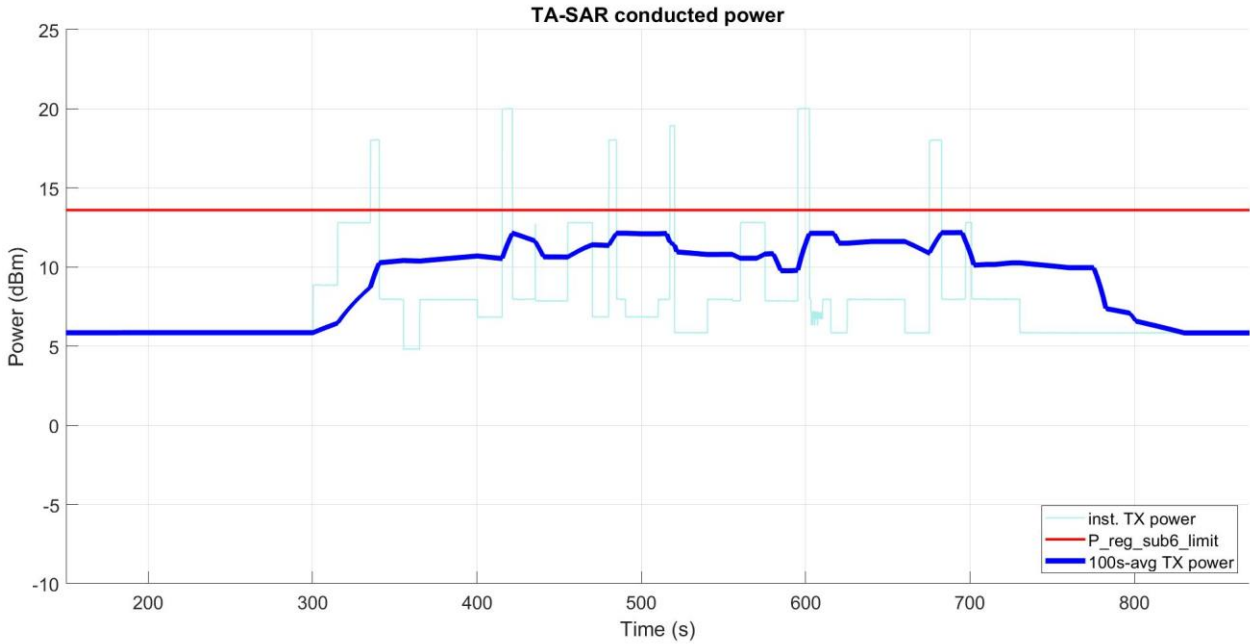

Figure 5- 31 Time-averaged conducted TX power over time

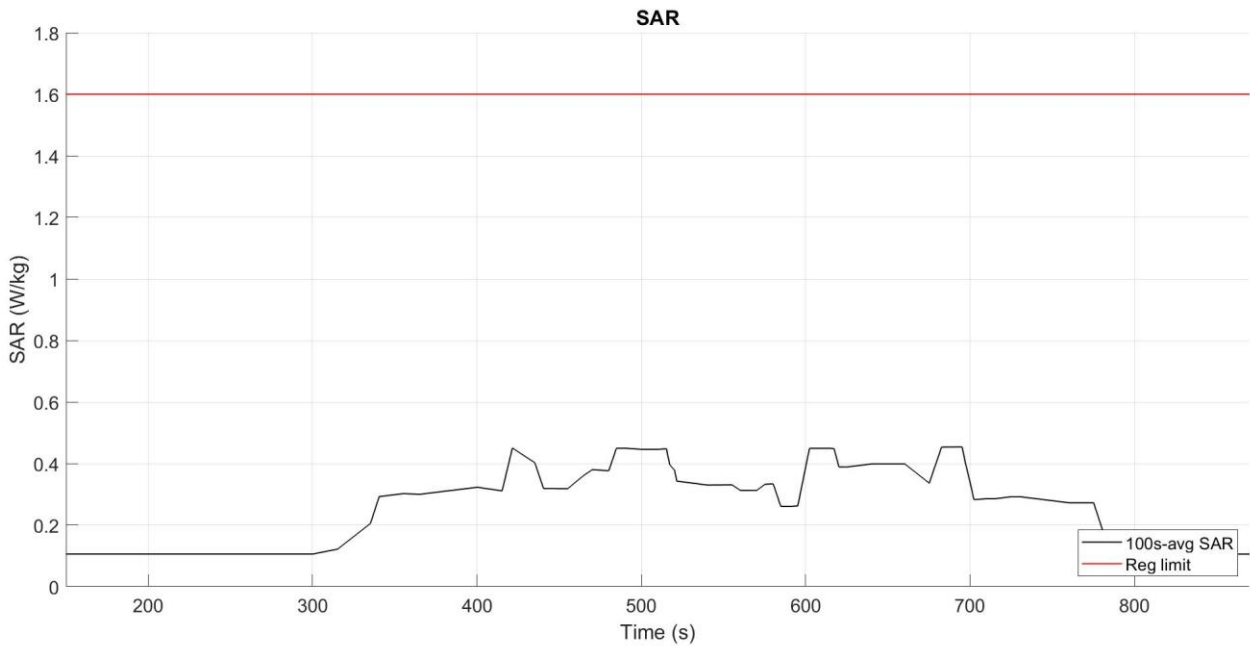

Figure 5- 32 Time-averaged SAR

FCC 1gSAR limit	1.6 W/kg
Max 60s-time averaged 1gSAR	0.454 W/kg
Validation result: pass	

- Case9-1 in table 6-3: NR n26 result for test sequence 1

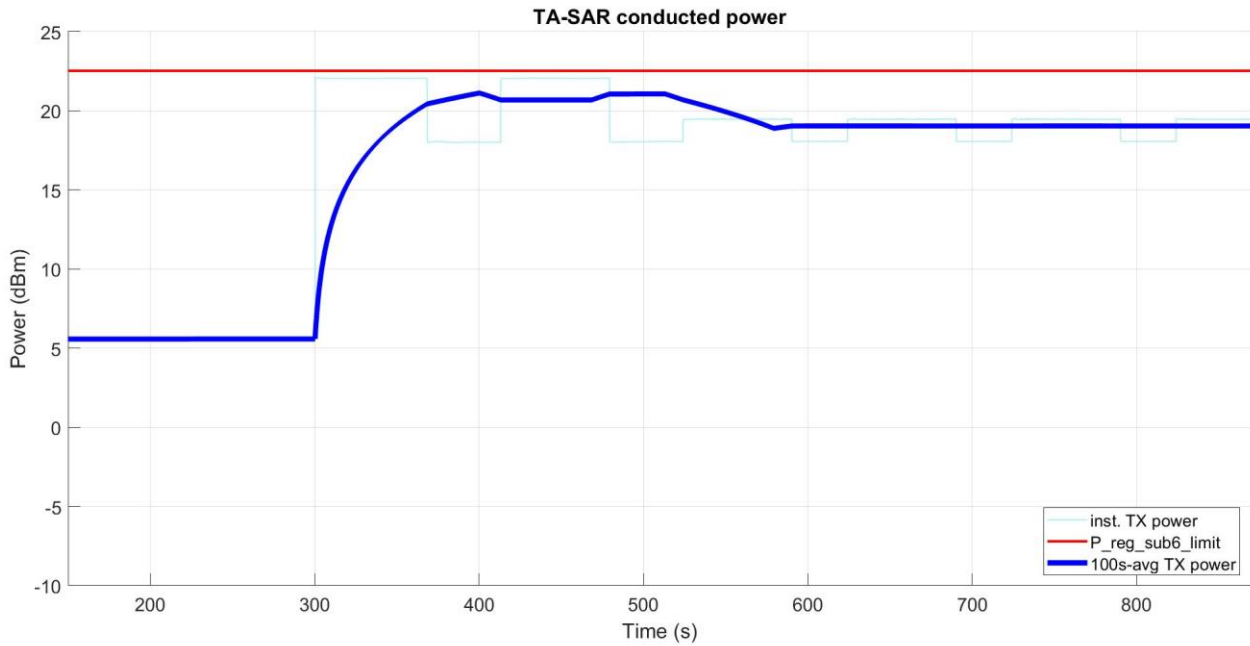

Figure 5- 33 Time-averaged conducted TX power over time

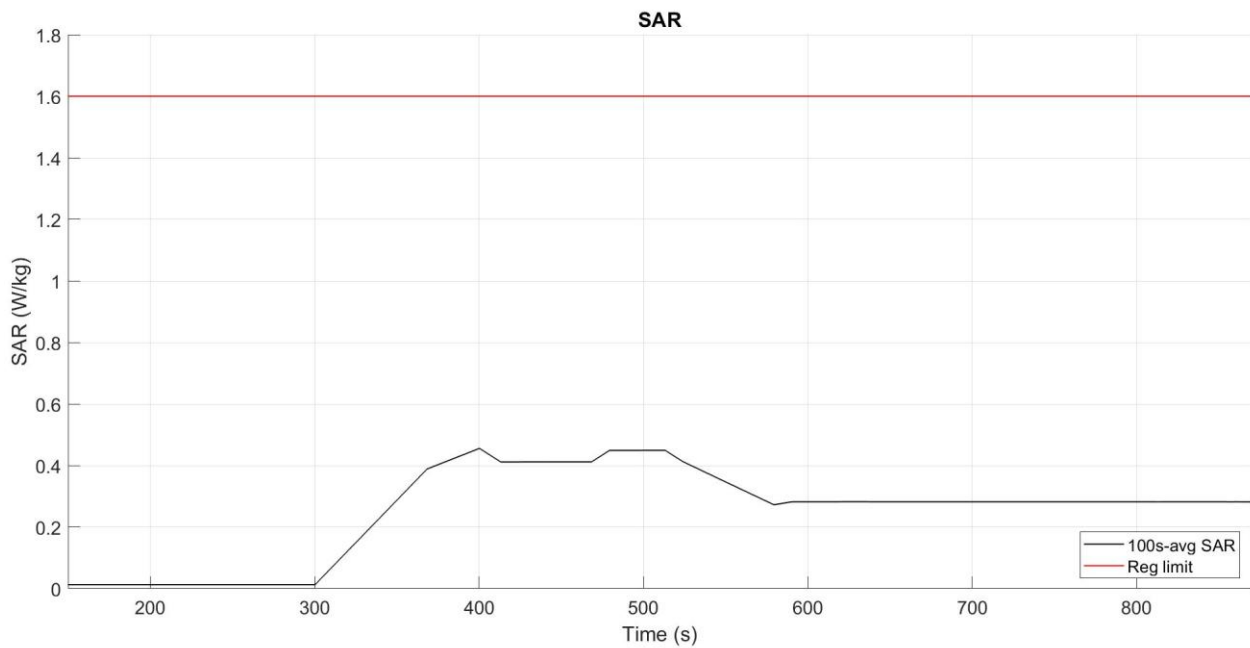

Figure 5- 34 Time-averaged SAR

FCC 1gSAR limit	1.6 W/kg
Max 60s-time averaged 1gSAR	0.455 W/kg
Validation result: pass	

● Case9-2: NR n26 result for test sequence 2

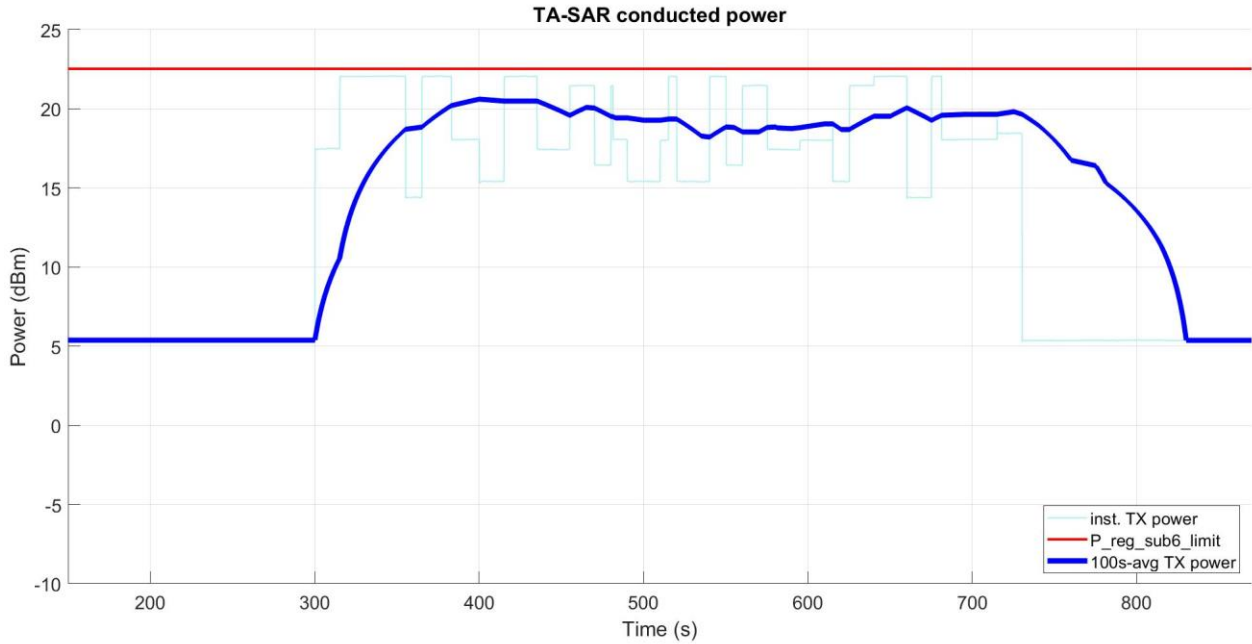

Figure 5- 35 Time-averaged conducted TX power over time

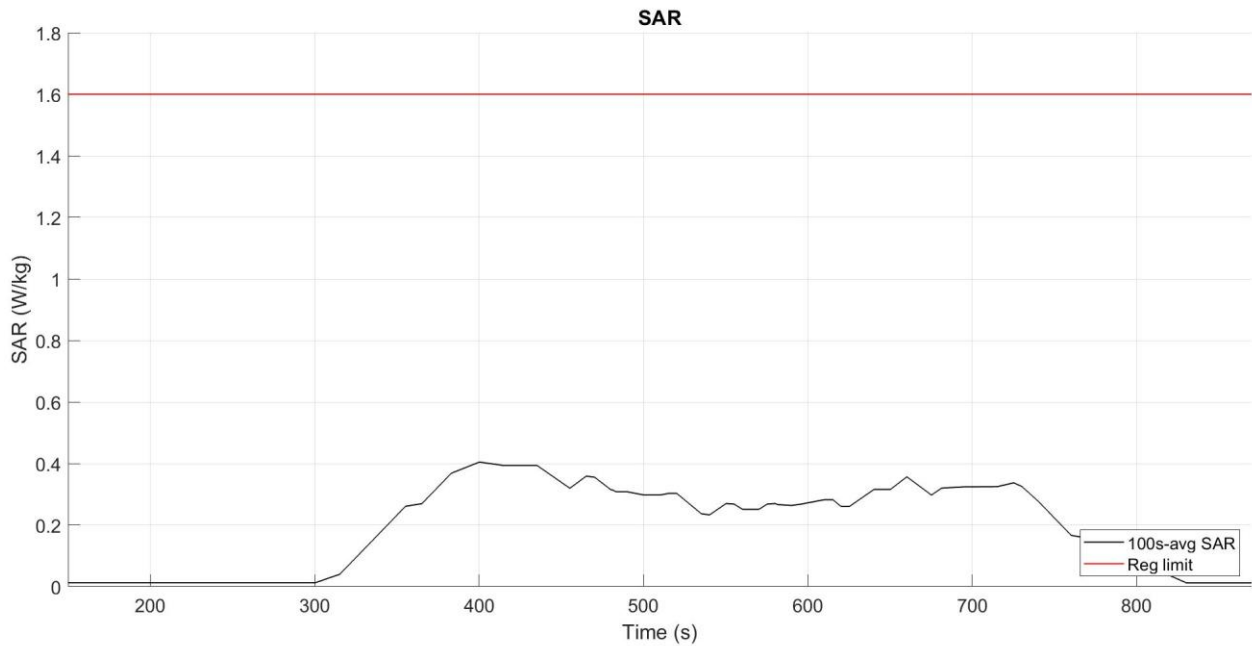

Figure 5- 36 Time-averaged SAR

FCC 1gSAR limit	1.6 W/kg
Max 100s-time averaged 1gSAR	0.405 W/kg
Validation result: pass	

5.4 Conducted Power Measurement Results for Scenario 3: Call Disconnection and Re-establishment

In this scenario, the test power sequence #0 (i.e., maximum TX power is requested by a call box for each RAT) is used, and the call drop is manually configured for a pre-defined period and then the call is re-established to continue data transmission. The test case for this scenario is relegated in Table 6-3, and the test procedure follows section 4.4.2. The measurement setup is shown in Figure 5-2. The high-level summary of the final validation results is also listed in the last column of the table, which concludes that Mediatek’s TA-SAR algorithm can maintain the time-averaged SAR is always below the FCC requirement. The following section will demonstrate how Mediatek’s TA-SAR algorithm behaves.

The corresponding detailed test procedure is described in 4.4.2. Figure 5-42 demonstrates the EUT’s instantaneous conducted TX power, the time-averaged conducted TX power behavior over time, and the power limit ($P_{reg_sub6_limit} = P_{sub6_limit} + 1dB$ device uncertainty). Figure 5-43 illustrates the corresponding time-averaged SAR over time converted from the TX time-averaged power by using the equation listed in section 4.4.2. As seen in this figure, the time-averaged SAR does not exceed the FCC limit.

- **Case10: LTE B7 call drop happens at the time instance of 500 seconds.**

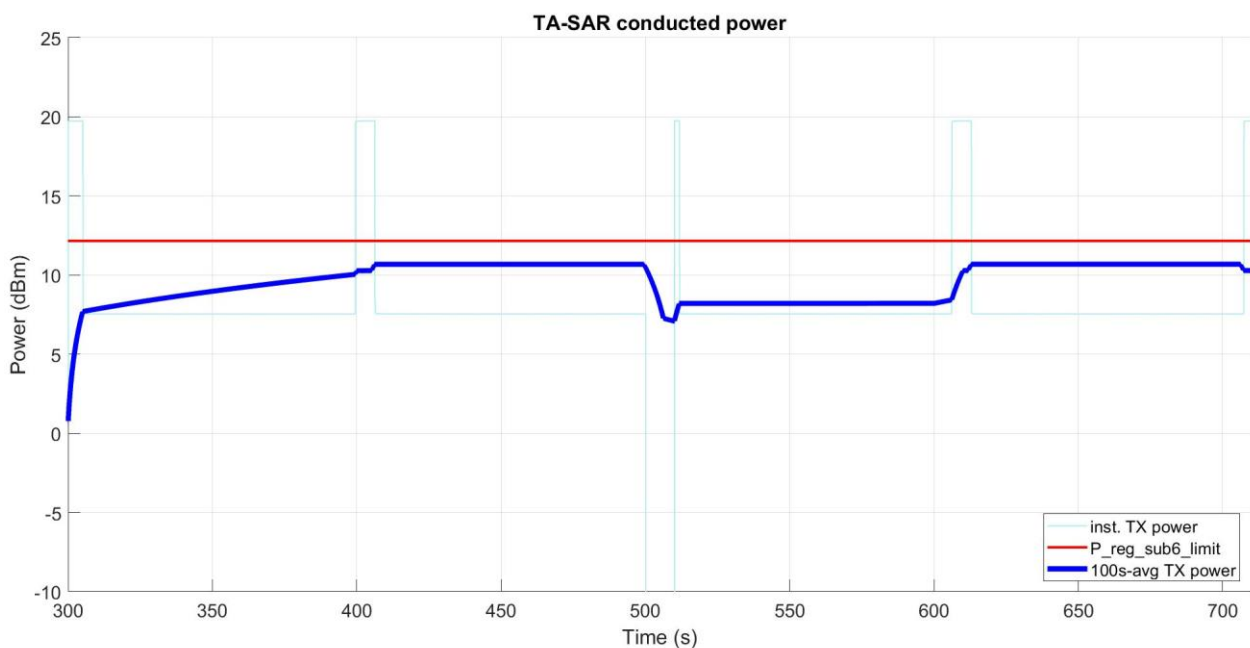

Figure 5- 42 Time-averaged conducted TX power over time

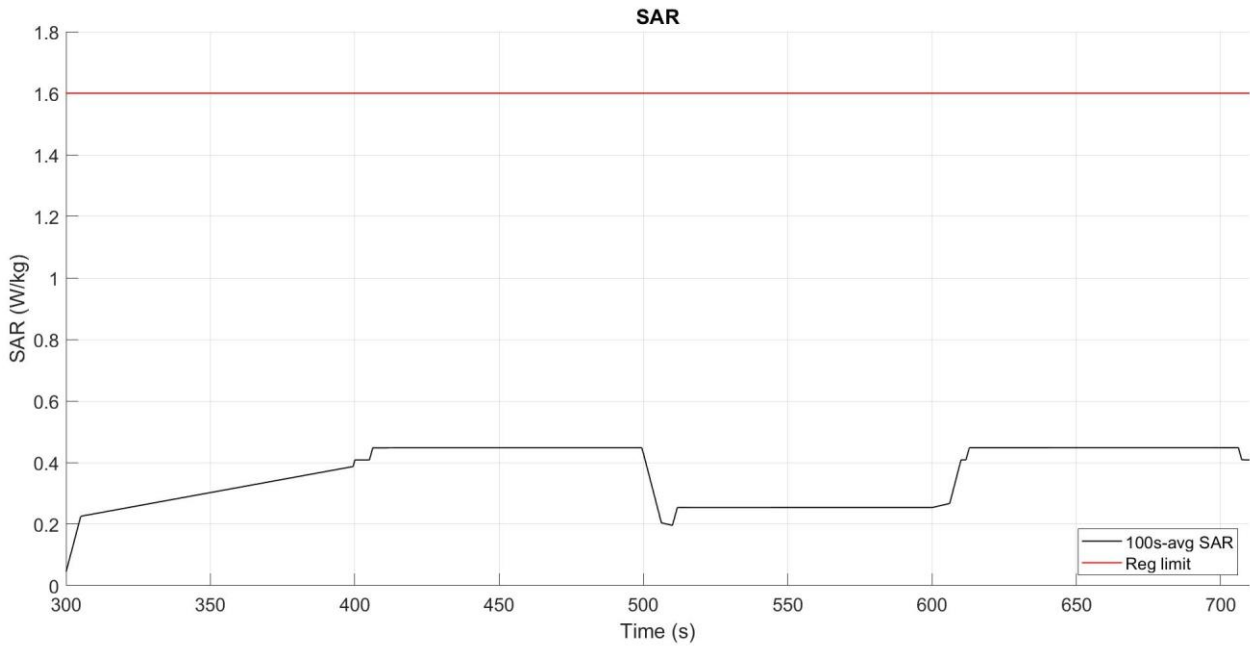

Figure 5- 37 Time-averaged SAR

FCC 1gSAR limit	1.6 W/kg
Max 60s-time averaged 1gSAR	0.448 W/kg
Validation result: pass	

5.5 Conducted Power Measurement Results for Scenario Band Handover

In this scenario, the test power sequence #0 (i.e., maximum TX power is requested by a call box for each RAT) is used, and band (and RAT) handover is manually configured at a specific time instance. The test case widely cover handover scenarios between two RATs. The test case for this scenario is relegated in Table 6-3, and the test procedure follows section 4.5.2. The measurement setup is shown in Figure 5-3 (band handover) and Figure 5-5 (RAT handover). The high-level summary of the final validation results is also listed in the last column of the table, which concludes that Mediatek’s TA-SAR algorithm can maintain the time-averaged SAR is always below the FCC requirement. The following section will demonstrate how Mediatek’s TA-SAR algorithm behaves.

The corresponding detailed test procedure is described in 4.5.2. The first figure demonstrates the EUT’s instantaneous conducted TX power and the time-averaged conducted TX power behavior over time, and the power limit ($P_{reg_sub6_limit} = P_{sub6_limit} + 1\text{dB device uncertainty}$). The handover is configured at the time instance of 500 seconds. It is observed in the figure that the time-averaged TX power of the individual RAT is below its own P_{sub6_limit} . The second figure illustrates the corresponding time-averaged normalized SAR over time converted from the TX time-averaged power by using the equation listed in section 4.5.2. The figure shows that the time-averaged normalized SAR does not exceed the normalized FCC limit of 1.

- **Case11: band handover happens at the time instance of 500 seconds.**

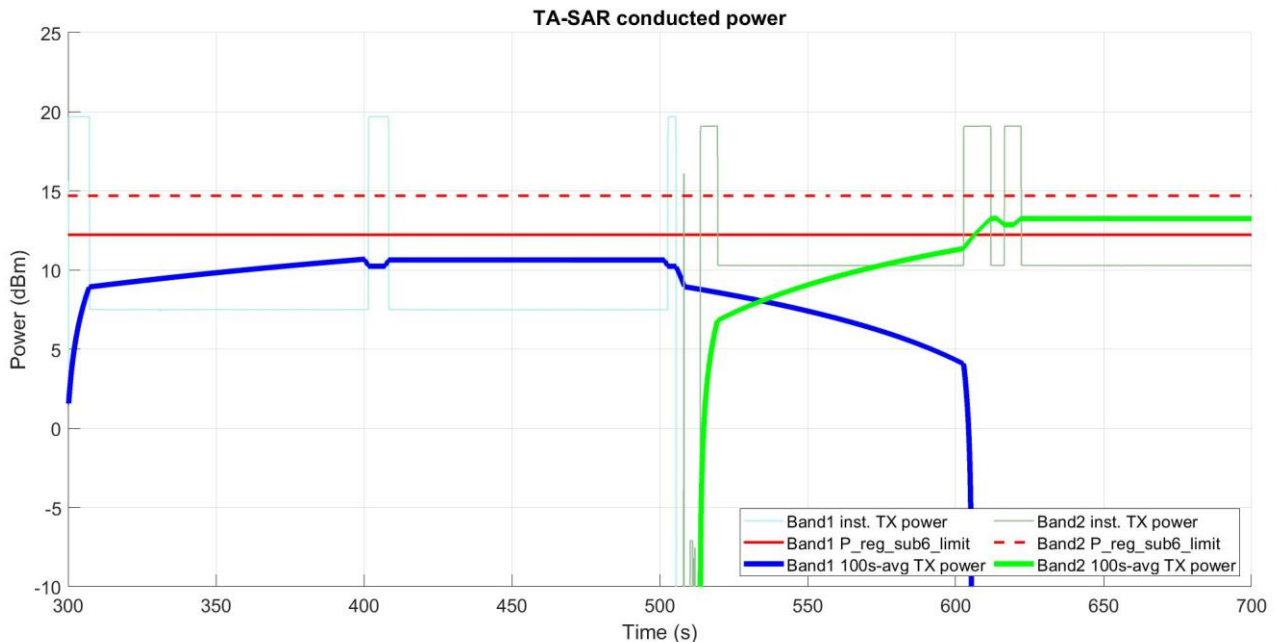

Figure 5- 38 Time-averaged conducted TX power over time

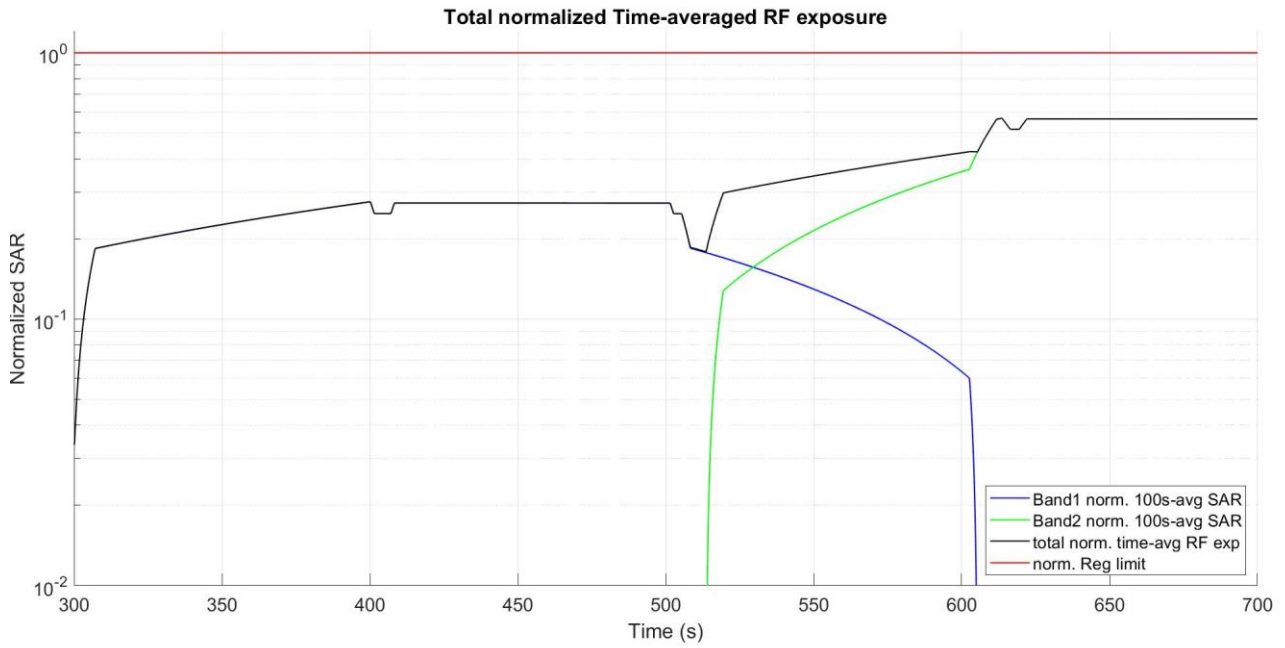

Figure 5- 39 Normalized time-averaged SAR

FCC limit of total RF exposure (normalized)	1.0
Max total normalized time-averaged RF exposure	0.568
Validation result: pass	

5.6 Conducted Power Measurement Results for Scenario 5: ECI Change

In this scenario, the test power sequence #0 (i.e., maximum TX power is requested by a call box for each RAT) is used, and ECI change at the EUT side is manually configured at a specific time instance. The test case cover ECI switching scenario between two ECIs. The test case for this scenario is relegated in Table 6-3, and the test procedure follows section 4.6.2. The measurement setup is shown in Figure 5-2. The high-level summary of the final validation results is also listed in the last column of the table, which concludes that Mediatek’s TA-SAR algorithm can maintain the time-averaged SAR is always below the FCC requirement. The following section will demonstrate how Mediatek’s TA-SAR algorithm behaves. The corresponding detailed test procedure is described in 4.6.2. The first figure demonstrates the EUT’s instantaneous conducted TX power and the time-averaged conducted TX power behavior over time, and the power limit ($P_{reg_sub6_limit} = P_{sub6_limit} + 1\text{dB device uncertainty}$). During the test period, there are two ECI change events configured individually at the time instances 500 seconds and 700 seconds. The 1st change is from ECI = 7 to ECI = 2 and the 2nd change is from ECI = 2 back to ECI = 7. It is observed in the figure that the time-averaged TX power of the individual RAT is below its own P_{sub6_limit} . The second figure illustrates the corresponding time-averaged normalized SAR over time converted from the TX time-averaged power by using the equation listed in section 4.6.2. The figure shows that the time-averaged normalized SAR does not exceed the normalized FCC limit of 1.

- **Case12: LTE B7 ECI7 changes to ECI2 happen at the time instances of 500 and 700 seconds, respectively**

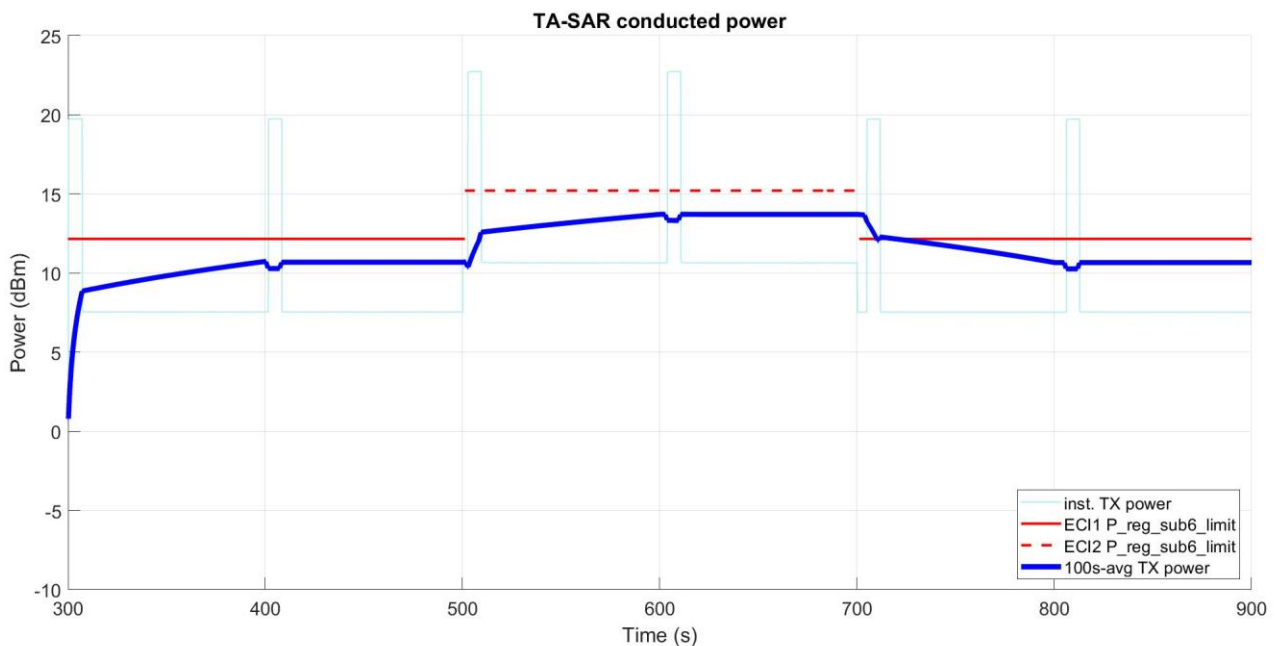

Figure 5- 40 Time-averaged conducted TX power over time

NOTE : The inst. TX power should be compared with $P_{reg_sub6_limit}$ of the corresponding configuration, i.e. 10.5 dBm for ECI 7 and 13.5 dBm for ECI 2, then transformed and averaged in SAR perspective to check compliance. Therefore, even though the time-averaged TX power seems to exceed $P_{reg_sub6_limit}$ after configuration changed (from 700s to 730s), the time-averaged SAR pass regulation as a matter of fact.

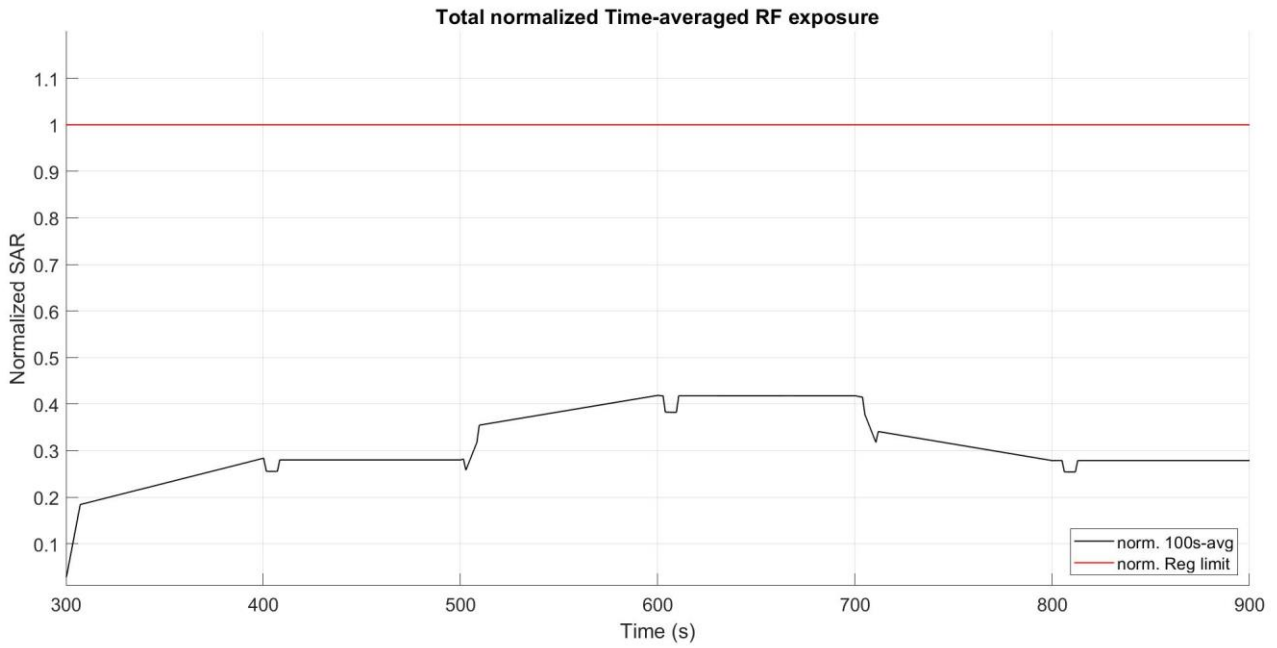

Figure 5- 41 Normalized time-averaged SAR

FCC limit of total RF exposure (normalized)	1.0
Max total normalized time-averaged RF exposure	0.419
Validation result: pass	

5.7 Conducted Power Measurement Results for Scenario 7: Time Window Switching

In this scenario, the test power sequence #0 (i.e., maximum TX power is requested by a call box for each RAT) is used, and band handover events within a RAT are manually configured at specific time instances. This scenario aims to validate the correctness of the TA-SAR algorithm with existence of moving average time window change. The two test cases for this scenario are relegated in Table 6-3, and the test procedure follows section 4.8.2. The measurement setup is shown in Figure 5-3. The high-level summary of the final validation results are also listed in the last column of the table, which concludes that Mediatek's TA-SAR algorithm can maintain the time-averaged SAR is always below the FCC requirement for all the cases. The following sections will demonstrate how Mediatek's TA-SAR algorithm behaves.

5.7.1 Measurement results for Time window switching 60s-100s-60

The corresponding detailed test procedure is described in 4.8.2. During the test period, there are two band handover events configured individually at the time instances 450 seconds and 620 seconds. The 1st handover is from B48 to B7 and the 2nd handover is from B7 back to B48. The first figure demonstrates the EUT's instantaneous conducted TX power and the time-averaged conducted TX power behavior over time, and the power limit ($P_{reg_sub6_limit} = P_{sub6_limit} + 1\text{dB device uncertainty}$). It is observed in the figure that the time-averaged TX power during the transitions of the band changes is maintained below the power limitation. The second figure illustrates the corresponding time-averaged normalized SAR over time converted from the TX time-averaged power by using the equation listed in section 4.8.2. The figure shows that the time-averaged normalized SAR does not exceed the normalized FCC limit of 1.

- Case13: LTE B48 handover to LTE B7 happens at the time instances of 450 and 620 seconds.

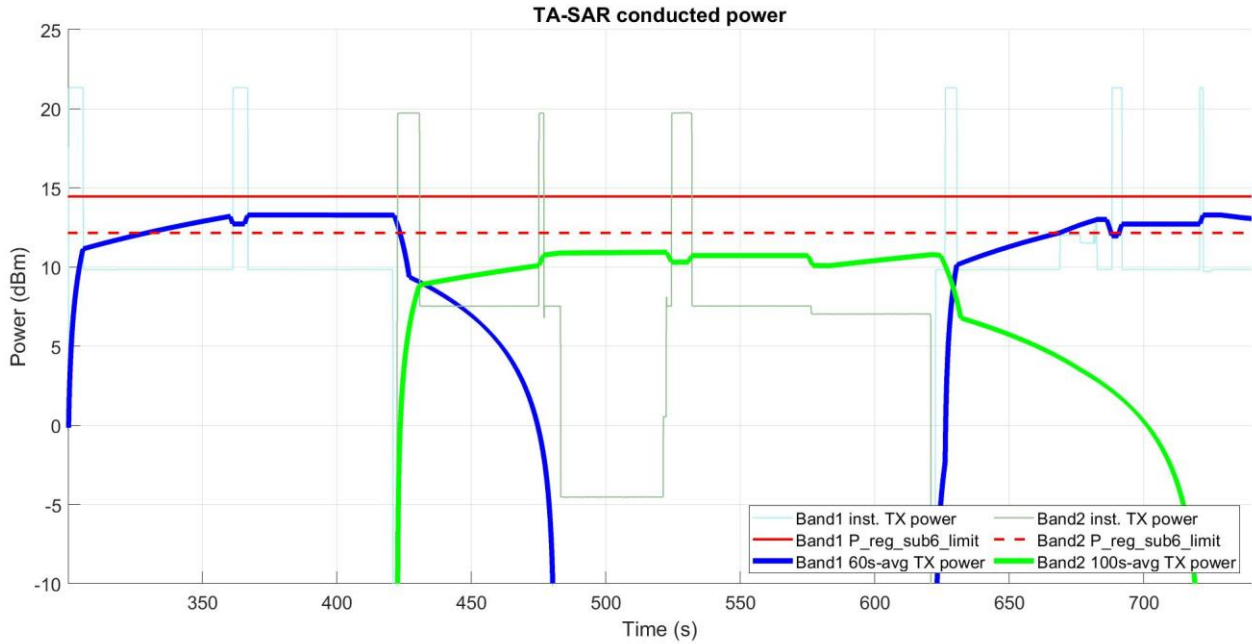

Figure 5- 42 Time-averaged conducted TX power over time

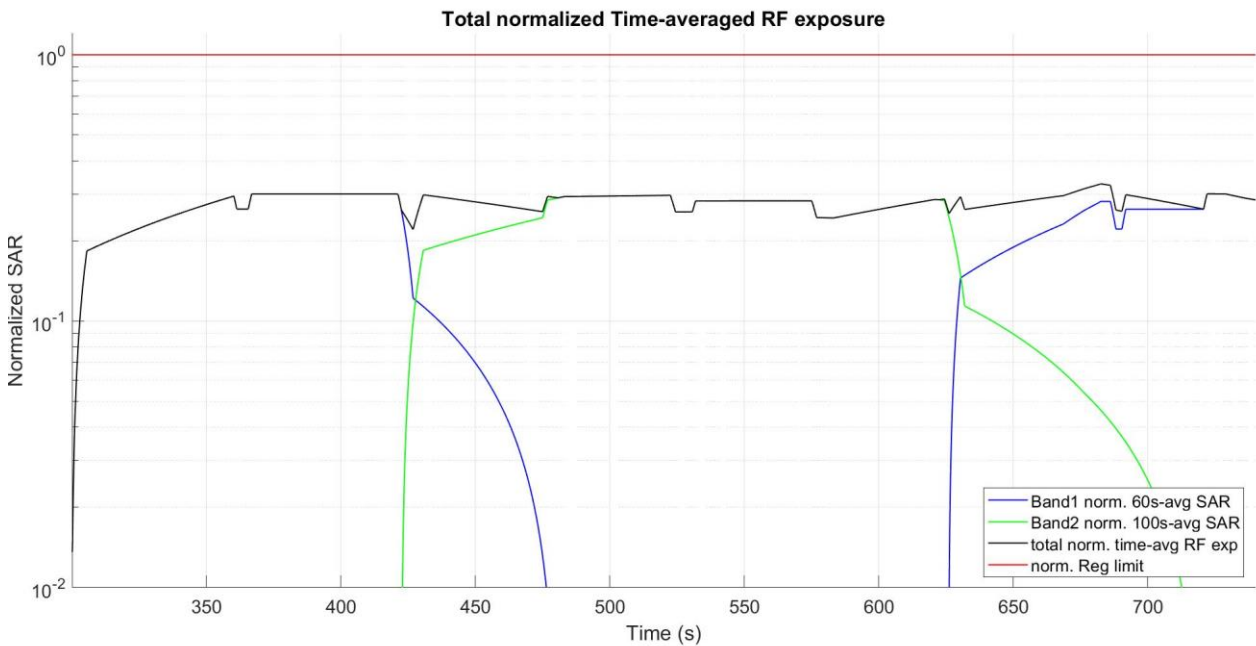

Figure 5- 43 Normalized time-averaged SAR

FCC limit of total RF exposure (normalized)	1.0
Max total normalized time-averaged RF exposure	0.328
Validation result: pass	

5.7.2 Measurement results for Time window switching 100s-60s-100s

The corresponding detailed test procedure is described in 4.8.2. During the test period, there are two band handover events configured individually at the time instances 500 seconds and 620 seconds. The 1st handover is from B7 to B48 and the 2nd handover is from B48 back to B7. The first figure demonstrates the EUT's instantaneous conducted TX power and the time-averaged conducted TX power behavior over time, and the power limit ($P_{reg_sub6_limit} = P_{sub6_limit} + 1\text{dB}$ device uncertainty). It is observed in the figure that the time-averaged TX power during the transitions of the band changes is maintained below the power limitation. The second figure illustrates the corresponding time-averaged normalized SAR over time converted from the TX time-averaged power by using the equation listed in section 4.8.2. The figure shows that the time-averaged normalized SAR does not exceed the normalized FCC limit of 1.

- **Case14: LTE B7 handover to LTE B48 happens at the time instances of 500 and 620 seconds.**

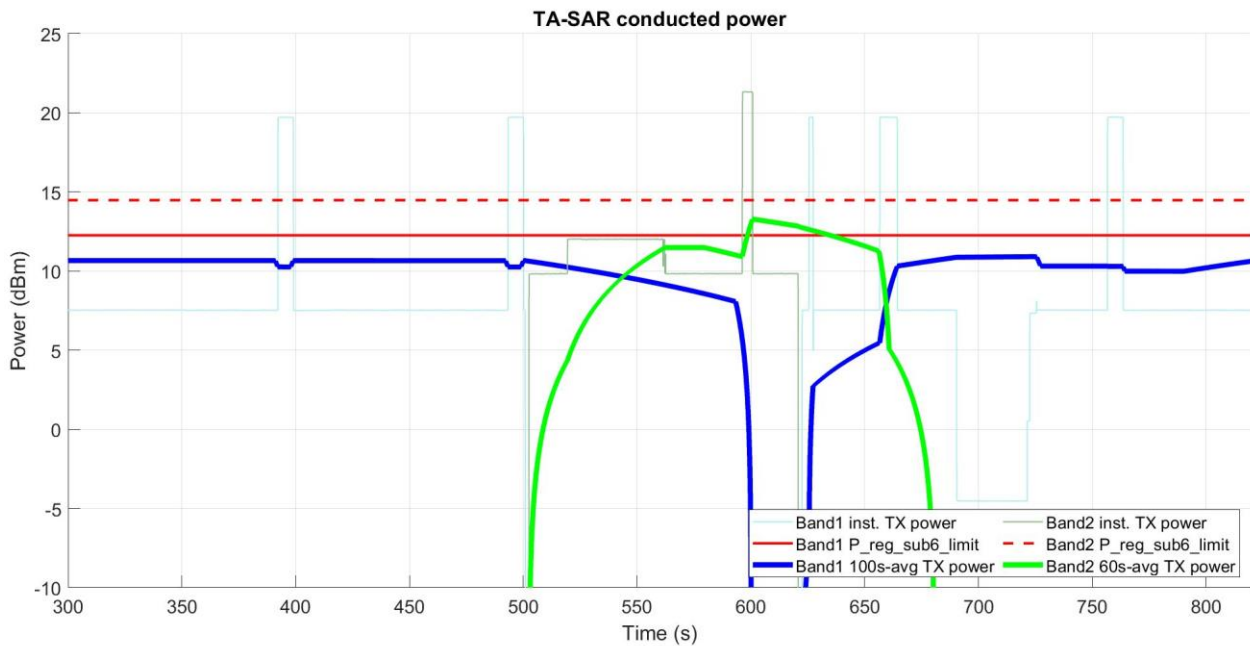

Figure 5- 44 Time-averaged conducted TX power over time

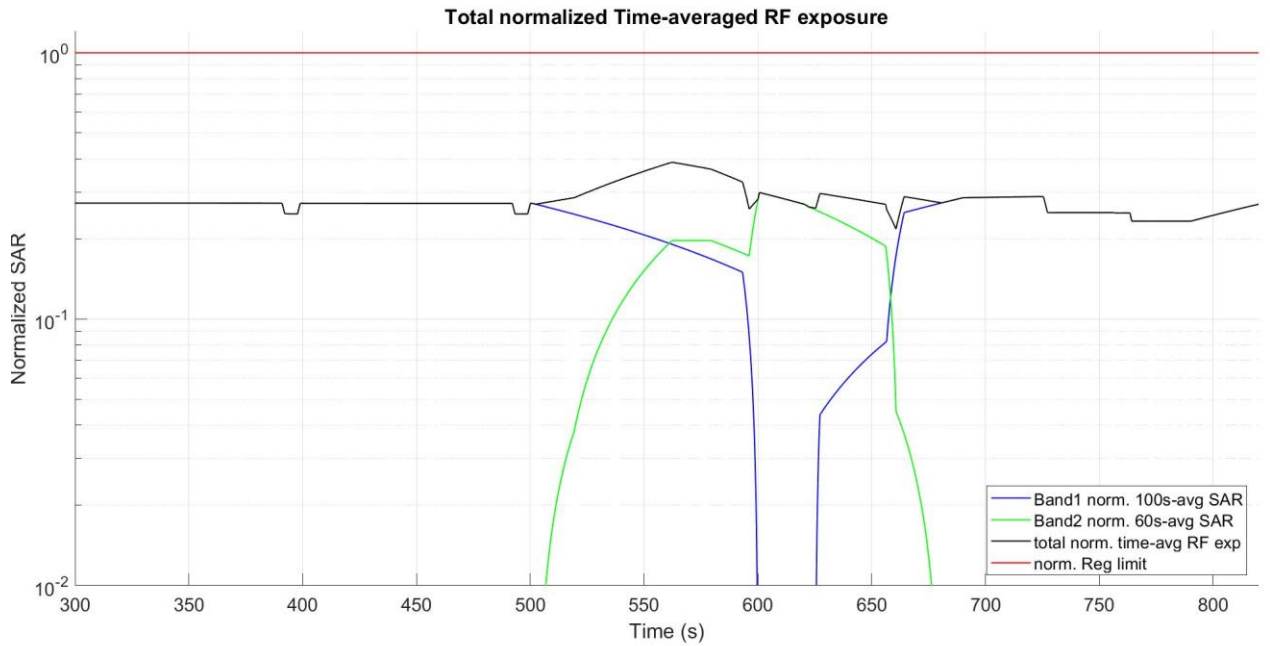

Figure 5- 45 Normalized time-averaged SAR

FCC limit of total RF exposure (normalized)	1.0
Max total normalized time-averaged RF exposure	0.388
Validation result: pass	

5.8 Conducted Power Measurement Results for Scenario 8: SAR Exposure Switching (EN-DC)

In this scenario, the test power sequence #0 (i.e., maximum TX power is requested by a call box for each RAT) is used, and LTE and NR FR1 are turned on at the same time for a pre-defined period during the test. This scenario aims to validate whether the TA-SAR algorithm is able to maintain TER below the FCC limit when the two radios change TX power dynamically. The experiment parameters are summarized in Table 6-10, and the test procedure follows section 4.9.2. The measurement setup is shown in Figure 5-5.

During the test period,

- Time = 300s~500s: NR FR1-only scenario.
- Time = 500s~700s: LTE + NR FR1 scenario.
- Time = 700s~900s: LTE-only scenario.

The first figure demonstrates the EUT's instantaneous conducted TX power and the time-averaged conducted TX power behavior over time, and the power limit ($P_{reg_sub6_limit} = P_{sub6_limit} + 1\text{dB device uncertainty}$). It is observed in the figure that the time-averaged TX power in all time periods is maintained below the power limitation. The second figure illustrates the corresponding time-averaged normalized SAR over time converted from the TX time-averaged power by using the equation listed in section 4.9.2. The figure shows that the time-averaged normalized SAR does not exceed the normalized FCC limit of 1.

● **Case15: SAR Exposure Switch for LTE B48 to FR1 n66**



Figure 5- 46 Time-averaged conducted TX power over time

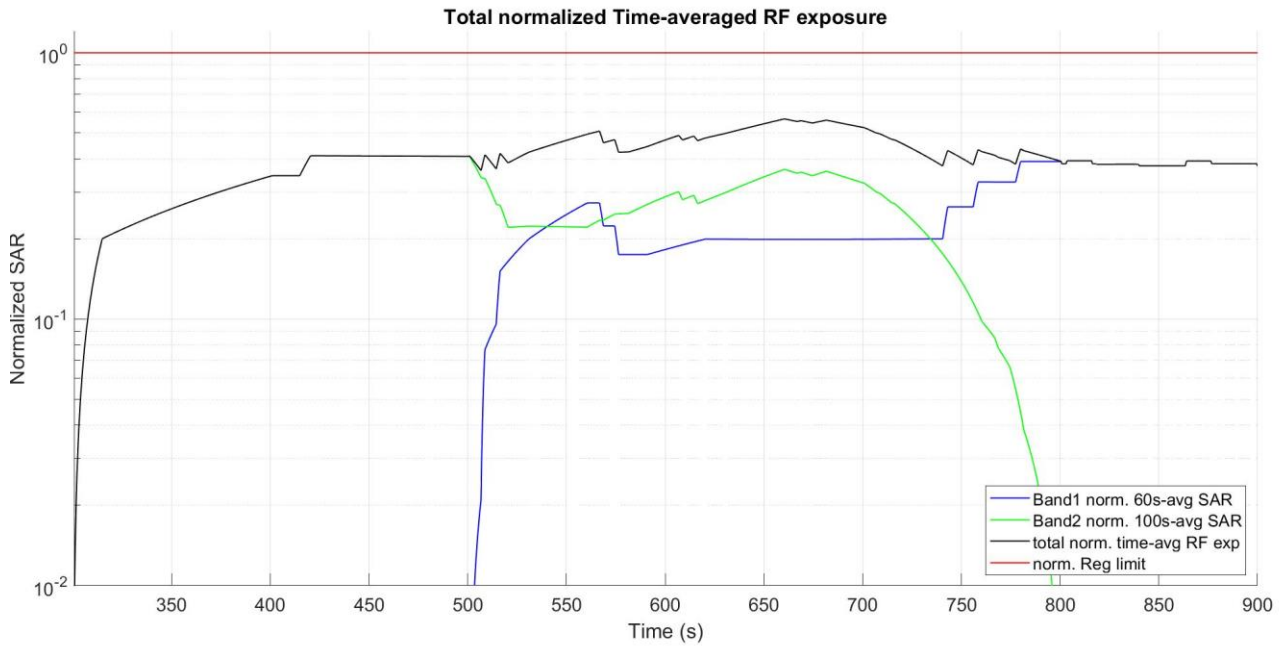

Figure 5- 47 Normalized time-averaged SAR

FCC limit of total RF exposure (normalized)	1.0
Max total normalized time-averaged RF exposure	0.564
Validation result: pass	

5.9 Conducted Power Measurement Results for Scenario 8: SAR Exposure Switching (UL CA)

In this scenario, the test power sequence #0 (i.e., maximum TX power is requested by a call box for each RAT) is used, and LTE UL CA are turned on at the same time for a pre-defined period during the test. This scenario aims to validate whether the TA-SAR algorithm is able to maintain TER below the FCC limit when the two radios change TX power dynamically. The experiment parameters are summarized in Table 6-10, and the test procedure follows section 4.9.2. The measurement setup is shown in Figure 5-5.

During the test period,

- Time = 300s~500s: LTE -only scenario.
- Time = 500s~700s: LTE UL CA scenario.
- Time = 700s~900s: LTE-only scenario.

The first figure demonstrates the EUT's instantaneous conducted TX power and the time-averaged conducted TX power behavior over time, and the power limit ($P_{reg_sub6_limit} = P_{sub6_limit} + 1\text{dB device uncertainty}$). It is observed in the figure that the time-averaged TX power in all time periods is maintained below the power limitation. The second figure illustrates the corresponding time-averaged normalized SAR over time converted from the TX time-averaged power by using the equation listed in section 4.9.2. The figure shows that the time-averaged normalized SAR does not exceed the normalized FCC limit of 1.

● **Case16: SAR Exposure Switch for LTE B25 to LTE B26**



Figure 5- 48 Time-averaged conducted TX power over time

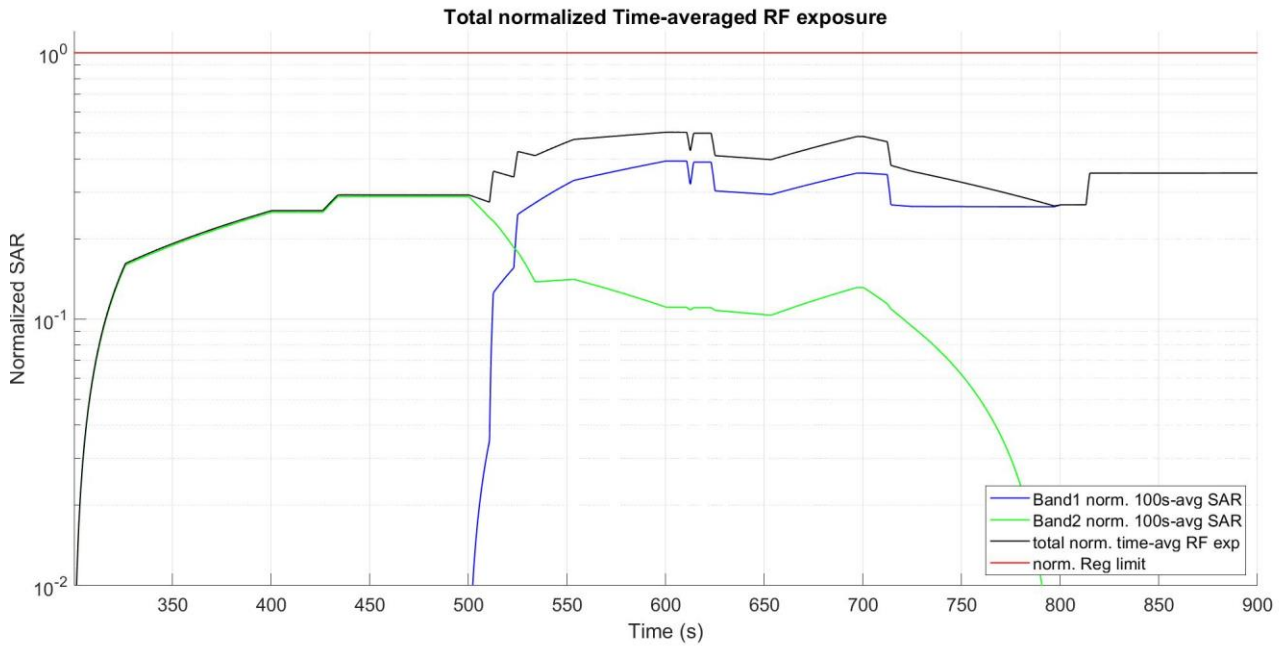

Figure 5- 49 Normalized time-averaged SAR

FCC limit of total RF exposure (normalized)	1.0
Max total normalized time-averaged RF exposure	0.503
Validation result: pass	

6. TA-SAR Validation via SAR Measurements

6.1 Measurement Setup

The measurement setup is similar to normal fixed power SAR measurement. The difference in SAR measurement setup for time averaging feature validation is that the call box operates under the close loop power control mode and is connected to the PC, so that the PC can control the call box based on the test sequence to configure EUT's TX target power. The same test procedure used in conducted power setup for time-varying TX power measurement is also used in this section for time-averaging SAR measurements. Since the SAR chamber is an uncontrolled environment, the path loss between call box antenna and the EUT are well calibrated. The test setup is illustrated in Figure 7-1.

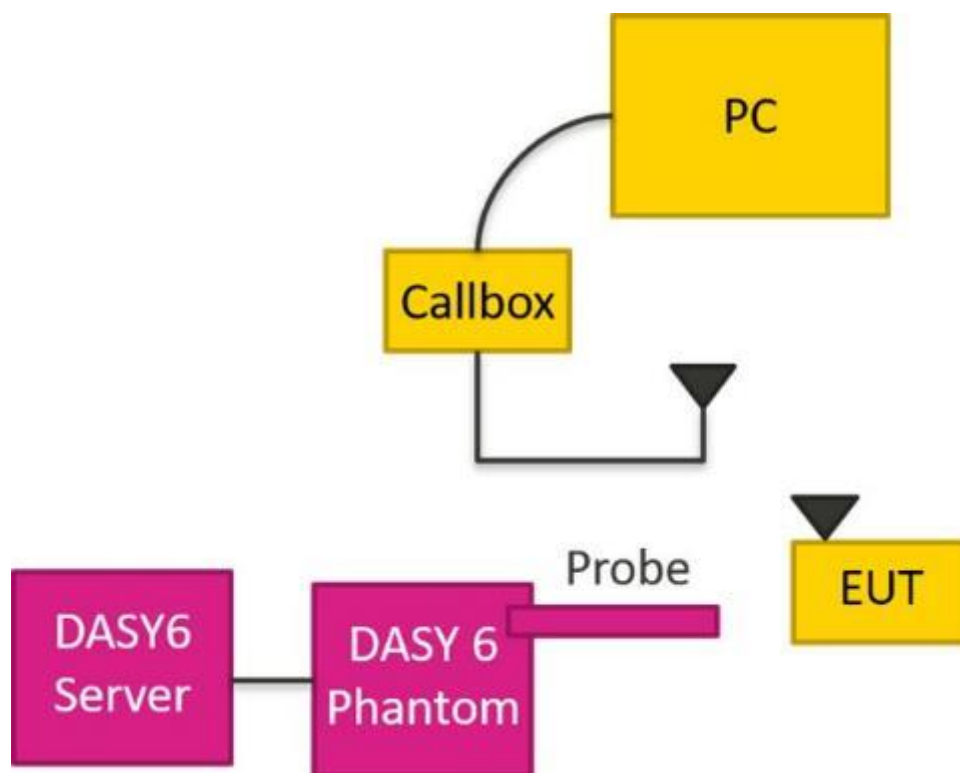

Figure 6-1 TA-SAR wireless test environment

6.2 SAR Measurement Results for Scenario 2: Time-Varying TX Power

In this scenario, Mediatek’s TA-SAR algorithm is tested under more dynamic power test sequences. The test sequence #1 is shown in section 4.1 and test sequence #2 is tabulated in table 4.4. All of the test cases for this scenario are relegated in Table 7-1, and the test procedure follows section 4.10.2. The measurement setup is shown in Figure 6-1, 7-2(a) and 7-2(b). All of the measurements are conduct in SPORTON (i.e., an FCC certified lab) by using DASY6. The high-level summary of the final validation results is given in the last column of the table, which concludes that Mediatek’s TA-SAR algorithm can maintain the time-averaged SAR is always below the FCC requirement for all test cases. The following sections will demonstrate case-by-case to show how Mediatek’s TA-SAR algorithm behaves for each RAT.

Table 7-1 Operating parameters for different TA-SAR parameters setting

Test case	RAT	Test band	Test seq.	ECI	Pmax Setting (dBm)	Measurement Pmax (dBm)	Plimit setting (dBm)	Measurement Plimit (dBm)	PEU_backoff (dBm)	PEU_max_cust (dBm)	Pass /Fail SAR limit
1	Time-varting TX power	GSM850(4TX)	1 & 2	7	25.50	25.25	22.00	22.27	3	5	Pass
2		GSM1900(4TX)	1 & 2	7	22.50	22.47	13.00	13.18	3	6	Pass
3		WCDMA II	1 & 2	7	23.00	23.74	13.50	13.52	3	6	Pass
4		WCDMA V	1 & 2	7	23.00	23.84	21.50	22.27	3	3	Pass
5		LTE Band 7	1 & 2	7	23.00	23.76	10.50	11.16	3	9	Pass
6		LTE Band 26 / 5	1 & 2	6	23.00	23.87	22.00	22.87	3	3	Pass
7		FR1 n41	1 & 2	7	23.00	23.24	12.50	12.60	3	9	Pass
8		FR1 n26	1 & 2	7	23.00	22.47	22.00	21.53	3	5	Pass

6.2.1 SAR Measurement results for 2G

- Case1-1: 2G GSM850 result for test sequence 1

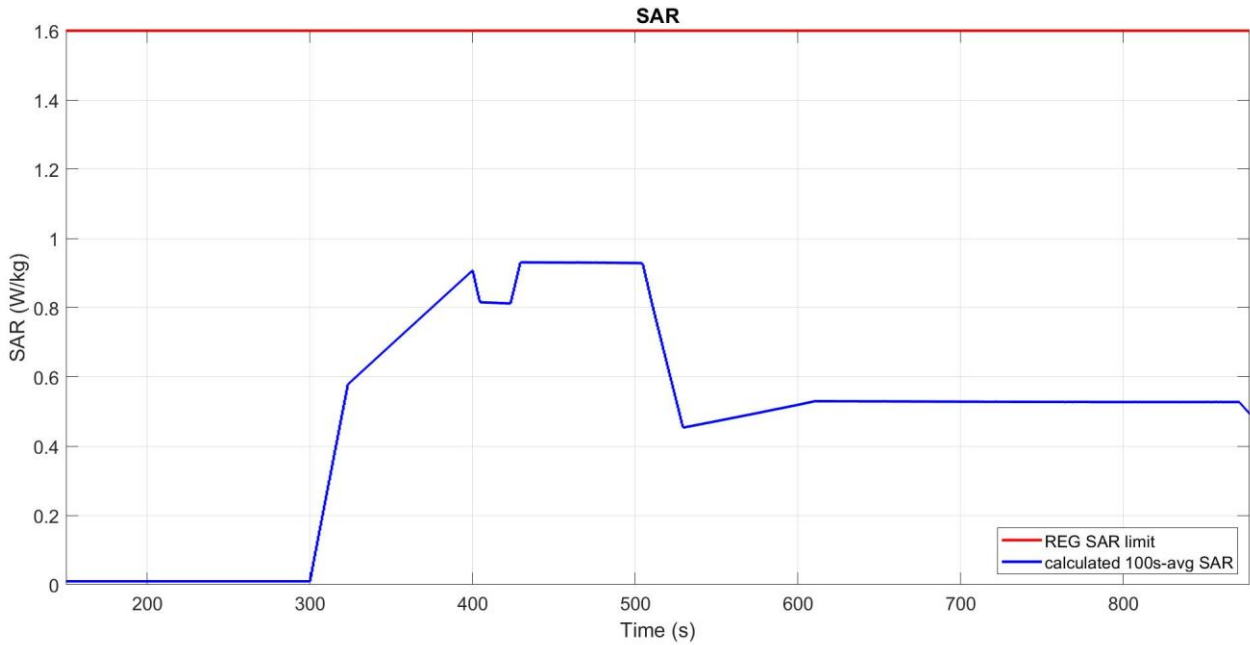

Figure Time-averaged SAR

FCC 1gSAR limit	1.6 W/kg
Max 100s-time averaged 1gSAR	0.931 W/kg
Validation result: pass	

● Case1-2: GSM850 result for test sequence 2

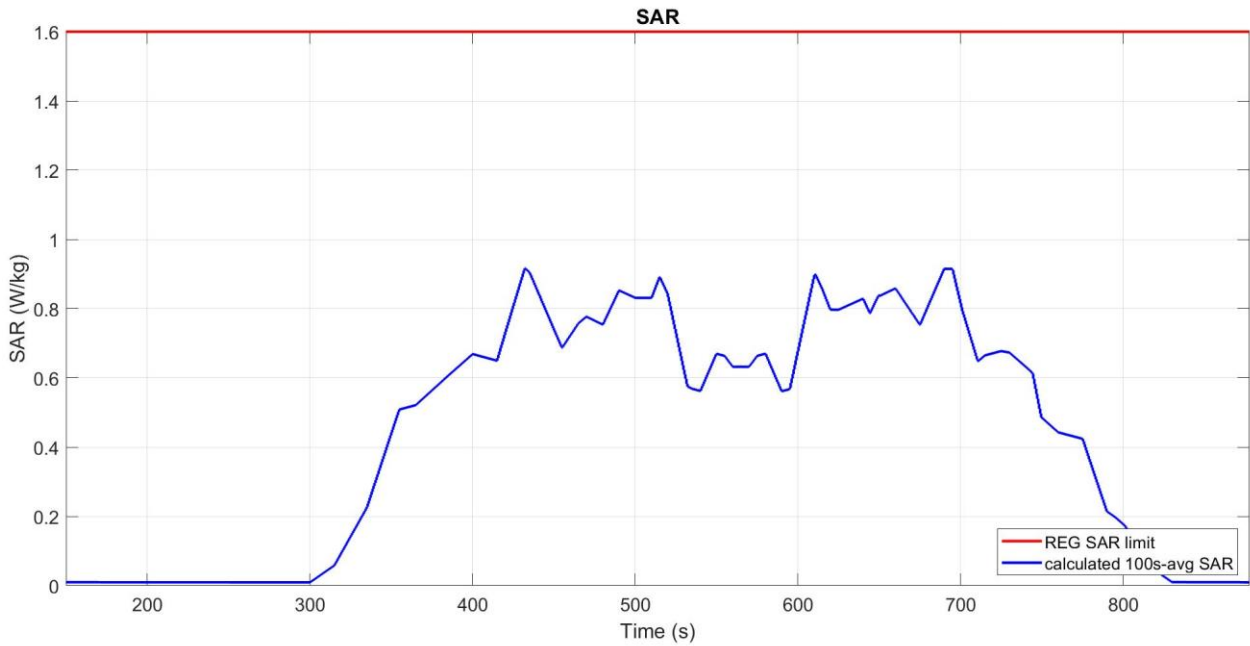

Figure Time-averaged SAR

FCC 1gSAR limit	1.6 W/kg
Max 100s-time averaged 1gSAR	0.916 W/kg
Validation result: pass	

● Case2-1: 2G GSM1900 result for test sequence 1

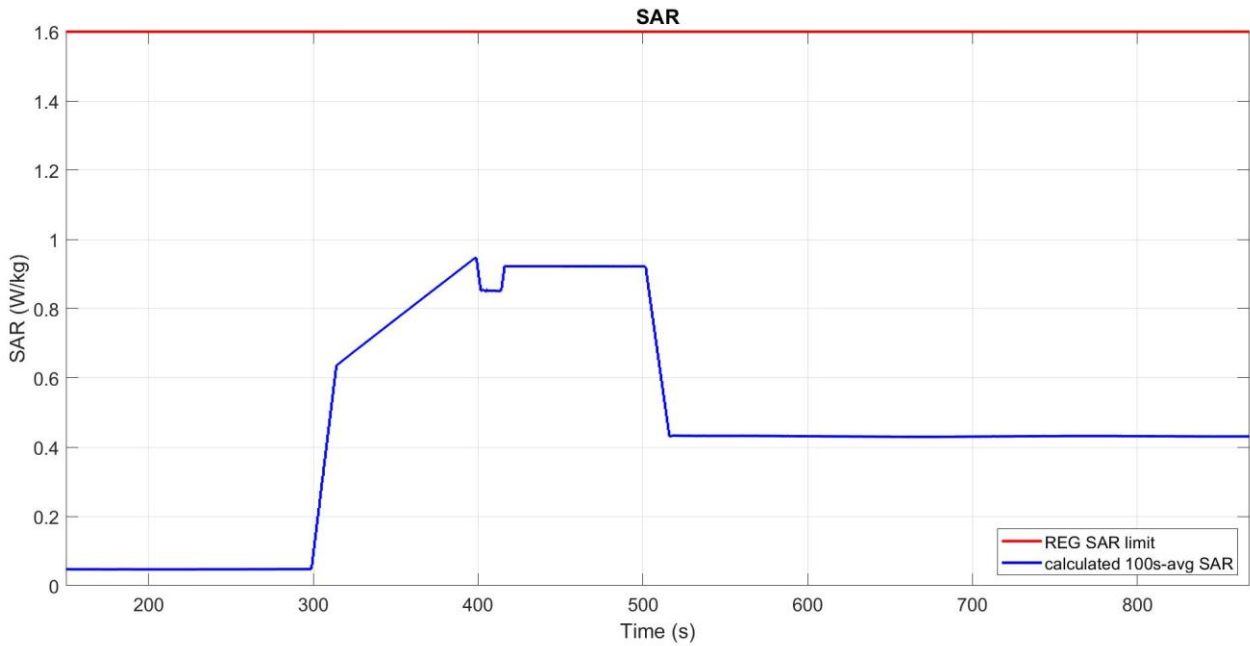

Figure 6-17 Time-averaged SAR

FCC 1gSAR limit	1.6 W/kg
Max 100s-time averaged 1gSAR	0.946 W/kg
Validation result: pass	



● Case2-2: GSM1900 result for test sequence 2

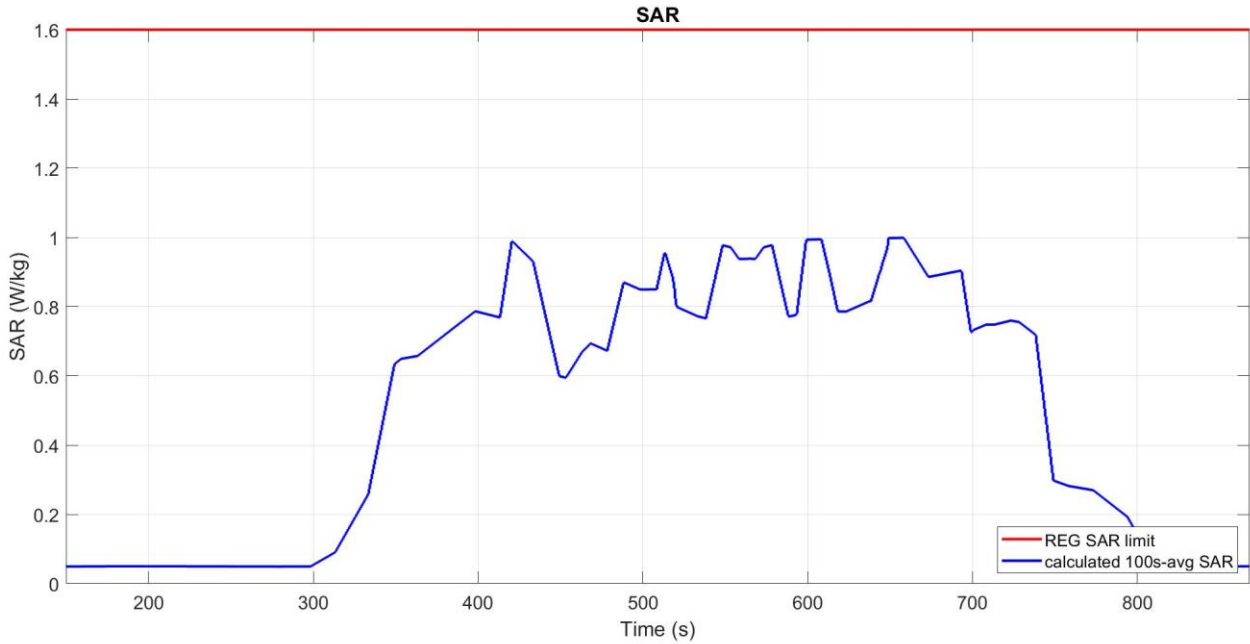

Figure 6-18 Time-averaged SAR

FCC 1gSAR limit	1.6 W/kg
Max 100s-time averaged 1gSAR	0.999 W/kg
Validation result: pass	

6.2.2 SAR Measurement results for 3G WCDMA

- Case3-1: WCDMA B2 result for test sequence 1

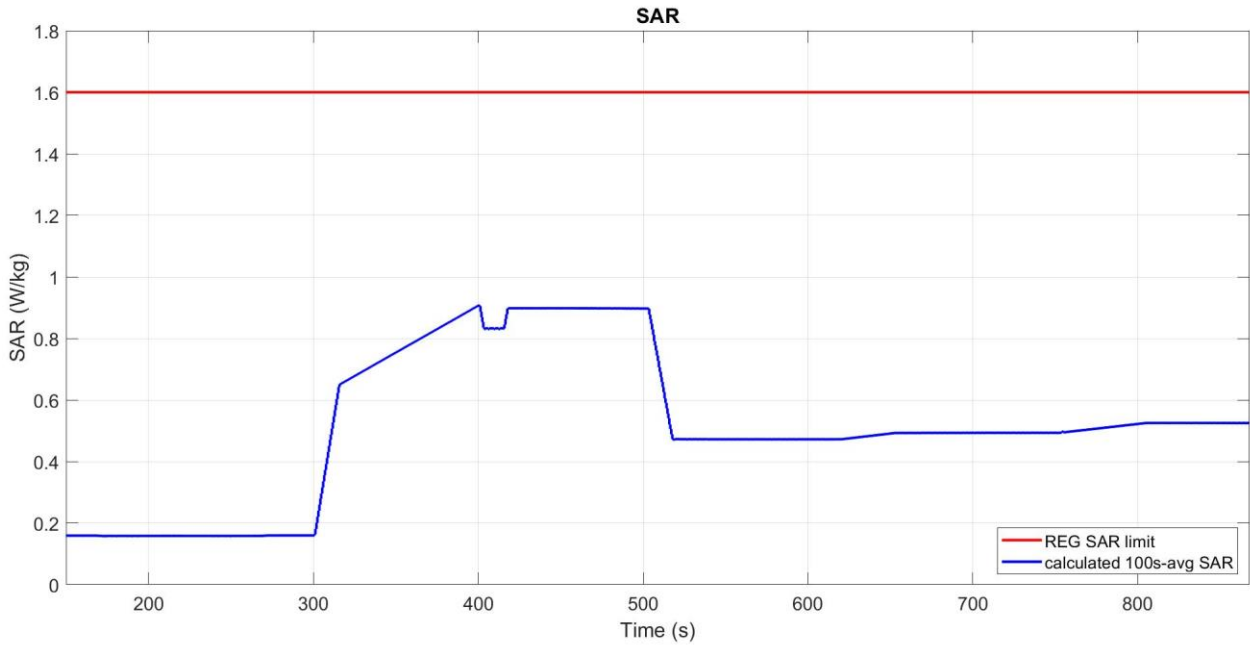

Figure 6-11 Time-averaged SAR

FCC 1gSAR limit	1.6 W/kg
Max 100s-time averaged 1gSAR	0.907 W/kg
Validation result: pass	

● Case3-2: WCDMA B2 result for test sequence 2

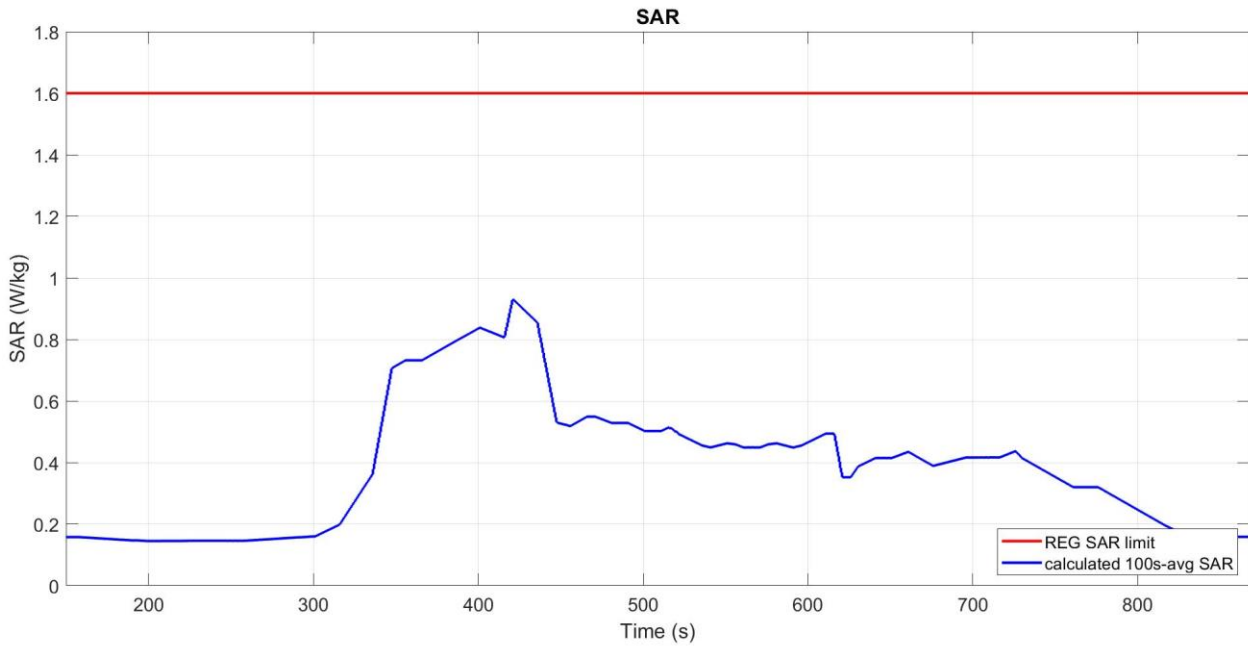

Figure 6-12 Time-averaged SAR

FCC 1gSAR limit	1.6 W/kg
Max 100s-time averaged 1gSAR	0.929 W/kg
Validation result: pass	

● Case4-1: WCDMA B5 result for test sequence 1

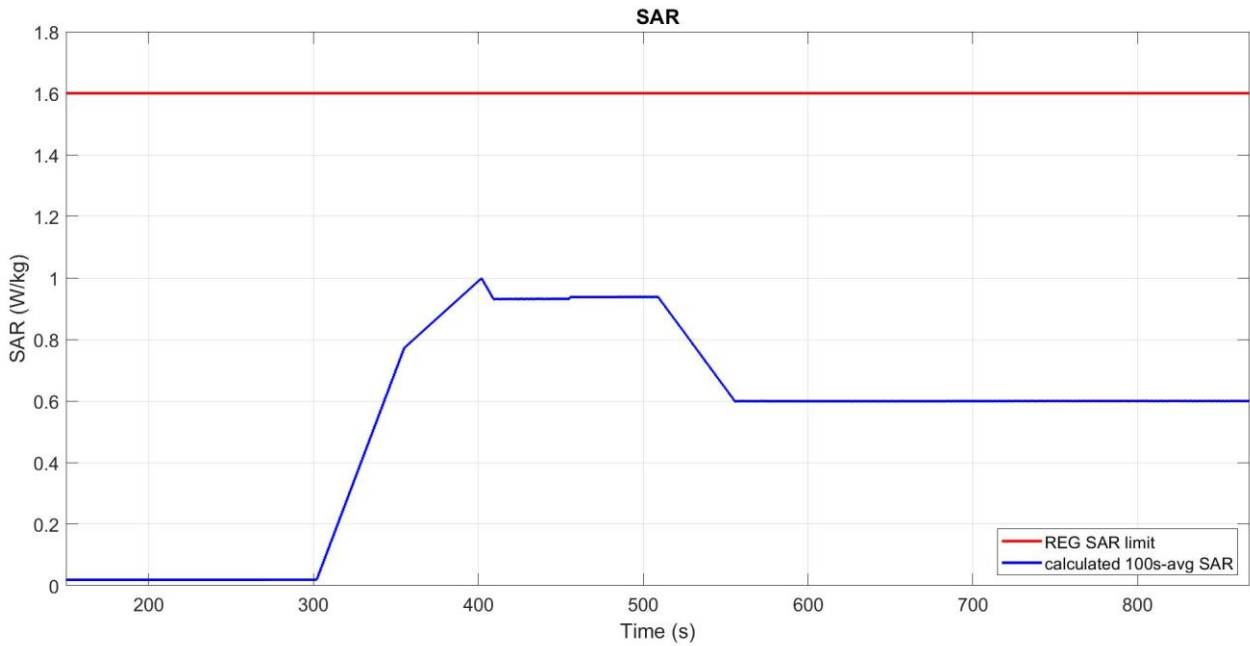

Figure 6-13 Time-averaged SAR

FCC 1gSAR limit	1.6 W/kg
Max 100s-time averaged 1gSAR	0.997 W/kg
Validation result: pass	

● Case4-2: WCDMA B5 result for test sequence 2

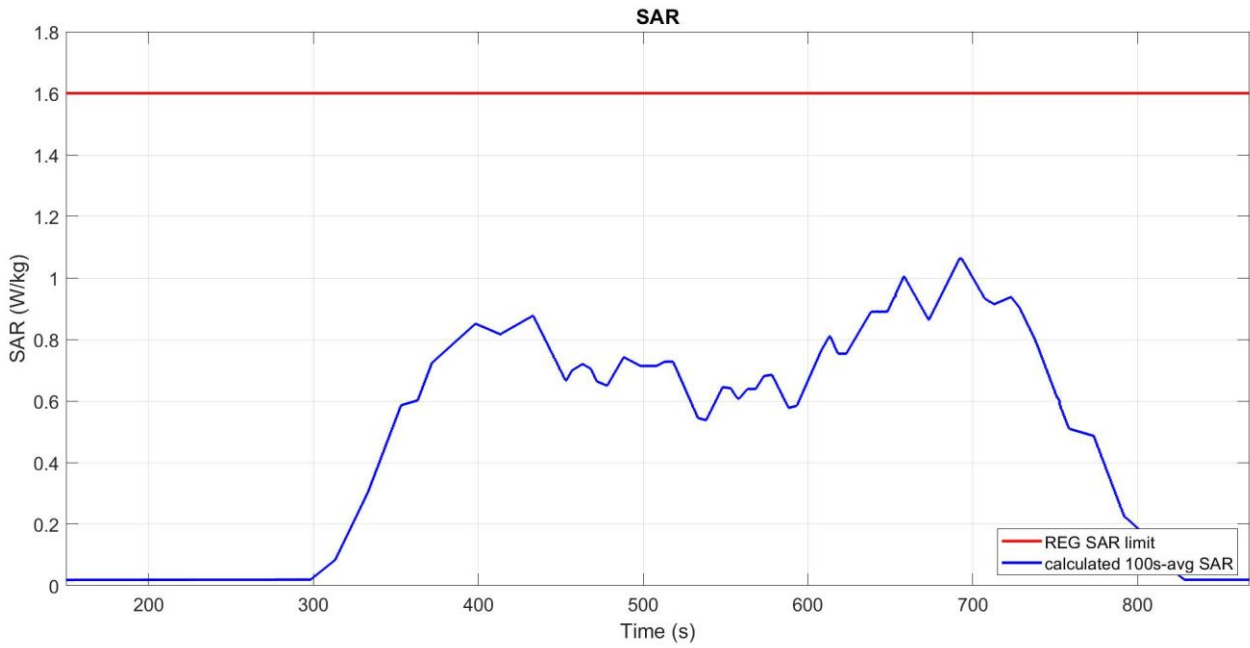

Figure 6-14 Time-averaged SAR

FCC 1gSAR limit	1.6 W/kg
Max 100s-time averaged 1gSAR	1.063 W/kg
Validation result: pass	

6.2.3 SAR Measurement results for LTE

- Case5-1: LTE B7 result for test sequence 1

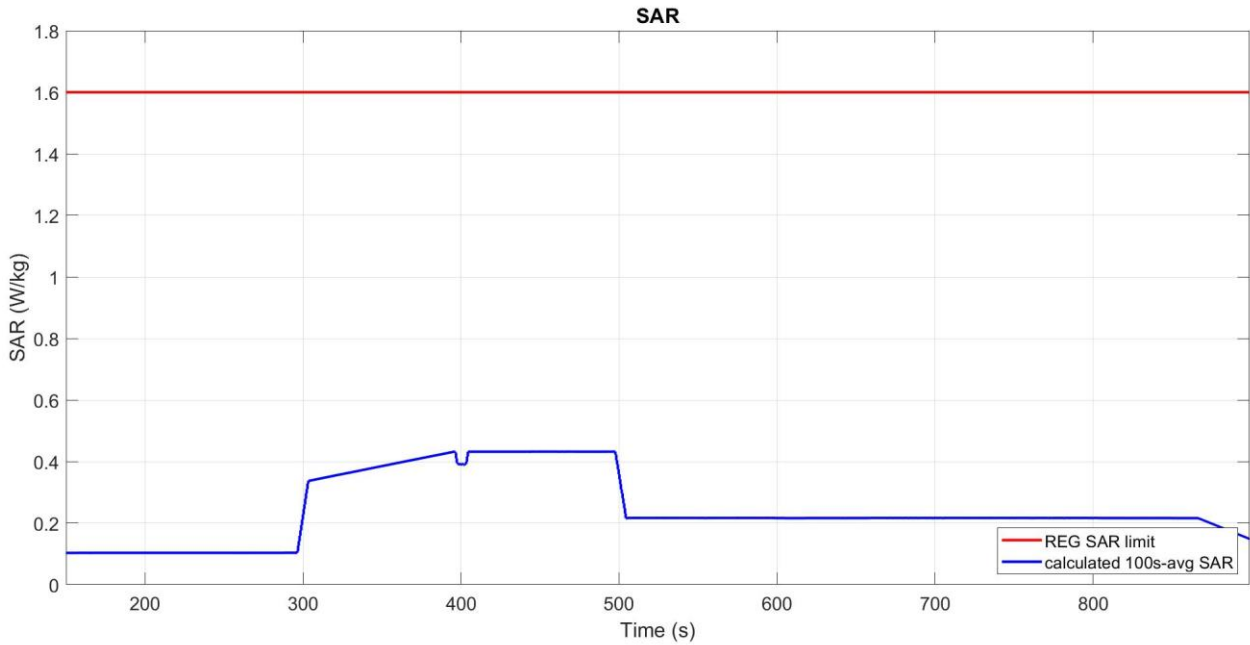

Figure 6-7 Time-averaged SAR

FCC 1gSAR limit	1.6 W/kg
Max 100s-time averaged 1gSAR	0.432 W/kg
Validation result: pass	

● Case5-2: LTE B7 result for test sequence 2

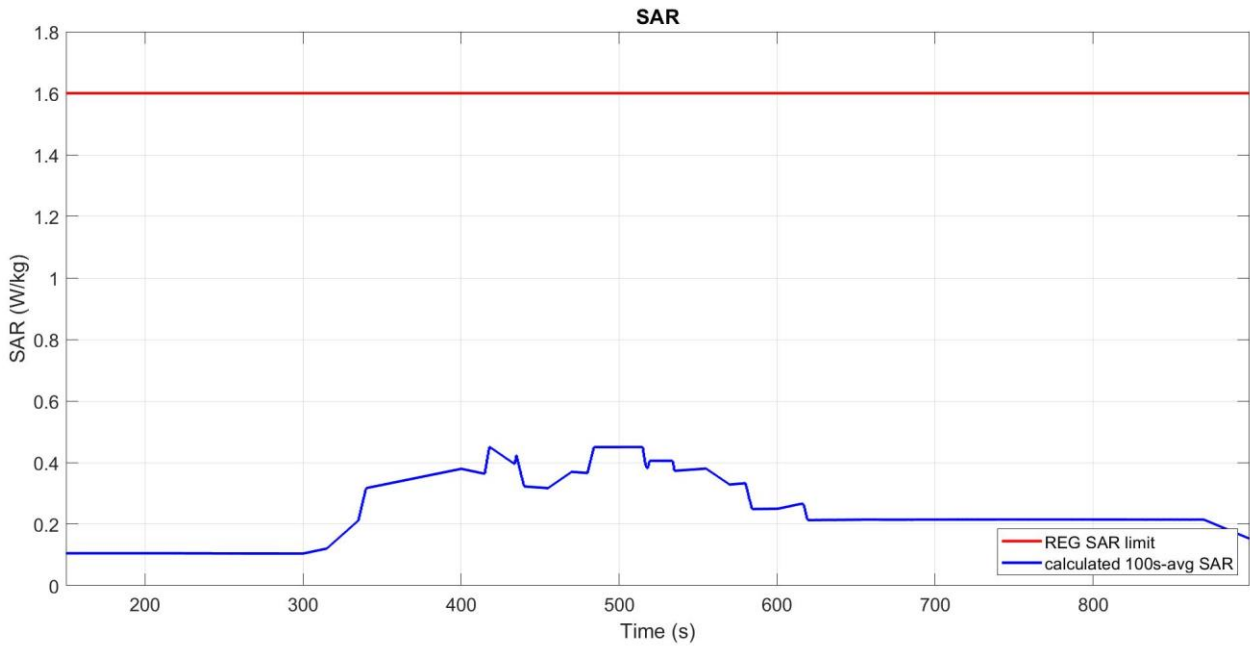

Figure 6-8 Time-averaged SAR

FCC 1gSAR limit	1.6 W/kg
Max 60s-time averaged 1gSAR	0.451 W/kg
Validation result: pass	



● Case6-1: LTE B26 result for test sequence 1

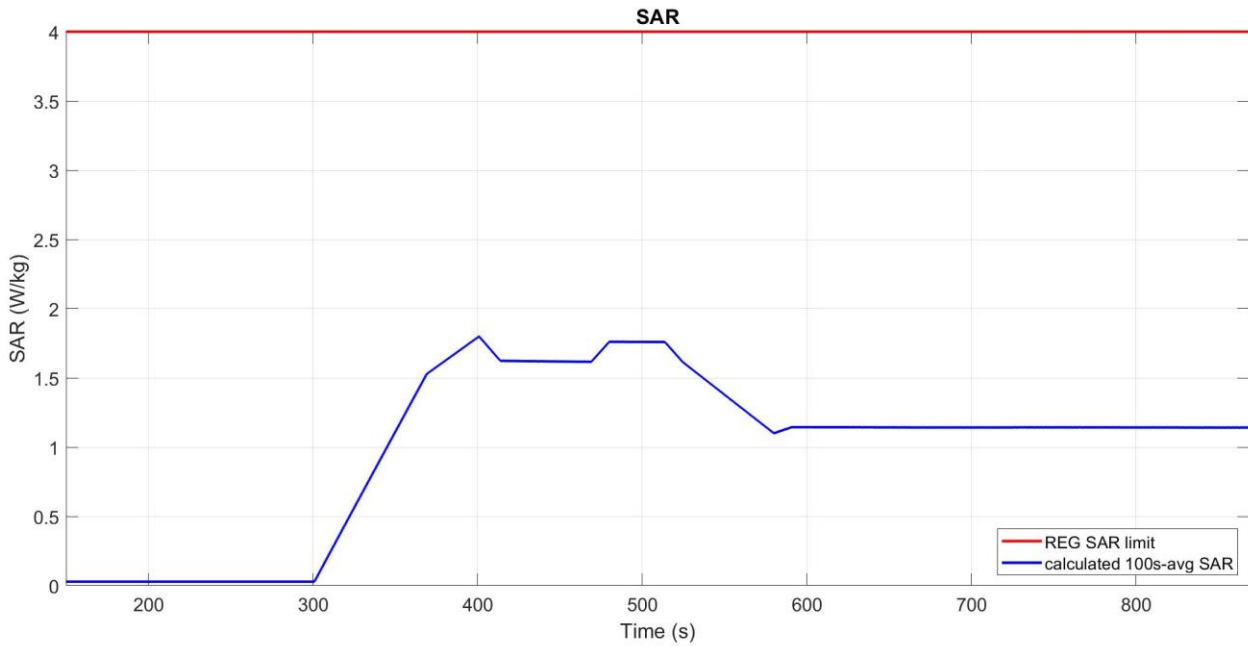

Figure 6-9 Time-averaged SAR

FCC 10gSAR limit	4.0 W/kg
Max 100s-time averaged 10gSAR	1.797 W/kg
Validation result: pass	

● Case6-2: LTE B26 result for test sequence 2

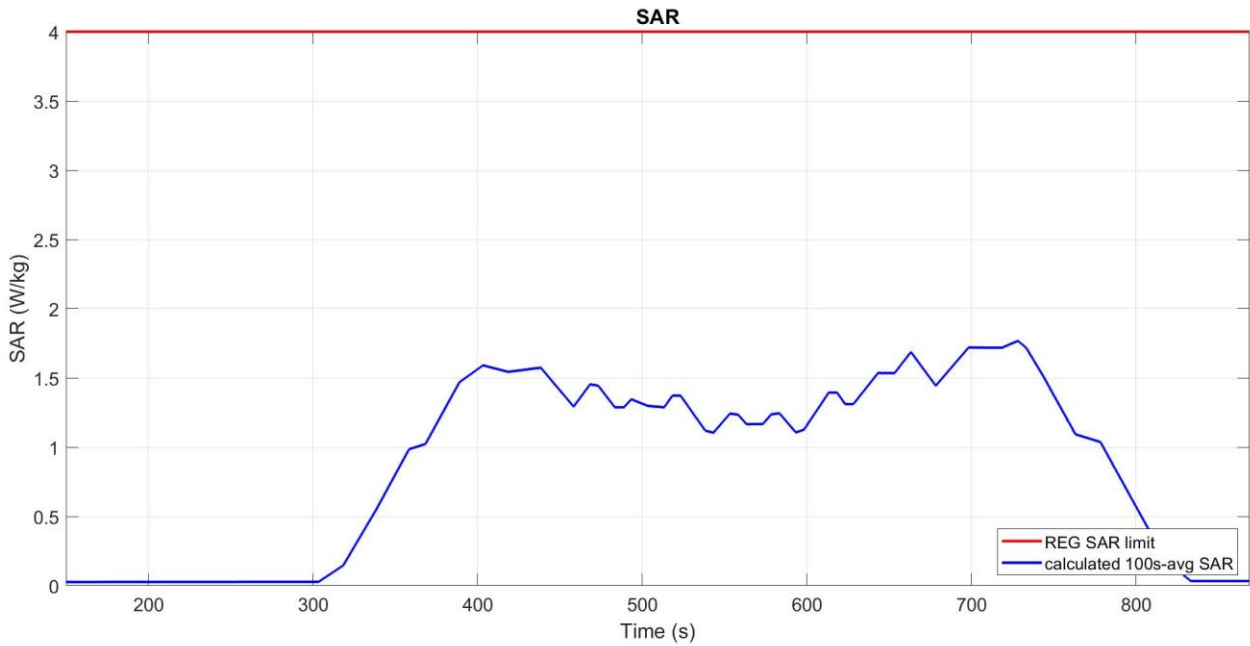

Figure 6-10 Time-averaged SAR

FCC 10gSAR limit	4.0 W/kg
Max 100s-time averaged 10gSAR	1.766 W/kg
Validation result: pass	

6.2.4 SAR Measurement results for NR

- Case7-1: NR n26 result for test sequence 1

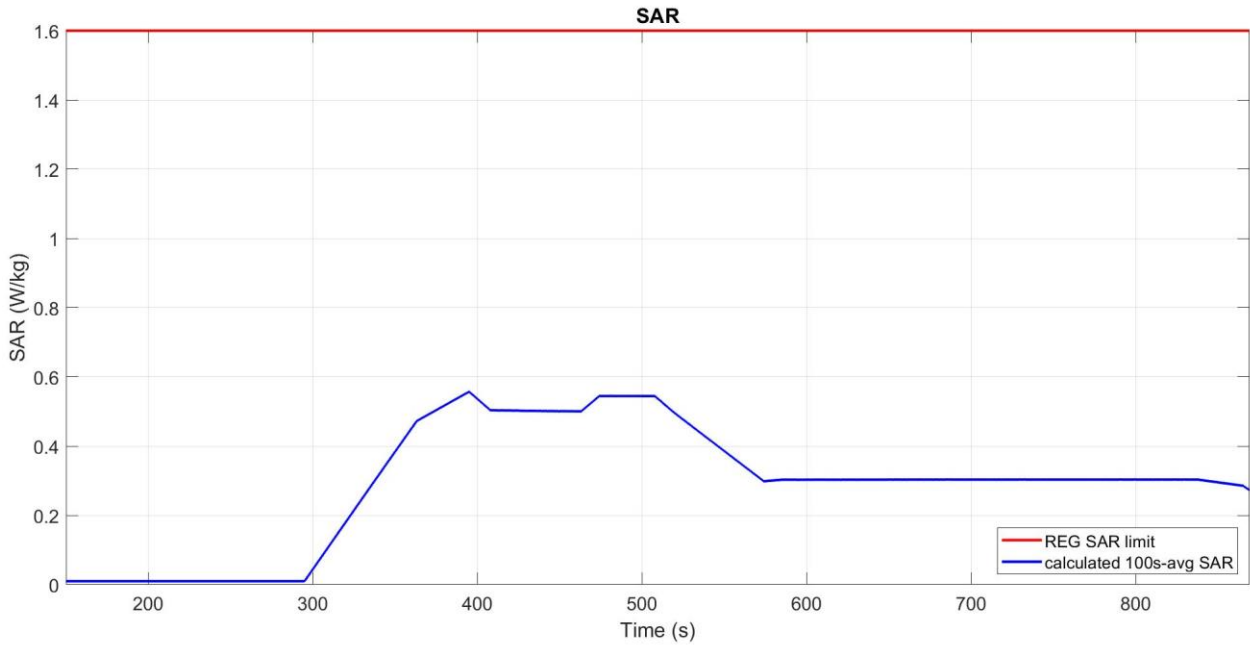

Figure 6-3 Time-averaged SAR

FCC 1gSAR limit	1.6 W/kg
Max 60s-time averaged 1gSAR	0.556 W/kg
Validation result: pass	



● Case7-2: NR n26 result for test sequence 2

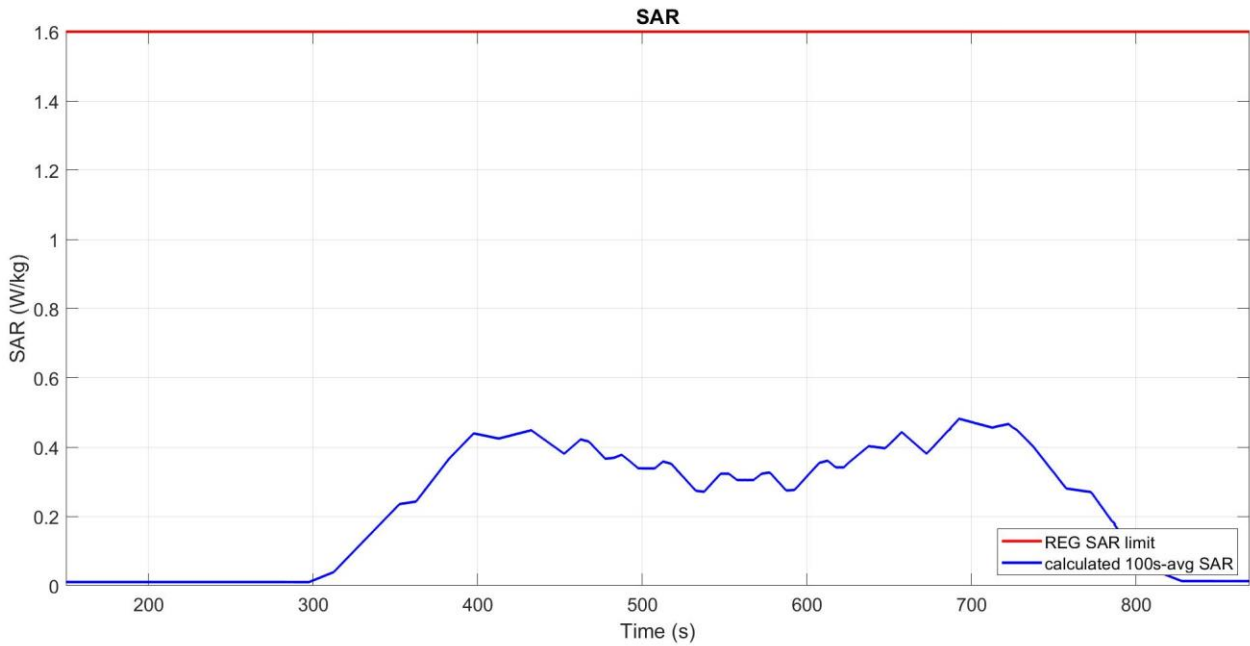

Figure 6-4 Time-averaged SAR

FCC 1gSAR limit	1.6 W/kg
Max 60s-time averaged 1gSAR	0.482 W/kg
Validation result: pass	



● Case8-1: NR n41 result for test sequence 1

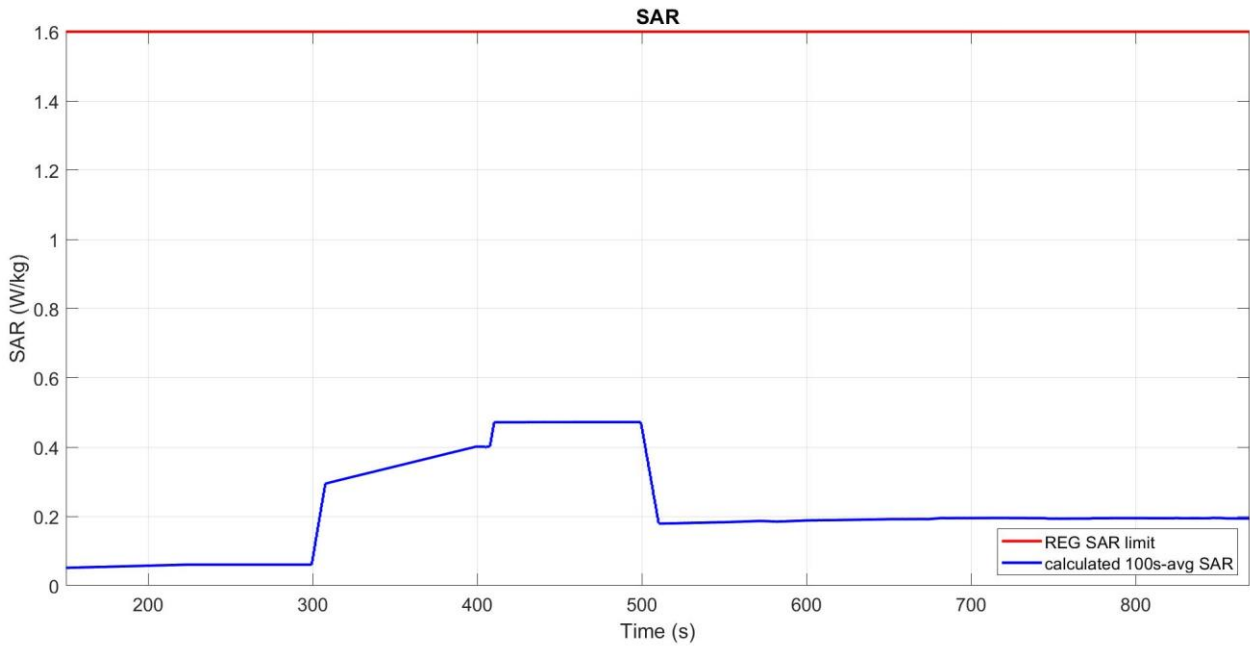

Figure 6-5 Time-averaged SAR

FCC 1gSAR limit	1.6 W/kg
Max 100s-time averaged 1gSAR	0.472 W/kg
Validation result: pass	

● Case8-2: NR n41 result for test sequence 2

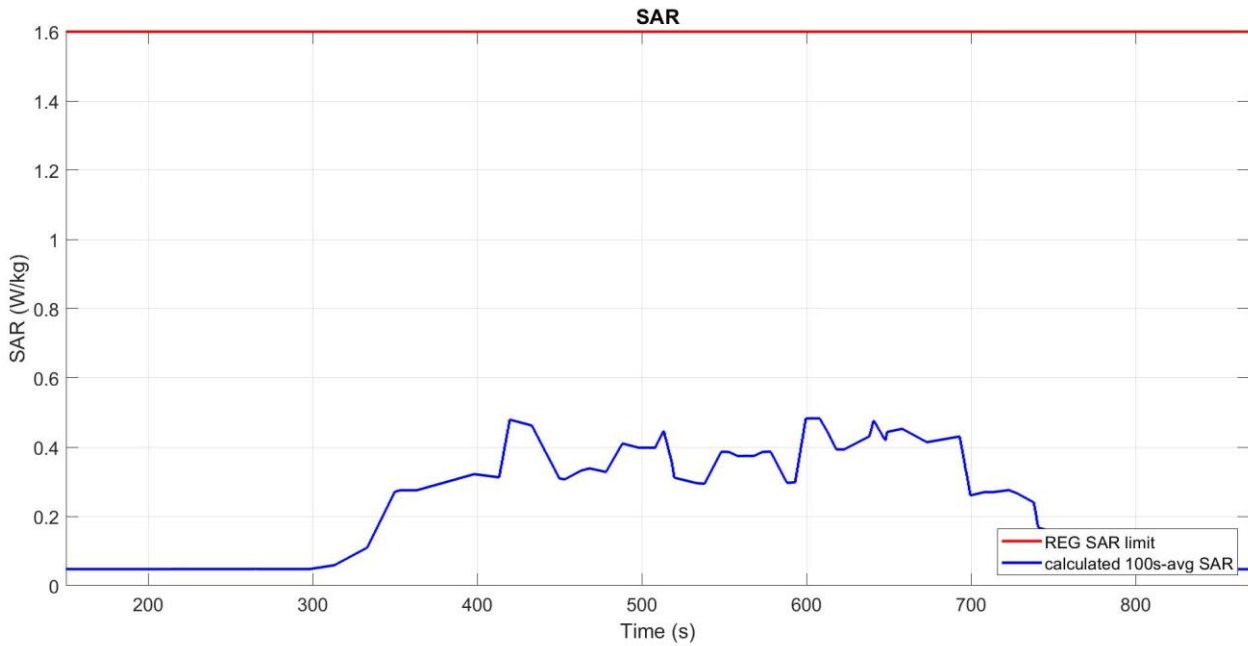

Figure 6-6 Time-averaged SAR for case

FCC 1gSAR limit	1.6 W/kg
Max 100s-time averaged 1gSAR	0.483 W/kg
Validation result: pass	



7. Conclusions

This document proposes TA-SAR test scenarios and procedures, and further proves Mediatek's TA-SAR algorithms can meet the FCC SAR regulations with the proposed test scenarios and procedures. As shown in Chapters 6 and 8, Mediatek's TA-SAR algorithms are able to maintain SAR over time below the FCC regulatory limits (based on the agreed TX-power-to-SAR translation). Furthermore, the near-field measurements are also done in an FCC certified lab (i.e., SPORTON) to further validate the proposed test methodologies, and the results shown in Chapters 7 and 9 demonstrate that Mediatek's TA-SAR algorithms really can maintain SAR over time below the FCC regulatory limits under the proposed test procedures. Based on the provided measurement evidences, it is concluded that Mediatek's TA-SAR algorithms can be tested by using the proposed test methodology for FCC compliance.

8. cDASY6 System Verification

8.1 The system to be used for the near field power density measurement

- SPEAG DASY6 system
- SPEAG cDASY6 5G module software
- EUmmWVx probe
- 5G Phantom cover

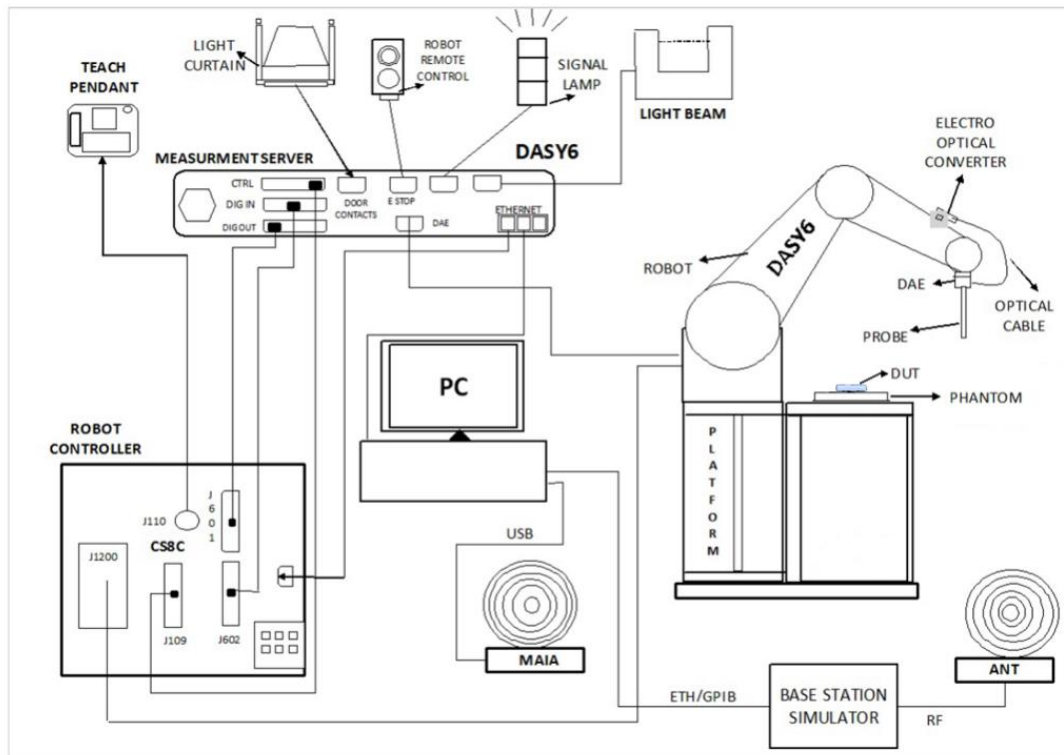

8.2 Test Side Location

Sporton Lab and below test site location are accredited to ISO 17025 by Taiwan Accreditation Foundation (TAF code: 1190). The ISED Assigned Code is 4086B and 4086H

Test Site	SPORTON INTERNATIONAL INC. EMC & Wireless Communications Laboratory
Test Site Location	4086B No. 52, Huaya 1st Rd., Guishan Dist., Taoyuan City 333, CHINESE TAIPEI
Test Site No.	SAR06-HY

8.3 SAR E-Field Probe

Construction	Symmetric design with triangular core Built-in shielding against static charges PEEK enclosure material (resistant to organic solvents, e.g., DGBE)	
Frequency	10 MHz – >6 GHz Linearity: ±0.2 dB (30 MHz – 6 GHz)	
Directivity	±0.3 dB in TSL (rotation around probe axis) ±0.5 dB in TSL (rotation normal to probe axis)	
Dynamic Range	10 µW/g – >100 mW/g Linearity: ±0.2 dB (noise: typically <1 µW/g)	
Dimensions	Overall length: 337 mm (tip: 20 mm) Tip diameter: 2.5 mm (body: 12 mm) Typical distance from probe tip to dipole centers: 1 mm	

8.4 Data Acquisition Electronics (DAE)

The data acquisition electronics (DAE) consists of a highly sensitive electrometer-grade preamplifier with auto-zeroing, a channel and gain-switching multiplexer, a fast 16 bit AD-converter and a command decoder and control logic unit. Transmission to the measurement server is accomplished through an optical downlink for data and status information as well as an optical uplink for commands and the clock. The input impedance of the DAE is 200 MOhm; the inputs are symmetrical and floating. Common mode rejection is above 80 dB.

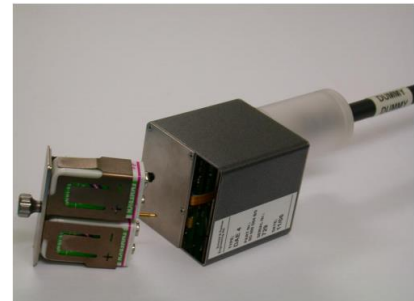



9. Test Equipment List

Manufacturer	Name of Equipment	Type/Model	Serial Number	Calibration	
				Last Cal.	Due Date
SPEAG	835MHz System Validation Kit	D835V2	4d167	Nov. 24, 2022	Nov. 23, 2023
SPEAG	1900MHz System Validation Kit ⁽²⁾	D1900V2	5d185	Jun. 17, 2022	Jun. 16, 2023
SPEAG	2600MHz System Validation Kit ⁽²⁾	D2600V2	1089	Mar. 24, 2022	Mar. 22, 2024
SPEAG	Data Acquisition Electronics	DAE4	1696	Nov. 09, 2022	Nov. 08, 2023
SPEAG	Dosimetric E-Field Probe	EX3DV4	3931	Oct. 31, 2022	Oct. 30, 2023
Testo	Hygro meter	608-H1	45196600	Nov. 02, 2022	Nov. 01, 2023
R&S	Wideband Radio Communication Tester	CMW500	169351	Oct. 18, 2022	Oct. 17, 2023
Anritsu	Signal Generator	MG3710A	6201502524	Oct. 12, 2022	Oct. 11, 2023
Anritsu	Power Meter	ML2495A	1419002	Aug. 16, 2022	Aug. 15, 2023
Anritsu	Power Sensor	MA2411B	1911176	Aug. 16, 2022	Aug. 15, 2023
Anritsu	Power Meter	ML2495A	1804003	Oct. 17, 2022	Oct. 16, 2023
Anritsu	Power Sensor	MA2411B	1726150	Oct. 17, 2022	Oct. 16, 2023
R&S	Power Sensor	NRP8S	109688	Sep. 23, 2022	Sep. 22, 2023
R&S	Power Sensor	NRP50S	100983	Nov. 10, 2022	Nov. 09, 2023
Mini-Circuits	Power Amplifier	ZVE-8G+	479102029	Sep. 15, 2022	Sep. 14, 2023
Mini-Circuits	Power Amplifier	ZHL-42W+	321501827	Sep. 15, 2022	Sep. 14, 2023
ATM	Dual Directional Coupler	C122H-10	P610410z-02	Note 1	
Warison	Directional Coupler	WCOU-10-50S-10	WR889BMC4B1	Note 1	
Woken	Attenuator 1	WK0602-XX	N/A	Note 1	
PE	Attenuator 2	PE7005-10	N/A	Note 1	
PE	Attenuator 3	PE7005-3	N/A	Note 1	

General Note:

1. Prior to system verification and validation, the path loss from the signal generator to the system check source and the power meter, which includes the amplifier, cable, attenuator and directional coupler, was measured by the network analyzer. The reading of the power meter was offset by the path loss difference between the path to the power meter and the path to the system check source to monitor the actual power level fed to the system check source.
2. The dipole calibration interval can be extended to 3 years with justification according to KDB 865664 D01. The dipoles are also not physically damaged, or repaired during the interval. The justification data in appendix C can be found which the return loss is < -20dB, within 20% of prior calibration, the impedance is within 5 ohm of prior calibration for each dipole.



10. System verification and validation

10.1 Tissue Verification

The tissue dielectric parameters of tissue-equivalent media used for SAR measurements must be characterized within a temperature range of 18°C to 25°C, measured with calibrated instruments and apparatuses, such as network analyzers and temperature probes. The temperature of the tissue-equivalent medium during SAR measurement must also be within 18°C to 25°C and within ± 2°C of the temperature when the tissue parameters are characterized. The tissue dielectric measurement system must be calibrated before use. The dielectric parameters must be measured before the tissue-equivalent medium is used in a series of SAR measurements.

The liquid tissue depth was at least 15cm in the phantom for all SAR testing

<Tissue Check Results>

Frequency (MHz)	Liquid Temp. (°C)	Conductivity (σ)	Permittivity (ε _r)	Conductivity Target (σ)	Permittivity Target (ε _r)	Delta (σ) (%)	Delta (ε _r) (%)	Limit (%)	Date
835	22.5	0.908	41.700	0.90	41.50	0.89	0.48	±5	2023/4/20
1900	22.5	1.420	41.300	1.40	40.00	1.43	3.25	±5	2023/4/20
2600	22.5	1.990	38.900	1.96	39.00	1.53	-0.26	±5	2023/4/20

10.2 System Verification

Comparing to the original SAR value provided by SPEAG, the verification data should be within its specification of 10 %. Below table shows the target SAR and measured SAR after normalized to 1W input power. The table below indicates the system performance check can meet the variation criterion and the plots can be referred to Appendix D.

<System Verification Results>

Date	Frequency (MHz)	Input Power (mW)	Dipole S/N	Probe S/N	DAE S/N	Measured 1g SAR (W/kg)	Targeted 1g SAR (W/kg)	Normalized 1g SAR (W/kg)	Deviation (%)	Measured 10g SAR (W/kg)	Targeted 10g SAR (W/kg)	Normalized 10g SAR (W/kg)	Deviation (%)
2023/4/20	835	250	D835V2-4d167	EX3DV4_3931	DAE4 Sn1696	2.470	9.800	9.88	0.82	1.650	6.380	6.6	3.45
2023/4/20	1900	250	D1900V2-5d185	EX3DV4_3931	DAE4 Sn1696	9.240	39.000	36.96					
2023/4/20	2600	250	D2600V2-1089	EX3DV4_3931	DAE4 Sn1696	13.960	55.400	55.84					

11. Uncertainty Assessment

Declaration of Conformity:

The test results with all measurement uncertainty excluded is presented in accordance with the regulation limits or requirements declared by manufacturers.

Comments and Explanations:

The declared of product specification for EUT presented in the report are provided by the manufacturer, and the ufacturer takes all the responsibilities for the accuracy of product specification.

The component of uncertainly may generally be categorized according to the methods used to evaluate them. The evaluation of uncertainly by the statistical analysis of a series of observations is termed a Type An evaluation of uncertainty. The evaluation of uncertainty by means other than the statistical analysis of a series of observation is termed a Type B evaluation of uncertainty. Each component of uncertainty, however evaluated, is represented by an estimated standard deviation, termed standard uncertainty, which is determined by the positive square root of the estimated variance.

A Type A evaluation of standard uncertainty may be based on any valid statistical method for treating data. This includes calculating the standard deviation of the mean of a series of independent observations; using the method of least squares to fit a curve to the data in order to estimate the parameter of the curve and their standard deviations; or carrying out an analysis of variance in order to identify and quantify random effects in certain kinds of measurement.

A type B evaluation of standard uncertainty is typically based on scientific judgment using all of the relevant information available. These may include previous measurement data, experience, and knowledge of the behavior and properties of relevant materials and instruments, manufacture’s specification, data provided in calibration reports and uncertainties assigned to reference data taken from handbooks. Broadly speaking, the uncertainty is either obtained from an outdoor source or obtained from an assumed distribution, such as the normal distribution, rectangular or triangular distributions indicated in table below.

Uncertainty Distributions	Normal	Rectangular	Triangular	U-Shape
Multi-plying Factor ^(a)	1/k ^(b)	1/√3	1/√6	1/√2

- (a) standard uncertainty is determined as the product of the multiplying factor and the estimated range of variations in the measured quantity
- (b) κ is the coverage factor

Standard Uncertainty for Assumed Distribution

The combined standard uncertainty of the measurement result represents the estimated standard deviation of the result. It is obtained by combining the individual standard uncertainties of both Type A and Type B evaluation using the usual “root-sum-squares” (RSS) methods of combining standard deviations by taking the positive square root of the estimated variances.

Expanded uncertainty is a measure of uncertainty that defines an interval about the measurement result within which the measured value is confidently believed to lie. It is obtained by multiplying the combined standard uncertainty by a coverage factor. Typically, the coverage factor ranges from 2 to 3. Using a coverage factor allows the true value of a measured quantity to be specified with a defined probability within the specified uncertainty range. For purpose of this document, a coverage factor two is used, which corresponds to confidence interval of about 95 %. The DASy uncertainty Budget is shown in the following tables.

The judgment of conformity in the report is based on the measurement results excluding the measurement uncertainty.



Uncertainty Budget for frequency range 30 MHz to 6 GHz							
Error Description	Uncertainty Value (±%)	Probability	Divisor	(Ci) 1g	(Ci) 10g	Standard Uncertainty (1g) (±%)	Standard Uncertainty (10g) (±%)
Measurement System							
Probe Calibration	7.0	N	1	1	1	7.0	7.0
Axial Isotropy	4.7	R	1.732	0.7	0.7	1.9	1.9
Hemispherical Isotropy	9.6	R	1.732	0.7	0.7	3.9	3.9
Linearity	4.7	R	1.732	1	1	2.7	2.7
Modulation Response	3.2	R	1.732	1	1	1.8	1.8
System Detection Limits	1.0	R	1.732	1	1	0.6	0.6
Boundary Effects	2.0	R	1.732	1	1	1.2	1.2
Readout Electronics	0.3	N	1	1	1	0.3	0.3
Response Time	0.0	R	1.732	1	1	0.0	0.0
Integration Time	2.6	R	1.732	1	1	1.5	1.5
RF Ambient Noise	3.0	R	1.732	1	1	1.7	1.7
RF Ambient Reflections	3.0	R	1.732	1	1	1.7	1.7
Probe Positioner	0.4	R	1.732	1	1	0.2	0.2
Probe Positioning	6.7	R	1.732	1	1	3.9	3.9
Post-processing	4.0	R	1.732	1	1	2.3	2.3
Test Sample Related							
Device Holder	3.6	N	1	1	1	3.6	3.6
Test sample Positioning	3.0	N	1	1	1	3.0	3.0
Power Scaling	0.0	R	1.732	1	1	0.0	0.0
Power Drift	5.0	R	1.732	1	1	2.9	2.9
Phantom and Setup							
Phantom Uncertainty	7.6	R	1.732	1	1	4.4	4.4
SAR correction	0.0	R	1.732	1	0.84	0.0	0.0
Liquid Conductivity Repeatability	0.2	N	1	0.78	0.71	0.1	0.1
Liquid Conductivity (target)	5.0	R	1.732	0.78	0.71	2.3	2.0
Liquid Conductivity (mea.)	2.5	R	1.732	0.78	0.71	1.1	1.0
Temp. unc. - Conductivity	3.4	R	1.732	0.78	0.71	1.5	1.4
Liquid Permittivity Repeatability	0.15	N	1	0.23	0.26	0.0	0.0
Liquid Permittivity (target)	5.0	R	1.732	0.23	0.26	0.7	0.8
Liquid Permittivity (mea.)	2.5	R	1.732	0.23	0.26	0.3	0.4
Temp. unc. - Permittivity	0.83	R	1.732	0.23	0.26	0.1	0.1
Combined Std. Uncertainty						12.9%	12.8%
Coverage Factor for 95 %						K=2	K=2
Expanded STD Uncertainty						25.9%	25.5%

- Appendix A. Plots of System Performance Check**
- Appendix B. DASYS Calibration Certificate**
- Appendix C. Test Setup Photos**