



FCC RF Test Report

APPLICANT : Motorola Mobility LLC
EQUIPMENT : Mobile Cellular Phone
BRAND NAME : Motorola
MODEL NAME : XT2317-1, XT2317-2, XT2317-3, XT2317DL
FCC ID : IHDT56AL4
STANDARD : 47 CFR Part 2, 22(H), 24(E), 27(L) , 27(H) , 27(F)
CLASSIFICATION : PCS Licensed Transmitter Held to Ear (PCE)
TEST DATE(S) : Dec. 21, 2022 ~ Jan. 02, 2023

We, Sporton International Inc. (Kunshan), would like to declare that the tested sample has been evaluated in accordance with the procedures given in ANSI C63.26-2015 and shown compliance with the applicable technical standards.

The test results in this report apply exclusively to the tested model / sample. Without written approval of Sporton International Inc. (Kunshan), the test report shall not be reproduced except in full.

Jason Jia

Approved by: Jason Jia



Sporton International Inc. (Kunshan)

**No. 1098, Pengxi North Road, Kunshan Economic Development Zone Jiangsu Province 215300
People's Republic of China**



TABLE OF CONTENTS

REVISION HISTORY...3
SUMMARY OF TEST RESULT...4
1 GENERAL DESCRIPTION...5
1.1 Applicant...5
1.2 Manufacturer...5
1.3 Product Feature of Equipment Under Test...5
1.4 Product Specification of Equipment Under Test...6
1.5 Modification of EUT...7
1.6 Specification of Accessory...7
1.7 Maximum ERP/EIRP Power and Emission Designator...8
1.8 Testing Location...10
1.9 Test Software...10
1.10 Applicable Standards...10
2 TEST CONFIGURATION OF EQUIPMENT UNDER TEST...11
2.1 Test Mode...11
2.2 Connection Diagram of Test System...13
2.3 Support Unit used in test configuration and system...13
2.4 Measurement Results Explanation Example...13
2.5 Frequency List of Low/Middle/High Channels...14
3 CONDUCTED TEST ITEMS...18
3.1 Measuring Instruments...18
3.2 Test Setup...18
3.3 Test Result of Conducted Test...18
3.4 Conducted Output Power and ERP/EIRP...19
3.5 Peak-to-Average Ratio...20
3.6 Occupied Bandwidth...21
3.7 Conducted Band Edge...22
3.8 Conducted Spurious Emission...24
3.9 Frequency Stability...25
4 RADIATED TEST ITEMS...26
4.1 Measuring Instruments...26
4.2 Test Setup...26
4.3 Test Result of Radiated Test...27
4.4 Radiated Spurious Emission...28
5 LIST OF MEASURING EQUIPMENT...29
6 UNCERTAINTY OF EVALUATION...30
APPENDIX A. TEST RESULTS OF CONDUCTED TEST
APPENDIX B. TEST RESULTS OF RADIATED TEST
APPENDIX C. TEST SETUP PHOTOGRAPHS



REVISION HISTORY

REPORT NO.	VERSION	DESCRIPTION	ISSUED DATE
FG2N1003B	Rev. 01	Initial issue of report	Jan. 18, 2023



SUMMARY OF TEST RESULT

Report Section	FCC Rule	Description	Limit	Result	Remark
3.4	§2.1046	Conducted Output Power	-	Report Only	-
	§22.913(a)(5)	Effective Radiated Power (Band 5) (Band 26)	ERP < 7 Watt	PASS	-
	§27.50(b)(10) §27.50(c)(10)	Effective Radiated Power (Band 12) (Band 13) (Band 17)	ERP < 3 Watt		-
	§24.232(c)	Equivalent Isotropic Radiated Power (Band 2) (Band 25)	EIRP < 2Watt		-
	§27.50(d)(4)	Equivalent Isotropic Radiated Power (Band 4) (Band 66)	EIRP < 1Watt		-
3.5	§24.232(d)	Peak-to-Average Ratio	<13 dB	PASS	-
3.6	§2.1049	Occupied Bandwidth	-	Report Only	-
3.7	§2.1051 §22.917(a) §24.238(a) §27.53(c)(2)(4) §27.53(g) §27.53(h)	Conducted Band Edge Measurement (Band 2) (Band 4) (Band 5) (Band 12) (Band 13) (Band 17) (Band 25) (Band 26) (Band 66)	< 43+10log ₁₀ (P[Watts])	PASS	-
3.8	§2.1051 §22.917(a) §24.238(a) §27.53(c)(2) §27.53(g) §27.53(h)	Conducted Spurious Emission (Band 2) (Band 4) (Band 5) (Band 12) (Band 13) (Band 17) (Band 25) (Band 26) (Band 66)	< 43+10log ₁₀ (P[Watts])	PASS	-
3.9	§2.1055 §22.355	Frequency Stability Temperature & Voltage	< 2.5 ppm for Part 22	PASS	-
	§2.1055 §24.235 §27.54		Within Authorized Band		
4.4	§2.1053 §22.917(a) §24.238(a) §27.53(c)(2) §27.53(f) §27.53(g) §27.53(h)	Radiated Spurious Emission (Band 2) (Band 4) (Band 5) (Band 12) (Band 13) (Band 17) (Band 25) (Band 26) (Band 66)	< 43+10log ₁₀ (P[Watts])	PASS	Under limit 11.18 dB at 1560.00 MHz

Declaration of Conformity:
The test results with all measurement uncertainty excluded are presented in accordance with the regulation limits or requirements declared by manufacturers.

Comments and Explanations:
The declared of product specification for EUT presented in the report are provided by the manufacturer, and the manufacturer takes all the responsibilities for the accuracy of product specification.



1 General Description

1.1 Applicant

Motorola Mobility LLC
222 W, Merchandise Mart Plaza, Chicago IL 60654 USA

1.2 Manufacturer

Motorola Mobility LLC
222 W, Merchandise Mart Plaza, Chicago IL 60654 USA

1.3 Product Feature of Equipment Under Test

Product Feature	
Equipment	Mobile Cellular Phone
Brand Name	Motorola
Model Name	XT2317-1, XT2317-2, XT2317-3, XT2317DL
FCC ID	IHDT56AL4
IMEI Code	Conducted: 359026430016032 Radiation: 359026430016685
HW Version	DVT2
SW Version	T1TH33.27
EUT Stage	Identical Prototype

Remark:

1. The above EUT's information was declared by manufacturer. Please refer to the specifications or user's manual for more detailed description.
2. The four model name XT2317-1, XT2317-2, XT2317-3, XT2317DL are the same product except model name different for market segment.



1.4 Product Specification of Equipment Under Test

Standards-related Product Specification	
Tx Frequency	LTE Band 2 : 1850 MHz ~ 1910 MHz LTE Band 4 : 1710 MHz ~ 1755 MHz LTE Band 5 : 824 MHz ~ 849 MHz LTE Band 12 : 699 MHz ~ 716 MHz LTE Band 13 : 777 MHz ~ 787 MHz LTE Band 17 : 704 MHz ~ 716 MHz LTE Band 25 : 1850 MHz ~ 1915 MHz LTE Band 26 : 824 MHz ~ 849 MHz LTE Band 66 : 1710 MHz ~ 1780 MHz
Rx Frequency	LTE Band 2 : 1930 MHz ~ 1990 MHz LTE Band 4 : 2110 MHz ~ 2155 MHz LTE Band 5 : 869 MHz ~ 894 MHz LTE Band 12 : 729 MHz ~ 746 MHz LTE Band 13 : 746 MHz ~ 756 MHz LTE Band 17 : 734 MHz ~ 746 MHz LTE Band 25 : 1930 MHz ~ 1995 MHz LTE Band 26 : 869 MHz ~ 894 MHz LTE Band 66 : 2110 MHz~ 2200 MHz
Bandwidth	LTE Band 2 : 1.4MHz / 3MHz / 5MHz / 10MHz / 15MHz / 20MHz LTE Band 4 : 1.4MHz / 3MHz / 5MHz / 10MHz / 15MHz / 20MHz LTE Band 5 : 1.4MHz / 3MHz / 5MHz / 10MHz LTE Band 12 : 1.4MHz / 3MHz / 5MHz / 10MHz LTE Band 13 : 5MHz / 10MHz LTE Band 17 : 5MHz / 10MHz LTE Band 25 : 1.4MHz / 3MHz / 5MHz / 10MHz / 15MHz / 20MHz LTE Band 26 : 1.4MHz / 3MHz / 5MHz / 10MHz / 15MHz LTE Band 66 : 1.4MHz / 3MHz / 5MHz / 10MHz / 15MHz / 20MHz
Maximum Output Power to Antenna	<Ant. 0>: LTE Band 2 : 22.28 dBm LTE Band 4 : 22.22 dBm LTE Band 5 : 22.53 dBm LTE Band 12 : 22.39 dBm LTE Band 13 : 22.27 dBm LTE Band 17 : 22.34 dBm LTE Band 25 : 22.34 dBm LTE Band 26 : 22.58 dBm LTE Band 66 : 22.25 dBm <Ant. 3>: LTE Band 2 : 21.25 dBm LTE Band 5 : 21.65 dBm LTE Band 12 : 21.33 dBm LTE Band 13 : 21.21 dBm LTE Band 17 : 21.30 dBm LTE Band 25 : 21.30 dBm LTE Band 26 : 21.68 dBm
Antenna Gain	<Ant. 0>: LTE Band 2 : 0.84 dBi LTE Band 4 : 1.25 dBi LTE Band 5 : -2.45 dBi LTE Band 12 : -3.36 dBi LTE Band 13 : -4.30 dBi LTE Band 17 : -3.56 dBi LTE Band 25 : 0.84 dBi



	LTE Band 26 : -2.45 dBi LTE Band 66 : 1.29 dBi <Ant. 3>: LTE Band 2 : -0.80 dBi LTE Band 5 : -5.00 dBi LTE Band 12 : -6.30 dBi LTE Band 13 : -8.40 dBi LTE Band 17 : -6.30 dBi LTE Band 25 : -0.80 dBi LTE Band 26 : -5.00 dBi
Type of Modulation	QPSK / 16QAM / 64QAM

Note: The maximum ERP/EIRP is calculated from output power and antenna gain, only the maximum ERP/EIRP of Ant.0 are shown in the report.

1.5 Modification of EUT

No modifications are made to the EUT during all test items.

1.6 Specification of Accessory

Specification of Accessory				
AC Adapter 1	Brand Name	Motorola (Aohai)	Model Name	MC-101
AC Adapter 2	Brand Name	Motorola (Salcomp)	Model Name	MC-101
AC Adapter 3	Brand Name	Motorola (Chenyang)	Model Name	MC-101
Battery 1	Brand Name	Motorola (ATL)	Model Name	PG50
Battery 2	Brand Name	Motorola (SCUD)	Model Name	PG50
Earphone	Brand Name	Motorola (New Leader)	Model Name	MH191
USB Cable 1	Brand Name	Motorola (SAIBAO)	Model Name	SWT-A120A
USB Cable 2	Brand Name	Motorola (NAEE)	Model Name	1.1.0157
USB Cable 3	Brand Name	Motorola (WASHIN)	Model Name	HX-WT-40



1.7 Maximum ERP/EIRP Power and Emission Designator

LTE Band 2		QPSK		16QAM/64QAM	
BW (MHz)	Frequency Range (MHz)	Maximum EIRP(W)	Emission Designator (99%OBW)	Maximum EIRP(W)	Emission Designator (99%OBW)
1.4	1850.7 ~ 1909.3	0.2023	1M09G7D	0.1667	1M09W7D
3	1851.5 ~ 1908.5	0.2042	2M70G7D	0.1652	2M70W7D
5	1852.5 ~ 1907.5	0.2032	4M50G7D	0.1656	4M49W7D
10	1855.0 ~ 1905.0	0.2018	9M09G7D	0.1652	9M03W7D
15	1857.5 ~ 1902.5	0.2037	13M5G7D	0.1663	13M6W7D
20	1860.0 ~ 1900.0	0.2051	17M9G7D	0.1679	17M9W7D
LTE Band 25		QPSK		16QAM/64QAM	
BW (MHz)	Frequency Range (MHz)	Maximum EIRP(W)	Emission Designator (99%OBW)	Maximum EIRP(W)	Emission Designator (99%OBW)
1.4	1850.7 ~ 1914.3	0.2018	1M09G7D	0.1644	1M09W7D
3	1851.5 ~ 1913.5	0.2056	2M70G7D	0.1652	2M70W7D
5	1852.5 ~ 1912.5	0.2065	4M50G7D	0.1683	4M49W7D
10	1855.0 ~ 1910.0	0.2056	9M09G7D	0.1679	9M03W7D
15	1857.5 ~ 1907.5	0.2046	13M5G7D	0.1698	13M6W7D
20	1860.0 ~ 1905.0	0.2080	17M9G7D	0.1706	17M9W7D
LTE Band 4		QPSK		16QAM/64QAM	
BW (MHz)	Frequency Range (MHz)	Maximum EIRP(W)	Emission Designator (99%OBW)	Maximum EIRP(W)	Emission Designator (99%OBW)
1.4	1710.7 ~ 1754.3	0.2218	1M08G7D	0.1901	1M10W7D
3	1711.5 ~ 1753.5	0.2203	2M70G7D	0.1888	2M72W7D
5	1712.5 ~ 1752.5	0.2218	4M48G7D	0.1888	4M49W7D
10	1715.0 ~ 1750.0	0.2188	9M03G7D	0.1837	9M01W7D
15	1717.5 ~ 1747.5	0.2218	13M5G7D	0.1888	13M5W7D
20	1720.0 ~ 1745.0	0.2223	18M4G7D	0.1905	18M3W7D
LTE Band 66		QPSK		16QAM/64QAM	
BW (MHz)	Frequency Range (MHz)	Maximum EIRP(W)	Emission Designator (99%OBW)	Maximum EIRP(W)	Emission Designator (99%OBW)
1.4	1710.7 ~ 1779.3	0.2254	1M08G7D	0.1862	1M10W7D
3	1711.5 ~ 1778.5	0.2239	2M70G7D	0.1837	2M72W7D
5	1712.5 ~ 1777.5	0.2244	4M48G7D	0.1858	4M49W7D
10	1715.0 ~ 1775.0	0.2234	9M03G7D	0.1866	9M01W7D
15	1717.5 ~ 1772.5	0.2239	13M5G7D	0.1816	13M5W7D
20	1720.0 ~ 1770.0	0.2259	18M4G7D	0.1866	18M3W7D



LTE Band 5		QPSK		16QAM/64QAM	
BW (MHz)	Frequency Range (MHz)	Maximum ERP(W)	Emission Designator (99%OBW)	Maximum ERP(W)	Emission Designator (99%OBW)
1.4	824.7 ~ 848.3	0.0619	1M09G7D	0.0498	1M09W7D
3	825.5 ~ 847.5	0.0617	2M72G7D	0.0497	2M69W7D
5	826.5 ~ 846.5	0.0600	4M48G7D	0.0494	4M48W7D
10	829.0 ~ 844.0	0.0621	9M09G7D	0.0499	9M07W7D
LTE Band 26		QPSK		16QAM/64QAM	
BW (MHz)	Frequency Range (MHz)	Maximum ERP(W)	Emission Designator (99%OBW)	Maximum ERP(W)	Emission Designator (99%OBW)
1.4	824.7 ~ 848.3	0.0617	1M09G7D	0.0474	1M09W7D
3	825.5 ~ 847.5	0.0617	2M72G7D	0.0481	2M69W7D
5	826.5 ~ 846.5	0.0619	4M48G7D	0.0488	4M48W7D
10	829.0 ~ 844.0	0.0615	9M09G7D	0.0475	9M07W7D
15	831.5 ~ 841.5	0.0628	13M4G7D	0.0498	13M6W7D
CH26790	824.0	0.0607	13M4G7D	0.0478	13M4W7D
LTE Band 12		QPSK		16QAM/64QAM	
BW (MHz)	Frequency Range (MHz)	Maximum ERP(W)	Emission Designator (99%OBW)	Maximum ERP(W)	Emission Designator (99%OBW)
1.4	699.7 ~ 715.3	0.0480	1M09G7D	0.0388	1M09W7D
3	700.5 ~ 714.5	0.0482	2M71G7D	0.0389	2M72W7D
5	701.5 ~ 713.5	0.0482	4M54G7D	0.0389	4M48W7D
10	704.0 ~ 711.0	0.0488	9M09G7D	0.0393	9M05W7D
LTE Band 13		QPSK		16QAM/64QAM	
BW (MHz)	Frequency Range (MHz)	Maximum ERP(W)	Emission Designator (99%OBW)	Maximum ERP(W)	Emission Designator (99%OBW)
5	779.5 ~ 784.5	0.0378	4M52G7D	0.0306	4M48W7D
10	782.0	0.0382	9M09G7D	0.0310	8M99W7D
LTE Band 17		QPSK		16QAM/64QAM	
BW (MHz)	Frequency Range (MHz)	Maximum ERP(W)	Emission Designator (99%OBW)	Maximum ERP(W)	Emission Designator (99%OBW)
5	706.5 ~ 713.5	0.0448	4M54G7D	0.0375	4M48W7D
10	709.0 ~ 711.0	0.0460	9M09G7D	0.0385	9M05W7D

Note:

1. LTE Band 26 overlaps the entire frequency range of LTE Band 5. Therefore, the test results provided in this report covers Band 5 and the portion of Band 26 subject to Part 22.
2. LTE Band 66 overlaps the entire frequency range of LTE Band 4. Therefore, the test results provided in this report covers Band 66 as well as Band 4.
3. LTE Band 25 overlaps the entire frequency range of LTE Band 2. Therefore, the test results provided in this report covers Band 25 as well as Band 2.
4. LTE Band 12 overlaps the entire frequency range of LTE Band 17. Therefore, the test results provided in this report covers Band 12 as well as Band 17.
5. All modulations have been tested, and only the worst test results of PSK & QAM are shown in the report.



1.8 Testing Location

Sporton International Inc. (Kunshan) is accredited to ISO/IEC 17025:2017 by American Association for Laboratory Accreditation with Certificate Number 5145.02.

Test Firm	Sporton International Inc. (Kunshan)		
Test Site Location	No. 1098, Pengxi North Road, Kunshan Economic Development Zone Jiangsu Province 215300 People's Republic of China TEL : +86-512-57900158 FAX : +86-512-57900958		
Test Site No.	Sporton Site No.	FCC Designation No.	FCC Test Firm Registration No.
	03CH06-KS TH01-KS	CN1257	314309

1.9 Test Software

Item	Site	Manufacture	Name	Version
1.	03CH06-KS	AUDIX	E3	6.2009-8-24al

1.10 Applicable Standards

According to the specifications of the manufacturer, the EUT must comply with the requirements of the following standards:

- 47 CFR Part 2, 22(H), 24(E), 27(L) , 27(H) , 27(F)
- ANSI C63.26-2015
- FCC KDB 971168 D01 Power Meas License Digital Systems v03r01
- FCC KDB 412172 D01 Determining ERP and EIRP v01r01

Remark:

1. All test items were verified and recorded according to the standards and without any deviation during the test.
2. This EUT has also been tested and complied with the requirements of FCC Part 15, Subpart B, recorded in a separate test report.



2 Test Configuration of Equipment Under Test

2.1 Test Mode

Antenna port conducted and radiated test items listed below are performed according to KDB 971168 D01 Power Meas License Digital Systems v03r01 with maximum output power.

Radiated measurements are performed by rotating the EUT in three different orthogonal test planes to find the maximum emission(Y Plane).

Test Items	Band	Bandwidth (MHz)						Modulation				RB #			Test Channel		
		1.4	3	5	10	15	20	QPSK	16QAM	64QAM	256QAM	1	Half	Full	L	M	H
Max. Output Power	2	v	v	v	v	v	v	v	v	v	-	v		v	v	v	v
	4	v	v	v	v	v	v	v	v	v	-	v		v	v	v	v
	5	v	v	v	v	-	-	v	v	v	-	v		v	v	v	v
	12	v	v	v	v	-	-	v	v	v	-	v		v	v	v	v
	13	-	-	v	v	-	-	v	v	v	-	v		v	v	v	v
	17	-	-	v	v	-	-	v	v	v	-	v		v	v	v	v
	25	v	v	v	v	v	v	v	v	v	-	v		v	v	v	v
	26	v	v	v	v	v	-	v	v	v	-	v		v	v	v	v
	66	v	v	v	v	v	v	v	v	v	-	v		v	v	v	v
Peak-to-Average Ratio	12				v	-	-	v	v	v	-			v		v	
	13	-	-		v	-	-	v	v	v	-			v		v	
	25						v	v	v	v	-			v		v	
	26					v	-	v	v	v	-			v		v	
	66						v	v	v	v	-			v		v	
26dB and 99% Bandwidth	12	v	v	v	v	-	-	v	v		-			v		v	
	13	-	-	v	v	-	-	v	v		-			v		v	
	25	v	v	v	v	v	v	v	v		-			v		v	
	26	v	v	v	v	v	-	v	v		-			v		v	
	66	v	v	v	v	v	v	v	v		-			v		v	



Test Items	Band	Bandwidth (MHz)						Modulation				RB #			Test Channel			
		1.4	3	5	10	15	20	QPSK	16QAM	64QAM	256QAM	1	Half	Full	L	M	H	
Conducted BandEdge	12	v	v	v	v	-	-	v	v	v	-	v		v	v	v		v
	13	-	-	v	v	-	-	v	v	v	-	v		v	v	v		v
	25	v	v	v	v	v	v	v	v	v	-	v		v	v	v		v
	26	v	v	v	v	v	-	v	v	v	-	v		v	v	v		v
	66	v	v	v	v	v	v	v	v	v	-	v		v	v	v		v
Conducted Spurious Emission	12	v	v	v	v	-	-	v			-	v			v	v	v	
	13	-	-	v	v	-	-	v			-	v			v	v	v	
	25	v	v	v	v	v	v	v			-	v			v	v	v	
	26	v	v	v	v	v	-	v			-	v			v	v	v	
	66	v	v	v	v	v	v	v			-	v			v	v	v	
Frequency Stability	12				v	-	-	v			-			v		v		
	13	-	-		v	-	-	v			-			v		v		
	25				v			v			-			v		v		
	26				v		-	v			-			v		v		
	66				v			v			-			v		v		
E.R.P / E.I.R.P	5	v	v	v	v	-	-	v	v	v	-	v		v	v	v	v	v
	12	v	v	v	v	-	-	v	v	v	-	v		v	v	v	v	v
	13	-	-	v	v	-	-	v	v	v	-	v		v	v	v	v	v
	25	v	v	v	v	v	v	v	v	v	-	v		v	v	v	v	v
	26	v	v	v	v	v	-	v	v	v	-	v		v	v	v	v	v
	66	v	v	v	v	v	v	v	v	v	-	v		v	v	v	v	v
Radiated Spurious Emission	12	Worst Case													v	v	v	
	13	Worst Case													v	v	v	
	25	Worst Case													v	v	v	
	26	Worst Case													v	v	v	
	66	Worst Case													v	v	v	
Note	<ol style="list-style-type: none"> The mark "v" means that this configuration is chosen for testing The mark "-" means that this bandwidth is not supported. The device is investigated from 30MHz to 10 times of fundamental signal for radiated spurious emission test under different RB size/offset and modulations in exploratory test. Subsequently, only the worst case emissions are reported. All test items are based on engineering evaluation. 																	

2.2 Connection Diagram of Test System

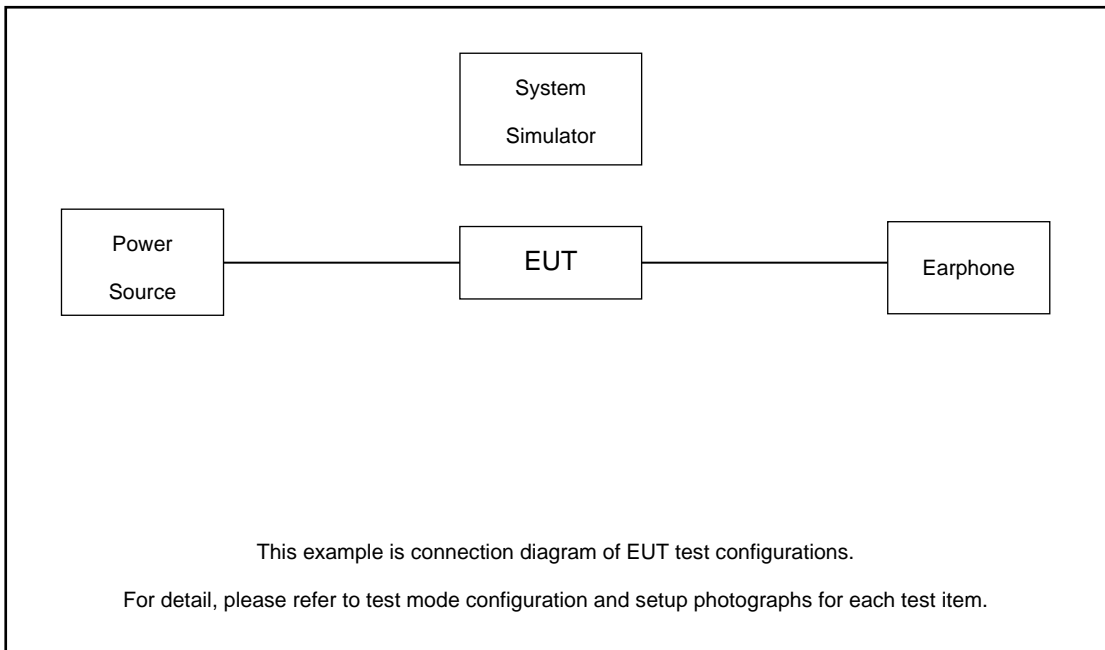

2.3 Support Unit used in test configuration and system

Item	Equipment	Trade Name	Model No.	FCC ID	Data Cable	Power Cord
1.	Power Supply	GWINSTEK	PSS-2002	N/A	N/A	Unshielded, 1.8 m
2.	LTE Base Station	Anritsu	MT8820/8821	N/A	N/A	Unshielded, 1.8 m

2.4 Measurement Results Explanation Example

For all conducted test items:

The offset level is set in the spectrum analyzer to compensate the RF cable loss between EUT conducted output port and spectrum analyzer. With the offset compensation, the spectrum analyzer reading level is exactly the EUT RF output level.

The spectrum analyzer offset is derived from RF cable loss.

Offset = RF cable loss.

Following shows an offset computation example with cable loss 4.6 dB.

Example :

$$\begin{aligned} \text{Offset(dB)} &= \text{RF cable loss(dB)}. \\ &= 4.6 \text{ (dB)} \end{aligned}$$



2.5 Frequency List of Low/Middle/High Channels

LTE Band 2 Channel and Frequency List				
BW [MHz]	Channel/Frequency(MHz)	Lowest	Middle	Highest
20	Channel	18700	18900	19100
	Frequency	1860	1880	1900
15	Channel	18675	18900	19125
	Frequency	1857.5	1880	1902.5
10	Channel	18650	18900	19150
	Frequency	1855	1880	1905
5	Channel	18625	18900	19175
	Frequency	1852.5	1880	1907.5
3	Channel	18615	18900	19185
	Frequency	1851.5	1880	1908.5
1.4	Channel	18607	18900	19193
	Frequency	1850.7	1880	1909.3

LTE Band 4 Channel and Frequency List				
BW [MHz]	Channel/Frequency(MHz)	Lowest	Middle	Highest
20	Channel	20050	20175	20300
	Frequency	1720	1732.5	1745
15	Channel	20025	20175	20325
	Frequency	1717.5	1732.5	1747.5
10	Channel	20000	20175	20350
	Frequency	1715	1732.5	1750
5	Channel	19975	20175	20375
	Frequency	1712.5	1732.5	1752.5
3	Channel	19965	20175	20385
	Frequency	1711.5	1732.5	1753.5
1.4	Channel	19957	20175	20393
	Frequency	1710.7	1732.5	1754.3



LTE Band 5 Channel and Frequency List				
BW [MHz]	Channel/Frequency(MHz)	Lowest	Middle	Highest
10	Channel	20450	20525	20600
	Frequency	829	836.5	844
5	Channel	20425	20525	20625
	Frequency	826.5	836.5	846.5
3	Channel	20415	20525	20635
	Frequency	825.5	836.5	847.5
1.4	Channel	20407	20525	20643
	Frequency	824.7	836.5	848.3

LTE Band 12 Channel and Frequency List				
BW [MHz]	Channel/Frequency(MHz)	Lowest	Middle	Highest
10	Channel	23060	23095	23130
	Frequency	704	707.5	711
5	Channel	23035	23095	23155
	Frequency	701.5	707.5	713.5
3	Channel	23025	23095	23165
	Frequency	700.5	707.5	714.5
1.4	Channel	23017	23095	23173
	Frequency	699.7	707.5	715.3

LTE Band 13 Channel and Frequency List				
BW [MHz]	Channel/Frequency(MHz)	Lowest	Middle	Highest
10	Channel	-	23230	-
	Frequency	-	782	-
5	Channel	23205	23230	23255
	Frequency	779.5	782	784.5



LTE Band 17 Channel and Frequency List				
BW [MHz]	Channel/Frequency(MHz)	Lowest	Middle	Highest
10	Channel	23780	23790	23800
	Frequency	709	710	711
5	Channel	23755	23790	23825
	Frequency	706.5	710	713.5

LTE Band 25 Channel and Frequency List				
BW [MHz]	Channel/Frequency(MHz)	Lowest	Middle	Highest
20	Channel	26140	26340	26590
	Frequency	1860	1880	1905
15	Channel	26115	26340	26615
	Frequency	1857.5	1880	1907.5
10	Channel	26090	26340	26640
	Frequency	1855	1880	1910
5	Channel	26065	26340	26665
	Frequency	1852.5	1880	1912.5
3	Channel	26055	26340	26675
	Frequency	1851.5	1880	1913.5
1.4	Channel	26047	26340	26683
	Frequency	1850.7	1880	1914.3

LTE Band 26 Channel and Frequency List				
BW [MHz]	Channel/Frequency(MHz)	Lowest	Middle	Highest
15	Channel	26865	26915	26965
	Frequency	831.5	836.5	841.5
10	Channel	26840	26915	26990
	Frequency	829	836.5	844
5	Channel	26815	26915	27015
	Frequency	826.5	836.5	846.5
3	Channel	26805	26915	27025
	Frequency	825.5	836.5	847.5
1.4	Channel	26797	26915	27033
	Frequency	824.7	836.5	848.3



LTE Band 26 Cross-rule Channel and Frequency List				
BW [MHz]	Channel/Frequency(MHz)	-	Middle	-
15	Channel	-	26790	-
	Frequency	-	824	-
10	Channel	-	26790	-
	Frequency	-	824	-
5	Channel	-	26790	-
	Frequency	-	824	-
3	Channel	-	26790	-
	Frequency	-	824	-
1.4	Channel	-	26790	-
	Frequency	-	824	-

LTE Band 66 Channel and Frequency List				
BW [MHz]	Channel/Frequency(MHz)	Lowest	Middle	Highest
20	Channel	132072	132322	132572
	Frequency	1720	1745	1770
15	Channel	132047	132322	132597
	Frequency	1717.5	1745	1772.5
10	Channel	132022	132322	132622
	Frequency	1715	1745	1775
5	Channel	131997	132322	132647
	Frequency	1712.5	1745	1777.5
3	Channel	131987	132322	132657
	Frequency	1711.5	1745	1778.5
1.4	Channel	131979	132322	132665
	Frequency	1710.7	1745	1779.3

3 Conducted Test Items

3.1 Measuring Instruments

See list of measuring instruments of this test report.

3.2 Test Setup

3.2.1 Conducted Output Power

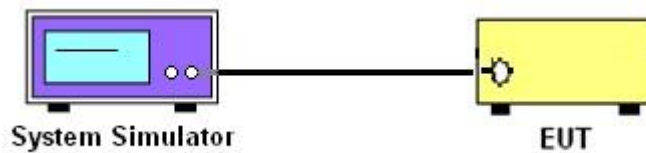

3.2.2 Peak-to-Average Ratio, Occupied Bandwidth, Conducted Band-Edge and Conducted Spurious Emission

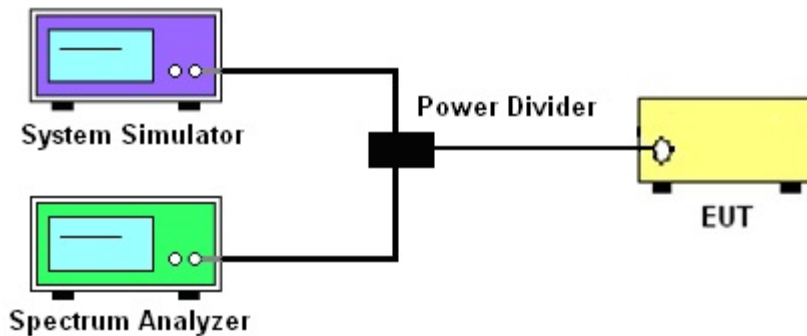

3.2.3 Frequency Stability

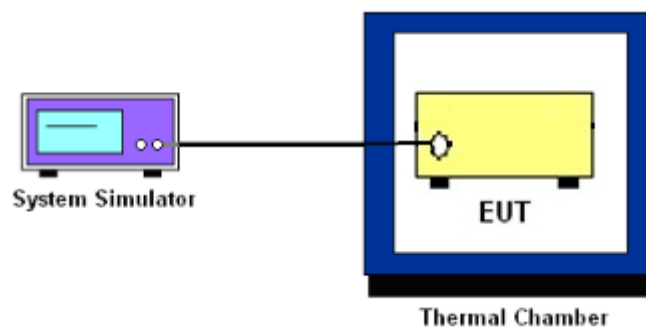

3.3 Test Result of Conducted Test

Please refer to Appendix A.



3.4 Conducted Output Power and ERP/EIRP

3.4.1 Description of the Conducted Output Power Measurement and ERP/EIRP Measurement

A system simulator was used to establish communication with the EUT. Its parameters were set to force the EUT transmitting at maximum output power. The measured power in the radio frequency on the transmitter output terminals shall be reported.

The ERP of mobile transmitters must not exceed 7 Watts for LTE Band 5 and Band 26.

The ERP of mobile transmitters must not exceed 3 Watts for LTE Band 12, Band 13 and Band 17.

The EIRP of mobile transmitters must not exceed 2 Watts for LTE Band 2 and Band 25.

The EIRP of mobile transmitters must not exceed 1 Watts for LTE Band 4 and Band 66.

According to KDB 412172 D01 Power Approach,

$EIRP = P_T + G_T - L_C$, $ERP = EIRP - 2.15$, where

P_T = transmitter output power in dBm

G_T = gain of the transmitting antenna in dBi

L_C = signal attenuation in the connecting cable between the transmitter and antenna in dB

3.4.2 Test Procedures

1. The testing follows ANSI C63.26 Section 5.2
2. The transmitter output port was connected to the system simulator.
3. Set EUT at maximum power through the system simulator.
4. Select lowest, middle, and highest channels for each band and different modulation.
5. Measure and record the power level from the system simulator.



3.5 Peak-to-Average Ratio

3.5.1 Description of the PAR Measurement

Power Complementary Cumulative Distribution Function (CCDF) curves provide a means for characterizing the power peaks of a digitally modulated signal on a statistical basis. A CCDF curve depicts the probability of the peak signal amplitude exceeding the average power level. Most contemporary measurement instrumentation include the capability to produce CCDF curves for an input signal provided that the instrument's resolution bandwidth can be set wide enough to accommodate the entire input signal bandwidth. In measuring transmissions in this band using an average power technique, the peak-to-average ratio (PAR) of the transmission may not exceed 13 dB.

3.5.2 Test Procedures

1. The testing follows ANSI C63.26 Section 5.2.3.4 (CCDF).
2. The EUT was connected to spectrum and system simulator via a power divider.
3. Set the CCDF (Complementary Cumulative Distribution Function) option in spectrum analyzer.
4. The highest RF powers were measured and recorded the maximum PAPR level associated with a probability of 0.1 %.
5. Record the deviation as Peak to Average Ratio.



3.6 Occupied Bandwidth

3.6.1 Description of Occupied Bandwidth Measurement

The occupied bandwidth is the width of a frequency band such that, below the lower and above the upper frequency limits, the mean powers emitted are each equal to a specified percentage 0.5% of the total mean transmitted power.

The 26 dB emission bandwidth is defined as the frequency range between two points, one above and one below the carrier frequency, at which the spectral density of the emission is attenuated 26 dB below the maximum in-band spectral density of the modulated signal. Spectral density (power per unit bandwidth) is to be measured with a detector of resolution bandwidth equal to approximately 1.0% of the emission bandwidth.

3.6.2 Test Procedures

1. The testing follows ANSI C63.26 Section 5.4
2. The EUT was connected to spectrum analyzer and system simulator via a power divider.
3. The spectrum analyzer center frequency is set to the nominal EUT channel center frequency. The span range for the spectrum analyzer shall be between two and five times the anticipated OBW.
4. The nominal resolution bandwidth (RBW) shall be in the range of 1 to 5 % of the anticipated OBW, and the VBW shall be at least 3 times the RBW.
5. Set the detection mode to peak, and the trace mode to max hold.
6. Determine the reference value: Set the EUT to transmit a modulated signal. Allow the trace to stabilize. Set the spectrum analyzer marker to the highest level of the displayed trace.
(this is the reference value)
7. Determine the “-26 dB down amplitude” as equal to (Reference Value – X).
8. Place two markers, one at the lowest and the other at the highest frequency of the envelope of the spectral display such that each marker is at or slightly below the “-X dB down amplitude” determined in step 6. If a marker is below this “-X dB down amplitude” value it shall be placed as close as possible to this value. The OBW is the positive frequency difference between the two markers.
9. Use the 99 % power bandwidth function of the spectrum analyzer and report the measured bandwidth.



3.7 Conducted Band Edge

3.7.1 Description of Conducted Band Edge Measurement

22.917(a)

For operations in the 824 – 849 MHz band, the FCC limit is $43 + 10\log_{10}(P[\text{Watts}])$ dB below the transmitter power $P(\text{Watts})$ in a 100kHz bandwidth. However, in the 1MHz bands immediately outside and adjacent to the licensee's frequency block, a resolution bandwidth of at least one percent of the emission bandwidth of the fundamental emission of the transmitter may be employed.

24.238 (a)

For operations in the 1850-1910 and 1930-1990 MHz band, the FCC limit is $43 + 10\log_{10}(P[\text{Watts}])$ dB below the transmitter power $P(\text{Watts})$ in a 1MHz bandwidth. However, in the 1 MHz bands immediately outside and adjacent to the frequency block a resolution bandwidth of at least one percent of the emission bandwidth of the fundamental emission of the transmitter may be employed.

27.53 (c)

For operations in the 776-788 MHz band, the FCC limit is $43 + 10\log_{10}(P[\text{Watts}])$ dB below the transmitter power $P(\text{Watts})$ in a 100 kHz bandwidth. However, in the 100 kHz bands immediately outside and adjacent to the frequency block, a resolution bandwidth of at least 30 kHz may be employed. In addition, the power of any unwanted emissions in any 6.25 kHz bandwidth for all frequencies between 763-775 MHz and 793-806 MHz shall be attenuated below the transmitter power, P (dBW), by at least $65 + 10 \log_{10} p(\text{watts})$, dB, for mobile and portable equipment.

27.53 (g)

For operations in the 600MHz band and 698 -746 MHz band, the FCC limit is $43 + 10\log_{10}(P[\text{Watts}])$ dB below the transmitter power $P(\text{Watts})$ in a 100 kHz bandwidth. However, in the 100 kilohertz bands immediately outside and adjacent to a licensee's frequency block, a resolution bandwidth of at least 30 kHz may be employed.

27.53 (h)

For operations in the 1710 – 1755 MHz band, the FCC limit is $43 + 10\log_{10}(P[\text{Watts}])$ dB below the transmitter power $P(\text{Watts})$ in a 1 MHz bandwidth. However, in the 1MHz bands immediately outside and adjacent to the licensee's frequency block, a resolution bandwidth of at least one percent of the emission bandwidth of the fundamental emission of the transmitter may be employed.



3.7.2 Test Procedures

1. The testing follows ANSI C63.26 section 5.7
2. The EUT was connected to spectrum analyzer and system simulator via a power divider.
3. The band edges of low and high channels for the highest RF powers were measured.
4. Set RBW \geq 1% EBW in the 1MHz band immediately outside and adjacent to the band edge.
5. Beyond the 1 MHz band from the band edge, RBW=1MHz was used.
6. Set spectrum analyzer with RMS detector.
7. The RF fundamental frequency should be excluded against the limit line in the operating frequency band.
8. Checked that all the results comply with the emission limit line.

Example:

The limit line is derived from $43 + 10\log(P)$ dB below the transmitter power P(Watts)

$$= P(W) - [43 + 10\log(P)] \text{ (dB)}$$

$$= [30 + 10\log(P)] \text{ (dBm)} - [43 + 10\log(P)] \text{ (dB)} = -13\text{dBm}.$$

9. When using the integration method, the starting frequency of the integration shall be centered at one-half of the RBW away from the band edge.



3.8 Conducted Spurious Emission

3.8.1 Description of Conducted Spurious Emission Measurement

The power of any emission outside of the authorized operating frequency ranges must be lower than the transmitter power (P) by a factor of at least $43 + 10 \log (P)$ dB.

It is measured by means of a calibrated spectrum analyzer and scanned from 30 MHz up to a frequency including its 10th harmonic.

3.8.2 Test Procedures

1. The testing follows ANSI C63.26 section 5.7
2. The EUT was connected to spectrum analyzer and system simulator via a power divider.
3. The RF output of EUT was connected to the spectrum analyzer by RF cable and attenuator. The path loss was compensated to the results for each measurement.
4. The middle channel for the highest RF power within the transmitting frequency was measured.
5. The conducted spurious emission for the whole frequency range was taken.
6. Make the measurement with the spectrum analyzer's RBW = 1MHz, VBW = 3MHz.
7. Set spectrum analyzer with RMS detector.
8. Taking the record of maximum spurious emission.
9. The RF fundamental frequency should be excluded against the limit line in the operating frequency band.
10. The limit line is derived from $43 + 10\log(P)$ dB below the transmitter power P(Watts)
= $P(W) - [43 + 10\log(P)]$ (dB)
= $[30 + 10\log(P)]$ (dBm) - $[43 + 10\log(P)]$ (dB)
= -13dBm.



3.9 Frequency Stability

3.9.1 Description of Frequency Stability Measurement

The frequency stability shall be measured by variation of ambient temperature and variation of primary supply voltage to ensure that the fundamental emission stays within the authorized frequency block. The frequency stability of the transmitter shall be maintained within $\pm 0.00025\%$ ($\pm 2.5\text{ppm}$) of the center frequency.

3.9.2 Test Procedures for Temperature Variation

1. The testing follows ANSI C63.26 section 5.6.4
2. The EUT was set up in the thermal chamber and connected with the system simulator.
3. With power OFF, the temperature was decreased to -30°C and the EUT was stabilized before testing. Power was applied and the maximum change in frequency was recorded within one minute.
4. With power OFF, the temperature was raised in 10°C step up to 50°C . The EUT was stabilized at each step for at least half an hour. Power was applied and the maximum frequency change was recorded within one minute.

3.9.3 Test Procedures for Voltage Variation

1. The testing follows ANSI C63.26 section 5.6.5
2. The EUT was placed in a temperature chamber at $20\pm 5^{\circ}\text{C}$ and connected with the system simulator.
3. The power supply voltage to the EUT was varied from 85% to 115% of the nominal value for other than hand carried battery equipment.
4. For hand carried, battery powered equipment, reduce the primary ac or dc supply voltage to the battery operating end point, which shall be specified by the manufacturer.
5. The variation in frequency was measured for the worst case.

4 Radiated Test Items

4.1 Measuring Instruments

See list of measuring instruments of this test report.

4.2 Test Setup

4.2.1 For radiated test below 30MHz

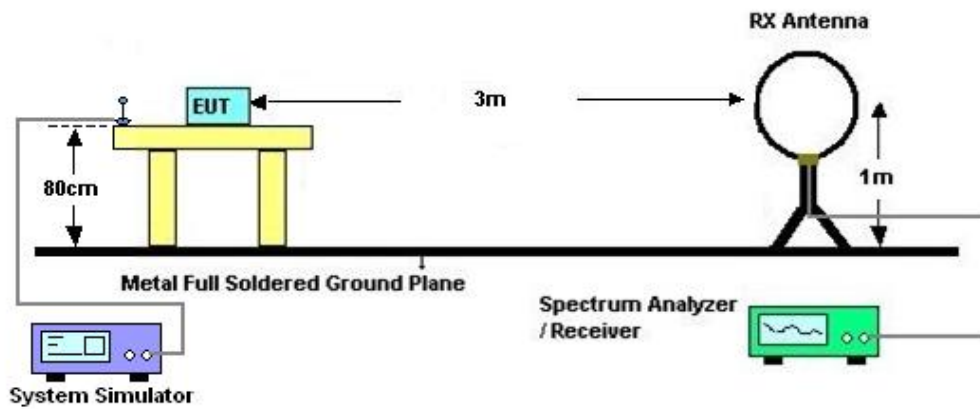

4.2.2 For radiated test from 30MHz to 1GHz

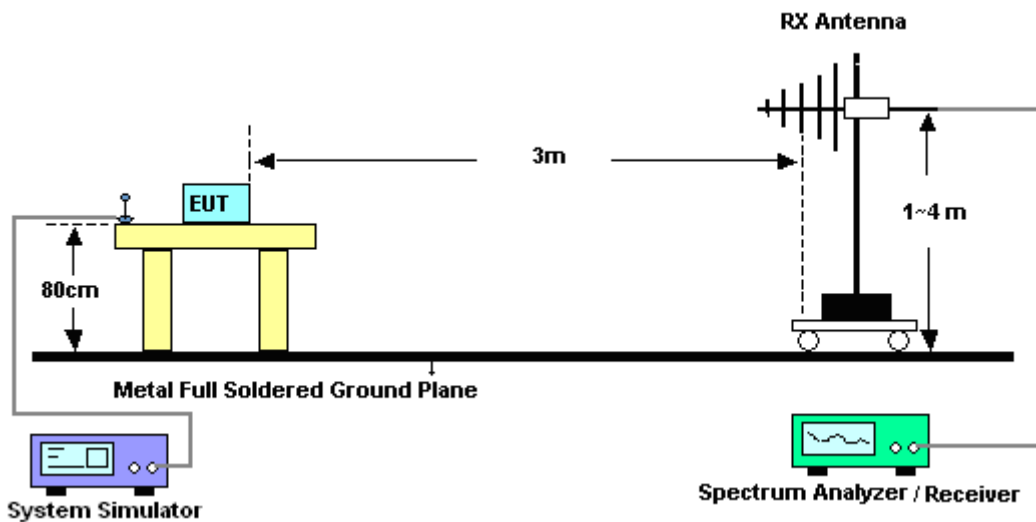

4.2.3 For radiated test above 1GHz

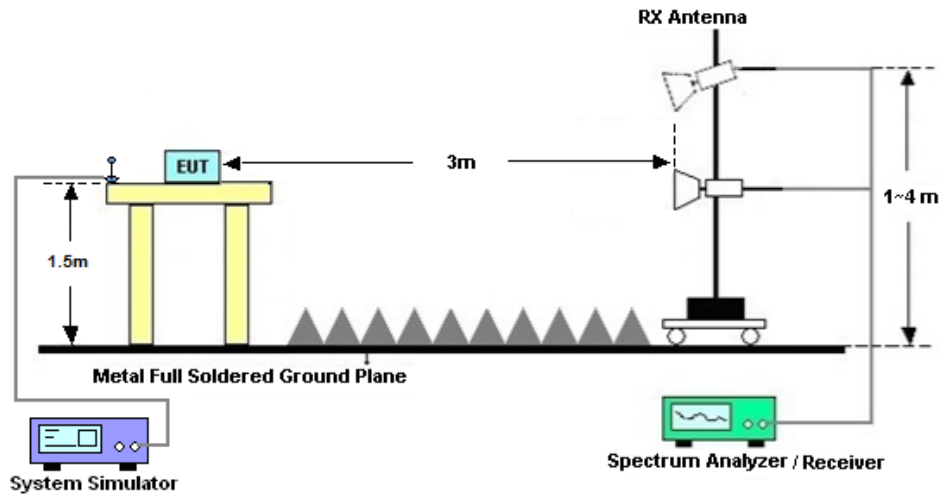

4.3 Test Result of Radiated Test

The low frequency, which started from 9 kHz to 30MHz, was pre-scanned and the result which was 20dB lower than the limit line was not reported.

Please refer to Appendix B.



4.4 Radiated Spurious Emission

4.4.1 Description of Radiated Spurious Emission

The radiated spurious emission was measured by substitution method according to ANSI C63.26. The power of any emission outside of the authorized operating frequency ranges must be attenuated below the transmitter power (P) by a factor of at least $43 + 10 \log(P)$ dB.

For LTE Band 13

For operations in the 746-758 MHz, 775-788 MHz, and 805-806 MHz bands, emissions in the band 1559-1610 MHz shall be limited to -70 dBW/MHz equivalent isotropically radiated power (EIRP) for wideband signals, and -80 dBW EIRP for discrete emissions of less than 700 Hz bandwidth.

The spectrum is scanned from 30 MHz up to a frequency including its 10th harmonic.

4.4.2 Test Procedures

1. The testing follows ANSI C63.26 Section 5.5
2. The EUT was placed on a turntable with 0.8 meter height for frequency below 1GHz and 1.5 meter height for frequency above 1GHz respectively above ground.
3. The EUT was set 3 meters from the receiving antenna mounted on the antenna tower.
4. The table was rotated 360 degrees to determine the position of the highest spurious emission.
5. The height of the receiving antenna is varied between 1m to 4m to search the maximum spurious emission for both horizontal and vertical polarizations.
6. During the measurement, the system simulator parameters were set to force the EUT transmitting at maximum output power.
7. Make the measurement with the spectrum analyzer's RBW = 1MHz, VBW = 3MHz, taking the record of maximum spurious emission.
8. A horn antenna was substituted in place of the EUT and was driven by a signal generator.
9. Tune the output power of signal generator to the same emission level with EUT maximum spurious emission.
10. $EIRP \text{ (dBm)} = S.G. \text{ Power} - Tx \text{ Cable Loss} + Tx \text{ Antenna Gain}$
11. $ERP \text{ (dBm)} = EIRP - 2.15$
12. The RF fundamental frequency should be excluded against the limit line in the operating frequency band.

The limit line is derived from $43 + 10\log(P)$ dB below the transmitter power P(Watts)
 $= P(W) - [43 + 10\log(P)] \text{ (dB)}$
 $= [30 + 10\log(P)] \text{ (dBm)} - [43 + 10\log(P)] \text{ (dB)}$
 $= -13\text{dBm}.$



5 List of Measuring Equipment

Instrument	Manufacturer	Model No.	Serial No.	Characteristics	Calibration Date	Test Date	Due Date	Remark
Spectrum Analyzer	R&S	FSV40	101040	10Hz~40GHz	Oct. 12, 2022	Dec. 21, 2022~ Dec. 25, 2022	Oct. 11, 2023	Conducted (TH01-KS)
Power divider	STI	STI08-0055	-	0.5~40GHz	Aug. 25, 2022	Dec. 21, 2022~ Dec. 25, 2022	Aug. 24, 2023	Conducted (TH01-KS)
Temperature & humidity chamber	Hongzhan	LP-150U	H2014011440	-40~+150°C 20%~95%RH	Jul. 15, 2022	Dec. 21, 2022~ Dec. 25, 2022	Jul. 14, 2023	Conducted (TH01-KS)
EXA Spectrum Analyzer	Keysight	N9010B	MY60242126	10Hz~44GHz	Oct. 13, 2022	Jan. 02, 2023	Oct. 12, 2023	Radiation (03CH06-KS)
Loop Antenna	R&S	HFH2-Z2	100321	9kHz~30MHz	Oct. 16, 2022	Jan. 02, 2023	Oct. 15, 2023	Radiation (03CH06-KS)
Bilog Antenna	TeseQ	CBL6111D	49921	30MHz~1GHz	May 24, 2022	Jan. 02, 2023	May 23, 2023	Radiation (03CH06-KS)
Double Ridge Horn Antenna	ETS-Lindgren	3117	00218642	1GHz~18GHz	Apr. 18, 2022	Jan. 02, 2023	Apr. 17, 2023	Radiation (03CH06-KS)
SHF-EHF Horn	Com-power	AH-840	101093	18GHz~40GHz	Jan. 05, 2022	Jan. 02, 2023	Jan. 04, 2023	Radiation (03CH06-KS)
Amplifier	SONOMA	310N	380827	9KHz ~1GHZ	Jul. 11, 2022	Jan. 02, 2023	Jul. 10, 2023	Radiation (03CH06-KS)
high gain Amplifier	MITEQ	AMF-7D-00 101800-30-1 0P	2082395	1Ghz-18Ghz	Jan. 05, 2022	Jan. 02, 2023	Jan. 04, 2023	Radiation (03CH06-KS)
Amplifier	Keysight	83017A	MY53270319	500MHz~26.5GHz	Oct. 12, 2022	Jan. 02, 2023	Oct. 12, 2023	Radiation (03CH06-KS)
Amplifier	MITEQ	EM18G40G GA	060728	18~40GHz	Jan. 05, 2022	Jan. 02, 2023	Jan. 04, 2023	Radiation (03CH06-KS)
AC Power Source	Chroma	61601	F104090004	N/A	NCR	Jan. 02, 2023	NCR	Radiation (03CH06-KS)
Turn Table	ChamPro	EM 1000-T	060762-T	0~360 degree	NCR	Jan. 02, 2023	NCR	Radiation (03CH06-KS)
Antenna Mast	ChamPro	EM 1000-A	060762-A	1 m~4 m	NCR	Jan. 02, 2023	NCR	Radiation (03CH06-KS)

NCR: No Calibration Required



6 Uncertainty of Evaluation

The measurement uncertainties shown below were calculated in accordance with the requirements of ANSI 63.26-2015. All the measurement uncertainty value were shown with a coverage K=2 to indicate 95% level of confidence. The measurement data show herein meets or exceeds the CISPR measurement uncertainty values specified in CISPR 16-4-2 and can be compared directly to specified limit to determine compliance.

Uncertainty of Conducted Measurement

Test Item	Uncertainty
Conducted Power	±0.46 dB
Conducted Emissions	±0.48 dB
Occupied Channel Bandwidth	±0.1 %

Uncertainty of Radiated Emission Measurement (30 MHz ~ 1000 MHz)

Measuring Uncertainty for a Level of Confidence of 95% (U = 2Uc(y))	2.5dB
---	-------

Uncertainty of Radiated Emission Measurement (1 GHz ~ 18 GHz)

Measuring Uncertainty for a Level of Confidence of 95% (U = 2Uc(y))	2.1dB
---	-------

Uncertainty of Radiated Emission Measurement (18 GHz ~ 40 GHz)

Measuring Uncertainty for a Level of Confidence of 95% (U = 2Uc(y))	2.1dB
---	-------

----- THE END -----



Appendix A. Test Results of Conducted Test

Test Engineer :	Lex Wu	Temperature :	22~23°C
		Relative Humidity :	40~42%

Conducted Output Power(Average power) and ERP/EIRP

LTE Band 2 <Ant.0>:

BW [MHz]	Modulation	RB Size	RB Offset	Power Low Ch. / Freq.	Power Middle Ch. / Freq.	Power High Ch. / Freq.	EIRP(W)		
Channel				18700	18900	19100	EIRP(W)		
Frequency (MHz)				1860	1880	1900	L	M	H
20	QPSK	1	0	22.19	22.28	22.14	0.2009	0.2051	0.1986
20	QPSK	1	99	22.27	22.23	22.23	0.2046	0.2028	0.2028
20	QPSK	100	0	21.25	21.35	21.28	0.1618	0.1656	0.1629
20	16QAM	1	0	21.34	21.33	21.41	0.1652	0.1648	0.1679
20	64QAM	1	0	20.44	20.36	20.31	0.1343	0.1318	0.1303
Channel				18675	18900	19125	EIRP(W)		
Frequency (MHz)				1857.5	1880	1902.5	L	M	H
15	QPSK	1	0	22.13	22.25	22.02	0.1982	0.2037	0.1932
15	16QAM	1	0	21.12	21.20	21.37	0.1570	0.1600	0.1663
Channel				18650	18900	19150	EIRP(W)		
Frequency (MHz)				1855	1880	1905	L	M	H
10	QPSK	1	0	22.12	22.21	22.07	0.1977	0.2018	0.1954
10	16QAM	1	0	21.32	21.12	21.34	0.1644	0.1570	0.1652
Channel				18625	18900	19175	EIRP(W)		
Frequency (MHz)				1852.5	1880	1907.5	L	M	H
5	QPSK	1	0	22.24	22.23	22.24	0.2032	0.2028	0.2032
5	16QAM	1	0	21.09	21.16	21.35	0.1560	0.1585	0.1656
Channel				18615	18900	19185	EIRP(W)		
Frequency (MHz)				1851.5	1880	1908.5	L	M	H
3	QPSK	1	0	22.06	22.26	22.02	0.1950	0.2042	0.1932
3	16QAM	1	0	21.26	21.34	21.32	0.1622	0.1652	0.1644
Channel				18607	18900	19193	EIRP(W)		
Frequency (MHz)				1850.7	1880	1909.3	L	M	H
1.4	QPSK	1	0	22.03	22.08	22.22	0.1936	0.1959	0.2023
1.4	16QAM	1	0	21.30	21.38	21.22	0.1637	0.1667	0.1607



LTE Band 4 <Ant.0>:

BW [MHz]	Modulation	RB Size	RB Offset	Power Low Ch. / Freq.	Power Middle Ch. / Freq.	Power High Ch. / Freq.	EIRP(W)		
Channel				20050	20175	20300	EIRP(W)		
Frequency (MHz)				1720	1732.5	1745	L	M	H
20	QPSK	1	0	22.15	22.22	22.16	0.2188	0.2223	0.2193
20	QPSK	1	99	22.17	22.13	22.20	0.2198	0.2178	0.2213
20	QPSK	100	0	21.27	21.33	21.20	0.1786	0.1811	0.1758
20	16QAM	1	0	21.27	21.30	21.55	0.1786	0.1799	0.1905
20	64QAM	1	0	20.49	20.33	20.25	0.1493	0.1439	0.1413
Channel				20025	20175	20325	EIRP(W)		
Frequency (MHz)				1717.5	1732.5	1747.5	L	M	H
15	QPSK	1	0	22.16	22.21	22.19	0.2193	0.2218	0.2208
15	16QAM	1	0	21.28	21.17	21.51	0.1791	0.1746	0.1888
Channel				20000	20175	20350	EIRP(W)		
Frequency (MHz)				1715	1732.5	1750	L	M	H
10	QPSK	1	0	22.15	22.12	22.14	0.2188	0.2173	0.2183
10	16QAM	1	0	21.25	21.15	21.39	0.1778	0.1738	0.1837
Channel				19975	20175	20375	EIRP(W)		
Frequency (MHz)				1712.5	1732.5	1752.5	L	M	H
5	QPSK	1	0	22.13	22.21	22.12	0.2178	0.2218	0.2173
5	16QAM	1	0	21.16	21.31	21.51	0.1742	0.1803	0.1888
Channel				19965	20175	20385	EIRP(W)		
Frequency (MHz)				1711.5	1732.5	1753.5	L	M	H
3	QPSK	1	0	22.15	22.12	22.18	0.2188	0.2173	0.2203
3	16QAM	1	0	21.25	21.29	21.51	0.1778	0.1795	0.1888
Channel				19950	20175	20393	EIRP(W)		
Frequency (MHz)				1710	1732.5	1754.3	L	M	H
1.4	QPSK	1	0	22.21	22.12	22.16	0.2218	0.2173	0.2193
1.4	16QAM	1	0	21.15	21.24	21.54	0.1738	0.1774	0.1901



LTE Band 5 <Ant.0>:

BW [MHz]	Modulation	RB Size	RB Offset	Power Low Ch. / Freq.	Power Middle Ch. / Freq.	Power High Ch. / Freq.	ERP(W)		
Channel				20450	20525	20600	ERP(W)		
Frequency (MHz)				829	836.5	844	L	M	H
10	QPSK	1	0	22.47	22.53	22.52	0.0612	0.0621	0.0619
10	QPSK	1	49	22.44	22.37	22.44	0.0608	0.0598	0.0608
10	QPSK	50	0	21.39	21.55	21.48	0.0478	0.0495	0.0488
10	16QAM	1	0	21.53	21.45	21.58	0.0493	0.0484	0.0499
10	64QAM	1	0	20.61	20.50	20.53	0.0399	0.0389	0.0392
Channel				20425	20525	20625	ERP(W)		
Frequency (MHz)				826.5	836.5	846.5	L	M	H
5	QPSK	1	0	22.28	22.38	22.38	0.0586	0.0600	0.0600
5	16QAM	1	0	21.45	21.29	21.54	0.0484	0.0467	0.0494
Channel				20415	20525	20635	ERP(W)		
Frequency (MHz)				825.5	836.5	847.5	L	M	H
3	QPSK	1	0	22.29	22.50	22.47	0.0587	0.0617	0.0612
3	16QAM	1	0	21.56	21.41	21.37	0.0497	0.0480	0.0475
Channel				20407	20525	20643	ERP(W)		
Frequency (MHz)				824.7	836.5	848.3	L	M	H
1.4	QPSK	1	0	22.36	22.35	22.52	0.0597	0.0596	0.0619
1.4	16QAM	1	0	21.47	21.44	21.57	0.0486	0.0483	0.0498



LTE Band 12 <Ant.0>:

BW [MHz]	Modulation	RB Size	RB Offset	Power Low Ch. / Freq.	Power Middle Ch. / Freq.	Power High Ch. / Freq.	ERP(W)		
Channel				23060	23095	23130	ERP(W)		
Frequency (MHz)				704	707.5	711	L	M	H
10	QPSK	1	0	22.35	22.39	22.32	0.0483	0.0488	0.0480
10	QPSK	1	49	22.23	22.27	22.30	0.0470	0.0474	0.0478
10	QPSK	50	0	21.35	21.43	21.41	0.0384	0.0391	0.0389
10	16QAM	1	0	21.30	21.33	21.45	0.0379	0.0382	0.0393
10	64QAM	1	0	20.61	20.42	20.53	0.0324	0.0310	0.0318
Channel				23035	23095	23155	ERP(W)		
Frequency (MHz)				701.5	707.5	713.5	L	M	H
5	QPSK	1	0	22.18	22.34	22.31	0.0465	0.0482	0.0479
5	16QAM	1	0	21.29	21.32	21.41	0.0378	0.0381	0.0389
Channel				23025	23095	23165	ERP(W)		
Frequency (MHz)				700.5	707.5	714.5	L	M	H
3	QPSK	1	0	22.34	22.25	22.14	0.0482	0.0472	0.0460
3	16QAM	1	0	21.18	21.35	21.41	0.0369	0.0384	0.0389
Channel				23017	23095	23173	ERP(W)		
Frequency (MHz)				699.7	707.5	715.3	L	M	H
1.4	QPSK	1	0	22.31	22.32	22.13	0.0479	0.0480	0.0459
1.4	16QAM	1	0	21.40	21.12	21.27	0.0388	0.0364	0.0377

LTE Band 13 <Ant.0>:

BW [MHz]	Modulation	RB Size	RB Offset	Power Low Ch. / Freq.	Power Middle Ch. / Freq.	Power High Ch. / Freq.	ERP(W)		
Channel				23230			ERP(W)		
Frequency (MHz)				782				M	
10	QPSK	1	0		22.27			0.0382	
10	QPSK	1	49		22.17			0.0373	
10	QPSK	50	0		21.34			0.0308	
10	16QAM	1	0		21.36			0.0310	
10	64QAM	1	0		20.29			0.0242	
Channel				23205	23230	23255	ERP(W)		
Frequency (MHz)				779.5	782	784.5	L	M	H
5	QPSK	1	0	22.17	22.07	22.22	0.0373	0.0365	0.0378
5	16QAM	1	0	21.22	21.16	21.31	0.0300	0.0296	0.0306



LTE Band 17 <Ant.0>:

BW [MHz]	Modulation	RB Size	RB Offset	Power Low Ch. / Freq.	Power Middle Ch. / Freq.	Power High Ch. / Freq.	ERP(W)		
Channel				23780	23790	23800			
Frequency (MHz)				709	710	711	L	M	H
10	QPSK	1	0	22.31	22.34	22.29	0.0457	0.0460	0.0455
10	QPSK	1	49	22.30	22.23	22.32	0.0456	0.0449	0.0458
10	QPSK	50	0	21.26	21.42	21.39	0.0359	0.0372	0.0370
10	16QAM	1	0	21.49	21.41	21.56	0.0378	0.0372	0.0385
10	64QAM	1	0	20.52	20.44	20.42	0.0303	0.0297	0.0296
Channel				23755	23790	23825	ERP(W)		
Frequency (MHz)				706.5	710	713.5	L	M	H
5	QPSK	1	0	22.19	22.22	22.21	0.0445	0.0448	0.0447
5	16QAM	1	0	21.41	21.34	21.45	0.0372	0.0366	0.0375

LTE Band 25 <Ant.0>:

BW [MHz]	Modulation	RB Size	RB Offset	Power Low Ch. / Freq.	Power Middle Ch. / Freq.	Power High Ch. / Freq.	EIRP(W)		
Channel				26140	26340	26590			
Frequency (MHz)				1860	1880	1905	L	M	H
20	QPSK	1	0	22.14	22.34	22.22	0.1986	0.2080	0.2023
20	QPSK	1	99	22.26	22.29	22.27	0.2042	0.2056	0.2046
20	QPSK	100	0	21.22	21.30	21.29	0.1607	0.1637	0.1633
20	16QAM	1	0	21.39	21.38	21.48	0.1671	0.1667	0.1706
20	64QAM	1	0	20.38	20.29	20.28	0.1324	0.1297	0.1294
Channel				26115	26340	26615	EIRP(W)		
Frequency (MHz)				1857.5	1880	1907.5	L	M	H
15	QPSK	1	0	22.13	22.12	22.27	0.1982	0.1977	0.2046
15	16QAM	1	0	21.23	21.26	21.46	0.1611	0.1622	0.1698
Channel				26090	26340	26640	EIRP(W)		
Frequency (MHz)				1855	1880	1910	L	M	H
10	QPSK	1	0	22.04	22.29	22.11	0.1941	0.2056	0.1972
10	16QAM	1	0	21.38	21.32	21.41	0.1667	0.1644	0.1679
Channel				26065	26340	26665	EIRP(W)		
Frequency (MHz)				1852.5	1880	1912.5	L	M	H
5	QPSK	1	0	22.12	22.31	22.06	0.1977	0.2065	0.1950
5	16QAM	1	0	21.31	21.32	21.42	0.1641	0.1644	0.1683
Channel				26055	26340	26675	EIRP(W)		
Frequency (MHz)				1851.5	1880	1913.5	L	M	H
3	QPSK	1	0	22.17	22.29	22.07	0.2000	0.2056	0.1954
3	16QAM	1	0	21.24	21.34	21.33	0.1614	0.1652	0.1648
Channel				26047	26340	26683	EIRP(W)		
Frequency (MHz)				1850.7	1880	1914.3	L	M	H
1.4	QPSK	1	0	22.18	22.11	22.21	0.2004	0.1972	0.2018
1.4	16QAM	1	0	21.07	21.24	21.32	0.1552	0.1614	0.1644



LTE Band 26 <Ant.0>:

BW [MHz]	Modulation	RB Size	RB Offset	Power Low Ch. / Freq.	Power Low Ch. / Freq.	Power Middle Ch. / Freq.	Power High Ch. / Freq.	ERP(W)			
Channel				26790	26865	26915	26965				
Frequency (MHz)				824	831.5	836.5	841.5	Straddle Ch	L	M	H
15	QPSK	1	0	22.42	22.58	22.54	22.40	0.0605	0.0628	0.0622	0.0603
15	QPSK	1	74	22.43	22.27	22.21	22.29	0.0607	0.0585	0.0577	0.0587
15	QPSK	75	0	21.48	21.52	21.49	21.40	0.0488	0.0492	0.0489	0.0479
15	16QAM	1	0	21.39	21.37	21.35	21.57	0.0478	0.0475	0.0473	0.0498
15	64QAM	1	0	20.55	20.52	20.37	20.37	0.0394	0.0391	0.0378	0.0378
Channel					26840	26915	26990	ERP(W)			
Frequency (MHz)					829	836.5	844		L	M	H
10	QPSK	1	0		22.49	22.31	22.40		0.0615	0.0590	0.0603
10	16QAM	1	0		21.27	21.30	21.37		0.0465	0.0468	0.0475
Channel					26815	26915	27015	ERP(W)			
Frequency (MHz)					826.5	836.5	846.5		L	M	H
5	QPSK	1	0		22.52	22.37	22.34		0.0619	0.0598	0.0594
5	16QAM	1	0		21.37	21.28	21.48		0.0475	0.0466	0.0488
Channel					26815	26915	27025	ERP(W)			
Frequency (MHz)					825.5	836.5	847.5		L	M	H
3	QPSK	1	0		22.50	22.32	22.21		0.0617	0.0592	0.0577
3	16QAM	1	0		21.17	21.30	21.42		0.0454	0.0468	0.0481
Channel					26797	26915	27033	ERP(W)			
Frequency (MHz)					824.7	836.5	848.3		L	M	H
1.4	QPSK	1	0		22.50	22.38	22.23		0.0617	0.0600	0.0579
1.4	16QAM	1	0		21.36	21.36	21.22		0.0474	0.0474	0.0459



LTE Band 66 <Ant.0>:

BW [MHz]	Modulation	RB Size	RB Offset	Power Low Ch. / Freq.	Power Middle Ch. / Freq.	Power High Ch. / Freq.	EIRP(W)		
Channel				132072	132322	132572	EIRP(W)		
Frequency (MHz)				1720	1745	1770	L	M	H
20	QPSK	1	0	22.20	22.25	22.18	0.2234	0.2259	0.2223
20	QPSK	1	99	22.17	22.16	22.14	0.2218	0.2213	0.2203
20	QPSK	100	0	21.31	21.35	21.32	0.1820	0.1837	0.1824
20	16QAM	1	0	21.42	21.39	21.23	0.1866	0.1854	0.1786
20	64QAM	1	0	20.39	20.40	20.10	0.1472	0.1476	0.1377
Channel				132047	132322	132597	EIRP(W)		
Frequency (MHz)				1717.5	1745	1772.5	L	M	H
15	QPSK	1	0	22.21	22.14	22.10	0.2239	0.2203	0.2183
15	16QAM	1	0	21.14	21.30	21.13	0.1750	0.1816	0.1746
Channel				132022	132322	132622	EIRP(W)		
Frequency (MHz)				1715	1745	1775	L	M	H
10	QPSK	1	0	22.20	22.14	22.10	0.2234	0.2203	0.2183
10	16QAM	1	0	21.33	21.42	21.24	0.1828	0.1866	0.1791
Channel				131997	132322	132647	EIRP(W)		
Frequency (MHz)				1712.5	1745	1777.5	L	M	H
5	QPSK	1	0	22.18	22.22	22.18	0.2223	0.2244	0.2223
5	16QAM	1	0	21.22	21.40	21.19	0.1782	0.1858	0.1770
Channel				131987	132322	132657	EIRP(W)		
Frequency (MHz)				1711.5	1745	1778.5	L	M	H
3	QPSK	1	0	22.11	22.21	22.17	0.2188	0.2239	0.2218
3	16QAM	1	0	21.16	21.12	21.35	0.1758	0.1742	0.1837
Channel				131979	132322	132665	EIRP(W)		
Frequency (MHz)				1710.7	1745	1779.3	L	M	H
1.4	QPSK	1	0	22.22	22.19	22.24	0.2244	0.2228	0.2254
1.4	16QAM	1	0	21.39	21.41	21.25	0.1854	0.1862	0.1795



LTE Band 12

Peak-to-Average Ratio

Mode	LTE Band 12 / 10MHz			
Mod.	QPSK	16QAM	64QAM	Limit: 13dB
RB Size	Full RB	Full RB	Full RB	Result
Middle CH	5.48	6.35	6.61	PASS

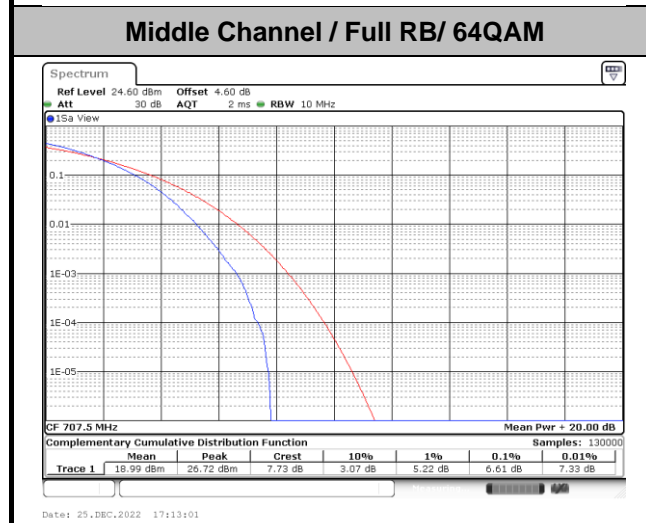
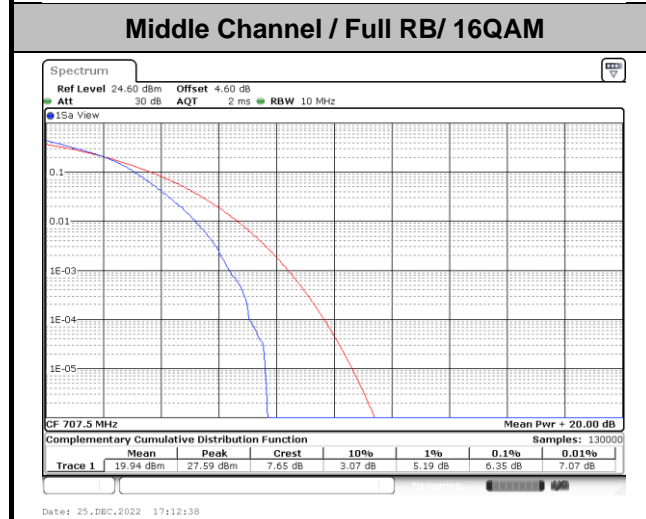
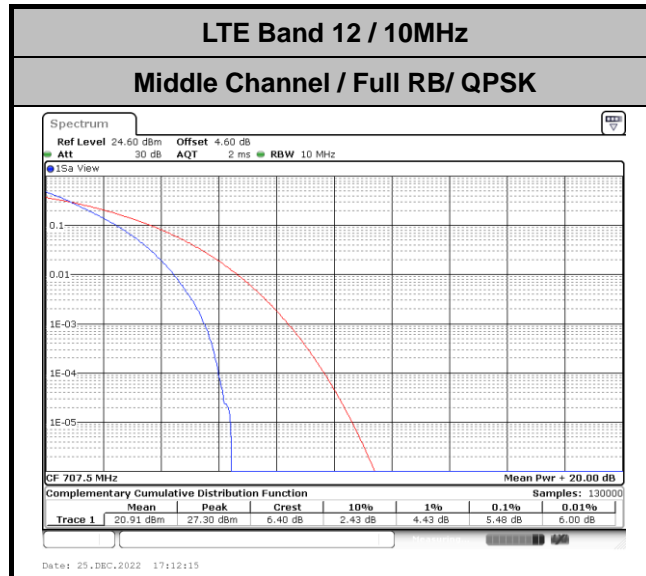



26dB Bandwidth

Mode	LTE Band 12 : 26dB BW(MHz)	
BW	1.4MHz	
Mod.	QPSK	16QAM
Middle CH	1.28	1.27
BW	3MHz	
Mod.	QPSK	16QAM
Middle CH	2.97	2.96
BW	5MHz	
Mod.	QPSK	16QAM
Middle CH	4.93	5.10
BW	10MHz	
Mod.	QPSK	16QAM
Middle CH	10.29	10.03

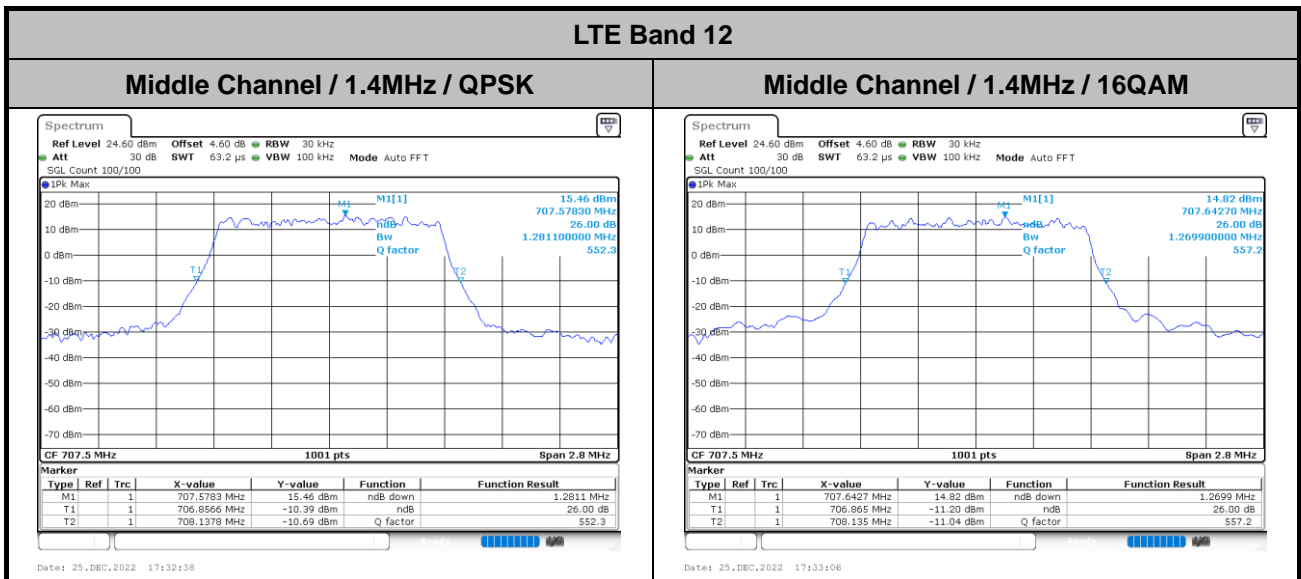



LTE Band 12

Middle Channel / 3MHz / QPSK

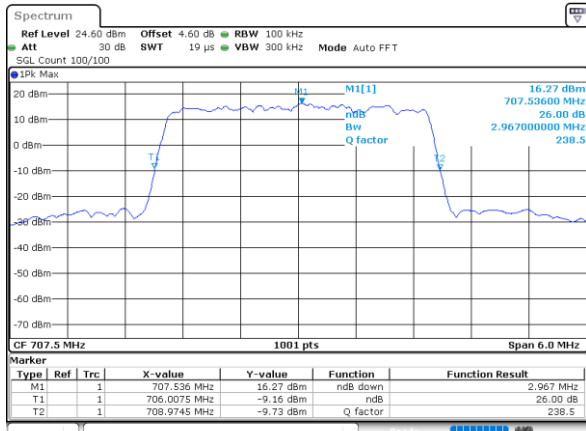

Date: 25. DEC. 2022 17:40:22

Middle Channel / 3MHz / 16QAM

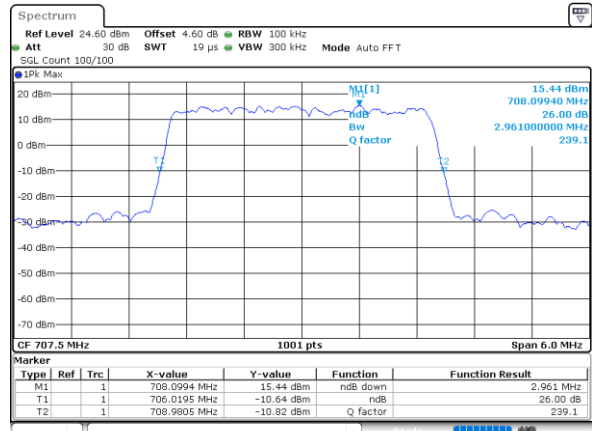

Date: 25. DEC. 2022 17:40:49

LTE Band 12

Middle Channel / 5MHz / QPSK

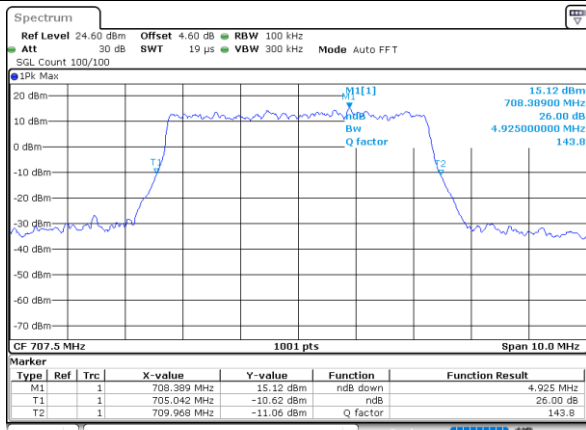

Date: 25. DEC. 2022 17:46:05

Middle Channel / 5MHz / 16QAM

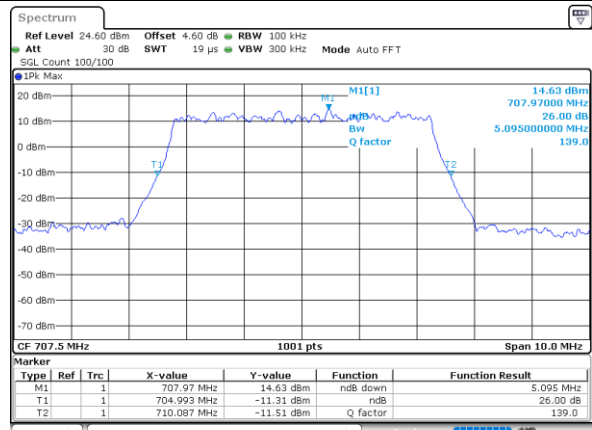

Date: 25. DEC. 2022 17:46:33

LTE Band 12

Middle Channel / 10MHz / QPSK

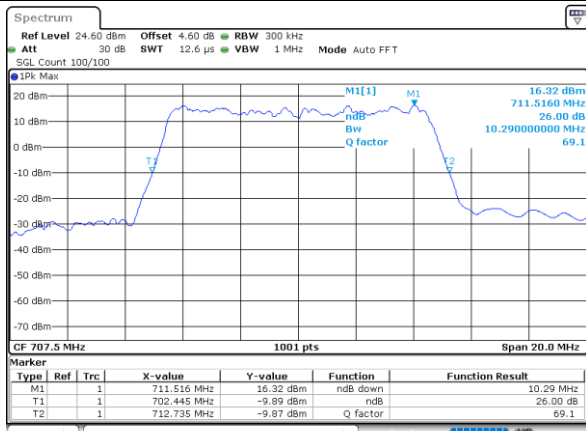

Date: 25. DEC. 2022 17:14:07

Middle Channel / 10MHz / 16QAM

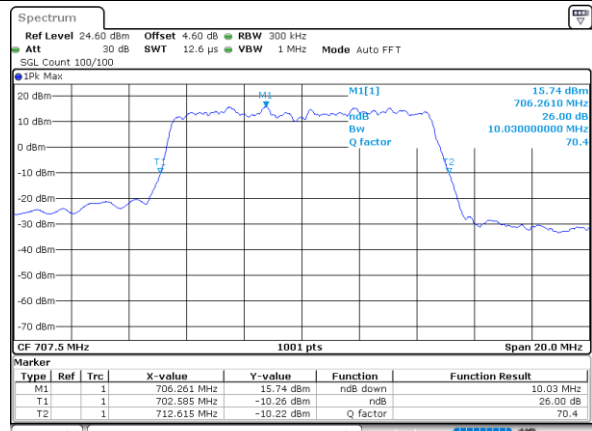

Date: 25. DEC. 2022 17:14:28



Occupied Bandwidth

Mode	LTE Band 12 : 99%OBW(MHz)	
BW	1.4MHz	
Mod.	QPSK	16QAM
Middle CH	1.09	1.09
BW	3MHz	
Mod.	QPSK	16QAM
Middle CH	2.71	2.72
BW	5MHz	
Mod.	QPSK	16QAM
Middle CH	4.54	4.48
BW	10MHz	
Mod.	QPSK	16QAM
Middle CH	9.09	9.05

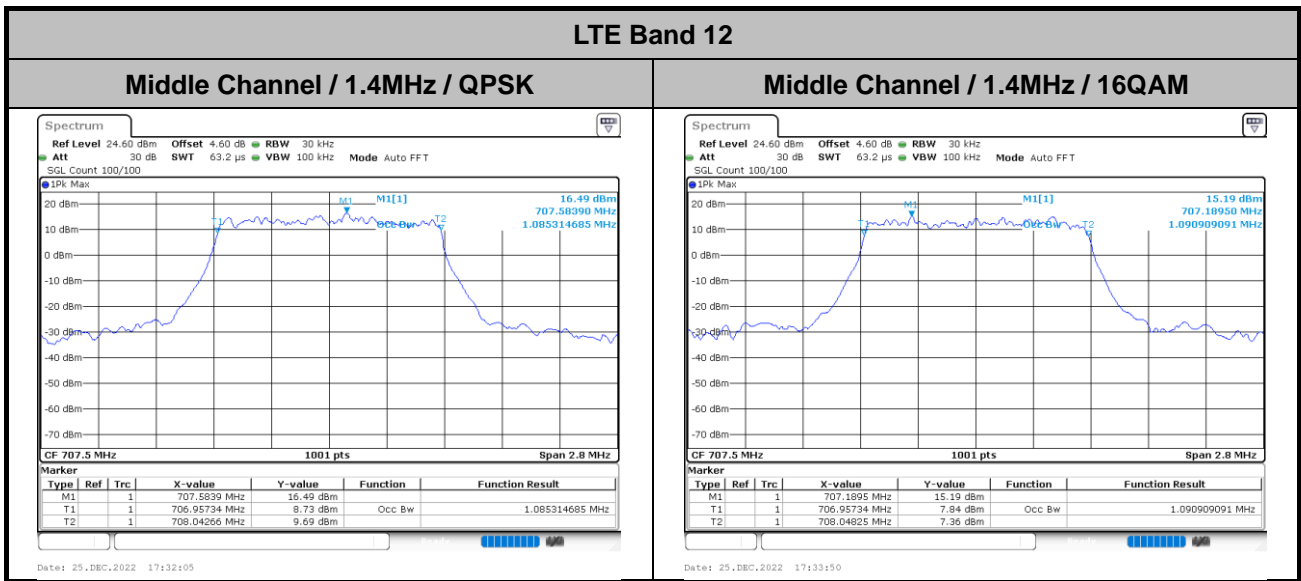



LTE Band 12

Middle Channel / 3MHz / QPSK

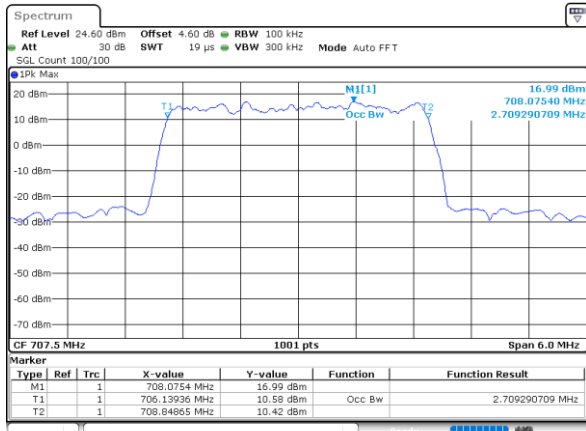

Date: 25, DEC, 2022 17:39:59

Middle Channel / 3MHz / 16QAM

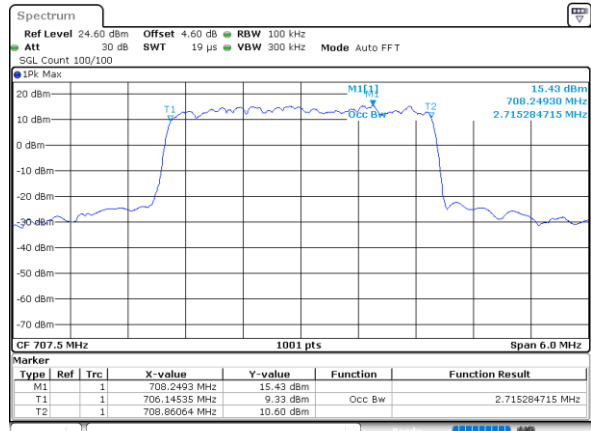

Date: 25, DEC, 2022 17:41:13

LTE Band 12

Middle Channel / 5MHz / QPSK

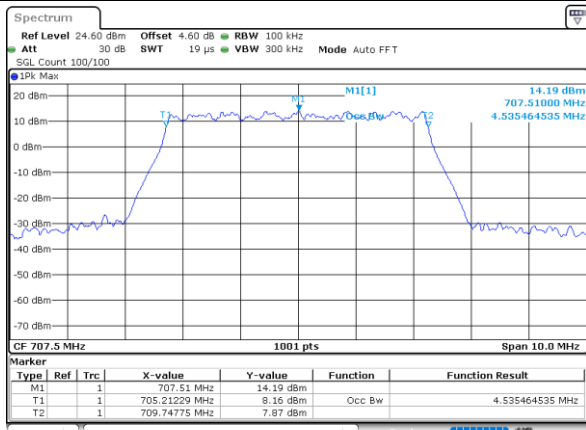

Date: 25, DEC, 2022 17:47:00

Middle Channel / 5MHz / 16QAM

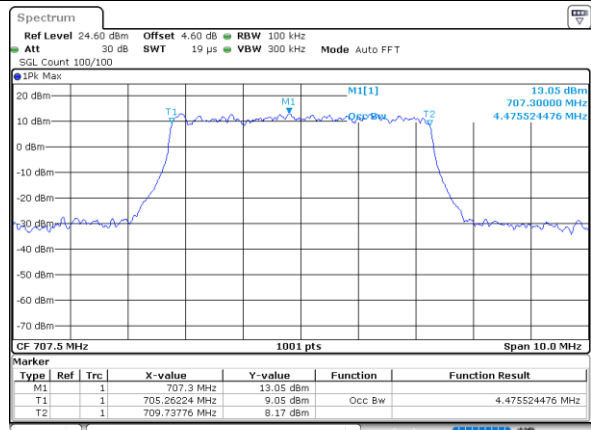

Date: 26, DEC, 2022 14:33:22

LTE Band 12

Middle Channel / 10MHz / QPSK

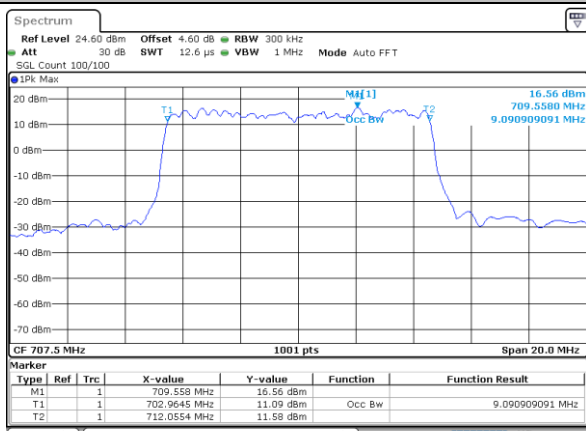

Date: 25, DEC, 2022 17:13:23

Middle Channel / 10MHz / 16QAM

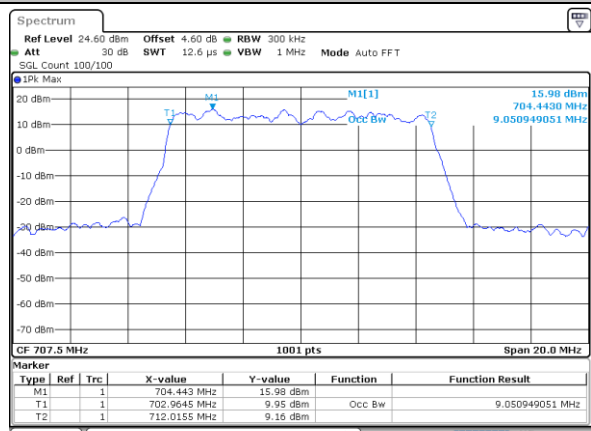

Date: 25, DEC, 2022 17:13:45



Conducted Band Edge

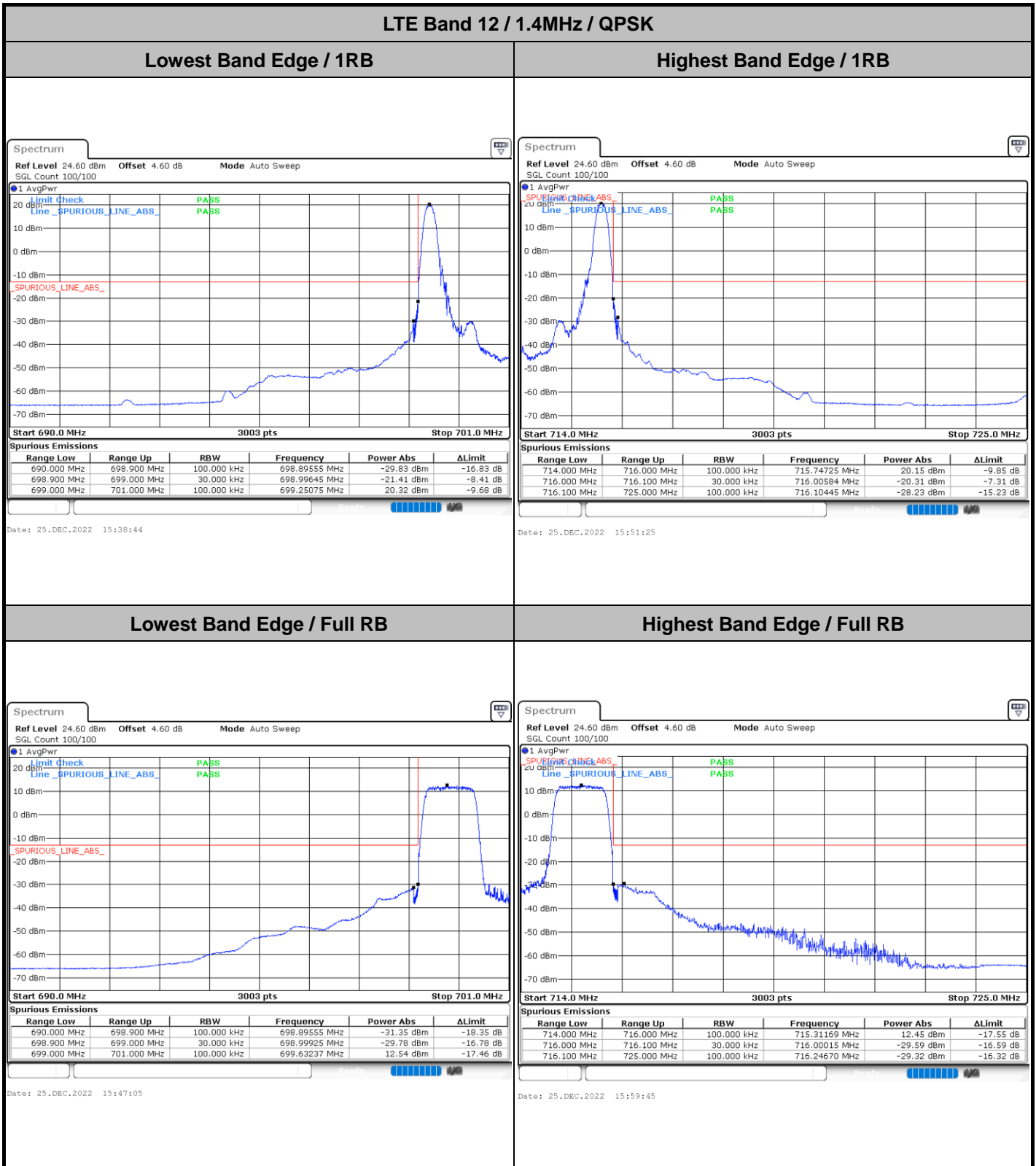



LTE Band 12 / 1.4MHz / 16QAM

Lowest Band Edge / 1 RB

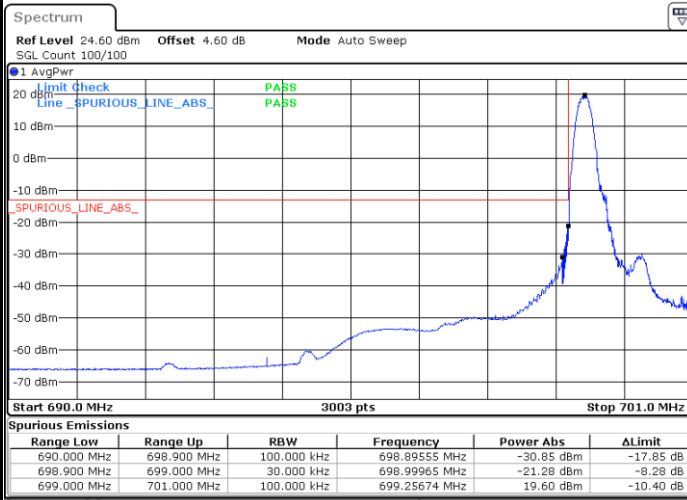

Date: 25.DEC.2022 15:40:24

Highest Band Edge / 1 RB

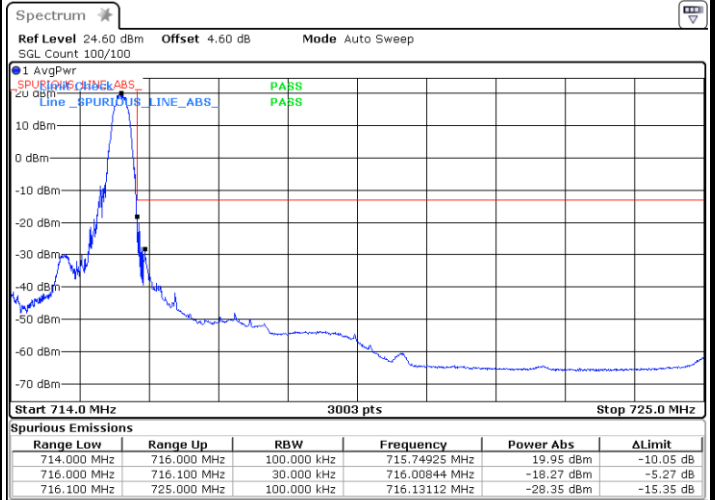

Date: 25.DEC.2022 17:27:58

Lowest Band Edge / Full RB

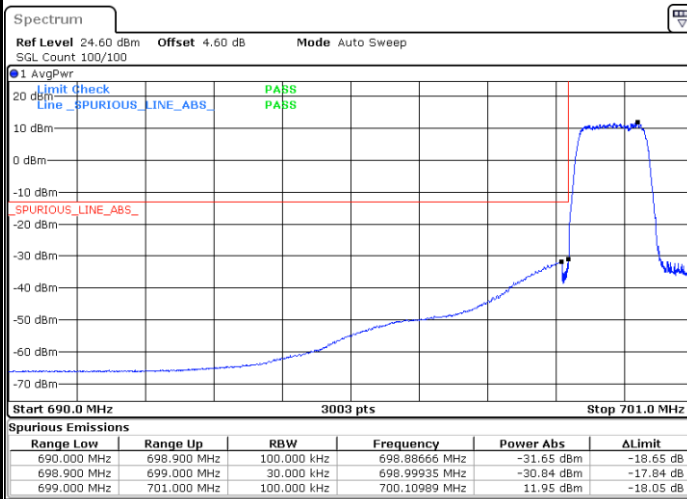

Date: 25.DEC.2022 15:45:25

Highest Band Edge / Full RB

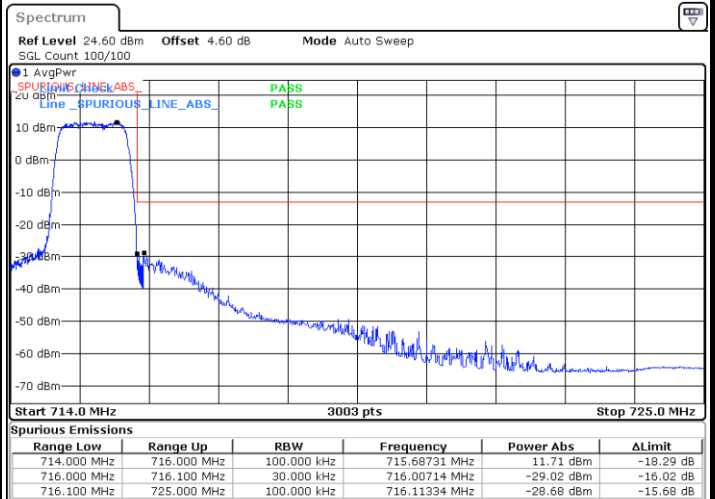

Date: 25.DEC.2022 15:58:05



LTE Band 12 / 1.4MHz / 64QAM

Lowest Band Edge / 1 RB

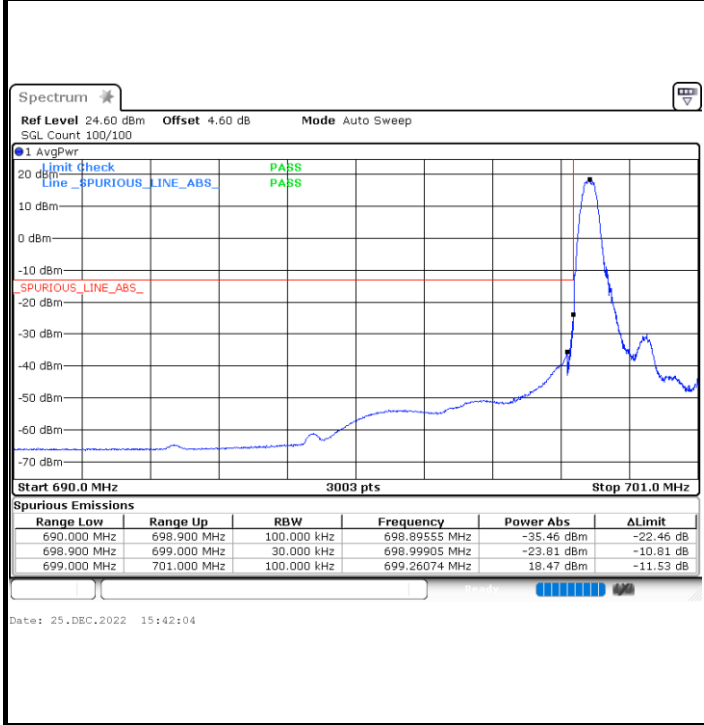

Highest Band Edge / 1 RB

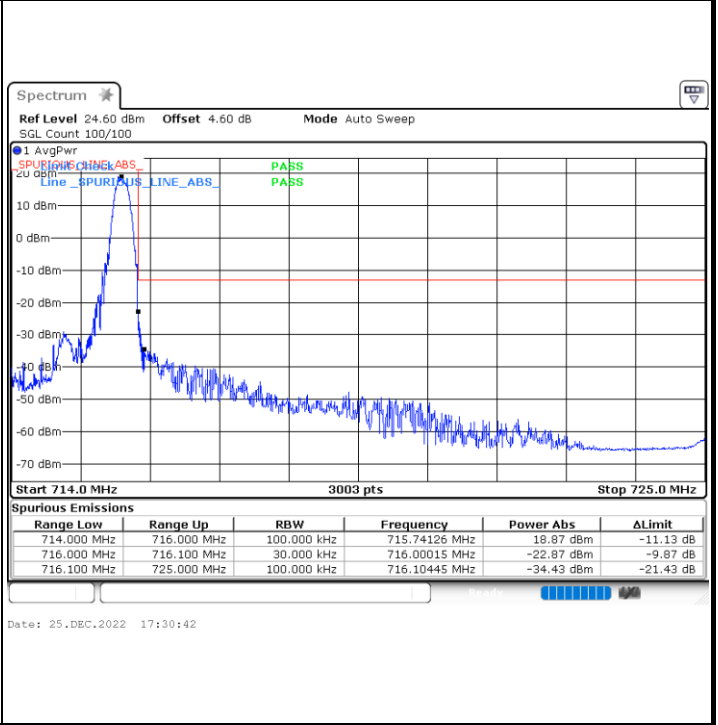

Lowest Band Edge / Full RB

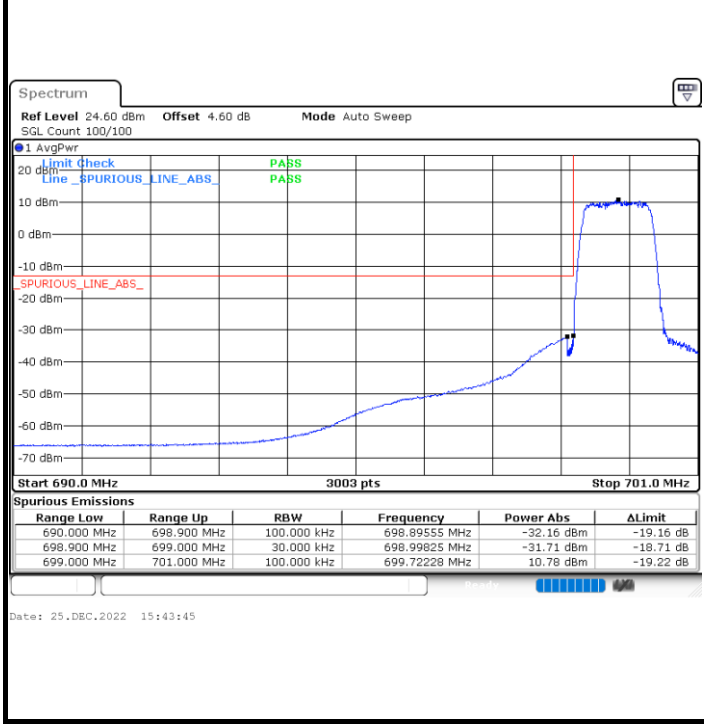

Highest Band Edge / Full RB

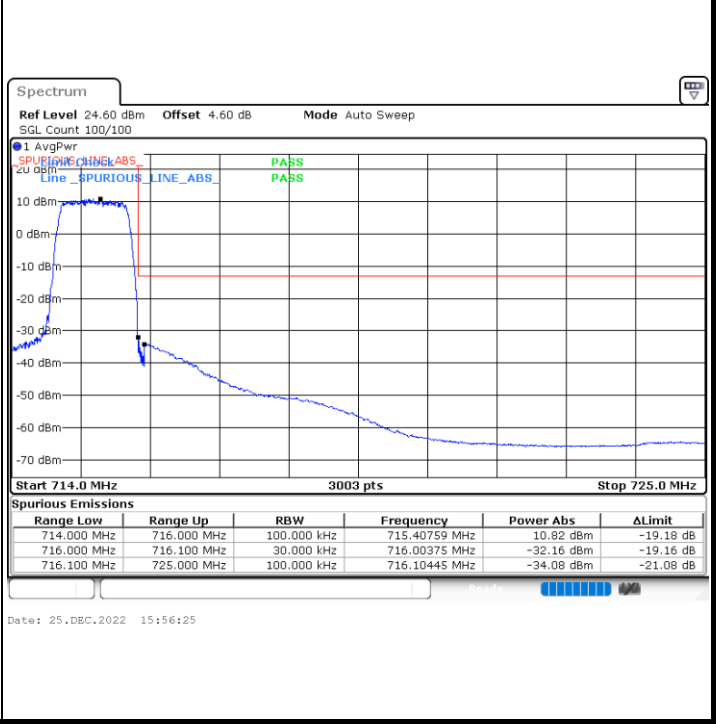



LTE Band 12 / 3MHz / QPSK

Lowest Band Edge / 1RB

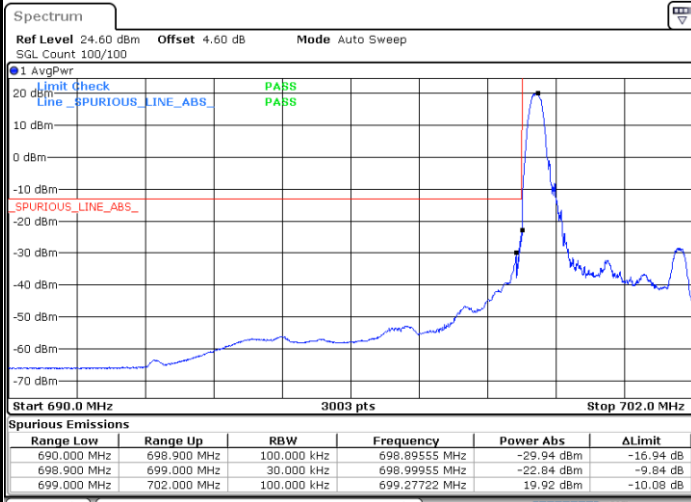

Date: 25.DEC.2022 16:02:46

Highest Band Edge / 1 RB

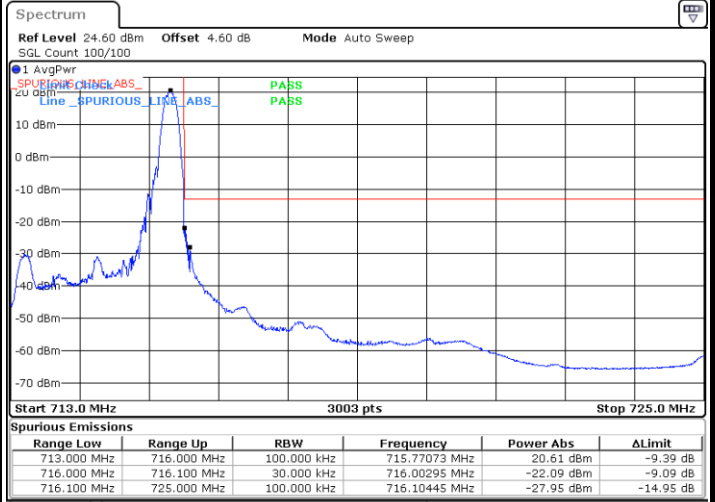

Date: 25.DEC.2022 16:15:27

Lowest Band Edge / Full RB

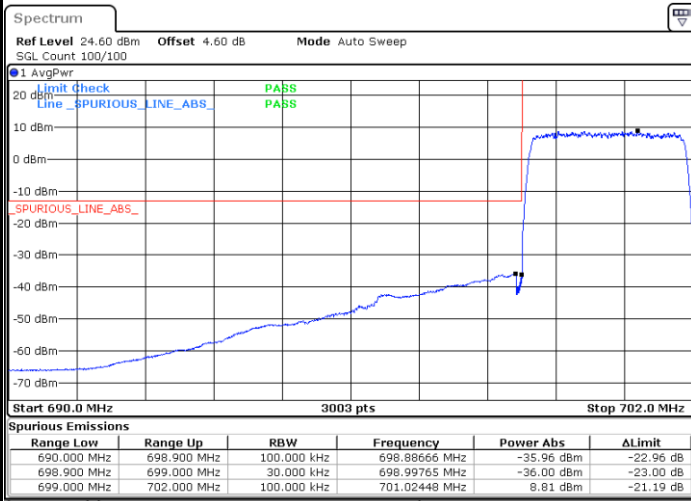

Date: 25.DEC.2022 16:11:07

Highest Band Edge / Full RB

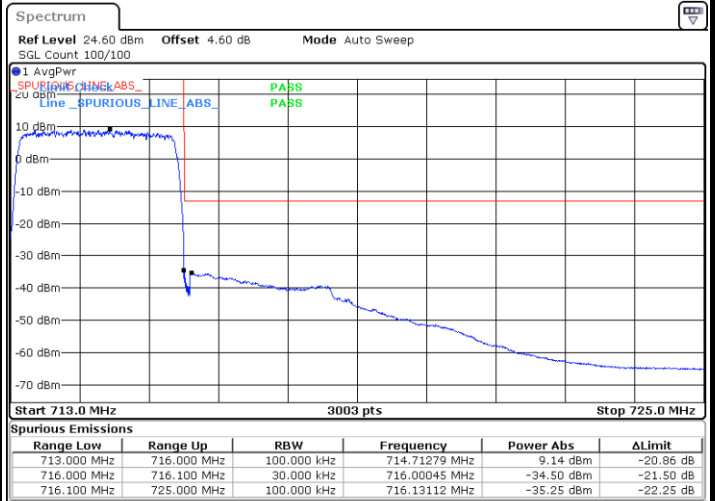

Date: 25.DEC.2022 16:23:47



LTE Band 12 / 3MHz / 16QAM

Lowest Band Edge / 1 RB

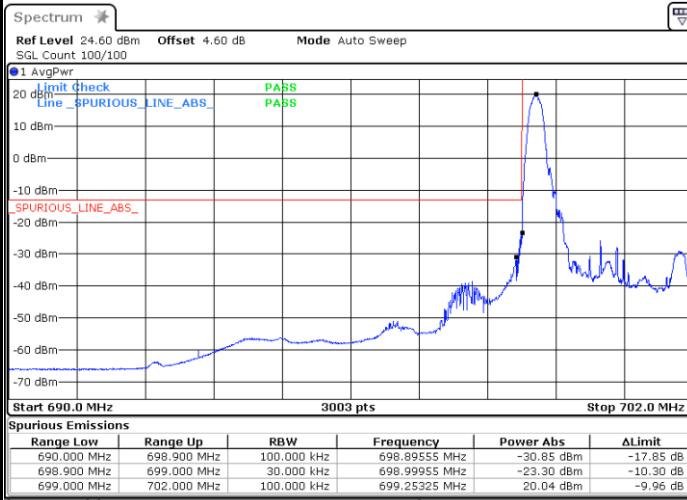

Date: 25.DEC.2022 17:35:58

Highest Band Edge / 1 RB



Date: 25.DEC.2022 17:37:43

Lowest Band Edge / Full RB

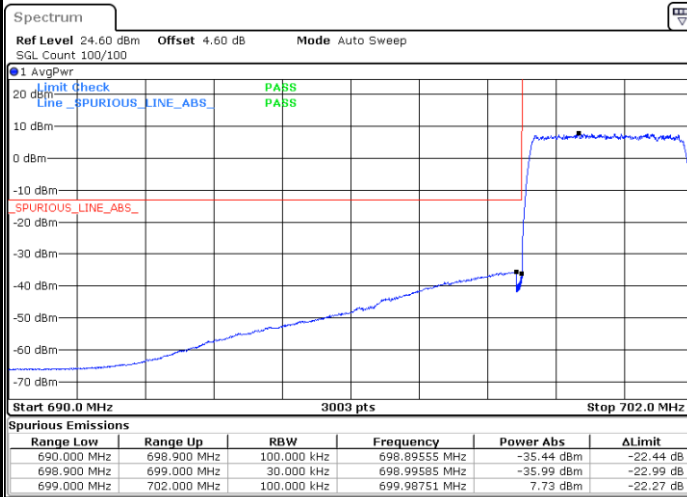

Date: 25.DEC.2022 16:09:27

Highest Band Edge / Full RB

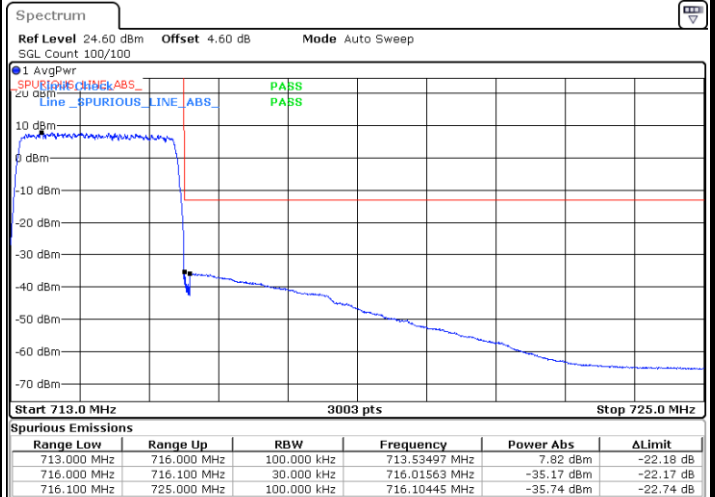

Date: 25.DEC.2022 16:22:07



LTE Band 12 / 3MHz / 64QAM

Lowest Band Edge / 1 RB

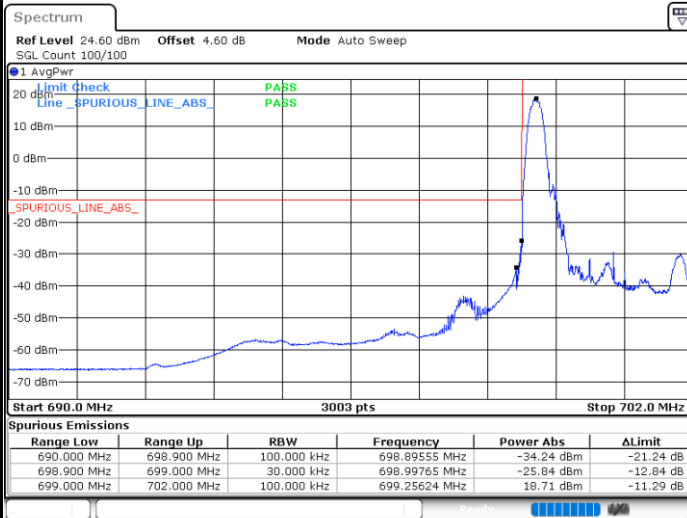

Highest Band Edge / 1 RB

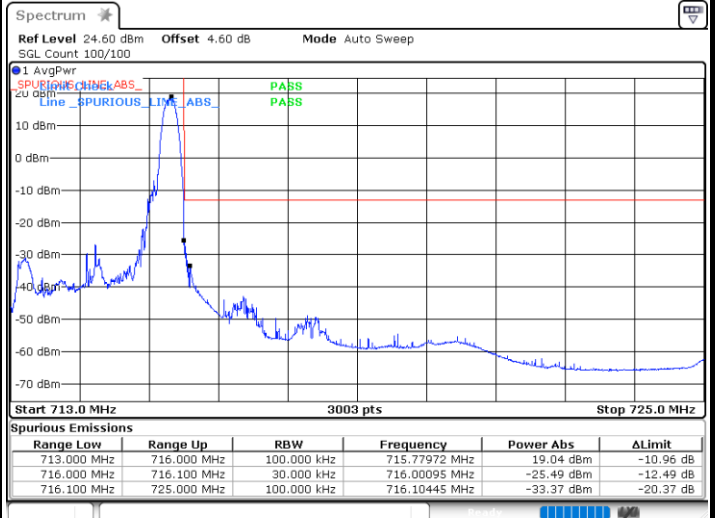

Lowest Band Edge / Full RB

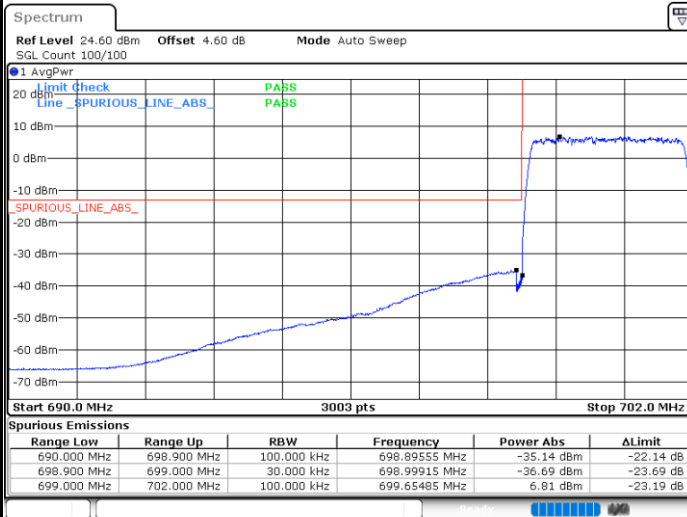

Highest Band Edge / Full RB

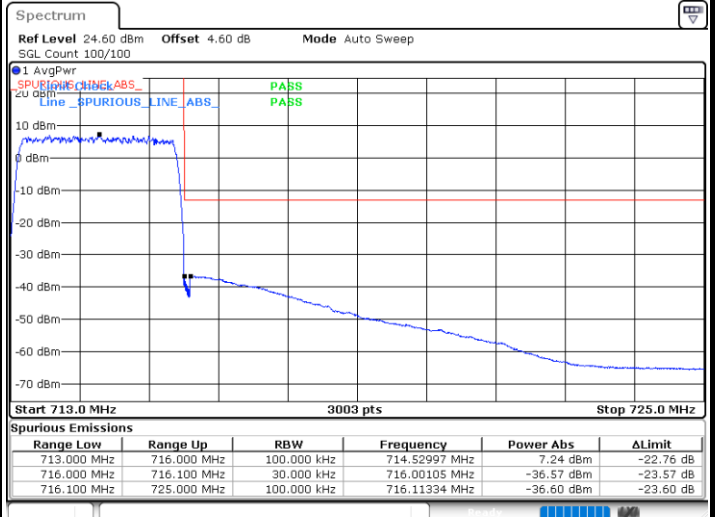



LTE Band 12 / 5MHz / QPSK

Lowest Band Edge / 1 RB

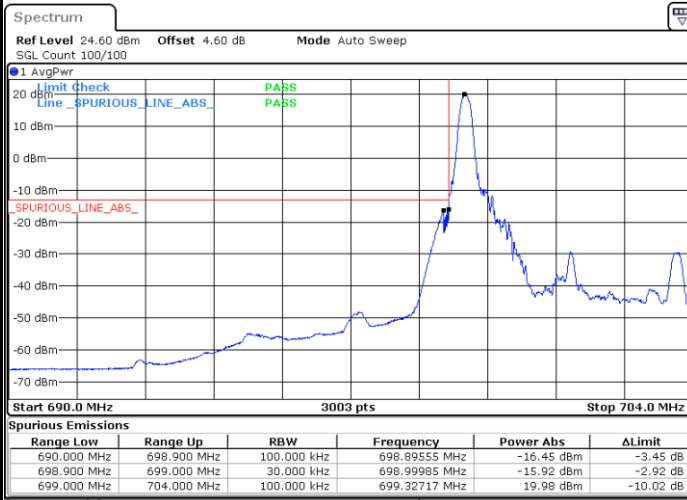

Date: 25.DEC.2022 16:26:48

Highest Band Edge / 1 RB

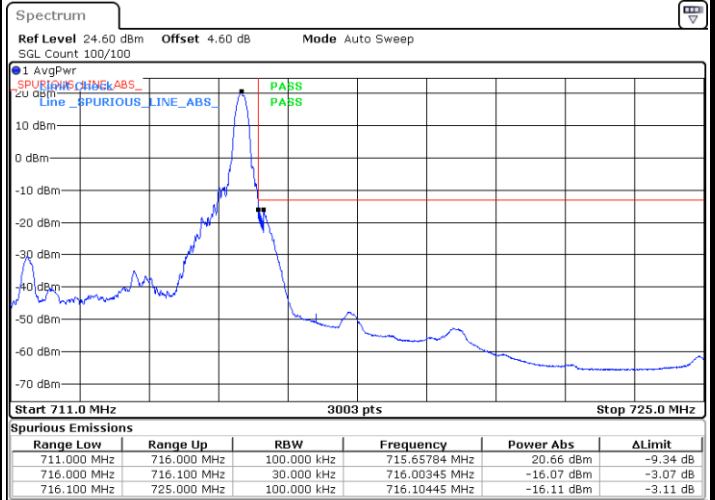

Date: 25.DEC.2022 16:39:29

Lowest Band Edge / Full RB

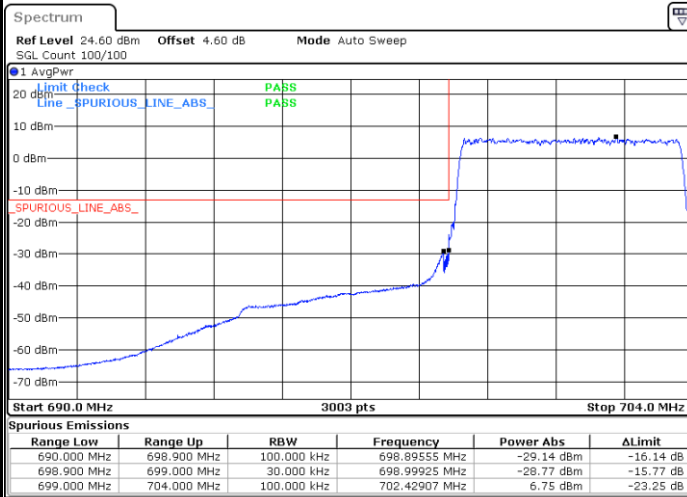

Date: 25.DEC.2022 16:35:09

Highest Band Edge / Full RB

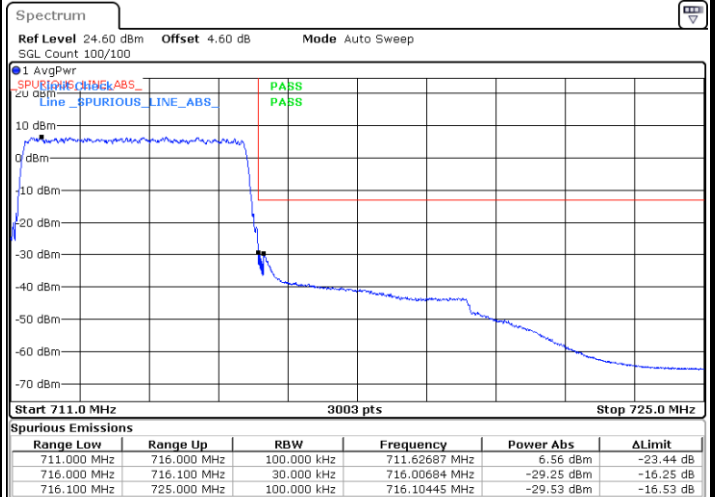

Date: 25.DEC.2022 16:47:50



LTE Band 12 / 5MHz / 16QAM

Lowest Band Edge / 1RB

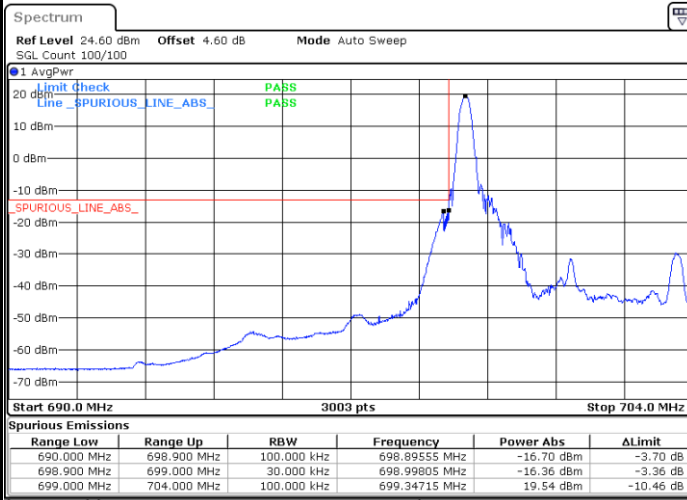

Highest Band Edge / 1 RB

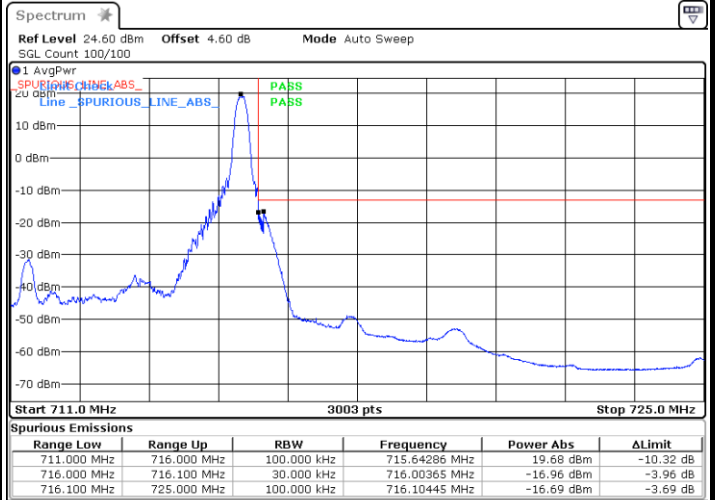

Lowest Band Edge / Full RB

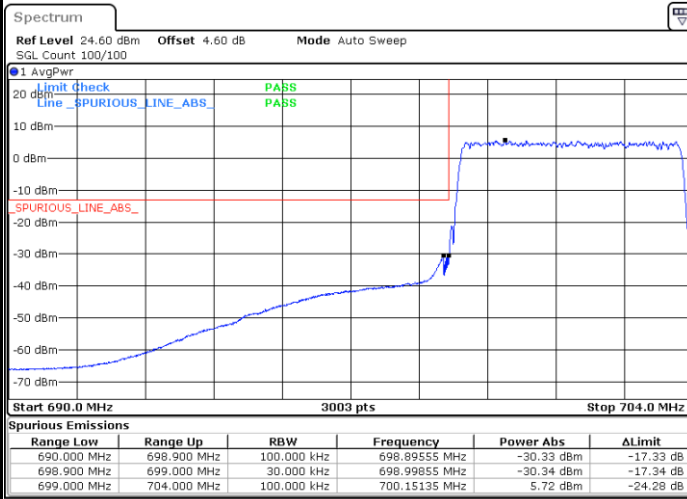

Highest Band Edge / Full RB

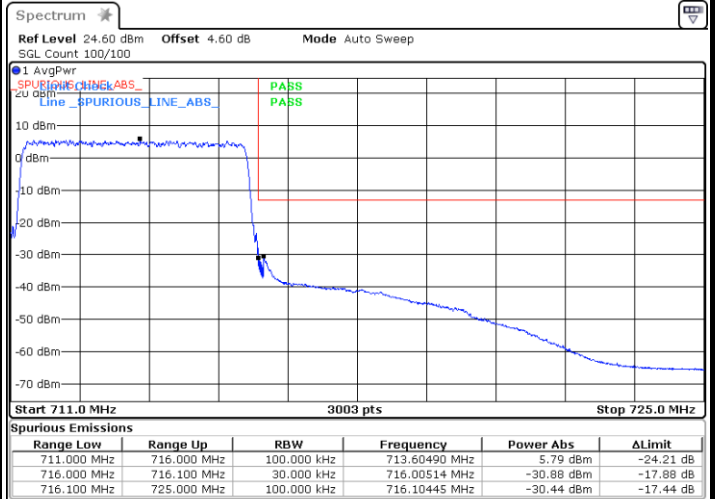



LTE Band 12 / 5MHz / 64QAM

Lowest Band Edge / 1RB

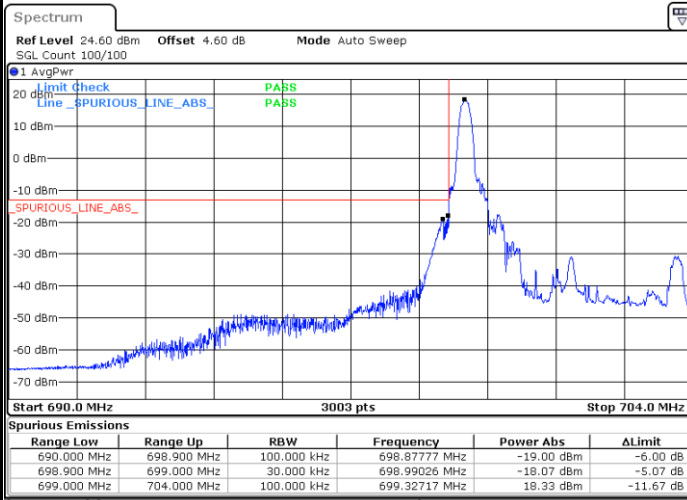

Date: 25.DEC.2022 17:43:19

Highest Band Edge / 1 RB

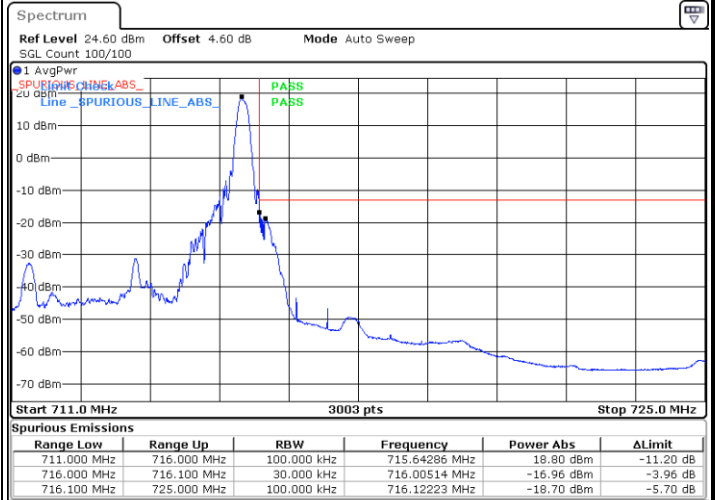

Date: 25.DEC.2022 16:42:49

Lowest Band Edge / Full RB

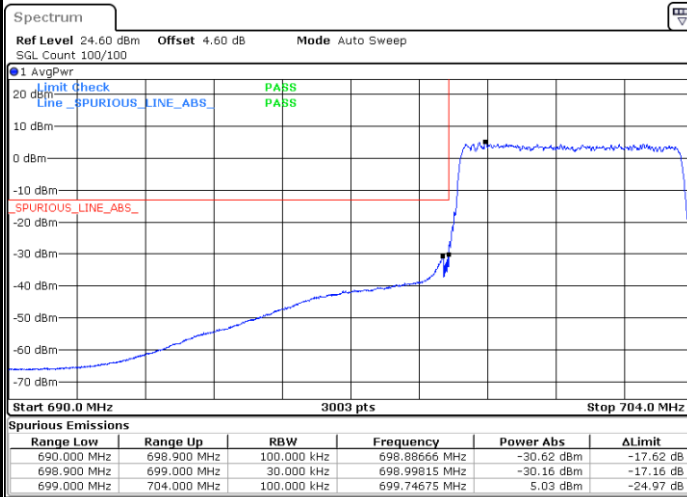

Date: 25.DEC.2022 16:31:49

Highest Band Edge / Full RB

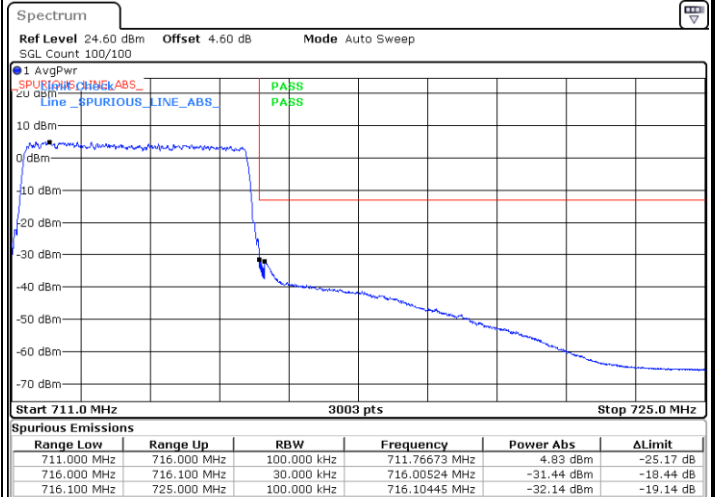

Date: 25.DEC.2022 16:44:30



LTE Band 12 / 10MHz / QPSK

Lowest Band Edge / 1 RB

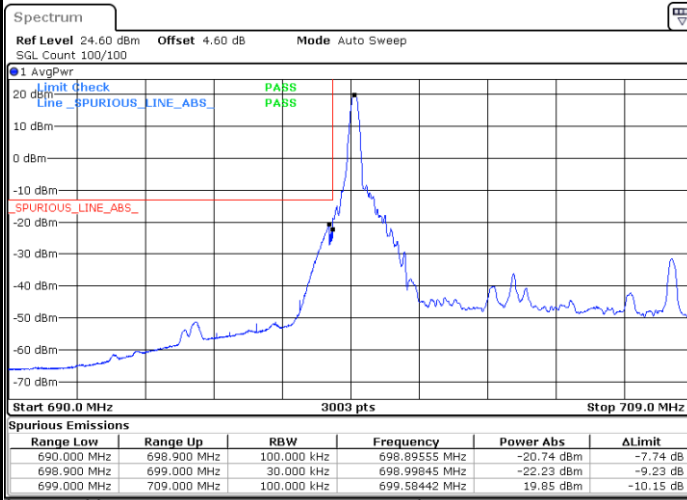

Date: 25.DEC.2022 16:50:51

Highest Band Edge / 1 RB

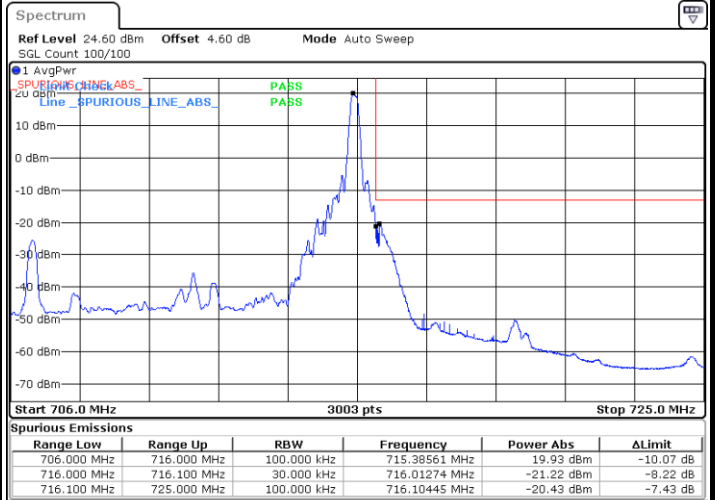

Date: 25.DEC.2022 17:03:32

Lowest Band Edge / Full RB

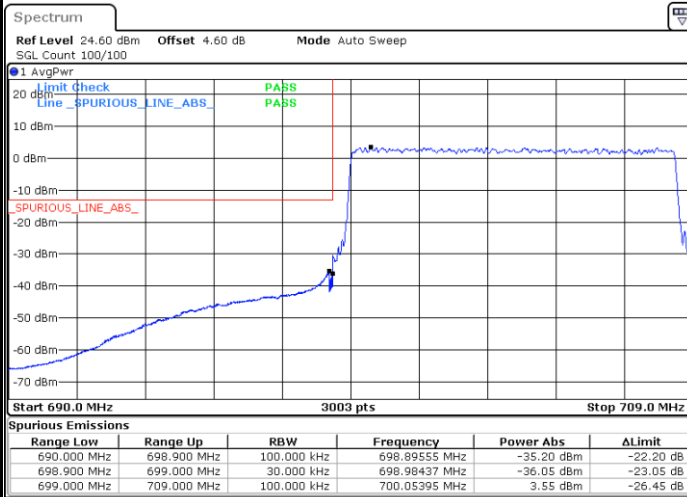

Date: 25.DEC.2022 16:59:12

Highest Band Edge / Full RB

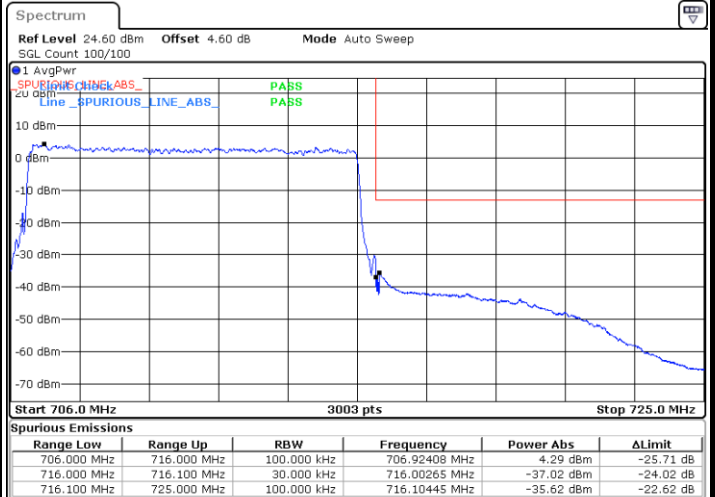

Date: 25.DEC.2022 17:11:52



LTE Band 12 / 10MHz / 16QAM

Lowest Band Edge / 1 RB

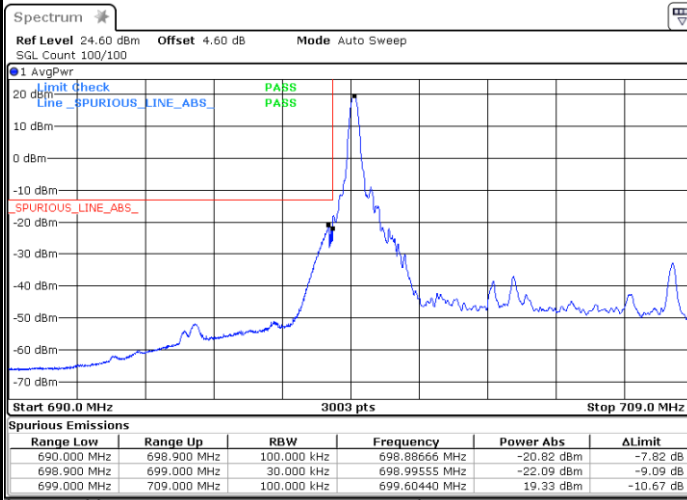

Date: 25.DEC.2022 17:18:31

Highest Band Edge / 1 RB

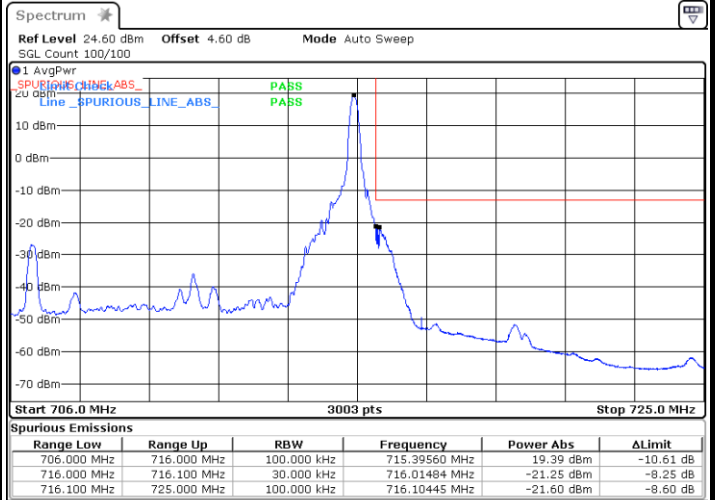

Date: 25.DEC.2022 17:05:12

Lowest Band Edge / Full RB

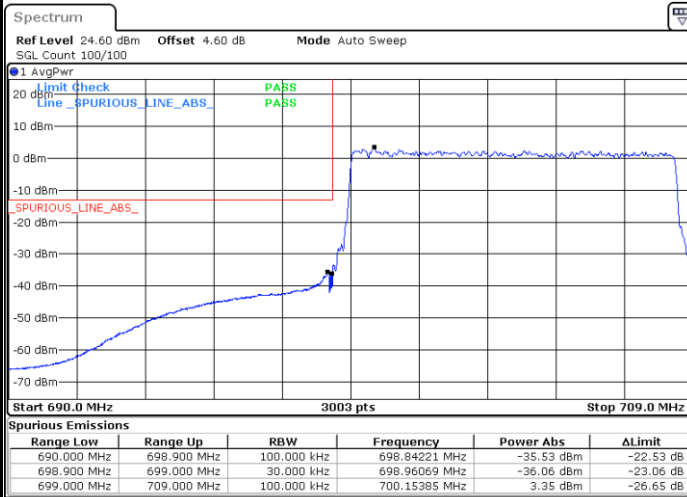

Date: 25.DEC.2022 16:57:32

Highest Band Edge / Full RB

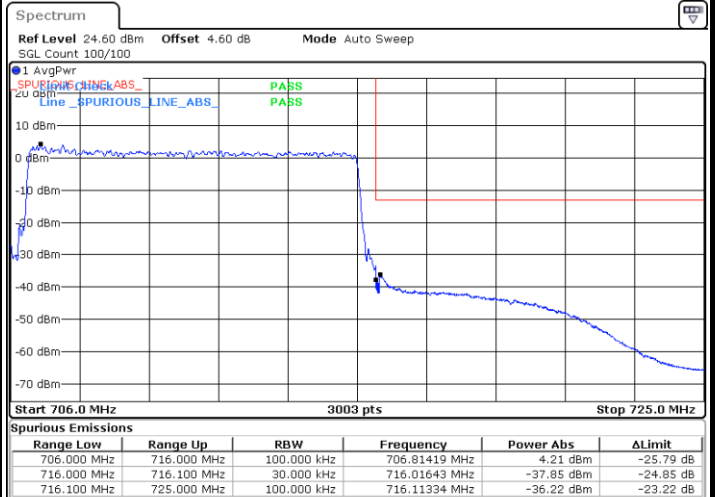

Date: 25.DEC.2022 17:10:12



LTE Band 12 / 10MHz / 64QAM

Lowest Band Edge / 1 RB

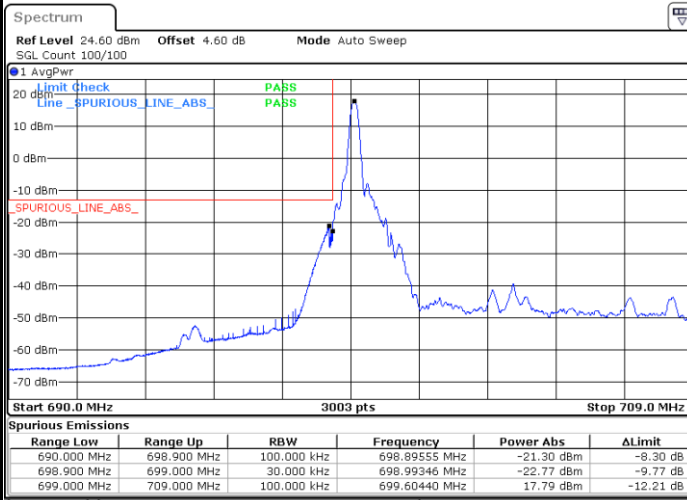

Date: 25.DEC.2022 17:20:50

Highest Band Edge / 1 RB

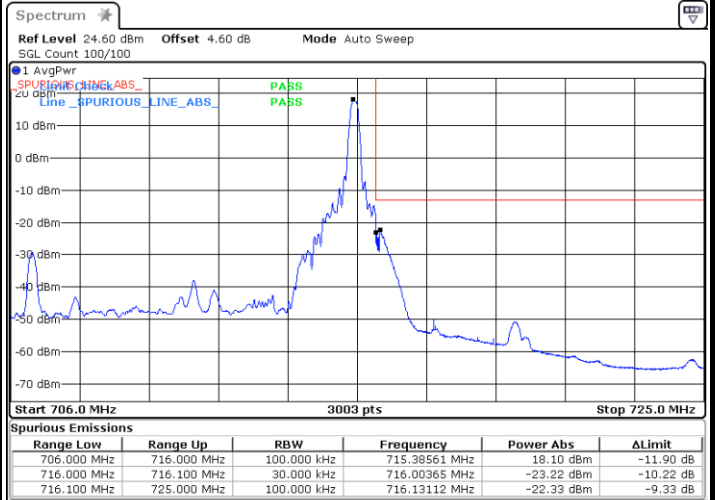

Date: 25.DEC.2022 17:06:52

Lowest Band Edge / Full RB

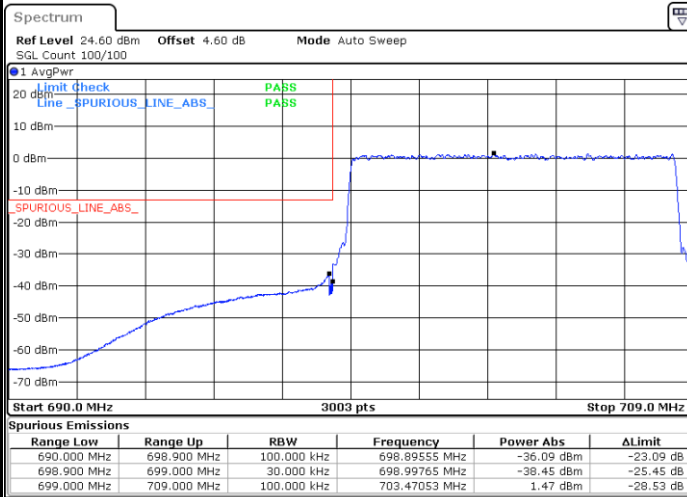

Date: 25.DEC.2022 16:55:52

Highest Band Edge / Full RB

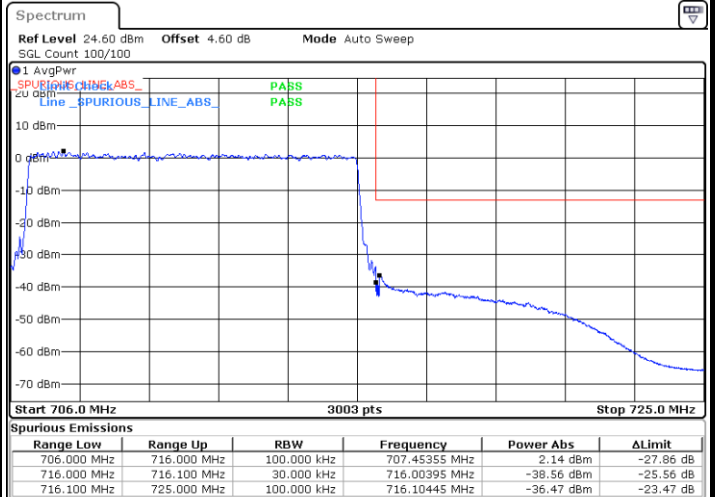

Date: 25.DEC.2022 17:08:32



Conducted Spurious Emission

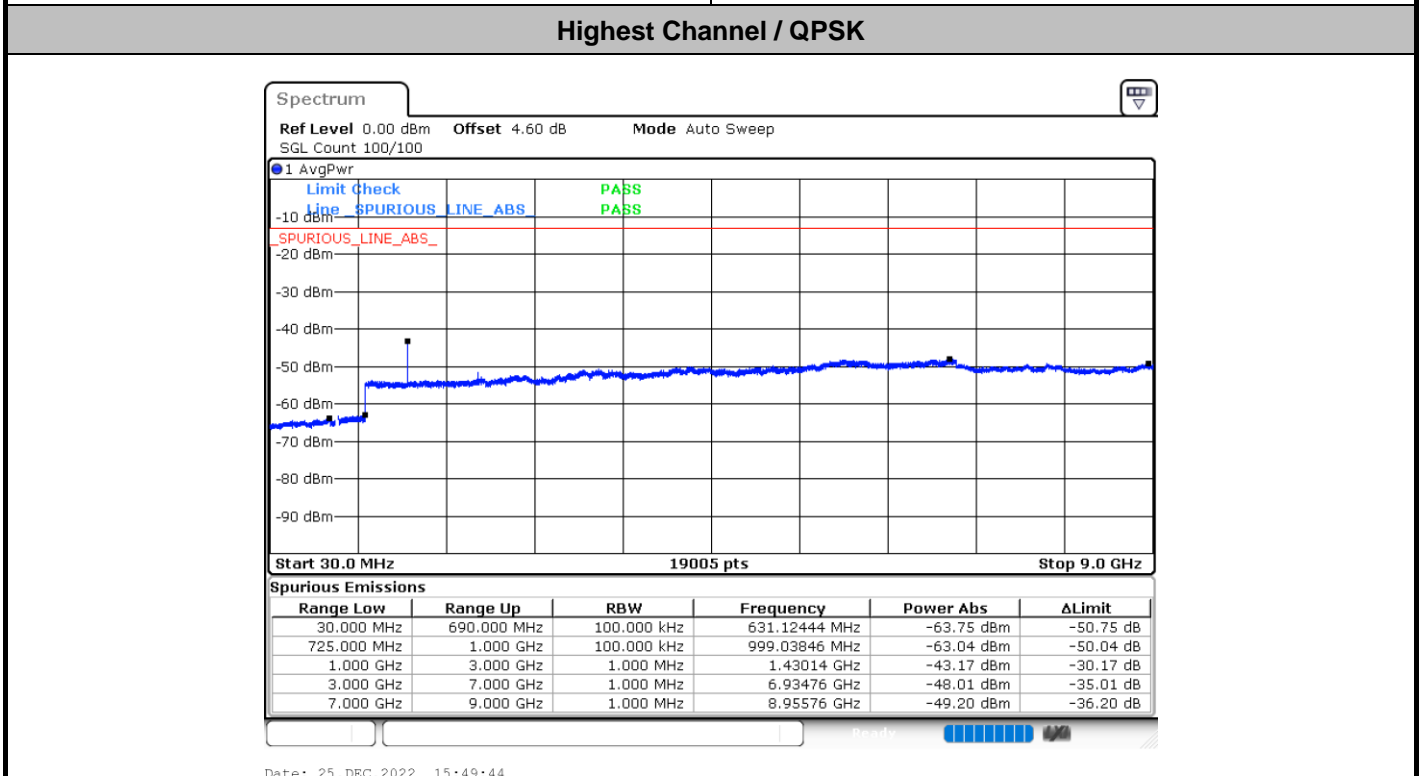
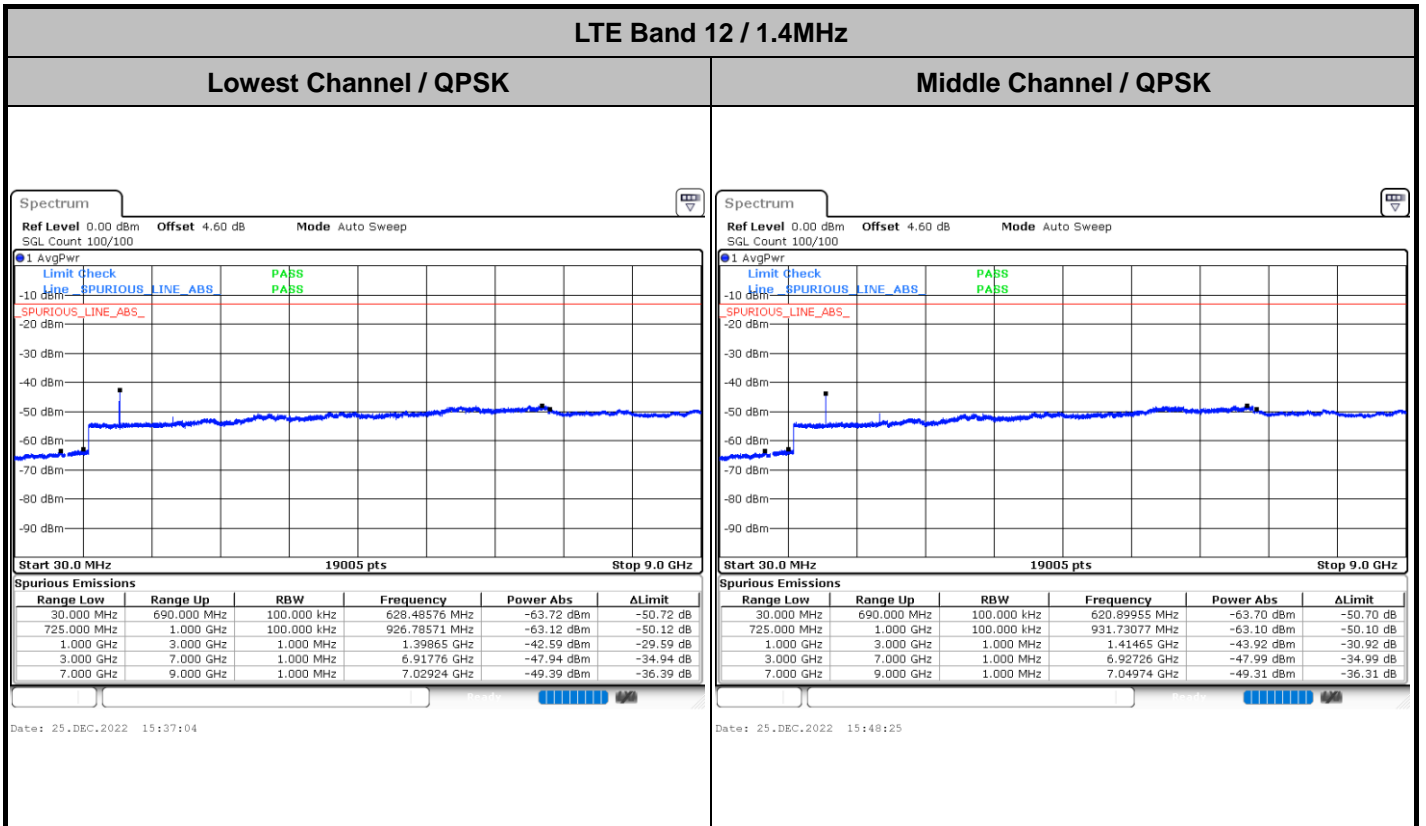



LTE Band 12 / 3MHz

Lowest Channel / QPSK

Middle Channel / QPSK

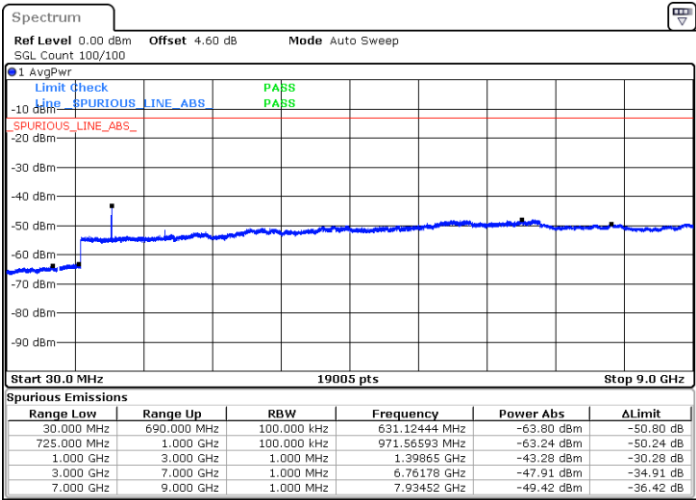

Date: 25.DEC.2022 16:01:06

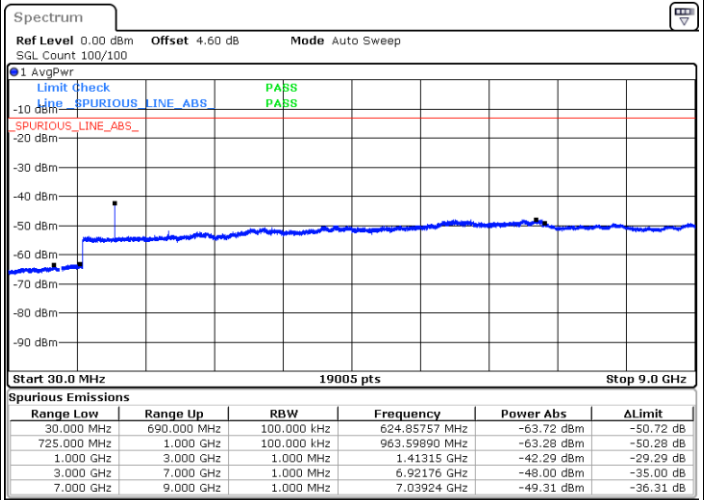

Date: 25.DEC.2022 16:12:27

Highest Channel / QPSK

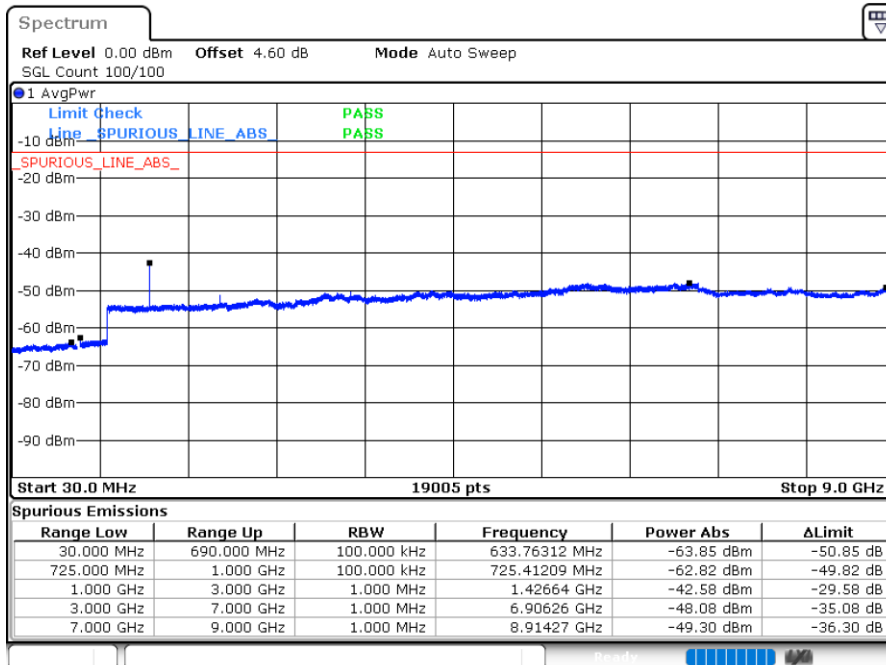

Date: 25.DEC.2022 16:13:46



LTE Band 12 / 5MHz

Lowest Channel / QPSK

Middle Channel / QPSK

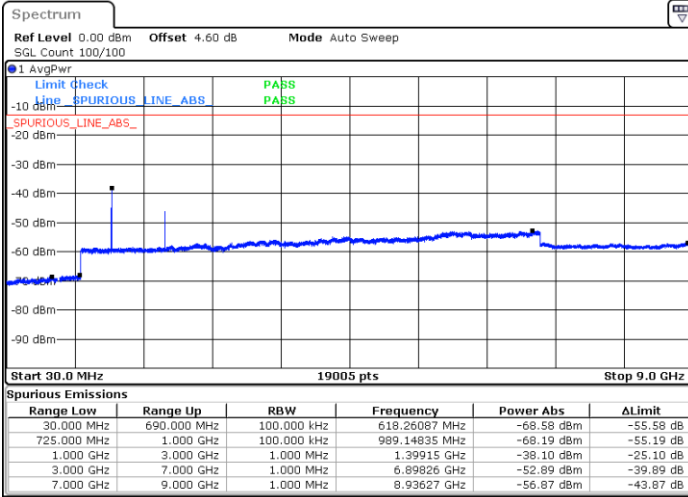

Date: 25 DEC.2022 16:25:08

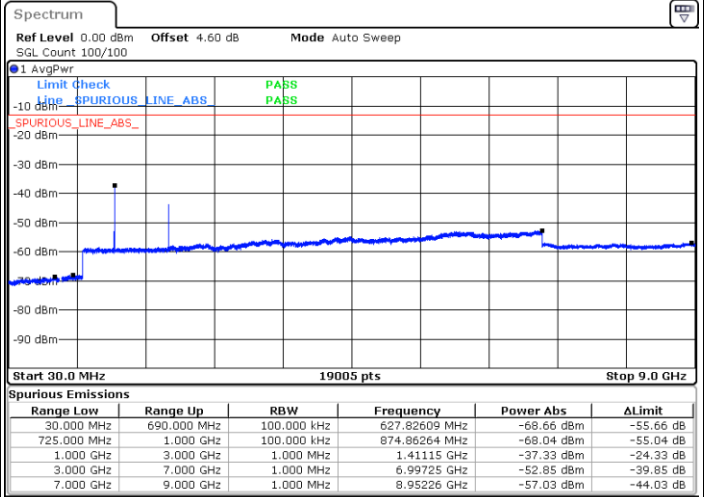

Date: 25 DEC.2022 16:36:29

Highest Channel / QPSK

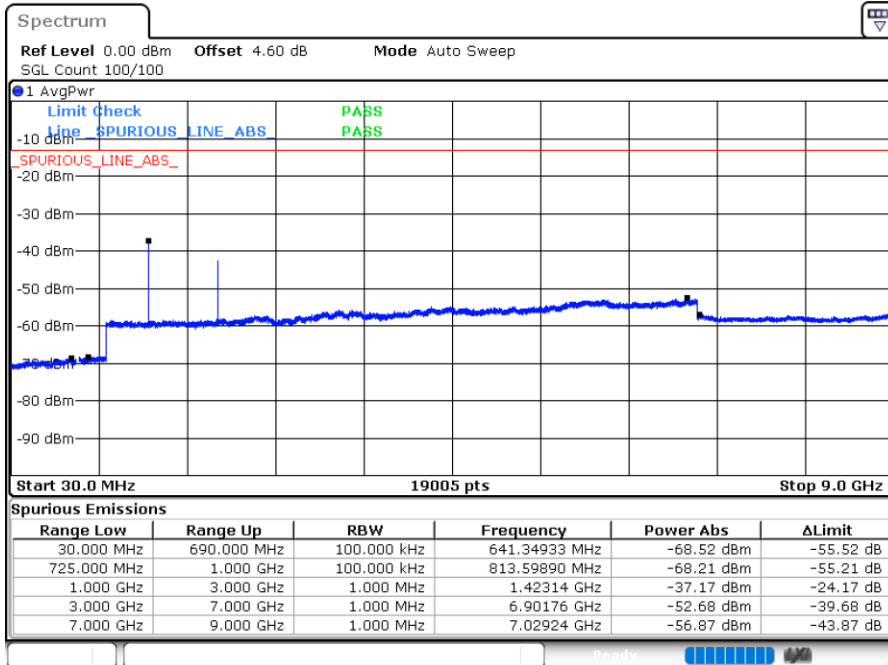

Date: 25 DEC.2022 16:37:49



LTE Band 12 / 10MHz

Lowest Channel / QPSK

Middle Channel / QPSK

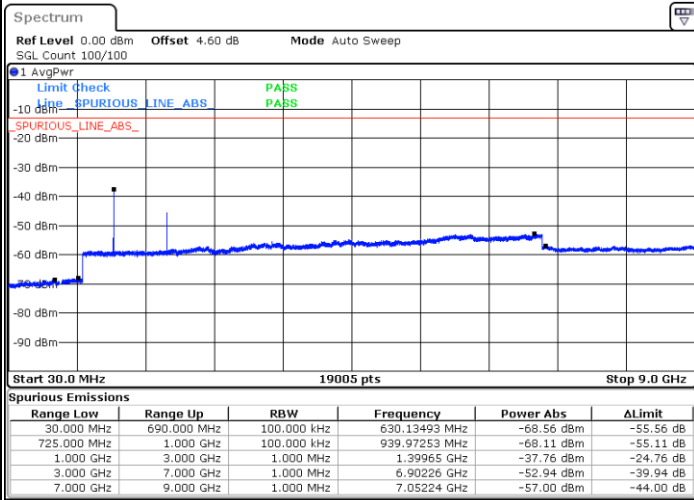

Date: 25.DEC.2022 16:49:11

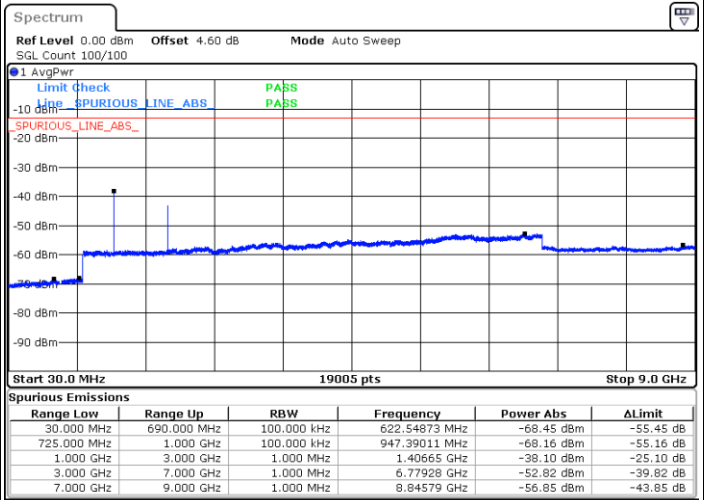

Date: 25.DEC.2022 17:00:32

Highest Channel / QPSK

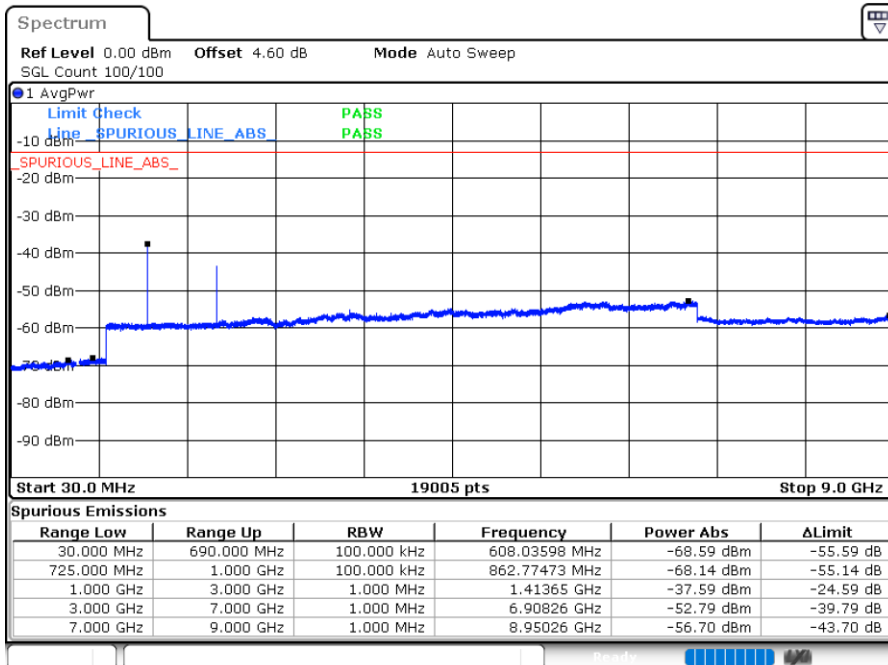

Date: 25.DEC.2022 17:01:51



Frequency Stability

Test Conditions		LTE Band 12 (QPSK) / Middle Channel	Limit
Temperature (°C)	Voltage (Volt)	BW 10MHz	Note 2.
		Deviation (ppm)	Result
50	Normal Voltage	0.0028	PASS
40	Normal Voltage	0.0016	
30	Normal Voltage	0.0014	
20(Ref.)	Normal Voltage	0.0000	
10	Normal Voltage	0.0011	
0	Normal Voltage	0.0019	
-10	Normal Voltage	0.0021	
-20	Normal Voltage	0.0025	
-30	Normal Voltage	0.0031	
20	Maximum Voltage	0.0019	
20	Normal Voltage	0.0007	
20	Battery End Point	0.0013	

Note:

1. Normal Voltage =3.89V. ; Battery End Point (BEP) =3.6 V. ; Maximum Voltage =4.48 V.
2. The frequency fundamental emissions stay within the authorized frequency block.



LTE Band 13

Peak-to-Average Ratio

Mode	LTE Band 13 / 10MHz			
Mod.	QPSK	16QAM	64QAM	Limit: 13dB
RB Size	Full RB	Full RB	Full RB	Result
Middle CH	5.19	6.06	6.32	PASS

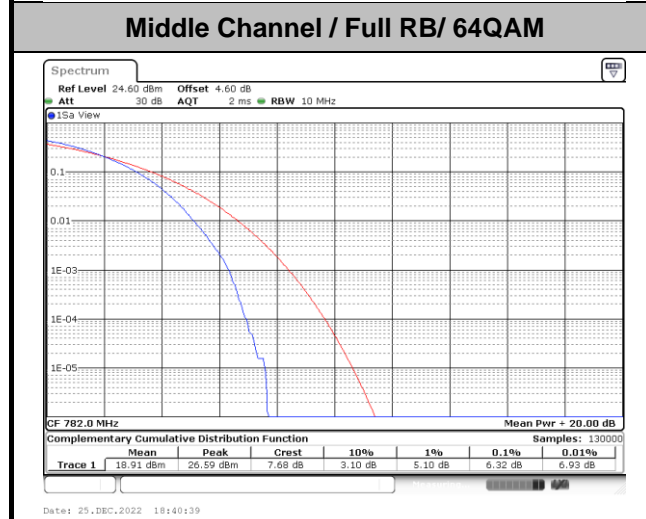
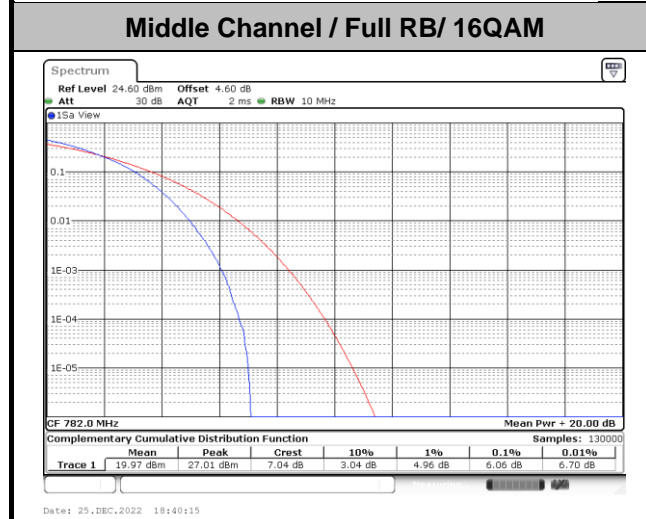
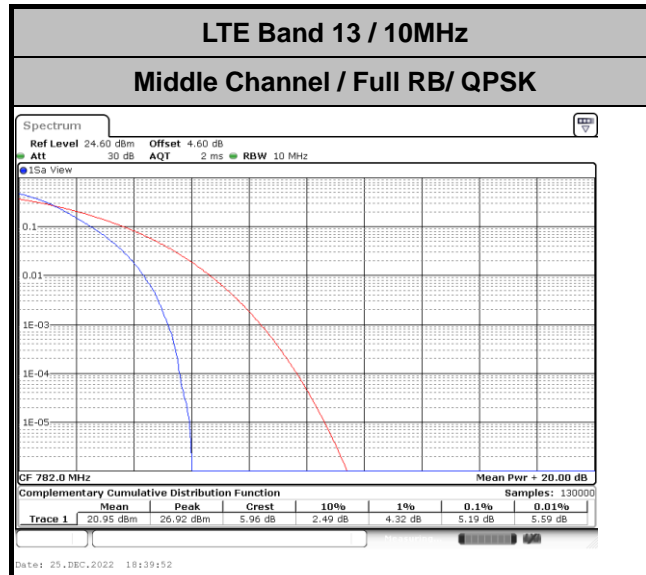



26dB Bandwidth

Mode	LTE Band 13 : 26dB BW(MHz)	
BW	10MHz	
Mod.	QPSK	16QAM
Middle CH	9.63	9.85
BW	5MHz	
Mod.	QPSK	16QAM
Middle CH	4.94	5.08

