

# FCC RF Test Report

APPLICANT : Motorola Mobility LLC  
EQUIPMENT : Mobile Cellular Phone  
BRAND NAME : Motorola  
MODEL NAME : XT2313-3, XT2313-4, XT2313-6  
FCC ID : IHDT56AJ8  
STANDARD : 47 CFR Part 2, 27  
CLASSIFICATION : PCS Licensed Transmitter Held to Ear (PCE)  
TEST DATE(S) : Dec. 01, 2022 ~ Dec. 23, 2022

We, Sporton International Inc. (Kunshan), would like to declare that the tested sample has been evaluated in accordance with the procedures given in ANSI C63.26-2015 and shown compliance with the applicable technical standards.

This report contains data that were produced under subcontract by Sporton International Inc. (Shenzhen).

The test results in this report apply exclusively to the tested model / sample. Without written approval of Sporton International Inc. (Kunshan), the test report shall not be reproduced except in full.

Jason Jia

Approved by: Jason Jia



**Sporton International Inc. (Kunshan)**

**No. 1098, Pengxi North Road, Kunshan Economic Development Zone Jiangsu Province 215300  
People's Republic of China**



TABLE OF CONTENTS

REVISION HISTORY..... 3
SUMMARY OF TEST RESULT ..... 4
1 GENERAL DESCRIPTION ..... 5
1.1 Applicant ..... 5
1.2 Manufacturer ..... 5
1.3 Product Feature of Equipment Under Test ..... 5
1.4 Product Specification of Equipment Under Test ..... 5
1.5 Specification of Accessory ..... 6
1.6 Modification of EUT ..... 6
1.7 Maximum EIRP and Emission Designator ..... 6
1.8 Testing Site ..... 6
1.9 Test Software ..... 7
1.10 Applied Standards ..... 7
2 TEST CONFIGURATION OF EQUIPMENT UNDER TEST ..... 8
2.1 Test Mode ..... 8
2.2 Connection Diagram of Test System ..... 9
2.3 Support Unit used in test configuration and system ..... 9
2.4 Measurement Results Explanation Example ..... 10
2.5 Frequency List of Low/Middle/High Channels ..... 10
3 CONDUCTED TEST ITEMS ..... 11
3.1 Measuring Instruments ..... 11
3.2 Test Setup ..... 11
3.3 Test Result of Conducted Test ..... 11
3.4 Conducted Output Power Measurement ..... 12
3.5 Peak-to-Average Ratio ..... 13
3.6 EIRP ..... 14
3.7 Occupied Bandwidth ..... 15
3.8 Conducted Band Edge Measurement ..... 16
3.9 Conducted Spurious Emission Measurement ..... 17
3.10 Frequency Stability Measurement ..... 18
4 RADIATED TEST ITEMS ..... 19
4.1 Measuring Instruments ..... 19
4.2 Test Setup ..... 19
4.3 Test Result of Radiated Test ..... 20
4.4 Radiated Spurious Emission Measurement ..... 21
5 LIST OF MEASURING EQUIPMENT ..... 22
6 UNCERTAINTY OF EVALUATION ..... 23
APPENDIX A. TEST RESULTS OF CONDUCTED TEST
APPENDIX B. TEST RESULTS OF RADIATED TEST
APPENDIX C. TEST SETUP PHOTOGRAPHS



## REVISION HISTORY

| REPORT NO. | VERSION | DESCRIPTION             | ISSUED DATE   |
|------------|---------|-------------------------|---------------|
| FG2N1810N  | Rev. 01 | Initial issue of report | Jan. 11, 2023 |
|            |         |                         |               |
|            |         |                         |               |
|            |         |                         |               |
|            |         |                         |               |
|            |         |                         |               |
|            |         |                         |               |
|            |         |                         |               |
|            |         |                         |               |
|            |         |                         |               |
|            |         |                         |               |
|            |         |                         |               |
|            |         |                         |               |
|            |         |                         |               |
|            |         |                         |               |



### SUMMARY OF TEST RESULT

| Report Section | FCC Rule                 | Description                                  | Limit                               | Result      | Remark                                       |
|----------------|--------------------------|--|-------------------------------------|-------------|--|
| 3.4            | §2.1046                  | Conducted Output Power                       | —                                   | Report Only | -  |
| 3.5            | -                        | Peak-to-Average Ratio                        | —                                   | Report Only |  |
| 3.6            | §27.50 (a)(3)            | EIRP   | EIRP < 250mW/5MHz                   | PASS        | -  |
| 3.7            | §2.1049                  | Occupied Bandwidth                           | —                                   | Report Only | -  |
| 3.8            | §2.1051<br>§27.53 (a)(4) | Conducted Band Edge Measurement              | Refer standard                      | PASS        | -  |
| 3.9            | §2.1051<br>§27.53 (a)(4) | Conducted Spurious Emission                  | < 70+10log <sub>10</sub> (P[Watts]) | PASS        | -  |
| 3.10           | §2.1055<br>§27.54        | Frequency Stability<br>Temperature & Voltage | Within the band                     | PASS        | -  |
| 4.4            | §2.1053<br>§27.53 (a)(4) | Radiated Spurious Emission                   | < 70+10log <sub>10</sub> (P[Watts]) | PASS        | Under limit<br>5.63 dB at<br>4612.000<br>MHz |

**Declaration of Conformity:**

The test results with all measurement uncertainty excluded are presented in accordance with the regulation limits or requirements declared by manufacturers.

**Comments and Explanations:**

The declared of product specification for EUT presented in the report are provided by the manufacturer, and the manufacturer takes all the responsibilities for the accuracy of product specification.



# 1 General Description

## 1.1 Applicant

Motorola Mobility LLC  
222 W,Merchandise Mart Plaza, Chicago IL 60654 USA

## 1.2 Manufacturer

Motorola Mobility LLC  
222 W,Merchandise Mart Plaza, Chicago IL 60654 USA

## 1.3 Product Feature of Equipment Under Test

| Product Feature |  |
|-----------------|--|
| Equipment       | Mobile Cellular Phone                                      |
| Brand Name      | Motorola   |
| Model Name      | XT2313-3, XT2313-4, XT2313-6                               |
| FCC ID          | IHDT56AJ8  |
| IMEI Code       | Conducted : 353054820021830<br>Radiation : 353054820015733 |
| HW Version      | DVT2   |
| SW Version      | T1TPN33.13   |
| EUT Stage       | Identical Prototype  |

Remark: The three model name XT2313-3, XT2313-4, XT2313-6 are the same product except model name different for market segment.

## 1.4 Product Specification of Equipment Under Test

| Product Feature    |   |
|--------------------|---|
| Tx Frequency       | 5G NR n30 : 2305 MHz ~ 2315 MHz   |
| Rx Frequency       | 5G NR n30 : 2350 MHz ~ 2360 MHz   |
| Bandwidth          | 5MHz / 10MHz  |
| SCS                | 15kHz   |
| Antenna Gain       | <Ant. 1> -1.92 dBi<br><Ant. 4> -1.6 dBi   |
| Type of Modulation | CP-OFDM: QPSK / 16QAM / 64QAM / 256QAM<br>DFT-s-OFDM: PI/2 BPSK / QPSK / 16QAM / 64QAM / 256QAM |

Remark:

1. The device supports two PAs for 5G NR n30(main PA for Ant. 1 and other PA for Ant. 4).
2. 5G NR n30 main PA supports SA mode and NSA mode. The whole testing has assessed SA mode by referring to the higher conducted power for conducted test items.
3. 5G NR n30 other PA supports NSA mode only.
4. The EN-DC mode combination could be referred to the product spec.

- For NSA mode of all EN-DC combination, we only show the combination of the maximum power among all NSA combinations in the report.

### 1.5 Specification of Accessory

| Specification of Accessory |            |                    |            |           |
|----------------------------|------------|--------------------|------------|-----------|
| Battery 1                  | Brand Name | Motorola (ATL)     | Model Name | NH50      |
| Battery 2                  | Brand Name | Motorola (Sunwoda) | Model Name | NH50      |
| USB Cable 1                | Brand Name | Motorola (Saibao)  | Model Name | SLQ-A212A |
| USB Cable 2                | Brand Name | Motorola (NAIYI)   | Model Name | 1.1.0196  |

### 1.6 Modification of EUT

No modifications are made to the EUT during all test items.

### 1.7 Maximum EIRP and Emission Designator

| 5G NR n30 |                       | PI/2 BPSK / QPSK |                              | 16QAM / 64QAM / 256QAM |                              |
|-----------|-----------------------|------------------|------------------------------|------------------------|------------------------------|
| BW (MHz)  | Frequency Range (MHz) | Maximum EIRP(W)  | Emission Designator (99%OBW) | Maximum EIRP(W)        | Emission Designator (99%OBW) |
| 5         | 2307.5 ~ 2312.5       | 0.1358           | 4M49G7D                      | 0.1219                 | 4M49W7D                      |
| 10        | 2310.0                | 0.1406           | 9M29G7D                      | 0.1282                 | 9M30W7D                      |

Note: All modulations have been tested, and only the worst test results of PSK & QAM are shown in the report.

### 1.8 Testing Site

Sporton International Inc. (Kunshan) is accredited to ISO/IEC 17025:2017 by American Association for Laboratory Accreditation with Certificate Number 5145.02.

|                    |  |                     |                                |
|--------------------|--|---------------------|--------------------------------|
| Test Firm          | Sporton International Inc. (Kunshan)   |                     |                                |
| Test Site Location | No. 1098, Pengxi North Road, Kunshan Economic Development Zone<br>Jiangsu Province 215300 People’s Republic of China<br>TEL : +86-512-57900158<br>FAX : +86-512-57900958 |                     |                                |
| Test Site No.      | Sporton Site No.   | FCC Designation No. | FCC Test Firm Registration No. |
|                    | 03CH04-KS  | CN1257              | 314309                         |



Sporton International Inc. (ShenZhen) is accredited to ISO/IEC 17025:2017 by American Association for Laboratory Accreditation with Certificate Number 5145.01.

|                           |   |                            |                                       |
|---------------------------|---|----------------------------|---------------------------------------|
| <b>Test Firm</b>          | Sporton International Inc. (ShenZhen)   |                            |                                       |
| <b>Test Site Location</b> | 1/F, 2/F, Bldg 5, Shiling Industrial Zone, Xinwei Village, Xili, Nanshan, Shenzhen, 518055 People's Republic of China<br>TEL: +86-755-86379589<br>FAX: +86-755-86379595 |                            |                                       |
| <b>Test Site No.</b>      | <b>Sporton Site No.</b>   | <b>FCC Designation No.</b> | <b>FCC Test Firm Registration No.</b> |
|                           | TH01-SZ   | CN1256                     | 421272                                |

Test data subcontracted: Conducted test case in section 3 of this report.

### 1.9 Test Software

| Item | Site      | Manufacturer | Name | Version       |
|------|-----------|--------------|------|---------------|
| 1.   | 03CH04-KS | AUDIX        | E3   | 6.2009-8-24al |

### 1.10 Applied Standards

According to the specifications of the manufacturer, the EUT must comply with the requirements of the following standards:

- ♦ 47 CFR Part 2, Part 27(D)
- ♦ ANSI C63.26-2015
- ♦ FCC KDB 971168 Power Meas License Digital Systems D01 v03r01
- ♦ FCC KDB 412172 D01 Determining ERP and EIRP v01r01
- ♦

**Remark:**

1. All test items were verified and recorded according to the standards and without any deviation during the test.
2. This EUT has also been tested and complied with the requirements of FCC Part 15, Subpart B, recorded in a separate test report.



## 2 Test Configuration of Equipment Under Test

### 2.1 Test Mode

Antenna port conducted and radiated test items listed below are performed according to KDB 971168 D01 Power Meas. License Digital Systems v03r01 with maximum output power.

Radiated measurements are performed by rotating the EUT in three different orthogonal test planes to find the maximum emission. (X-Plane)

| Conducted Test Cases        | Band  | Bandwidth (MHz) |   |   |    |    |    | Modulation |      |       |       |        | RB # |      |      | Test Channel |   |   |  |
|-----------------------------|---|-----------------|---|---|----|----|----|------------|------|-------|-------|--------|------|------|------|--------------|---|---|--|
|                             |   | 1.4             | 3 | 5 | 10 | 15 | 20 | PI/2 BPSK  | QPSK | 16QAM | 64QAM | 256QAM | 1    | Half | Full | L            | M | H |  |
| Max. Output Power           | n30   | -               | - | V |    | -  | -  | V          | V    | V     | V     | V      | V    |      | V    | V            | V | V |  |
|                             |   | -               | - |   | V  | -  | -  | V          | V    | V     | V     | V      | V    |      | V    |              | V |   |  |
| Peak-to-Average Ratio       | n30   | -               | - | V |    | -  | -  | V          | V    |       |       |        | V    |      | V    | V            | V |   |  |
| E.I.R.P                     | n30   | -               | - | V |    | -  | -  | V          | V    | V     | V     | V      | V    |      | V    | V            | V | V |  |
|                             |   | -               | - |   | V  | -  | -  | V          | V    | V     | V     | V      | V    |      | V    |              | V |   |  |
| 26dB and 99% Bandwidth      | n30   | -               | - | V |    | -  | -  | V          | V    | V     | V     | V      |      |      | V    |              | V |   |  |
|                             |   | -               | - |   | V  | -  | -  | V          | V    | V     | V     | V      |      |      | V    |              | V |   |  |
| Conducted Band Edge         | n30   | -               | - | V |    | -  | -  | V          | V    |       |       |        | V    |      | V    | V            |   | V |  |
|                             |   | -               | - |   | V  | -  | -  | V          | V    |       |       |        | V    |      | V    |              | V |   |  |
| Conducted Spurious Emission | n30   | -               | - | V |    | -  | -  | V          | V    |       |       |        | V    |      |      | V            | V | V |  |
|                             |   | -               | - |   | V  | -  | -  | V          | V    |       |       |        | V    |      |      |              | V |   |  |
| Frequency Stability         | n30   | -               | - | V |    | -  | -  |            | V    |       |       |        |      |      | V    |              | V |   |  |
| Radiated Spurious Emission  | n30   | Worst Case      |   |   |    |    |    |            |      |       |       |        |      |      |      |              |   | V |  |
| Note                        | <ol style="list-style-type: none"> <li>The mark "v " means that this configuration is chosen for testing</li> <li>The mark "-" means that this bandwidth is not supported.</li> <li>The device is investigated from 30MHz to 10 times of fundamental signal for radiated spurious emission test under different RB size/offset and modulations in exploratory test. Subsequently, only the worst case emissions are reported.</li> <li>Frequency Stability: Normal Voltage = 3.87V; Low Voltage =3.6V; High Voltage =4.51V</li> </ol> |                 |   |   |    |    |    |            |      |       |       |        |      |      |      |              |   |   |  |



## 2.2 Connection Diagram of Test System

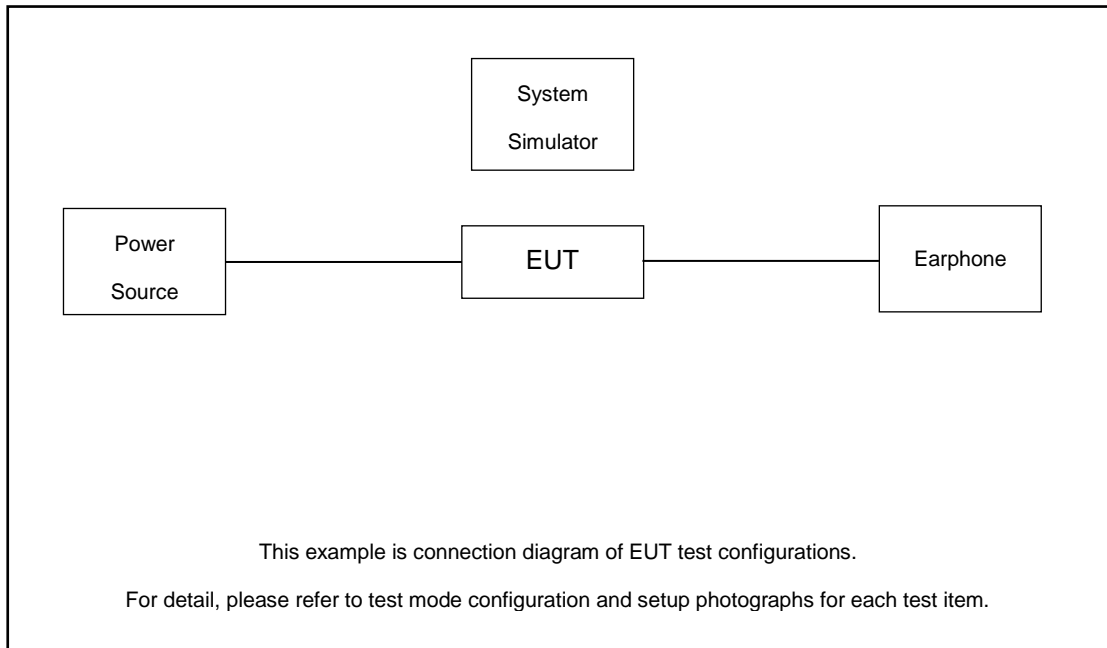

## 2.3 Support Unit used in test configuration and system

| Item | Equipment        | Trade Name | Model No. | FCC ID | Data Cable       | Power Cord        |
|------|------------------|------------|-----------|--------|------------------|-------------------|
| 1.   | Power Supply     | GWINSTEK   | PSS-2002  | N/A    | N/A              | Unshielded, 1.8 m |
| 2.   | NR Base Station  | Anritsu    | MT8000A   | N/A    | N/A              | Unshielded, 1.8 m |
| 3.   | LTE Base Station | Anritsu    | MT8821C   | N/A    | N/A              | Unshielded, 1.8 m |
| 4.   | Earphone         | Lenovo     | P121      | N/A    | Unshielded, 1.2m | N/A               |
| 5.   | Adapter          | Moto       | MC-101    | N/A    | N/A              | N/A               |

## 2.4 Measurement Results Explanation Example

**For all conducted test items:**

The offset level is set in the spectrum analyzer to compensate the RF cable loss between EUT conducted output port and spectrum analyzer. With the offset compensation, the spectrum analyzer reading level is exactly the EUT RF output level.

The spectrum analyzer offset is derived from RF cable loss.

*Offset = RF cable loss.*

Following shows an offset computation example with cable loss 8.40 dB.

Example :

*Offset(dB) = RF cable loss(dB).*

*= 8.40 (dB)*

## 2.5 Frequency List of Low/Middle/High Channels

| 5G NR n30 Channel and Frequency List |                        |        |        |         |
|--------------------------------------|------------------------|--------|--------|---------|
| BW [MHz]                             | Channel/Frequency(MHz) | Lowest | Middle | Highest |
| 10                                   | Channel                | -      | 27710  | -       |
|                                      | Frequency              | -      | 2310   | -       |
| 5                                    | Channel                | 27685  | 27710  | 27735   |
|                                      | Frequency              | 2307.5 | 2310   | 2312.5  |

### 3 Conducted Test Items

#### 3.1 Measuring Instruments

See list of measuring instruments of this test report.

#### 3.2 Test Setup

##### 3.2.1 Conducted Output Power

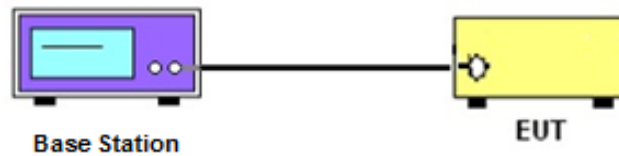

##### 3.2.2 Peak-to-Average Ratio, Occupied / 26dB Bandwidth, Band-Edge and Conducted Spurious Emission

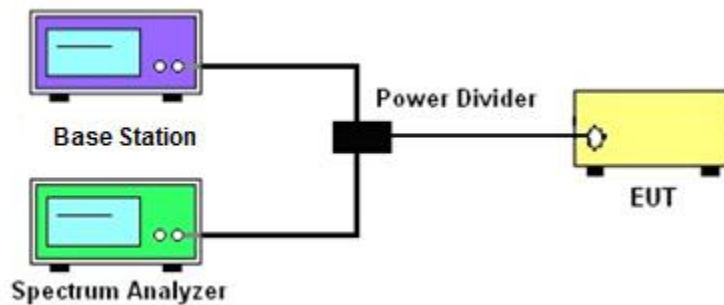

##### 3.2.3 Frequency Stability



### 3.3 Test Result of Conducted Test

Please refer to Appendix A.



## 3.4 Conducted Output Power Measurement

### 3.4.1 Description of the Conducted Output Power Measurement

A base station simulator was used to establish communication with the EUT. Its parameters were set to transmit the maximum power on the EUT. The measured power in the radio frequency on the transmitter output terminals shall be reported.

### 3.4.2 Test Procedures

1. The testing follows ANSI C63.26 Section 5.2
2. The transmitter output port was connected to the system simulator.
3. Set EUT at maximum power through the system simulator.
4. Select lowest, middle, and highest channels for each band and different modulation.
5. Measure and record the power level from the system simulator.

## 3.5 Peak-to-Average Ratio

### 3.5.1 Description of the PAR Measurement

Power Complementary Cumulative Distribution Function (CCDF) curves provide a means for characterizing the power peaks of a digitally modulated signal on a statistical basis. A CCDF curve depicts the probability of the peak signal amplitude exceeding the average power level. Most contemporary measurement instrumentation include the capability to produce CCDF curves for an input signal provided that the instrument's resolution bandwidth can be set wide enough to accommodate the entire input signal bandwidth. In measuring transmissions in this band using an average power technique, the peak-to-average ratio (PAR) of the transmission may not exceed 13 dB.

### 3.5.2 Test Procedures

1. The testing follows ANSI C63.26 Section 5.2.3.4 (CCDF).
2. The EUT was connected to spectrum and system simulator via a power divider.
3. Set the CCDF (Complementary Cumulative Distribution Function) option in spectrum analyzer.
4. The highest RF powers were measured and recorded the maximum PAPR level associated with a probability of 0.1 %.
5. Record the deviation as Peak to Average Ratio.

## 3.6 EIRP

### 3.6.1 Description of EIRP

For mobile and portable stations transmitting in the 2305-2315 MHz band or the 2350-2360 MHz band, the average EIRP must not exceed 50 milliwatts within any 1 megahertz of authorized bandwidth, *except that* for mobile and portable stations compliant with 3GPP LTE standards or another advanced mobile broadband protocol that avoids concentrating energy at the edge of the operating band the average EIRP must not exceed 250 milliwatts within any 5 megahertz of authorized bandwidth but may exceed 50 milliwatts within any 1 megahertz of authorized bandwidth. For mobile and portable stations using time division duplexing (TDD) technology, the duty cycle must not exceed 38 percent in the 2305-2315 MHz and 2350-2360 MHz bands. Mobile and portable stations using FDD technology are restricted to transmitting in the 2305-2315 MHz band. Power averaging shall not include intervals in which the transmitter is off.

### 3.6.2 Test Procedures

1. According to KDB 412172 D01 Power Approach,
2.  $EIRP = P_T + G_T - L_C$ ,  $ERP = EIRP - 2.15$ , where

$P_T$  = transmitter output power in dBm

$G_T$  = gain of the transmitting antenna in dBi

$L_C$  = signal attenuation in the connecting cable between the transmitter and antenna in dB

## 3.7 Occupied Bandwidth

### 3.7.1 Description of Occupied Bandwidth Measurement

The occupied bandwidth is the width of a frequency band such that, below the lower and above the upper frequency limits, the mean powers emitted are each equal to a specified percentage 0.5% of the total mean transmitted power.

The 26 dB emission bandwidth is defined as the frequency range between two points, one above and one below the carrier frequency, at which the spectral density of the emission is attenuated 26 dB below the maximum in-band spectral density of the modulated signal. Spectral density (power per unit bandwidth) is to be measured with a detector of resolution bandwidth equal to approximately 1.0% of the emission bandwidth.

### 3.7.2 Test Procedures

1. The testing follows ANSI C63.26 Section 5.4
2. The EUT was connected to spectrum analyzer and system simulator via a power divider.
3. The spectrum analyzer center frequency is set to the nominal EUT channel center frequency. The span range for the spectrum analyzer shall be between two and five times the anticipated OBW.
4. The nominal resolution bandwidth (RBW) shall be in the range of 1 to 5 % of the anticipated OBW, and the VBW shall be at least 3 times the RBW.
5. Set the detection mode to peak, and the trace mode to max hold.
6. Determine the reference value: Set the EUT to transmit a modulated signal. Allow the trace to stabilize. Set the spectrum analyzer marker to the highest level of the displayed trace.  
(this is the reference value)
7. Determine the “-26 dB down amplitude” as equal to (Reference Value – X).
8. Place two markers, one at the lowest and the other at the highest frequency of the envelope of the spectral display such that each marker is at or slightly below the “-X dB down amplitude” determined in step 6. If a marker is below this “-X dB down amplitude” value it shall be placed as close as possible to this value. The OBW is the positive frequency difference between the two markers.
9. Use the 99 % power bandwidth function of the spectrum analyzer and report the measured bandwidth.

## 3.8 Conducted Band Edge Measurement

### 3.8.1 Description of Conducted Band Edge Measurement

27.53 (a)(4)

For mobile and portable stations operating in the 2305-2315 MHz and 2350-2360 MHz bands:

- (i) By a factor of not less than:  $43 + 10 \log (P)$  dB on all frequencies between 2305 and 2320 MHz and on all frequencies between 2345 and 2360 MHz that are outside the licensed band(s) of operation, not less than  $55 + 10 \log (P)$  dB on all frequencies between 2320 and 2324 MHz and on all frequencies between 2341 and 2345 MHz, not less than  $61 + 10 \log (P)$  dB on all frequencies between 2324 and 2328 MHz and on all frequencies between 2337 and 2341 MHz, and not less than  $67 + 10 \log (P)$  dB on all frequencies between 2328 and 2337 MHz;
- (ii) By a factor of not less than  $43 + 10 \log (P)$  dB on all frequencies between 2300 and 2305 MHz,  $55 + 10 \log (P)$  dB on all frequencies between 2296 and 2300 MHz,  $61 + 10 \log (P)$  dB on all frequencies between 2292 and 2296 MHz,  $67 + 10 \log (P)$  dB on all frequencies between 2288 and 2292 MHz, and  $70 + 10 \log (P)$  dB below 2288 MHz;
- (iii) By a factor of not less than  $43 + 10 \log (P)$  dB on all frequencies between 2360 and 2365 MHz, and not less than  $70 + 10 \log (P)$  dB above 2365 MHz.

### 3.8.2 Test Procedures

1. The testing follows ANSI C63.26 section 5.7
2. The EUT was connected to spectrum analyzer and system simulator via a power divider.
3. The band edges of low and high channels for the highest RF powers were measured.
4. Set RBW  $\geq$  1% EBW in the 1MHz band immediately outside and adjacent to the band edge.
5. Beyond the 1 MHz band from the band edge, RBW=1MHz was used or a narrower RBW was used and the measured power was integrated over the full required measurement bandwidth of 1 MHz.
6. Set spectrum analyzer with RMS detector.
7. The RF fundamental frequency should be excluded against the limit line in the operating frequency band.
8. Checked that all the results comply with the emission limit line.

Example:

The limit line is derived from  $43 + 10\log(P)$ dB below the transmitter power P(Watts)

$$= P(W) - [43 + 10\log(P)] \text{ (dB)}$$

$$= [30 + 10\log(P)] \text{ (dBm)} - [43 + 10\log(P)] \text{ (dB)} = -13\text{dBm.}$$



## 3.9 Conducted Spurious Emission Measurement

### 3.9.1 Description of Conducted Spurious Emission Measurement

The power of any emission outside of the authorized operating frequency ranges must be lower than the transmitter power (P) by a factor of at least  $70 + 10 \log (P)$  dB.

It is measured by means of a calibrated spectrum analyzer and scanned from 30MHz up to a frequency including its 10<sup>th</sup> harmonic.

### 3.9.2 Test Procedures

1. The testing follows ANSI C63.26 section 5.7
2. The EUT was connected to spectrum analyzer and system simulator via a power divider.
3. The RF output of EUT was connected to the spectrum analyzer by RF cable and attenuator. The path loss was compensated to the results for each measurement.
4. The middle channel for the highest RF power within the transmitting frequency was measured.
5. The conducted spurious emission for the whole frequency range was taken.
6. Make the measurement with the spectrum analyzer's RBW = 1MHz, VBW = 3MHz.
7. Set spectrum analyzer with RMS detector.
8. Taking the record of maximum spurious emission.
9. The RF fundamental frequency should be excluded against the limit line in the operating frequency band.
10. The limit line is derived from  $70 + 10\log(P)$ dB below the transmitter power P(Watts)  
= P(W)- [70 + 10log(P)] (dB)  
= [30 + 10log(P)] (dBm) - [70 + 10log(P)] (dB)  
= -40dBm

## 3.10 Frequency Stability Measurement

### 3.10.1 Description of Frequency Stability Measurement

The frequency stability shall be measured by variation of ambient temperature and variation of primary supply voltage to ensure that the fundamental emission stays within the authorized frequency block.

### 3.10.2 Test Procedures for Temperature Variation

1. The testing follows ANSI C63.26 section 5.6.4
2. The EUT was set up in the thermal chamber and connected with the system simulator.
3. With power OFF, the temperature was decreased to  $-30^{\circ}\text{C}$  and the EUT was stabilized before testing. Power was applied and the maximum change in frequency was recorded within one minute.
4. With power OFF, the temperature was raised in  $10^{\circ}\text{C}$  step up to  $50^{\circ}\text{C}$ . The EUT was stabilized at each step for at least half an hour. Power was applied and the maximum frequency change was recorded within one minute.

### 3.10.3 Test Procedures for Voltage Variation

1. The testing follows ANSI C63.26 section 5.6.5.
2. The EUT was placed in a temperature chamber at  $20\pm 5^{\circ}\text{C}$  and connected with the system simulator.
3. The power supply voltage to the EUT was varied from 85% to 115% of the nominal value for other than hand carried battery equipment.
4. For hand carried, battery powered equipment, reduce the primary ac or dc supply voltage to the battery operating end point, which shall be specified by the manufacturer.
5. The variation in frequency was measured for the worst case.

## 4 Radiated Test Items

### 4.1 Measuring Instruments

See list of measuring instruments of this test report.

### 4.2 Test Setup

#### 4.2.1 For radiated test below 30MHz



#### 4.2.2 For radiated test from 30MHz to 1GHz

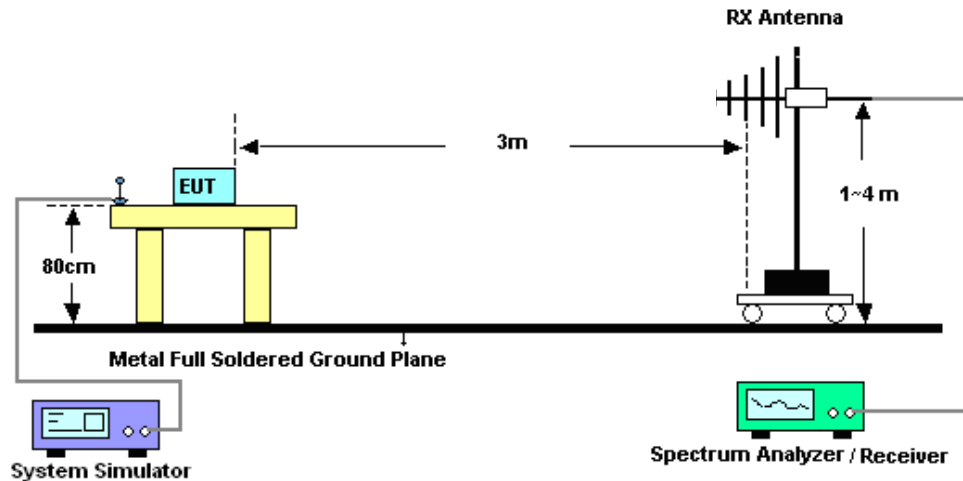

**4.2.3 For radiated test above 1GHz**



**4.3 Test Result of Radiated Test**

The low frequency, which started from 9 kHz to 30MHz, was pre-scanned and the result which was 20dB lower than the limit line was not reported.

Please refer to Appendix B.

## 4.4 Radiated Spurious Emission Measurement

### 4.4.1 Description of Radiated Spurious Emission

The radiated spurious emission was measured by substitution method according to ANSI/TIA-603-E. The power of any emission outside of the authorized operating frequency ranges must be attenuated below the transmitter power (P) by a factor of at least  $70 + 10 \log(P)$  dB.

The spectrum is scanned from 30 MHz up to a frequency including its 10th harmonic.

### 4.4.2 Test Procedures

1. The testing follows ANSI C63.26 Section 5.5
2. The EUT was placed on a turntable with 0.8 meter height for frequency below 1GHz and 1.5 meter height for frequency above 1GHz respectively above ground.
3. The EUT was set 3 meters from the receiving antenna mounted on the antenna tower.
4. The table was rotated 360 degrees to determine the position of the highest spurious emission.
5. The height of the receiving antenna is varied between 1m to 4m to search the maximum spurious emission for both horizontal and vertical polarizations.
6. During the measurement, the system simulator parameters were set to force the EUT transmitting at maximum output power.
7. Make the measurement with the spectrum analyzer's RBW = 1MHz, VBW = 3MHz, taking the record of maximum spurious emission.
8. A horn antenna was substituted in place of the EUT and was driven by a signal generator.
9. Tune the output power of signal generator to the same emission level with EUT maximum spurious emission.

$$\text{EIRP (dBm)} = \text{S.G. Power} - \text{Tx Cable Loss} + \text{Tx Antenna Gain}$$

$$\text{ERP (dBm)} = \text{EIRP} - 2.15$$

10. The RF fundamental frequency should be excluded against the limit line in the operating frequency band.

The limit line is derived from  $70 + 10\log(P)$ dB below the transmitter power P(Watts)

$$= P(W) - [70 + 10\log(P)] \text{ (dB)}$$

$$= [30 + 10\log(P)] \text{ (dBm)} - [70 + 10\log(P)] \text{ (dB)}$$

$$= -40\text{dBm.}$$



## 5 List of Measuring Equipment

| Instrument            | Manufacturer                 | Model No.        | Serial No.         | Characteristics      | Calibration Date | Test Date                       | Due Date      | Remark                |
|-----------------------|------------------------------|------------------|--------------------|----------------------|------------------|---------------------------------|---------------|-----------------------|
| EMI Test Receiver&SA  | Agilent                      | N9038A           | MY52260185         | 20Hz~26.5GHz         | Dec. 27, 2021    | Dec. 01, 2022~<br>Dec. 18, 2022 | Dec. 26, 2022 | Conducted (TH01-SZ)   |
| Power Divider         | TOJOIN                       | PS-2SM-04<br>265 | 60.06.020.007<br>7 | 0.4GHz~26.5GHz       | Dec. 25, 2021    | Dec. 01, 2022~<br>Dec. 18, 2022 | Dec. 24, 2022 | Conducted (TH01-SZ)   |
| Thermal Chamber       | Ten Billion<br>Hongzhangroup | LP-150U          | H2014081803        | -40~+150°C           | Jul. 07, 2022    | Dec. 01, 2022~<br>Dec. 18, 2022 | Jul. 06, 2023 | Conducted (TH01-SZ)   |
| EXA Spectrum Analyzer | Keysight                     | N9010B           | MY57471079         | 10Hz-44G,MAX<br>30dB | Oct. 12, 2022    | Dec. 23, 2022                   | Oct. 11, 2023 | Radiation (03CH04-KS) |
| Loop Antenna          | R&S                          | HFH2-Z2          | 100321             | 9kHz~30MHz           | Oct. 29, 2022    | Dec. 23, 2022                   | Oct. 28, 2023 | Radiation (03CH04-KS) |
| Bilog Antenna         | TeseQ                        | CBL6111D         | 49922              | 30MHz-1GHz           | May 24, 2022     | Dec. 23, 2022                   | May 23, 2023  | Radiation (03CH04-KS) |
| Horn Antenna          | Schwarzbeck                  | BBHA9120D        | 1284               | 1GHz~18GHz           | Jan. 05, 2022    | Dec. 23, 2022                   | Jan. 04, 2023 | Radiation (03CH04-KS) |
| SHF-EHF Horn          | Com-power                    | AH-840           | 101070             | 18GHz~40GHz          | Jan. 05, 2022    | Dec. 23, 2022                   | Jan. 04, 2023 | Radiation (03CH04-KS) |
| Amplifier             | SONOMA                       | 310N             | 187289             | 9KHz-1GHz            | Jan. 05, 2022    | Dec. 23, 2022                   | Jan. 04, 2023 | Radiation (03CH04-KS) |
| Amplifier             | MITEQ                        | EM18G40G<br>GA   | 060728             | 18~40GHz             | Jan. 05, 2022    | Dec. 23, 2022                   | Jan. 04, 2023 | Radiation (03CH04-KS) |
| high gain Amplifier   | EM                           | EM01G18G<br>A    | 060840             | 1Ghz-18Ghz           | Oct. 12, 2022    | Dec. 23, 2022                   | Oct. 11, 2023 | Radiation (03CH04-KS) |
| Amplifier             | Agilent                      | 8449B            | 3008A02370         | 1Ghz-18Ghz           | Oct. 12, 2022    | Dec. 23, 2022                   | Oct. 11, 2023 | Radiation (03CH04-KS) |
| AC Power Source       | Chroma                       | 61601            | F104090004         | N/A                  | NCR              | Dec. 23, 2022                   | NCR           | Radiation (03CH04-KS) |
| Turn Table            | ChamPro                      | EM 1000-T        | 060762-T           | 0~360 degree         | NCR              | Dec. 23, 2022                   | NCR           | Radiation (03CH04-KS) |
| Antenna Mast          | ChamPro                      | EM 1000-A        | 060762-A           | 1 m~4 m              | NCR              | Dec. 23, 2022                   | NCR           | Radiation (03CH04-KS) |

NCR: No Calibration Required



## 6 Uncertainty of Evaluation

The measurement uncertainties shown below were calculated in accordance with the requirements of ANSI 63.26-2015. All the measurement uncertainty value were shown with a coverage K=2 to indicate 95% level of confidence. The measurement data show herein meets or exceeds the CISPR measurement uncertainty values specified in CISPR 16-4-2 and can be compared directly to specified limit to determine compliance.

### Uncertainty of Conducted Measurement

| Test Item                  | Uncertainty |
|----------------------------|-------------|
| Conducted Power            | ±1.34 dB    |
| Conducted Emissions        | ±1.34 dB    |
| Occupied Channel Bandwidth | ±0.12 %     |

### Uncertainty of Radiated Emission Measurement (30 MHz ~ 1000 MHz)

|   |       |
|---|-------|
| Measuring Uncertainty for a Level of Confidence of 95% (U = 2Uc(y)) | 3.3dB |
|---|-------|

### Uncertainty of Radiated Emission Measurement (1 GHz ~ 18 GHz)

|   |       |
|---|-------|
| Measuring Uncertainty for a Level of Confidence of 95% (U = 2Uc(y)) | 2.8dB |
|---|-------|

### Uncertainty of Radiated Emission Measurement (18 GHz ~ 40 GHz)

|   |       |
|---|-------|
| Measuring Uncertainty for a Level of Confidence of 95% (U = 2Uc(y)) | 2.8dB |
|---|-------|

----- THE END -----



## Appendix A. Test Results of Conducted Test

|                 |          |                     |         |
|-----------------|----------|---------------------|---------|
| Test Engineer : | Jung Kuo | Temperature :       | 22~23°C |
|                 |          | Relative Humidity : | 40~42%  |



# FR1 N30(ANT1)

## Transmitter Conducted Output Power And EIRP,(G<sub>T</sub> - L<sub>C</sub>)=-1.92dB

| NR Band | SCS (kHz) | Bandwidth (MHz) | Arfcn  | Freq (MHz) | Modulation           | RB    | Conducted Power(dBm) | EIRP (dBm) | EIRP (W) |
|---------|-----------|-----------------|--------|------------|----------------------|-------|----------------------|------------|----------|
| 30      | 15        | 5               | 461500 | 2307.5     | DFT-s-OFDM QPSK      | 1@1   | 23.11                | 21.19      | 0.1315   |
| 30      | 15        | 5               | 461500 | 2307.5     | DFT-s-OFDM 16 QAM    | 1@1   | 22.77                | 20.85      | 0.1216   |
| 30      | 15        | 5               | 462000 | 2310.0     | DFT-s-OFDM QPSK      | 1@1   | 23.2                 | 21.28      | 0.1343   |
| 30      | 15        | 5               | 462000 | 2310.0     | DFT-s-OFDM 16 QAM    | 1@1   | 22.72                | 20.8       | 0.1202   |
| 30      | 15        | 5               | 462500 | 2312.5     | DFT-s-OFDM QPSK      | 1@1   | 23.21                | 21.29      | 0.1346   |
| 30      | 15        | 5               | 462500 | 2312.5     | DFT-s-OFDM 16 QAM    | 1@1   | 22.78                | 20.86      | 0.1219   |
| 30      | 15        | 10              | 462000 | 2310.0     | DFT-s-OFDM PI/2 BPSK | 25@12 | 23.24                | 21.32      | 0.1355   |
| 30      | 15        | 10              | 462000 | 2310.0     | DFT-s-OFDM PI/2 BPSK | 1@1   | 23.2                 | 21.28      | 0.1343   |
| 30      | 15        | 10              | 462000 | 2310.0     | DFT-s-OFDM PI/2 BPSK | 1@50  | 23.19                | 21.27      | 0.1340   |
| 30      | 15        | 10              | 462000 | 2310.0     | DFT-s-OFDM QPSK      | 25@12 | 23.26                | 21.34      | 0.1361   |
| 30      | 15        | 10              | 462000 | 2310.0     | DFT-s-OFDM QPSK      | 1@1   | 23.4                 | 21.48      | 0.1406   |
| 30      | 15        | 10              | 462000 | 2310.0     | DFT-s-OFDM QPSK      | 1@50  | 23.34                | 21.42      | 0.1387   |
| 30      | 15        | 10              | 462000 | 2310.0     | DFT-s-OFDM 16 QAM    | 25@12 | 22.77                | 20.85      | 0.1216   |
| 30      | 15        | 10              | 462000 | 2310.0     | DFT-s-OFDM 16 QAM    | 1@1   | 23                   | 21.08      | 0.1282   |
| 30      | 15        | 10              | 462000 | 2310.0     | DFT-s-OFDM 16 QAM    | 1@50  | 22.87                | 20.95      | 0.1245   |
| 30      | 15        | 10              | 462000 | 2310.0     | DFT-s-OFDM 64 QAM    | 25@12 | 21.84                | 19.92      | 0.0982   |
| 30      | 15        | 10              | 462000 | 2310.0     | DFT-s-OFDM 64 QAM    | 1@1   | 21.84                | 19.92      | 0.0982   |
| 30      | 15        | 10              | 462000 | 2310.0     | DFT-s-OFDM 64 QAM    | 1@50  | 21.78                | 19.86      | 0.0968   |
| 30      | 15        | 10              | 462000 | 2310.0     | DFT-s-OFDM 256 QAM   | 25@12 | 19.22                | 17.3       | 0.0537   |
| 30      | 15        | 10              | 462000 | 2310.0     | DFT-s-OFDM 256 QAM   | 1@1   | 19.36                | 17.44      | 0.0555   |
| 30      | 15        | 10              | 462000 | 2310.0     | DFT-s-OFDM 256 QAM   | 1@50  | 19.25                | 17.33      | 0.0541   |
| 30      | 15        | 10              | 462000 | 2310.0     | CP-OFDM QPSK         | 26@13 | 22.56                | 20.64      | 0.1159   |
| 30      | 15        | 10              | 462000 | 2310.0     | CP-OFDM QPSK         | 1@1   | 22.66                | 20.74      | 0.1186   |
| 30      | 15        | 10              | 462000 | 2310.0     | CP-OFDM QPSK         | 1@50  | 22.25                | 20.33      | 0.1079   |

## Frequency Stability

| NR Band | SCS (kHz) | Bandwidth (MHz) | Arfcn  | Freq (MHz) | Modulation      | RB   | Deviation (ppm) | Verdict | Environment |
|---------|-----------|-----------------|--------|------------|-----------------|------|-----------------|---------|-------------|
| 30      | 15        | 5               | 462000 | 2310.0     | DFT-s-OFDM QPSK | 25@0 | 0.0059          | PASS    | NV          |
| 30      | 15        | 5               | 462000 | 2310.0     | DFT-s-OFDM QPSK | 25@0 | 0.0051          | PASS    | LV          |
| 30      | 15        | 5               | 462000 | 2310.0     | DFT-s-OFDM QPSK | 25@0 | 0.0061          | PASS    | HV          |
| 30      | 15        | 5               | 462000 | 2310.0     | DFT-s-OFDM QPSK | 25@0 | 0.0058          | PASS    | -30°C       |
| 30      | 15        | 5               | 462000 | 2310.0     | DFT-s-OFDM QPSK | 25@0 | 0.0047          | PASS    | -20°C       |
| 30      | 15        | 5               | 462000 | 2310.0     | DFT-s-OFDM QPSK | 25@0 | 0.0032          | PASS    | -10°C       |
| 30      | 15        | 5               | 462000 | 2310.0     | DFT-s-OFDM QPSK | 25@0 | 0.0031          | PASS    | 0°C         |
| 30      | 15        | 5               | 462000 | 2310.0     | DFT-s-OFDM QPSK | 25@0 | 0.0068          | PASS    | 10°C        |
| 30      | 15        | 5               | 462000 | 2310.0     | DFT-s-OFDM QPSK | 25@0 | 0.0059          | PASS    | 20°C        |
| 30      | 15        | 5               | 462000 | 2310.0     | DFT-s-OFDM QPSK | 25@0 | 0.0023          | PASS    | 30°C        |
| 30      | 15        | 5               | 462000 | 2310.0     | DFT-s-OFDM QPSK | 25@0 | 0.0046          | PASS    | 40°C        |
| 30      | 15        | 5               | 462000 | 2310.0     | DFT-s-OFDM QPSK | 25@0 | 0.0070          | PASS    | 50°C        |

## Peak to Average Ratio

| NR Band | SCS (kHz) | Bandwidth (MHz) | Arfcn  | Freq (MHz) | Modulation              | RB   | Result (dB) | Limit (dB) | Verdict |
|---------|-----------|-----------------|--------|------------|-------------------------|------|-------------|------------|---------|
| 30      | 15        | 5               | 461500 | 2307.5     | DFT-s-OFDM<br>PI/2 BPSK | 25@0 | 4.07        | 13         | PASS    |
| 30      | 15        | 5               | 461500 | 2307.5     | DFT-s-OFDM<br>PI/2 BPSK | 1@0  | 4.11        | 13         | PASS    |
| 30      | 15        | 5               | 461500 | 2307.5     | DFT-s-OFDM<br>QPSK      | 25@0 | 5.11        | 13         | PASS    |
| 30      | 15        | 5               | 461500 | 2307.5     | DFT-s-OFDM<br>QPSK      | 1@0  | 4.53        | 13         | PASS    |
| 30      | 15        | 5               | 462000 | 2310.0     | DFT-s-OFDM<br>PI/2 BPSK | 25@0 | 3.89        | 13         | PASS    |
| 30      | 15        | 5               | 462000 | 2310.0     | DFT-s-OFDM<br>PI/2 BPSK | 1@0  | 3.81        | 13         | PASS    |
| 30      | 15        | 5               | 462000 | 2310.0     | DFT-s-OFDM<br>QPSK      | 25@0 | 5.19        | 13         | PASS    |
| 30      | 15        | 5               | 462000 | 2310.0     | DFT-s-OFDM<br>QPSK      | 1@0  | 4.78        | 13         | PASS    |
| 30      | 15        | 5               | 462500 | 2312.5     | DFT-s-OFDM<br>PI/2 BPSK | 25@0 | 3.8         | 13         | PASS    |
| 30      | 15        | 5               | 462500 | 2312.5     | DFT-s-OFDM<br>PI/2 BPSK | 1@0  | 3.75        | 13         | PASS    |
| 30      | 15        | 5               | 462500 | 2312.5     | DFT-s-OFDM<br>QPSK      | 25@0 | 5.15        | 13         | PASS    |
| 30      | 15        | 5               | 462500 | 2312.5     | DFT-s-OFDM<br>QPSK      | 1@0  | 4.84        | 13         | PASS    |

N30(5M)\_DFT-s-OFDM\_PI\_2-BPSK\_Outer\_Full\_Low\_CH



N30(5M)\_DFT-s-OFDM\_PI\_2-BPSK\_Edge\_1RB\_Left\_Low\_CH



N30(5M)\_DFT-s-OFDM\_QPSK\_Outer\_Full\_Low\_CH



N30(5M)\_DFT-s-OFDM\_QPSK\_Edge\_1RB\_Left\_Low\_CH

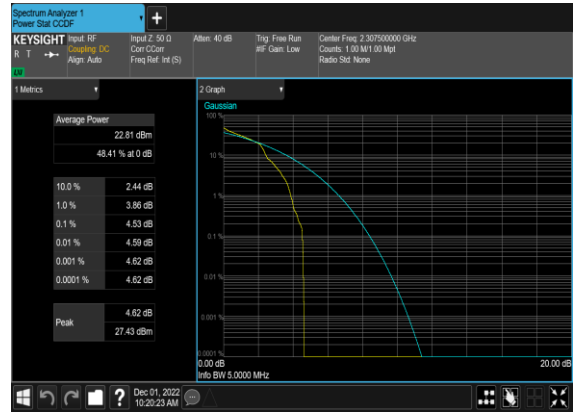

N30(5M)\_DFT-s-OFDM\_PI\_2-BPSK\_Outer\_Full\_Mid\_CH



N30(5M)\_DFT-s-OFDM\_PI\_2-BPSK\_Edge\_1RB\_Left\_Mid\_CH

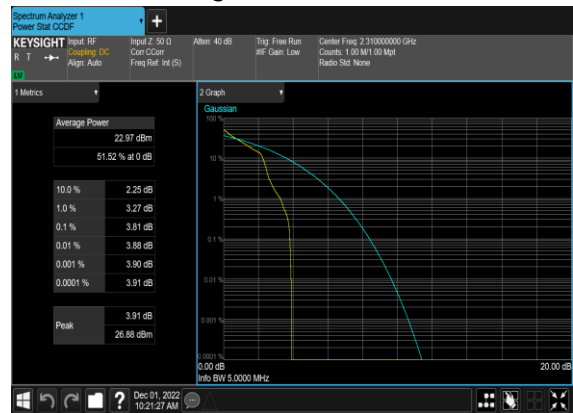

N30(5M)\_DFT-s-OFDM\_QPSK\_Outer\_Full\_Mid\_CH



N30(5M)\_DFT-s-OFDM\_QPSK\_Edge\_1RB\_Left\_Mid\_CH



N30(5M)\_DFT-s-OFDM\_PI\_2-BPSK\_Outer\_Full\_High\_CH

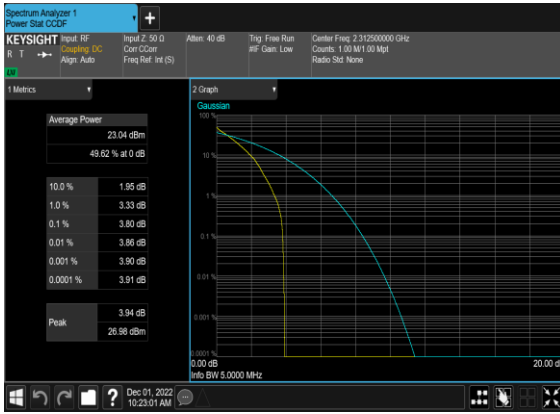

N30(5M)\_DFT-s-OFDM\_PI\_2-BPSK\_Edge\_1RB\_Left\_High\_CH

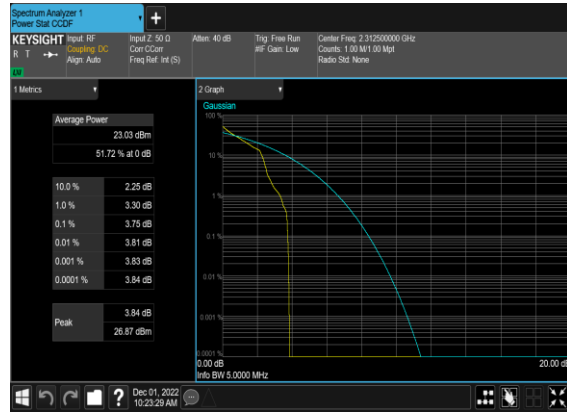

N30(5M)\_DFT-s-OFDM\_QPSK\_Outer\_Full\_High\_CH

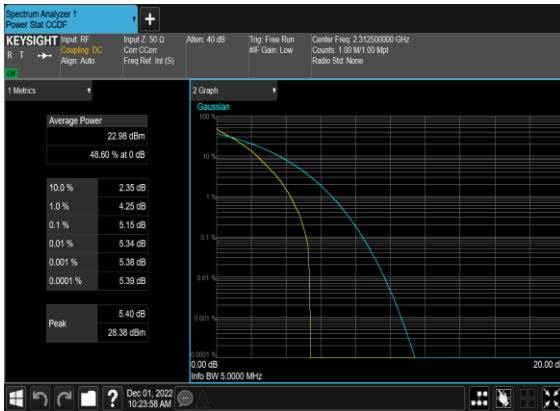

N30(5M)\_DFT-s-OFDM\_QPSK\_Edge\_1RB\_Left\_High\_CH



## Occupied Bandwidth

| NR Band | SCS (kHz) | Bandwidth (MHz) | Arfcn  | Freq (MHz) | Modulation              | RB   | OBW (MHz) | 26dB OBW (MHz) |
|---------|-----------|-----------------|--------|------------|-------------------------|------|-----------|----------------|
| 30      | 15        | 5               | 462000 | 2310.0     | DFT-s-OFDM<br>PI/2 BPSK | 25@0 | 4.474     | 4.94           |
| 30      | 15        | 5               | 462000 | 2310.0     | DFT-s-OFDM<br>QPSK      | 25@0 | 4.4729    | 4.837          |
| 30      | 15        | 5               | 462000 | 2310.0     | CP-OFDM<br>QPSK         | 25@0 | 4.4863    | 4.947          |
| 30      | 15        | 5               | 462000 | 2310.0     | CP-OFDM 16<br>QAM       | 25@0 | 4.4856    | 4.971          |
| 30      | 15        | 5               | 462000 | 2310.0     | CP-OFDM 64<br>QAM       | 25@0 | 4.4786    | 4.963          |
| 30      | 15        | 5               | 462000 | 2310.0     | CP-OFDM 256<br>QAM      | 25@0 | 4.4729    | 4.965          |
| 30      | 15        | 10              | 462000 | 2310.0     | DFT-s-OFDM<br>PI/2 BPSK | 50@0 | 8.8962    | 9.483          |
| 30      | 15        | 10              | 462000 | 2310.0     | DFT-s-OFDM<br>QPSK      | 50@0 | 8.9155    | 9.52           |
| 30      | 15        | 10              | 462000 | 2310.0     | CP-OFDM<br>QPSK         | 52@0 | 9.2897    | 9.93           |
| 30      | 15        | 10              | 462000 | 2310.0     | CP-OFDM 16<br>QAM       | 52@0 | 9.2869    | 9.923          |
| 30      | 15        | 10              | 462000 | 2310.0     | CP-OFDM 64<br>QAM       | 52@0 | 9.2814    | 9.859          |
| 30      | 15        | 10              | 462000 | 2310.0     | CP-OFDM 256<br>QAM      | 52@0 | 9.3004    | 9.959          |

### N30(5M)\_DFT-s-OFDM\_PI\_2-BPSK\_Outer\_Full\_Mid\_CH

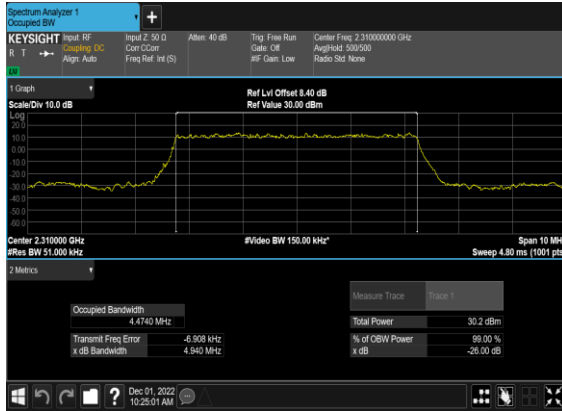

### N30(5M)\_DFT-s-OFDM\_QPSK\_Outer\_Full\_Mid\_CH

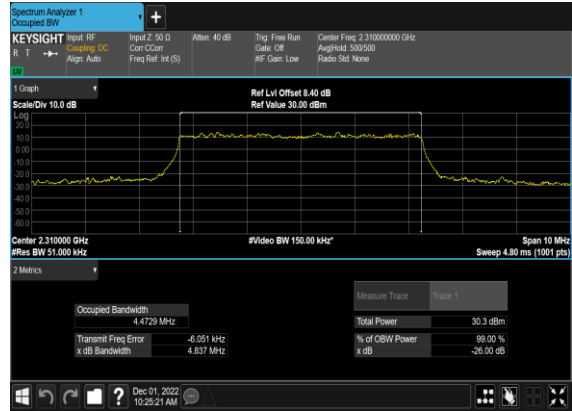

### N30(5M)\_CP-OFDM\_QPSK\_Outer\_Full\_Mid\_CH



### N30(5M)\_CP-OFDM\_16QAM\_Outer\_Full\_Mid\_CH



### N30(5M)\_CP-OFDM\_64QAM\_Outer\_Full\_Mid\_CH

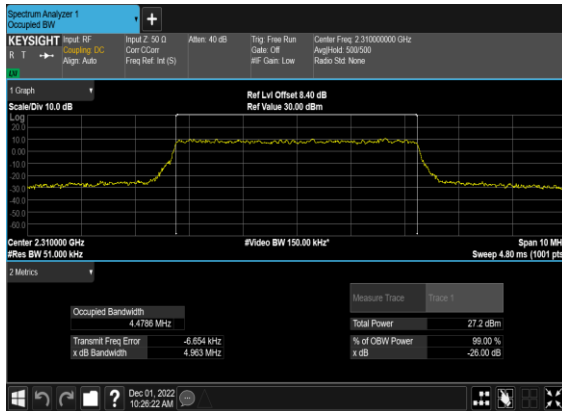

### N30(5M)\_CP-OFDM\_256QAM\_Outer\_Full\_Mid\_CH

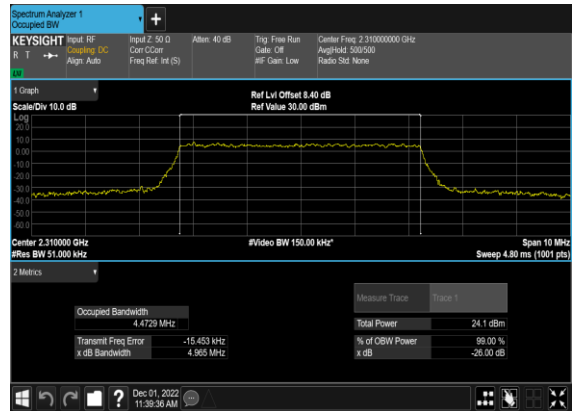

N30(10M)\_DFT-s-OFDM\_PI\_2-  
BPSK\_Outer\_Full\_Low\_CH

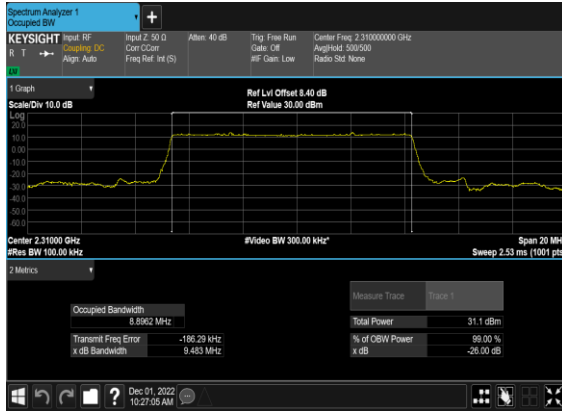

N30(10M)\_DFT-s-  
OFDM\_QPSK\_Outer\_Full\_Low\_CH

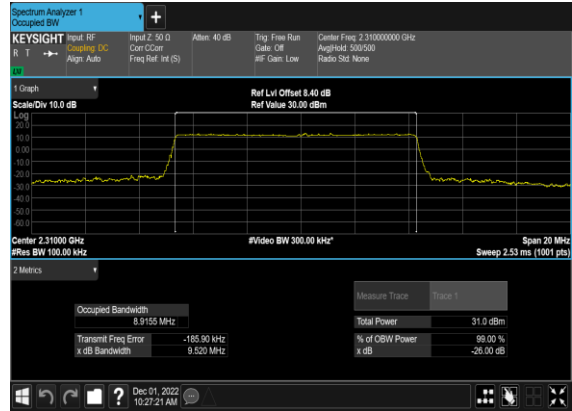

N30(10M)\_CP-  
OFDM\_QPSK\_Outer\_Full\_Low\_CH



N30(10M)\_CP-OFDM\_16  
QAM\_Outer\_Full\_Low\_CH



N30(10M)\_CP-OFDM\_64  
QAM\_Outer\_Full\_Low\_CH

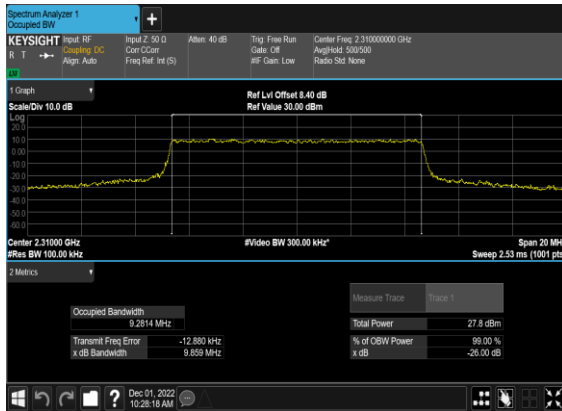

N30(10M)\_CP-OFDM\_256  
QAM\_Outer\_Full\_Low\_CH

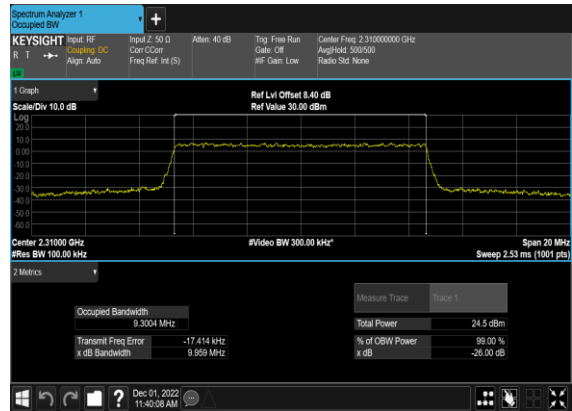



## Conducted Spurious Emissions

| NR Band | SCS (kHz) | Bandwidth (MHz) | Arfcn  | Freq (MHz) | Modulation      | RB  | Result    | Verdict |
|---------|-----------|-----------------|--------|------------|-----------------|-----|-----------|---------|
| 30      | 15        | 5               | 461500 | 2307.5     | DFT-s-OFDM BPSK | 1@0 | see graph | ---     |
| 30      | 15        | 5               | 461500 | 2307.5     | DFT-s-OFDM BPSK | 1@0 | see graph | PASS    |
| 30      | 15        | 5               | 461500 | 2307.5     | DFT-s-OFDM BPSK | 1@0 | see graph | PASS    |
| 30      | 15        | 5               | 461500 | 2307.5     | DFT-s-OFDM QPSK | 1@0 | see graph | ---     |
| 30      | 15        | 5               | 461500 | 2307.5     | DFT-s-OFDM QPSK | 1@0 | see graph | PASS    |
| 30      | 15        | 5               | 461500 | 2307.5     | DFT-s-OFDM QPSK | 1@0 | see graph | PASS    |
| 30      | 15        | 5               | 462000 | 2310.0     | DFT-s-OFDM BPSK | 1@0 | see graph | ---     |
| 30      | 15        | 5               | 462000 | 2310.0     | DFT-s-OFDM BPSK | 1@0 | see graph | PASS    |
| 30      | 15        | 5               | 462000 | 2310.0     | DFT-s-OFDM BPSK | 1@0 | see graph | PASS    |
| 30      | 15        | 5               | 462000 | 2310.0     | DFT-s-OFDM QPSK | 1@0 | see graph | ---     |
| 30      | 15        | 5               | 462000 | 2310.0     | DFT-s-OFDM QPSK | 1@0 | see graph | PASS    |
| 30      | 15        | 5               | 462000 | 2310.0     | DFT-s-OFDM QPSK | 1@0 | see graph | PASS    |
| 30      | 15        | 5               | 462500 | 2312.5     | DFT-s-OFDM BPSK | 1@0 | see graph | ---     |
| 30      | 15        | 5               | 462500 | 2312.5     | DFT-s-OFDM BPSK | 1@0 | see graph | PASS    |
| 30      | 15        | 5               | 462500 | 2312.5     | DFT-s-OFDM BPSK | 1@0 | see graph | PASS    |
| 30      | 15        | 5               | 462500 | 2312.5     | DFT-s-OFDM QPSK | 1@0 | see graph | ---     |
| 30      | 15        | 5               | 462500 | 2312.5     | DFT-s-OFDM QPSK | 1@0 | see graph | PASS    |
| 30      | 15        | 5               | 462500 | 2312.5     | DFT-s-OFDM QPSK | 1@0 | see graph | PASS    |
| 30      | 15        | 10              | 462000 | 2310.0     | DFT-s-OFDM BPSK | 1@0 | see graph | ---     |
| 30      | 15        | 10              | 462000 | 2310.0     | DFT-s-OFDM BPSK | 1@0 | see graph | PASS    |
| 30      | 15        | 10              | 462000 | 2310.0     | DFT-s-OFDM BPSK | 1@0 | see graph | PASS    |
| 30      | 15        | 10              | 462000 | 2310.0     | DFT-s-OFDM QPSK | 1@0 | see graph | ---     |
| 30      | 15        | 10              | 462000 | 2310.0     | DFT-s-OFDM QPSK | 1@0 | see graph | PASS    |
| 30      | 15        | 10              | 462000 | 2310.0     | DFT-s-OFDM QPSK | 1@0 | see graph | PASS    |

### N30(5M)\_DFT-s-OFDM\_BPSK\_Edge\_1RB\_Left\_Low\_CH

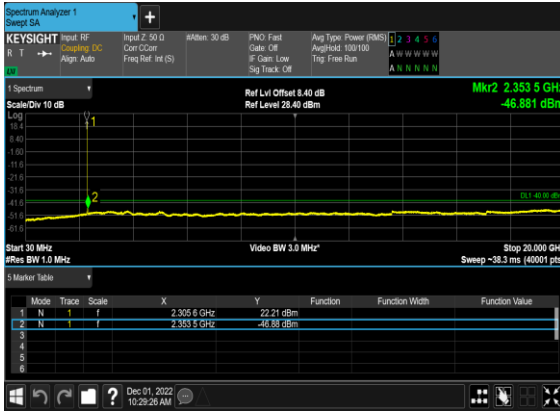

### N30(5M)\_DFT-s-OFDM\_BPSK\_Edge\_1RB\_Left\_Low\_CH

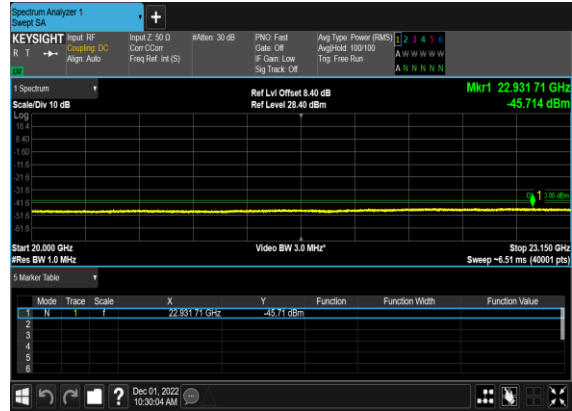

### N30(5M)\_DFT-s-OFDM\_QPSK\_Edge\_1RB\_Left\_Low\_CH



### N30(5M)\_DFT-s-OFDM\_QPSK\_Edge\_1RB\_Left\_Low\_CH

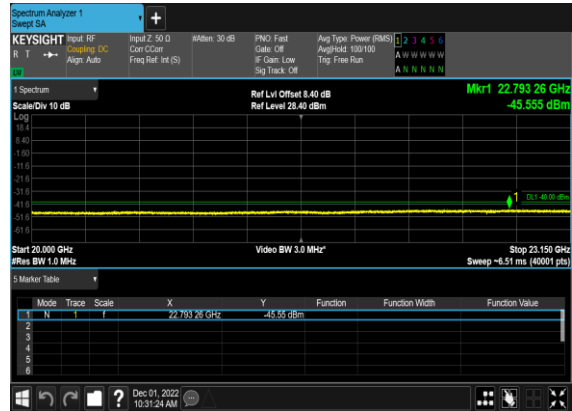

### N30(5M)\_DFT-s-OFDM\_BPSK\_Edge\_1RB\_Left\_Mid\_CH

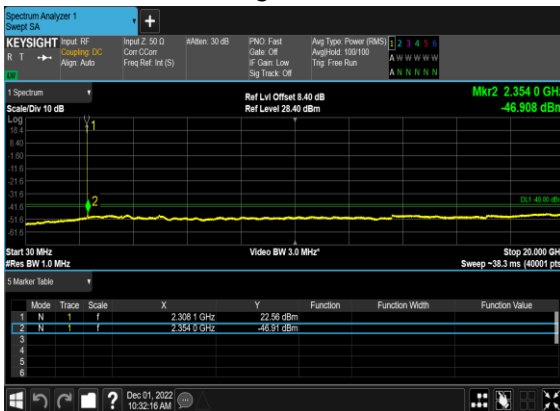

### N30(5M)\_DFT-s-OFDM\_BPSK\_Edge\_1RB\_Left\_Mid\_CH

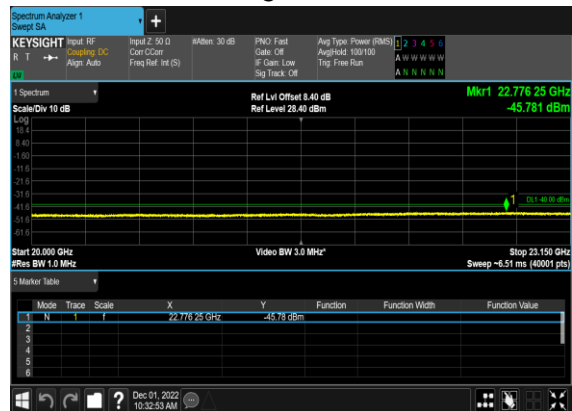

### N30(5M)\_DFT-s-OFDM\_QPSK\_Edge\_1RB\_Left\_Mid\_CH

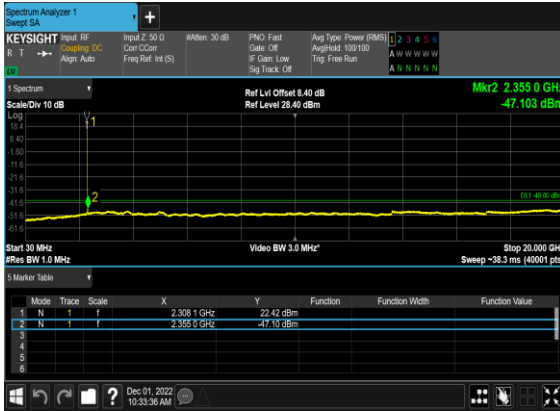

### N30(5M)\_DFT-s-OFDM\_QPSK\_Edge\_1RB\_Left\_Mid\_CH

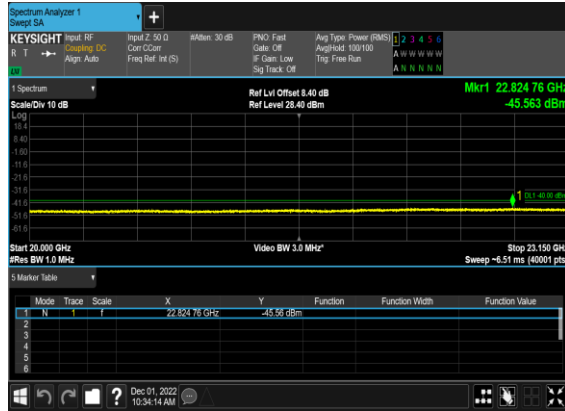

### N30(5M)\_DFT-s-OFDM\_BPSK\_Edge\_1RB\_Left\_High\_CH



### N30(5M)\_DFT-s-OFDM\_BPSK\_Edge\_1RB\_Left\_High\_CH

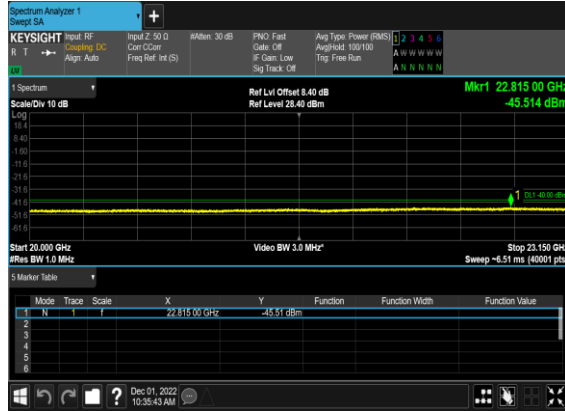

### N30(5M)\_DFT-s-OFDM\_QPSK\_Edge\_1RB\_Left\_High\_CH



### N30(5M)\_DFT-s-OFDM\_QPSK\_Edge\_1RB\_Left\_High\_CH

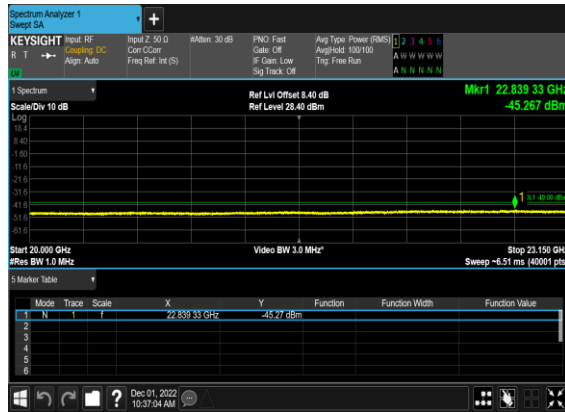

### N30(10M)\_DFT-s-OFDM\_BPSK\_Edge\_1RB\_Left\_Low\_CH

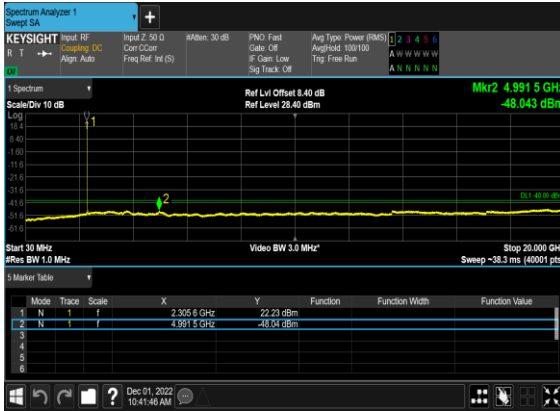

### N30(10M)\_DFT-s-OFDM\_BPSK\_Edge\_1RB\_Left\_Low\_CH

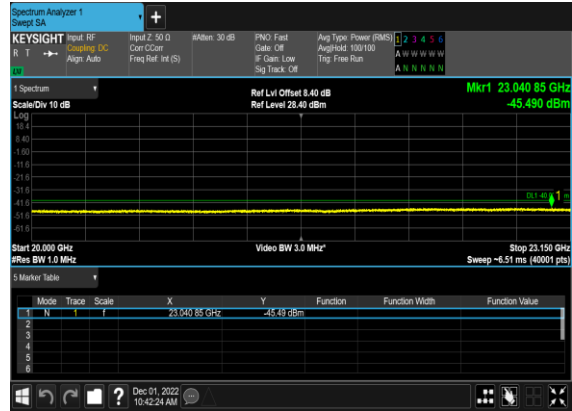

### N30(10M)\_DFT-s-OFDM\_QPSK\_Edge\_1RB\_Left\_Low\_CH

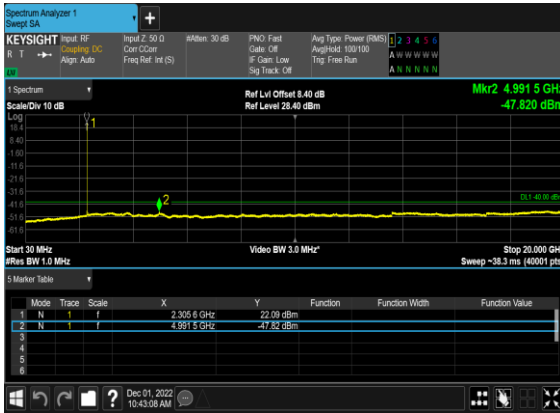

### N30(10M)\_DFT-s-OFDM\_QPSK\_Edge\_1RB\_Left\_Low\_CH

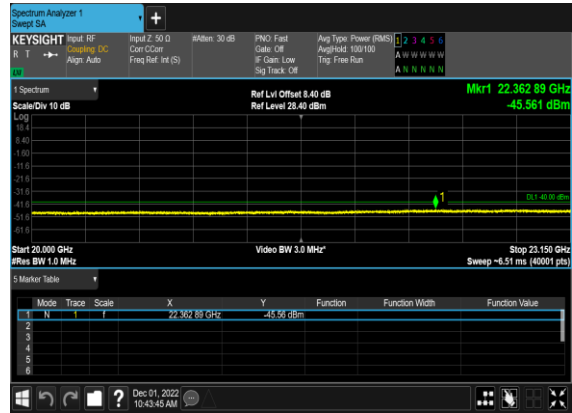

## Conducted Band Edge

| NR Band | SCS (kHz) | Bandwidth (MHz) | Arfcn  | Freq (MHz) | Modulation      | RB   | Result    | Verdict |
|---------|-----------|-----------------|--------|------------|-----------------|------|-----------|---------|
| 30      | 15        | 5               | 461500 | 2307.5     | DFT-s-OFDM BPSK | 1@0  | see graph | PASS    |
| 30      | 15        | 5               | 461500 | 2307.5     | DFT-s-OFDM QPSK | 1@0  | see graph | PASS    |
| 30      | 15        | 5               | 461500 | 2307.5     | DFT-s-OFDM BPSK | 25@0 | see graph | PASS    |
| 30      | 15        | 5               | 461500 | 2307.5     | DFT-s-OFDM QPSK | 25@0 | see graph | PASS    |
| 30      | 15        | 5               | 462500 | 2312.5     | DFT-s-OFDM BPSK | 1@24 | see graph | PASS    |
| 30      | 15        | 5               | 462500 | 2312.5     | DFT-s-OFDM QPSK | 1@24 | see graph | PASS    |
| 30      | 15        | 5               | 462500 | 2312.5     | DFT-s-OFDM BPSK | 25@0 | see graph | PASS    |
| 30      | 15        | 5               | 462500 | 2312.5     | DFT-s-OFDM QPSK | 25@0 | see graph | PASS    |
| 30      | 15        | 10              | 462000 | 2310.0     | DFT-s-OFDM BPSK | 1@0  | see graph | PASS    |
| 30      | 15        | 10              | 462000 | 2310.0     | DFT-s-OFDM QPSK | 1@0  | see graph | PASS    |
| 30      | 15        | 10              | 462000 | 2310.0     | DFT-s-OFDM BPSK | 1@51 | see graph | PASS    |
| 30      | 15        | 10              | 462000 | 2310.0     | DFT-s-OFDM QPSK | 1@51 | see graph | PASS    |
| 30      | 15        | 10              | 462000 | 2310.0     | DFT-s-OFDM BPSK | 50@0 | see graph | PASS    |
| 30      | 15        | 10              | 462000 | 2310.0     | DFT-s-OFDM QPSK | 50@0 | see graph | PASS    |

### N30(5M)\_DFT-s-OFDM\_BPSK\_Edge\_1RB\_Left\_Low\_CH

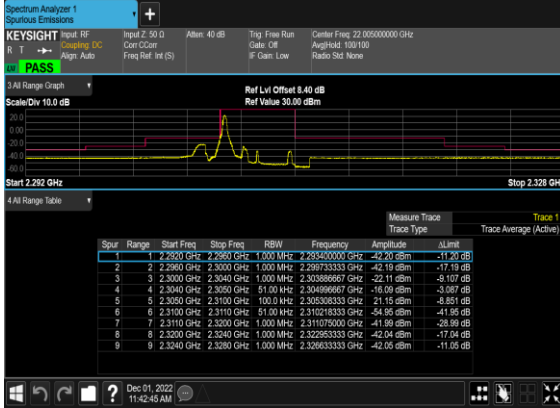

### N30(5M)\_DFT-s-OFDM\_QPSK\_Edge\_1RB\_Left\_Low\_CH

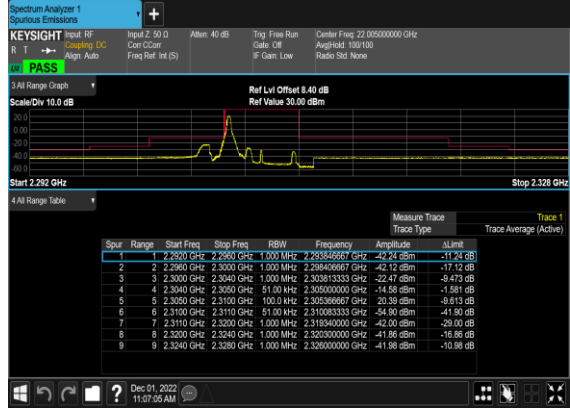

### N30(5M)\_DFT-s-OFDM\_BPSK\_Outer\_Full\_Low\_CH

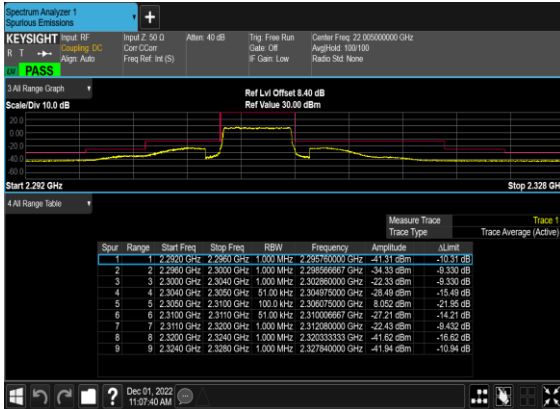

### N30(5M)\_DFT-s-OFDM\_QPSK\_Outer\_Full\_Low\_CH

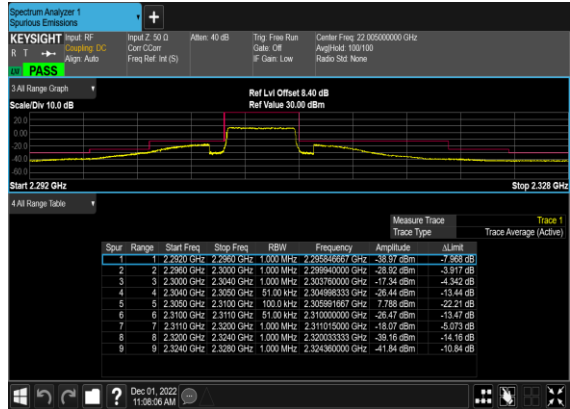

### N30(5M)\_DFT-s-OFDM\_BPSK\_Edge\_1RB\_Right\_High\_CH

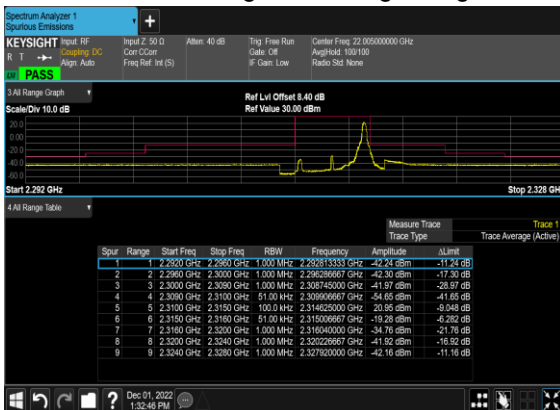

### N30(5M)\_DFT-s-OFDM\_QPSK\_Edge\_1RB\_Right\_High\_CH

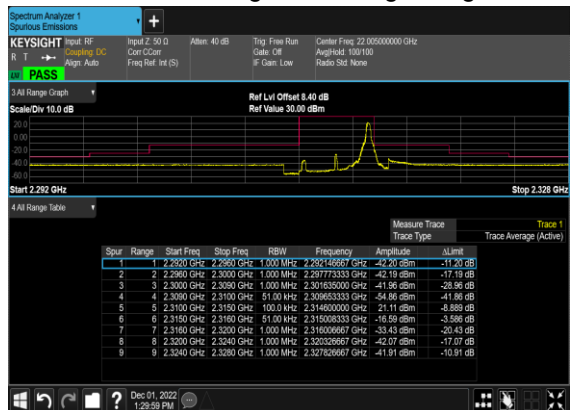

### N30(5M)\_DFT-s-OFDM\_BPSK\_Outer\_Full\_High\_CH

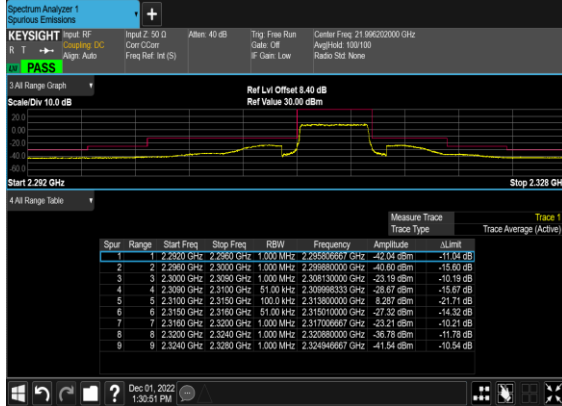

### N30(5M)\_DFT-s-OFDM\_QPSK\_Outer\_Full\_High\_CH

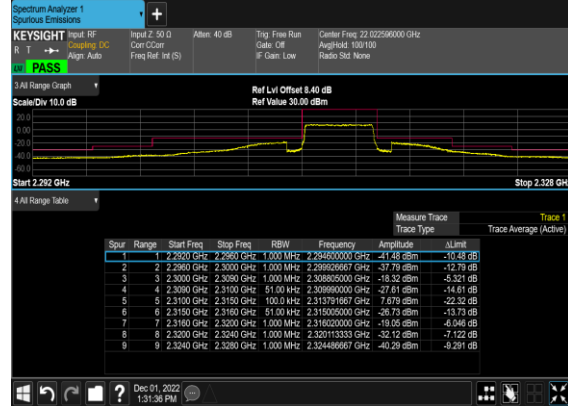

### N30(10M)\_DFT-s-OFDM\_BPSK\_Edge\_1RB\_Left\_Low\_CH

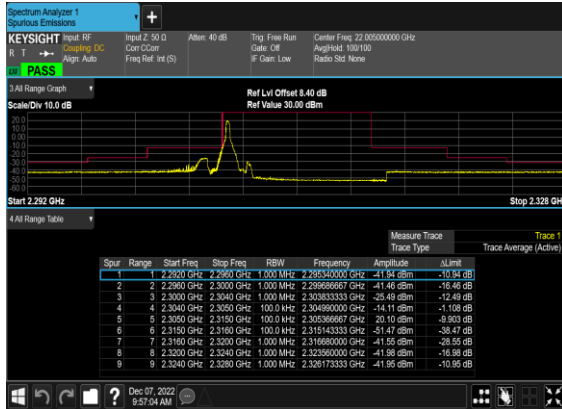

### N30(10M)\_DFT-s-OFDM\_QPSK\_Edge\_1RB\_Left\_Low\_CH

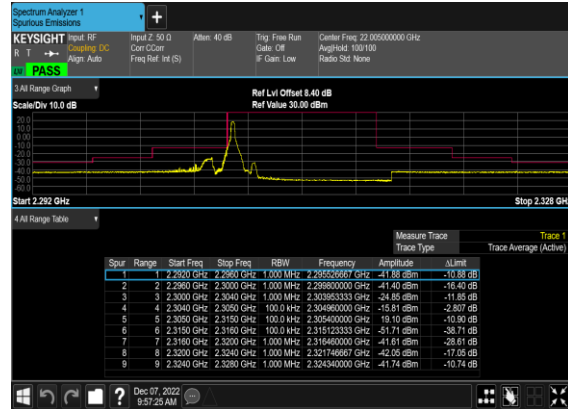

### N30(10M)\_DFT-s-OFDM\_BPSK\_Edge\_1RB\_Right\_Low\_CH

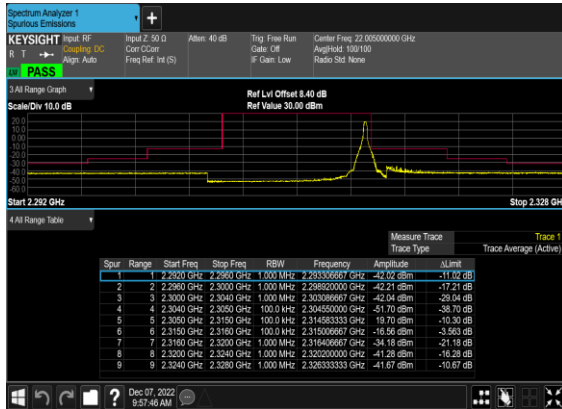

### N30(10M)\_DFT-s-OFDM\_QPSK\_Edge\_1RB\_Right\_Low\_CH

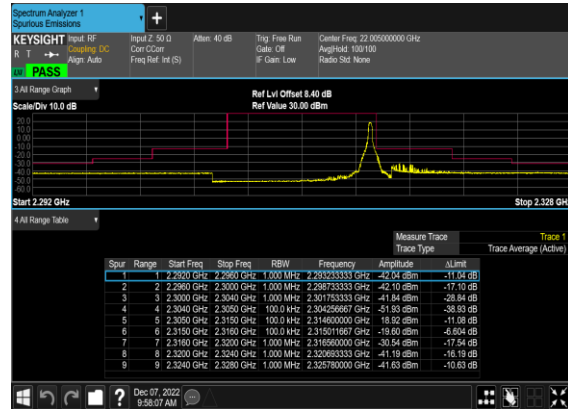

### N30(10M)\_DFT-s- OFDM\_BPSK\_Outer\_Full\_Low\_CH

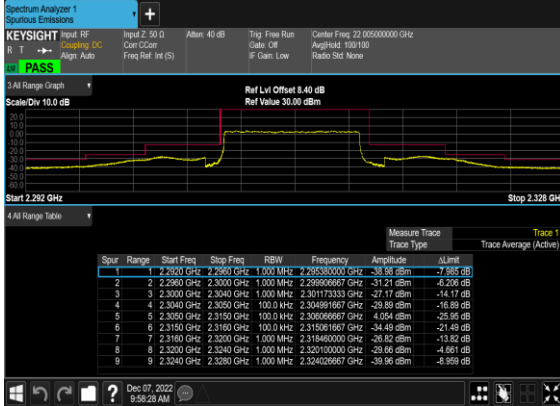

### N30(10M)\_DFT-s- OFDM\_QPSK\_Outer\_Full\_Low\_CH

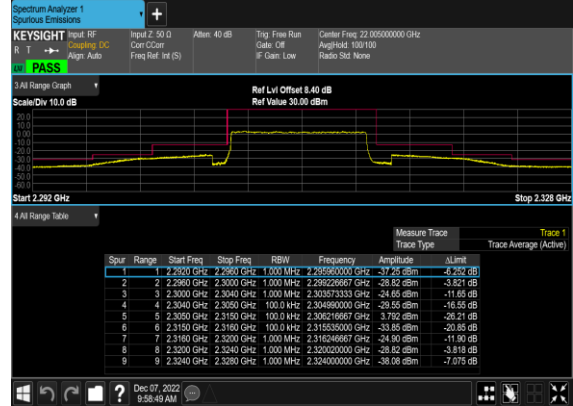



# FR1 N30 other PA (ANT4)

LTE Band: 2(ANT0), LTE BW: 10M, LTE ARFCN: Mid

## Transmitter Conducted Output Power And EIRP, ( $G_T - L_C$ )=-1.6dB

| NR Band | SCS (kHz) | Bandwidth (MHz) | Arfcn  | Freq (MHz) | Modulation           | RB    | Conducted Power(dBm) | EIRP (dBm) | EIRP (W) |
|---------|-----------|-----------------|--------|------------|----------------------|-------|----------------------|------------|----------|
| 30      | 15        | 5               | 461500 | 2307.5     | DFT-s-OFDM QPSK      | 1@1   | 22.75                | 21.15      | 0.1303   |
| 30      | 15        | 5               | 461500 | 2307.5     | DFT-s-OFDM 16 QAM    | 1@1   | 21.95                | 20.35      | 0.1084   |
| 30      | 15        | 5               | 462000 | 2310.0     | DFT-s-OFDM QPSK      | 1@1   | 22.8                 | 21.2       | 0.1318   |
| 30      | 15        | 5               | 462000 | 2310.0     | DFT-s-OFDM 16 QAM    | 1@1   | 22.18                | 20.58      | 0.1143   |
| 30      | 15        | 5               | 462500 | 2312.5     | DFT-s-OFDM QPSK      | 1@1   | 22.93                | 21.33      | 0.1358   |
| 30      | 15        | 5               | 462500 | 2312.5     | DFT-s-OFDM 16 QAM    | 1@1   | 22.45                | 20.85      | 0.1216   |
| 30      | 15        | 10              | 462000 | 2310       | DFT-s-OFDM PI/2 BPSK | 25@12 | 22.88                | 21.28      | 0.1343   |
| 30      | 15        | 10              | 462000 | 2310       | DFT-s-OFDM PI/2 BPSK | 1@1   | 22.94                | 21.34      | 0.1361   |
| 30      | 15        | 10              | 462000 | 2310       | DFT-s-OFDM PI/2 BPSK | 1@50  | 22.74                | 21.14      | 0.1300   |
| 30      | 15        | 10              | 462000 | 2310       | DFT-s-OFDM QPSK      | 25@12 | 22.73                | 21.13      | 0.1297   |
| 30      | 15        | 10              | 462000 | 2310       | DFT-s-OFDM QPSK      | 1@1   | 22.32                | 20.72      | 0.1180   |
| 30      | 15        | 10              | 462000 | 2310       | DFT-s-OFDM QPSK      | 1@50  | 22.12                | 20.52      | 0.1127   |
| 30      | 15        | 10              | 462000 | 2310       | DFT-s-OFDM 16 QAM    | 25@12 | 21.94                | 20.34      | 0.1081   |
| 30      | 15        | 10              | 462000 | 2310       | DFT-s-OFDM 16 QAM    | 1@1   | 21.32                | 19.72      | 0.0938   |
| 30      | 15        | 10              | 462000 | 2310       | DFT-s-OFDM 16 QAM    | 1@50  | 21.38                | 19.78      | 0.0951   |
| 30      | 15        | 10              | 462000 | 2310       | DFT-s-OFDM 64 QAM    | 25@12 | 20.65                | 19.05      | 0.0804   |
| 30      | 15        | 10              | 462000 | 2310       | DFT-s-OFDM 64 QAM    | 1@1   | 20.44                | 18.84      | 0.0766   |
| 30      | 15        | 10              | 462000 | 2310       | DFT-s-OFDM 64 QAM    | 1@50  | 20.49                | 18.89      | 0.0774   |
| 30      | 15        | 10              | 462000 | 2310       | DFT-s-OFDM 256 QAM   | 25@12 | 19.2                 | 17.6       | 0.0575   |
| 30      | 15        | 10              | 462000 | 2310       | DFT-s-OFDM 256 QAM   | 1@1   | 18.75                | 17.15      | 0.0519   |
| 30      | 15        | 10              | 462000 | 2310       | DFT-s-OFDM 256 QAM   | 1@50  | 18.54                | 16.94      | 0.0494   |
| 30      | 15        | 10              | 462000 | 2310       | CP-OFDM QPSK         | 26@13 | 21.4                 | 19.8       | 0.0955   |
| 30      | 15        | 10              | 462000 | 2310       | CP-OFDM QPSK         | 1@1   | 21.17                | 19.57      | 0.0906   |
| 30      | 15        | 10              | 462000 | 2310       | CP-OFDM QPSK         | 1@50  | 21.1                 | 19.5       | 0.0891   |

## Frequency Stability

| NR Band | SCS (kHz) | Bandwidth (MHz) | Arfcn  | Freq (MHz) | Modulation      | RB   | Deviation (ppm) | Verdict | Environment |
|---------|-----------|-----------------|--------|------------|-----------------|------|-----------------|---------|-------------|
| 30      | 15        | 5               | 462000 | 2310.0     | DFT-s-OFDM QPSK | 25@0 | 0.0066          | PASS    | NV          |
| 30      | 15        | 5               | 462000 | 2310.0     | DFT-s-OFDM QPSK | 25@0 | 0.0028          | PASS    | LV          |
| 30      | 15        | 5               | 462000 | 2310.0     | DFT-s-OFDM QPSK | 25@0 | 0.0021          | PASS    | HV          |
| 30      | 15        | 5               | 462000 | 2310.0     | DFT-s-OFDM QPSK | 25@0 | 0.0021          | PASS    | -30°C       |
| 30      | 15        | 5               | 462000 | 2310.0     | DFT-s-OFDM QPSK | 25@0 | 0.0067          | PASS    | -20°C       |
| 30      | 15        | 5               | 462000 | 2310.0     | DFT-s-OFDM QPSK | 25@0 | 0.0047          | PASS    | -10°C       |
| 30      | 15        | 5               | 462000 | 2310.0     | DFT-s-OFDM QPSK | 25@0 | 0.0023          | PASS    | 0°C         |
| 30      | 15        | 5               | 462000 | 2310.0     | DFT-s-OFDM QPSK | 25@0 | 0.0047          | PASS    | 10°C        |
| 30      | 15        | 5               | 462000 | 2310.0     | DFT-s-OFDM QPSK | 25@0 | 0.0066          | PASS    | 20°C        |
| 30      | 15        | 5               | 462000 | 2310.0     | DFT-s-OFDM QPSK | 25@0 | 0.0044          | PASS    | 30°C        |
| 30      | 15        | 5               | 462000 | 2310.0     | DFT-s-OFDM QPSK | 25@0 | 0.0041          | PASS    | 40°C        |
| 30      | 15        | 5               | 462000 | 2310.0     | DFT-s-OFDM QPSK | 25@0 | 0.0050          | PASS    | 50°C        |

## Peak to Average Ratio

| NR Band | SCS (kHz) | Bandwidth (MHz) | Arfcn  | Freq (MHz) | Modulation              | RB   | Result (dB) | Limit (dB) | Verdict |
|---------|-----------|-----------------|--------|------------|-------------------------|------|-------------|------------|---------|
| 30      | 15        | 5               | 461500 | 2307.5     | DFT-s-OFDM<br>PI/2 BPSK | 25@0 | 4.1         | 13         | PASS    |
| 30      | 15        | 5               | 461500 | 2307.5     | DFT-s-OFDM<br>PI/2 BPSK | 1@0  | 3.33        | 13         | PASS    |
| 30      | 15        | 5               | 461500 | 2307.5     | DFT-s-OFDM<br>QPSK      | 25@0 | 5.26        | 13         | PASS    |
| 30      | 15        | 5               | 461500 | 2307.5     | DFT-s-OFDM<br>QPSK      | 1@0  | 4.74        | 13         | PASS    |
| 30      | 15        | 5               | 462000 | 2310.0     | DFT-s-OFDM<br>PI/2 BPSK | 25@0 | 3.85        | 13         | PASS    |
| 30      | 15        | 5               | 462000 | 2310.0     | DFT-s-OFDM<br>PI/2 BPSK | 1@0  | 3.31        | 13         | PASS    |
| 30      | 15        | 5               | 462000 | 2310.0     | DFT-s-OFDM<br>QPSK      | 25@0 | 5.11        | 13         | PASS    |
| 30      | 15        | 5               | 462000 | 2310.0     | DFT-s-OFDM<br>QPSK      | 1@0  | 5.06        | 13         | PASS    |
| 30      | 15        | 5               | 462500 | 2312.5     | DFT-s-OFDM<br>PI/2 BPSK | 25@0 | 3.99        | 13         | PASS    |
| 30      | 15        | 5               | 462500 | 2312.5     | DFT-s-OFDM<br>PI/2 BPSK | 1@0  | 3.3         | 13         | PASS    |
| 30      | 15        | 5               | 462500 | 2312.5     | DFT-s-OFDM<br>QPSK      | 25@0 | 5.19        | 13         | PASS    |
| 30      | 15        | 5               | 462500 | 2312.5     | DFT-s-OFDM<br>QPSK      | 1@0  | 5.02        | 13         | PASS    |

B2\_N30(5M)\_DFT-s-OFDM\_PI\_2-BPSK\_Outer\_Full\_Low\_CH



B2\_N30(5M)\_DFT-s-OFDM\_PI\_2-BPSK\_Edge\_1RB\_Left\_Low\_CH



B2\_N30(5M)\_DFT-s-OFDM\_QPSK\_Outer\_Full\_Low\_CH

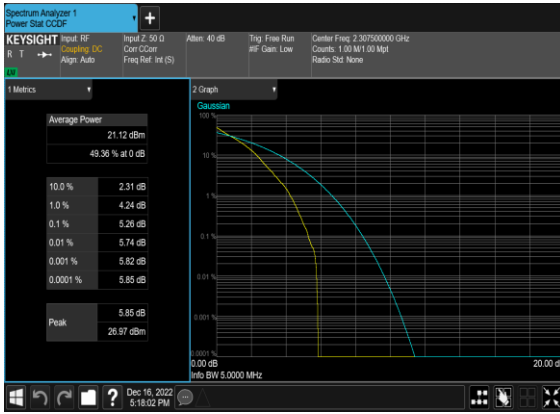

B2\_N30(5M)\_DFT-s-OFDM\_QPSK\_Edge\_1RB\_Left\_Low\_CH

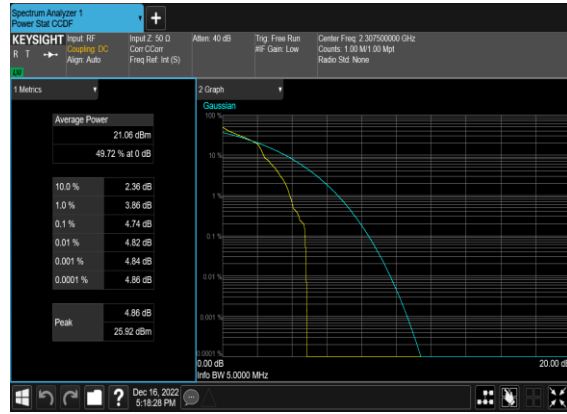

B2\_N30(5M)\_DFT-s-OFDM\_PI\_2-BPSK\_Outer\_Full\_Mid\_CH

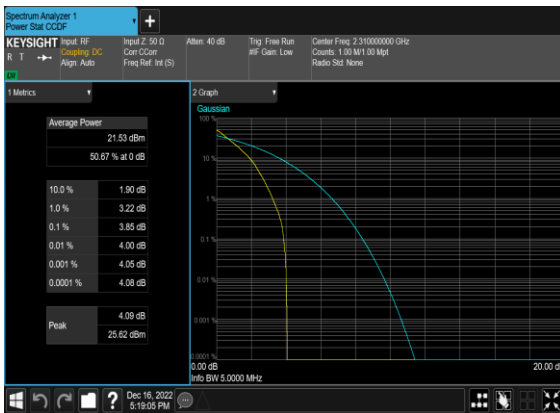

B2\_N30(5M)\_DFT-s-OFDM\_PI\_2-BPSK\_Edge\_1RB\_Left\_Mid\_CH



B2\_N30(5M)\_DFT-s-OFDM\_QPSK\_Outer\_Full\_Mid\_CH



B2\_N30(5M)\_DFT-s-OFDM\_QPSK\_Edge\_1RB\_Left\_Mid\_CH



B2\_N30(5M)\_DFT-s-OFDM\_PI\_2-BPSK\_Outer\_Full\_High\_CH



B2\_N30(5M)\_DFT-s-OFDM\_PI\_2-BPSK\_Edge\_1RB\_Left\_High\_CH



B2\_N30(5M)\_DFT-s-OFDM\_QPSK\_Outer\_Full\_High\_CH



B2\_N30(5M)\_DFT-s-OFDM\_QPSK\_Edge\_1RB\_Left\_High\_CH



## Occupied Bandwidth

| NR Band | SCS (kHz) | Bandwidth (MHz) | Arfcn  | Freq (MHz) | Modulation              | RB   | OBW (MHz) | 26dB BW (MHz) |
|---------|-----------|-----------------|--------|------------|-------------------------|------|-----------|---------------|
| 30      | 15        | 5               | 462000 | 2310.0     | DFT-s-OFDM<br>PI/2 BPSK | 25@0 | 4.4691    | 4.835         |
| 30      | 15        | 5               | 462000 | 2310.0     | DFT-s-OFDM<br>QPSK      | 25@0 | 4.4671    | 4.794         |
| 30      | 15        | 5               | 462000 | 2310.0     | CP-OFDM<br>QPSK         | 25@0 | 4.4763    | 4.916         |
| 30      | 15        | 5               | 462000 | 2310.0     | CP-OFDM 16<br>QAM       | 25@0 | 4.4834    | 4.951         |
| 30      | 15        | 5               | 462000 | 2310.0     | CP-OFDM 64<br>QAM       | 25@0 | 4.4792    | 4.93          |
| 30      | 15        | 5               | 462000 | 2310.0     | CP-OFDM 256<br>QAM      | 25@0 | 4.4735    | 4.997         |
| 30      | 15        | 10              | 462000 | 2310.0     | DFT-s-OFDM<br>PI/2 BPSK | 50@0 | 8.8926    | 9.418         |
| 30      | 15        | 10              | 462000 | 2310.0     | DFT-s-OFDM<br>QPSK      | 50@0 | 8.913     | 9.439         |
| 30      | 15        | 10              | 462000 | 2310.0     | CP-OFDM<br>QPSK         | 52@0 | 9.2891    | 9.9           |
| 30      | 15        | 10              | 462000 | 2310.0     | CP-OFDM 16<br>QAM       | 52@0 | 9.2869    | 9.834         |
| 30      | 15        | 10              | 462000 | 2310.0     | CP-OFDM 64<br>QAM       | 52@0 | 9.2866    | 9.867         |
| 30      | 15        | 10              | 462000 | 2310.0     | CP-OFDM 256<br>QAM      | 52@0 | 9.3048    | 9.867         |

### B2\_N30(5M)\_DFT-s-OFDM\_PI\_2- BPSK\_Outer\_Full\_Mid\_CH

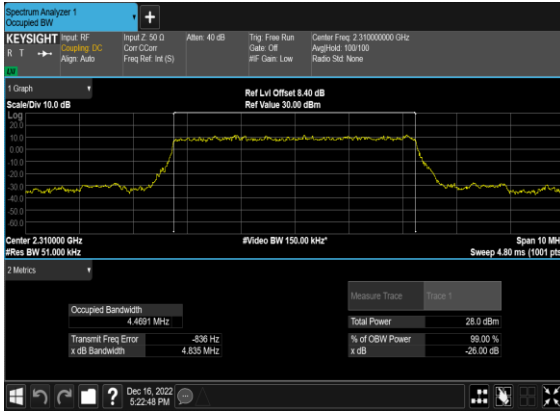

### B2\_N30(5M)\_DFT-s- OFDM\_QPSK\_Outer\_Full\_Mid\_CH

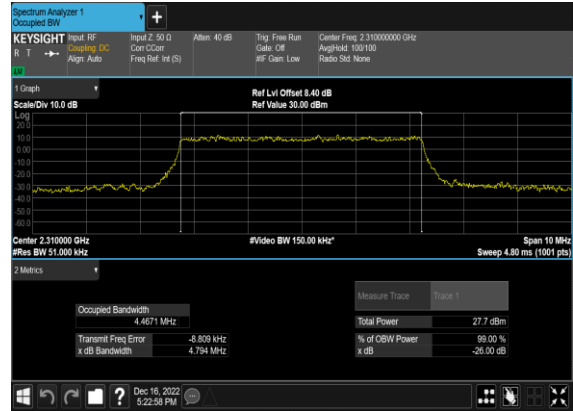

### B2\_N30(5M)\_CP- OFDM\_QPSK\_Outer\_Full\_Mid\_CH



### B2\_N30(5M)\_CP-OFDM\_16 QAM\_Outer\_Full\_Mid\_CH

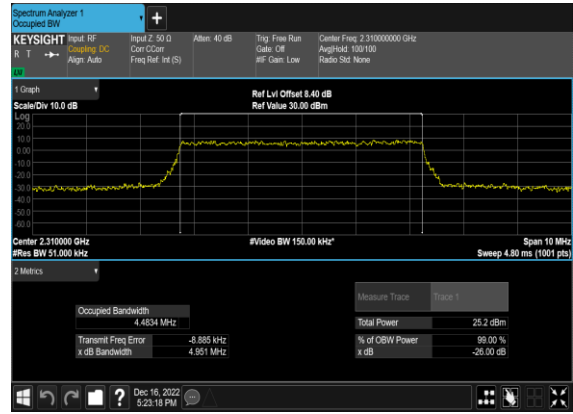

### B2\_N30(5M)\_CP-OFDM\_64 QAM\_Outer\_Full\_Mid\_CH

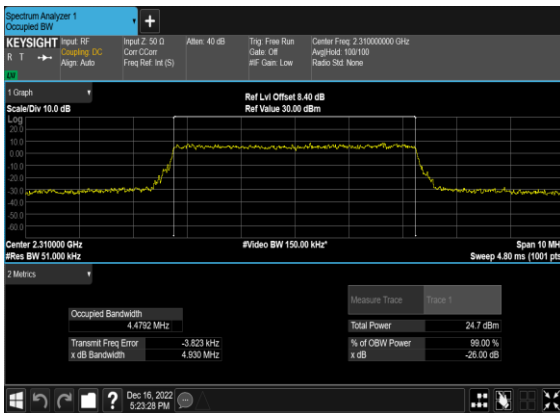

### B2\_N30(5M)\_CP-OFDM\_256 QAM\_Outer\_Full\_Mid\_CH

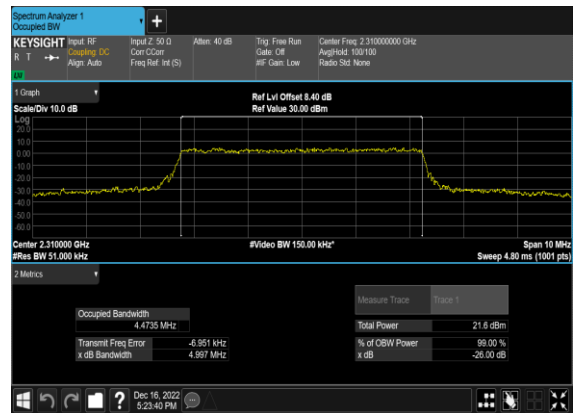

B2\_N30(10M)\_DFT-s-OFDM\_PI\_2-  
BPSK\_Outer\_Full\_Low\_CH

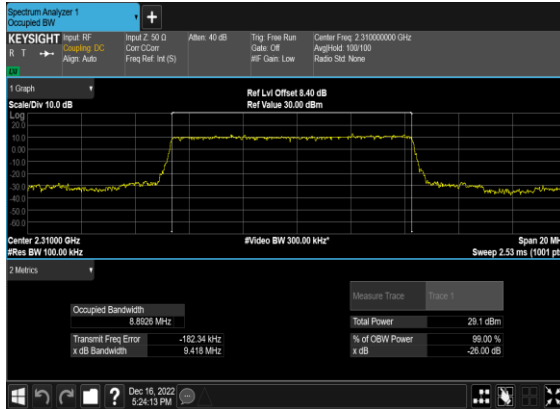

B2\_N30(10M)\_DFT-s-  
OFDM\_QPSK\_Outer\_Full\_Low\_CH

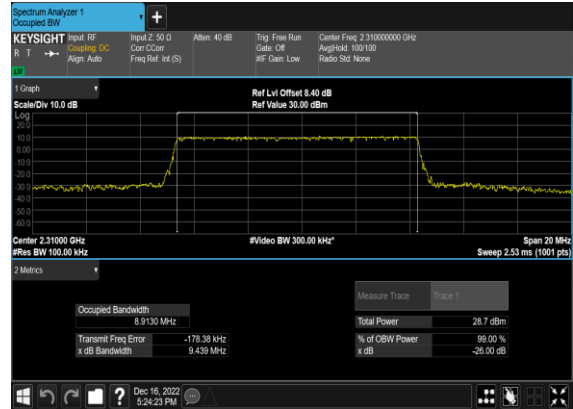

B2\_N30(10M)\_CP-  
OFDM\_QPSK\_Outer\_Full\_Low\_CH

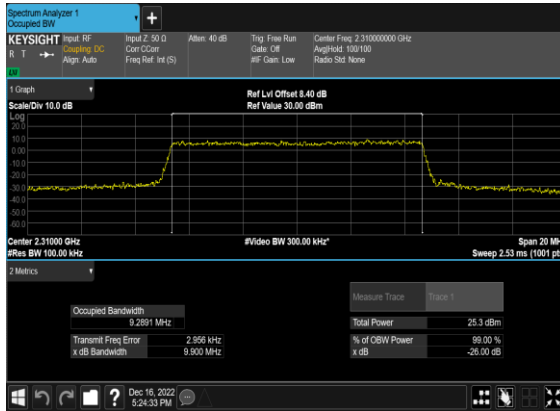

B2\_N30(10M)\_CP-OFDM\_16  
QAM\_Outer\_Full\_Low\_CH



B2\_N30(10M)\_CP-OFDM\_64  
QAM\_Outer\_Full\_Low\_CH

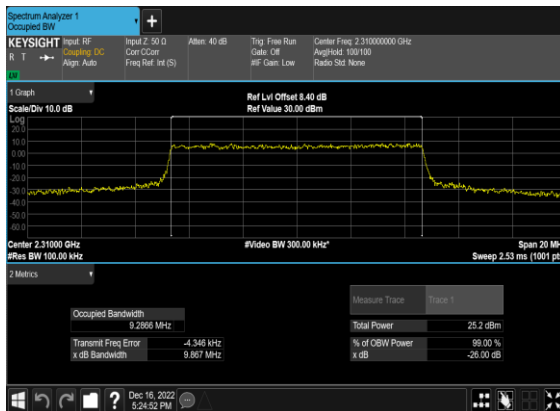

B2\_N30(10M)\_CP-OFDM\_256  
QAM\_Outer\_Full\_Low\_CH

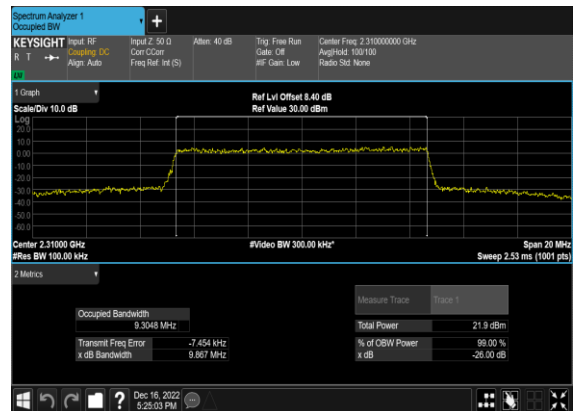



## Conducted Spurious Emissions

| NR Band | SCS (kHz) | Bandwidth (MHz) | Arfcn  | Freq (MHz) | Modulation      | RB  | Result    | Verdict |
|---------|-----------|-----------------|--------|------------|-----------------|-----|-----------|---------|
| 30      | 15        | 5               | 461500 | 2307.5     | DFT-s-OFDM BPSK | 1@0 | see graph | ---     |
| 30      | 15        | 5               | 461500 | 2307.5     | DFT-s-OFDM BPSK | 1@0 | see graph | PASS    |
| 30      | 15        | 5               | 461500 | 2307.5     | DFT-s-OFDM BPSK | 1@0 | see graph | PASS    |
| 30      | 15        | 5               | 461500 | 2307.5     | DFT-s-OFDM QPSK | 1@0 | see graph | ---     |
| 30      | 15        | 5               | 461500 | 2307.5     | DFT-s-OFDM QPSK | 1@0 | see graph | PASS    |
| 30      | 15        | 5               | 461500 | 2307.5     | DFT-s-OFDM QPSK | 1@0 | see graph | PASS    |
| 30      | 15        | 5               | 462000 | 2310.0     | DFT-s-OFDM BPSK | 1@0 | see graph | ---     |
| 30      | 15        | 5               | 462000 | 2310.0     | DFT-s-OFDM BPSK | 1@0 | see graph | PASS    |
| 30      | 15        | 5               | 462000 | 2310.0     | DFT-s-OFDM BPSK | 1@0 | see graph | PASS    |
| 30      | 15        | 5               | 462000 | 2310.0     | DFT-s-OFDM QPSK | 1@0 | see graph | ---     |
| 30      | 15        | 5               | 462000 | 2310.0     | DFT-s-OFDM QPSK | 1@0 | see graph | PASS    |
| 30      | 15        | 5               | 462000 | 2310.0     | DFT-s-OFDM QPSK | 1@0 | see graph | PASS    |
| 30      | 15        | 5               | 462500 | 2312.5     | DFT-s-OFDM BPSK | 1@0 | see graph | ---     |
| 30      | 15        | 5               | 462500 | 2312.5     | DFT-s-OFDM BPSK | 1@0 | see graph | PASS    |
| 30      | 15        | 5               | 462500 | 2312.5     | DFT-s-OFDM BPSK | 1@0 | see graph | PASS    |
| 30      | 15        | 5               | 462500 | 2312.5     | DFT-s-OFDM QPSK | 1@0 | see graph | ---     |
| 30      | 15        | 5               | 462500 | 2312.5     | DFT-s-OFDM QPSK | 1@0 | see graph | PASS    |
| 30      | 15        | 5               | 462500 | 2312.5     | DFT-s-OFDM QPSK | 1@0 | see graph | PASS    |
| 30      | 15        | 10              | 462000 | 2310.0     | DFT-s-OFDM BPSK | 1@0 | see graph | ---     |
| 30      | 15        | 10              | 462000 | 2310.0     | DFT-s-OFDM BPSK | 1@0 | see graph | PASS    |
| 30      | 15        | 10              | 462000 | 2310.0     | DFT-s-OFDM BPSK | 1@0 | see graph | PASS    |
| 30      | 15        | 10              | 462000 | 2310.0     | DFT-s-OFDM QPSK | 1@0 | see graph | ---     |
| 30      | 15        | 10              | 462000 | 2310.0     | DFT-s-OFDM QPSK | 1@0 | see graph | PASS    |
| 30      | 15        | 10              | 462000 | 2310.0     | DFT-s-OFDM QPSK | 1@0 | see graph | PASS    |

### B2\_N30(5M)\_DFT-s-OFDM\_BPSK\_Edge\_1RB\_Left\_Low\_CH

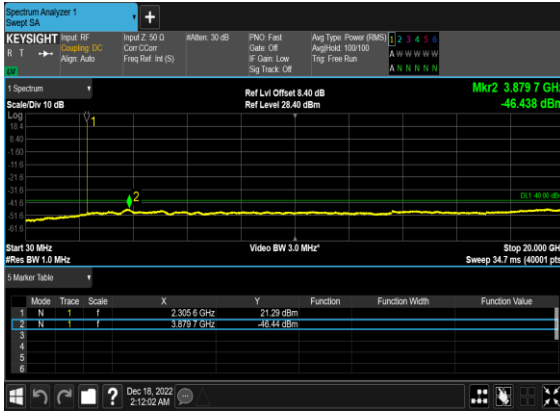

### B2\_N30(5M)\_DFT-s-OFDM\_BPSK\_Edge\_1RB\_Left\_Low\_CH

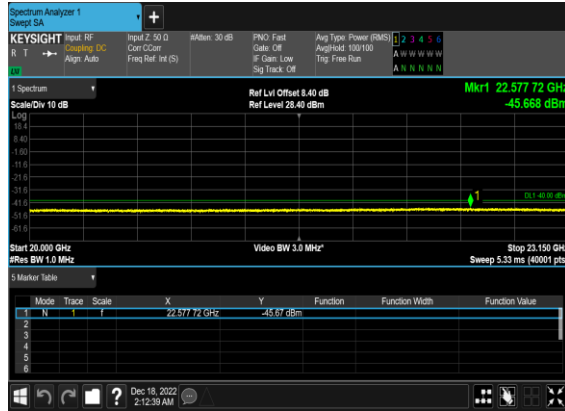

### B2\_N30(5M)\_DFT-s-OFDM\_QPSK\_Edge\_1RB\_Left\_Low\_CH

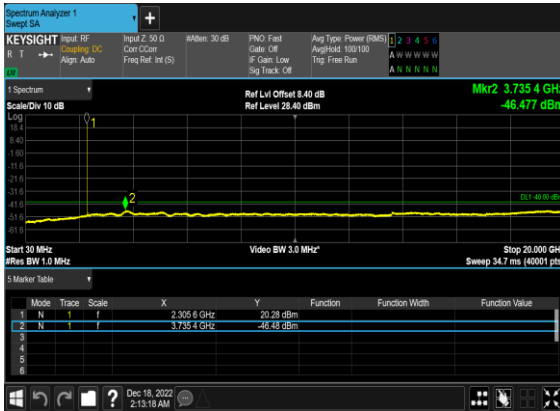

### B2\_N30(5M)\_DFT-s-OFDM\_QPSK\_Edge\_1RB\_Left\_Low\_CH

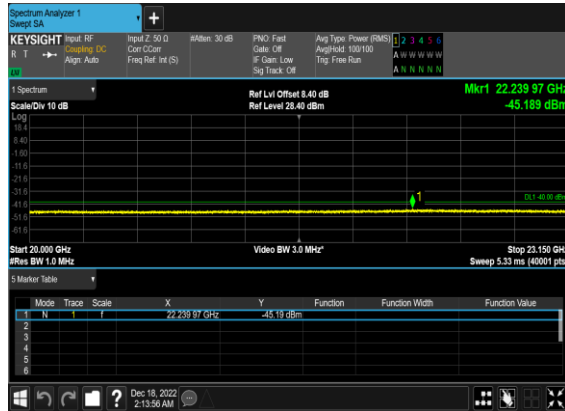

### B2\_N30(5M)\_DFT-s-OFDM\_BPSK\_Edge\_1RB\_Left\_Mid\_CH

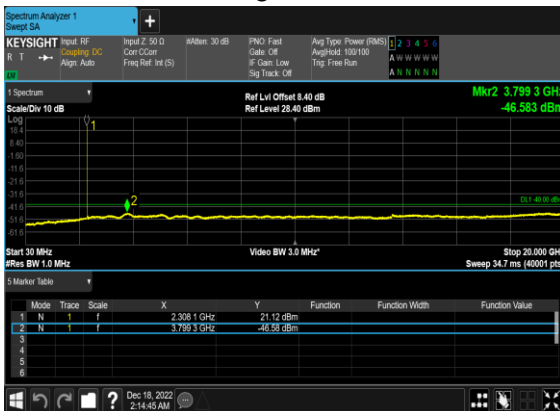

### B2\_N30(5M)\_DFT-s-OFDM\_BPSK\_Edge\_1RB\_Left\_Mid\_CH

