



FCC RF Test Report

APPLICANT : Motorola Mobility LLC
EQUIPMENT : Mobile Cellular Phone
BRAND NAME : Motorola
MODEL NAME : XT2335-2
FCC ID : IHDT56AJ7
STANDARD : 47 CFR Part 2, Part 27 Subpart Q
CLASSIFICATION : PCS Licensed Transmitter Held to Ear (PCE)
TEST DATE(S) : Oct. 24, 2022 ~ Nov. 01, 2022

We, Sporton International Inc. (Kunshan), would like to declare that the tested sample has been evaluated in accordance with the procedures given in ANSI C63.26-2015 and shown compliance with the applicable technical standards.

This report contains data that were produced under subcontract by Sporton International Inc. (Shenzhen)

The test results in this report apply exclusively to the tested model / sample. Without written approval of Sporton International Inc. (Kunshan), the test report shall not be reproduced except in full.

Jason Jia



Approved by: Jason Jia

Sporton International Inc. (Kunshan)

**No. 1098, Pengxi North Road, Kunshan Economic Development Zone Jiangsu Province 215300
People's Republic of China**



TABLE OF CONTENTS

REVISION HISTORY..... 3
SUMMARY OF TEST RESULT 4
1 GENERAL DESCRIPTION 5
1.1 Applicant..... 5
1.2 Manufacturer..... 5
1.3 Product Feature of Equipment Under Test..... 5
1.4 Product Specification of Equipment Under Test..... 5
1.5 Modification of EUT 5
1.6 Specification of Accessory..... 6
1.7 Maximum EIRP Power and Emission Designator 6
1.8 Testing Site..... 7
1.9 Test Software..... 7
1.10 Applied Standards 8
2 TEST CONFIGURATION OF EQUIPMENT UNDER TEST 9
2.1 Test Mode..... 9
2.2 Connection Diagram of Test System..... 10
2.3 Support Unit used in test configuration and system..... 10
2.4 Measurement Results Explanation Example..... 10
2.5 Frequency List of Low/Middle/High Channels..... 11
3 CONDUCTED TEST ITEMS 12
3.1 Measuring Instruments 12
3.2 Test Setup 12
3.3 Test Result of Conducted Test 12
3.4 Conducted Output Power Measurement 13
3.5 Peak-to-Average Ratio 14
3.6 EIRP 15
3.7 Occupied Bandwidth..... 16
3.8 Conducted Band Edge Measurement 17
3.9 Conducted Spurious Emission Measurement 18
3.10 Frequency Stability Measurement..... 19
4 RADIATED TEST ITEMS 20
4.1 Measuring Instruments 20
4.2 Test Setup 20
4.3 Test Result of Radiated Test 21
4.4 Radiated Spurious Emission Measurement 22
5 LIST OF MEASURING EQUIPMENT 23
6 UNCERTAINTY OF EVALUATION 24
APPENDIX A. TEST RESULTS OF CONDUCTED TEST
APPENDIX B. TEST RESULTS OF RADIATED TEST
APPENDIX C. TEST SETUP PHOTOGRAPHS



REVISION HISTORY

REPORT NO.	VERSION	DESCRIPTION	ISSUED DATE
FG292106-01B	Rev. 01	Initial issue of report	Nov. 18, 2022



SUMMARY OF TEST RESULT

Report Section	FCC Rule	Description	Limit	Result	Remark
3.4	§2.1046	Conducted Output Power	—	Report Only	-
3.5	§27.50 (k)(4)	Peak-to-Average Ratio	<13dB	PASS	
3.6	§27.50 (k)(3)	EIRP	EIRP < 1W (30dBm)	PASS	-
3.7	§2.1049	Occupied Bandwidth	—	Report Only	-
3.8	§2.1051 §27.53 (n)(2)	Conducted Band Edge Measurement	-13dBm/MHz	PASS	-
3.9	§2.1051 §27.53 (n)(2)	Conducted Spurious Emission	-13dBm/MHz	PASS	-
3.10	§2.1055 §27.54	Frequency Stability Temperature & Voltage	Within the band	PASS	-
4.4	§2.1053 §27.53 (n)(2)	Radiated Spurious Emission	-13dBm/MHz	PASS	Under limit 37.16 dB at 13924.40 MHz

Declaration of Conformity:

The test results with all measurement uncertainty excluded are presented in accordance with the regulation limits or requirements declared by manufacturers.

Comments and Explanations:

The declared of product specification for EUT presented in the report are provided by the manufacturer, and the manufacturer takes all the responsibilities for the accuracy of product specification.

1 General Description

1.1 Applicant

Motorola Mobility LLC
222 W,Merchandise Mart Plaza, Chicago IL 60654 USA

1.2 Manufacturer

Motorola Mobility LLC
222 W,Merchandise Mart Plaza, Chicago IL 60654 USA

1.3 Product Feature of Equipment Under Test

Product Feature	
Equipment	Mobile Cellular Phone
Brand Name	Motorola
Model Name	XT2335-2
FCC ID	IHDT56AJ7
IMEI Code	Conducted: 351401230012275/351401230012283 Radiation: 351401230013018/351401230013026
HW Version	DVT2
SW Version	TTP33.24
EUT Stage	Identical Prototype

1.4 Product Specification of Equipment Under Test

Product Feature	
Tx/Rx Frequency	LTE Band 42: 3450 MHz ~ 3550 MHz
Bandwidth	5MHz / 10MHz / 15MHz / 20MHz
Maximum Output Power to Antenna	LTE Band 42C : 23.56 dBm
Antenna Gain	LTE Band 42C : -4.2 dBi
Type of Modulation	QPSK / 16QAM / 64QAM / 256QAM

1.5 Modification of EUT

No modifications are made to the EUT during all test items.

1.6 Specification of Accessory

Specification of Accessory				
AC Adapter 1(US)	Brand Name	Motorola(AOHAI)	Model Name	MC-101
AC Adapter 1(EU)	Brand Name	Motorola(AOHAI)	Model Name	MC-102
AC Adapter 1(UK)	Brand Name	Motorola(AOHAI)	Model Name	MC-103
AC Adapter 1(AU)	Brand Name	Motorola(AOHAI)	Model Name	MC-105
AC Adapter 2(US)	Brand Name	Motorola(Chenyang)	Model Name	MC-101
AC Adapter 2(EU)	Brand Name	Motorola(Chenyang)	Model Name	MC-102
AC Adapter 2(UK)	Brand Name	Motorola(Chenyang)	Model Name	MC-103
AC Adapter 2(AU)	Brand Name	Motorola(Chenyang)	Model Name	MC-105
AC Adapter 3(US)	Brand Name	Motorola(Salcomp)	Model Name	MC-101
AC Adapter 3(EU)	Brand Name	Motorola(Salcomp)	Model Name	MC-102
AC Adapter 3(UK)	Brand Name	Motorola(Salcomp)	Model Name	MC-103
AC Adapter 3(AU)	Brand Name	Motorola(Salcomp)	Model Name	MC-105
AC Adapter 4(US)	Brand Name	Motorola(Salcomp)	Model Name	MC-201L
AC Adapter 4(EU)	Brand Name	Motorola(Salcomp)	Model Name	MC-202L
AC Adapter 4(AR)	Brand Name	Motorola(Salcomp)	Model Name	MC-206L
AC Adapter 4(BR)	Brand Name	Motorola(Salcomp)	Model Name	MC-207L
AC Adapter 4(CHILE)	Brand Name	Motorola(Salcomp)	Model Name	MC-209L
AC Adapter 5(US)	Brand Name	Motorola(AOHAI)	Model Name	MC-201L
AC Adapter 5(EU)	Brand Name	Motorola(AOHAI)	Model Name	MC-202L
AC Adapter 5(AR)	Brand Name	Motorola(AOHAI)	Model Name	MC-206L
AC Adapter 6(BR)	Brand Name	Motorola(Chenyang)	Model Name	MC-207
Battery 1	Brand Name	Motorola(ATL)	Model Name	NH50
Battery 2	Brand Name	Motorola(SUNWODA)	Model Name	NH50
Earphone 1	Brand Name	Motorola(New Leader)	Model Name	MH202
Earphone 2	Brand Name	Motorola(Lyand)	Model Name	MH202
USB Cable 1	Brand Name	Motorola(kawakami)	Model Name	S928D67706
USB Cable 2	Brand Name	Motorola(Beauford)	Model Name	S928D70140

1.7 Maximum EIRP Power and Emission Designator

LTE Band 42C	QPSK		16QAM/64QAM/256QAM	
	Maximum EIRP(W)	Emission Designator (99%OBW)	Maximum EIRP(W)	Emission Designator (99%OBW)
20MHz+20MHz	0.0863	37M8G7D	0.0822	37M8W7D

1.8 Testing Site

Sporton International Inc. (Kunshan) is accredited to ISO/IEC 17025:2017 by American Association for Laboratory Accreditation with Certificate Number 5145.02.

Test Firm	Sporton International Inc. (Kunshan)		
Test Site Location	No. 1098, Pengxi North Road, Kunshan Economic Development Zone Jiangsu Province 215300 People's Republic of China TEL : +86-512-57900158 FAX : +86-512-57900958		
Test Site No.	Sporton Site No.	FCC Designation No.	FCC Test Firm Registration No.
	TH01-KS	CN1257	314309

Sporton International Inc. (Shenzhen) is accredited to ISO/IEC 17025:2017 by American Association for Laboratory Accreditation with Certificate Number 5145.01.

Test Firm	Sporton International Inc. (Shenzhen)		
Test Location Site	101, 1st Floor, Block B, Building 1, No. 2, Tengfeng 4th Road, Fenghuang Community, Fuyong Street, Baoan District, Shenzhen City Guangdong Province China 518103 TEL: +86-755-33202398		
Test Site No.	Sporton Site No.	FCC Designation No.	FCC Test Firm Registration No.
	03CH02-SZ	CN1256	421272

1.9 Test Software

Item	Site	Manufacturer	Name	Version
1.	03CH02-SZ	AUDIX	E3	6.2009-8-24a



1.10 Applied Standards

According to the specifications of the manufacturer, the EUT must comply with the requirements of the following standards:

- ♦ 47 CFR Part 2, Part 27 Subpart Q
- ♦ ANSI C63.26-2015
- ♦ FCC KDB 971168 Power Meas License Digital Systems D01 v03r01
- ♦ FCC KDB 412172 D01 Determining ERP and EIRP v01r01
- ♦

Remark:

1. All test items were verified and recorded according to the standards and without any deviation during the test.
2. This EUT has also been tested and complied with the requirements of FCC Part 15, Subpart B, recorded in a separate test report.



2 Test Configuration of Equipment Under Test

2.1 Test Mode

Antenna port conducted and radiated test items listed below are performed according to KDB 971168 D01 Power Meas. License Digital Systems v03r01 with maximum output power.

Radiated measurements are performed by rotating the EUT in three different orthogonal test planes to find the maximum emission.

Test Items	Band	Bandwidth (MHz)										Modulation			RB #			Test Channel						
		20+20	20+15	15+20	20+10	10+20	20+5	5+20	15+15	15+10	10+15	QPSK	16QA M	64QA M	256QA M	1	Half	Full	L	M	H			
Max. Output Power	42C_CA	v	v	v	v	v	v	v	-	-	-	v	v	v	v	v				v	v	v		
26dB and 99% Bandwidth	42C_CA	v							-	-	-	v	v	v	v			v			v			
Conducted Band Edge	42C_CA	v	v	v	v	v	v	v	-	-	-	v	v	v		v		v	v			v		
Conducted Spurious Emission	42C_CA	v	v	v	v	v	v	v	-	-	-	v				v				v	v	v		
E.I.R.P.	42C_CA	v	v	v	v	v	v	v	-	-	-	v	v	v	v	v				v	v	v		
Radiated Spurious Emission	42C_CA	Worst Case																					v	
Note	<ol style="list-style-type: none"> The mark "v" means that this configuration is chosen for testing The mark "-" means that this bandwidth is not supported. The device is investigated from 30MHz to 10 times of fundamental signal for radiated spurious emission test under different RB size/offset and modulations in exploratory test. Subsequently, only the worst case emissions are reported. 																							

2.2 Connection Diagram of Test System

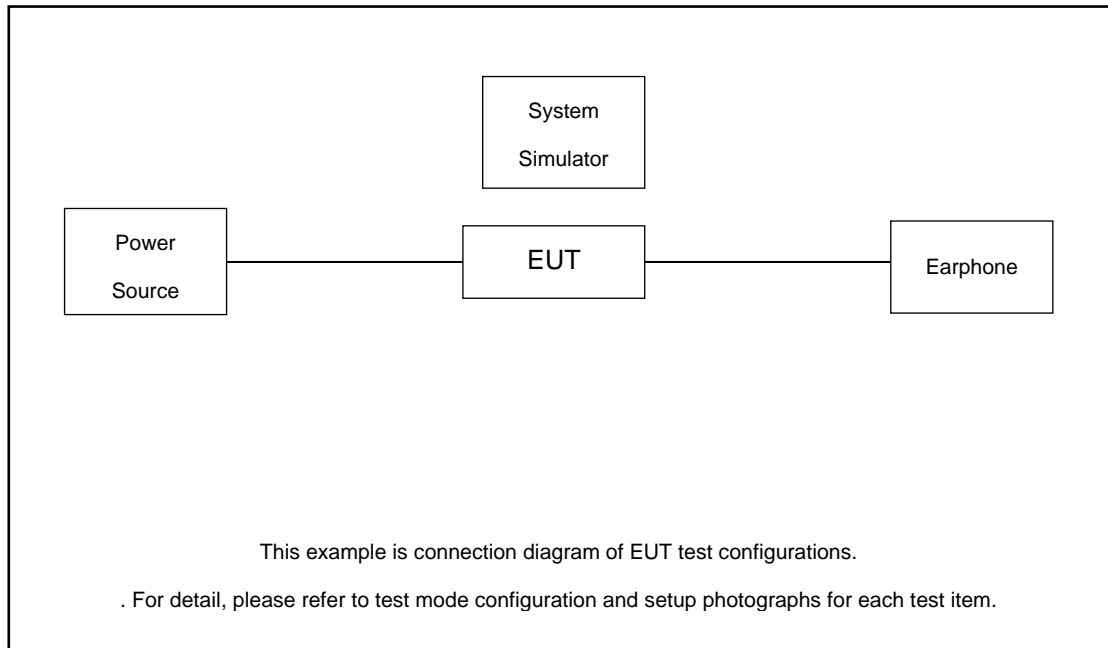

2.3 Support Unit used in test configuration and system

Item	Equipment	Trade Name	Model No.	FCC ID	Data Cable	Power Cord
1.	Power Supply	GWINSTEK	PSS-2002	N/A	N/A	Unshielded, 1.8 m
2.	LTE Base Station	Anritsu	MT8820C	N/A	N/A	Unshielded, 1.8 m

2.4 Measurement Results Explanation Example

For all conducted test items:

The offset level is set in the spectrum analyzer to compensate the RF cable loss between EUT conducted output port and spectrum analyzer. With the offset compensation, the spectrum analyzer reading level is exactly the EUT RF output level.

The spectrum analyzer offset is derived from RF cable loss.

Offset = RF cable loss.

Following shows an offset computation example with cable loss 8.72 dB.

Example :

$$\begin{aligned} \text{Offset(dB)} &= \text{RF cable loss(dB)}. \\ &= 8.72 \text{ (dB)} \end{aligned}$$



2.5 Frequency List of Low/Middle/High Channels

LTE Band 42C_CA Channel and Frequency List					
BW [MHz]	Channel/Frequency(MHz)		Lowest	Middle	Highest
20 + 20	PCC	Channel	41690	42491	43292
		Frequency	3410	3490.1	3570.2
	SCC	Channel	41888	42689	43490
		Frequency	3429.8	3509.9	3590
20 + 15	PCC	Channel	41690	42516	43341
		Frequency	3410	3492.6	3575.1
	SCC	Channel	41861	42687	43512
		Frequency	3427.1	3509.7	3592.2
15 + 20	PCC	Channel	41668	42493	43319
		Frequency	3407.8	3490.3	3572.9
	SCC	Channel	41839	42664	43490
		Frequency	3424.9	3507.4	3590
20 + 10	PCC	Channel	41690	42541	43391
		Frequency	3410	3495.1	3580.1
	SCC	Channel	41834	42685	43535
		Frequency	3424.4	3509.5	3594.5
10 + 20	PCC	Channel	41645	42496	43346
		Frequency	3405.5	3490.6	3575.6
	SCC	Channel	41789	42640	43490
		Frequency	3419.9	3505	3590
20 + 5	PCC	Channel	41690	42565	43440
		Frequency	3410	3497.5	3585
	SCC	Channel	41807	42682	43557
		Frequency	3421.7	3509.2	3596.7
5 + 20	PCC	Channel	41623	42498	43373
		Frequency	3403.3	3490.8	3578.3
	SCC	Channel	41740	42615	43490
		Frequency	3415	3502.5	3590

3 Conducted Test Items

3.1 Measuring Instruments

See list of measuring instruments of this test report.

3.2 Test Setup

3.2.1 Conducted Output Power

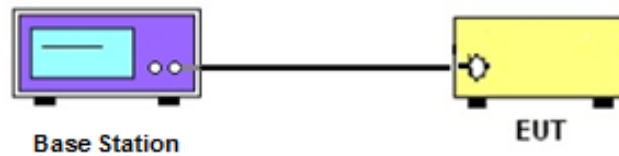

3.2.2 Peak-to-Average Ratio, Occupied / 26dB Bandwidth ,Band-Edge and Conducted Spurious Emission

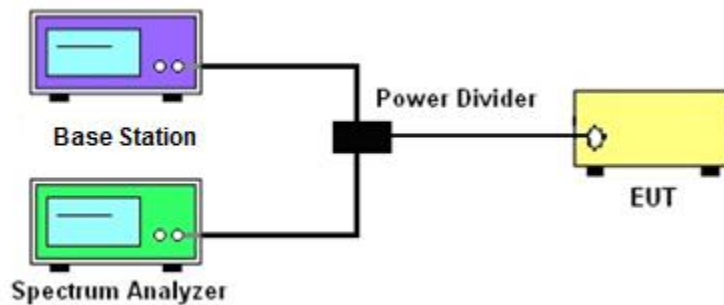

3.2.3 Frequency Stability

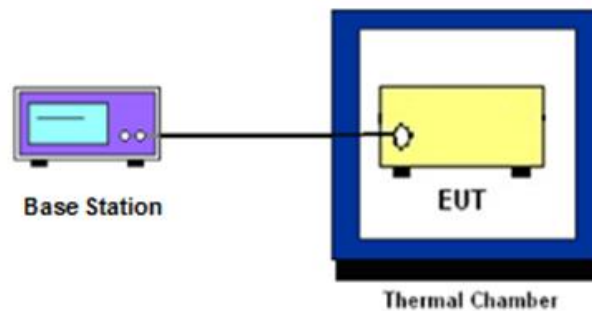

3.3 Test Result of Conducted Test

Please refer to Appendix A.



3.4 Conducted Output Power Measurement

3.4.1 Description of the Conducted Output Power Measurement

A base station simulator was used to establish communication with the EUT. Its parameters were set to transmit the maximum power on the EUT. The measured power in the radio frequency on the transmitter output terminals shall be reported.

3.4.2 Test Procedures

1. The testing follows ANSI C63.26 Section 5.2
2. The transmitter output port was connected to the system simulator.
3. Set EUT at maximum power through the system simulator.
4. Select lowest, middle, and highest channels for each band and different modulation.
5. Measure and record the power level from the system simulator.

3.5 Peak-to-Average Ratio

3.5.1 Description of the PAR Measurement

Power Complementary Cumulative Distribution Function (CCDF) curves provide a means for characterizing the power peaks of a digitally modulated signal on a statistical basis. A CCDF curve depicts the probability of the peak signal amplitude exceeding the average power level. Most contemporary measurement instrumentation include the capability to produce CCDF curves for an input signal provided that the instrument's resolution bandwidth can be set wide enough to accommodate the entire input signal bandwidth. In measuring transmissions in this band using an average power technique, the peak-to-average ratio (PAR) of the transmission may not exceed 13 dB.

3.5.2 Test Procedures

1. The testing follows ANSI C63.26 Section 5.2.3.4 (CCDF).
2. The EUT was connected to spectrum and system simulator via a power divider.
3. Set the CCDF (Complementary Cumulative Distribution Function) option in spectrum analyzer.
4. The highest RF powers were measured and recorded the maximum PAPR level associated with a probability of 0.1 %.
5. Record the deviation as Peak to Average Ratio.

3.6 EIRP

3.6.1 Description of EIRP Limit

§ 27.50 (k)(3)

Mobile devices are limited to 1Watt (30 dBm) EIRP. Mobile devices operating in these bands must employ a means for limiting power to the minimum necessary for successful communications

3.6.2 Test Procedures

1. According to KDB 412172 D01 Power Approach,
2. $EIRP = P_T + G_T - L_C$, $ERP = EIRP - 2.15$, where
 P_T = transmitter output power in dBm
 G_T = gain of the transmitting antenna in dBi
 L_C = signal attenuation in the connecting cable between the transmitter and antenna in dB

3.7 Occupied Bandwidth

3.7.1 Description of Occupied Bandwidth Measurement

The occupied bandwidth is the width of a frequency band such that, below the lower and above the upper frequency limits, the mean powers emitted are each equal to a specified percentage 0.5% of the total mean transmitted power.

The 26 dB emission bandwidth is defined as the frequency range between two points, one above and one below the carrier frequency, at which the spectral density of the emission is attenuated 26 dB below the maximum in-band spectral density of the modulated signal. Spectral density (power per unit bandwidth) is to be measured with a detector of resolution bandwidth equal to approximately 1.0% of the emission bandwidth.

3.7.2 Test Procedures

1. The testing follows ANSI C63.26 Section 5.4
2. The EUT was connected to spectrum analyzer and system simulator via a power divider.
3. The spectrum analyzer center frequency is set to the nominal EUT channel center frequency. The span range for the spectrum analyzer shall be between two and five times the anticipated OBW.
4. The nominal resolution bandwidth (RBW) shall be in the range of 1 to 5 % of the anticipated OBW, and the VBW shall be at least 3 times the RBW.
5. Set the detection mode to peak, and the trace mode to max hold.
6. Determine the reference value: Set the EUT to transmit a modulated signal. Allow the trace to stabilize. Set the spectrum analyzer marker to the highest level of the displayed trace.
(this is the reference value)
7. Determine the “-26 dB down amplitude” as equal to (Reference Value – X).
8. Place two markers, one at the lowest and the other at the highest frequency of the envelope of the spectral display such that each marker is at or slightly below the “-X dB down amplitude” determined in step 6. If a marker is below this “-X dB down amplitude” value it shall be placed as close as possible to this value. The OBW is the positive frequency difference between the two markers.
9. Use the 99 % power bandwidth function of the spectrum analyzer and report the measured bandwidth.

3.8 Conducted Band Edge Measurement

3.8.1 Description of Conducted Band Edge Measurement

§ 27.53 (n)(2)

For mobile operations in the 3450-3550 MHz band, the conducted power of any emission outside the licensee's authorized bandwidth shall not exceed -13 dBm/MHz.

Compliance with this paragraph is based on the use of measurement instrumentation employing a resolution bandwidth of 1 megahertz or greater. However, in the 1 megahertz bands immediately outside and adjacent to the licensee's frequency block, a resolution bandwidth of at least one percent of the emission bandwidth of the fundamental emission of the transmitter may be employed, but limited to a maximum of 200 kHz. In the bands between 1 and 5 MHz removed from the licensee's frequency block, the minimum resolution bandwidth for the measurement shall be 500 kHz.

3.8.2 Test Procedures

1. The testing follows ANSI C63.26 section 5.7
2. The EUT was connected to spectrum analyzer and system simulator via a power divider.
3. The band edges of low and high channels for the highest RF powers were measured.
4. Set RBW \geq 1% EBW but limited to a maximum of 200 kHz in the 1MHz band immediately outside and adjacent to the band edge.
5. Beyond the 1 MHz and 5 MHz removed from the band edge, set RBW \geq 500KHz.
6. Beyond the 5 MHz removed from the band edge, set RBW = 1MHz.
7. Set spectrum analyzer with RMS detector.
8. The RF fundamental frequency should be excluded against the limit line in the operating frequency band.
9. Checked that all the results comply with the emission limit line.

3.9 Conducted Spurious Emission Measurement

3.9.1 Description of Conducted Spurious Emission Measurement

The power of any emission outside of the authorized operating frequency ranges shall not exceed -13 dBm/MHz.

It is measured by means of a calibrated spectrum analyzer and scanned from 9 kHz up to a frequency including its 10th harmonic.

3.9.2 Test Procedures

1. The testing follows ANSI C63.26 section 5.7
2. The EUT was connected to spectrum analyzer and system simulator via a power divider.
3. The RF output of EUT was connected to the spectrum analyzer by RF cable and attenuator.
The path loss was compensated to the results for each measurement.
4. The middle channel for the highest RF power within the transmitting frequency was measured.
5. The conducted spurious emission for the whole frequency range was taken.
6. Make the measurement with the spectrum analyzer's RBW = 1MHz, VBW = 3MHz.
7. Set spectrum analyzer with RMS detector.
8. Taking the record of maximum spurious emission.
9. The RF fundamental frequency should be excluded against the limit line in the operating frequency band.
10. Checked that all the results comply with the emission limit line.

3.10 Frequency Stability Measurement

3.10.1 Description of Frequency Stability Measurement

The frequency stability shall be measured by variation of ambient temperature and variation of primary supply voltage to ensure that the fundamental emission stays within the authorized frequency block.

3.10.2 Test Procedures for Temperature Variation

1. The testing follows ANSI C63.26 section 5.6.4
2. The EUT was set up in the thermal chamber and connected with the system simulator.
3. With power OFF, the temperature was decreased to -30°C and the EUT was stabilized before testing. Power was applied and the maximum change in frequency was recorded within one minute.
4. With power OFF, the temperature was raised in 10°C step up to 50°C . The EUT was stabilized at each step for at least half an hour. Power was applied and the maximum frequency change was recorded within one minute.

3.10.3 Test Procedures for Voltage Variation

1. The testing follows ANSI C63.26 section 5.6.5.
2. The EUT was placed in a temperature chamber at $20\pm 5^{\circ}\text{C}$ and connected with the system simulator.
3. The power supply voltage to the EUT was varied from 85% to 115% of the nominal value for other than hand carried battery equipment.
4. For hand carried, battery powered equipment, reduce the primary ac or dc supply voltage to the battery operating end point, which shall be specified by the manufacturer.
5. The variation in frequency was measured for the worst case.

4 Radiated Test Items

4.1 Measuring Instruments

See list of measuring instruments of this test report.

4.2 Test Setup

4.2.1 For radiated test below 30MHz



4.2.2 For radiated test from 30MHz to 1GHz

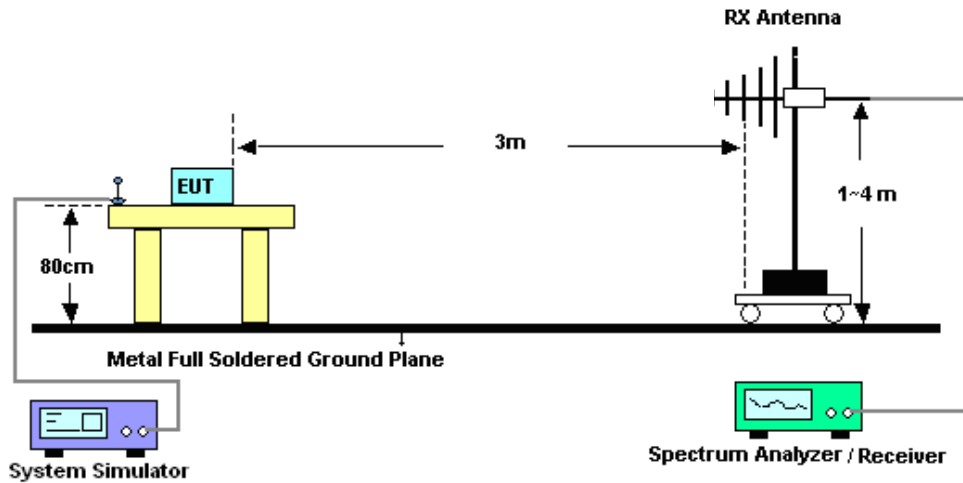

4.2.3 For radiated test above 1GHz



4.3 Test Result of Radiated Test

The low frequency, which started from 9 kHz to 30MHz, was pre-scanned and the result which was 20dB lower than the limit line was not reported.

Please refer to Appendix B.

4.4 Radiated Spurious Emission Measurement

4.4.1 Description of Radiated Spurious Emission

The radiated spurious emission was measured by substitution method according to ANSI C63.26. The power of any emission outside of the authorized operating frequency ranges shall not exceed -13 dBm/MHz.

The spectrum is scanned from 30 MHz up to a frequency including its 10th harmonic.

4.4.2 Test Procedures

1. The testing follows ANSI C63.26 Section 5.5
2. The EUT was placed on a turntable with 0.8 meter height for frequency below 1GHz and 1.5 meter height for frequency above 1GHz respectively above ground.
3. The EUT was set 3 meters from the receiving antenna mounted on the antenna tower.
4. The table was rotated 360 degrees to determine the position of the highest spurious emission.
5. The height of the receiving antenna is varied between 1m to 4m to search the maximum spurious emission for both horizontal and vertical polarizations.
6. During the measurement, the system simulator parameters were set to force the EUT transmitting at maximum output power.
7. Make the measurement with the spectrum analyzer's RBW = 1MHz, VBW = 3MHz, taking the record of maximum spurious emission.
8. A horn antenna was substituted in place of the EUT and was driven by a signal generator.
9. Tune the output power of signal generator to the same emission level with EUT maximum spurious emission.
$$\text{EIRP (dBm)} = \text{S.G. Power} - \text{Tx Cable Loss} + \text{Tx Antenna Gain}$$
$$\text{ERP (dBm)} = \text{EIRP} - 2.15$$
10. The RF fundamental frequency should be excluded against the limit line in the operating frequency band.



5 List of Measuring Equipment

Instrument	Manufacturer	Model No.	Serial No.	Characteristics	Calibration Date	Test Date	Due Date	Remark
Spectrum Analyzer	R&S	FSV40	101040	10Hz~40GHz	Oct. 12, 2022	Oct. 24, 2022~ Oct. 26, 2022	Oct. 11, 2023	Conducted (TH01-KS)
Power divider	STI	STI08-0055	-	0.5~40GHz	Aug. 25, 2022	Oct. 24, 2022~ Oct. 26, 2022	Aug. 24, 2023	Conducted (TH01-KS)
Temperature & humidity chamber	Hongzhan	LP-150U	H2014011440	-40~+150°C 20%~95%RH	Jul. 15, 2022	Oct. 24, 2022~ Oct. 26, 2022	Jul. 14, 2023	Conducted (TH01-KS)
EXA Spectrum Analyzer	KEYSIGHT	N9010A	MY55150213	10Hz~44GHz	Jul. 07, 2022	Nov. 01, 2022	Jul. 06, 2023	Radiation (03CH02-SZ)
Loop Antenna	R&S	HFH2-Z2	100354	9kHz~30MHz	Jul. 28, 2022	Nov. 01, 2022	Jul. 27, 2024	Radiation (03CH02-SZ)
Bilog Antenna	TeseQ	CBL6112D	35407	30MHz~2GHz	Oct. 21, 2022	Nov. 01, 2022	Oct. 20, 2023	Radiation (03CH02-SZ)
Double Ridge Horn Antenna	ETS-Lindgren	3117	00119436	1GHz~18GHz	Jul. 07, 2022	Nov. 01, 2022	Jul. 06, 2023	Radiation (03CH02-SZ)
HF Amplifier	MITEQ	TTA1840-35-HG	1871923	18GHz~40GHz	Jul. 07, 2022	Nov. 01, 2022	Jul. 06, 2023	Radiation (03CH02-SZ)
SHF-EHF Horn	com-power	AH-840	101071	18Ghz~40GHz	Apr. 10, 2022	Nov. 01, 2022	Apr. 09, 2023	Radiation (03CH02-SZ)
LF Amplifier	Burgeon	BPA-530	102211	0.01~3000Mhz	Oct. 21, 2022	Nov. 01, 2022	Oct. 20, 2023	Radiation (03CH02-SZ)
HF Amplifier	KEYSIGHT	83017A	MY53270105	0.5GHz~26.5Ghz	Oct. 21, 2022	Nov. 01, 2022	Oct. 20, 2023	Radiation (03CH02-SZ)
AC Power Source	Chroma	61601	616010002470	N/A	NCR	Nov. 01, 2022	NCR	Radiation (03CH02-SZ)
Turn Table	Chaintek	T-200	N/A	0~360 degree	NCR	Nov. 01, 2022	NCR	Radiation (03CH02-SZ)
Antenna Mast	Chaintek	MBS-400	N/A	1 m~4 m	NCR	Nov. 01, 2022	NCR	Radiation (03CH02-SZ)

NCR: No Calibration Required

6 Uncertainty of Evaluation

The measurement uncertainties shown below were calculated in accordance with the requirements of ANSI 63.26-2015. All the measurement uncertainty value were shown with a coverage K=2 to indicate 95% level of confidence. The measurement data show herein meets or exceeds the CISPR measurement uncertainty values specified in CISPR 16-4-2 and can be compared directly to specified limit to determine compliance.

Uncertainty of Conducted Measurement

Test Item	Uncertainty
Conducted Power	±0.46 dB
Conducted Emissions	±0.48 dB
Occupied Channel Bandwidth	±0.1 %

Uncertainty of Radiated Emission Measurement (30 MHz ~ 1000 MHz)

Measuring Uncertainty for a Level of Confidence of 95% (U = 2Uc(y))	2.47dB
---	--------

Uncertainty of Radiated Emission Measurement (1 GHz ~ 18 GHz)

Measuring Uncertainty for a Level of Confidence of 95% (U = 2Uc(y))	3.31dB
---	--------

Uncertainty of Radiated Emission Measurement (18 GHz ~ 40 GHz)

Measuring Uncertainty for a Level of Confidence of 95% (U = 2Uc(y))	3.72dB
---	--------

----- THE END -----



Appendix A. Test Results of Conducted Test

Conducted Output Power(Average power) and EIRP

Combination 20MHz+20MHz (100RB+100RB)							
Channel	Modulation	PCC		SCC		Measured Power	EIRP(W)
		RB Size	RB offset	RB Size	RB offset		
L	QPSK	1	Max	1	0	23.56	0.0863
M	QPSK	1	Max	1	0	23.19	0.0793
H	QPSK	1	Max	1	0	23.23	0.0800
L	16QAM	1	Max	1	0	23.35	0.0822
M	16QAM	1	Max	1	0	23.32	0.0817
H	16QAM	1	Max	1	0	23.21	0.0796
L	64QAM	1	Max	1	0	21.80	0.0575
M	64QAM	1	Max	1	0	21.56	0.0545
H	64QAM	1	Max	1	0	21.67	0.0558
L	256QAM	1	Max	1	0	19.83	0.0366
M	256QAM	1	Max	1	0	19.59	0.0346
H	256QAM	1	Max	1	0	19.85	0.0367
Combination 20MHz+15MHz (100RB+75RB)							
Channel	Modulation	PCC		SCC		Measured Power	EIRP(W)
		RB Size	RB offset	RB Size	RB offset		
L	QPSK	1	Max	1	0	23.51	0.0853
L	16QAM	1	Max	1	0	23.42	0.0836
Combination 15MHz+20MHz (100RB+75RB)							
Channel	Modulation	PCC		SCC		Measured Power	EIRP(W)
		RB Size	RB offset	RB Size	RB offset		
L	QPSK	1	Max	1	0	23.51	0.0853
L	16QAM	1	Max	1	0	23.50	0.0851
Combination 20MHz+10MHz (100RB+50RB)							
Channel	Modulation	PCC		SCC		Measured Power	EIRP(W)
		RB Size	RB offset	RB Size	RB offset		
L	QPSK	1	Max	1	0	23.52	0.0855
L	16QAM	1	Max	1	0	23.47	0.0845
Combination 10MHz+20MHz (50RB+100RB)							
Channel	Modulation	PCC		SCC		Measured Power	EIRP(W)
		RB Size	RB offset	RB Size	RB offset		
L	QPSK	1	Max	1	0	23.51	0.0853
L	16QAM	1	Max	1	0	23.41	0.0834
Combination 20MHz+5MHz (100RB+25RB)							
Channel	Modulation	PCC		SCC		Measured Power	EIRP(W)
		RB Size	RB offset	RB Size	RB offset		
L	QPSK	1	Max	1	0	23.49	0.0849
L	16QAM	1	Max	1	0	23.42	0.0836
Combination 5MHz+20MHz (25RB+100RB)							
Channel	Modulation	PCC		SCC		Measured Power	EIRP(W)
		RB Size	RB offset	RB Size	RB offset		



L	QPSK	1	Max	1	0	23.20	0.0794
L	16QAM	1	Max	1	0	22.80	0.0724



LTE Band 42C

26dB Bandwidth

Mode	LTE Band 42C : 26dB BW(MHz)			
Mod.	QPSK	16QAM	64QAM	256 QAM
BW	20MHz+20MHz	20MHz+20MHz	20MHz+20MHz	20MHz+20MHz
Middle CH	39.88	39.80	39.96	39.80

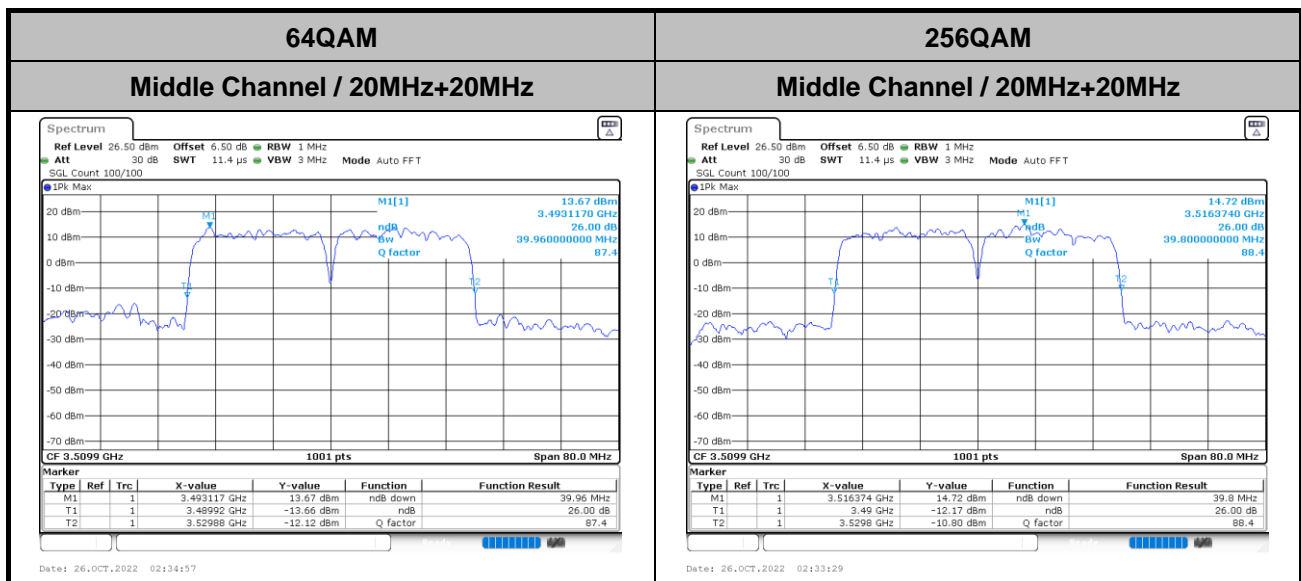
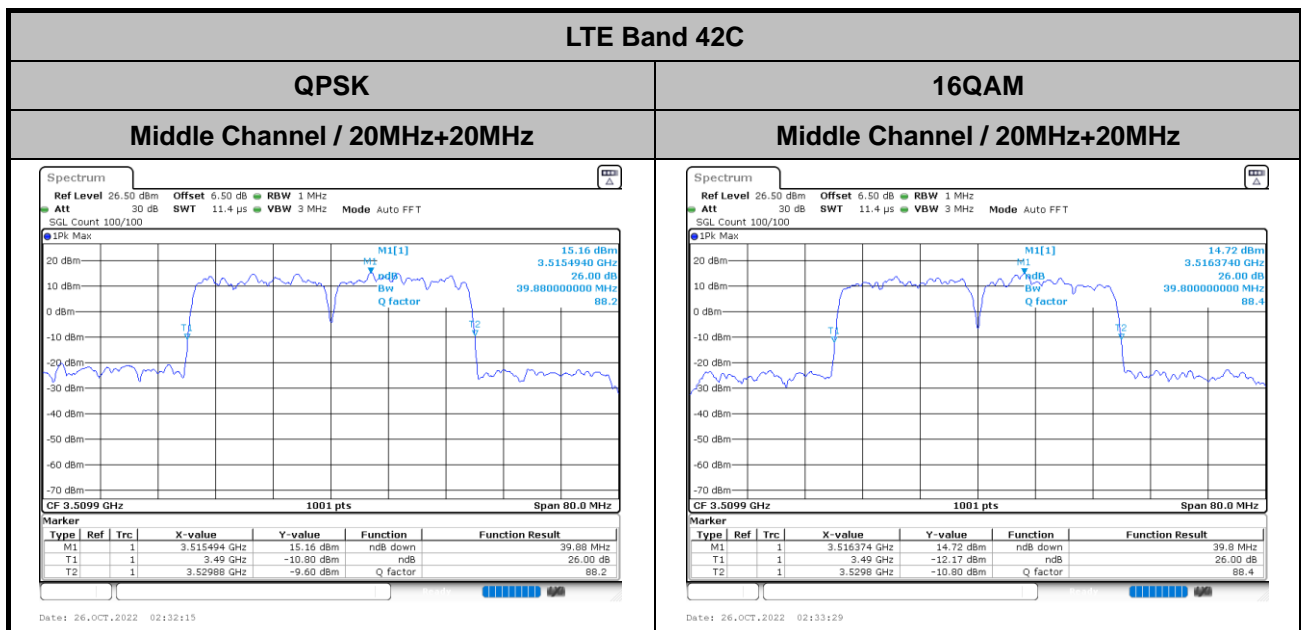



Occupied Bandwidth

Mode	LTE Band 42C : 99%OBW(MHz)			
Mod.	QPSK	16QAM	64QAM	256 QAM
BW	20MHz+20MHz	20MHz+20MHz	20MHz+20MHz	20MHz+20MHz
Middle CH	37.80	37.80	37.72	37.72

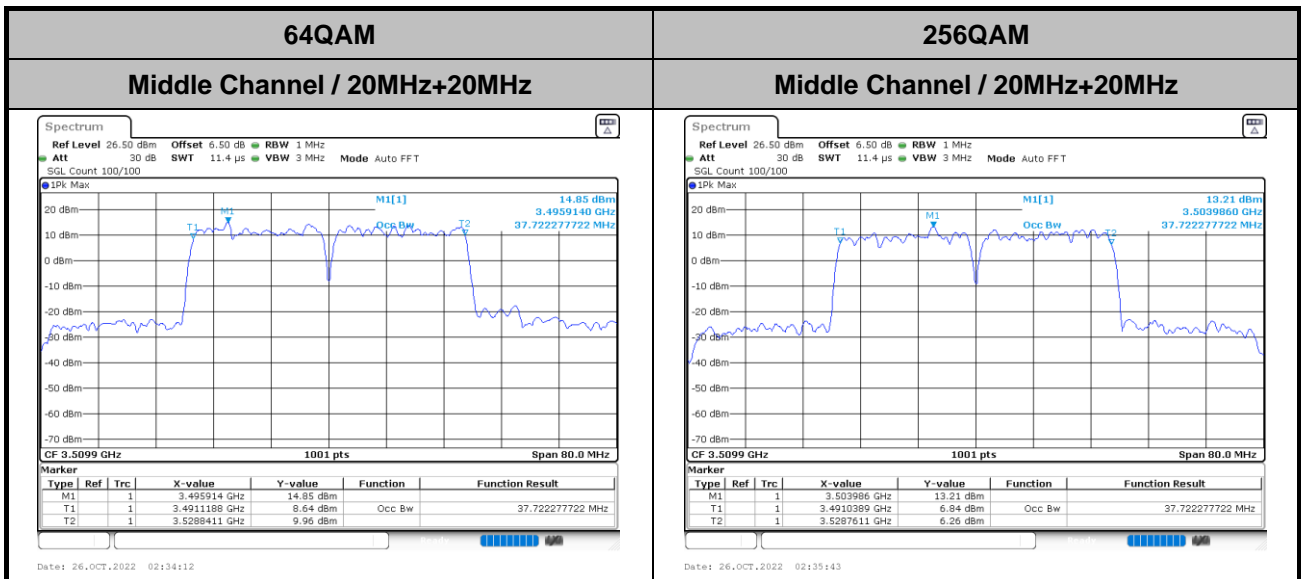
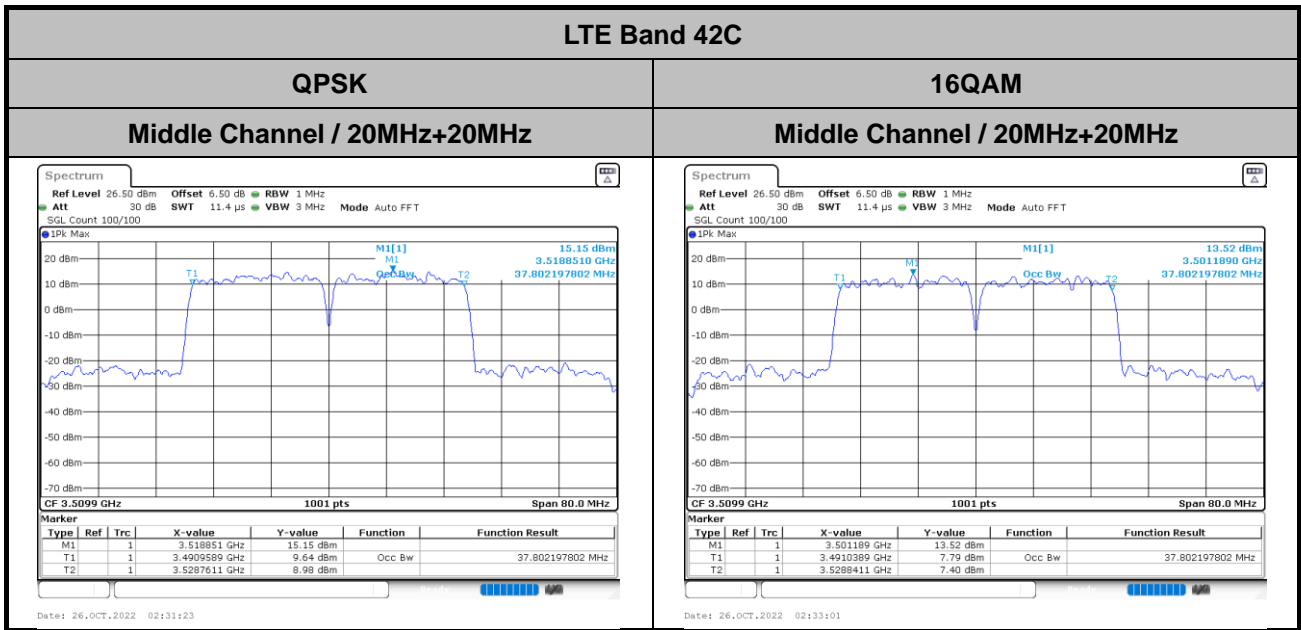



Conducted Band Edge

LTE Band 42C / 5MHz+20MHz

QPSK

Lowest Band Edge / 1RB0 and 1RB99

Highest Band Edge / 1RB0 and 1RB99

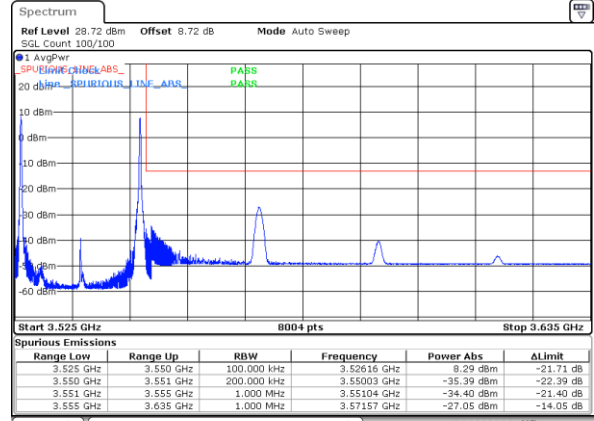
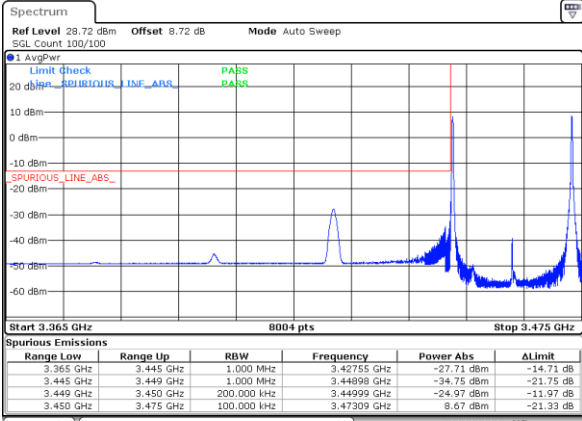

Date: 24.OCT.2022 14:26:16

Date: 24.OCT.2022 14:45:26

Lowest Band Edge / 1RB24 and 1RB0

Highest Band Edge / 1RB24 and 1RB0

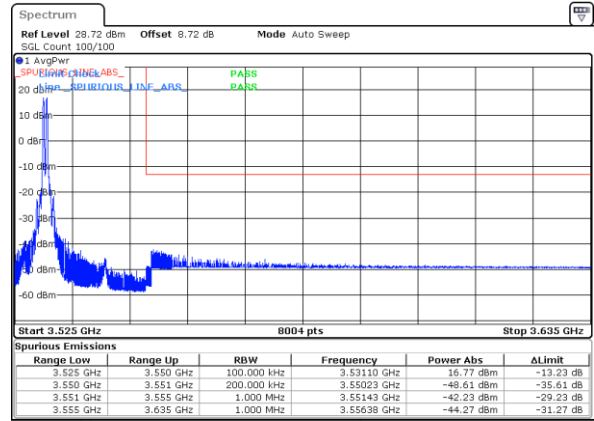
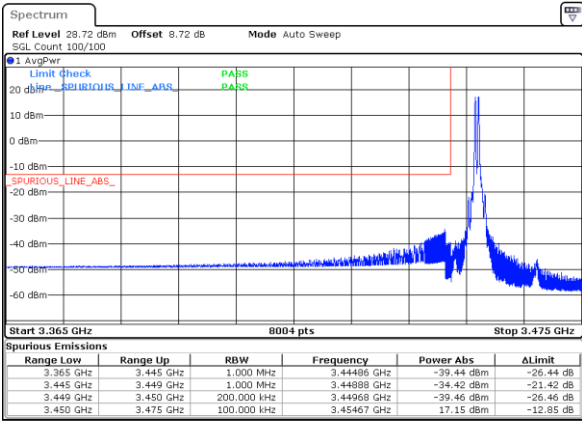

Date: 24.OCT.2022 14:28:23

Date: 24.OCT.2022 14:47:33

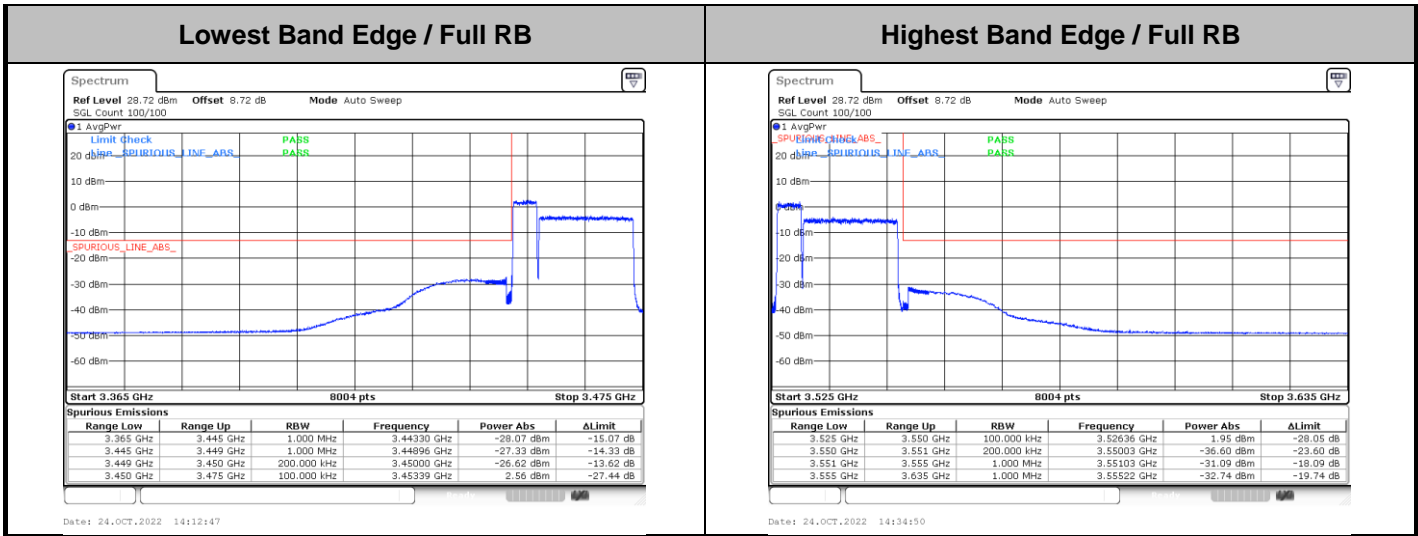



LTE Band 42C / 5MHz+20MHz

16QAM

Lowest Band Edge / 1RB0 and 1RB9

Highest Band Edge / 1RB0 and 1RB9

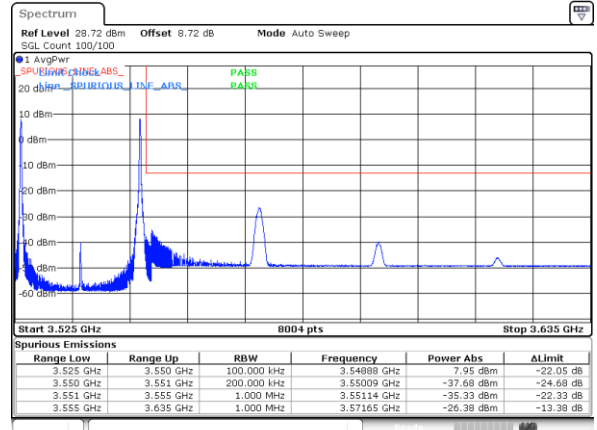
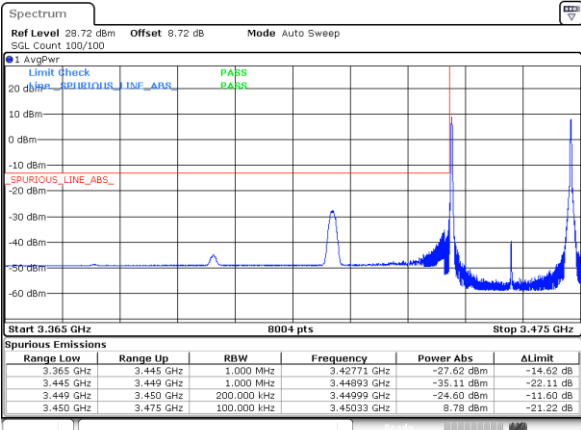

Date: 24.OCT.2022 14:24:09

Date: 24.OCT.2022 14:43:20

Lowest Band Edge / 1RB24 and 1RB0

Highest Band Edge / 1RB24 and 1RB0

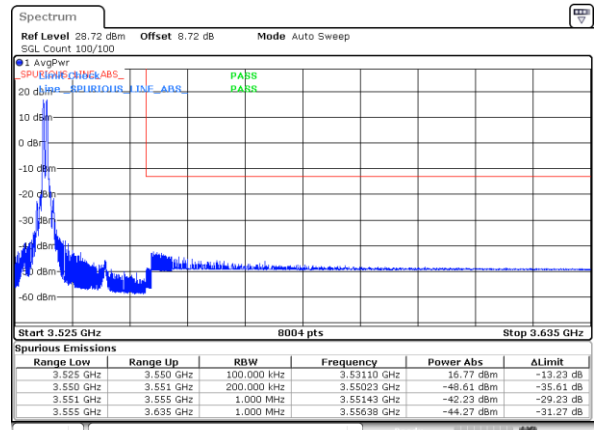
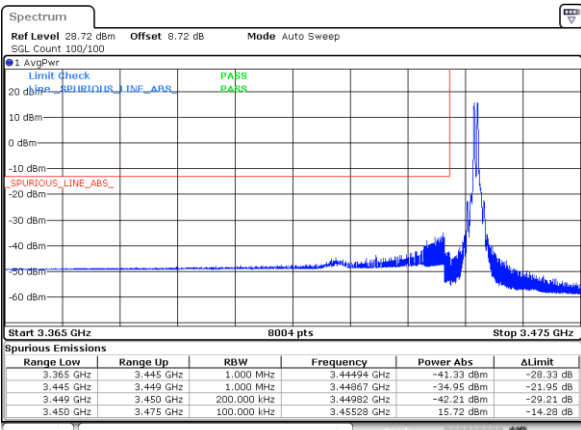

Date: 24.OCT.2022 14:30:30

Date: 24.OCT.2022 14:47:33

Lowest Band Edge / Full RB

Highest Band Edge / Full RB

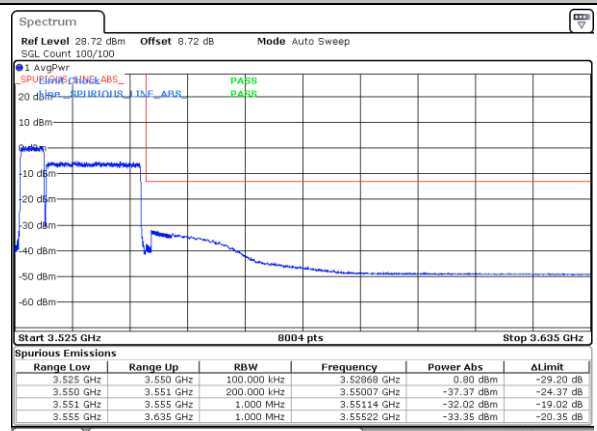
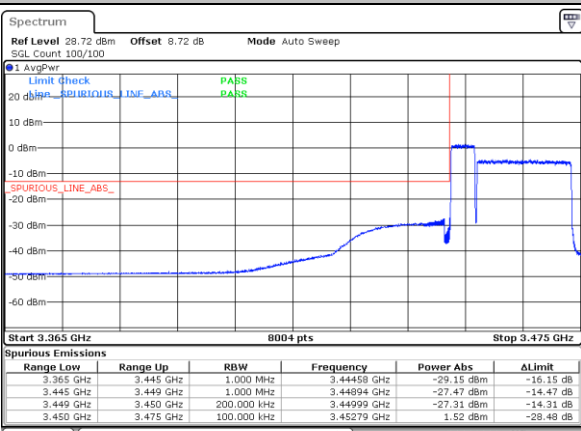

Date: 24.OCT.2022 14:14:14

Date: 24.OCT.2022 14:36:58



LTE Band 42C / 5MHz+20MHz

64QAM

Lowest Band Edge / 1RB0 and 1RB99

Highest Band Edge / 1RB0 and 1RB99

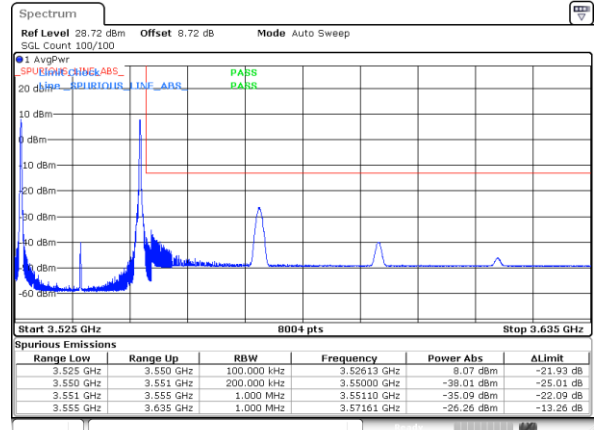
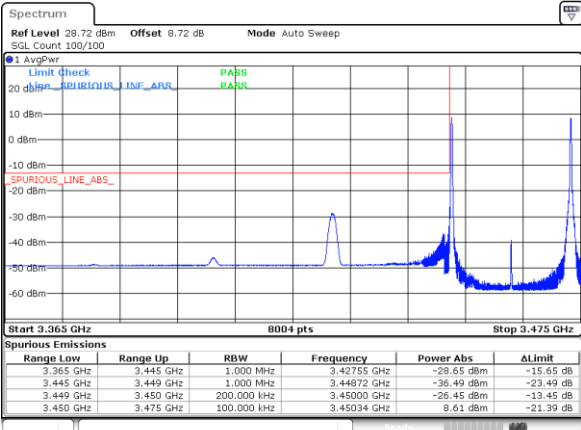

Date: 24.OCT.2022 14:22:03

Date: 24.OCT.2022 14:41:12

Lowest Band Edge / 1RB24 and 1RB0

Highest Band Edge / 1RB24 and 1RB0

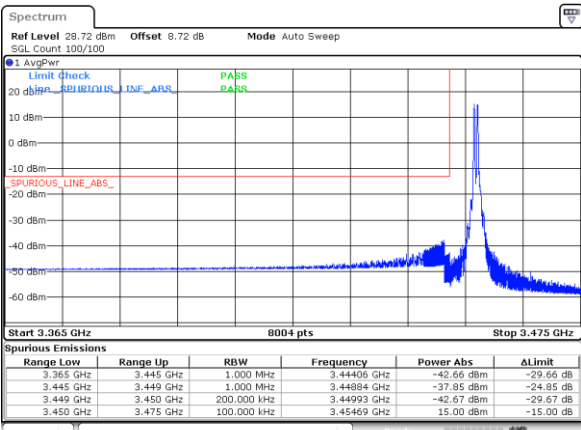

Date: 24.OCT.2022 14:32:36

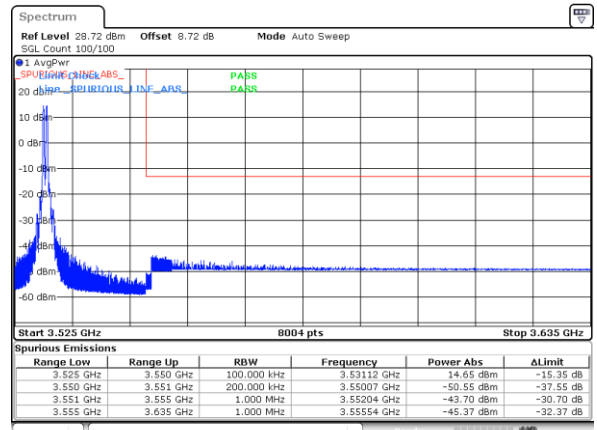

Date: 24.OCT.2022 14:51:48

Lowest Band Edge / Full RB

Highest Band Edge / Full RB

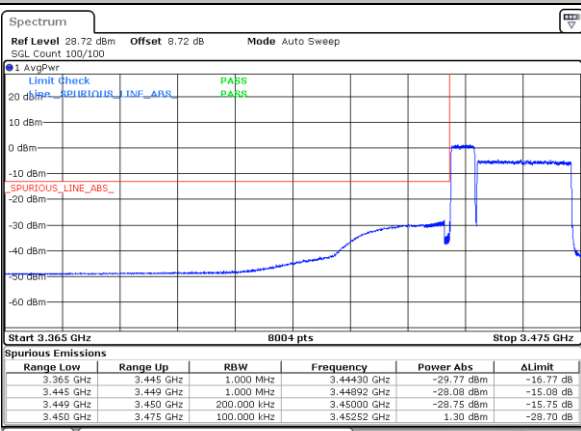

Date: 24.OCT.2022 14:15:41

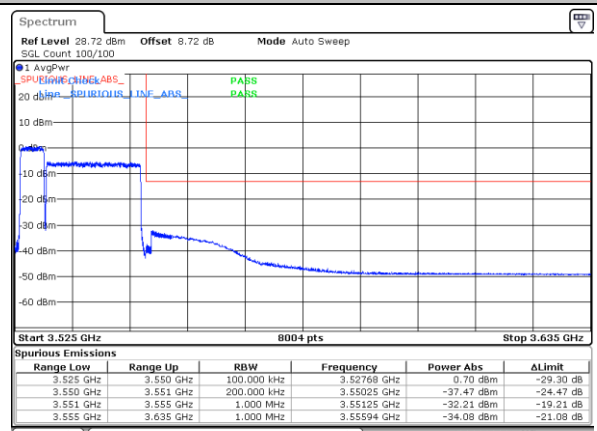

Date: 24.OCT.2022 14:39:05



LTE Band 42C / 5MHz+20MHz

256QAM

Lowest Band Edge / 1RB0 and 1RB99

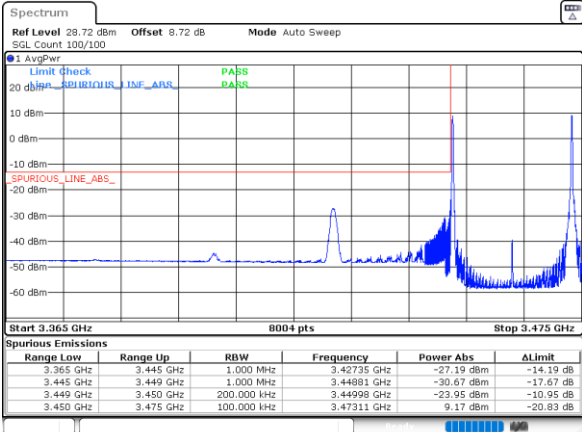

Date: 26.OCT.2022 00:33:25

Highest Band Edge / 1RB0 and 1RB99

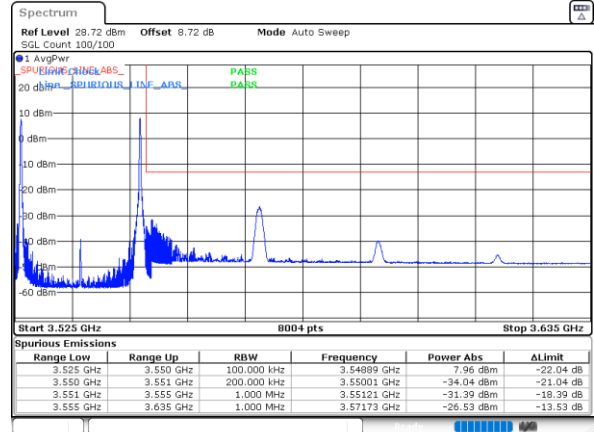

Date: 26.OCT.2022 00:37:18

Lowest Band Edge / 1RB24 and 1RB0

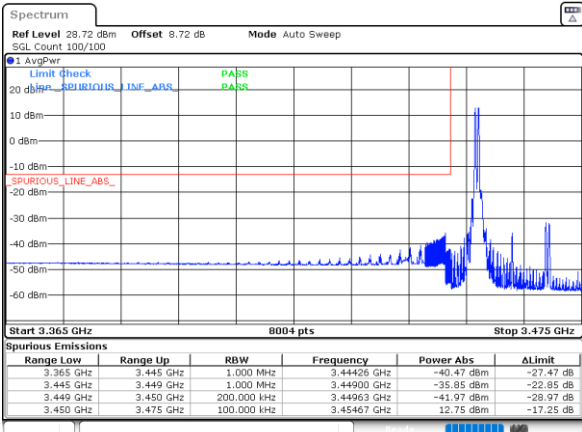

Date: 26.OCT.2022 00:34:48

Highest Band Edge / 1RB24 and 1RB0

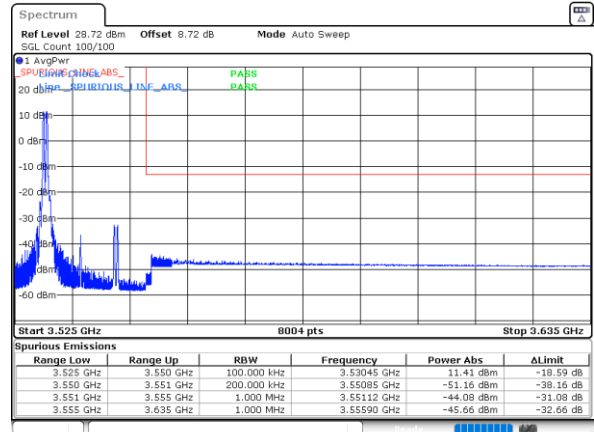

Date: 26.OCT.2022 00:38:24

Lowest Band Edge / Full RB

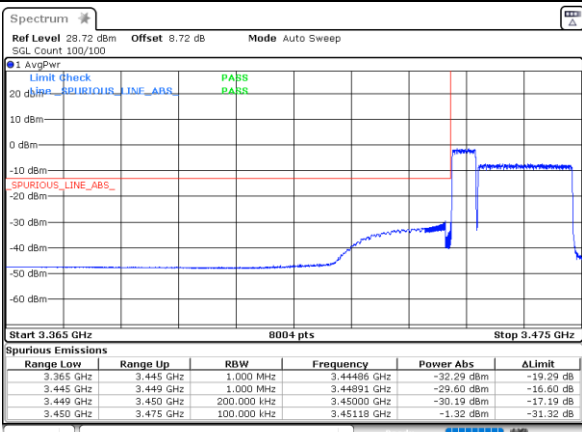

Date: 26.OCT.2022 00:31:24

Highest Band Edge / Full RB

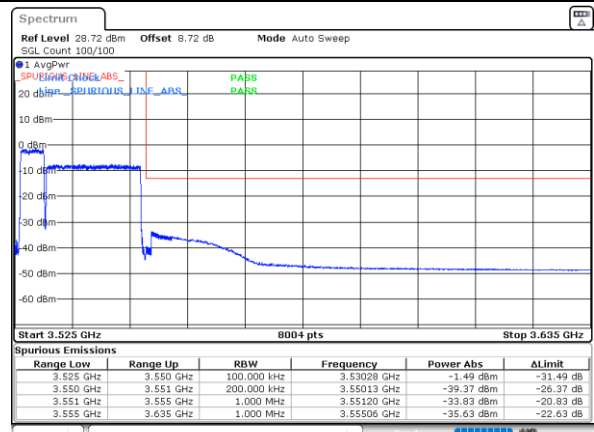

Date: 26.OCT.2022 00:36:22



LTE Band 42C / 10MHz+20MHz

QPSK

Lowest Band Edge / 1RB0 and 1RB99

Highest Band Edge / 1RB0 and 1RB99

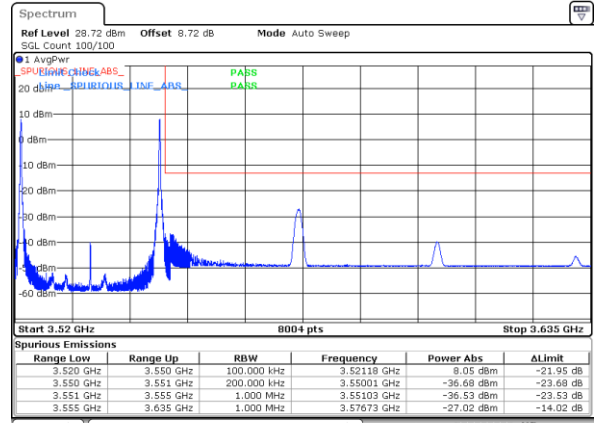
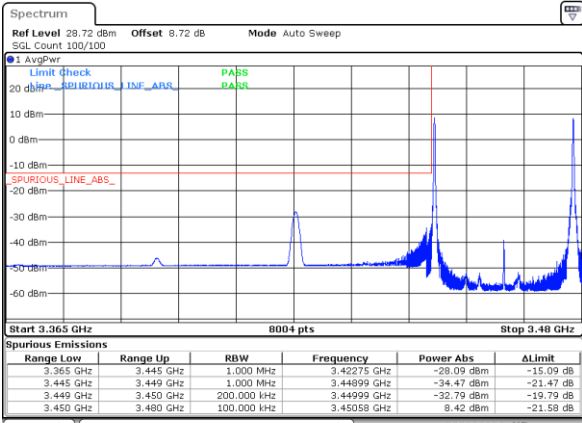

Date: 24.OCT.2022 15:47:33

Date: 24.OCT.2022 16:06:41

Lowest Band Edge / 1RB49 and 1RB0

Highest Band Edge / 1RB49 and 1RB0

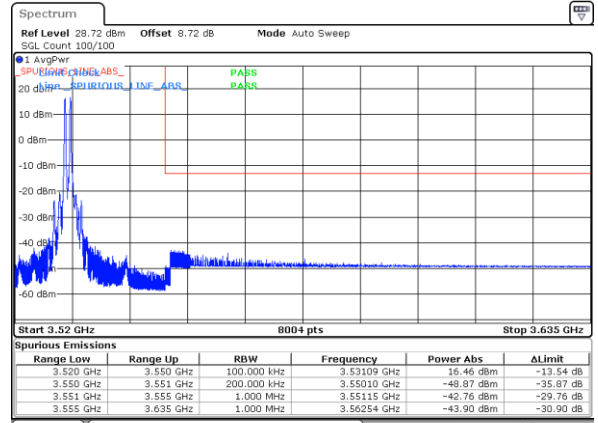
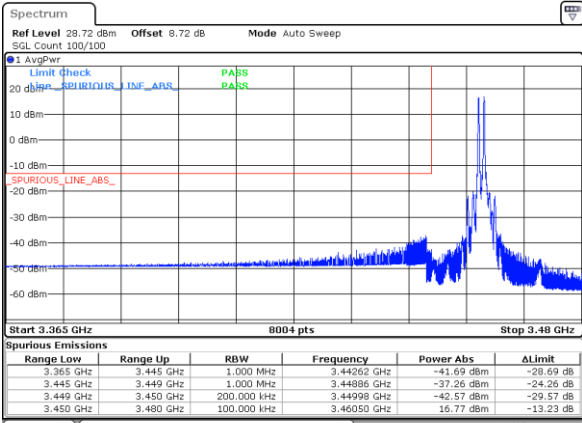

Date: 24.OCT.2022 15:49:40

Date: 24.OCT.2022 16:08:48

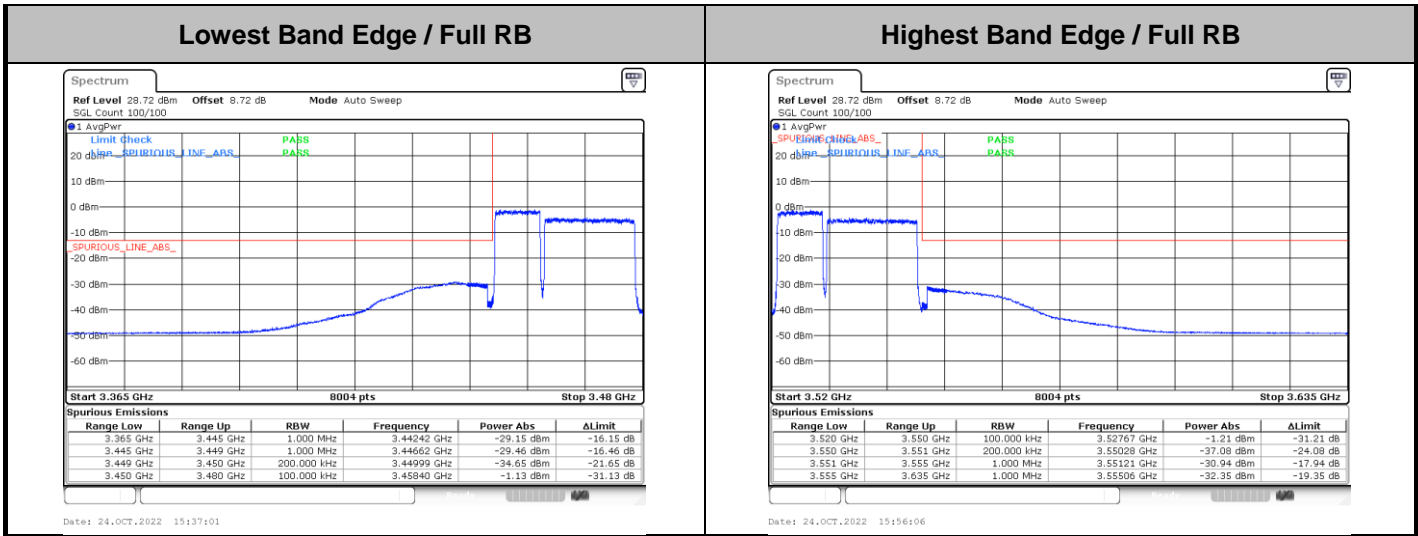



LTE Band 42C / 10MHz+20MHz

16QAM

Lowest Band Edge / 1RB0 and 1RB9

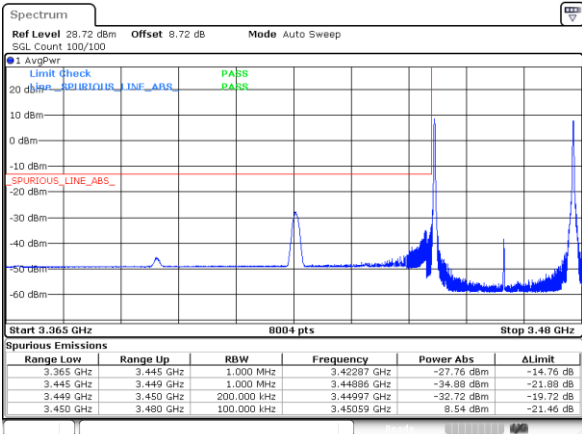

Date: 24.OCT.2022 15:45:27

Highest Band Edge / 1RB0 and 1RB9

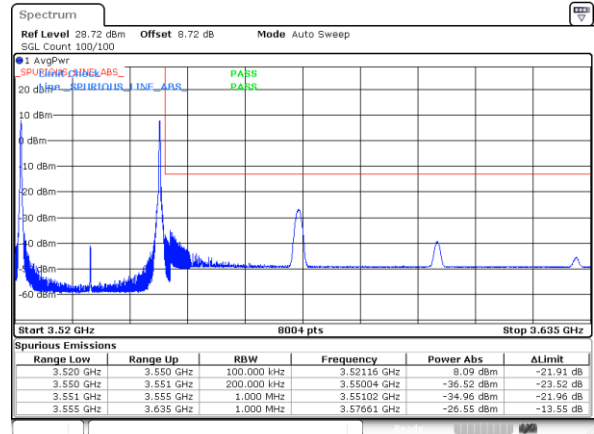

Date: 24.OCT.2022 16:04:34

Lowest Band Edge / 1RB49 and 1RB0

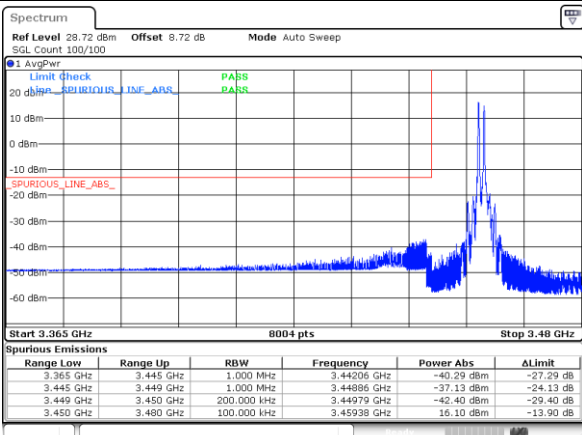

Date: 24.OCT.2022 15:51:46

Highest Band Edge / 1RB49 and 1RB0

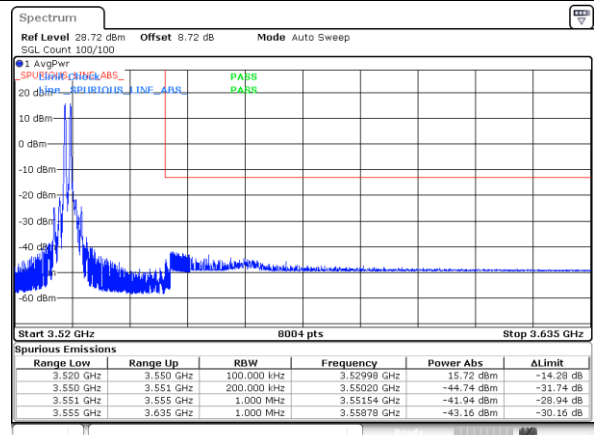

Date: 24.OCT.2022 16:10:54

Lowest Band Edge / Full RB

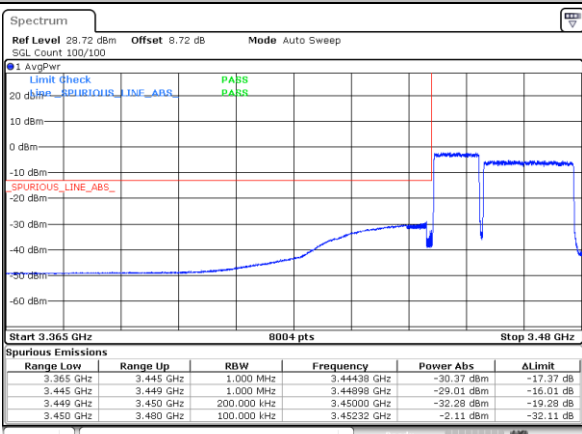

Date: 24.OCT.2022 15:39:08

Highest Band Edge / Full RB

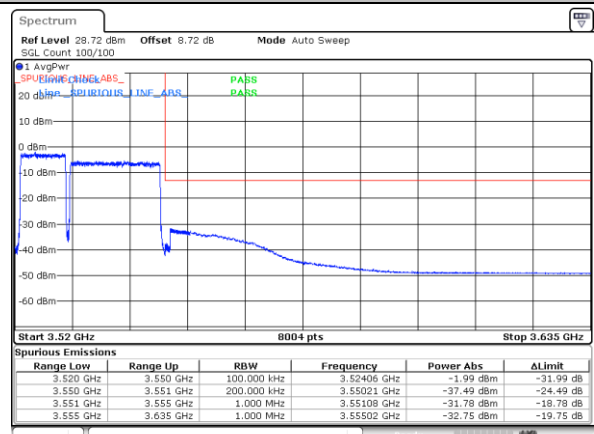

Date: 24.OCT.2022 15:58:13

LTE Band 42C / 10MHz+20MHz

64QAM

Lowest Band Edge / 1RB0 and 1RB99

Highest Band Edge / 1RB0 and 1RB99

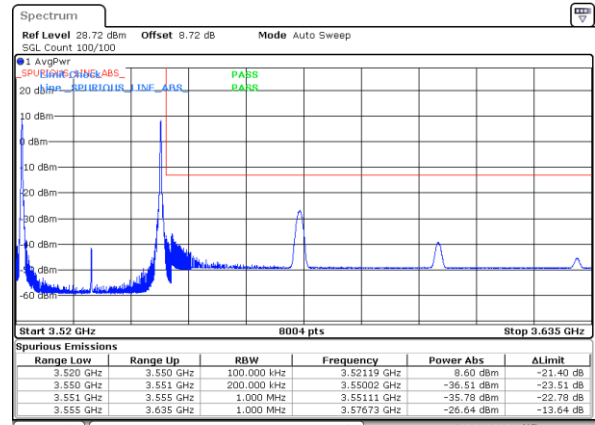
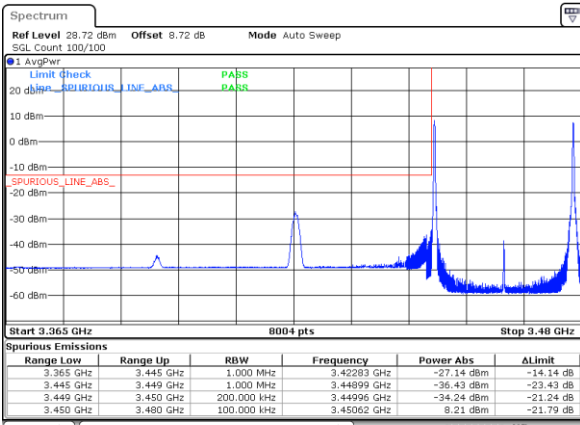

Date: 24.OCT.2022 15:43:21

Date: 24.OCT.2022 16:02:27

Lowest Band Edge / 1RB49 and 1RB0

Highest Band Edge / 1RB49 and 1RB0

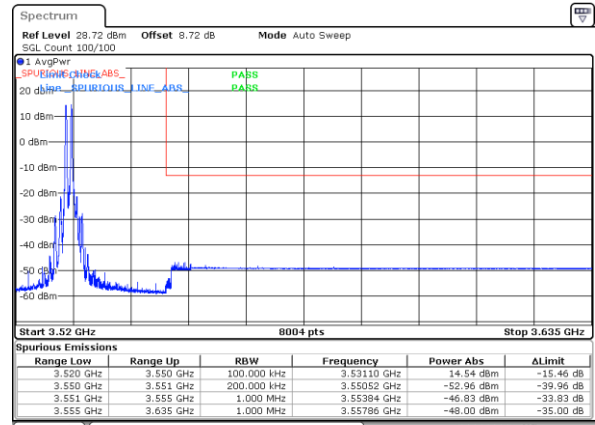
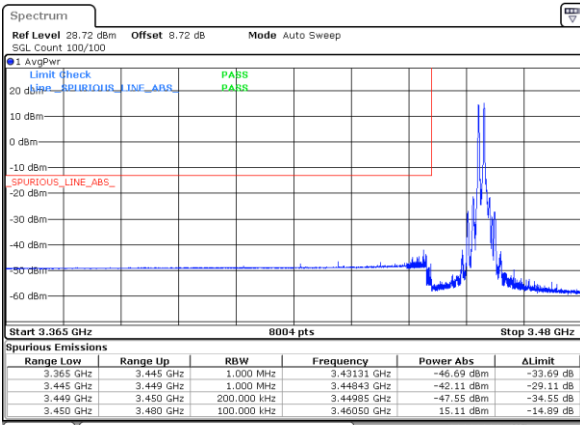

Date: 24.OCT.2022 15:53:52

Date: 24.OCT.2022 16:13:01



Lowest Band Edge / Full RB

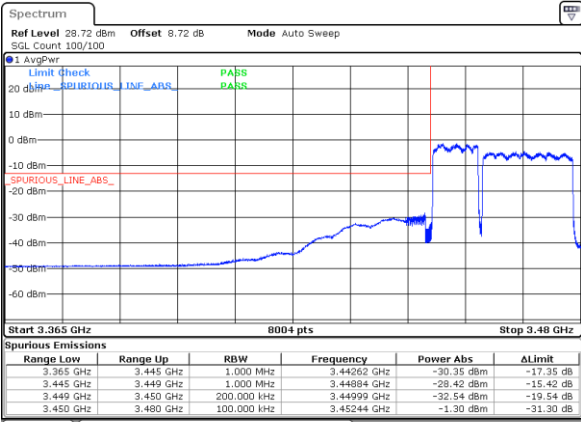

Highest Band Edge / Full RB

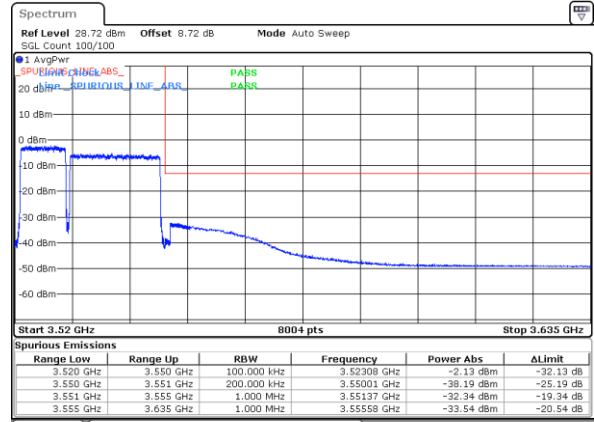

LTE Band 42C / 10MHz+20MHz

256QAM

Lowest Band Edge / 1RB0 and 1RB9

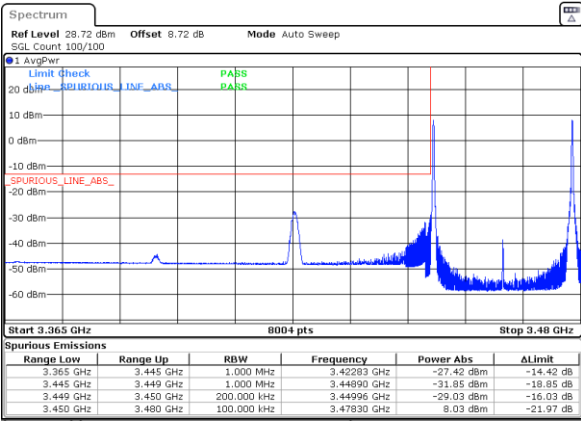

Highest Band Edge / 1RB0 and 1RB9

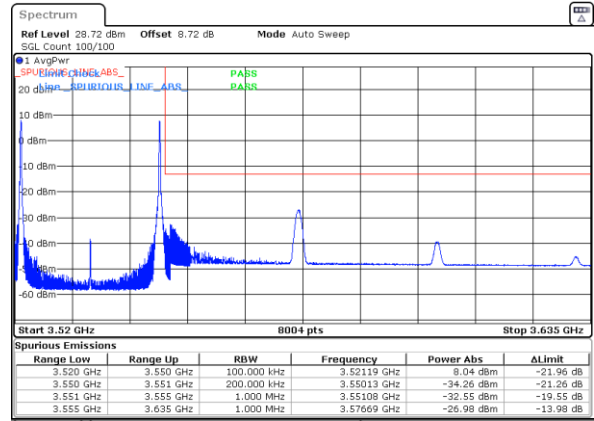

Lowest Band Edge / 1RB49 and 1RB0

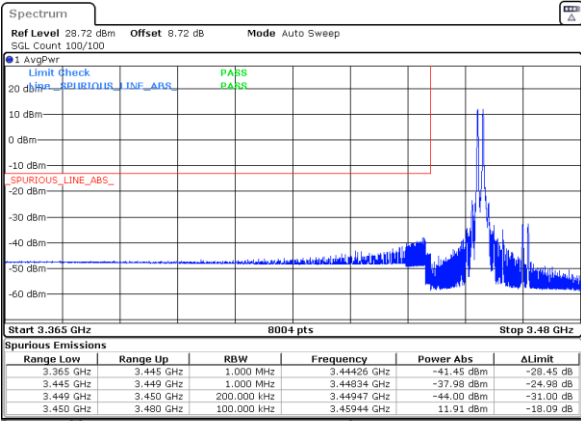

Highest Band Edge / 1RB49 and 1RB0

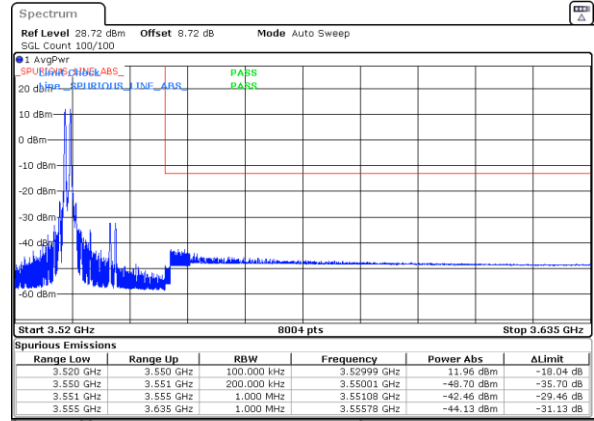

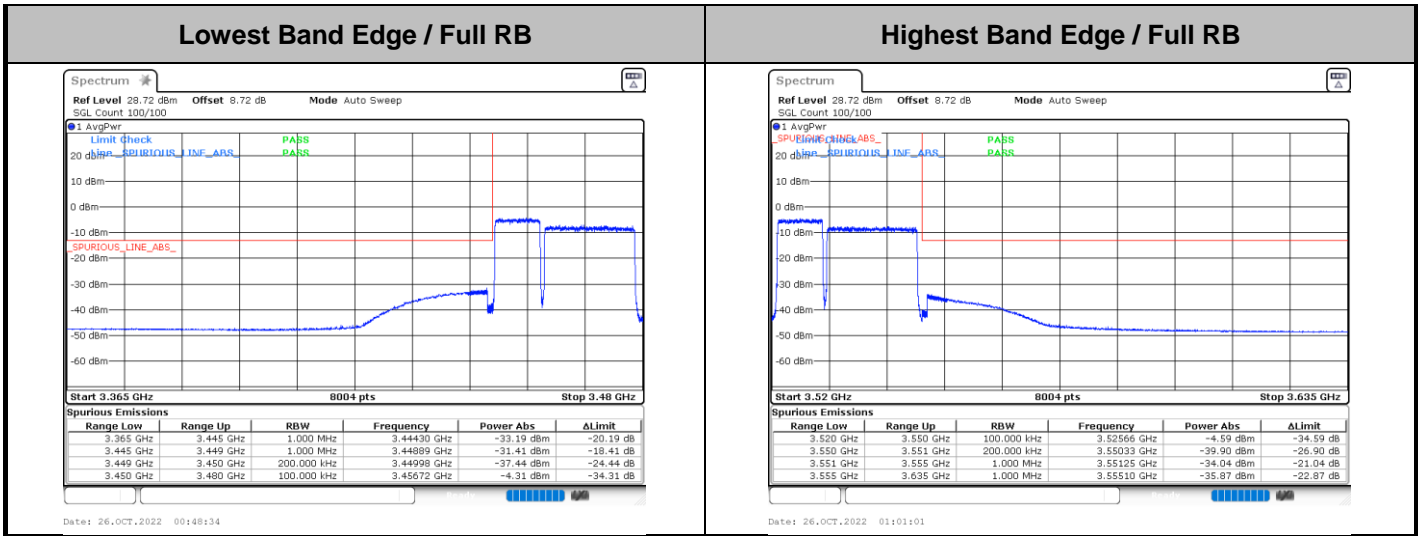



LTE Band 42C / 15MHz+20MHz

QPSK

Lowest Band Edge / 1RB0 and 1RB9

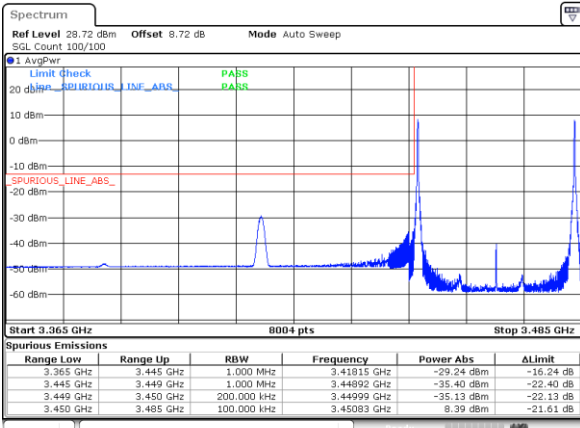

Highest Band Edge / 1RB0 and 1RB9

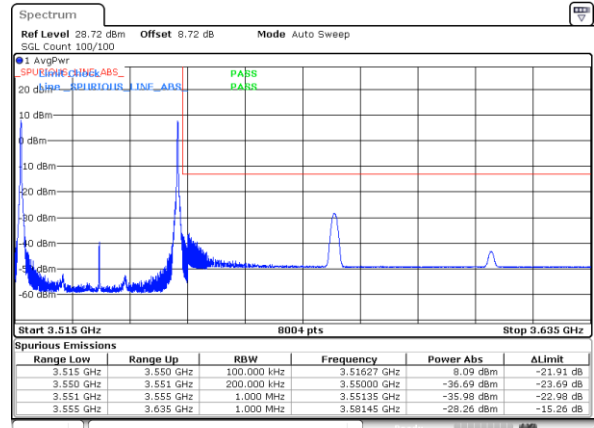

Lowest Band Edge / 1RB74 and 1RB0

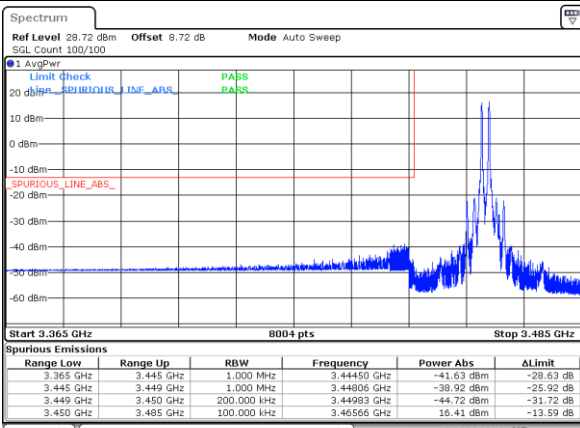

Highest Band Edge / 1RB74 and 1RB0

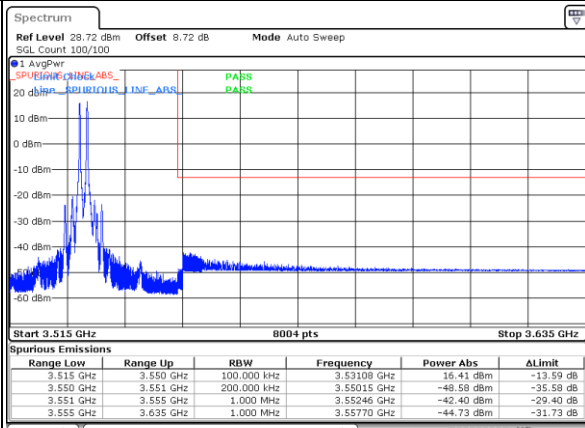

Lowest Band Edge / Full RB

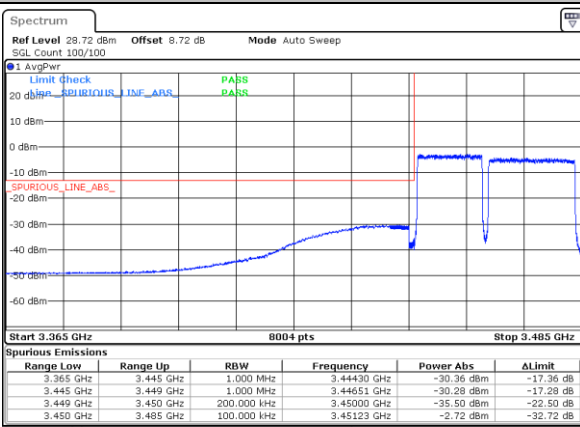

Highest Band Edge / Full RB

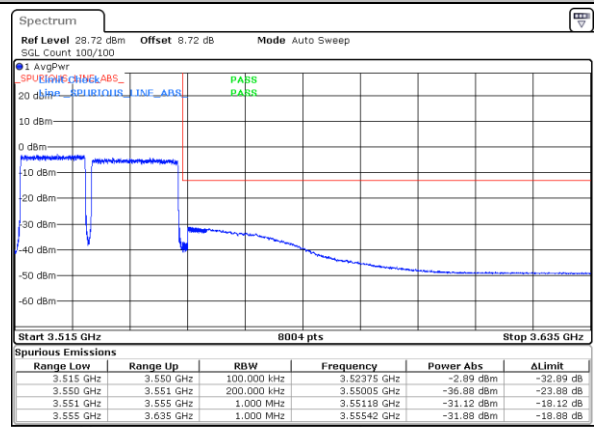



LTE Band 42C / 15MHz+20MHz

16QAM

Lowest Band Edge / 1RB0 and 1RB9

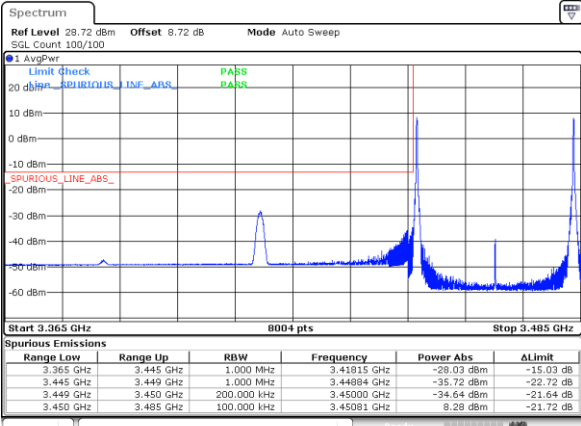

Date: 24.OCT.2022 17:05:28

Highest Band Edge / 1RB0 and 1RB9

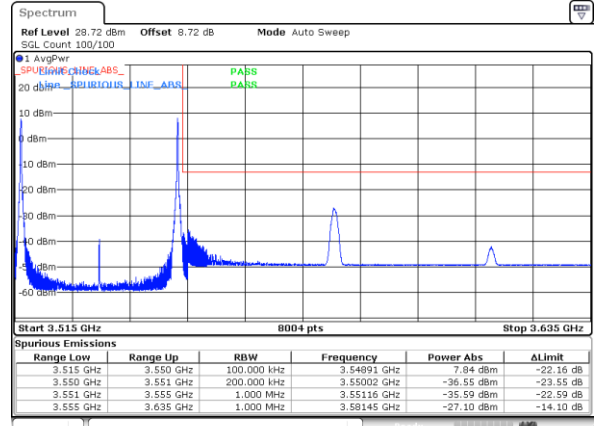

Date: 24.OCT.2022 17:24:29

Lowest Band Edge / 1RB74 and 1RB0

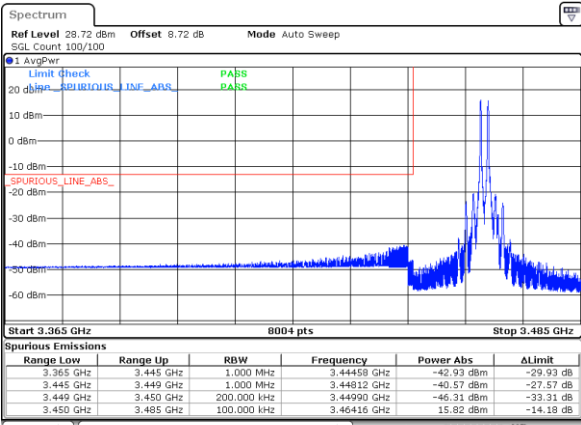

Date: 24.OCT.2022 17:11:47

Highest Band Edge / 1RB74 and 1RB0

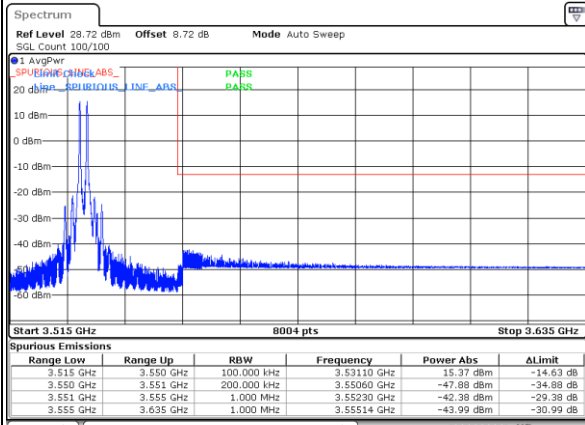

Date: 24.OCT.2022 17:30:46

Lowest Band Edge / Full RB

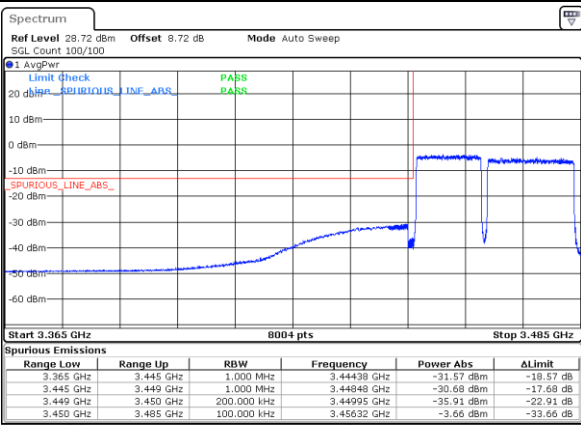

Date: 24.OCT.2022 16:59:10

Highest Band Edge / Full RB

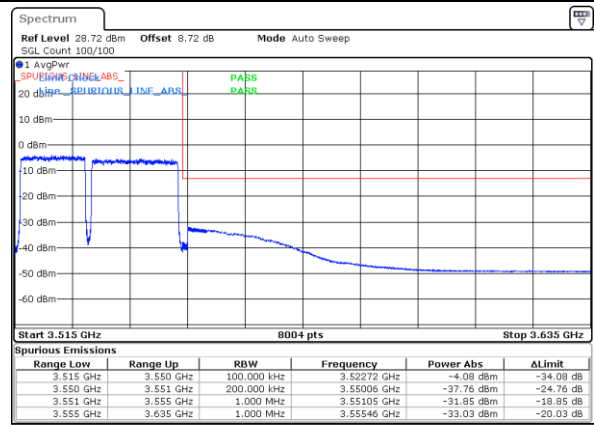

Date: 24.OCT.2022 17:18:11



LTE Band 42C / 15MHz+20MHz

64QAM

Lowest Band Edge / 1RB0 and 1RB9

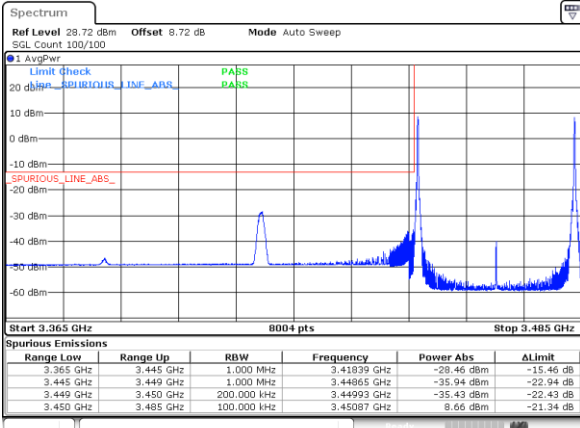

Date: 24.OCT.2022 17:03:22

Highest Band Edge / 1RB0 and 1RB9

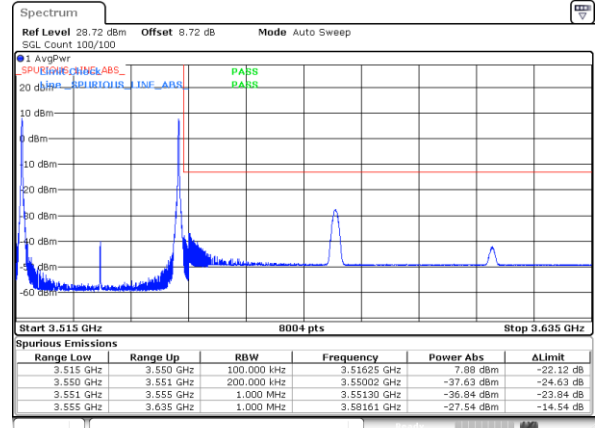

Date: 24.OCT.2022 17:22:23

Lowest Band Edge / 1RB74 and 1RB0

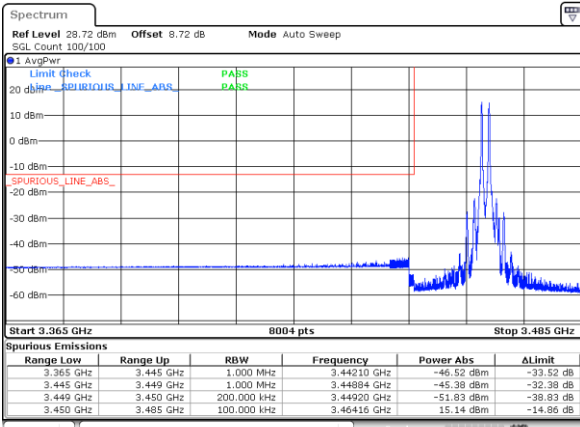

Date: 24.OCT.2022 17:13:53

Highest Band Edge / 1RB74 and 1RB0

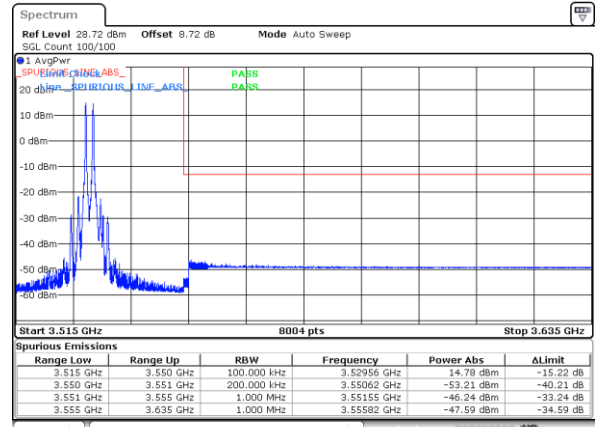

Date: 24.OCT.2022 17:32:52

Lowest Band Edge / Full RB

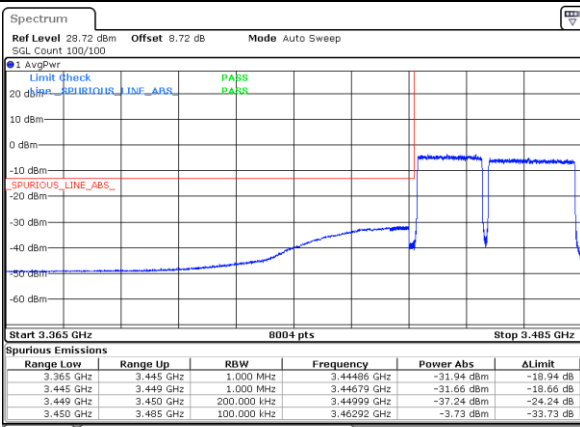

Date: 24.OCT.2022 17:01:16

Highest Band Edge / Full RB

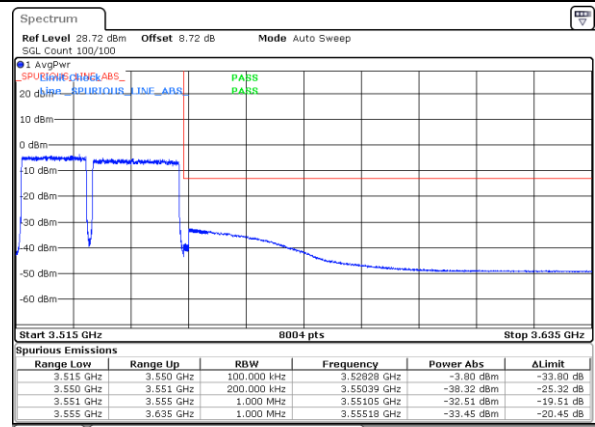

Date: 24.OCT.2022 17:20:17



LTE Band 42C / 15MHz+20MHz

256QAM

Lowest Band Edge / 1RB0 and 1RB9

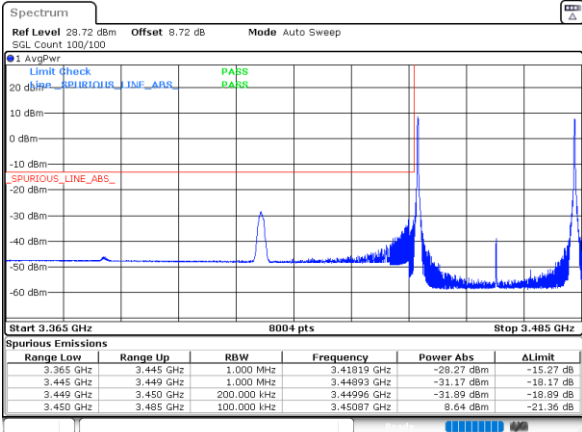

Date: 26.OCT.2022 02:10:53

Highest Band Edge / 1RB0 and 1RB9

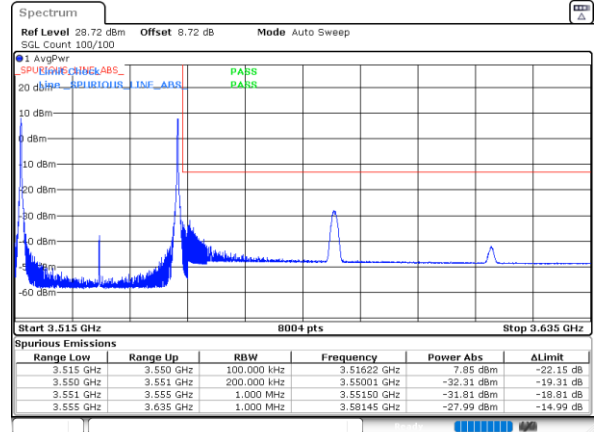

Date: 26.OCT.2022 02:13:32

Lowest Band Edge / 1RB74 and 1RB0

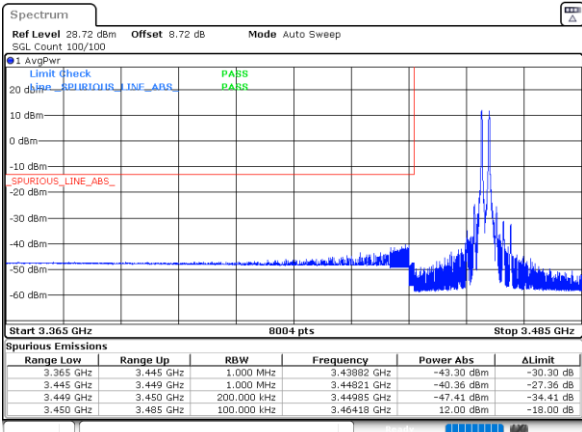

Date: 26.OCT.2022 02:11:24

Highest Band Edge / 1RB74 and 1RB0

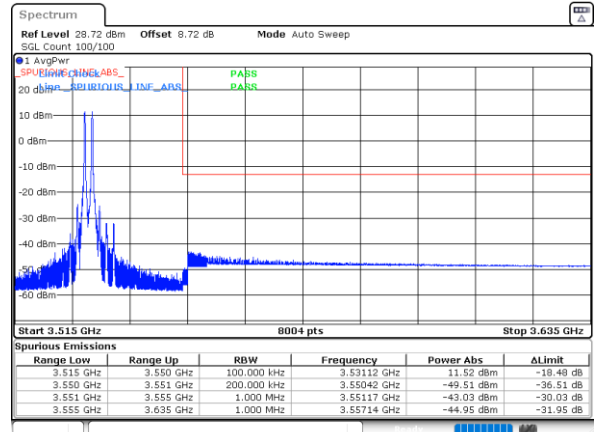

Date: 26.OCT.2022 02:14:29

Lowest Band Edge / Full RB

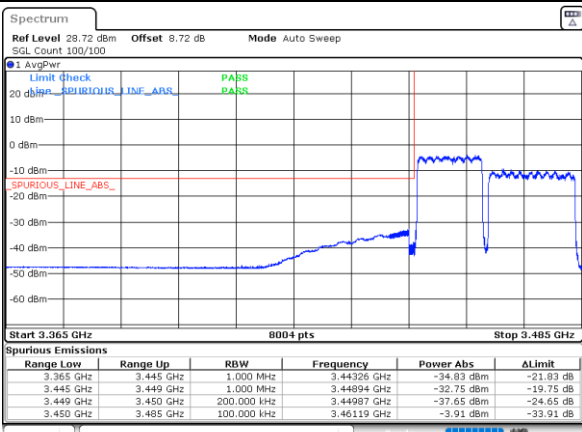

Date: 26.OCT.2022 02:08:49

Highest Band Edge / Full RB

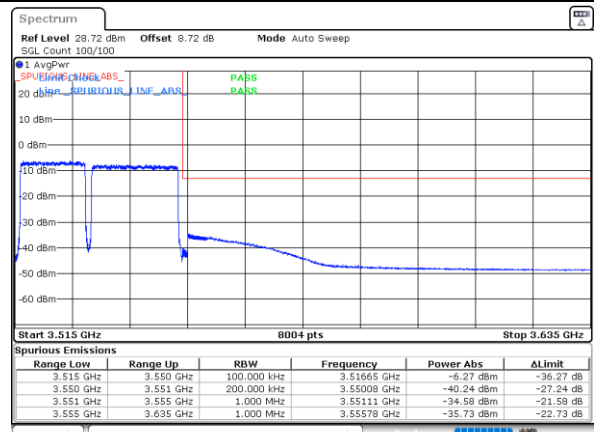

Date: 26.OCT.2022 02:12:32



LTE Band 42C / 20MHz+5MHz

QPSK

Lowest Band Edge / 1RB0 and 1RB24

Highest Band Edge / 1RB0 and 1RB24

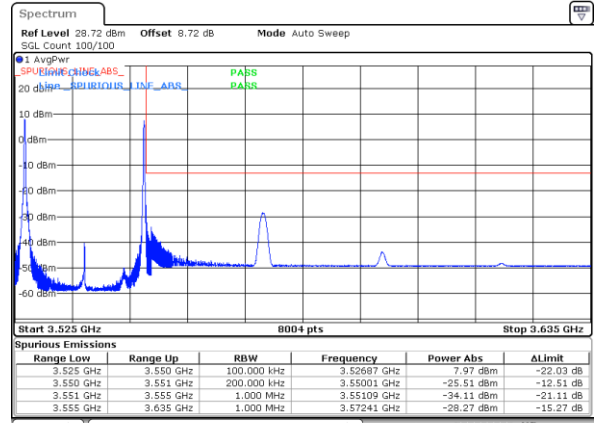
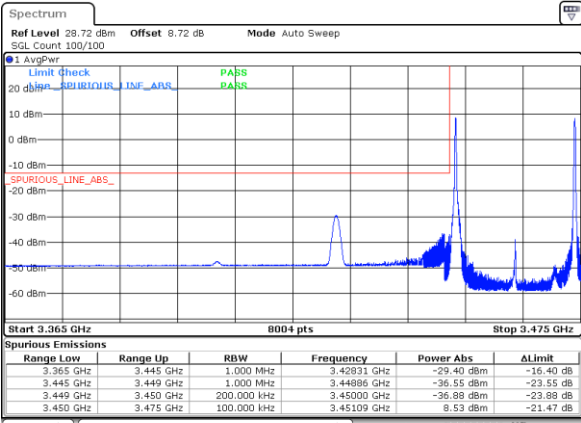

Date: 24.OCT.2022 15:08:24

Date: 24.OCT.2022 15:27:31

Lowest Band Edge / 1RB99 and 1RB0

Highest Band Edge / 1RB99 and 1RB0

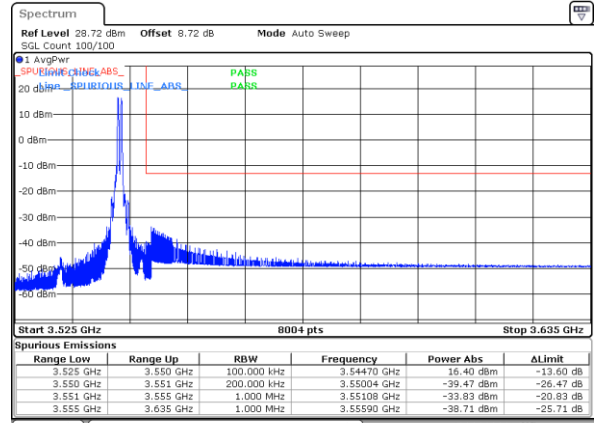
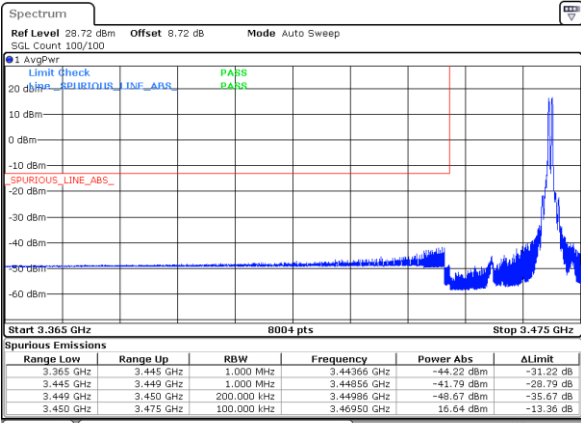

Date: 24.OCT.2022 15:10:31

Date: 24.OCT.2022 15:29:38

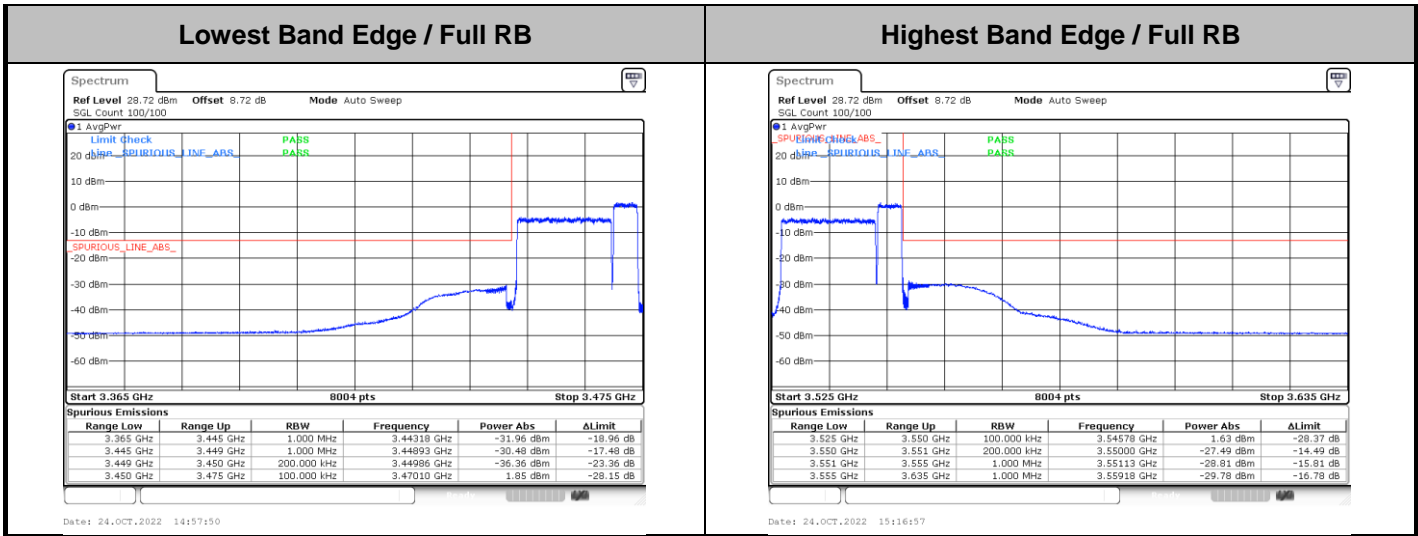



LTE Band 42C / 20MHz+5MHz

16QAM

Lowest Band Edge / 1RB0 and 1RB24

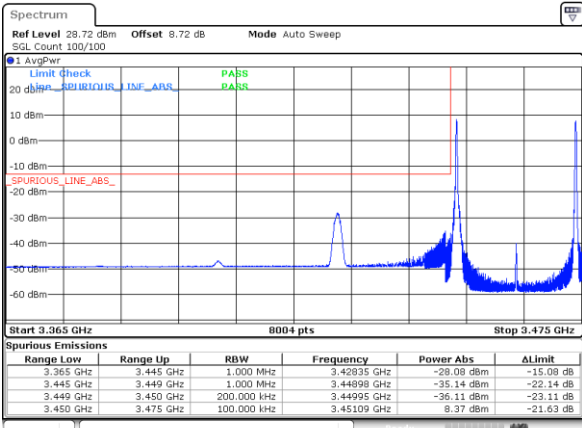

Date: 24.OCT.2022 15:06:18

Highest Band Edge / 1RB0 and 1RB24

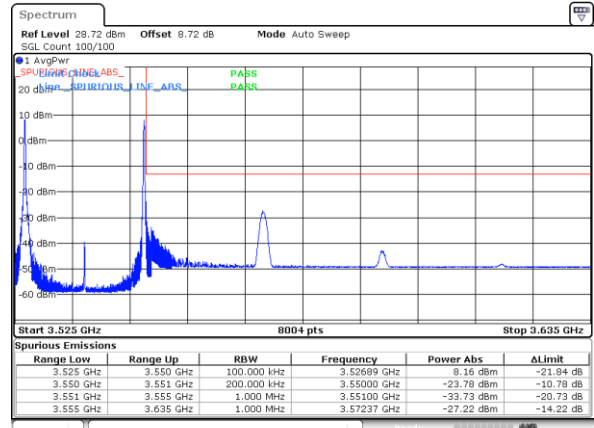

Date: 24.OCT.2022 15:25:24

Lowest Band Edge / 1RB99 and 1RB0

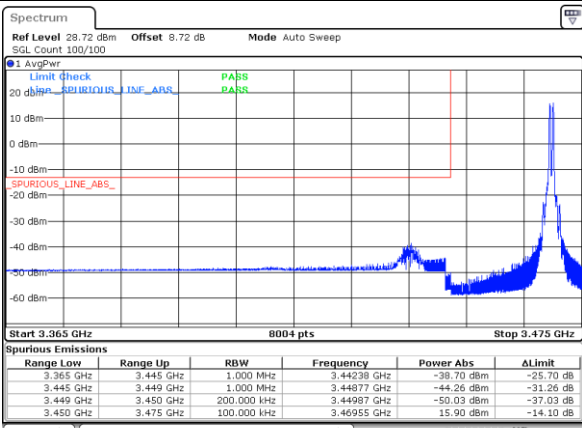

Date: 24.OCT.2022 15:12:37

Highest Band Edge / 1RB99 and 1RB0

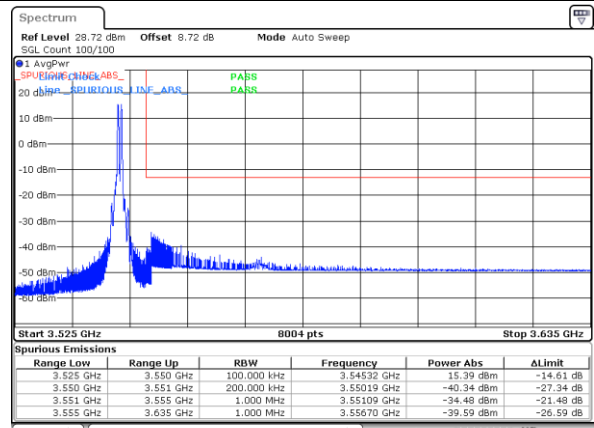

Date: 24.OCT.2022 15:31:45

Lowest Band Edge / Full RB

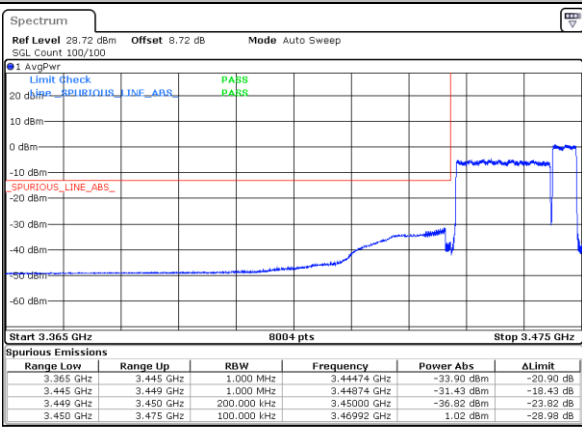

Date: 24.OCT.2022 14:59:58

Highest Band Edge / Full RB

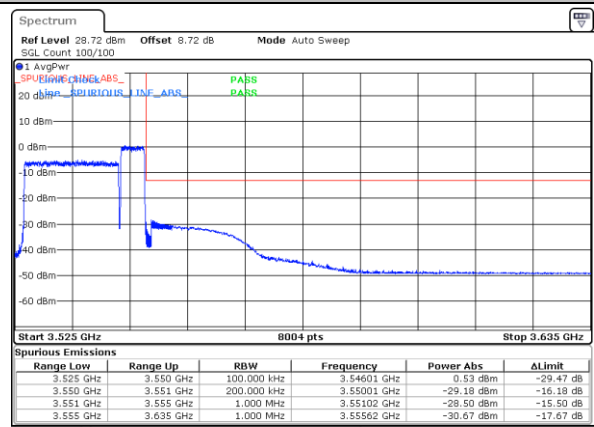

Date: 24.OCT.2022 15:19:04



LTE Band 42C / 20MHz+5MHz

64QAM

Lowest Band Edge / 1RB0 and 1RB24

Highest Band Edge / 1RB0 and 1RB24

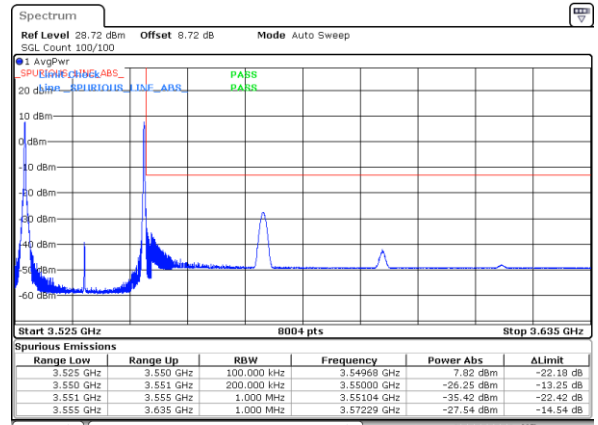
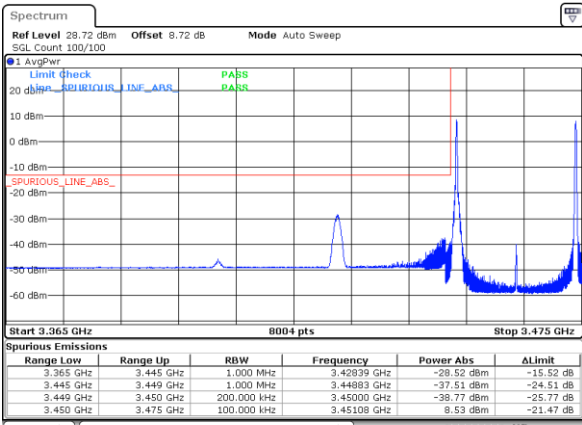

Date: 24.OCT.2022 15:04:11

Date: 24.OCT.2022 15:23:18

Lowest Band Edge / 1RB99 and 1RB0

Highest Band Edge / 1RB99 and 1RB0

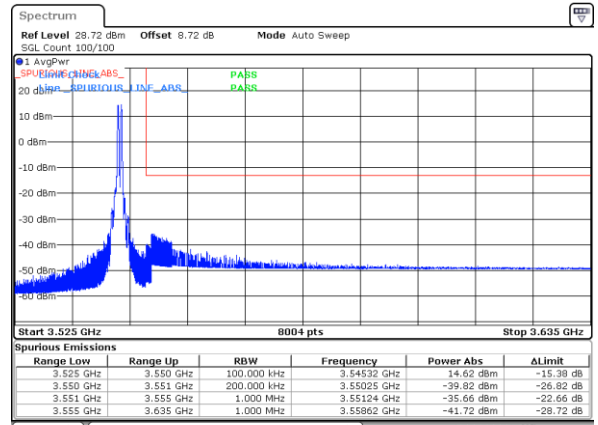
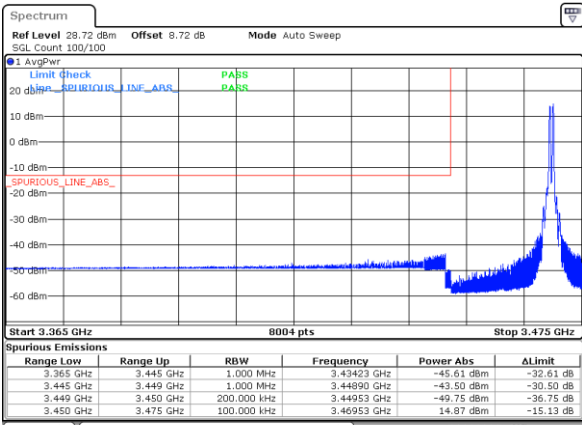

Date: 24.OCT.2022 15:14:44

Date: 24.OCT.2022 15:33:52



Lowest Band Edge / Full RB

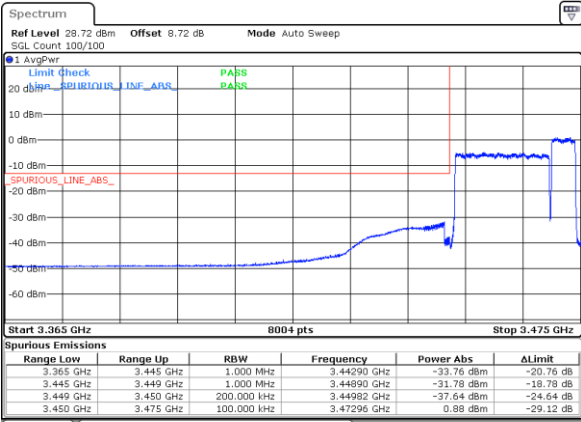

Date: 24_OCT_2022 15:02:05

Highest Band Edge / Full RB

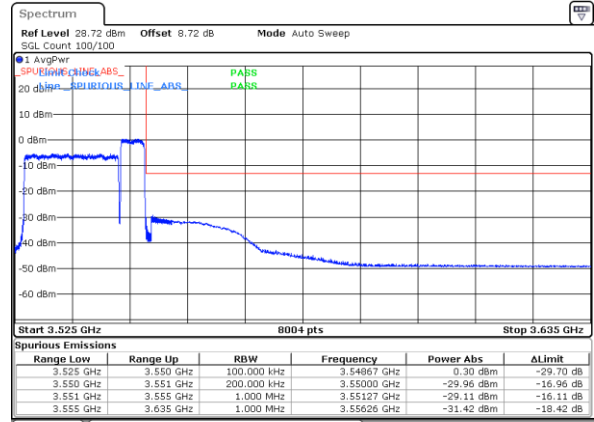

Date: 24_OCT_2022 15:23:11

LTE Band 42C / 20MHz+5MHz

256QAM

Lowest Band Edge / 1RB0 and 1RB24

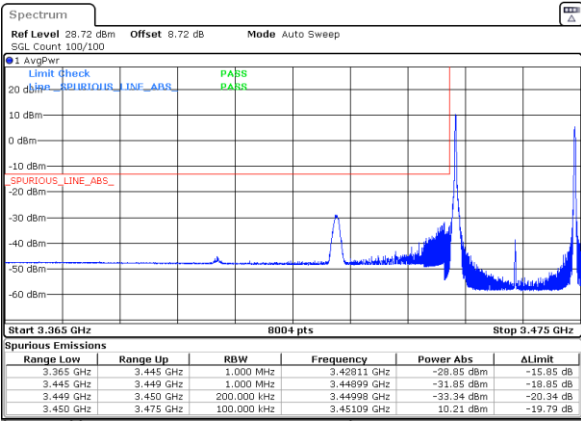

Date: 26_OCT_2022 00:41:55

Highest Band Edge / 1RB0 and 1RB24

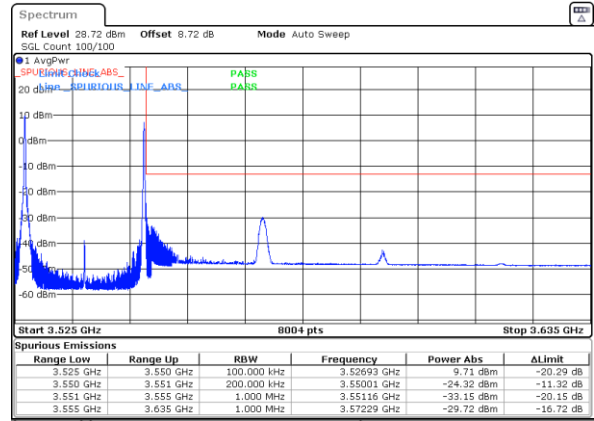

Date: 26_OCT_2022 00:45:54

Lowest Band Edge / 1RB99 and 1RB0

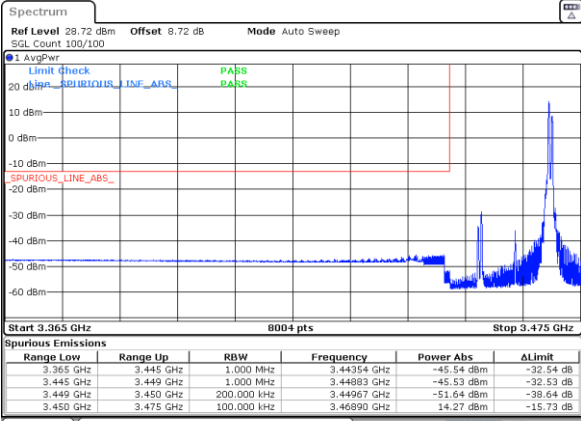

Date: 26_OCT_2022 00:42:58

Highest Band Edge / 1RB99 and 1RB0

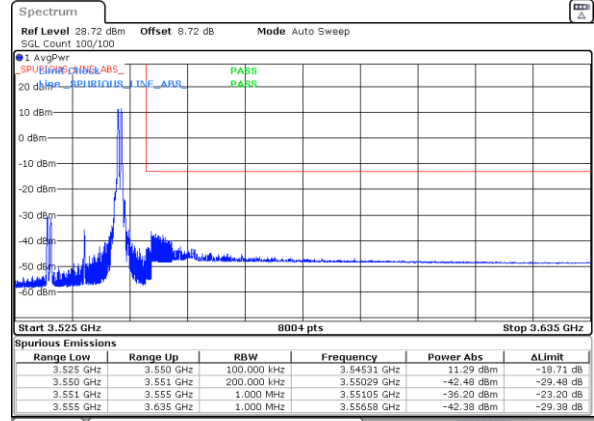

Date: 26_OCT_2022 00:46:50