



# FCC RF Test Report

**APPLICANT** : Motorola Mobility LLC  
**EQUIPMENT** : Mobile Cellular Phone  
**BRAND NAME** : Motorola  
**MODEL NAME** : XT2321-3, XT2321-5  
**FCC ID** : IHDT56AJ3  
**STANDARD** : 47 CFR Part 2, 22, 24, 27  
**CLASSIFICATION** : PCS Licensed Transmitter Held to Ear (PCE)  
**TEST DATE(S)** : Dec. 22, 2022 ~ Jan. 12, 2023

We, Sporton International Inc. (ShenZhen), would like to declare that the tested sample has been evaluated in accordance with the procedures given in ANSI C63.26-2015 and shown compliance with the applicable technical standards.

The test results in this report apply exclusively to the tested model / sample. Without written approval of Sporton International Inc. (ShenZhen), the test report shall not be reproduced except in full.

Jason Jia



Approved by: Jason Jia

**Sporton International Inc. (ShenZhen)**

**1/F, 2/F, Bldg 5, Shiling Industrial Zone, Xinwei Village, Xili, Nanshan, Shenzhen, 518055**

**People's Republic of China**



TABLE OF CONTENTS

REVISION HISTORY... 3
SUMMARY OF TEST RESULT ... 4
1 GENERAL DESCRIPTION ... 5
1.1 Applicant ... 5
1.2 Manufacturer ... 5
1.3 Product Feature of Equipment Under Test ... 5
1.4 Product Specification of Equipment Under Test ... 5
1.5 Modification of EUT ... 6
1.6 Specification of Accessory ... 7
1.7 Maximum ERP/EIRP Power and Emission Designator ... 7
1.8 Testing Location ... 9
1.9 Test Software ... 9
1.10 Applicable Standards ... 9
2 TEST CONFIGURATION OF EQUIPMENT UNDER TEST ... 10
2.1 Test Mode ... 10
2.2 Connection Diagram of Test System ... 12
2.3 Support Unit used in test configuration and system ... 12
2.4 Measurement Results Explanation Example ... 12
2.5 Frequency List of Low/Middle/High Channels ... 13
3 CONDUCTED TEST ITEMS ... 16
3.1 Measuring Instruments ... 16
3.2 Test Setup ... 16
3.3 Test Result of Conducted Test ... 16
3.4 Conducted Output Power and ERP/EIRP ... 17
3.5 Peak-to-Average Ratio ... 18
3.6 Occupied Bandwidth ... 19
3.7 Conducted Band Edge ... 20
3.8 Conducted Spurious Emission ... 22
3.9 Frequency Stability ... 23
4 RADIATED TEST ITEMS ... 24
4.1 Measuring Instruments ... 24
4.2 Test Setup ... 24
4.3 Test Result of Radiated Test ... 25
4.4 Radiated Spurious Emission ... 26
5 LIST OF MEASURING EQUIPMENT ... 27
6 UNCERTAINTY OF EVALUATION ... 28
APPENDIX A. TEST RESULTS OF CONDUCTED TEST
APPENDIX B. TEST RESULTS OF RADIATED TEST
APPENDIX C. TEST SETUP PHOTOGRAPHS



### REVISION HISTORY

REPORT NO.	VERSION	DESCRIPTION	ISSUED DATE
FG2D0913J	Rev. 01	Initial issue of report	Feb. 01, 2023



### SUMMARY OF TEST RESULT

Report Section	FCC Rule	Description	Limit	Result	Remark
3.4	§2.1046	Conducted Output Power	Reporting Only	PASS	-
	§22.913(a)(5)	Effective Radiated Power (5G NR n5, n26)	ERP < 7 Watt		
	§27.50(b)(10) §27.50(c)(10)	Effective Radiated Power (5G NR n12, n13, n71)	ERP < 3 Watt		
	§24.232(c)	Equivalent Isotropic Radiated Power (5G NR n2, n25)	EIRP < 2Watt		
3.5	§24.232(d)	Peak-to-Average Ratio	<13 dB	PASS	-
3.6	§2.1049	Occupied Bandwidth	Reporting Only	PASS	-
3.7	§2.1051 §22.917(a) §24.238(a) §27.53(c)(2)(4) §27.53(g)	Conducted Band Edge Measurement (5G NR n5, n26) (5G NR n2, n25) (5G NR n12, n13, n71)	< 43+10log10(P[Watts])	PASS	-
3.8	§2.1051 §22.917(a) §24.238(a) §27.53(c)(2) §27.53(g)	Conducted Spurious Emission (5G NR n5, n26) (5G NR n2, n25) (5G NR n12, n13, n71)	< 43+10log10(P[Watts])	PASS	-
3.9	§2.1055 §22.355	Frequency Stability Temperature & Voltage	< 2.5 ppm for Part 22	PASS	-
	§24.235 §27.54		Within Authorized Band		
4.4	§2.1053 §22.917(a) §24.238(a) §27.53(c)(2) & §27.53(f) §27.53(g)	Radiated Spurious Emission (5G NR n5, n26) (5G NR n2, n25) (5G NR n12, n13, n71)	< 43+10log <sub>10</sub> (P[Watts])	PASS	Under limit 12.19 dB at 10875.000 MHz

<b>Declaration of Conformity:</b>
The test results with all measurement uncertainty excluded are presented in accordance with the regulation limits or requirements declared by manufacturers.
<b>Comments and Explanations:</b>
The declared of product specification for EUT presented in the report are provided by the manufacturer, and the manufacturer takes all the responsibilities for the accuracy of product specification.



# 1 General Description

## 1.1 Applicant

Motorola Mobility LLC  
222 W,Merchandise Mart Plaza, Chicago IL 60654 USA

## 1.2 Manufacturer

Motorola Mobility LLC  
222 W,Merchandise Mart Plaza, Chicago IL 60654 USA

## 1.3 Product Feature of Equipment Under Test

Product Feature	
Equipment	Mobile Cellular Phone
Brand Name	Motorola
Model Name	XT2321-3, XT2321-5
FCC ID	IHDT56AJ3
IMEI Code	Conducted : 358041760020174 Radiation : 358041760025637/358041760025645
HW Version	DVT2
SW Version	TTZ 33.50
EUT Stage	Identical Prototype

The two model names XT2321-3, XT2321-5 are the same product except model name different for market segment.

## 1.4 Product Specification of Equipment Under Test

Standards-related Product Specification	
Tx Frequency	5G NR n2 : 1850 MHz ~ 1910 MHz 5G NR n5 : 824 MHz ~ 849 MHz 5G NR n12 : 699 MHz ~ 716 MHz 5G NR n13 : 777 MHz ~ 787 MHz 5G NR n25 : 1850 MHz ~ 1915 MHz 5G NR n26 : 824 MHz ~ 849 MHz 5G NR n71: 663 MHz ~ 698 MHz
Rx Frequency	5G NR n2 : 1930 MHz ~ 1990 MHz 5G NR n5 : 869 MHz ~ 894 MHz 5G NR n12: 729 MHz ~ 746 MHz 5G NR n13 : 746 MHz ~ 756 MHz 5G NR n25 : 1930 MHz ~ 1995 MHz 5G NR n26 : 869 MHz ~ 894 MHz 5G NR n71: 617 MHz ~ 652 MHz
Bandwidth	n2, n5, n26, n71: 5MHz / 10MHz / 15MHz / 20MHz n12: 5MHz / 10MHz / 15MHz n13: 5MHz / 10MHz n25: 5MHz / 10MHz / 15MHz / 20MHz / 25MHz / 30MHz / 40MHz



SCS	15kHz
Antenna Gain	<p>&lt;Ant. 0&gt;  n2: -2.23 dBi  n5: -1.12 dBi  n12: -2.97 dBi  n13: -2.69 dBi  n25: -2.23 dBi  n26: -1.12 dBi  n71: -2.97 dBi</p> <p>&lt;Ant. 1&gt;  n2: -2.07 dBi  n5: -2.37 dBi  n12: -3.94 dBi  n13: -2.84 dBi  n25: -2.07 dBi  n26: -2.37 dBi  n71: -4.19 dBi</p> <p>&lt;Ant. 2&gt;  n2: -2.43 dBi  n5: -5.87 dBi  n25: -2.43 dBi</p> <p>&lt;Ant. 3&gt;  n2: -3.61 dBi  n25: -3.61 dBi</p>
Type of Modulation	CP-OFDM: QPSK / 16QAM / 64QAM / 256QAM DFT-s-OFDM: PI/2 BPSK / QPSK / 16QAM / 64QAM / 256QAM

Remark:

1. The maximum ERP/EIRP is calculated from output power and antenna gain, only the maximum ERP/EIRP are shown in the report, 5G NR n2 for Ant.3, 5G NR n25 for Ant.2 and 5G NR n5/n12/n13/n26/n71 for Ant. 0.
2. All the supported ENDC combinations are verified conducted power, only the ENDC combination with highest power are shown in the report.
3. 5G NR n2/n5/n12/n25/n71 support SA mode and NSA mode. According to the maximum power between SA and NSA mode, SA covers NSA mode for (n2/n5/n12/n71), NSA covers SA mode for (n25) .
4. 5G NR n13/n26 supports SA mode only.
5. The EN-DC mode combination could be referred to the product spec.
6. The EUT has two working states, flip open state and flip close state, by verifying these two states, we choose the worst flip open state for all tests.

### 1.5 Modification of EUT

No modifications are made to the EUT during all test items.



### 1.6 Specification of Accessory

Specification of Accessory					
AC Adapter	Brand Name	Motorola (Salom)	Model Name	MC-301	
Battery 1	Brand Name	Motorola(ATL)	Model Name	PM29	
Battery 2	Brand Name	Motorola(ATL)	Model Name	PM08	
USB Cable 1	Brand Name	Motorola (Cabletech)	Model Name	SC18D13216	
USB Cable 2	Brand Name	Motorola (Luxshare)	Model Name	SC18D13217	
USB Cable 3	Brand Name	Motorola (Saibao)	Model Name	SC18D86732	

### 1.7 Maximum ERP/EIRP Power and Emission Designator

5G NR n2		PI/2 BPSK / QPSK		16QAM / 64QAM / 256QAM	
BW (MHz)	Frequency Range (MHz)	Maximum EIRP(W)	Emission Designator (99%OBW)	Maximum EIRP(W)	Emission Designator (99%OBW)
5	1852.5 ~ 1907.5	0.0891	4M47G7D	0.0873	4M48W7D
10	1855.0 ~ 1905.0	0.0879	9M26G7D	0.0865	9M28W7D
15	1857.5 ~ 1902.5	0.0861	14M1G7D	0.0857	14M1W7D
20	1860.0 ~ 1900.0	0.0931	18M9G7D	0.0893	18M9W7D

5G NR n25		PI/2 BPSK / QPSK		16QAM / 64QAM / 256QAM	
BW (MHz)	Frequency Range (MHz)	Maximum EIRP(W)	Emission Designator (99%OBW)	Maximum EIRP(W)	Emission Designator (99%OBW)
5	1852.5 ~ 1912.5	0.1211	4M47G7D	0.0897	4M48W7D
10	1855.0 ~ 1910.0	0.1143	9M26G7D	0.0968	9M28W7D
15	1857.5 ~ 1907.5	0.1222	14M1G7D	0.0982	14M1W7D
20	1860.0 ~ 1905.0	0.1216	18M9G7D	0.0979	18M9W7D
25	1862.5 ~ 1902.5	0.1216	23M7G7D	0.1183	23M7W7D
30	1865.0 ~ 1900.0	0.1169	28M6G7D	0.1159	28M6W7D
40	1870.0 ~ 1895.0	0.1236	38M7G7D	0.1197	38M5W7D

5G NR n5		PI/2 BPSK / QPSK		16QAM / 64QAM / 256QAM	
BW (MHz)	Frequency Range (MHz)	Maximum ERP(W)	Emission Designator (99%OBW)	Maximum ERP(W)	Emission Designator (99%OBW)
5	826.5 ~ 846.5	0.0989	4M49G7D	0.0986	4M50W7D
10	829.0 ~ 844.0	0.0998	9M28G7D	0.0986	9M29W7D
15	831.5 ~ 841.5	0.1052	14M1G7D	0.1019	14M1W7D
20	834.0 ~ 839.0	0.1084	18M9G7D	0.1054	18M9W7D



5G NR n26		PI/2 BPSK / QPSK		16QAM / 64QAM / 256QAM	
BW (MHz)	Frequency Range (MHz)	Maximum ERP(W)	Emission Designator (99%OBW)	Maximum ERP(W)	Emission Designator (99%OBW)
5	826.5 ~ 846.5	0.0995	4M49G7D	0.0993	4M50W7D
10	829.0 ~ 844.0	0.1007	9M28G7D	0.1005	9M29W7D
15	831.5 ~ 841.5	0.1072	14M1G7D	0.1069	14M1W7D
20	834.0 ~ 839.0	0.1094	18M9G7D	0.1076	18M9W7D

5G NR n12		PI/2 BPSK / QPSK		16QAM / 64QAM / 256QAM	
BW (MHz)	Frequency Range (MHz)	Maximum ERP(W)	Emission Designator (99%OBW)	Maximum ERP(W)	Emission Designator (99%OBW)
5	701.5 ~ 713.5	0.0653	4M48G7D	0.0594	4M48W7D
10	704.0 ~ 711.0	0.0655	9M26G7D	0.0596	9M28W7D
15	706.5 ~ 708.5	0.0729	14M0G7D	0.0622	14M1W7D

5G NR n13		PI/2 BPSK / QPSK		16QAM / 64QAM / 256QAM	
BW (MHz)	Frequency Range (MHz)	Maximum ERP(W)	Emission Designator (99%OBW)	Maximum ERP(W)	Emission Designator (99%OBW)
5	779.5 ~ 784.5	0.0619	4M49G7D	0.0535	4M50W7D
10	782	0.0679	9M26G7D	0.0590	9M28W7D

5G NR n71		PI/2 BPSK / QPSK		16QAM / 64QAM / 256QAM	
BW (MHz)	Frequency Range (MHz)	Maximum ERP(W)	Emission Designator (99%OBW)	Maximum ERP(W)	Emission Designator (99%OBW)
5	665.5 ~ 695.5	0.0700	4M48G7D	0.0630	4M48W7D
10	668.0 ~ 693.0	0.0708	9M27G7D	0.0644	9M28W7D
15	670.5 ~ 690.5	0.0733	14M1G7D	0.0665	14M1W7D
20	673.0 ~ 688.0	0.0769	18M9G7D	0.0644	18M9W7D

**Note:**

1. 5G NR n26 overlaps the entire frequency range of 5G NR n5. Therefore, the test results provided in this report covers 5G NR n5 and the portion of 5G NR n26 subject to Part 22.
2. 5G NR n25 overlaps the entire frequency range of 5G NR n2. Therefore, the test results provided in this report covers 5G NR n25 as well as 5G NR n2.
3. All modulations have been tested, only the worst test results of PSK & QAM are shown in the report.





### 1.8 Testing Location

Sporton International Inc. (ShenZhen) is accredited to ISO/IEC 17025:2017 by American Association for Laboratory Accreditation with Certificate Number 5145.01.

<b>Test Firm</b>	Sporton International Inc. (ShenZhen)		
<b>Test Site Location</b>	1/F, 2/F, Bldg 5, Shiling Industrial Zone, Xinwei Village, Xili, Nanshan, Shenzhen, 518055 People’s Republic of China TEL: +86-755-86379589 FAX: +86-755-86379595		
<b>Test Site No.</b>	<b>Sporton Site No.</b>	<b>FCC Designation No.</b>	<b>FCC Test Firm Registration No.</b>
	TH01-SZ	CN1256	421272

<b>Test Firm</b>	Sporton International Inc. (ShenZhen)		
<b>Test Site Location</b>	101, 1st Floor, Block B, Building 1, No. 2, Tengfeng 4th Road, Fenghuang Community, Fuyong Street, Baoan District, Shenzhen City Guangdong Province China 518103 TEL: +86-755-33202398		
<b>Test Site No.</b>	<b>Sporton Site No.</b>	<b>FCC Designation No.</b>	<b>FCC Test Firm Registration No.</b>
	03CH01-SZ	CN1256	421272

### 1.9 Test Software

Item	Site	Manufacturer	Name	Version
1.	03CH01-SZ	AUDIX	E3	6.2009-8-24

### 1.10 Applicable Standards

According to the specifications of the manufacturer, the EUT must comply with the requirements of the following standards:

- ♦ 47 CFR Part 2, 22, 24, 27
- ♦ ANSI C63.26-2015
- ♦ FCC KDB 971168 D01 Power Meas License Digital Systems v03r01
- ♦ FCC KDB 412172 D01 Determining ERP and EIRP v01r01

**Remark:**

All test items were verified and recorded according to the standards and without any deviation during the test.



## 2 Test Configuration of Equipment Under Test

### 2.1 Test Mode

Antenna port conducted and radiated test items are performed according to KDB 971168 D01 Power Meas License Digital Systems v03r01 with maximum output power.

For radiated measurement, pre-scanned in three orthogonal panels, X, Y, Z. The worst cases were recorded in this report.(X/Y-plane)

The device is investigated from 30MHz to 10 times of fundamental signal for radiated spurious emission test under different RB size/offset and modulations in exploratory test. Subsequently, only the worst case emissions are reported.

Orthogonal Planes of EUT	X Plane	Y Plane	Z Plane
			

Test Items	5G NR	Bandwidth (MHz)							Modulation					RB #		Test Channel		
		5	10	15	20	25	30	40	PI/2 BPSK	QPSK	16QAM	64QAM	256QAM	1	Full	L	M	H
Max. Output Power	n2	v	v	v	v	-	-	-	v	v	v	v	v	v	v	v	v	v
	n5	v	v	v	v	-	-	-	v	v	v	v	v	v	v	v	v	v
	n12	v	v	v	-	-	-	-	v	v	v	v	v	v	v	v	v	v
	n13	v	v	-	-	-	-	-	v	v	v	v	v	v	v	v	v	v
	n25	v	v	v	v	v	v	v	v	v	v	v	v	v	v	v	v	v
	n26	v	v	v	v	-	-	-	v	v	v	v	v	v	v	v	v	v
	n71	v	v	v	v	-	-	-	v	v	v	v	v	v	v	v	v	v
Peak-to-Average Ratio	n12		v		-	-	-	-	v	v				v	v	v	v	v
	n13	v		-	-	-	-	-	v	v				v	v	v	v	v
	n25				v				v	v				v	v	v	v	v
	n26				v	-	-	-	v	v				v	v	v	v	v
	n71				v	-	-	-	v	v				v	v	v	v	v
26dB and 99% Bandwidth	n12	v	v	v	-	-	-	-	v	v	v	v	v		v		v	
	n13	v	v	-	-	-	-	-	v	v	v	v	v		v		v	
	n25	v	v	v	v	v	v	v	v	v	v	v	v		v		v	
	n26	v	v	v	v	-	-	-	v	v	v	v	v		v		v	
	n71	v	v	v	v	-	-	-	v	v	v	v	v		v		v	



Test Items	5G NR	Bandwidth (MHz)							Modulation					RB #		Test Channel		
		5	10	15	20	25	30	40	PI/2 BPSK	QPSK	16QAM	64QAM	256QAM	1	Full	L	M	H
Conducted Band Edge	n12	v	v	v	-	-	-	-	v	v				v	v	v		v
	n13	v	v	-	-	-	-	-	v	v				v	v	v	v	v
	n25	v			v			v	v	v				v	v	v		v
	n26	v	v		v	-	-	-	v	v				v	v	v		v
	n71	v	v		v	-	-	-	v	v				v	v	v		v
Conducted Spurious Emission	n12	v	v	v	-	-	-	-	v	v				v		v	v	v
	n13	v	v	-	-	-	-	-	v	v				v		v	v	v
	n25	v			v			v	v	v				v		v	v	v
	n26	v	v		v	-	-	-	v	v				v		v	v	v
	n71	v	v		v	-	-	-	v	v				v		v	v	v
Frequency Stability	n12			v	-	-	-	-		v					v		v	
	n13	v		-	-	-	-	-		v					v		v	
	n25				v					v					v		v	
	n26				v	-	-	-		v					v		v	
	n71				v	-	-	-		v					v		v	
E.R.P / E.I.R.P	n2	v	v	v	v	-	-	-	v	v	v	v	v	v	v	v	v	v
	n5	v	v	v	v	-	-	-	v	v	v	v	v	v	v	v	v	v
	n12	v	v	v	-	-	-	-	v	v	v	v	v	v	v	v	v	v
	n13	v	v	-	-	-	-	-	v	v	v	v	v	v	v	v	v	v
	n25	v	v	v	v	v	v	v	v	v	v	v	v	v	v	v	v	v
	n26	v	v	v	v	-	-	-	v	v	v	v	v	v	v	v	v	v
	n71	v	v	v	v	-	-	-	v	v	v	v	v	v	v	v	v	v
Radiated Spurious Emission	n2	Worst Case														v	v	v
	n5	Worst Case														v	v	v
	n12	Worst Case														v	v	v
	n13	Worst Case															v	
	n25	Worst Case														v	v	v
	n26	Worst Case														v	v	v
	n71	Worst Case														v	v	v
Note	1. The mark "v" means that this configuration is chosen for testing 2. The mark "-" means that this bandwidth is not supported. 3. The device is investigated from 30MHz to 10 times of fundamental signal for radiated spurious emission test under different RB size/offset and modulations in exploratory test. Subsequently, only the worst case emissions are reported. 4. Frequency Stability : Normal Voltage = 3.91V ; Low Voltage =3.40V. ; High Voltage =4.50V																	

## 2.2 Connection Diagram of Test System

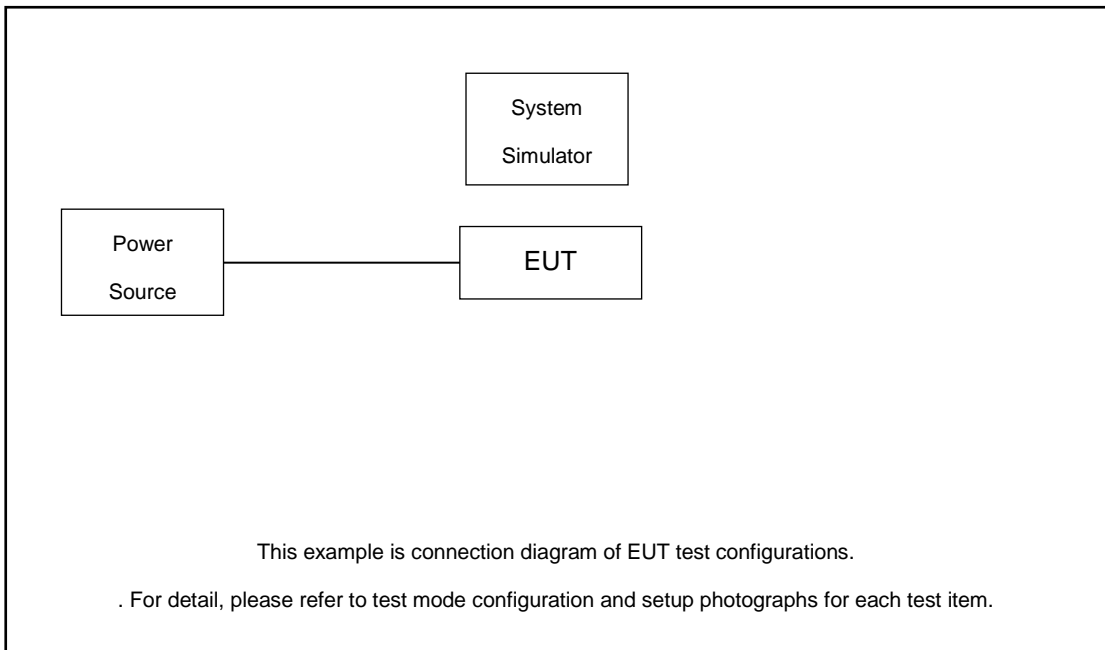

The EUT has been configuration operated in a manner tended to maximize its emission characteristics in a typical application.

## 2.3 Support Unit used in test configuration and system

Item	Equipment	Trade Name	Model No.	FCC ID	Data Cable	Power Cord
1.	DC Power Supply	GW	GPS-3030D	N/A	N/A	Unshielded, 1.8 m
2.	LTE Base Station	Anritsu	MT8821C	N/A	N/A	Unshielded, 1.8 m
3.	NR Base Station	Anritsu	MT8000A	N/A	N/A	Unshielded, 1.8 m

## 2.4 Measurement Results Explanation Example

### For all conducted test items:

The offset level is set in the spectrum analyzer to compensate the RF cable loss and attenuator factor between EUT conducted output port and spectrum analyzer. With the offset compensation, the spectrum analyzer reading level is exactly the EUT RF output level.

The spectrum analyzer offset is derived from RF cable loss and attenuator factor.

*Offset = RF cable loss.*

Following shows an offset computation example with cable loss 7.6 dB.

Example :

$$\begin{aligned} \text{Offset(dB)} &= \text{RF cable loss(dB)} \\ &= 7.6 \text{ (dB)} \end{aligned}$$



### 2.5 Frequency List of Low/Middle/High Channels

5G NR n2 Channel and Frequency List				
BW [MHz]	Channel/Frequency(MHz)	Lowest	Middle	Highest
20	Channel	372000	376000	380000
	Frequency	1860	1880	1900
15	Channel	371500	376000	380500
	Frequency	1857.5	1880	1902.5
10	Channel	371000	376000	381000
	Frequency	1855	1880	1905
5	Channel	370500	376000	381500
	Frequency	1852.5	1880	1907.5

5G NR n5 Channel and Frequency List				
BW [MHz]	Channel/Frequency(MHz)	Lowest	Middle	Highest
20	Channel	166800	167300	167800
	Frequency	834	836.5	839
15	Channel	166300	167300	168300
	Frequency	831.5	836.5	841.5
10	Channel	165800	167300	168800
	Frequency	829	836.5	844
5	Channel	165300	167300	169300
	Frequency	826.5	836.5	846.5

5G NR n12 Channel and Frequency List				
BW [MHz]	Channel/Frequency(MHz)	Lowest	Middle	Highest
15	Channel	141300	141500	141700
	Frequency	706.5	707.5	708.5
10	Channel	140800	141500	142200
	Frequency	704	707.5	711
5	Channel	140300	141500	142700
	Frequency	701.5	707.5	713.5



5G NR n13 Channel and Frequency List				
BW [MHz]	Channel/Frequency(MHz)	Lowest	Middle	Highest
10	Channel	155900	156400	156900
	Frequency	779.5	782	784.5
5	Channel	156400		
	Frequency	782		

5G NR n25 Channel and Frequency List				
BW [MHz]	Channel/Frequency(MHz)	Lowest	Middle	Highest
40	Channel	374000	376500	379000
	Frequency	1870	1882.5	1895
30	Channel	373000	376500	380000
	Frequency	1865	1882.5	1900
25	Channel	372500	376500	380500
	Frequency	1862.5	1882.5	1902.5
20	Channel	372000	376500	381000
	Frequency	1860	1882.5	1905
15	Channel	371500	376500	381500
	Frequency	1857.5	1882.5	1907.5
10	Channel	371000	376500	382000
	Frequency	1855	1882.5	1910
5	Channel	370500	376500	382500
	Frequency	1852.5	1882.5	1912.5

5G NR n26 Channel and Frequency List				
BW [MHz]	Channel/Frequency(MHz)	Lowest	Middle	Highest
20	Channel	175800	176300	176800
	Frequency	834	836.5	839
15	Channel	175300	176300	177300
	Frequency	831.5	836.5	841.5
10	Channel	174800	176300	177800
	Frequency	829	836.5	844
5	Channel	174300	176300	178300
	Frequency	826.5	836.5	846.5



5G NR n71 Channel and Frequency List				
BW [MHz]	Channel/Frequency(MHz)	Lowest	Middle	Highest
20	Channel	134600	136100	137600
	Frequency	673	680.5	688
15	Channel	134100	136100	138100
	Frequency	670.5	680.5	690.5
10	Channel	133600	136100	138600
	Frequency	668	680.5	693
5	Channel	133100	136100	139100
	Frequency	665.5	680.5	695.5

### 3 Conducted Test Items

#### 3.1 Measuring Instruments

See list of measuring instruments of this test report.

#### 3.2 Test Setup

##### 3.2.1 Conducted Output Power



##### 3.2.2 Peak-to-Average Ratio, Occupied Bandwidth ,Conducted Band-Edge and Conducted Spurious Emission



##### 3.2.3 Frequency Stability

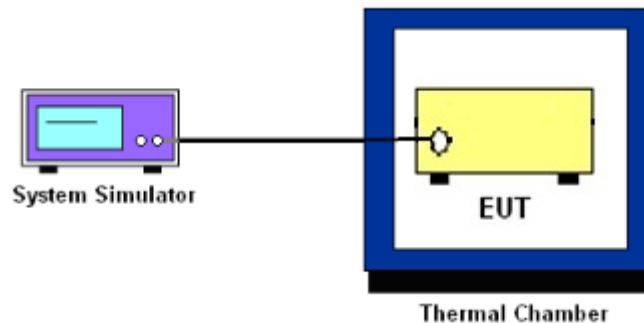

### 3.3 Test Result of Conducted Test

Please refer to Appendix A.





### 3.4 Conducted Output Power and ERP/EIRP

#### 3.4.1 Description of the Conducted Output Power Measurement and ERP/EIRP Measurement

A system simulator was used to establish communication with the EUT. Its parameters were set to force the EUT transmitting at maximum output power. The measured power in the radio frequency on the transmitter output terminals shall be reported.

The ERP of mobile transmitters must not exceed 7 Watts for 5G NR n5, n26.

The ERP of mobile transmitters must not exceed 3 Watts for 5G NR n12, n13, n71.

The EIRP of mobile transmitters must not exceed 2 Watts for 5G NR n2, n25.

According to KDB 412172 D01 Power Approach,

$EIRP = P_T + G_T - L_C$ ,  $ERP = EIRP - 2.15$ , where

$P_T$  = transmitter output power in dBm

$G_T$  = gain of the transmitting antenna in dBi

$L_C$  = signal attenuation in the connecting cable between the transmitter and antenna in dB

#### 3.4.2 Test Procedures

1. The testing follows ANSI C63.26 Section 5.2
2. The transmitter output port was connected to the system simulator.
3. Set EUT at maximum power through the system simulator.
4. Select lowest, middle, and highest channels for each band and different modulation.
5. Measure and record the power level from the system simulator.



## **3.5 Peak-to-Average Ratio**

### **3.5.1 Description of the PAR Measurement**

Power Complementary Cumulative Distribution Function (CCDF) curves provide a means for characterizing the power peaks of a digitally modulated signal on a statistical basis. A CCDF curve depicts the probability of the peak signal amplitude exceeding the average power level. Most contemporary measurement instrumentation include the capability to produce CCDF curves for an input signal provided that the instrument's resolution bandwidth can be set wide enough to accommodate the entire input signal bandwidth. In measuring transmissions in this band using an average power technique, the peak-to-average ratio (PAR) of the transmission may not exceed 13 dB.

### **3.5.2 Test Procedures**

1. The testing follows ANSI C63.26 Section 5.2.3.4 (CCDF).
2. The EUT was connected to spectrum and system simulator via a power divider.
3. Set the CCDF (Complementary Cumulative Distribution Function) option in spectrum analyzer.
4. The highest RF powers were measured and recorded the maximum PAPR level associated with a probability of 0.1 %.
5. Record the deviation as Peak to Average Ratio.



## 3.6 Occupied Bandwidth

### 3.6.1 Description of Occupied Bandwidth Measurement

The occupied bandwidth is the width of a frequency band such that, below the lower and above the upper frequency limits, the mean powers emitted are each equal to a specified percentage 0.5% of the total mean transmitted power.

The 26 dB emission bandwidth is defined as the frequency range between two points, one above and one below the carrier frequency, at which the spectral density of the emission is attenuated 26 dB below the maximum in-band spectral density of the modulated signal. Spectral density (power per unit bandwidth) is to be measured with a detector of resolution bandwidth equal to approximately 1.0% of the emission bandwidth.

### 3.6.2 Test Procedures

1. The testing follows ANSI C63.26 Section 5.4
2. The EUT was connected to spectrum analyzer and system simulator via a power divider.
3. The spectrum analyzer center frequency is set to the nominal EUT channel center frequency. The span range for the spectrum analyzer shall be between two and five times the anticipated OBW.
4. The nominal resolution bandwidth (RBW) shall be in the range of 1 to 5 % of the anticipated OBW, and the VBW shall be at least 3 times the RBW.
5. Set the detection mode to peak, and the trace mode to max hold.
6. Determine the reference value: Set the EUT to transmit a modulated signal. Allow the trace to stabilize. Set the spectrum analyzer marker to the highest level of the displayed trace.  
(this is the reference value)
7. Determine the “-26 dB down amplitude” as equal to (Reference Value – X).
8. Place two markers, one at the lowest and the other at the highest frequency of the envelope of the spectral display such that each marker is at or slightly below the “-X dB down amplitude” determined in step 6. If a marker is below this “-X dB down amplitude” value it shall be placed as close as possible to this value. The OBW is the positive frequency difference between the two markers.
9. Use the 99 % power bandwidth function of the spectrum analyzer and report the measured bandwidth.



### 3.7 Conducted Band Edge

#### 3.7.1 Description of Conducted Band Edge Measurement

22.917(a)

For operations in the 824 – 849 MHz band, the FCC limit is  $43 + 10\log_{10}(P[\text{Watts}])$  dB below the transmitter power  $P(\text{Watts})$  in a 100kHz bandwidth. However, in the 1MHz bands immediately outside and adjacent to the licensee's frequency block, a resolution bandwidth of at least one percent of the emission bandwidth of the fundamental emission of the transmitter may be employed.

24.238 (a)

For operations in the 1850-1910 and 1930-1990 MHz band, the FCC limit is  $43 + 10\log_{10}(P[\text{Watts}])$  dB below the transmitter power  $P(\text{Watts})$  in a 1MHz bandwidth. However, in the 1 MHz bands immediately outside and adjacent to the frequency block a resolution bandwidth of at least one percent of the emission bandwidth of the fundamental emission of the transmitter may be employed.

27.53 (c)

For operations in the 776-788 MHz band, the FCC limit is  $43 + 10\log_{10}(P[\text{Watts}])$  dB below the transmitter power  $P(\text{Watts})$  in a 100 kHz bandwidth. However, in the 100 kHz bands immediately outside and adjacent to the frequency block, a resolution bandwidth of at least 30 kHz may be employed. In addition, the power of any unwanted emissions in any 6.25 kHz bandwidth for all frequencies between 763-775 MHz and 793-806 MHz shall be attenuated below the transmitter power,  $P$  (dBW), by at least  $65 + 10 \log_{10} p(\text{watts})$ , dB, for mobile and portable equipment.

27.53 (g)

For operations in the 600MHz band and 698 -746 MHz band, the FCC limit is  $43 + 10\log_{10}(P[\text{Watts}])$  dB below the transmitter power  $P(\text{Watts})$  in a 100 kHz bandwidth. However, in the 100 kilohertz bands immediately outside and adjacent to a licensee's frequency block, a resolution bandwidth of at least 30 kHz may be employed.



### **3.7.2 Test Procedures**

1. The testing follows ANSI C63.26 section 5.7
2. The EUT was connected to spectrum analyzer and system simulator via a power divider.
3. The band edges of low and high channels for the highest RF powers were measured.
4. Set RBW  $\geq$  1% EBW in the 1MHz band immediately outside and adjacent to the band edge.
5. Beyond the 1 MHz band from the band edge, RBW=1MHz was used or a narrower RBW was used (generally limited to no less than 1% of the OBW) and the measured power was integrated over the full required measurement bandwidth.
6. Set spectrum analyzer with RMS detector.
7. The RF fundamental frequency should be excluded against the limit line in the operating frequency band.
8. Checked that all the results comply with the emission limit line.

Example:

The limit line is derived from  $43 + 10\log(P)$ dB below the transmitter power P(Watts)

$$= P(W) - [43 + 10\log(P)] \text{ (dB)}$$

$$= [30 + 10\log(P)] \text{ (dBm)} - [43 + 10\log(P)] \text{ (dB)} = -13\text{dBm.}$$

9. When using the integration method, the starting frequency of the integration shall be centered at one-half of the RBW away from the band edge.



### 3.8 Conducted Spurious Emission

#### 3.8.1 Description of Conducted Spurious Emission Measurement

The power of any emission outside of the authorized operating frequency ranges must be lower than the transmitter power (P) by a factor of at least  $43 + 10 \log (P)$  dB.

It is measured by means of a calibrated spectrum analyzer and scanned from 30 MHz up to a frequency including its 10<sup>th</sup> harmonic.

#### 3.8.2 Test Procedures

1. The testing follows ANSI C63.26 section 5.7
2. The EUT was connected to spectrum analyzer and system simulator via a power divider.
3. The RF output of EUT was connected to the spectrum analyzer by RF cable and attenuator. The path loss was compensated to the results for each measurement.
4. The middle channel for the highest RF power within the transmitting frequency was measured.
5. The conducted spurious emission for the whole frequency range was taken.
6. Make the measurement with the spectrum analyzer's RBW = 1MHz, VBW = 3MHz.
7. Set spectrum analyzer with RMS detector.
8. Taking the record of maximum spurious emission.
9. The RF fundamental frequency should be excluded against the limit line in the operating frequency band.
10. The limit line is derived from  $43 + 10\log(P)$ dB below the transmitter power P(Watts)  
= P(W)- [43 + 10log(P)] (dB)  
= [30 + 10log(P)] (dBm) - [43 + 10log(P)] (dB)  
= -13dBm.



## 3.9 Frequency Stability

### 3.9.1 Description of Frequency Stability Measurement

The frequency stability shall be measured by variation of ambient temperature and variation of primary supply voltage to ensure that the fundamental emission stays within the authorized frequency block. The frequency stability of the transmitter shall be maintained within  $\pm 0.00025\%$  ( $\pm 2.5\text{ppm}$ ) of the center frequency.

### 3.9.2 Test Procedures for Temperature Variation

1. The testing follows ANSI C63.26 section 5.6.4
2. The EUT was set up in the thermal chamber and connected with the system simulator.
3. With power OFF, the temperature was decreased to  $-30^{\circ}\text{C}$  and the EUT was stabilized before testing. Power was applied and the maximum change in frequency was recorded within one minute.
4. With power OFF, the temperature was raised in  $10^{\circ}\text{C}$  step up to  $50^{\circ}\text{C}$ . The EUT was stabilized at each step for at least half an hour. Power was applied and the maximum frequency change was recorded within one minute.

### 3.9.3 Test Procedures for Voltage Variation

1. The testing follows ANSI C63.26 section 5.6.5
2. The EUT was placed in a temperature chamber at  $20\pm 5^{\circ}\text{C}$  and connected with the system simulator.
3. The power supply voltage to the EUT was varied from 85% to 115% of the nominal value for other than hand carried battery equipment.
4. For hand carried, battery powered equipment, reduce the primary ac or dc supply voltage to the battery operating end point, which shall be specified by the manufacturer.
5. The variation in frequency was measured for the worst case.

## 4 Radiated Test Items

### 4.1 Measuring Instruments

See list of measuring instruments of this test report.

### 4.2 Test Setup

#### 4.2.1 For radiated test below 30MHz

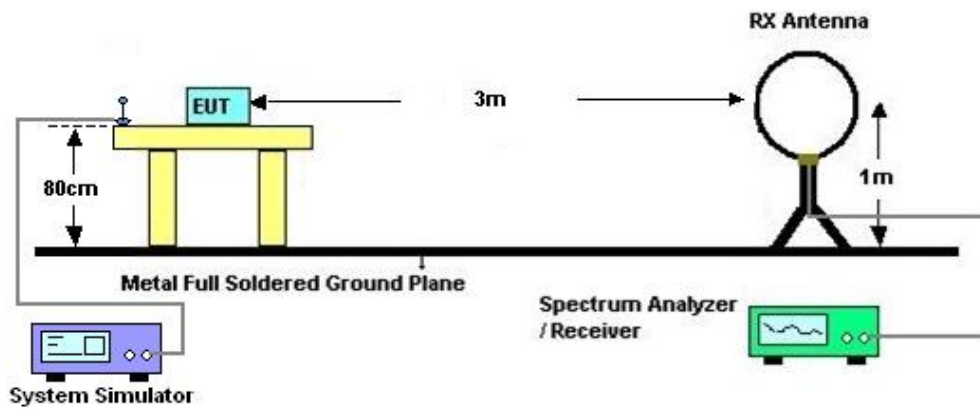

#### 4.2.2 For radiated test from 30MHz to 1GHz

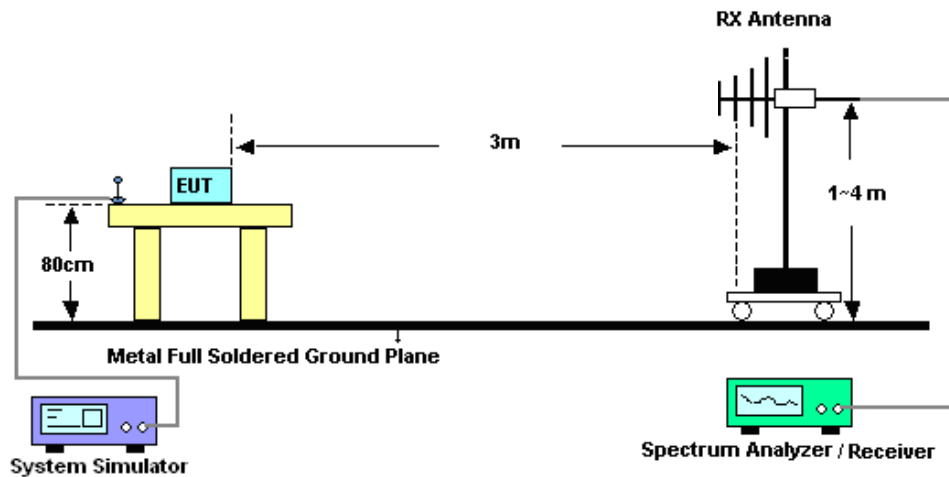



#### 4.2.3 For radiated test above 1GHz

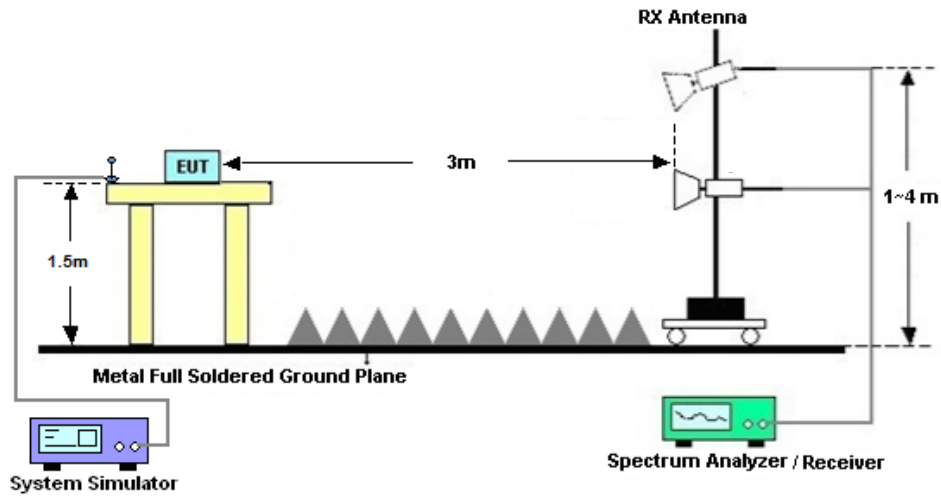

#### 4.3 Test Result of Radiated Test

The low frequency, which started from 9 kHz to 30MHz, was pre-scanned and the result which was 20dB lower than the limit line was not reported.

Please refer to Appendix B.



## 4.4 Radiated Spurious Emission

### 4.4.1 Description of Radiated Spurious Emission

The radiated spurious emission was measured by substitution method according to ANSI C63.26. The power of any emission outside of the authorized operating frequency ranges must be attenuated below the transmitter power (P) by a factor of at least  $43 + 10 \log (P)$  dB.

For 5G NR n13

For operations in the 746-758 MHz, 775-788 MHz, and 805-806 MHz bands, emissions in the band 1559-1610 MHz shall be limited to  $-70$  dBW/MHz equivalent isotropically radiated power (EIRP) for wideband signals, and  $-80$  dBW EIRP for discrete emissions of less than 700 Hz bandwidth.

The spectrum is scanned from 30 MHz up to a frequency including its 10th harmonic.

### 4.4.2 Test Procedures

1. The testing follows ANSI C63.26 Section 5.5
2. The EUT was placed on a turntable with 0.8 meter height for frequency below 1GHz and 1.5 meter height for frequency above 1GHz respectively above ground.
3. The EUT was set 3 meters from the receiving antenna mounted on the antenna tower.
4. The table was rotated 360 degrees to determine the position of the highest spurious emission.
5. The height of the receiving antenna is varied between 1m to 4m to search the maximum spurious emission for both horizontal and vertical polarizations.
6. During the measurement, the system simulator parameters were set to force the EUT transmitting at maximum output power.
7. Make the measurement with the spectrum analyzer's RBW = 1MHz, VBW = 3MHz, taking the record of maximum spurious emission.
8. A horn antenna was substituted in place of the EUT and was driven by a signal generator.
9. Tune the output power of signal generator to the same emission level with EUT maximum spurious emission.
10.  $EIRP (dBm) = S.G. Power - Tx Cable Loss + Tx Antenna Gain$
11.  $ERP (dBm) = EIRP - 2.15$
12. The RF fundamental frequency should be excluded against the limit line in the operating frequency band.

The limit line is derived from  $43 + 10\log(P)$ dB below the transmitter power P(Watts)  
 $= P(W) - [43 + 10\log(P)] (dB)$   
 $= [30 + 10\log(P)] (dBm) - [43 + 10\log(P)] (dB)$   
 $= -13dBm.$



## 5 List of Measuring Equipment

Instrument	Manufacturer	Model No.	Serial No.	Characteristics	Calibration Date	Test Date	Due Date	Remark
EMI Test Receiver&SA	Agilent	N9038A	MY52260185	20Hz~26.5GHz	Dec. 27, 2021	Dec. 22, 2022~Jan. 10, 2023	Dec. 26, 2022	Conducted (TH01-SZ)
EMI Test Receiver&SA	Agilent	N9038A	MY52260185	20Hz~26.5GHz	Dec. 26, 2022		Dec. 25, 2023	Conducted (TH01-SZ)
Power Divider	TOJOIN	PS-2SM-04 265	60.06.020.007 7	0.4GHz~26.5GHz	Dec. 26, 2021	Dec. 22, 2022~Jan. 10, 2023	Dec. 25, 2022	Conducted (TH01-SZ)
Power Divider	TOJOIN	PS-2SM-04 265	60.06.020.007 7	0.4GHz~26.5GHz	Dec. 25, 2022		Dec. 24, 2023	Conducted (TH01-SZ)
Thermal Chamber	Ten Billion Hongzhangroup	LP-150U	H2014081803	-40~+150°C	Jul. 07, 2022	Dec. 22, 2022~Jan. 10, 2023	Jul. 06, 2023	Conducted (TH01-SZ)
EMI Test Receiver&SA	Agilent	N9038A	MY52260185	20Hz~26.5GHz	Dec. 26, 2022	Jan. 12, 2023	Dec. 25, 2023	Radiation (03CH01-SZ)
Loop Antenna	R&S	HFH2-Z2	100354	9kHz~30MHz	Jul. 28, 2022	Jan. 12, 2023	Jul. 27, 2024	Radiation (03CH01-SZ)
HF Amplifier	KEYSIGHT	83017A	MY53270105	0.5GHz~26.5Ghz	Oct. 19, 2022	Jan. 12, 2023	Oct. 18, 2023	Radiation (03CH01-SZ)
Bilog Antenna	TeseQ	CBL6112D	35407	30MHz-2GHz	Sep. 28, 2022	Jan. 12, 2023	Sep. 27, 2023	Radiation (03CH01-SZ)
Double Ridge Horn Antenna	ETS-Lindgren	3117	00119436	1GHz~18GHz	Jul. 07, 2022	Jan. 12, 2023	Jul. 06, 2023	Radiation (03CH01-SZ)
SHF-EHF Horn	com-power	AH-840	101071	18Ghz-40GHz	Apr. 10, 2022	Jan. 12, 2023	Apr. 09, 2023	Radiation (03CH01-SZ)
LF Amplifier	Burgeon	BPA-530	102209	0.01~3000Mhz	Apr. 06, 2022	Jan. 12, 2023	Apr. 05, 2023	Radiation (03CH01-SZ)
HF Amplifier	MITEQ	AMF-7D-00 101800-30-1 0P-R	1943528	1GHz~18GHz	Oct. 19, 2022	Jan. 12, 2023	Oct. 18, 2023	Radiation (03CH01-SZ)
HF Amplifier	MITEQ	TTA1840-35 -HG	1871923	18GHz~40GHz	Jul. 06, 2022	Jan. 12, 2023	Jul. 05, 2023	Radiation (03CH01-SZ)
AC Power Source	Chroma	61601	616010001985	N/A	Nov. 10, 2022	Jan. 12, 2023	Nov. 09, 2023	Radiation (03CH01-SZ)
Turn Table	EM	EM1000	N/A	0~360 degree	NCR	Jan. 12, 2023	NCR	Radiation (03CH01-SZ)
Antenna Mast	EM	EM1000	N/A	1 m~4 m	NCR	Jan. 12, 2023	NCR	Radiation (03CH01-SZ)

NCR: No Calibration Required



## 6 Uncertainty of Evaluation

The measurement uncertainties shown below were calculated in accordance with the requirements of ANSI 63.26-2015. All the measurement uncertainty value were shown with a coverage K=2 to indicate 95% level of confidence. The measurement data show herein meets or exceeds the CISPR measurement uncertainty values specified in CISPR 16-4-2 and can be compared directly to specified limit to determine compliance.

### Uncertainty of Conducted Measurement

Test Item	Uncertainty
Conducted Power	±1.34 dB
Conducted Emissions	±1.34 dB
Occupied Channel Bandwidth	±0.13 %

### Uncertainty of Radiated Emission Measurement (30 MHz ~ 1000 MHz)

Measuring Uncertainty for a Level of Confidence of 95% (U = 2Uc(y))	2.48 dB
---	---------

### Uncertainty of Radiated Emission Measurement (1 GHz ~ 18 GHz)

Measuring Uncertainty for a Level of Confidence of 95% (U = 2Uc(y))	3.53 dB
---	---------

### Uncertainty of Radiated Emission Measurement (18 GHz ~ 40 GHz)

Measuring Uncertainty for a Level of Confidence of 95% (U = 2Uc(y))	4.02 dB
---	---------

----- THE END -----



## Appendix A. Test Results of Conducted Test

Test Engineer :	Jung Kuo	Temperature :	22~23°C
		Relative Humidity :	40~42%

# FR1 N2(ANT3)

## Transmitter Conducted Output Power and EIRP, (G<sub>T</sub> - L<sub>C</sub>)=-3.61dB

NR Band	SCS (kHz)	Bandwidth (MHz)	Arfcn	Freq (MHz)	Modulation	RB	Conducted Power (dBm)	EIRP (dBm)	EIRP (W)
2	15	5	370500	1852.5	DFT-s-OFDM QPSK	1@1	23.11	19.5	0.0891
2	15	5	370500	1852.5	DFT-s-OFDM 16 QAM	1@1	23.02	19.41	0.0873
2	15	5	376000	1880	DFT-s-OFDM QPSK	1@1	22.99	19.38	0.0867
2	15	5	376000	1880	DFT-s-OFDM 16 QAM	1@1	22.85	19.24	0.0839
2	15	5	381500	1907.5	DFT-s-OFDM QPSK	1@1	22.87	19.26	0.0843
2	15	5	381500	1907.5	DFT-s-OFDM 16 QAM	1@1	22.86	19.25	0.0841
2	15	10	371000	1855	DFT-s-OFDM QPSK	1@1	23.05	19.44	0.0879
2	15	10	371000	1855	DFT-s-OFDM 16 QAM	1@1	22.98	19.37	0.0865
2	15	10	376000	1880	DFT-s-OFDM QPSK	1@1	22.87	19.26	0.0843
2	15	10	376000	1880	DFT-s-OFDM 16 QAM	1@1	22.86	19.25	0.0841
2	15	10	381000	1905	DFT-s-OFDM QPSK	1@1	22.92	19.31	0.0853
2	15	10	381000	1905	DFT-s-OFDM 16 QAM	1@1	22.9	19.29	0.0849
2	15	15	371500	1857.5	DFT-s-OFDM QPSK	1@1	22.96	19.35	0.0861
2	15	15	371500	1857.5	DFT-s-OFDM 16 QAM	1@1	22.94	19.33	0.0857
2	15	15	376000	1880	DFT-s-OFDM QPSK	1@1	22.94	19.33	0.0857
2	15	15	376000	1880	DFT-s-OFDM 16 QAM	1@1	22.93	19.32	0.0855
2	15	15	380500	1902.5	DFT-s-OFDM QPSK	1@1	22.87	19.26	0.0843
2	15	15	380500	1902.5	DFT-s-OFDM 16 QAM	1@1	22.86	19.25	0.0841
2	15	20	372000	1860	DFT-s-OFDM PI/2 BPSK	50@25	23.11	19.5	0.0891
2	15	20	372000	1860	DFT-s-OFDM PI/2 BPSK	1@1	23.06	19.45	0.0881
2	15	20	372000	1860	DFT-s-OFDM PI/2 BPSK	1@104	23.02	19.41	0.0873
2	15	20	372000	1860	DFT-s-OFDM QPSK	50@25	23.14	19.53	0.0897
2	15	20	372000	1860	DFT-s-OFDM QPSK	1@1	23.18	19.57	0.0906
2	15	20	372000	1860	DFT-s-OFDM QPSK	1@104	23.3	19.69	0.0931
2	15	20	372000	1860	DFT-s-OFDM 16 QAM	50@25	23.11	19.5	0.0891
2	15	20	372000	1860	DFT-s-OFDM 16 QAM	1@1	23.12	19.51	0.0893
2	15	20	372000	1860	DFT-s-OFDM 16 QAM	1@104	23.08	19.47	0.0885
2	15	20	372000	1860	DFT-s-OFDM 64 QAM	50@25	22.56	18.95	0.0785
2	15	20	372000	1860	DFT-s-OFDM 64 QAM	1@1	22.83	19.22	0.0836
2	15	20	372000	1860	DFT-s-OFDM 64 QAM	1@104	22.58	18.97	0.0789
2	15	20	372000	1860	DFT-s-OFDM 256 QAM	50@25	21.27	17.66	0.0583
2	15	20	372000	1860	DFT-s-OFDM 256 QAM	1@1	21.62	18.01	0.0632
2	15	20	372000	1860	DFT-s-OFDM 256 QAM	1@104	21.57	17.96	0.0625
2	15	20	372000	1860	CP-OFDM QPSK	53@26	23.09	19.48	0.0887
2	15	20	372000	1860	CP-OFDM QPSK	1@1	23.1	19.49	0.0889
2	15	20	372000	1860	CP-OFDM QPSK	1@104	23.14	19.53	0.0897

2	15	20	376000	1880	DFT-s-OFDM PI/2 BPSK	50@25	22.99	19.38	0.0867
2	15	20	376000	1880	DFT-s-OFDM PI/2 BPSK	1@1	23.05	19.44	0.0879
2	15	20	376000	1880	DFT-s-OFDM PI/2 BPSK	1@104	22.95	19.34	0.0859
2	15	20	376000	1880	DFT-s-OFDM QPSK	50@25	23.03	19.42	0.0875
2	15	20	376000	1880	DFT-s-OFDM QPSK	1@1	23.09	19.48	0.0887
2	15	20	376000	1880	DFT-s-OFDM QPSK	1@104	23.08	19.47	0.0885
2	15	20	376000	1880	DFT-s-OFDM 16 QAM	50@25	23	19.39	0.0869
2	15	20	376000	1880	DFT-s-OFDM 16 QAM	1@1	23.02	19.41	0.0873
2	15	20	376000	1880	DFT-s-OFDM 16 QAM	1@104	23.05	19.44	0.0879
2	15	20	376000	1880	DFT-s-OFDM 64 QAM	50@25	22	18.39	0.0690
2	15	20	376000	1880	DFT-s-OFDM 64 QAM	1@1	22.38	18.77	0.0753
2	15	20	376000	1880	DFT-s-OFDM 64 QAM	1@104	22.22	18.61	0.0726
2	15	20	376000	1880	DFT-s-OFDM 256 QAM	50@25	20.82	17.21	0.0526
2	15	20	376000	1880	DFT-s-OFDM 256 QAM	1@1	20.91	17.3	0.0537
2	15	20	376000	1880	DFT-s-OFDM 256 QAM	1@104	20.67	17.06	0.0508
2	15	20	376000	1880	CP-OFDM QPSK	53@26	23.06	19.45	0.0881
2	15	20	376000	1880	CP-OFDM QPSK	1@1	22.88	19.27	0.0845
2	15	20	376000	1880	CP-OFDM QPSK	1@104	22.37	18.76	0.0752
2	15	20	380000	1900	DFT-s-OFDM PI/2 BPSK	50@25	23.02	19.41	0.0873
2	15	20	380000	1900	DFT-s-OFDM PI/2 BPSK	1@1	23.01	19.4	0.0871
2	15	20	380000	1900	DFT-s-OFDM PI/2 BPSK	1@104	22.98	19.37	0.0865
2	15	20	380000	1900	DFT-s-OFDM QPSK	50@25	23.07	19.46	0.0883
2	15	20	380000	1900	DFT-s-OFDM QPSK	1@1	23.09	19.48	0.0887
2	15	20	380000	1900	DFT-s-OFDM QPSK	1@104	23.27	19.66	0.0925
2	15	20	380000	1900	DFT-s-OFDM 16 QAM	50@25	23.05	19.44	0.0879
2	15	20	380000	1900	DFT-s-OFDM 16 QAM	1@1	23.01	19.4	0.0871
2	15	20	380000	1900	DFT-s-OFDM 16 QAM	1@104	23.09	19.48	0.0887
2	15	20	380000	1900	DFT-s-OFDM 64 QAM	50@25	22.51	18.9	0.0776
2	15	20	380000	1900	DFT-s-OFDM 64 QAM	1@1	22.61	19	0.0794
2	15	20	380000	1900	DFT-s-OFDM 64 QAM	1@104	22.69	19.08	0.0809
2	15	20	380000	1900	DFT-s-OFDM 256 QAM	50@25	21.04	17.43	0.0553
2	15	20	380000	1900	DFT-s-OFDM 256 QAM	1@1	21.57	17.96	0.0625
2	15	20	380000	1900	DFT-s-OFDM 256 QAM	1@104	21.54	17.93	0.0621
2	15	20	380000	1900	CP-OFDM QPSK	53@26	23.01	19.4	0.0871
2	15	20	380000	1900	CP-OFDM QPSK	1@1	23.07	19.46	0.0883
2	15	20	380000	1900	CP-OFDM QPSK	1@104	22.81	19.2	0.0832

# FR1 N5(ANT0)

## Transmitter Conducted Output Power and ERP, (G<sub>T</sub> - L<sub>C</sub>)=-1.12dB

NR Band	SCS (kHz)	Bandwidth (MHz)	Arfcn	Freq (MHz)	Modulation	RB	Conducted Power (dBm)	ERP (dBm)	ERP (W)
5	15	5	165300	826.5	DFT-s-OFDM QPSK	1@1	23.22	19.95	0.0989
5	15	5	165300	826.5	DFT-s-OFDM 16 QAM	1@1	23.21	19.94	0.0986
5	15	5	167300	836.5	DFT-s-OFDM QPSK	1@1	23.1	19.83	0.0962
5	15	5	167300	836.5	DFT-s-OFDM 16 QAM	1@1	23.09	19.82	0.0959
5	15	5	169300	846.5	DFT-s-OFDM QPSK	1@1	22.89	19.62	0.0916
5	15	5	169300	846.5	DFT-s-OFDM 16 QAM	1@1	22.88	19.61	0.0914
5	15	10	165800	829	DFT-s-OFDM QPSK	1@1	23.26	19.99	0.0998
5	15	10	165800	829	DFT-s-OFDM 16 QAM	1@1	23.21	19.94	0.0986
5	15	10	167300	836.5	DFT-s-OFDM QPSK	1@1	23.21	19.94	0.0986
5	15	10	167300	836.5	DFT-s-OFDM 16 QAM	1@1	23.18	19.91	0.0979
5	15	10	168800	844	DFT-s-OFDM QPSK	1@1	23.21	19.94	0.0986
5	15	10	168800	844	DFT-s-OFDM 16 QAM	1@1	23.2	19.93	0.0984
5	15	15	166300	831.5	DFT-s-OFDM QPSK	1@1	23.48	20.21	0.1050
5	15	15	166300	831.5	DFT-s-OFDM 16 QAM	1@1	23.35	20.08	0.1019
5	15	15	167300	836.5	DFT-s-OFDM QPSK	1@1	23.49	20.22	0.1052
5	15	15	167300	836.5	DFT-s-OFDM 16 QAM	1@1	23.3	20.03	0.1007
5	15	15	168300	841.5	DFT-s-OFDM QPSK	1@1	23.41	20.14	0.1033
5	15	15	168300	841.5	DFT-s-OFDM 16 QAM	1@1	23.3	20.03	0.1007
5	15	20	166800	834	DFT-s-OFDM PI/2 BPSK	50@25	23.21	19.94	0.0986
5	15	20	166800	834	DFT-s-OFDM PI/2 BPSK	1@1	23.31	20.04	0.1009
5	15	20	166800	834	DFT-s-OFDM PI/2 BPSK	1@104	22.93	19.66	0.0925
5	15	20	166800	834	DFT-s-OFDM QPSK	50@25	23.21	19.94	0.0986
5	15	20	166800	834	DFT-s-OFDM QPSK	1@1	23.62	20.35	0.1084
5	15	20	166800	834	DFT-s-OFDM QPSK	1@104	23.09	19.82	0.0959
5	15	20	166800	834	DFT-s-OFDM 16 QAM	50@25	23.22	19.95	0.0989
5	15	20	166800	834	DFT-s-OFDM 16 QAM	1@1	23.5	20.23	0.1054
5	15	20	166800	834	DFT-s-OFDM 16 QAM	1@104	23.2	19.93	0.0984
5	15	20	166800	834	DFT-s-OFDM 64 QAM	50@25	23.37	20.1	0.1023
5	15	20	166800	834	DFT-s-OFDM 64 QAM	1@1	23.49	20.22	0.1052
5	15	20	166800	834	DFT-s-OFDM 64 QAM	1@104	23.21	19.94	0.0986
5	15	20	166800	834	DFT-s-OFDM 256 QAM	50@25	21.97	18.7	0.0741
5	15	20	166800	834	DFT-s-OFDM 256 QAM	1@1	21.95	18.68	0.0738
5	15	20	166800	834	DFT-s-OFDM 256 QAM	1@104	21.61	18.34	0.0682
5	15	20	166800	834	CP-OFDM QPSK	53@26	23.22	19.95	0.0989
5	15	20	166800	834	CP-OFDM QPSK	1@1	23.34	20.07	0.1016
5	15	20	166800	834	CP-OFDM QPSK	1@104	22.56	19.29	0.0849



5	15	20	167300	836.5	DFT-s-OFDM PI/2 BPSK	50@25	23.27	20	0.1000
5	15	20	167300	836.5	DFT-s-OFDM PI/2 BPSK	1@1	23.23	19.96	0.0991
5	15	20	167300	836.5	DFT-s-OFDM PI/2 BPSK	1@104	22.81	19.54	0.0899
5	15	20	167300	836.5	DFT-s-OFDM QPSK	50@25	23.23	19.96	0.0991
5	15	20	167300	836.5	DFT-s-OFDM QPSK	1@1	23.56	20.29	0.1069
5	15	20	167300	836.5	DFT-s-OFDM QPSK	1@104	22.99	19.72	0.0938
5	15	20	167300	836.5	DFT-s-OFDM 16 QAM	50@25	23.18	19.91	0.0979
5	15	20	167300	836.5	DFT-s-OFDM 16 QAM	1@1	23.5	20.23	0.1054
5	15	20	167300	836.5	DFT-s-OFDM 16 QAM	1@104	23.18	19.91	0.0979
5	15	20	167300	836.5	DFT-s-OFDM 64 QAM	50@25	23.33	20.06	0.1014
5	15	20	167300	836.5	DFT-s-OFDM 64 QAM	1@1	23.27	20	0.1000
5	15	20	167300	836.5	DFT-s-OFDM 64 QAM	1@104	22.9	19.63	0.0918
5	15	20	167300	836.5	DFT-s-OFDM 256 QAM	50@25	21.96	18.69	0.0740
5	15	20	167300	836.5	DFT-s-OFDM 256 QAM	1@1	21.94	18.67	0.0736
5	15	20	167300	836.5	DFT-s-OFDM 256 QAM	1@104	21.56	18.29	0.0675
5	15	20	167300	836.5	CP-OFDM QPSK	53@26	23.14	19.87	0.0971
5	15	20	167300	836.5	CP-OFDM QPSK	1@1	23.24	19.97	0.0993
5	15	20	167300	836.5	CP-OFDM QPSK	1@104	22.53	19.26	0.0843
5	15	20	167800	839	DFT-s-OFDM PI/2 BPSK	50@25	23.29	20.02	0.1005
5	15	20	167800	839	DFT-s-OFDM PI/2 BPSK	1@1	23.16	19.89	0.0975
5	15	20	167800	839	DFT-s-OFDM PI/2 BPSK	1@104	22.79	19.52	0.0895
5	15	20	167800	839	DFT-s-OFDM QPSK	50@25	23.15	19.88	0.0973
5	15	20	167800	839	DFT-s-OFDM QPSK	1@1	23.46	20.19	0.1045
5	15	20	167800	839	DFT-s-OFDM QPSK	1@104	22.93	19.66	0.0925
5	15	20	167800	839	DFT-s-OFDM 16 QAM	50@25	23.16	19.89	0.0975
5	15	20	167800	839	DFT-s-OFDM 16 QAM	1@1	23.45	20.18	0.1042
5	15	20	167800	839	DFT-s-OFDM 16 QAM	1@104	23.15	19.88	0.0973
5	15	20	167800	839	DFT-s-OFDM 64 QAM	50@25	23.3	20.03	0.1007
5	15	20	167800	839	DFT-s-OFDM 64 QAM	1@1	23.4	20.13	0.1030
5	15	20	167800	839	DFT-s-OFDM 64 QAM	1@104	23.04	19.77	0.0948
5	15	20	167800	839	DFT-s-OFDM 256 QAM	50@25	21.95	18.68	0.0738
5	15	20	167800	839	DFT-s-OFDM 256 QAM	1@1	21.86	18.59	0.0723
5	15	20	167800	839	DFT-s-OFDM 256 QAM	1@104	21.54	18.27	0.0671
5	15	20	167800	839	CP-OFDM QPSK	53@26	23.17	19.9	0.0977
5	15	20	167800	839	CP-OFDM QPSK	1@1	23.28	20.01	0.1002
5	15	20	167800	839	CP-OFDM QPSK	1@104	22.97	19.7	0.0933

# FR1 N12(ANT0)

## Transmitter Conducted Output Power and ERP, ( $G_T - L_C$ )=-2.97dB

NR Band	SCS (kHz)	Bandwidth (MHz)	Arfcn	Freq (MHz)	Modulation	RB	Conducted Power (dBm)	ERP (dBm)	ERP (W)
12	15	5	140300	701.5	DFT-s-OFDM QPSK	1@1	23.27	18.15	0.0653
12	15	5	140300	701.5	DFT-s-OFDM 16 QAM	1@1	22.86	17.74	0.0594
12	15	5	141500	707.5	DFT-s-OFDM QPSK	1@1	23.14	18.02	0.0634
12	15	5	141500	707.5	DFT-s-OFDM 16 QAM	1@1	22.73	17.61	0.0577
12	15	5	142700	713.5	DFT-s-OFDM QPSK	1@1	22.94	17.82	0.0605
12	15	5	142700	713.5	DFT-s-OFDM 16 QAM	1@1	22.53	17.41	0.0551
12	15	10	140800	704.0	DFT-s-OFDM QPSK	1@1	23.28	18.16	0.0655
12	15	10	140800	704.0	DFT-s-OFDM 16 QAM	1@1	22.87	17.75	0.0596
12	15	10	141500	707.5	DFT-s-OFDM QPSK	1@1	23.26	18.14	0.0652
12	15	10	141500	707.5	DFT-s-OFDM 16 QAM	1@1	22.85	17.73	0.0593
12	15	10	142200	711.0	DFT-s-OFDM QPSK	1@1	23.21	18.09	0.0644
12	15	10	142200	711.0	DFT-s-OFDM 16 QAM	1@1	22.8	17.68	0.0586
12	15	15	141300	706.5	DFT-s-OFDM PI/2 BPSK	36@18	23.17	18.05	0.0638
12	15	15	141300	706.5	DFT-s-OFDM PI/2 BPSK	1@1	23.16	18.04	0.0637
12	15	15	141300	706.5	DFT-s-OFDM PI/2 BPSK	1@77	22.88	17.76	0.0597
12	15	15	141300	706.5	DFT-s-OFDM QPSK	36@18	22.87	17.75	0.0596
12	15	15	141300	706.5	DFT-s-OFDM QPSK	1@1	23.57	18.45	0.0700
12	15	15	141300	706.5	DFT-s-OFDM QPSK	1@77	22.98	17.86	0.0611
12	15	15	141300	706.5	DFT-s-OFDM 16 QAM	36@18	22.89	17.77	0.0598
12	15	15	141300	706.5	DFT-s-OFDM 16 QAM	1@1	22.76	17.64	0.0581
12	15	15	141300	706.5	DFT-s-OFDM 16 QAM	1@77	22.71	17.59	0.0574
12	15	15	141300	706.5	DFT-s-OFDM 64 QAM	36@18	22.54	17.42	0.0552

12	15	15	141300	706.5	DFT-s-OFDM 64 QAM	1@1	22.21	17.09	0.0512
12	15	15	141300	706.5	DFT-s-OFDM 64 QAM	1@77	22.27	17.15	0.0519
12	15	15	141300	706.5	DFT-s-OFDM 256 QAM	36@18	20.43	15.31	0.0340
12	15	15	141300	706.5	DFT-s-OFDM 256 QAM	1@1	20.29	15.17	0.0329
12	15	15	141300	706.5	DFT-s-OFDM 256 QAM	1@77	20.07	14.95	0.0313
12	15	15	141300	706.5	CP-OFDM QPSK	39@19	23.29	18.17	0.0656
12	15	15	141300	706.5	CP-OFDM QPSK	1@1	22.64	17.52	0.0565
12	15	15	141300	706.5	CP-OFDM QPSK	1@77	22.65	17.53	0.0566
12	15	15	141500	707.5	DFT-s-OFDM PI/2 BPSK	36@18	23.14	18.02	0.0634
12	15	15	141500	707.5	DFT-s-OFDM PI/2 BPSK	1@1	23.37	18.25	0.0668
12	15	15	141500	707.5	DFT-s-OFDM PI/2 BPSK	1@77	22.85	17.73	0.0593
12	15	15	141500	707.5	DFT-s-OFDM QPSK	36@18	23.21	18.09	0.0644
12	15	15	141500	707.5	DFT-s-OFDM QPSK	1@1	23.38	18.26	0.0670
12	15	15	141500	707.5	DFT-s-OFDM QPSK	1@77	22.87	17.75	0.0596
12	15	15	141500	707.5	DFT-s-OFDM 16 QAM	36@18	22.8	17.68	0.0586
12	15	15	141500	707.5	DFT-s-OFDM 16 QAM	1@1	22.9	17.78	0.0600
12	15	15	141500	707.5	DFT-s-OFDM 16 QAM	1@77	22.66	17.54	0.0568
12	15	15	141500	707.5	DFT-s-OFDM 64 QAM	36@18	22.33	17.21	0.0526
12	15	15	141500	707.5	DFT-s-OFDM 64 QAM	1@1	22.21	17.09	0.0512
12	15	15	141500	707.5	DFT-s-OFDM 64 QAM	1@77	22.17	17.05	0.0507
12	15	15	141500	707.5	DFT-s-OFDM 256 QAM	36@18	20.19	15.07	0.0321
12	15	15	141500	707.5	DFT-s-OFDM 256 QAM	1@1	20.4	15.28	0.0337
12	15	15	141500	707.5	DFT-s-OFDM 256 QAM	1@77	20.01	14.89	0.0308
12	15	15	141500	707.5	CP-OFDM QPSK	39@19	23.22	18.1	0.0646
12	15	15	141500	707.5	CP-OFDM QPSK	1@1	22.95	17.83	0.0607
12	15	15	141500	707.5	CP-OFDM QPSK	1@77	22.26	17.14	0.0518
12	15	15	141700	708.5	DFT-s-OFDM PI/2 BPSK	36@18	23.12	18	0.0631

12	15	15	141700	708.5	DFT-s-OFDM PI/2 BPSK	1@1	23.75	18.63	0.0729
12	15	15	141700	708.5	DFT-s-OFDM PI/2 BPSK	1@77	23.66	18.54	0.0714
12	15	15	141700	708.5	DFT-s-OFDM QPSK	36@18	23.12	18	0.0631
12	15	15	141700	708.5	DFT-s-OFDM QPSK	1@1	23.5	18.38	0.0689
12	15	15	141700	708.5	DFT-s-OFDM QPSK	1@77	22.9	17.78	0.0600
12	15	15	141700	708.5	DFT-s-OFDM 16 QAM	36@18	22.79	17.67	0.0585
12	15	15	141700	708.5	DFT-s-OFDM 16 QAM	1@1	23.06	17.94	0.0622
12	15	15	141700	708.5	DFT-s-OFDM 16 QAM	1@77	22.57	17.45	0.0556
12	15	15	141700	708.5	DFT-s-OFDM 64 QAM	36@18	22.5	17.38	0.0547
12	15	15	141700	708.5	DFT-s-OFDM 64 QAM	1@1	22.52	17.4	0.0550
12	15	15	141700	708.5	DFT-s-OFDM 64 QAM	1@77	22.43	17.31	0.0538
12	15	15	141700	708.5	DFT-s-OFDM 256 QAM	36@18	20.22	15.1	0.0324
12	15	15	141700	708.5	DFT-s-OFDM 256 QAM	1@1	20.52	15.4	0.0347
12	15	15	141700	708.5	DFT-s-OFDM 256 QAM	1@77	19.99	14.87	0.0307
12	15	15	141700	708.5	CP-OFDM QPSK	39@19	23.19	18.07	0.0641
12	15	15	141700	708.5	CP-OFDM QPSK	1@1	23.04	17.92	0.0619
12	15	15	141700	708.5	CP-OFDM QPSK	1@77	22.56	17.44	0.0555

## Frequency Stability

NR Band	SCS (kHz)	Bandwidth (MHz)	Arfcn	Freq (MHz)	Modulation	RB	Deviation (ppm)	Verdict	Environment
12	15	15	141500	707.5	DFT-s-OFDM QPSK	75@0	0.0000	PASS	NV
12	15	15	141500	707.5	DFT-s-OFDM QPSK	75@0	0.0007	PASS	LV
12	15	15	141500	707.5	DFT-s-OFDM QPSK	75@0	0.0006	PASS	HV
12	15	15	141500	707.5	DFT-s-OFDM QPSK	75@0	0.0049	PASS	-30°C
12	15	15	141500	707.5	DFT-s-OFDM QPSK	75@0	0.0007	PASS	-20°C
12	15	15	141500	707.5	DFT-s-OFDM QPSK	75@0	0.0023	PASS	-10°C
12	15	15	141500	707.5	DFT-s-OFDM QPSK	75@0	0.0011	PASS	0°C
12	15	15	141500	707.5	DFT-s-OFDM QPSK	75@0	0.0004	PASS	10°C
12	15	15	141500	707.5	DFT-s-OFDM QPSK	75@0	0.0000	PASS	20°C
12	15	15	141500	707.5	DFT-s-OFDM QPSK	75@0	0.0047	PASS	30°C
12	15	15	141500	707.5	DFT-s-OFDM QPSK	75@0	0.0048	PASS	40°C
12	15	15	141500	707.5	DFT-s-OFDM QPSK	75@0	0.0011	PASS	50°C

## Peak to Average Ratio

NR Band	SCS (kHz)	Bandwidth (MHz)	Arcfn	Freq (MHz)	Modulation	RB	Result (dB)	Limit (dB)	Verdict
12	15	10	140800	704.0	DFT-s-OFDM PI/2 BPSK	50@0	4.59	13	PASS
12	15	10	140800	704.0	DFT-s-OFDM PI/2 BPSK	1@0	4.13	13	PASS
12	15	10	140800	704.0	DFT-s-OFDM QPSK	50@0	5.08	13	PASS
12	15	10	140800	704.0	DFT-s-OFDM QPSK	1@0	4.59	13	PASS
12	15	10	141500	707.5	DFT-s-OFDM PI/2 BPSK	50@0	3.87	13	PASS
12	15	10	141500	707.5	DFT-s-OFDM PI/2 BPSK	1@0	4.05	13	PASS
12	15	10	141500	707.5	DFT-s-OFDM QPSK	50@0	5.21	13	PASS
12	15	10	141500	707.5	DFT-s-OFDM QPSK	1@0	4.64	13	PASS
12	15	10	142200	711.0	DFT-s-OFDM PI/2 BPSK	50@0	4.15	13	PASS
12	15	10	142200	711.0	DFT-s-OFDM PI/2 BPSK	1@0	4.02	13	PASS
12	15	10	142200	711.0	DFT-s-OFDM QPSK	50@0	5.35	13	PASS
12	15	10	142200	711.0	DFT-s-OFDM QPSK	1@0	4.3	13	PASS

N12(10M)\_DFT-s-OFDM\_PI\_2-BPSK\_Outer\_Full\_Low\_CH



N12(10M)\_DFT-s-OFDM\_PI\_2-BPSK\_Edge\_1RB\_Left\_Low\_CH



N12(10M)\_DFT-s-OFDM\_QPSK\_Outer\_Full\_Low\_CH

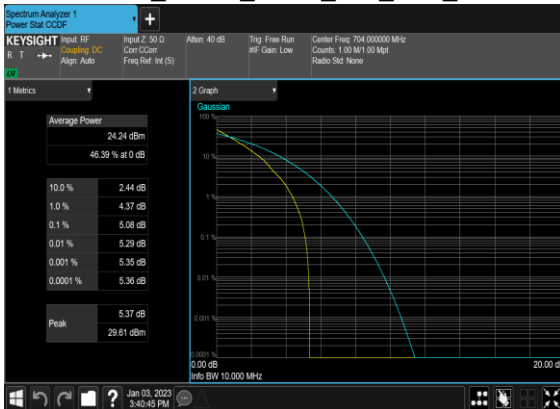

N12(10M)\_DFT-s-OFDM\_QPSK\_Edge\_1RB\_Left\_Low\_CH

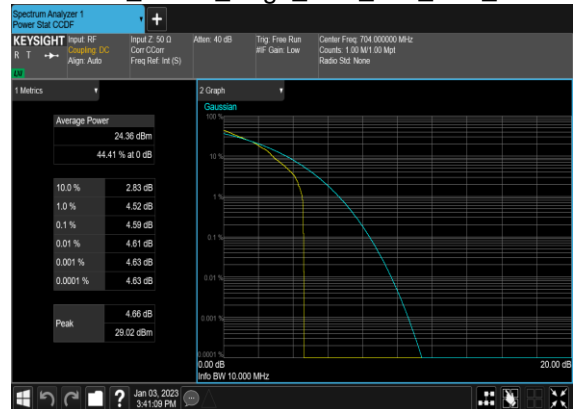

N12(10M)\_DFT-s-OFDM\_PI\_2-BPSK\_Outer\_Full\_Mid\_CH

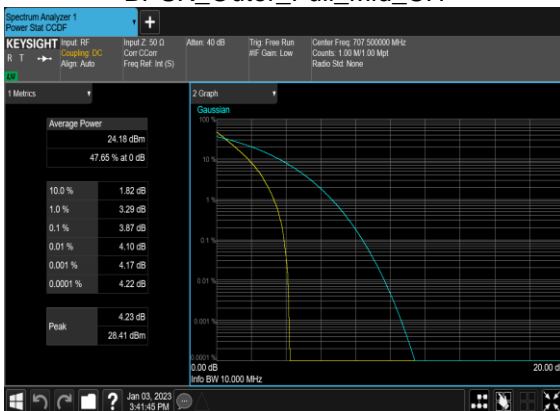

N12(10M)\_DFT-s-OFDM\_PI\_2-BPSK\_Edge\_1RB\_Left\_Mid\_CH

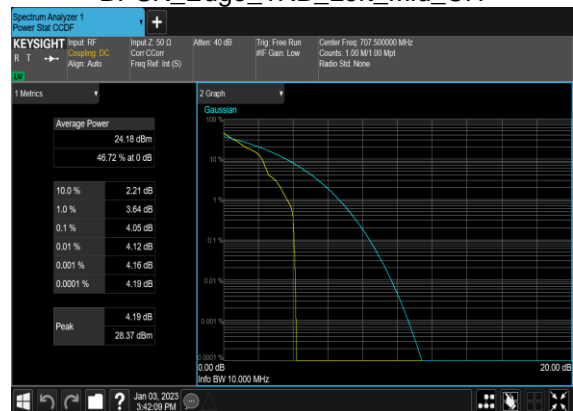

N12(10M)\_DFT-s-OFDM\_QPSK\_Outer\_Full\_Mid\_CH

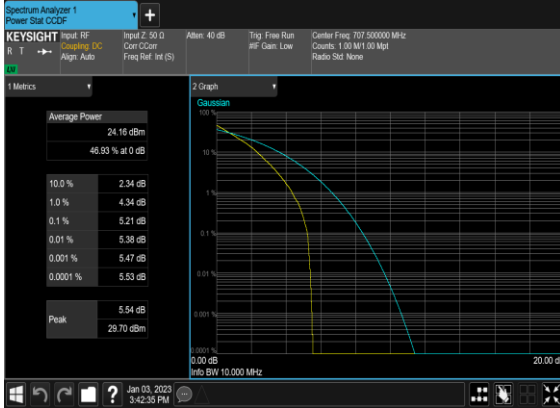

N12(10M)\_DFT-s-OFDM\_QPSK\_Edge\_1RB\_Left\_Mid\_CH

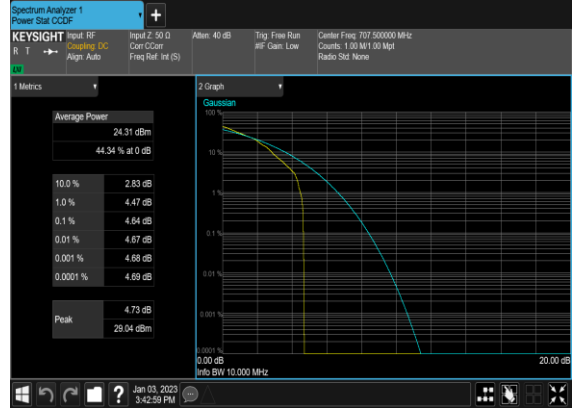

N12(10M)\_DFT-s-OFDM\_PI\_2-BPSK\_Outer\_Full\_High\_CH

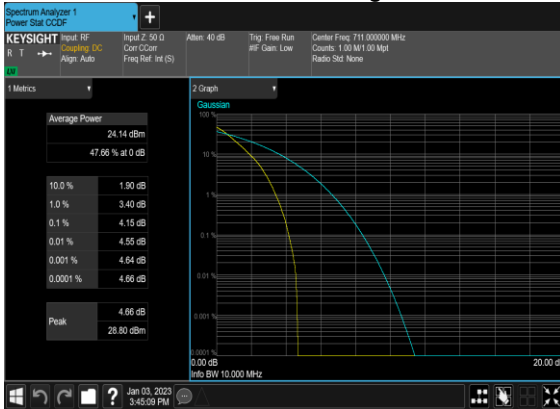

N12(10M)\_DFT-s-OFDM\_PI\_2-BPSK\_Edge\_1RB\_Left\_High\_CH

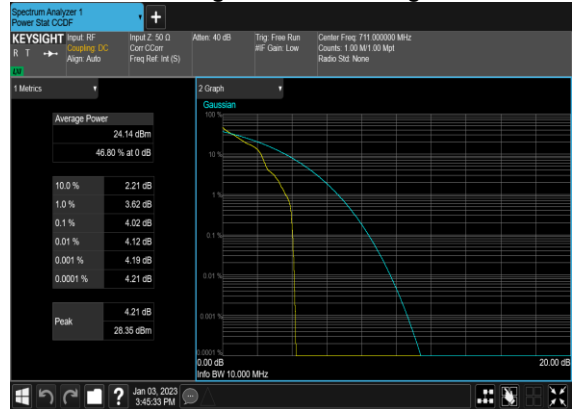

N12(10M)\_DFT-s-OFDM\_QPSK\_Outer\_Full\_High\_CH



N12(10M)\_DFT-s-OFDM\_QPSK\_Edge\_1RB\_Left\_High\_CH





## Occupied Bandwidth

NR Band	SCS (kHz)	Bandwidth (MHz)	Arfcn	Freq (MHz)	Modulation	RB	OBW (MHz)	26dB BW (MHz)
12	15	5	141500	707.5	DFT-s-OFDM PI/2 BPSK	25@0	4.481	5.025
12	15	5	141500	707.5	DFT-s-OFDM QPSK	25@0	4.4638	4.935
12	15	5	141500	707.5	CP-OFDM QPSK	25@0	4.4696	5.096
12	15	5	141500	707.5	CP-OFDM 16 QAM	25@0	4.4793	5.11
12	15	5	141500	707.5	CP-OFDM 64 QAM	25@0	4.4615	5.067
12	15	5	141500	707.5	CP-OFDM 256 QAM	25@0	4.4709	4.951
12	15	10	141500	707.5	DFT-s-OFDM PI/2 BPSK	50@0	8.8747	9.495
12	15	10	141500	707.5	DFT-s-OFDM QPSK	50@0	8.8876	9.497
12	15	10	141500	707.5	CP-OFDM QPSK	52@0	9.2572	10.07
12	15	10	141500	707.5	CP-OFDM 16 QAM	52@0	9.2752	9.884
12	15	10	141500	707.5	CP-OFDM 64 QAM	52@0	9.213	9.807
12	15	10	141500	707.5	CP-OFDM 256 QAM	52@0	9.2578	9.901
12	15	15	141500	707.5	DFT-s-OFDM PI/2 BPSK	75@0	13.338	14.23
12	15	15	141500	707.5	DFT-s-OFDM QPSK	75@0	13.369	14.31
12	15	15	141500	707.5	CP-OFDM QPSK	79@0	14.043	14.94
12	15	15	141500	707.5	CP-OFDM 16 QAM	79@0	14.063	14.88
12	15	15	141500	707.5	CP-OFDM 64 QAM	79@0	14.083	14.77
12	15	15	141500	707.5	CP-OFDM 256 QAM	79@0	14.036	14.83

N12(5M)\_DFT-s-OFDM\_PI\_2-  
BPSK\_Outer\_Full\_Mid\_CH

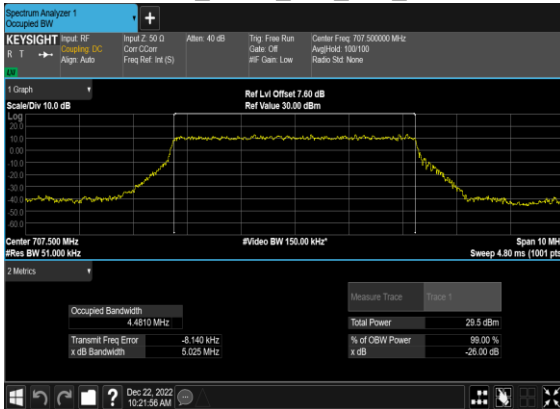

N12(5M)\_DFT-s-  
OFDM\_QPSK\_Outer\_Full\_Mid\_CH

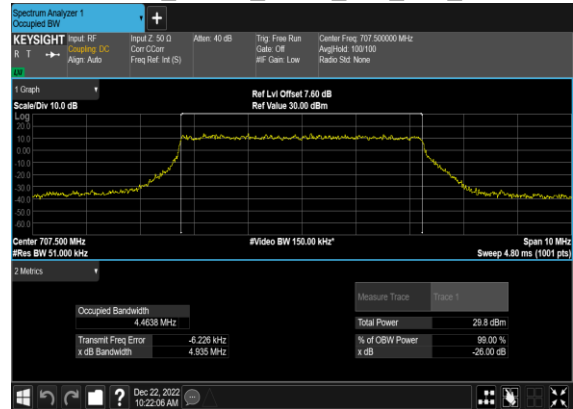

N12(5M)\_CP-  
OFDM\_QPSK\_Outer\_Full\_Mid\_CH

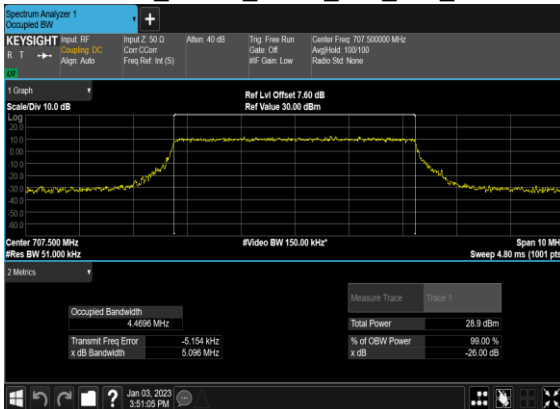

N12(5M)\_CP-OFDM\_16  
QAM\_Outer\_Full\_Mid\_CH

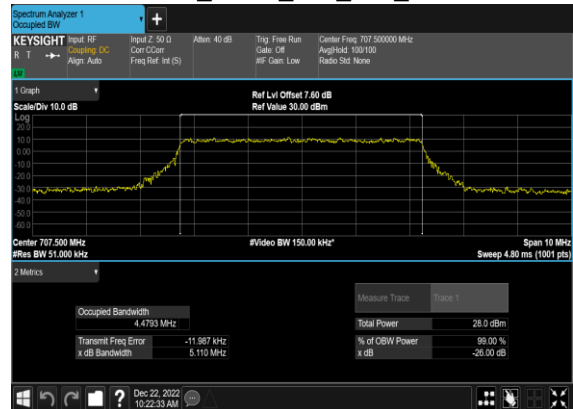

N12(5M)\_CP-OFDM\_64  
QAM\_Outer\_Full\_Mid\_CH

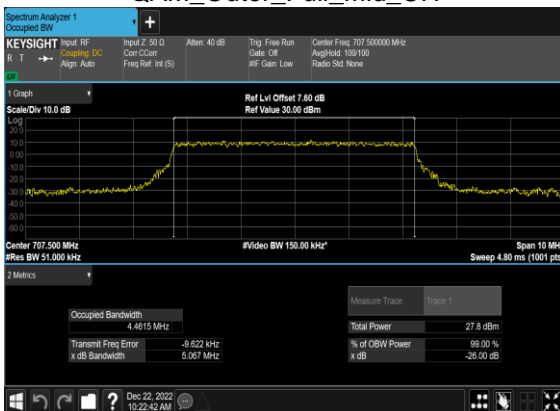

N12(5M)\_CP-OFDM\_256  
QAM\_Outer\_Full\_Mid\_CH

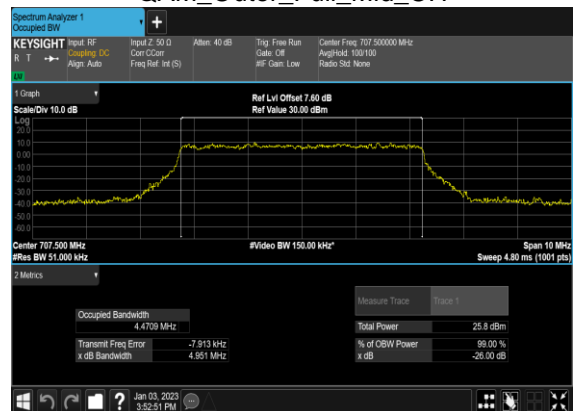

N12(10M)\_DFT-s-OFDM\_PI\_2-BPSK\_Outer\_Full\_Mid\_CH

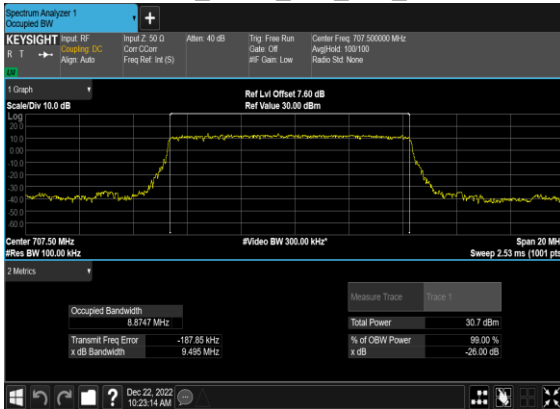

N12(10M)\_DFT-s-OFDM\_QPSK\_Outer\_Full\_Mid\_CH

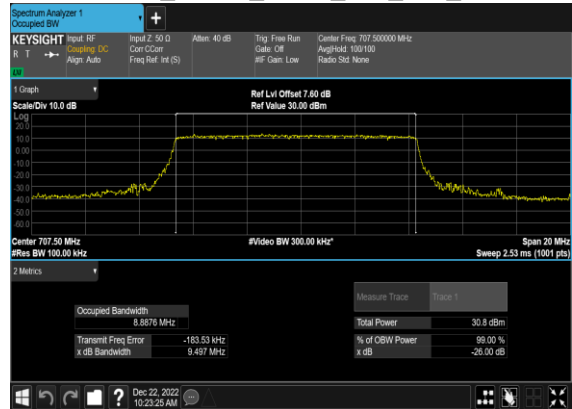

N12(10M)\_CP-OFDM\_QPSK\_Outer\_Full\_Mid\_CH

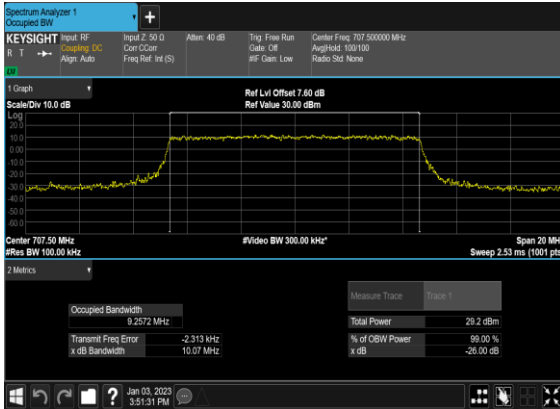

N12(10M)\_CP-OFDM\_16QAM\_Outer\_Full\_Mid\_CH



N12(10M)\_CP-OFDM\_64QAM\_Outer\_Full\_Mid\_CH

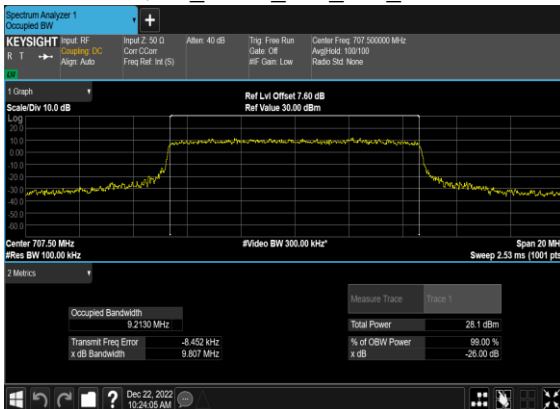

N12(10M)\_CP-OFDM\_256QAM\_Outer\_Full\_Mid\_CH

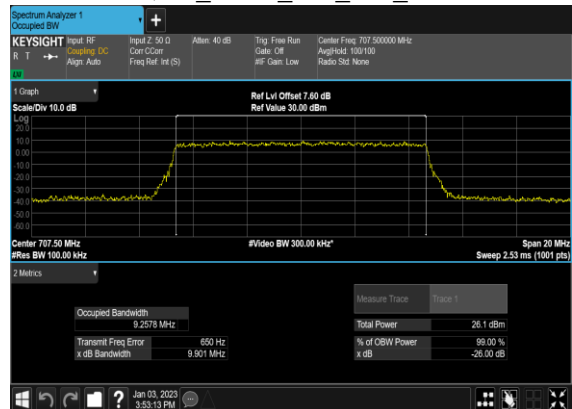

### N12(15M)\_DFT-s-OFDM\_PI\_2- BPSK\_Outer\_Full\_Mid\_CH

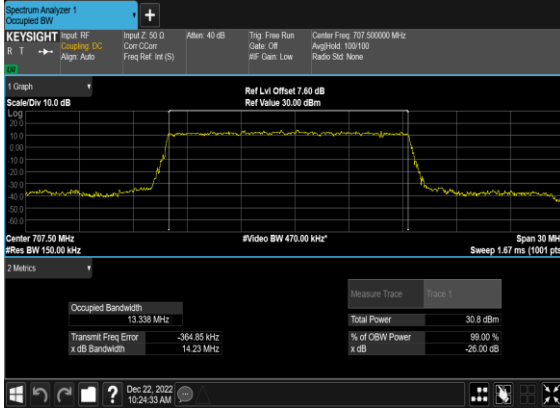

### N12(15M)\_DFT-s- OFDM\_QPSK\_Outer\_Full\_Mid\_CH



### N12(15M)\_CP- OFDM\_QPSK\_Outer\_Full\_Mid\_CH

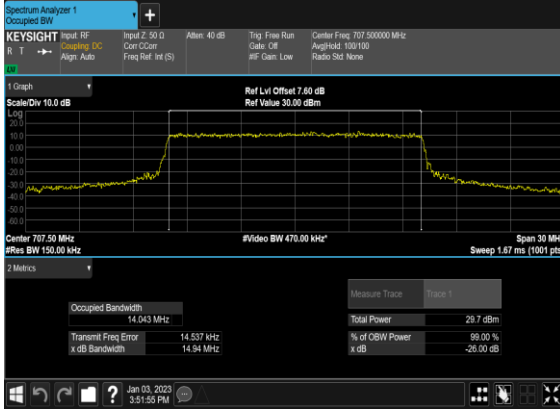

### N12(15M)\_CP-OFDM\_16 QAM\_Outer\_Full\_Mid\_CH

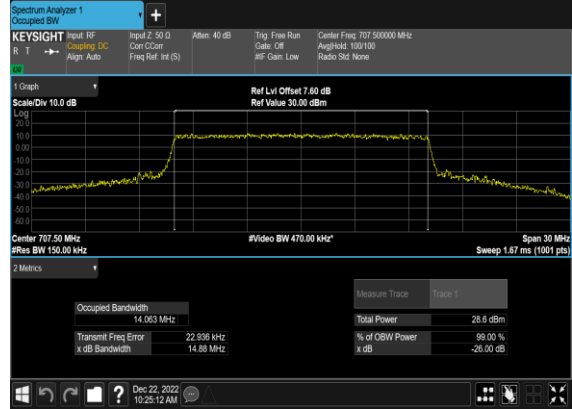

### N12(15M)\_CP-OFDM\_64 QAM\_Outer\_Full\_Mid\_CH

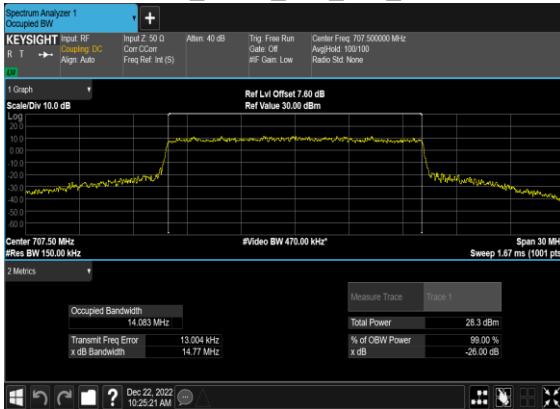

### N12(15M)\_CP-OFDM\_256 QAM\_Outer\_Full\_Mid\_CH

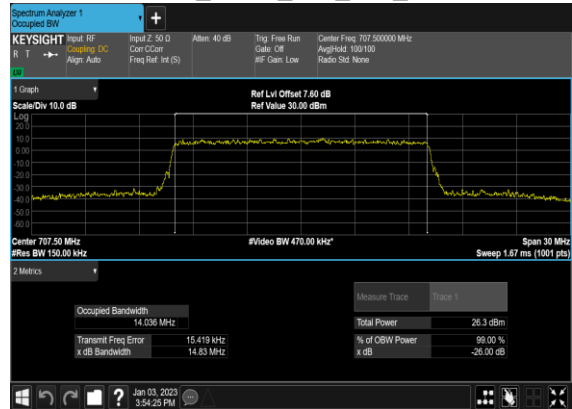

## Conducted Spurious Emissions

NR Band	SCS (kHz)	Bandwidth (MHz)	Arfcn	Freq (MHz)	Modulation	RB	Result	Verdict
12	15	5	140300	701.5	DFT-s-OFDM BPSK	1@0	see graph	---
12	15	5	140300	701.5	DFT-s-OFDM BPSK	1@0	see graph	PASS
12	15	5	140300	701.5	DFT-s-OFDM QPSK	1@0	see graph	---
12	15	5	140300	701.5	DFT-s-OFDM QPSK	1@0	see graph	PASS
12	15	5	141500	707.5	DFT-s-OFDM BPSK	1@0	see graph	---
12	15	5	141500	707.5	DFT-s-OFDM BPSK	1@0	see graph	PASS
12	15	5	141500	707.5	DFT-s-OFDM QPSK	1@0	see graph	---
12	15	5	141500	707.5	DFT-s-OFDM QPSK	1@0	see graph	PASS
12	15	5	142700	713.5	DFT-s-OFDM BPSK	1@0	see graph	---
12	15	5	142700	713.5	DFT-s-OFDM BPSK	1@0	see graph	PASS
12	15	5	142700	713.5	DFT-s-OFDM QPSK	1@0	see graph	---
12	15	5	142700	713.5	DFT-s-OFDM QPSK	1@0	see graph	PASS
12	15	10	140800	704.0	DFT-s-OFDM BPSK	1@0	see graph	---
12	15	10	140800	704.0	DFT-s-OFDM BPSK	1@0	see graph	PASS
12	15	10	140800	704.0	DFT-s-OFDM QPSK	1@0	see graph	---
12	15	10	140800	704.0	DFT-s-OFDM QPSK	1@0	see graph	PASS
12	15	10	141500	707.5	DFT-s-OFDM BPSK	1@0	see graph	---
12	15	10	141500	707.5	DFT-s-OFDM BPSK	1@0	see graph	PASS
12	15	10	141500	707.5	DFT-s-OFDM QPSK	1@0	see graph	---
12	15	10	141500	707.5	DFT-s-OFDM QPSK	1@0	see graph	PASS
12	15	10	142200	711.0	DFT-s-OFDM BPSK	1@0	see graph	---
12	15	10	142200	711.0	DFT-s-OFDM BPSK	1@0	see graph	PASS

12	15	10	142200	711.0	DFT-s-OFDM QPSK	1@0	see graph	---
12	15	10	142200	711.0	DFT-s-OFDM QPSK	1@0	see graph	<b>PASS</b>
12	15	15	141300	706.5	DFT-s-OFDM BPSK	1@0	see graph	---
12	15	15	141300	706.5	DFT-s-OFDM BPSK	1@0	see graph	<b>PASS</b>
12	15	15	141300	706.5	DFT-s-OFDM QPSK	1@0	see graph	---
12	15	15	141300	706.5	DFT-s-OFDM QPSK	1@0	see graph	<b>PASS</b>
12	15	15	141500	707.5	DFT-s-OFDM BPSK	1@0	see graph	---
12	15	15	141500	707.5	DFT-s-OFDM BPSK	1@0	see graph	<b>PASS</b>
12	15	15	141500	707.5	DFT-s-OFDM QPSK	1@0	see graph	---
12	15	15	141500	707.5	DFT-s-OFDM QPSK	1@0	see graph	<b>PASS</b>
12	15	15	141700	708.5	DFT-s-OFDM BPSK	1@0	see graph	---
12	15	15	141700	708.5	DFT-s-OFDM BPSK	1@0	see graph	<b>PASS</b>
12	15	15	141700	708.5	DFT-s-OFDM QPSK	1@0	see graph	---
12	15	15	141700	708.5	DFT-s-OFDM QPSK	1@0	see graph	<b>PASS</b>

N12(5M)\_DFT-s-OFDM\_BPSK\_Edge\_1RB\_Left\_Low\_CH

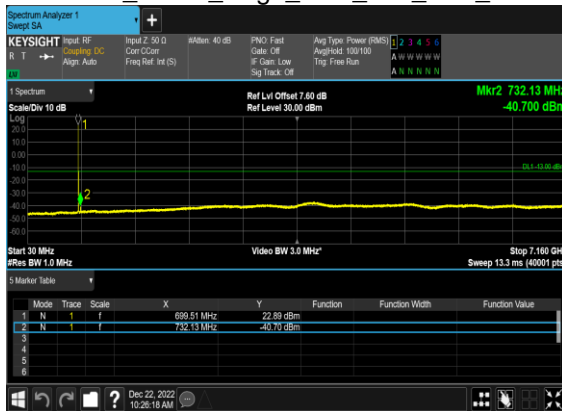

N12(5M)\_DFT-s-OFDM\_QPSK\_Edge\_1RB\_Left\_Low\_CH



N12(5M)\_DFT-s-OFDM\_BPSK\_Edge\_1RB\_Left\_Mid\_CH



N12(5M)\_DFT-s-OFDM\_QPSK\_Edge\_1RB\_Left\_Mid\_CH



N12(5M)\_DFT-s-OFDM\_BPSK\_Edge\_1RB\_Left\_High\_CH



N12(5M)\_DFT-s-OFDM\_QPSK\_Edge\_1RB\_Left\_High\_CH



### N12(10M)\_DFT-s-OFDM\_BPSK\_Edge\_1RB\_Left\_Low\_CH



### N12(10M)\_DFT-s-OFDM\_QPSK\_Edge\_1RB\_Left\_Low\_CH

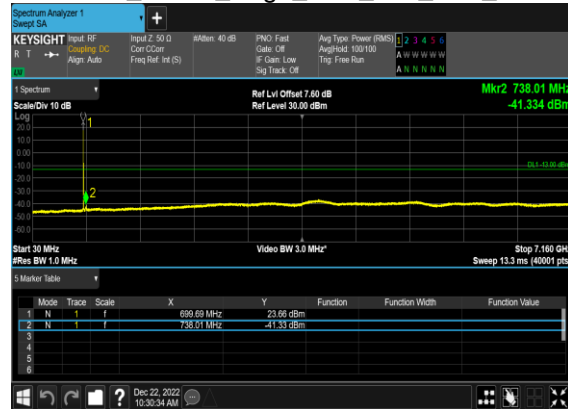

### N12(10M)\_DFT-s-OFDM\_BPSK\_Edge\_1RB\_Left\_Mid\_CH

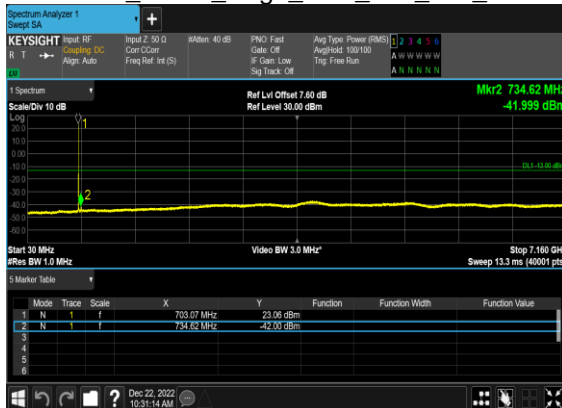

### N12(10M)\_DFT-s-OFDM\_QPSK\_Edge\_1RB\_Left\_Mid\_CH



### N12(10M)\_DFT-s-OFDM\_BPSK\_Edge\_1RB\_Left\_High\_CH



### N12(10M)\_DFT-s-OFDM\_QPSK\_Edge\_1RB\_Left\_High\_CH

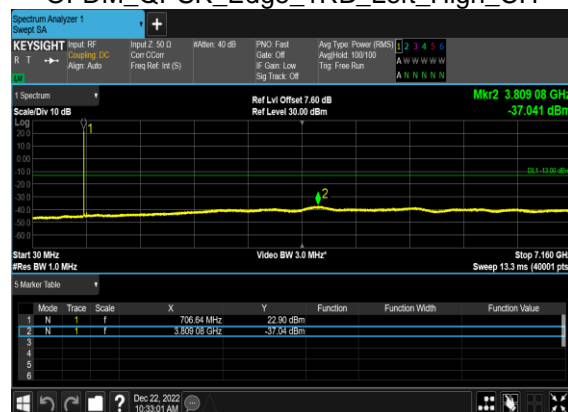



### N12(15M)\_DFT-s-OFDM\_BPSK\_Edge\_1RB\_Left\_Low\_CH

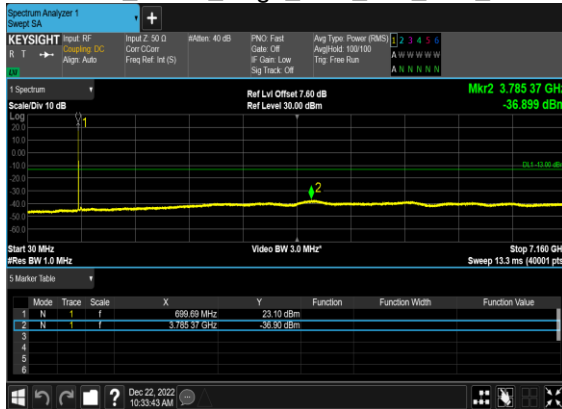

### N12(15M)\_DFT-s-OFDM\_QPSK\_Edge\_1RB\_Left\_Low\_CH

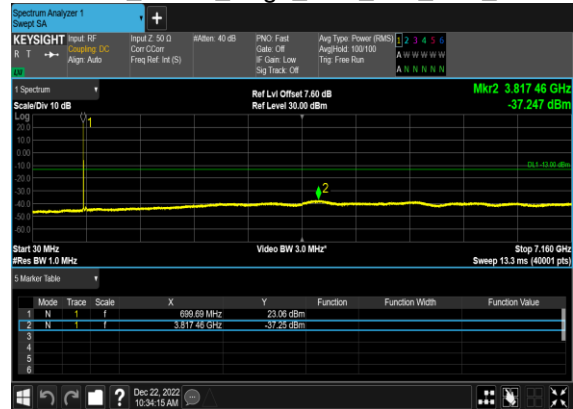

### N12(15M)\_DFT-s-OFDM\_BPSK\_Edge\_1RB\_Left\_Mid\_CH

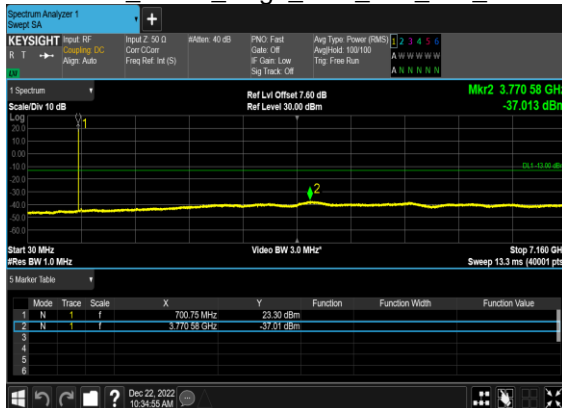

### N12(15M)\_DFT-s-OFDM\_QPSK\_Edge\_1RB\_Left\_Mid\_CH



### N12(15M)\_DFT-s-OFDM\_BPSK\_Edge\_1RB\_Left\_High\_CH



### N12(15M)\_DFT-s-OFDM\_QPSK\_Edge\_1RB\_Left\_High\_CH

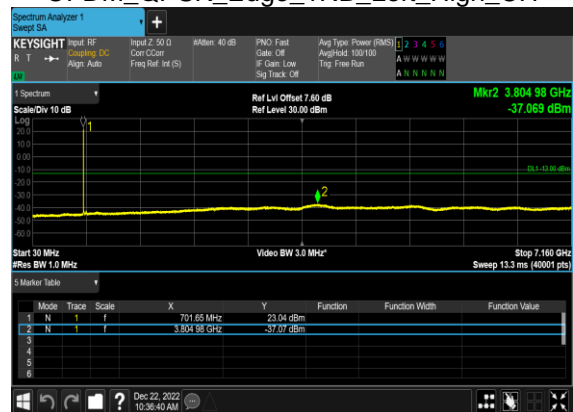

## Conducted Band Edge

NR Band	SCS (kHz)	Bandwidth (MHz)	Arfcn	Freq (MHz)	Modulation	RB	Result	Verdict
12	15	5	140300	701.5	DFT-s-OFDM BPSK	1@0	see graph	PASS
12	15	5	140300	701.5	DFT-s-OFDM QPSK	1@0	see graph	PASS
12	15	5	140300	701.5	DFT-s-OFDM BPSK	25@0	see graph	PASS
12	15	5	140300	701.5	DFT-s-OFDM QPSK	25@0	see graph	PASS
12	15	5	142700	713.5	DFT-s-OFDM BPSK	1@24	see graph	PASS
12	15	5	142700	713.5	DFT-s-OFDM QPSK	1@24	see graph	PASS
12	15	5	142700	713.5	DFT-s-OFDM BPSK	25@0	see graph	PASS
12	15	5	142700	713.5	DFT-s-OFDM QPSK	25@0	see graph	PASS
12	15	10	140800	704.0	DFT-s-OFDM BPSK	1@0	see graph	PASS
12	15	10	140800	704.0	DFT-s-OFDM QPSK	1@0	see graph	PASS
12	15	10	140800	704.0	DFT-s-OFDM BPSK	50@0	see graph	PASS
12	15	10	140800	704.0	DFT-s-OFDM QPSK	50@0	see graph	PASS
12	15	10	142200	711.0	DFT-s-OFDM BPSK	1@51	see graph	PASS
12	15	10	142200	711.0	DFT-s-OFDM QPSK	1@51	see graph	PASS
12	15	10	142200	711.0	DFT-s-OFDM BPSK	50@0	see graph	PASS
12	15	10	142200	711.0	DFT-s-OFDM QPSK	50@0	see graph	PASS
12	15	15	141300	706.5	DFT-s-OFDM BPSK	1@0	see graph	PASS
12	15	15	141300	706.5	DFT-s-OFDM QPSK	1@0	see graph	PASS
12	15	15	141300	706.5	DFT-s-OFDM BPSK	75@0	see graph	PASS
12	15	15	141300	706.5	DFT-s-OFDM QPSK	75@0	see graph	PASS
12	15	15	141700	708.5	DFT-s-OFDM BPSK	1@78	see graph	PASS
12	15	15	141700	708.5	DFT-s-OFDM QPSK	1@78	see graph	PASS
12	15	15	141700	708.5	DFT-s-OFDM BPSK	75@0	see graph	PASS
12	15	15	141700	708.5	DFT-s-OFDM QPSK	75@0	see graph	PASS

### N12(5M)\_DFT-s-OFDM\_BPSK\_Edge\_1RB\_Left\_Low\_CH

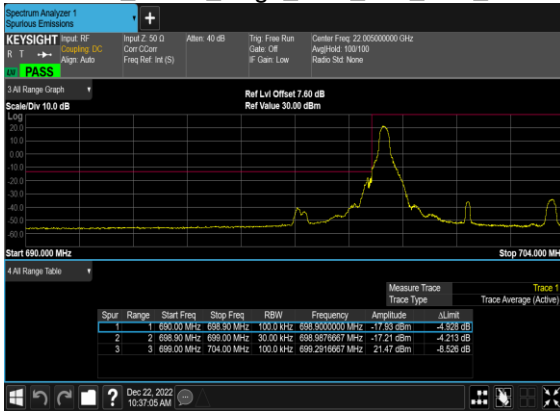

### N12(5M)\_DFT-s-OFDM\_QPSK\_Edge\_1RB\_Left\_Low\_CH

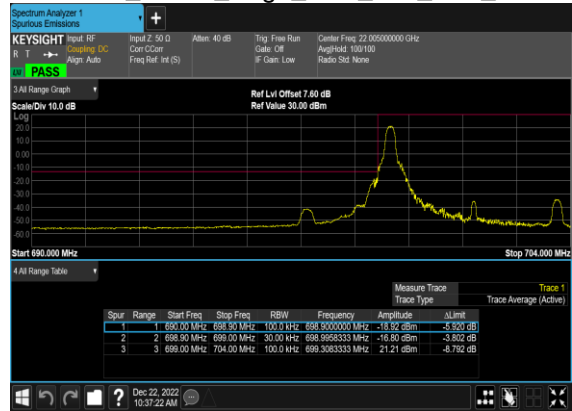

### N12(5M)\_DFT-s-OFDM\_BPSK\_Outer\_Full\_Low\_CH

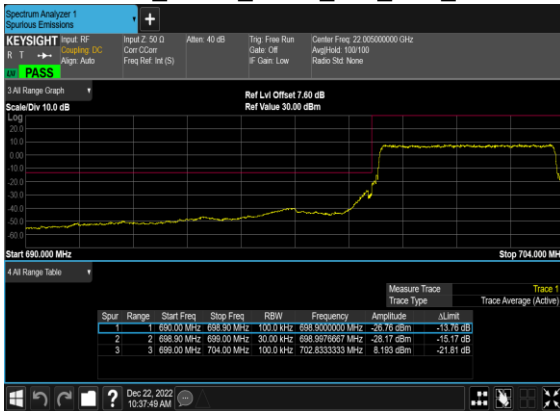

### N12(5M)\_DFT-s-OFDM\_QPSK\_Outer\_Full\_Low\_CH

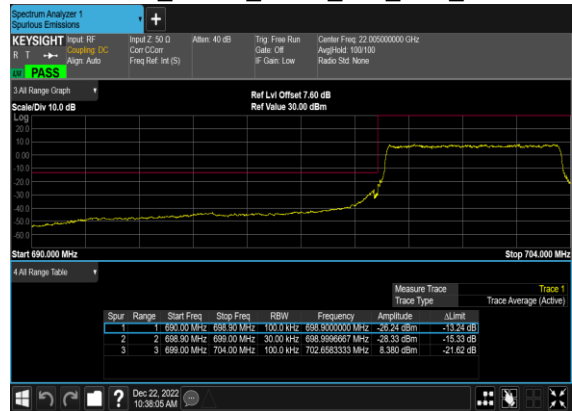

### N12(5M)\_DFT-s-OFDM\_BPSK\_Edge\_1RB\_Right\_High\_CH

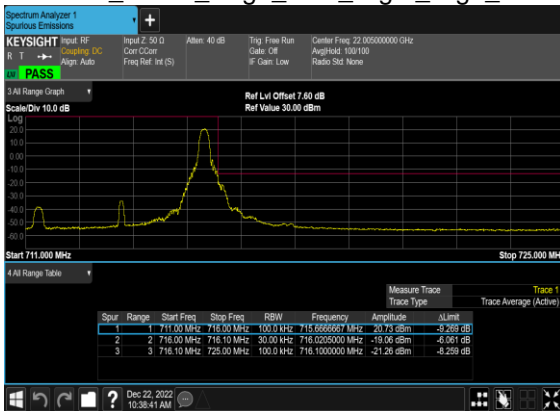

### N12(5M)\_DFT-s-OFDM\_QPSK\_Edge\_1RB\_Right\_High\_CH

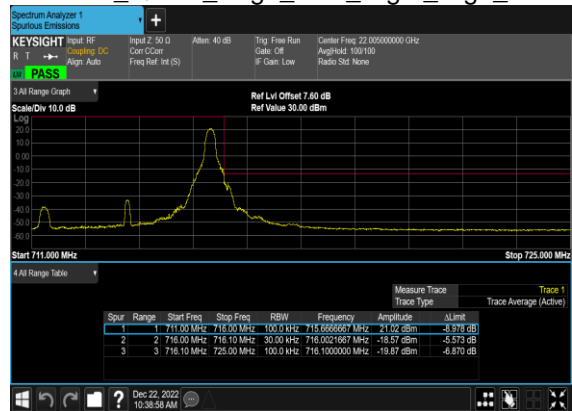

### N12(5M)\_DFT-s-OFDM\_BPSK\_Outer\_Full\_High\_CH



### N12(5M)\_DFT-s-OFDM\_QPSK\_Outer\_Full\_High\_CH

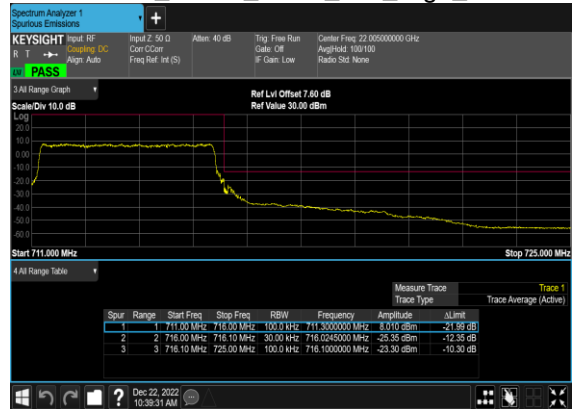

### N12(10M)\_DFT-s-OFDM\_BPSK\_Edge\_1RB\_Left\_Low\_CH

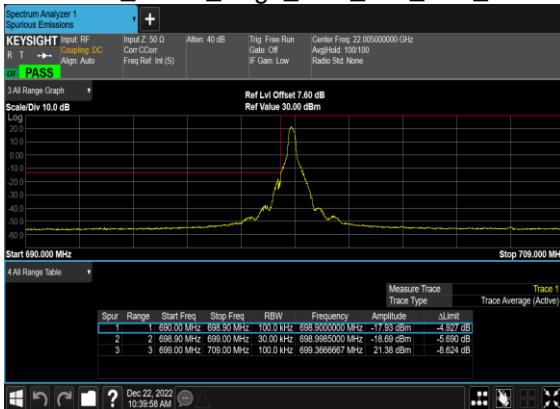

### N12(10M)\_DFT-s-OFDM\_QPSK\_Edge\_1RB\_Left\_Low\_CH

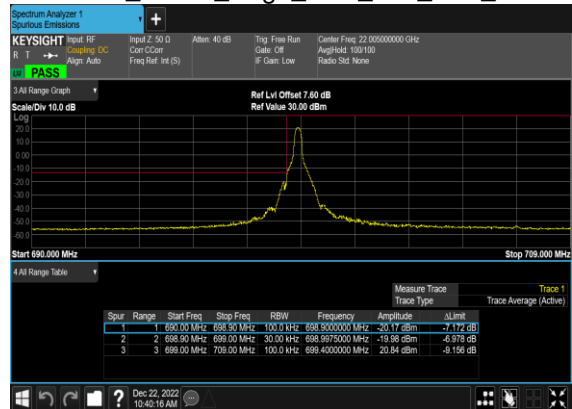

### N12(10M)\_DFT-s-OFDM\_BPSK\_Outer\_Full\_Low\_CH

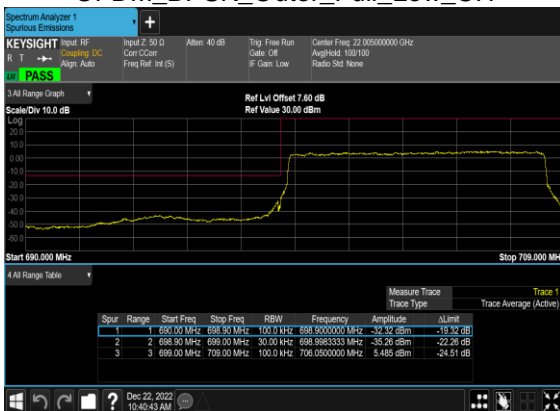

### N12(10M)\_DFT-s-OFDM\_QPSK\_Outer\_Full\_Low\_CH

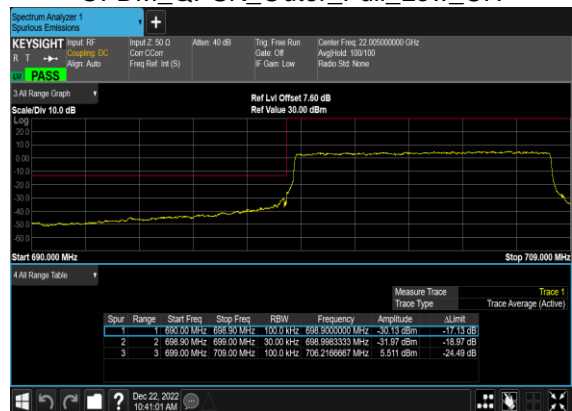

### N12(10M)\_DFT-s-OFDM\_BPSK\_Edge\_1RB\_Right\_High\_CH

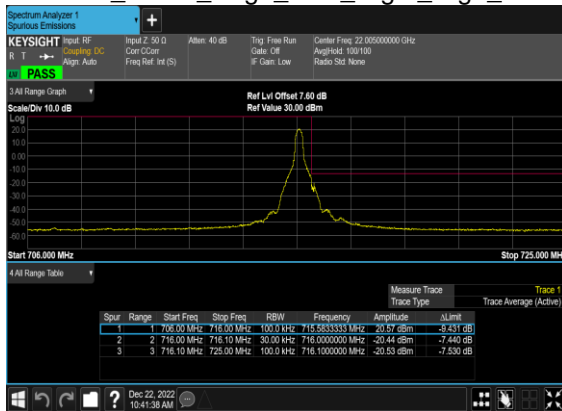

### N12(10M)\_DFT-s-OFDM\_QPSK\_Edge\_1RB\_Right\_High\_CH

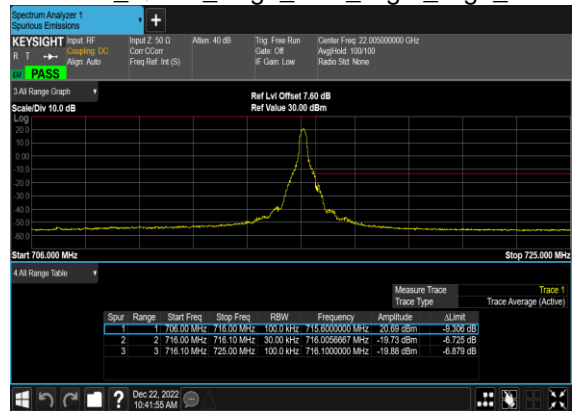

### N12(10M)\_DFT-s-OFDM\_BPSK\_Outer\_Full\_High\_CH



### N12(10M)\_DFT-s-OFDM\_QPSK\_Outer\_Full\_High\_CH



### N12(15M)\_DFT-s-OFDM\_BPSK\_Edge\_1RB\_Left\_Low\_CH

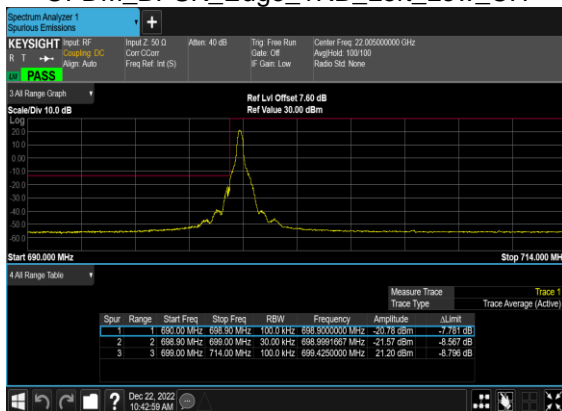

### N12(15M)\_DFT-s-OFDM\_QPSK\_Edge\_1RB\_Left\_Low\_CH

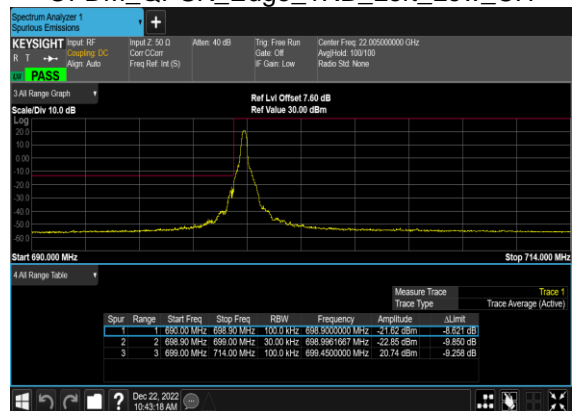

### N12(15M)\_DFT-s-OFDM\_BPSK\_Outer\_Full\_Low\_CH

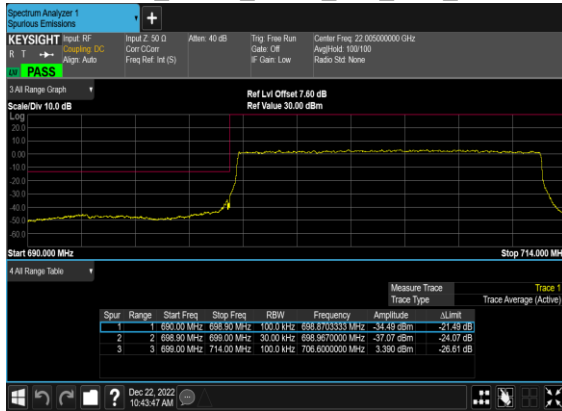

### N12(15M)\_DFT-s-OFDM\_QPSK\_Outer\_Full\_Low\_CH

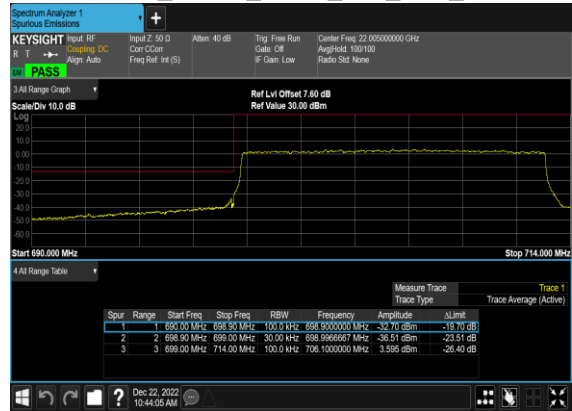

### N12(15M)\_DFT-s-OFDM\_BPSK\_Edge\_1RB\_Right\_High\_CH

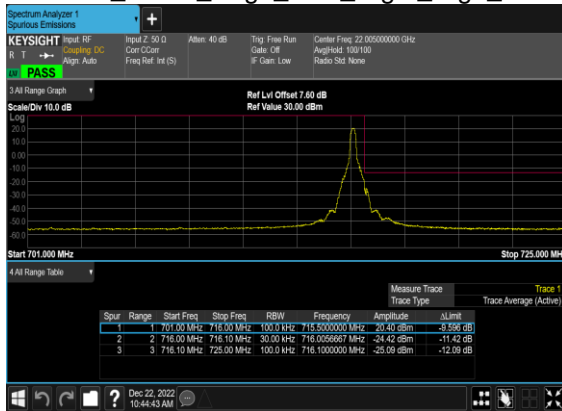

### N12(15M)\_DFT-s-OFDM\_QPSK\_Edge\_1RB\_Right\_High\_CH

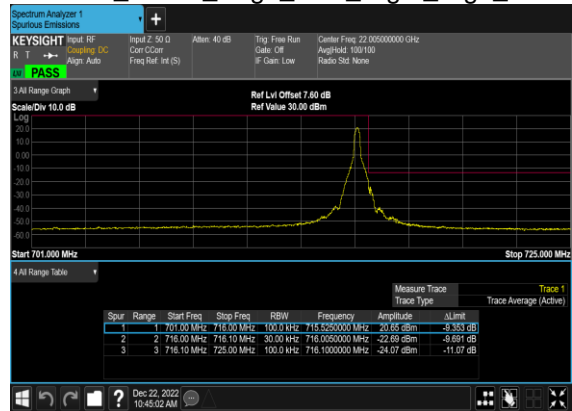

### N12(15M)\_DFT-s-OFDM\_BPSK\_Outer\_Full\_High\_CH



### N12(15M)\_DFT-s-OFDM\_QPSK\_Outer\_Full\_High\_CH



# FR1 N13(ANT0)

## Transmitter Conducted Output Power and ERP, ( $G_T - L_C$ )=-2.69dB

NR Band	SCS (kHz)	Bandwidth (MHz)	Arfcn	Freq (MHz)	Modulation	RB	Conducted Power (dBm)	ERP (dBm)	ERP (W)
13	15	5	149700	779.5	DFT-s-OFDM QPSK	1@1	21.5	16.66	0.0463
13	15	5	149700	779.5	DFT-s-OFDM 16 QAM	1@1	20.84	16	0.0398
13	15	5	150200	782.0	DFT-s-OFDM QPSK	1@1	22.2	17.36	0.0545
13	15	5	150200	782.0	DFT-s-OFDM 16 QAM	1@1	21.58	16.74	0.0472
13	15	5	150700	784.5	DFT-s-OFDM QPSK	1@1	22.76	17.92	0.0619
13	15	5	150700	784.5	DFT-s-OFDM 16 QAM	1@1	22.12	17.28	0.0535
13	15	10	150200	782.0	DFT-s-OFDM PI/2 BPSK	25@12	22.8	17.96	0.0625
13	15	10	150200	782.0	DFT-s-OFDM PI/2 BPSK	1@1	21.41	16.57	0.0454
13	15	10	150200	782.0	DFT-s-OFDM PI/2 BPSK	1@50	21.82	16.98	0.0499
13	15	10	150200	782.0	DFT-s-OFDM QPSK	25@12	22.8	17.96	0.0625
13	15	10	150200	782.0	DFT-s-OFDM QPSK	1@1	21.41	16.57	0.0454
13	15	10	150200	782.0	DFT-s-OFDM QPSK	1@50	23.16	18.32	0.0679
13	15	10	150200	782.0	DFT-s-OFDM 16 QAM	25@12	21.73	16.89	0.0489
13	15	10	150200	782.0	DFT-s-OFDM 16 QAM	1@1	20.57	15.73	0.0374
13	15	10	150200	782.0	DFT-s-OFDM 16 QAM	1@50	22.55	17.71	0.0590
13	15	10	150200	782.0	DFT-s-OFDM 64 QAM	25@12	20.38	15.54	0.0358
13	15	10	150200	782.0	DFT-s-OFDM 64 QAM	1@1	19.57	14.73	0.0297
13	15	10	150200	782.0	DFT-s-OFDM 64 QAM	1@50	21.55	16.71	0.0469
13	15	10	150200	782.0	DFT-s-OFDM 256 QAM	25@12	18.74	13.9	0.0245
13	15	10	150200	782.0	DFT-s-OFDM 256 QAM	1@1	17.72	12.88	0.0194
13	15	10	150200	782.0	DFT-s-OFDM 256 QAM	1@50	19.64	14.8	0.0302
13	15	10	150200	782.0	CP-OFDM QPSK	26@13	19.51	14.67	0.0293
13	15	10	150200	782.0	CP-OFDM QPSK	1@1	20.06	15.22	0.0333
13	15	10	150200	782.0	CP-OFDM QPSK	1@50	21.98	17.14	0.0518

## Frequency Stability

NR Band	SCS (kHz)	Bandwidth (MHz)	Arfcn	Freq (MHz)	Modulation	RB	Deviation (ppm)	Verdict	Environment
13	15	5	150200	782.0	DFT-s-OFDM QPSK	25@0	0.0000	PASS	NV
13	15	5	150200	782.0	DFT-s-OFDM QPSK	25@0	0.0005	PASS	LV
13	15	5	150200	782.0	DFT-s-OFDM QPSK	25@0	0.0014	PASS	HV
13	15	5	150200	782.0	DFT-s-OFDM QPSK	25@0	0.0014	PASS	-30°C
13	15	5	150200	782.0	DFT-s-OFDM QPSK	25@0	0.0028	PASS	-20°C
13	15	5	150200	782.0	DFT-s-OFDM QPSK	25@0	0.0009	PASS	-10°C
13	15	5	150200	782.0	DFT-s-OFDM QPSK	25@0	0.0009	PASS	0°C
13	15	5	150200	782.0	DFT-s-OFDM QPSK	25@0	0.0008	PASS	10°C
13	15	5	150200	782.0	DFT-s-OFDM QPSK	25@0	0.0000	PASS	20°C
13	15	5	150200	782.0	DFT-s-OFDM QPSK	25@0	0.0033	PASS	30°C
13	15	5	150200	782.0	DFT-s-OFDM QPSK	25@0	0.0018	PASS	40°C
13	15	5	150200	782.0	DFT-s-OFDM QPSK	25@0	0.0001	PASS	50°C



## Peak to Average Ratio

NR Band	SCS (kHz)	Bandwidth (MHz)	Arfcn	Freq (MHz)	Modulation	RB	Result (dB)	Limit (dB)	Verdict
13	15	5	149700	779.5	DFT-s-OFDM PI/2 BPSK	25@0	4.01	13	PASS
13	15	5	149700	779.5	DFT-s-OFDM PI/2 BPSK	1@0	3.98	13	PASS
13	15	5	149700	779.5	DFT-s-OFDM QPSK	25@0	4.66	13	PASS
13	15	5	149700	779.5	DFT-s-OFDM QPSK	1@0	4.58	13	PASS
13	15	5	150200	782.0	DFT-s-OFDM PI/2 BPSK	25@0	4.04	13	PASS
13	15	5	150200	782.0	DFT-s-OFDM PI/2 BPSK	1@0	4.01	13	PASS
13	15	5	150200	782.0	DFT-s-OFDM QPSK	25@0	4.51	13	PASS
13	15	5	150200	782.0	DFT-s-OFDM QPSK	1@0	4.63	13	PASS
13	15	5	150700	784.5	DFT-s-OFDM PI/2 BPSK	25@0	3.69	13	PASS
13	15	5	150700	784.5	DFT-s-OFDM PI/2 BPSK	1@0	3.95	13	PASS
13	15	5	150700	784.5	DFT-s-OFDM QPSK	25@0	4.32	13	PASS
13	15	5	150700	784.5	DFT-s-OFDM QPSK	1@0	4.58	13	PASS

N13(5M)\_DFT-s-OFDM\_PI\_2-BPSK\_Outer\_Full\_Low\_CH



N13(5M)\_DFT-s-OFDM\_PI\_2-BPSK\_Edge\_1RB\_Left\_Low\_CH



N13(5M)\_DFT-s-OFDM\_QPSK\_Outer\_Full\_Low\_CH

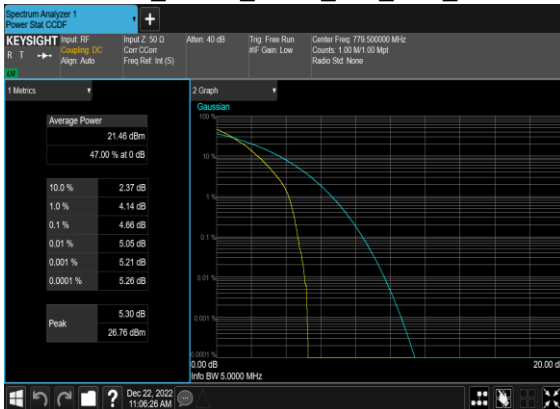

N13(5M)\_DFT-s-OFDM\_QPSK\_Edge\_1RB\_Left\_Low\_CH



N13(5M)\_DFT-s-OFDM\_PI\_2-BPSK\_Outer\_Full\_Mid\_CH



N13(5M)\_DFT-s-OFDM\_PI\_2-BPSK\_Edge\_1RB\_Left\_Mid\_CH

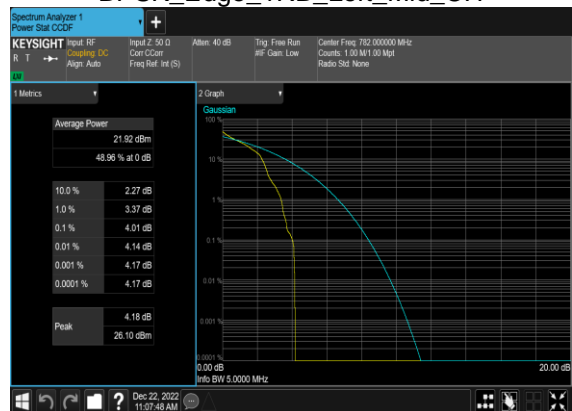

N13(5M)\_DFT-s-OFDM\_QPSK\_Outer\_Full\_Mid\_CH

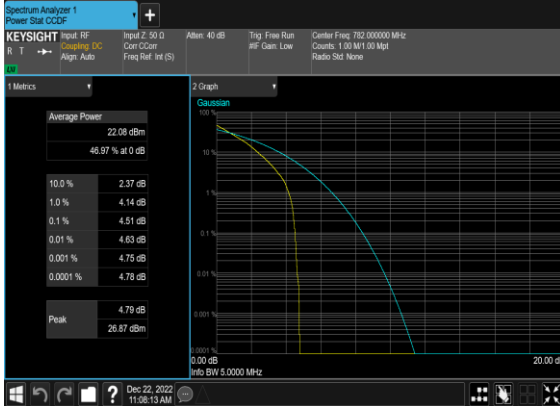

N13(5M)\_DFT-s-OFDM\_QPSK\_Edge\_1RB\_Left\_Mid\_CH

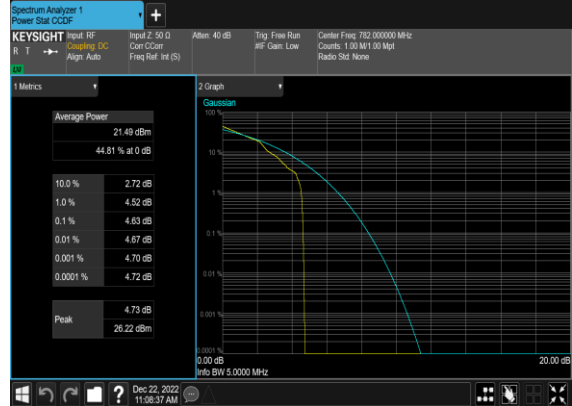

N13(5M)\_DFT-s-OFDM\_PI\_2-BPSK\_Outer\_Full\_High\_CH



N13(5M)\_DFT-s-OFDM\_PI\_2-BPSK\_Edge\_1RB\_Left\_High\_CH



N13(5M)\_DFT-s-OFDM\_QPSK\_Outer\_Full\_High\_CH

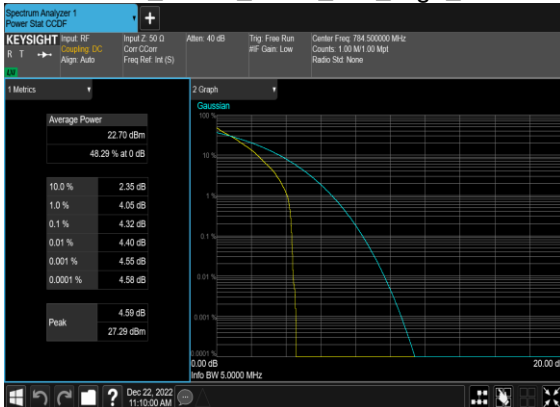

N13(5M)\_DFT-s-OFDM\_QPSK\_Edge\_1RB\_Left\_High\_CH



## Occupied Bandwidth

NR Band	SCS (kHz)	Bandwidth (MHz)	Arfcn	Freq (MHz)	Modulation	RB	OBW (MHz)	26dB BW (MHz)
13	15	5	150200	782.0	DFT-s-OFDM PI/2 BPSK	25@0	4.4887	4.983
13	15	5	150200	782.0	DFT-s-OFDM QPSK	25@0	4.4645	4.998
13	15	5	150200	782.0	CP-OFDM QPSK	25@0	4.4735	5.036
13	15	5	150200	782.0	CP-OFDM 16 QAM	25@0	4.4954	5.219
13	15	5	150200	782.0	CP-OFDM 64 QAM	25@0	4.4646	4.93
13	15	5	150200	782.0	CP-OFDM 256 QAM	25@0	4.4734	5.078
13	15	10	150200	782.0	DFT-s-OFDM PI/2 BPSK	50@0	8.8811	9.485
13	15	10	150200	782.0	DFT-s-OFDM QPSK	50@0	8.9009	9.658
13	15	10	150200	782.0	CP-OFDM QPSK	52@0	9.2584	9.916
13	15	10	150200	782.0	CP-OFDM 16 QAM	52@0	9.2791	9.876
13	15	10	150200	782.0	CP-OFDM 64 QAM	52@0	9.2375	9.78
13	15	10	150200	782.0	CP-OFDM 256 QAM	52@0	9.2598	9.974