



FCC RF Test Report

APPLICANT : Motorola Mobility LLC
EQUIPMENT : Mobile Cellular Phone
BRAND NAME : Motorola
MODEL NAME : XT2321-1
FCC ID : IHDT56AJ5
STANDARD : 47 CFR Part 2, 24(E), 27(L)
CLASSIFICATION : PCS Licensed Transmitter Held to Ear (PCE)
TEST DATE(S) : Jan. 17, 2023 ~ Feb. 27, 2023

We, Sporton International Inc. (ShenZhen), would like to declare that the tested sample has been evaluated in accordance with the procedures given in ANSI C63.26-2015 and shown compliance with the applicable technical standards.

This report contains data that were produced under subcontract by Sporton International Inc. (Kunshan).

The test results in this report apply exclusively to the tested model / sample. Without written approval of Sporton International Inc. (ShenZhen), the test report shall not be reproduced except in full.

Jason Jia



Approved by: Jason Jia

Sporton International Inc. (ShenZhen)

1/F, 2/F, Bldg 5, Shiling Industrial Zone, Xinwei Village, Xili, Nanshan, Shenzhen, 518055

People's Republic of China



TABLE OF CONTENTS

REVISION HISTORY..... 3

SUMMARY OF TEST RESULT 4

1 GENERAL DESCRIPTION 5

 1.1 Applicant..... 5

 1.2 Manufacturer 5

 1.3 Product Feature of Equipment Under Test 5

 1.4 Product Specification of Equipment Under Test 6

 1.5 Specification of Accessory 7

 1.6 Modification of EUT 7

 1.7 Maximum EIRP and Emission Designator 7

 1.8 Testing Location 8

 1.9 Test Software 9

 1.10 Applicable Standards 9

2 TEST CONFIGURATION OF EQUIPMENT UNDER TEST 10

 2.1 Test Mode..... 10

 2.2 Connection Diagram of Test System 10

 2.3 Support Unit used in test configuration 11

 2.4 Measurement Results Explanation Example 11

 2.5 Frequency List of Low/Middle/High Channels..... 11

3 CONDUCTED TEST RESULT..... 12

 3.1 Measuring Instruments..... 12

 3.2 Test Setup 12

 3.3 Test Result of Conducted Test..... 12

 3.4 Conducted Output Power and EIRP 13

 3.5 Peak-to-Average Ratio 14

 3.6 99% Occupied Bandwidth and 26dB Bandwidth Measurement..... 15

 3.7 Conducted Band Edge 16

 3.8 Conducted Spurious Emission 17

 3.9 Frequency Stability..... 18

4 RADIATED TEST ITEMS 19

 4.1 Measuring Instruments..... 19

 4.2 Test Setup 19

 4.3 Test Result of Radiated Test..... 20

 4.4 Field Strength of Spurious Radiation Measurement 21

5 LIST OF MEASURING EQUIPMENT 22

6 UNCERTAINTY OF EVALUATION 23

APPENDIX A. TEST RESULTS OF CONDUCTED TEST

APPENDIX B. TEST RESULTS OF RADIATED TEST

APPENDIX C. TEST SETUP PHOTOGRAPHS



SUMMARY OF TEST RESULT

Report Section	FCC Rule	Description	Limit	Result	Remark
3.4	§2.1046	Conducted Output Power	-	Report Only	-
	§24.232(c)	Equivalent Isotropic Radiated Power	< 2 Watts	PASS	-
	§27.50(d)(4)	Equivalent Isotropic Radiated Power	< 1 Watts	PASS	-
3.5	§24.232(d)	Peak-to-Average Ratio	< 13 dB	PASS	-
3.6	§2.1049	Occupied Bandwidth	Reporting Only	PASS	-
3.7	§2.1051 §24.238(a) §27.53(h)	Band Edge Measurement	< 43+10log10(P[Watts])	PASS	-
3.8	§2.1051 §24.238(a) §27.53(h)	Conducted Emission	< 43+10log10(P[Watts])	PASS	-
3.9	§2.1055 §24.235 §27.54	Frequency Stability for Temperature & Voltage	Within Authorized Band	PASS	-
4.4	§2.1053; §24.238(a); §27.53(h)	Field Strength of Spurious Radiation	< 43+10log10(P[Watts])	PASS	Under limit 38.17 dB at 5722.800 MHz

Declaration of Conformity:

The test results with all measurement uncertainty excluded are presented in accordance with the regulation limits or requirements declared by manufacturers.

Comments and Explanations:

The declared of product specification for EUT presented in the report are provided by the manufacturer, and the manufacturer takes all the responsibilities for the accuracy of product specification.



1 General Description

1.1 Applicant

Motorola Mobility LLC
222 W,Merchandise Mart Plaza, Chicago IL 60654 USA

1.2 Manufacturer

Motorola Mobility LLC
222 W,Merchandise Mart Plaza, Chicago IL 60654 USA

1.3 Product Feature of Equipment Under Test

Product Feature	
Equipment	Mobile Cellular Phone
Brand Name	Motorola
Model Name	XT2321-1
FCC ID	IHDT56AJ5
IMEI Code	Conducted: 356909990009013/356909990009021 for B2 356909990009294/356909990009302 for B4 Radiation: 356909990009575/356909990009583 for B2 356909990009294/356909990009302 for B4
HW Version	DVT2
SW Version	TTZ33.61
EUT Stage	Identical Prototype

Remark:

1. The above EUT's information was declared by manufacturer. Please refer to the specifications or user's manual for more detailed description.
2. The EUT has two working states, flip open state and flip close state, by verifying these two states, we choose the worst flip open state for all tests.

1.4 Product Specification of Equipment Under Test

Standards-related Product Specification	
Tx Frequency	WCDMA: Band II: 1850 MHz ~ 1910 MHz Band IV: 1710 MHz ~ 1755 MHz
Rx Frequency	WCDMA: Band II: 1930 MHz ~ 1990 MHz Band IV: 2110 MHz ~ 2155 MHz
Maximum Output Power to Antenna	Ant.0: WCDMA: Band IV: 21.99 dBm Ant.1: WCDMA: Band IV: 22.96 dBm Ant.2: WCDMA: Band II: 23.17 dBm Band IV: 23.34 dBm Ant.3: WCDMA: Band II: 24.25 dBm Band IV: 24.34 dBm
Antenna Type	Ant.0/1/2: Monopole Antenna Ant.3: Loop Antenna
Antenna Gain	Ant.0: AWS Band: -2.20 dBi Ant.1: AWS Band: -2.64 dBi Ant.2: PCS Band: -2.43 dBi AWS Band: -4.65 dBi Ant.3: PCS Band: -3.61 dBi AWS Band: -3.73 dBi
Type of Modulation	GSM: GMSK GPRS: GMSK EDGE: GMSK / 8PSK WCDMA : BPSK HSDPA/DC-HSDPA : QPSK HSUPA : QPSK HSPA+ : 16QAM(16QAM uplink is not supported) DC-HSDPA : 64QAM

Note: The maximum EIRP is calculated from max output power and max antenna gain, so only the maximum EIRP is shown in the report, Ant.2 for Band II & Ant.3 for Band IV.

1.5 Specification of Accessory

Specification of Accessory				
AC Adapter 1(US)	Brand Name	Motorola(Salcomp)	Model Name	MC-331
AC Adapter 1 (EU)	Brand Name	Motorola(Salcomp)	Model Name	MC-332
AC Adapter 1 (UK)	Brand Name	Motorola(Salcomp)	Model Name	MC-333
AC Adapter 1(AU)	Brand Name	Motorola(Salcomp)	Model Name	MC-335
AC Adapter 1(AR)	Brand Name	Motorola(Salcomp)	Model Name	MC-336
AC Adapter 1(BR)	Brand Name	Motorola(Salcomp)	Model Name	MC-337
AC Adapter 1(CHILE)	Brand Name	Motorola(Salcomp)	Model Name	MC-339
AC Adapter 1(KR)	Brand Name	Motorola(Salcomp)	Model Name	MC-330
AC Adapter 2(IN)	Brand Name	Motorola(Salcomp)	Model Name	MC-334
Battery 1	Brand Name	Motorola(ATL)	Model Name	PM29
Battery 2	Brand Name	Motorola(ATL)	Model Name	PM08
USB Cable 1	Brand Name	Motorola(Saibao)	Model Name	SC18D22297
USB Cable 2	Brand Name	Motorola(Cabletech)	Model Name	SC18D22298
USB Cable 3	Brand Name	Motorola(Luxshare)	Model Name	SC18D22299

1.6 Modification of EUT

No modifications are made to the EUT during all test items.

1.7 Maximum EIRP and Emission Designator

FCC Rule	Frequency Band	Frequency Range (MHz)	Type of Modulation	Maximum EIRP (W)	Emission Designator
Part 24	WCDMA Band II	1852.4 ~ 1907.6	BPSK	0.1186	4M20F9W
Part 27	WCDMA Band IV	1712.4 ~ 1752.6	BPSK	0.1151	4M15F9W



1.8 Testing Location

Sporton International Inc. (ShenZhen) is accredited to ISO/IEC 17025:2017 by American Association for Laboratory Accreditation with Certificate Number 5145.01.

Test Firm	Sporton International Inc. (ShenZhen)		
Test Site Location	1/F, 2/F, Bldg 5, Shiling Industrial Zone, Xinwei Village, Xili, Nanshan, Shenzhen, 518055 People's Republic of China TEL: +86-755-86379589 FAX: +86-755-86379595		
Test Site No.	Sporton Site No.	FCC Designation No.	FCC Test Firm Registration No.
	TH01-SZ	CN1256	421272

Test Firm	Sporton International Inc. (ShenZhen)		
Test Site Location	101, 1st Floor, Block B, Building 1, No. 2, Tengfeng 4th Road, Fenghuang Community, Fuyong Street, Baoan District, Shenzhen City Guangdong Province China 518103 TEL: +86-755-33202398		
Test Site No.	Sporton Site No.	FCC Designation No.	FCC Test Firm Registration No.
	03CH01-SZ	CN1256	421272

Sporton International Inc. (Kunshan) is accredited to ISO/IEC 17025:2017 by American Association for Laboratory Accreditation with Certificate Number 5145.02.

Test Firm	Sporton International Inc. (Kunshan)		
Test Site Location	No. 1098, Pengxi North Road, Kunshan Economic Development Zone Jiangsu Province 215300 People's Republic of China TEL : +86-512-57900158 FAX : +86-512-57900958		
Test Site No.	Sporton Site No.	FCC Designation No.	FCC Test Firm Registration No.
	03CH04-KS TH01-KS	CN1257	314309

Test data subcontracted: Test cases for WCDMA Band IV in section 3/4 of this report.



1.9 Test Software

Item	Site	Manufacturer	Name	Version
1.	03CH01-SZ	AUDIX	E3	6.2009-8-24
2.	03CH04-KS	AUDIX	E3	6.2009-8-24al

1.10 Applicable Standards

According to the specifications of the manufacturer, the EUT must comply with the requirements of the following standards:

- ♦ 47 CFR Part 2, 24(E), 27(L)
- ♦ ANSI C63.26-2015
- ♦ FCC KDB 971168 D01 Power Meas. License Digital Systems v03r01
- ♦ FCC KDB 412172 D01 Determining ERP and EIRP v01r01

Remark:

1. All test items were verified and recorded according to the standards and without any deviation during the test.
2. This EUT has also been tested and complied with the requirements of FCC Part 15, Subpart B, recorded in a separate test report.

2 Test Configuration of Equipment Under Test

2.1 Test Mode

Antenna port conducted and radiated test items were performed according to KDB 971168 D01 Power Meas. License Digital Systems v03r01 with maximum output power.

Radiated measurements were performed with rotating EUT in different three orthogonal test planes to find the maximum emission.(X Plane)

Radiated emissions were investigated as following frequency range:

1. 30 MHz to 19100 MHz for WCDMA Band II.
2. 30 MHz to 18000 MHz for WCDMA Band IV.

All modes and data rates and positions were investigated.

Test modes are chosen to be reported as the worst case configuration below:

Test Modes		
Band	Radiated TCs	Conducted TCs
WCDMA Band II	■ RMC 12.2Kbps Link	■ RMC 12.2Kbps Link
WCDMA Band IV	■ RMC 12.2Kbps Link	■ RMC 12.2Kbps Link

2.2 Connection Diagram of Test System

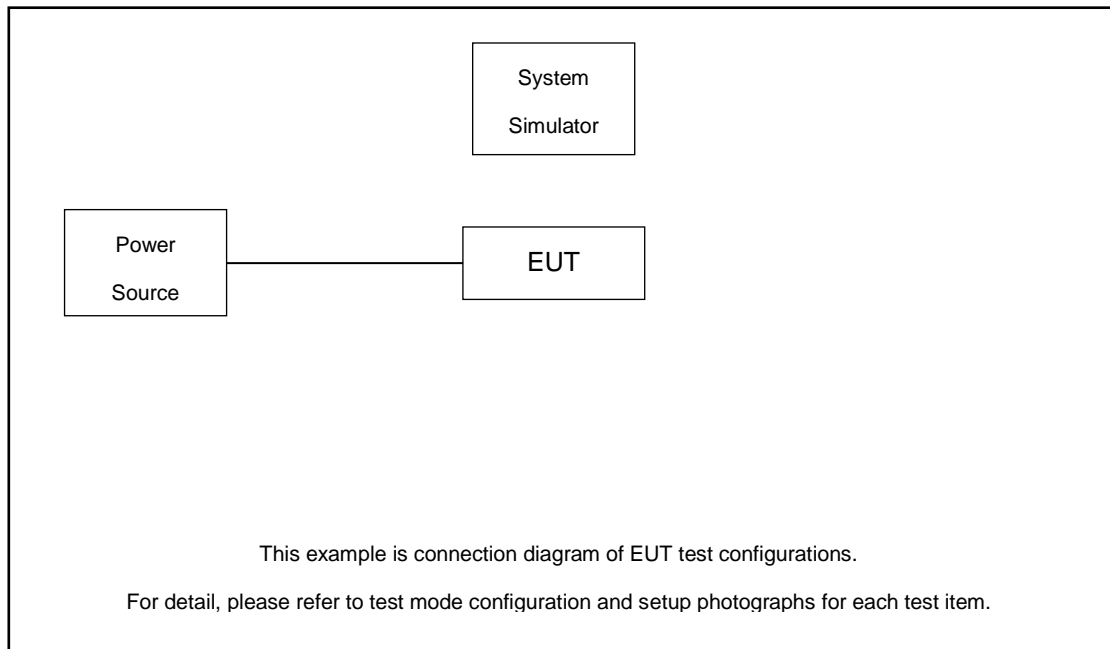

The EUT has been configuration operated in a manner tended to maximize its emission characteristics in a typical application.



2.3 Support Unit used in test configuration

Item	Equipment	Trade Name	Model No.	FCC ID	Data Cable	Power Cord
1.	Base Station	Anritsu	MT8820C	Fcc DoC	N/A	Unshielded, 1.8 m

2.4 Measurement Results Explanation Example

For all conducted test items:

The offset level is set in the spectrum analyzer to compensate the RF cable loss and attenuator factor between RF conducted output port and spectrum analyzer. With the offset compensation, the spectrum analyzer reading level will be exactly the RF output level.

The spectrum analyzer offset is derived from RF cable loss and attenuator factor.

$$\text{Offset} = \text{RF cable loss} + \text{attenuator factor}.$$

The following shows an offset computation example with RF cable loss 4.6 dB and a 10dB attenuator.

Example :

$$\begin{aligned} \text{Offset(dB)} &= \text{RF cable loss(dB)} + \text{attenuator factor(dB)}. \\ &= 4.5 + 10 = 14.5 \text{ (dB)} \end{aligned}$$

2.5 Frequency List of Low/Middle/High Channels

Frequency List				
Band	Channel/Frequency(MHz)	Lowest	Middle	Highest
WCDMA Band II	Channel	9262	9400	9538
	Frequency	1852.4	1880.0	1907.6
WCDMA Band IV	Channel	1312	1413	1513
	Frequency	1712.4	1732.6	1752.6

3 Conducted Test Result

3.1 Measuring Instruments

See list of measuring instruments of this test report.

3.2 Test Setup

3.2.1 Conducted Output Power



3.2.2 Peak-to-Average Ratio, Occupied Bandwidth, Conducted Band-Edge and Conducted Spurious Emission

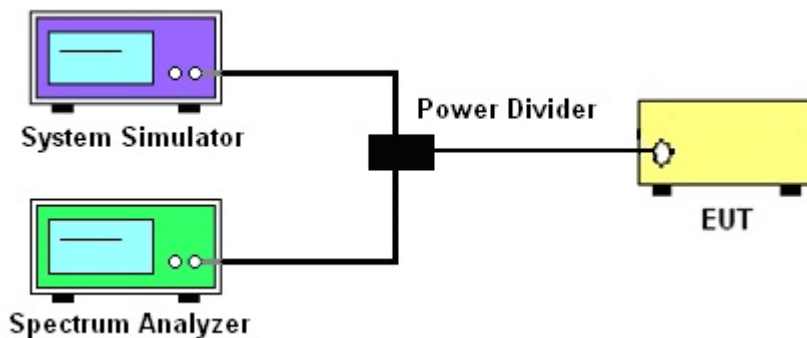

3.2.3 Frequency Stability

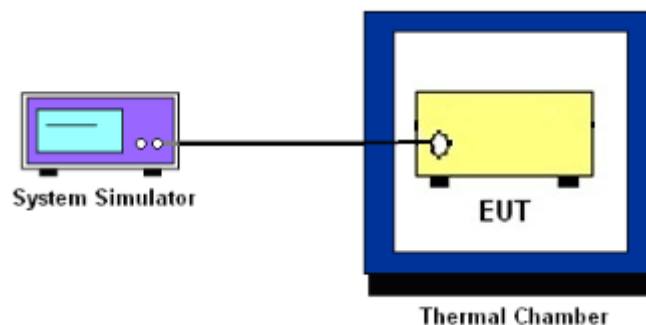

3.3 Test Result of Conducted Test

Please refer to Appendix A.



3.4 Conducted Output Power and EIRP

3.4.1 Description of the Conducted Output Power and EIRP

A system simulator was used to establish communication with the EUT. Its parameters were set to enforce EUT transmitting at the maximum power. The measured power in the radio frequency on the transmitter output terminals shall be reported.

The EIRP of mobile transmitters must not exceed 2 Watts for WCDMA Band II.

The EIRP of mobile transmitters must not exceed 1 Watts for WCDMA Band IV.

According to KDB 412172 D01 Power Approach,

$EIRP = P_T + G_T - L_C$, $ERP = EIRP - 2.15$, where

P_T = transmitter output power in dBm

G_T = gain of the transmitting antenna in dBi

L_C = signal attenuation in the connecting cable between the transmitter and antenna in dB

3.4.2 Test Procedures

1. The testing follows ANSI C63.26 Section 5.2
2. The transmitter output port was connected to the system simulator.
3. Set EUT at maximum power through the system simulator.
4. Select lowest, middle, and highest channels for each band and different modulation.
5. Measure and record the power level from the system simulator.



3.5 Peak-to-Average Ratio

3.5.1 Description of the PAR Measurement

The peak-to-average ratio (PAR) of the transmission may not exceed 13 dB.

3.5.2 Test Procedures

1. The testing follows ANSI C63.26 Section 5.2.3.4 (CCDF).
2. The EUT was connected to spectrum and system simulator via a power divider.
3. Set the CCDF (Complementary Cumulative Distribution Function) option in spectrum analyzer.
4. The highest RF powers were measured and recorded the maximum PAPR level associated with a probability of 0.1 %.
5. Record the deviation as Peak to Average Ratio.



3.6 99% Occupied Bandwidth and 26dB Bandwidth Measurement

3.6.1 Description of 99% Occupied Bandwidth and 26dB Bandwidth Measurement

The occupied bandwidth is the width of a frequency band such that, below the lower and above the upper frequency limits, the mean powers emitted are each equal to a specified percentage 0.5% of the total mean transmitted power.

The 26 dB emission bandwidth is defined as the frequency range between two points, one above and one below the carrier frequency, at which the spectral density of the emission is attenuated 26 dB below the maximum in-band spectral density of the modulated signal. Spectral density (power per unit bandwidth) is to be measured with a detector of resolution bandwidth equal to approximately 1.0% of the emission bandwidth.

3.6.2 Test Procedures

1. The testing follows ANSI C63.26 Section 5.4
2. The EUT was connected to spectrum analyzer and system simulator via a power divider.
3. The spectrum analyzer center frequency is set to the nominal EUT channel center frequency. The span range for the spectrum analyzer shall be between two and five times the anticipated OBW.
4. The nominal resolution bandwidth (RBW) shall be in the range of 1 to 5 % of the anticipated OBW, and the VBW shall be at least 3 times the RBW.
5. Set the detection mode to peak, and the trace mode to max hold.
6. Determine the reference value: Set the EUT to transmit a modulated signal. Allow the trace to stabilize. Set the spectrum analyzer marker to the highest level of the displayed trace. (this is the reference value)
7. Determine the “-26 dB down amplitude” as equal to (Reference Value – X).
8. Place two markers, one at the lowest and the other at the highest frequency of the envelope of the spectral display such that each marker is at or slightly below the “-X dB down amplitude” determined in step 6. If a marker is below this “-X dB down amplitude” value it shall be placed as close as possible to this value. The OBW is the positive frequency difference between the two markers.
9. Use the 99 % power bandwidth function of the spectrum analyzer and report the measured bandwidth.



3.7 Conducted Band Edge

3.7.1 Description of Conducted Band Edge Measurement

The power of any emission outside of the authorized operating frequency ranges must be lower than the transmitter power (P) by a factor of at least $43 + 10 \log (P)$ dB.

3.7.2 Test Procedures

1. The testing follows ANSI C63.26 section 5.7
2. The EUT was connected to the spectrum analyzer and system simulator via a power divider.
3. The RF output of EUT was connected to the spectrum analyzer by an RF cable and attenuator. The path loss was compensated to the results for each measurement.
4. The band edges of low and high channels for the highest RF powers were measured.
5. The RF fundamental frequency should be excluded against the limit line in the operating frequency band.
6. The limit line is derived from $43 + 10\log(P)$ dB below the transmitter power P(Watts)



3.8 Conducted Spurious Emission

3.8.1 Description of Conducted Spurious Emission Measurement

The power of any emission outside of the authorized operating frequency ranges must be lower than the transmitter power (P) by a factor of at least $43 + 10 \log (P)$ dB.

It is measured by means of a calibrated spectrum analyzer and scanned from 30 MHz up to a frequency including its 10th harmonic.

3.8.2 Test Procedures

1. The testing follows ANSI C63.26 section 5.7
2. The EUT was connected to the spectrum analyzer and system simulator via a power divider.
3. The RF output of EUT was connected to the spectrum analyzer by an RF cable and attenuator. The path loss was compensated to the results for each measurement.
4. The middle channel for the highest RF power within the transmitting frequency was measured.
5. The conducted spurious emission for the whole frequency range was taken.
6. The RF fundamental frequency should be excluded against the limit line in the operating frequency band.
7. The limit line is derived from $43 + 10\log(P)$ dB below the transmitter power P(Watts)



3.9 Frequency Stability

3.9.1 Description of Frequency Stability Measurement

The frequency stability shall be measured by variation of ambient temperature and variation of primary supply voltage to ensure that the fundamental emission stays within the authorized frequency block.

3.9.2 Test Procedures for Temperature Variation

1. The testing follows ANSI C63.26 section 5.6.4
2. The EUT was set up in the thermal chamber and connected with the system simulator.
3. With power OFF, the temperature was decreased to -30°C and the EUT was stabilized before testing. Power was applied and the maximum change in frequency was recorded within one minute.
4. With power OFF, the temperature was raised in 10°C step up to 50°C. The EUT was stabilized at each step for at least half an hour. Power was applied and the maximum frequency change was recorded within one minute.

3.9.3 Test Procedures for Voltage Variation

1. The testing follows ANSI C63.26 section 5.6.5
2. The EUT was placed in a temperature chamber at 20±5°C and connected with the system simulator.
3. The power supply voltage to the EUT was varied from 85% to 115% of the nominal value for other than hand carried battery equipment.
4. For hand carried, battery powered equipment, reduce the primary ac or dc supply voltage to the battery operating end point, which shall be specified by the manufacturer.
5. The variation in frequency was measured for the worst case.

4 Radiated Test Items

4.1 Measuring Instruments

See list of measuring instruments of this test report.

4.2 Test Setup

4.2.1 For radiated test below 30MHz

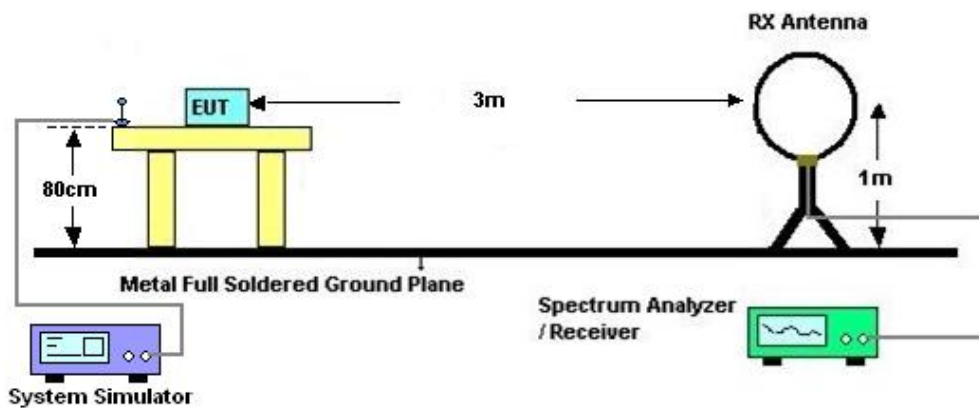

4.2.2 For radiated test from 30MHz to 1GHz

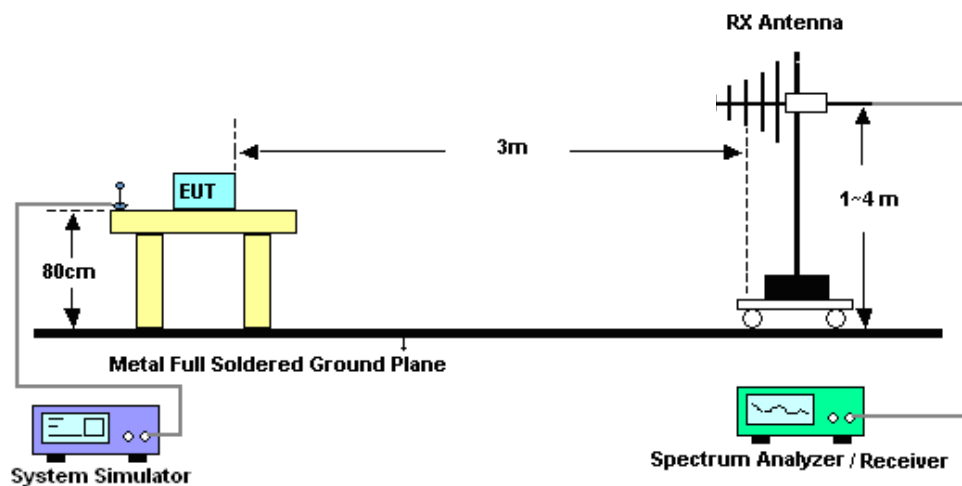

4.2.3 For radiated test above 1GHz

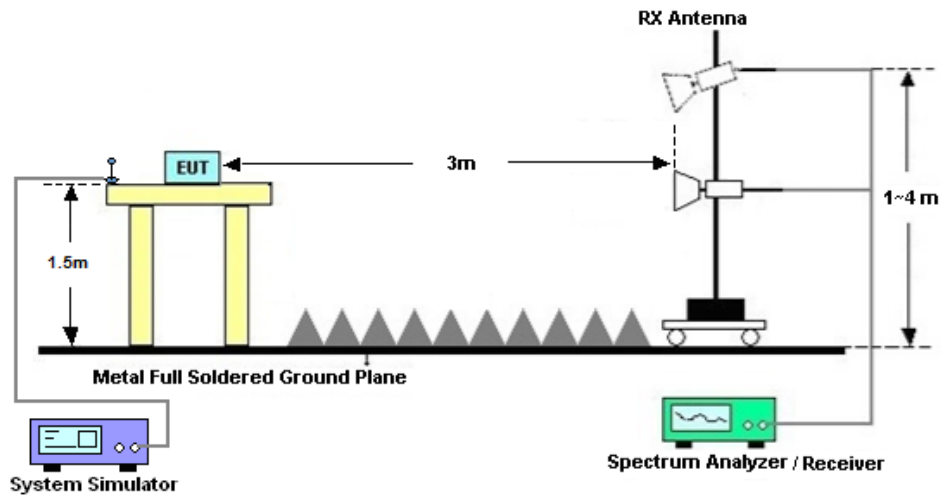

4.3 Test Result of Radiated Test

The low frequency, which started from 9 kHz to 30MHz, was pre-scanned and the result which was 20dB lower than the limit line was not reported.

Please refer to Appendix B.



4.4 Field Strength of Spurious Radiation Measurement

4.4.1 Description of Field Strength of Spurious Radiated Measurement

The power of any emission outside of the authorized operating frequency ranges must be attenuated below the transmitter power (P) by a factor of at least $43 + 10 \log (P)$ dB. The spectrum is scanned from 30 MHz up to a frequency including its 10th harmonic.

4.4.2 Test Procedures

1. The testing follows ANSI C63.26 Section 5.5
2. The EUT was placed on a rotatable wooden table 0.8 meters for frequency below 1GHz and 1.5 meter for frequency above 1GHz above the ground.
3. The EUT was set 3 meters from the receiving antenna, which was mounted on the antenna tower.
4. The table was rotated 360 degrees to determine the position of the highest spurious emission.
5. The height of the receiving antenna is varied between one meter and four meters to search for the maximum spurious emission for both horizontal and vertical polarizations.
6. Make the measurement with the spectrum analyzer's RBW = 1MHz, VBW = 3MHz, taking record of maximum spurious emission.
7. A horn antenna was substituted in place of the EUT and was driven by a signal generator.
8. Tune the output power of signal generator to the same emission level with EUT maximum spurious emission.
9. Taking the record of output power at antenna port.
10. Repeat step 7 to step 8 for another polarization.
11. $EIRP \text{ (dBm)} = S.G. \text{ Power} - Tx \text{ Cable Loss} + Tx \text{ Antenna Gain}$
12. $ERP \text{ (dBm)} = EIRP - 2.15$
13. The RF fundamental frequency should be excluded against the limit line in the operating frequency band.
14. The limit line is derived from $43 + 10\log(P)$ dB below the transmitter power P(Watts)



5 List of Measuring Equipment

Instrument	Manufacturer	Model No.	Serial No.	Characteristics	Calibration Date	Test Date	Due Date	Remark
Spectrum Analyzer	R&S	FSV40	101078	10Hz~40GHz	Apr. 07, 2022	Jan. 17, 2023~ Feb. 01, 2023	Apr. 06, 2023	Conducted (TH01-SZ)
Power Divider	TOJOIN	PS-2SM-04 265	60.06.020.007 7	0.4GHz~26.5GHz	Dec. 25, 2022	Jan. 17, 2023~ Feb. 01, 2023	Dec. 24, 2023	Conducted (TH01-SZ)
Thermal Chamber	Ten Billion Hongzhangroup	LP-150U	H2014081803	-40~+150°C	Jul. 07, 2022	Jan. 17, 2023~ Feb. 01, 2023	Jul. 06, 2023	Conducted (TH01-SZ)
EMI Test Receiver&SA	Agilent	N9038A	MY52260185	20Hz~26.5GHz	Dec. 26, 2022	Jan. 17, 2023	Dec. 25, 2023	Radiation (03CH01-SZ)
Loop Antenna	R&S	HFH2-Z2	100354	9kHz~30MHz	Jul. 28, 2022	Jan. 17, 2023	Jul. 27, 2024	Radiation (03CH01-SZ)
HF Amplifier	KEYSIGHT	83017A	MY53270105	0.5GHz~26.5Ghz	Oct. 19, 2022	Jan. 17, 2023	Oct. 18, 2023	Radiation (03CH01-SZ)
Bilog Antenna	TeseQ	CBL6112D	35407	30MHz-2GHz	Sep. 28, 2022	Jan. 17, 2023	Sep. 27, 2023	Radiation (03CH01-SZ)
Double Ridge Horn Antenna	ETS-Lindgren	3117	00119436	1GHz~18GHz	Jul. 07, 2022	Jan. 17, 2023	Jul. 06, 2023	Radiation (03CH01-SZ)
SHF-EHF Horn	com-power	AH-840	101071	18Ghz-40GHz	Apr. 10, 2022	Jan. 17, 2023	Apr. 09, 2023	Radiation (03CH01-SZ)
LF Amplifier	Burgeon	BPA-530	102209	0.01~3000Mhz	Apr. 06, 2022	Jan. 17, 2023	Apr. 05, 2023	Radiation (03CH01-SZ)
HF Amplifier	MITEQ	AMF-7D-00 101800-30-1 0P-R	1943528	1GHz~18GHz	Oct. 19, 2022	Jan. 17, 2023	Oct. 18, 2023	Radiation (03CH01-SZ)
HF Amplifier	MITEQ	TTA1840-35 -HG	1871923	18GHz~40GHz	Jul. 06, 2022	Jan. 17, 2023	Jul. 05, 2023	Radiation (03CH01-SZ)
AC Power Source	Chroma	61601	61601000198 5	N/A	Nov. 10, 2022	Jan. 17, 2023	Nov. 09, 2023	Radiation (03CH01-SZ)
Turn Table	EM	EM1000	N/A	0~360 degree	NCR	Jan. 17, 2023	NCR	Radiation (03CH01-SZ)
Antenna Mast	EM	EM1000	N/A	1 m~4 m	NCR	Jan. 17, 2023	NCR	Radiation (03CH01-SZ)
Spectrum Analyzer	R&S	FSV40	101040	10Hz~40GHz	Oct. 12, 2022	Feb. 27, 2023	Oct. 11, 2023	Conducted (TH01-KS)
Power divider	STI	STI08-0055	-	0.5~40GHz	NCR	Feb. 27, 2023	NCR	Conducted (TH01-KS)
Temperature & humidity chamber	Hongzhan	LP-150U	H2014011440	-40~+150°C 20%~95%RH	Jul. 15, 2022	Feb. 27, 2023	Jul. 14, 2023	Conducted (TH01-KS)
EXA Spectrum Analyzer	Keysight	N9010B	MY57471079	10Hz-44G,MAX 30dB	Oct. 12, 2022	Feb. 27, 2023	Oct. 11, 2023	Radiation (03CH04-KS)
Loop Antenna	R&S	HFH2-Z2	100321	9kHz~30MHz	Oct. 16, 2022	Feb. 27, 2023	Oct. 15, 2023	Radiation (03CH04-KS)
Bilog Antenna	TeseQ	CBL6111D	49922	30MHz-1GHz	May 24, 2022	Feb. 27, 2023	May 23, 2023	Radiation (03CH04-KS)
Horn Antenna	Schwarzbeck	BBHA9120D	1284	1GHz~18GHz	Oct. 16, 2022	Feb. 27, 2023	Oct. 15, 2023	Radiation (03CH04-KS)
Amplifier	SONOMA	310N	187289	9KHz-1GHz	May 24, 2022	Feb. 27, 2023	May 23, 2023	Radiation (03CH04-KS)
high gain Amplifier	EM	EM01G18G A	060840	1Ghz-18Ghz	Oct. 12, 2022	Feb. 27, 2023	Oct. 11, 2023	Radiation (03CH04-KS)
Amplifier	Agilent	8449B	3008A02370	1Ghz-18Ghz	Oct. 12, 2022	Feb. 27, 2023	Oct. 11, 2023	Radiation (03CH04-KS)
AC Power Source	Chroma	61601	F104090004	N/A	NCR	Feb. 27, 2023	NCR	Radiation (03CH04-KS)
Turn Table	ChamPro	EM 1000-T	060762-T	0~360 degree	NCR	Feb. 27, 2023	NCR	Radiation (03CH04-KS)
Antenna Mast	ChamPro	EM 1000-A	060762-A	1 m~4 m	NCR	Feb. 27, 2023	NCR	Radiation (03CH04-KS)

NCR: No Calibration Required



6 Uncertainty of Evaluation

The measurement uncertainties shown below were calculated in accordance with the requirements of ANSI 63.26-2015. All the measurement uncertainty value were shown with a coverage K=2 to indicate 95% level of confidence. The measurement data show herein meets or exceeds the CISPR measurement uncertainty values specified in CISPR 16-4-2 and can be compared directly to specified limit to determine compliance.

<Test Site: TH01-SZ>

Uncertainty of Conducted Measurement

Test Item	Uncertainty
Conducted Power	±1.34 dB
Conducted Emissions	±1.34 dB
Occupied Channel Bandwidth	±0.13 %

<Test Site: 03CH01-SZ>

Uncertainty of Radiated Emission Measurement (30 MHz ~ 1000 MHz)

Measuring Uncertainty for a Level of Confidence of 95% (U = 2Uc(y))	2.48dB
---	--------

Uncertainty of Radiated Emission Measurement (1 GHz ~ 18 GHz)

Measuring Uncertainty for a Level of Confidence of 95% (U = 2Uc(y))	3.53dB
---	--------

Uncertainty of Radiated Emission Measurement (18 GHz ~ 40 GHz)

Measuring Uncertainty for a Level of Confidence of 95% (U = 2Uc(y))	4.02dB
---	--------



<Test Site: TH01-KS>

Uncertainty of Conducted Measurement

Test Item	Uncertainty
Conducted Power	±0.46 dB
Conducted Emissions	±0.48 dB
Occupied Channel Bandwidth	±0.1 %

<Test Site: 03CH04-KS>

Uncertainty of Radiated Emission Measurement (30 MHz ~ 1000 MHz)

Measuring Uncertainty for a Level of Confidence of 95% (U = 2Uc(y))	3.3dB
---	-------

Uncertainty of Radiated Emission Measurement (1 GHz ~ 18 GHz)

Measuring Uncertainty for a Level of Confidence of 95% (U = 2Uc(y))	2.8dB
---	-------

----- THE END -----



Appendix A. Test Results of Conducted Test

Conducted Output Power (Average power)

Band		WCDMA Band II_Ant.2		
TX Channel		9262	9400	9538
Rx Channel		9662	9800	9938
Frequency (MHz)		1852.4	1880	1907.6
3GPP Rel 99	AMR 12.2Kbps	23.02	23.15	23.05
3GPP Rel 99	RMC 12.2Kbps	23.08	23.17	23.11
3GPP Rel 6	HSDPA Subtest-1	22.21	22.37	22.05
3GPP Rel 6	HSDPA Subtest-2	22.14	22.26	22.10
3GPP Rel 6	HSDPA Subtest-3	21.56	21.80	21.68
3GPP Rel 6	HSDPA Subtest-4	21.61	21.74	21.71
3GPP Rel 8	DC-HSDPA Subtest-1	22.15	22.32	22.16
3GPP Rel 8	DC-HSDPA Subtest-2	21.92	22.03	21.99
3GPP Rel 8	DC-HSDPA Subtest-3	21.46	21.56	21.55
3GPP Rel 8	DC-HSDPA Subtest-4	21.50	21.58	21.49
3GPP Rel 6	HSUPA Subtest-1	22.18	22.35	22.35
3GPP Rel 6	HSUPA Subtest-2	20.19	20.24	20.01
3GPP Rel 6	HSUPA Subtest-3	21.00	21.23	21.18
3GPP Rel 6	HSUPA Subtest-4	20.07	20.15	20.02
3GPP Rel 6	HSUPA Subtest-5	22.27	22.18	22.17

Band		WCDMA Band IV_Ant.3		
TX Channel		1312	1413	1513
Rx Channel		1537	1638	1738
Frequency (MHz)		1712.4	1732.6	1752.6
3GPP Rel 99	AMR 12.2Kbps	24.22	24.31	24.18
3GPP Rel 99	RMC 12.2Kbps	24.27	24.34	24.23
3GPP Rel 6	HSDPA Subtest-1	23.16	23.31	23.31
3GPP Rel 6	HSDPA Subtest-2	23.22	23.35	23.21
3GPP Rel 6	HSDPA Subtest-3	22.93	22.81	22.69
3GPP Rel 6	HSDPA Subtest-4	22.71	22.90	22.81
3GPP Rel 8	DC-HSDPA Subtest-1	23.28	23.34	23.23
3GPP Rel 8	DC-HSDPA Subtest-2	23.20	23.37	23.38
3GPP Rel 8	DC-HSDPA Subtest-3	22.53	22.77	22.61
3GPP Rel 8	DC-HSDPA Subtest-4	22.60	22.71	22.57
3GPP Rel 6	HSUPA Subtest-1	23.30	23.34	23.26
3GPP Rel 6	HSUPA Subtest-2	21.34	21.37	21.31
3GPP Rel 6	HSUPA Subtest-3	22.20	22.32	22.26
3GPP Rel 6	HSUPA Subtest-4	21.16	21.46	21.43
3GPP Rel 6	HSUPA Subtest-5	23.18	23.20	23.21



EIRP

WCDMA Band II ($G_T - L_C = -2.43$ dB)			
Channel	9262	9400	9538
	(Low)	(Mid)	(High)
Frequency	1852.4	1880	1907.6
(MHz)			
Conducted Power (dBm)	23.08	23.17	23.11
Conducted Power (Watts)	0.2032	0.2075	0.2046
EIRP(dBm)	20.65	20.74	20.68
EIRP(Watts)	0.1161	0.1186	0.1169

WCDMA Band IV ($G_T - L_C = -3.73$ dB)			
Channel	1312	1413	1513
	(Low)	(Mid)	(High)
Frequency	1712.4	1732.6	1752.6
(MHz)			
Conducted Power (dBm)	24.27	24.34	24.23
Conducted Power (Watts)	0.2673	0.2716	0.2649
EIRP(dBm)	20.54	20.61	20.50
EIRP(Watts)	0.1132	0.1151	0.1122



A1. WCDMA Band II

Peak-to-Average Ratio

Mode	WCDMA Band II(dB)	Limit: 13dB
Mod.	RMC 12.2Kbps	Result
Lowest CH	2.67	PASS
Middle CH	2.70	
Highest CH	2.46	

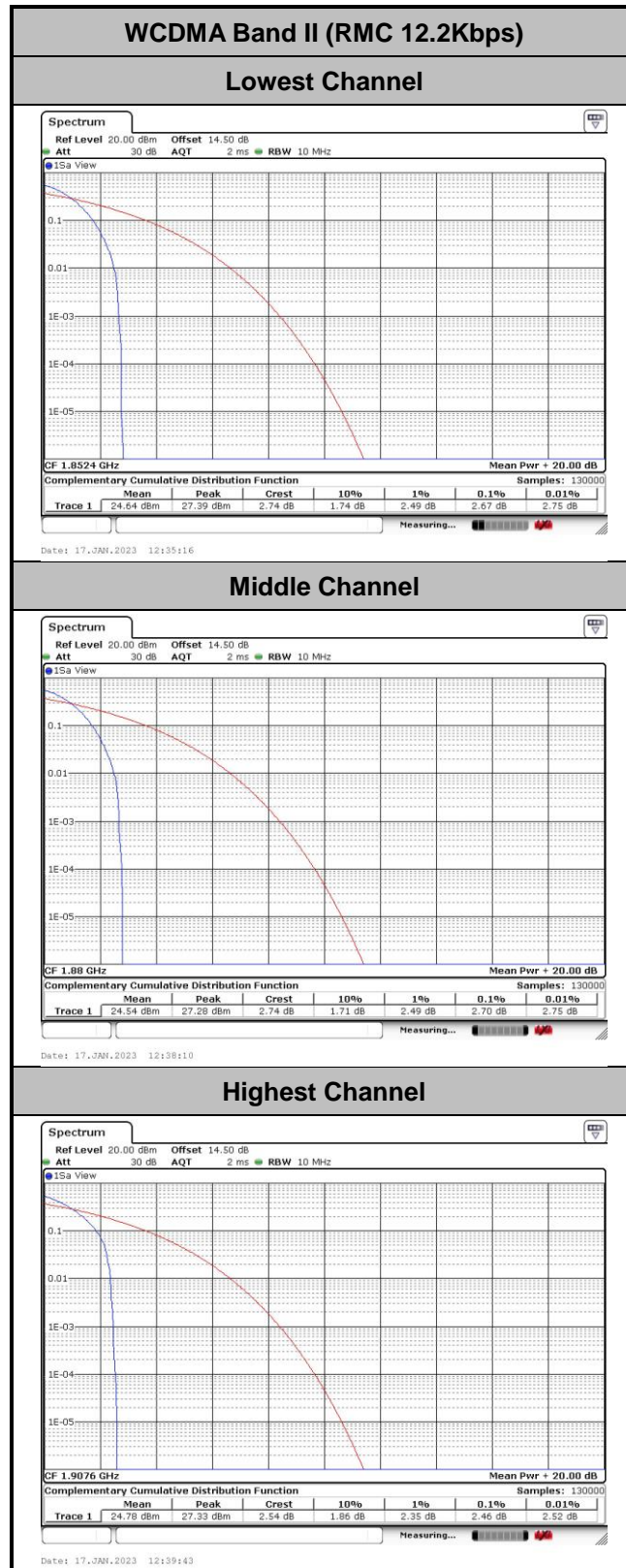



26dB Bandwidth

Mode	WCDMA Band II(MHz)
Mod.	RMC 12.2Kbps
Lowest CH	4.76
Middle CH	4.79
Highest CH	4.80

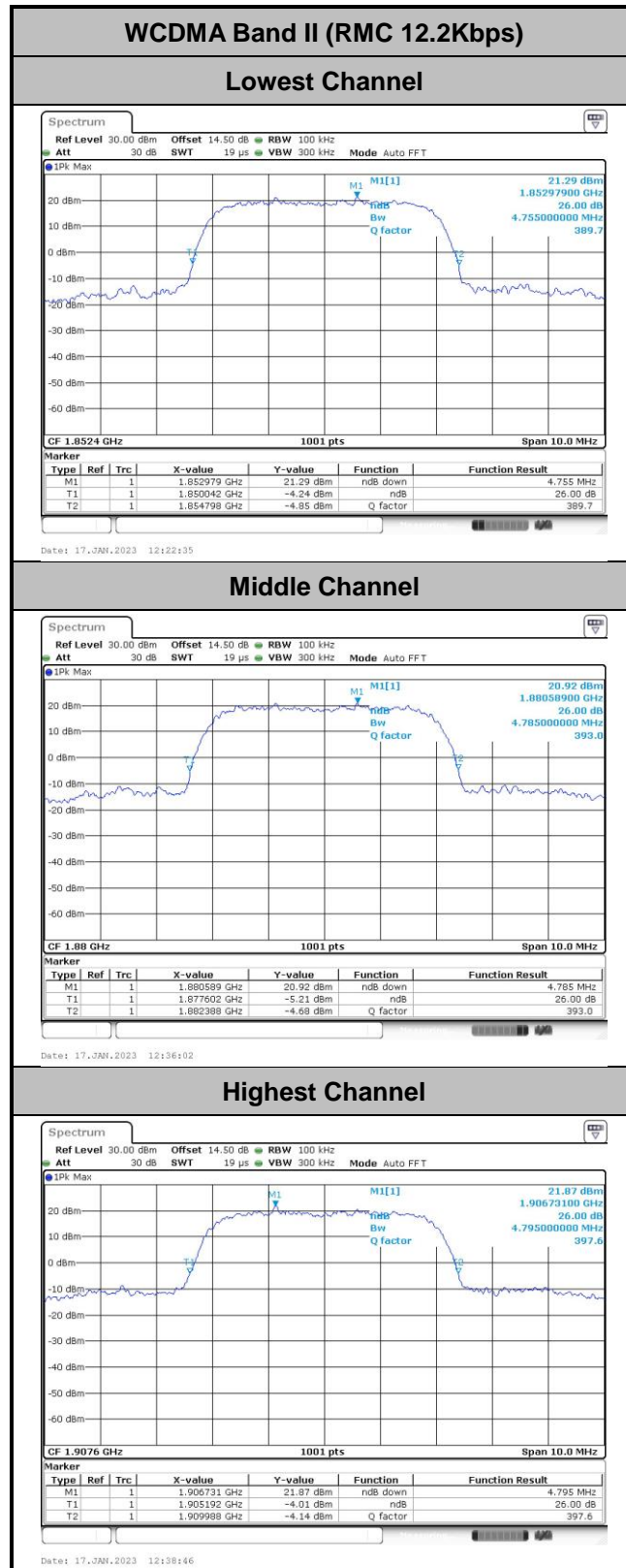



Occupied Bandwidth

Mode	WCDMA Band II(MHz)
Mod.	RMC 12.2Kbps
Lowest CH	4.16
Middle CH	4.18
Highest CH	4.20

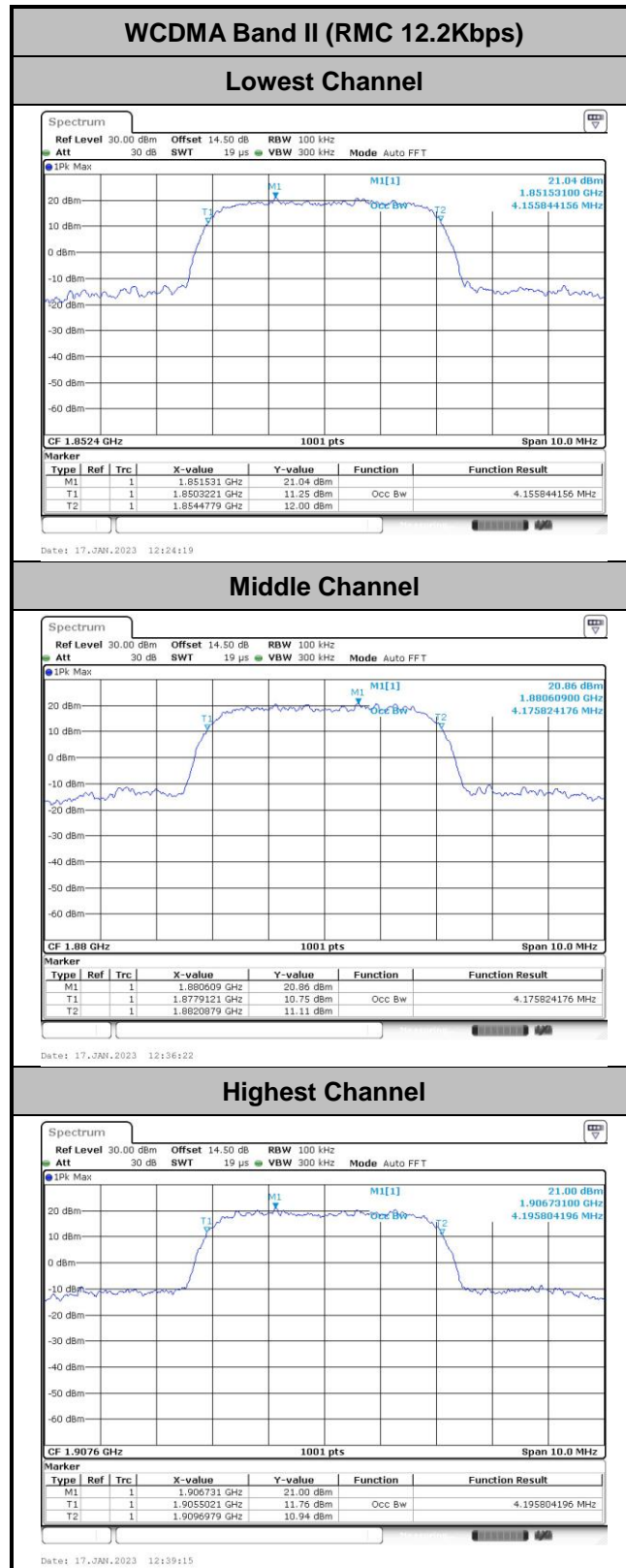



Conducted Band Edge

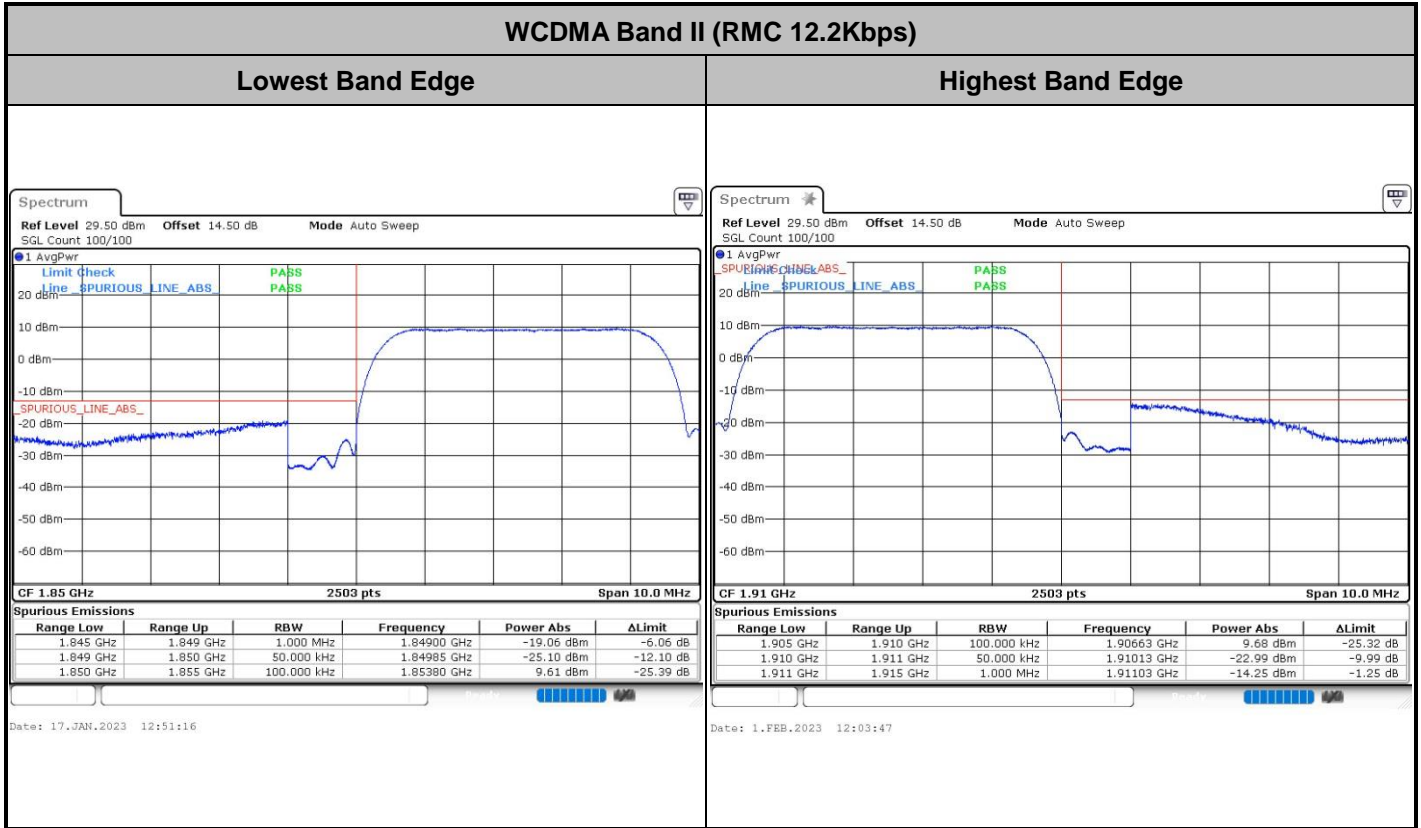



Conducted Spurious Emission

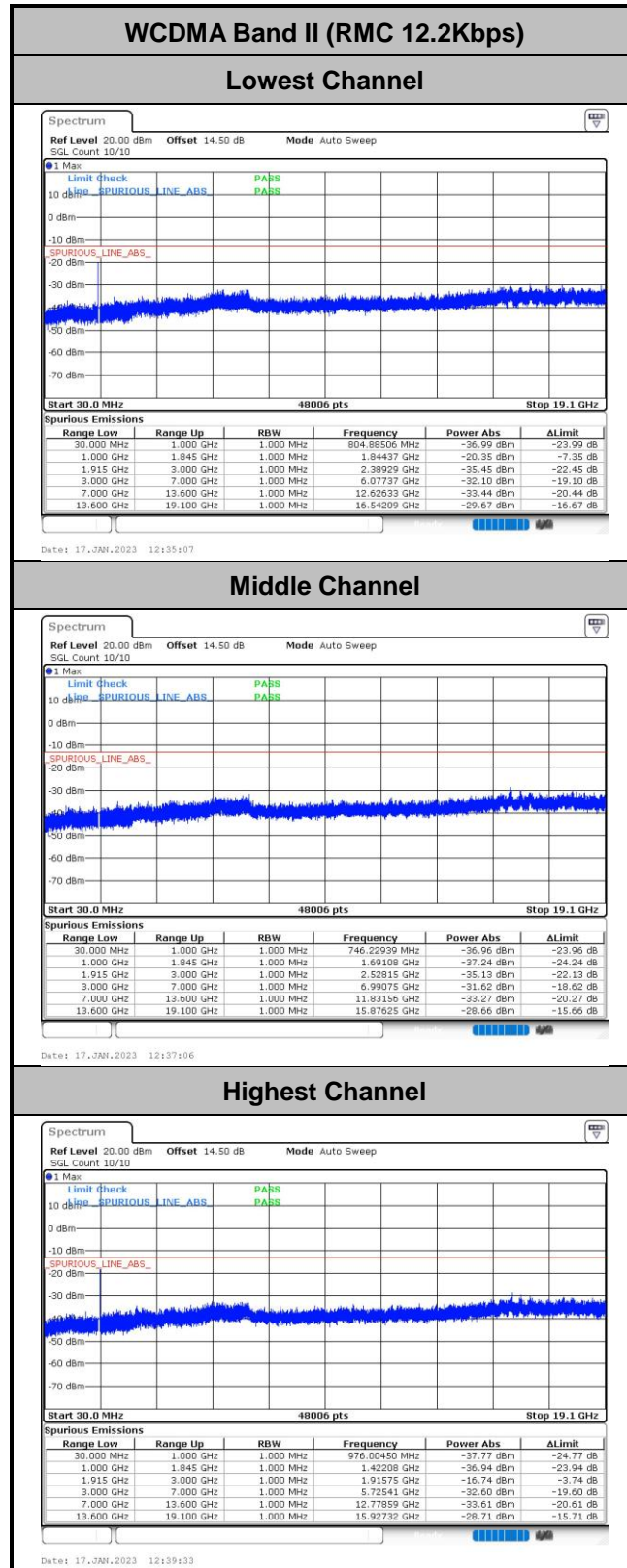



Frequency Stability

Test Conditions	Middle Channel	WCDMA Band II (RMC 12.2Kbps)	Limit Note 2.
Temperature (°C)	Voltage (Volt)	Deviation (ppm)	Result
50	Normal Voltage	0.0003	PASS
40	Normal Voltage	0.0002	
30	Normal Voltage	0.0005	
20(Ref.)	Normal Voltage	0.0000	
10	Normal Voltage	0.0004	
0	Normal Voltage	0.0000	
-10	Normal Voltage	0.0006	
-20	Normal Voltage	0.0003	
-30	Normal Voltage	0.0007	
20	Maximum Voltage	0.0006	
20	Normal Voltage	0.0000	
20	Battery End Point	0.0004	

Note:

1. Normal Voltage = 3.91V. ; Battery End Point (BEP) = 3.4 V. ; Maximum Voltage =4.5 V
2. The frequency fundamental emissions stay within the authorized frequency block based on the frequency deviation measured is small.



A2. WCDMA Band IV

Peak-to-Average Ratio

Mode	WCDMA Band IV(dB)	Limit: 13dB
Mod.	RMC 12.2Kbps	Result
Lowest CH	2.70	PASS
Middle CH	2.81	
Highest CH	2.78	

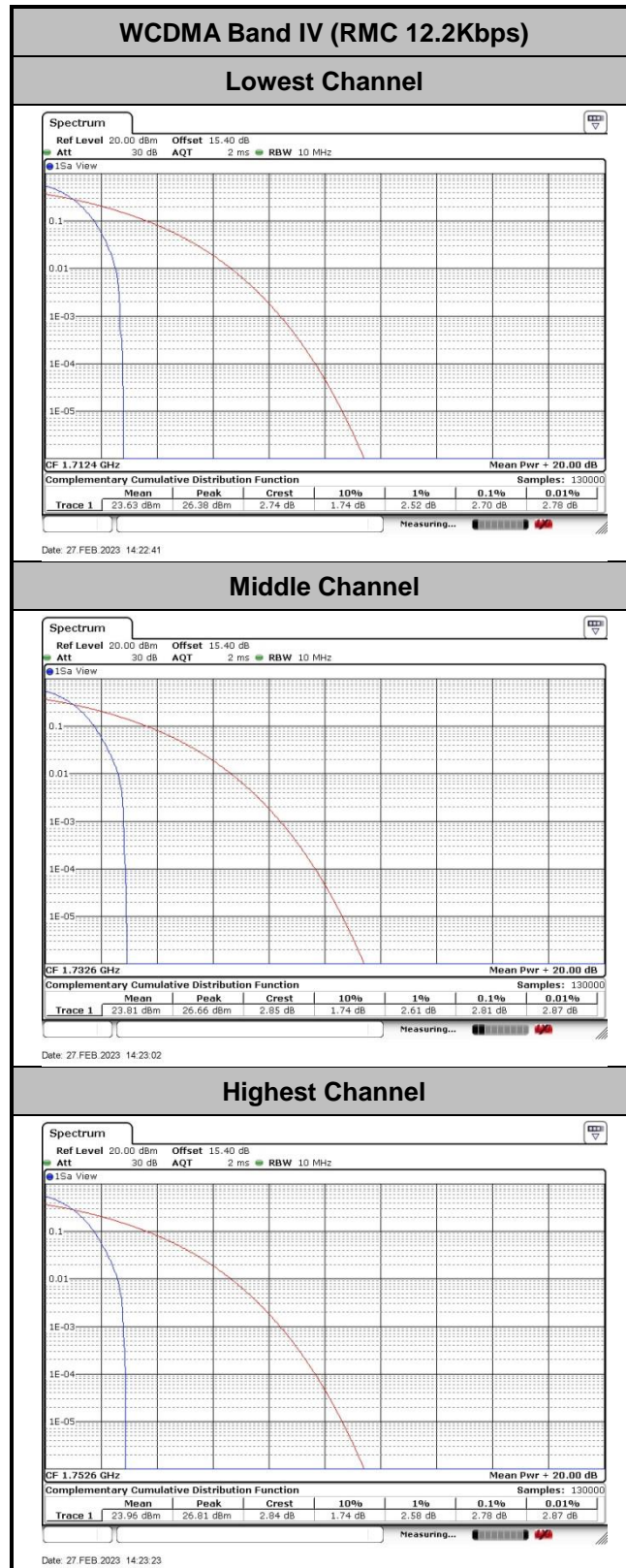



26dB Bandwidth

Mode	WCDMA Band IV(MHz)
Mod.	RMC 12.2Kbps
Lowest CH	4.735
Middle CH	4.725
Highest CH	4.735

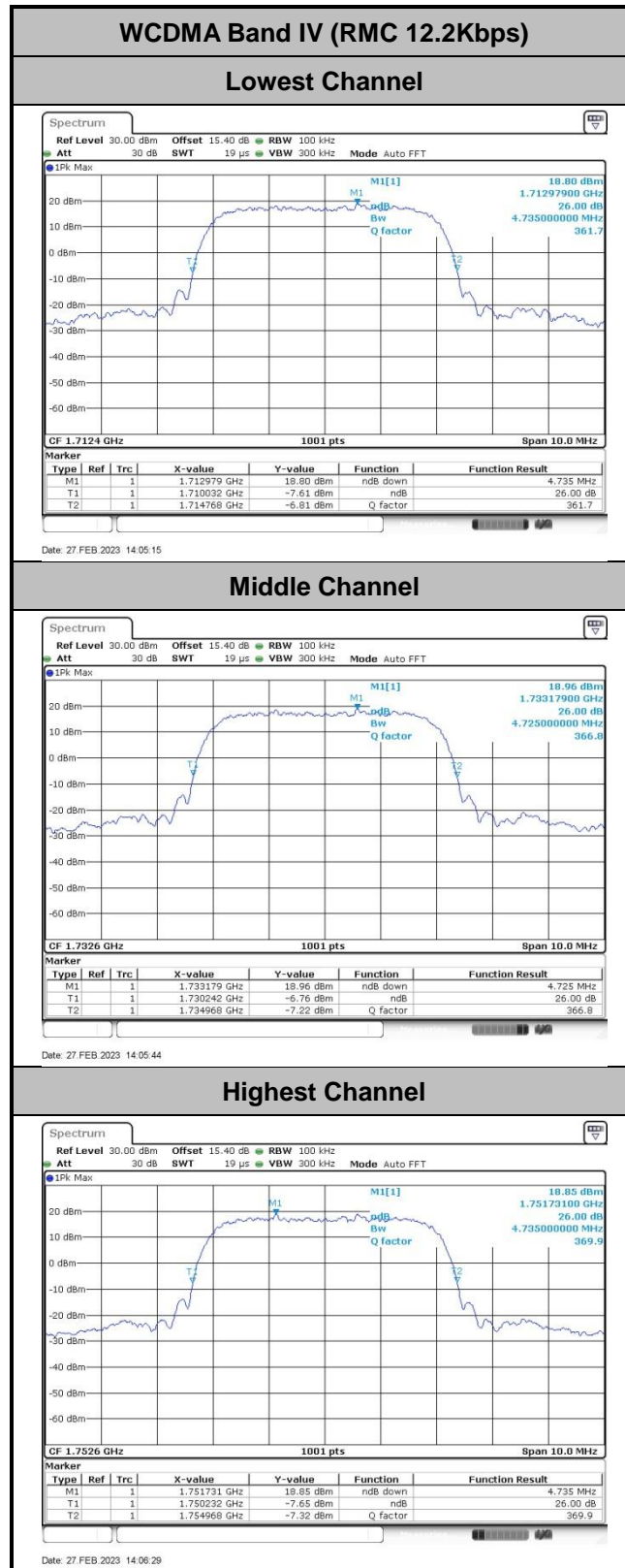



Occupied Bandwidth

Mode	WCDMA Band IV(MHz)
Mod.	RMC 12.2Kbps
Lowest CH	4.146
Middle CH	4.146
Highest CH	4.146

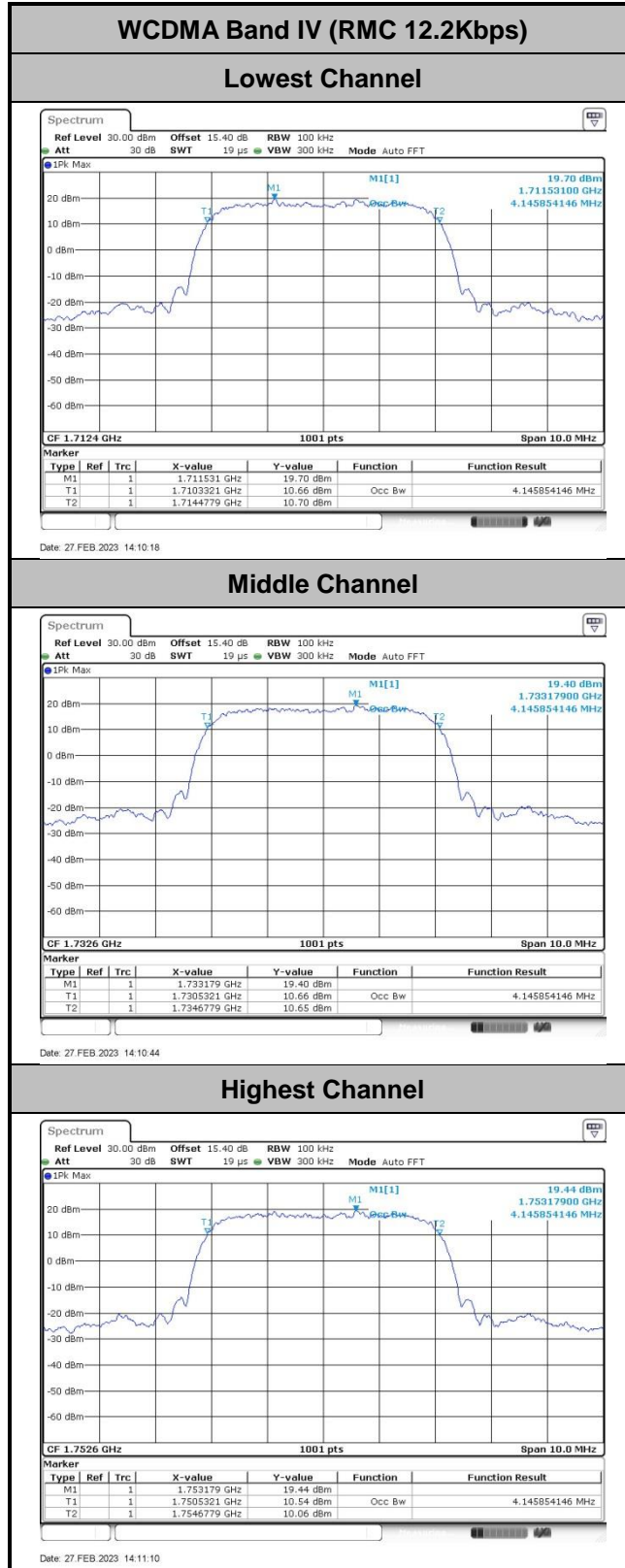



Conducted Band Edge

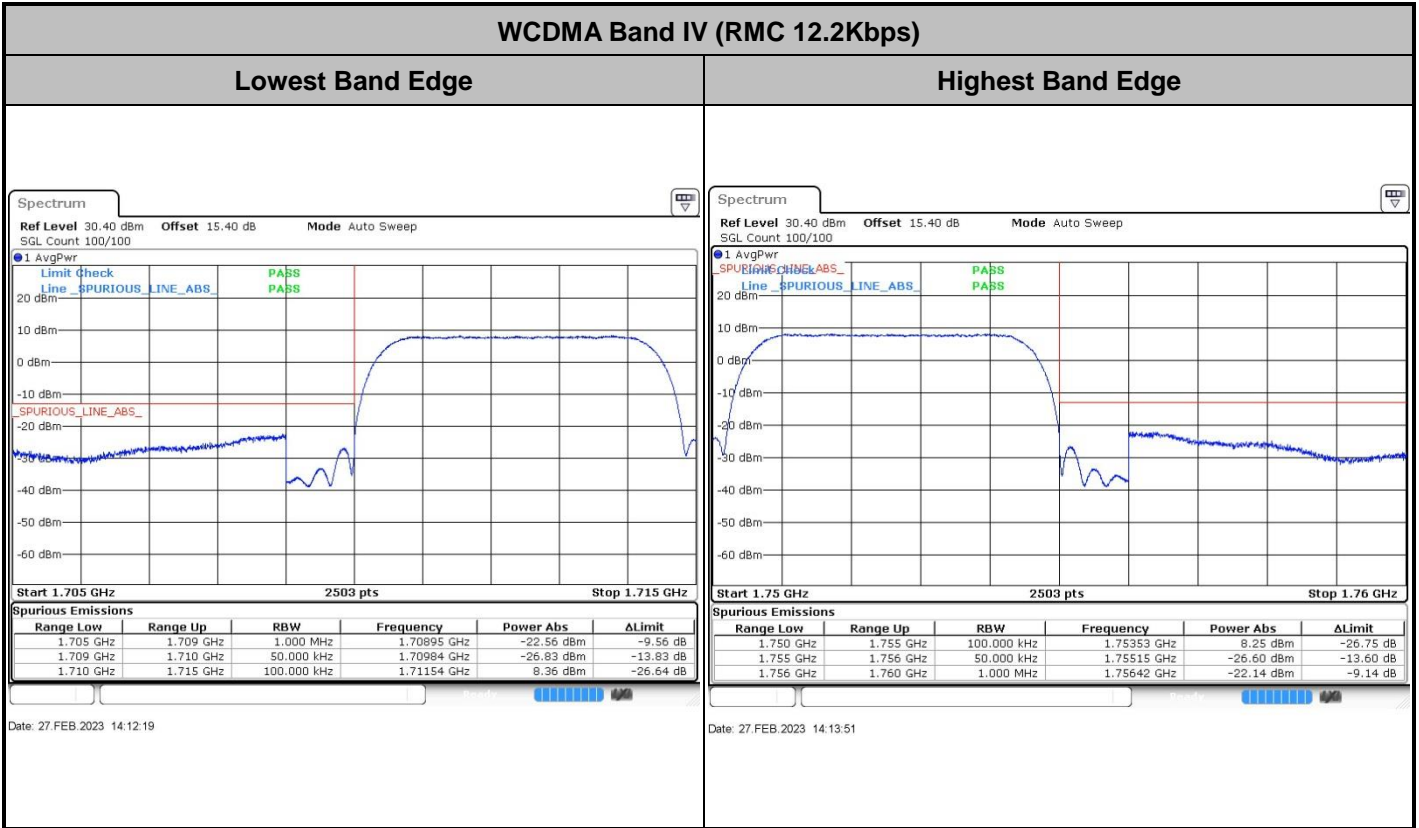



Conducted Spurious Emission

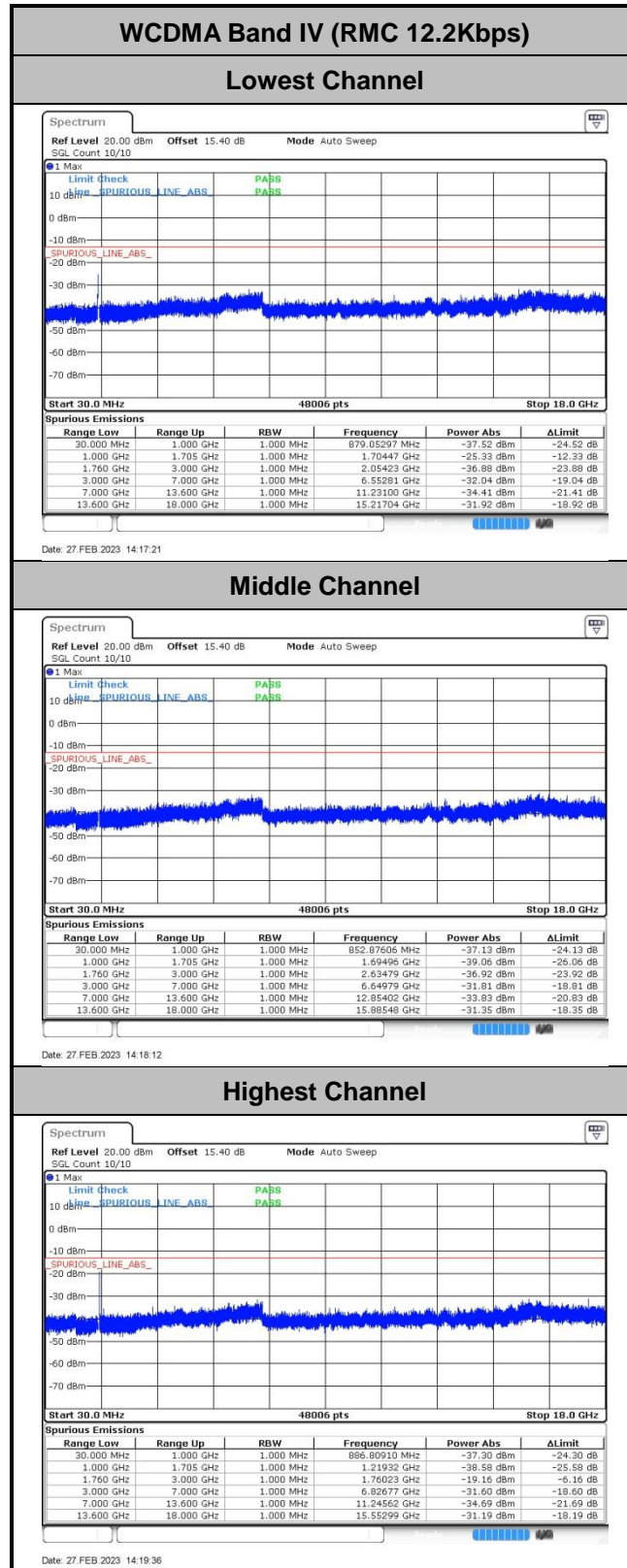



Frequency Stability

Test Conditions	Middle Channel	WCDMA Band IV (RMC 12.2Kbps)	Limit Note 2.
Temperature (°C)	Voltage (Volt)	Deviation (ppm)	Result
50	Normal Voltage	0.0002	PASS
40	Normal Voltage	0.0006	
30	Normal Voltage	0.0011	
20(Ref.)	Normal Voltage	0.0000	
10	Normal Voltage	0.0003	
0	Normal Voltage	0.0001	
-10	Normal Voltage	0.0005	
-20	Normal Voltage	0.0002	
-30	Normal Voltage	0.0008	
20	Maximum Voltage	0.0005	
20	Normal Voltage	0.0000	
20	Battery End Point	0.0003	

Note:

1. Normal Voltage = 3.91V. ; Battery End Point (BEP) = 3.4 V. ; Maximum Voltage =4.5 V
2. The frequency fundamental emissions stay within the authorized frequency block based on the frequency deviation measured is small.



Appendix B. Test Results of Radiated Test

Radiated Spurious Emission

Test Engineer :	Shiwei Wen	Temperature :	22~25°C
		Relative Humidity :	48~52%

Note: Pre-scanned harmonic for the different antennas, we choose the worst antenna mode to test.

WCDMA Band II(RMC 12.2Kbps) Ant.3									
Channel	Frequency (MHz)	EIRP (dBm)	Limit (dBm)	Over Limit (dB)	SPA Reading (dBm)	S.G. Power (dBm)	TX Cable loss (dB)	TX Antenna Gain (dBi)	Polarization (H/V)
Lowest	3704.8	-55.53	-13	-42.53	-78.71	-62.29	5.82	12.58	H
	5557.2	-56.66	-13	-43.66	-81.41	-62.38	7.28	13.00	H
	7409.6	-53.47	-13	-40.47	-80.85	-56.63	8.32	11.48	H
	3704.8	-52.82	-13	-39.82	-77.69	-59.58	5.82	12.58	V
	5557.2	-53.22	-13	-40.22	-78.4	-58.94	7.28	13.00	V
	7409.6	-53.67	-13	-40.67	-81.02	-56.83	8.32	11.48	V
Middle	3760	-56.40	-13	-43.40	-78.89	-63.15	5.85	12.60	H
	5640	-56.42	-13	-43.42	-80.82	-62.22	7.30	13.10	H
	7520	-54.21	-13	-41.21	-81.09	-57.36	8.35	11.50	H
	3760	-53.52	-13	-40.52	-79.17	-60.27	5.85	12.60	V
	5640	-52.58	-13	-39.58	-77.13	-58.38	7.30	13.10	V
	7520	-53.65	-13	-40.65	-80.51	-56.80	8.35	11.50	V
Highest	3815.2	-56.23	-13	-43.23	-79.13	-62.97	5.88	12.62	H
	5722.8	-55.18	-13	-42.18	-80.02	-60.99	7.32	13.13	H
	7630.4	-54.38	-13	-41.38	-80.92	-57.54	8.38	11.54	H
	3815.2	-53.73	-13	-40.73	-78.23	-60.47	5.88	12.62	V
	5722.8	-51.17	-13	-38.17	-76.49	-56.98	7.32	13.13	V
	7630.4	-53.57	-13	-40.57	-80.79	-56.73	8.38	11.54	V

Remark: Spurious emissions within 30-1000MHz were found more than 20dB below limit line.



WCDMA Band IV(RMC 12.2Kbps) Ant.3								
Channel	Frequency (MHz)	EIRP (dBm)	Limit (dBm)	Over Limit (dB)	S.G. Power (dBm)	TX Cable loss (dB)	TX Antenna Gain (dBi)	Polarization (H/V)
Lowest	3420	-64.04	-13	-51.04	-74.78	2.604	13.34	H
	5130	-60.74	-13	-47.74	-71.25	3.011	13.52	H
	6855	-60.02	-13	-47.02	-70.22	3.271	13.47	H
	3420	-63.57	-13	-50.57	-74.31	2.604	13.34	V
	5130	-60.05	-13	-47.05	-70.56	3.011	13.52	V
	6855	-58.80	-13	-45.80	-69.00	3.271	13.47	V
Middle	3465	-63.48	-13	-50.48	-74.22	2.604	13.34	H
	5190	-59.98	-13	-46.98	-70.49	3.011	13.52	H
	6930	-58.81	-13	-45.81	-69.01	3.271	13.47	H
	3465	-63.29	-13	-50.29	-74.03	2.604	13.34	V
	5190	-59.16	-13	-46.16	-69.67	3.011	13.52	V
	6930	-58.32	-13	-45.32	-68.52	3.271	13.47	V
Highest	3510	-63.29	-13	-50.29	-74.03	2.604	13.34	H
	5250	-60.53	-13	-47.53	-71.04	3.011	13.52	H
	7005	-58.84	-13	-45.84	-69.04	3.271	13.47	H
	3510	-63.00	-13	-50.00	-73.74	2.604	13.34	V
	5250	-60.57	-13	-47.57	-71.08	3.011	13.52	V
	7005	-58.88	-13	-45.88	-69.08	3.271	13.47	V

Remark: Spurious emissions within 30-1000MHz were found more than 20dB below limit line.