



FCC RF Test Report

APPLICANT : Motorola Mobility LLC
EQUIPMENT : Mobile Cellular Phone
BRAND NAME : Motorola
MODEL NAME : XT2321-3, XT2321-5
FCC ID : IHDT56AJ3
STANDARD : 47 CFR Part 2, 27
CLASSIFICATION : PCS Licensed Transmitter Held to Ear (PCE)
TEST DATE(S) : Dec. 22, 2022 ~ Jan. 18, 2023

We, Sporton International Inc. (ShenZhen), would like to declare that the tested sample has been evaluated in accordance with the procedures given in ANSI C63.26-2015 and shown compliance with the applicable technical standards.

The test results in this report apply exclusively to the tested model / sample. Without written approval of Sporton International Inc. (ShenZhen), the test report shall not be reproduced except in full.

Jason Jia



Approved by: Jason Jia

Sporton International Inc. (ShenZhen)

1/F, 2/F, Bldg 5, Shiling Industrial Zone, Xinwei Village, Xili, Nanshan, Shenzhen, 518055

People's Republic of China



TABLE OF CONTENTS

REVISION HISTORY...3
SUMMARY OF TEST RESULT...4
1 GENERAL DESCRIPTION...5
1.1 Applicant...5
1.2 Manufacturer...5
1.3 Product Feature of Equipment Under Test...5
1.4 Product Specification of Equipment Under Test...5
1.5 Modification of EUT...7
1.6 Maximum EIRP Power and Emission Designator...7
1.7 Testing Location...9
1.8 Test Software...9
1.9 Applicable Standards...9
1.10 Specification of Accessory...10
2 TEST CONFIGURATION OF EQUIPMENT UNDER TEST...11
2.1 Test Mode...11
2.2 Connection Diagram of Test System...13
2.3 Support Unit used in test configuration and system...13
2.4 Measurement Results Explanation Example...13
2.5 Frequency List of Low/Middle/High Channels...14
3 CONDUCTED TEST ITEMS...17
3.1 Measuring Instruments...17
3.2 Test Setup...17
3.3 Test Result of Conducted Test...17
3.4 Conducted Output Power and EIRP...18
3.5 Peak-to-Average Ratio...19
3.6 Occupied Bandwidth...20
3.7 Conducted Band Edge...21
3.8 Conducted Spurious Emission...23
3.9 Frequency Stability...24
4 RADIATED TEST ITEMS...25
4.1 Measuring Instruments...25
4.2 Test Setup...25
4.3 Test Result of Radiated Test...26
4.4 Radiated Spurious Emission...27
5 LIST OF MEASURING EQUIPMENT...28
6 UNCERTAINTY OF EVALUATION...29
APPENDIX A. TEST RESULTS OF CONDUCTED TEST
APPENDIX B. TEST RESULTS OF RADIATED TEST
APPENDIX C. TEST SETUP PHOTOGRAPHS



SUMMARY OF TEST RESULT

Report Section	FCC Rule	Description	Limit	Result	Remark
3.4	§2.1046	Conducted Output Power	Reporting Only	PASS	-
	§27.50(h)(2)	Equivalent Isotropic Radiated Power (5G NR n7, n41, n38)	EIRP < 2Watt		
	§27.50(d)(4)	Equivalent Isotropic Radiated Power (5G NR n66, n70)	EIRP < 1Watt		
3.5	N/A	Peak-to-Average Ratio	<13 dB	PASS	-
3.6	§2.1049	Occupied Bandwidth	Reporting Only	PASS	-
3.7	§2.1051 §27.53(h)	Conducted Band Edge Measurement (5G NR n66, n70)	< 43+10log10(P[Watts])	PASS	-
	§27.53(m)(4)	Conducted Band Edge Measurement (5G NR n7, n41, n38)	§27.53(m)(4)		
3.8	§2.1051 §27.53(h)	Conducted Spurious Emission (5G NR n66, n70)	< 43+10log10(P[Watts])	PASS	-
	§2.1051 §27.53(m)(4)	Conducted Spurious Emission (5G NR n7, n41, n38)	< 55+10log ₁₀ (P[Watts])		
3.9	§2.1055 §27.54	Frequency Stability Temperature & Voltage	Within Authorized Band	PASS	-
4.4	§2.1053 §27.53(h)	Radiated Spurious Emission (5G NR n66, n70)	< 43+10log ₁₀ (P[Watts])	PASS	Under limit 12.59 dB at 14500.000 MHz
	§2.1053 §27.53(m)(4)	Radiated Spurious Emission (5G NR n7, n41, n38)	< 55+10log ₁₀ (P[Watts])		

Declaration of Conformity:
The test results with all measurement uncertainty excluded are presented in accordance with the regulation limits or requirements declared by manufacturers.
Comments and Explanations:
The declared of product specification for EUT presented in the report are provided by the manufacturer, and the manufacturer takes all the responsibilities for the accuracy of product specification.



1 General Description

1.1 Applicant

Motorola Mobility LLC
222 W,Merchandise Mart Plaza, Chicago IL 60654 USA

1.2 Manufacturer

Motorola Mobility LLC
222 W,Merchandise Mart Plaza, Chicago IL 60654 USA

1.3 Product Feature of Equipment Under Test

Product Feature	
Equipment	Mobile Cellular Phone
Brand Name	Motorola
Model Name	XT2321-3, XT2321-5
FCC ID	IHDT56AJ3
IMEI Code	Conducted : 358041760020174 Radiation : 358041760025637/358041760025645
HW Version	DVT2
SW Version	TTZ 33.50
EUT Stage	Identical Prototype

The two model names XT2321-3, XT2321-5 are the same product except model name different for market segment.

1.4 Product Specification of Equipment Under Test

Standards-related Product Specification	
Tx Frequency	5G NR n7 : 2500 MHz ~ 2570 MHz 5G NR n38 : 2570 MHz ~ 2620 MHz 5G NR n41 : 2496 MHz ~ 2690 MHz 5G NR n66 : 1710 MHz ~ 1780 MHz 5G NR n70 : 1695 MHz ~ 1710 MHz
Rx Frequency	5G NR n7 : 2620 MHz ~ 2690 MHz 5G NR n38: 2570 MHz ~ 2620 MHz 5G NR n41 : 2496 MHz ~ 2690 MHz 5G NR n66 : 2110 MHz~ 2200 MHz 5G NR n70 : 1995 MHz ~ 2020 MHz
Bandwidth	n7 : 5MHz / 10MHz / 15MHz / 20MHz / 25MHz / 30MHz / 40MHz n38 : 10MHz / 15MHz / 20MHz / 25MHz / 30MHz n41 : 20MHz / 30MHz / 40MHz / 50MHz / 60MHz / 70MHz / 80MHz / 90MHz / 100MHz n66: 5MHz / 10MHz / 15MHz / 20MHz / 30MHz / 40MHz n70: 5MHz / 10MHz / 15MHz
SCS	n7, n66, n70 for 15kHz



<p>Antenna Gain</p>	<p>n38, n41 for 30kHz</p> <p><Ant.0> n7 : -1.11 dBi n38 : -1.27 dBi n41 : -1.08 dBi n66 : -2.20 dBi n70 : -2.53 dBi</p> <p><Ant. 1> n7 : -3.27 dBi n38 : -2.77 dBi n41 : -1.90 dBi n66 : -2.64 dBi n70 : -2.61 dB</p> <p><Ant. 2> n7 : -0.86 dBi n38 : -0.86 dBi n41 : -0.86 dBi n66 : -4.65 dBi n70 : -5.53 dB</p> <p><Ant. 3> n7 : -2.06 dBi n38 : -1.91 dBi n41 : -1.91 dBi n66 : -3.73 dBi n70 : -4.60 dB</p>
<p>Type of Modulation</p>	<p>CP-OFDM: QPSK / 16QAM / 64QAM / 256QAM DFT-s-OFDM: PI/2 BPSK / QPSK / 16QAM / 64QAM / 256QAM</p>

Remark:

1. The maximum EIRP is calculated from output power and antenna gain, only the maximum EIRP are shown in the report, 5G NR n7 for Ant. 2 and n38/n41/n66/n70 for Ant.3 and n41_UL MIMO for Ant.(2+3).
2. All the supported ENDC combinations are verified conducted power, only the ENDC combination with highest power are shown in the report.
3. 5G NR n7/n38/n41/n66 support SA mode and NSA mode. According to the maximum power between SA and NSA mode, SA covers NSA mode for n38/n66 and NSA covers SA mode for n7/n41.
4. 5G NR n70 supports SA mode only.
5. The device supports HPUE mode for 5G NR n41 single carrier.
6. 5G NR n41 supports UL MIMO mode for Power class 1.5, the MIMO mode is completely uncorrelated, so the directional gain is selected the maximum gain among all antennas.
7. For n41 MIMO mode, the conducted BE/Spurious are tested at single antenna port and add $10 \cdot \log(N_{ANT})$ according to KDB 662911 D01.
8. The device supports two PAs for 5G NR n41 (other PA only support SA mode(Ant.2)), the maximum power of main PA is higher than the other PA, therefore, we chose higher power PA to calculate the EIRP and show in the report.
9. The EN-DC mode combination could be referred to the product spec.
10. The EUT has two working states, flip open state and flip close state, by verifying these two states, we choose the worst flip open state for all tests.



1.5 Modification of EUT

No modifications are made to the EUT during all test items.

1.6 Maximum EIRP Power and Emission Designator

5G NR n66		PI/2 BPSK / QPSK		16QAM / 64QAM / 256QAM	
BW (MHz)	Frequency Range (MHz)	Maximum EIRP(W)	Emission Designator (99%OBW)	Maximum EIRP(W)	Emission Designator (99%OBW)
5	1712.5 ~ 1777.5	0.0881	4M49G7D	0.0805	4M49W7D
10	1715.0 ~ 1775.0	0.0863	9M28G7D	0.0755	9M28W7D
15	1717.5 ~ 1772.5	0.0869	14M1G7D	0.0753	14M1W7D
20	1720.0 ~ 1770.0	0.0863	18M9G7D	0.0764	19M0W7D
30	1725.0 ~ 1765.0	0.0893	28M6G7D	0.0778	28M6W7D
40	1730.0 ~ 1760.0	0.0910	38M6G7D	0.0838	38M6W7D

5G NR n7 EN_DC_2A_n7A		PI/2 BPSK / QPSK		16QAM / 64QAM / 256QAM	
BW (MHz)	Frequency Range (MHz)	Maximum EIRP(W)	Emission Designator (99%OBW)	Maximum EIRP(W)	Emission Designator (99%OBW)
5	2502.5 ~ 2567.5	0.1629	4M48G7D	0.1324	4M50W7D
10	2505.0 ~ 2565.0	0.1611	9M27G7D	0.1205	9M29W7D
15	2507.5 ~ 2562.5	0.1671	14M1G7D	0.1242	14M1W7D
20	2510.0 ~ 2560.0	0.1734	18M9G7D	0.1393	18M9W7D
25	2512.5 ~ 2557.5	0.1758	23M7G7D	0.1337	23M8W7D
30	2515.0 ~ 2555.0	0.1722	28M6G7D	0.1343	28M6W7D
40	2520.0 ~ 2550.0	0.1774	38M6G7D	0.1648	38M6W7D

5G NR n38		PI/2 BPSK / QPSK		16QAM / 64QAM / 256QAM	
BW (MHz)	Frequency Range (MHz)	Maximum EIRP(W)	Emission Designator (99%OBW)	Maximum EIRP(W)	Emission Designator (99%OBW)
10	2575.0 ~ 2615.0	0.1687	8M59G7D	0.1340	8M61W7D
15	2577.5 ~ 2612.5	0.1758	13M6G7D	0.1374	13M6W7D
20	2580.0 ~ 2610.0	0.1718	18M3G7D	0.1384	18M2W7D
25	2582.5 ~ 2607.5	0.1734	23M2G7D	0.1371	23M2W7D
30	2585.0 ~ 2605.0	0.1770	28M0G7D	0.1422	27M9W7D



5G NR n41 EN_DC_12A_n41A		PI/2 BPSK / QPSK		16QAM / 64QAM / 256QAM	
BW (MHz)	Frequency Range (MHz)	Maximum EIRP(W)	Emission Designator (99%OBW)	Maximum EIRP(W)	Emission Designator (99%OBW)
20	2506.02 ~ 2679.99	0.3006	18M3G7D	0.2460	18M2W7D
30	2511.00 ~ 2674.98	0.2904	28M0G7D	0.2393	27M9W7D
40	2516.01 ~ 2670.00	0.2897	37M9G7D	0.2393	37M9W7D
50	2521.02 ~ 2664.99	0.3055	47M6G7D	0.2410	47M6W7D
60	2526.00 ~ 2659.98	0.2985	57M9G7D	0.2388	58M0W7D
70	2531.01 ~ 2655.00	0.2911	67M7G7D	0.2371	67M7W7D
80	2536.02 ~ 2649.99	0.2904	77M6G7D	0.2317	77M8W7D
90	2541.00 ~ 2644.98	0.2904	87M6G7D	0.2344	87M6W7D
100	2546.01 ~ 2640.00	0.3105	97M6G7D	0.2512	97M7W7D

5G NR n41 UL MIMO		PI/2 BPSK / QPSK		16QAM / 64QAM / 256QAM	
BW (MHz)	Frequency Range (MHz)	Maximum EIRP(W)	Emission Designator (99%OBW)	Maximum EIRP(W)	Emission Designator (99%OBW)
20	2506.02 ~ 2679.99	0.6561	18M2G7D	0.5188	18M3W7D
30	2511.00 ~ 2674.98	0.6637	27M9G7D	0.5212	27M9W7D
40	2516.01 ~ 2670.00	0.6714	37M9G7D	0.5248	38M0W7D
50	2521.02 ~ 2664.99	0.6622	47M5G7D	0.5458	47M6W7D
60	2526.00 ~ 2659.98	0.6622	58M1G7D	0.5224	58M0W7D
70	2531.01 ~ 2655.00	0.6237	67M6G7D	0.4875	67M6W7D
80	2536.02 ~ 2649.99	0.6109	77M6G7D	0.4932	77M8W7D
90	2541.00 ~ 2644.98	0.6081	87M5G7D	0.4853	87M7W7D
100	2546.01 ~ 2640.00	0.6808	97M6G7D	0.5495	97M8W7D

5G NR n70		PI/2 BPSK / QPSK		16QAM / 64QAM / 256QAM	
BW (MHz)	Frequency Range (MHz)	Maximum EIRP(W)	Emission Designator (99%OBW)	Maximum EIRP(W)	Emission Designator (99%OBW)
5	1697.5 ~ 1707.5	0.0706	4M48G7D	0.0634	4M48W7D
10	1700.0 ~ 1705.0	0.0700	9M27G7D	0.0643	9M30W7D
15	1702.5	0.0714	14M1G7D	0.0701	14M1W7D

Note:

- 5G NR n41 overlaps the entire frequency range of 5G NR n38. Therefore, the test results provided in this report covers 5G NR n41 as well as 5G NR n38, and 5G NR n38 supports BW 10MHz/15MHz/25MHz, it is tested in the report. .
- All modulations have been tested, only the worst test results of PSK & QAM are shown in the report.



1.7 Testing Location

Sporton International Inc. (ShenZhen) is accredited to ISO/IEC 17025:2017 by American Association for Laboratory Accreditation with Certificate Number 5145.01.

Test Firm	Sporton International Inc. (ShenZhen)		
Test Site Location	1/F, 2/F, Bldg 5, Shiling Industrial Zone, Xinwei Village, Xili, Nanshan, Shenzhen, 518055 People’s Republic of China TEL: +86-755-86379589 FAX: +86-755-86379595		
Test Site No.	Sporton Site No.	FCC Designation No.	FCC Test Firm Registration No.
	TH01-SZ	CN1256	421272

Test Firm	Sporton International Inc. (ShenZhen)		
Test Site Location	101, 1st Floor, Block B, Building 1, No. 2, Tengfeng 4th Road, Fenghuang Community, Fuyong Street, Baoan District, Shenzhen City Guangdong Province China 518103 TEL: +86-755-33202398		
Test Site No.	Sporton Site No.	FCC Designation No.	FCC Test Firm Registration No.
	03CH01-SZ	CN1256	421272

1.8 Test Software

Item	Site	Manufacturer	Name	Version
1.	03CH01-SZ	AUDIX	E3	6.2009-8-24

1.9 Applicable Standards

According to the specifications of the manufacturer, the EUT must comply with the requirements of the following standards:

- ♦ 47 CFR Part 2, 27
- ♦ ANSI C63.26-2015
- ♦ FCC KDB 971168 D01 Power Meas License Digital Systems v03r01
- ♦ FCC KDB 412172 D01 Determining ERP and EIRP v01r01

Remark:

All test items were verified and recorded according to the standards and without any deviation during the test.



1.10 Specification of Accessory

Specification of Accessory				
AC Adapter	Brand Name	Motorola (Salom)	Model Name	MC-301
Battery 1	Brand Name	Motorola(ATL)	Model Name	PM29
Battery 2	Brand Name	Motorola(ATL)	Model Name	PM08
USB Cable 1	Brand Name	Motorola (Cabletech)	Model Name	SC18D13216
USB Cable 2	Brand Name	Motorola (Luxshare)	Model Name	SC18D13217
USB Cable 3	Brand Name	Motorola (Saibao)	Model Name	SC18D86732



2 Test Configuration of Equipment Under Test

2.1 Test Mode

Antenna port conducted and radiated test items are performed according to KDB 971168 D01 Power Meas License Digital Systems v03r01 with maximum output power.

For radiated measurement, pre-scanned in three orthogonal panels, X, Y, Z. The worst cases were recorded in this report.

The device is investigated from 30MHz to 10 times of fundamental signal for radiated spurious emission test under different RB size/offset and modulations in exploratory test. Subsequently, only the worst case emissions are reported.

Orthogonal Planes of EUT	X Plane	Y Plane	Z Plane
			

Test Items	5G NR	Bandwidth (MHz)													Modulation					RB #		Test Channel					
		5	10	15	20	25	30	40	50	60	70	80	90	100	PI/2 BPSK	QPSK	16QAM	64QAM	256QAM	1	Full	L	M	H			
Max. Output Power	n7	v	v	v	v	v	v	v	-	-	-	-	-	-	v	v	v	v	v	v	v	v	v	v	v	v	
	n38	-	v	v	v	v	v	-	-	-	-	-	-	-	v	v	v	v	v	v	v	v	v	v	v	v	
	n41	-	-	-	v	-	v	v	v	v	v	v	v	v	v	v	v	v	v	v	v	v	v	v	v	v	v
	n66	v	v	v	v	-	v	v	-	-	-	-	-	-	v	v	v	v	v	v	v	v	v	v	v	v	v
	n70	v	v	v	-	-	-	-	-	-	-	-	-	-	v	v	v	v	v	v	v	v	v	v	v	v	v
Peak-to-Average Ratio	n7				v				-	-	-	-	-	-	v	v					v	v	v	v	v	v	
	n38	-	v					-	-	-	-	-	-	-	v	v					v	v	v	v	v	v	
	n41	-	-	-	v	-									v	v					v	v	v	v	v	v	
	n66				v	-	-								v	v					v	v	v	v	v	v	v
	n70		v		-	-	-	-	-	-	-	-	-	-	v	v					v	v	v	v	v	v	v
26dB and 99% Bandwidth	n7	v	v	v	v	v	v	v	-	-	-	-	-	-	v	v	v	v	v		v				v		
	n38	-	v	v		v			-	-	-	-	-	-	v	v	v	v	v		v				v		
	n41	-	-	-	v	-	v	v	v	v	v	v	v	v	v	v	v	v	v		v				v		
	n66	v	v	v	v	-	v	v	-	-	-	-	-	-	v	v	v	v	v		v				v		
	n70	v	v	v	-	-	-	-	-	-	-	-	-	-	v	v	v	v	v		v				v		



Test Items	5G NR	Bandwidth (MHz)													Modulation					RB #		Test Channel		
		5	10	15	20	25	30	40	50	60	70	80	90	100	PI/2 BPSK	QPSK	16QAM	64QAM	256QAM	1	Full	L	M	H
Conducted Band Edge	n7	v			v			v	-	-	-	-	-	v	v				v	v	v		v	
	n38	-	v	v		v		-	-	-	-	-	-	v	v				v	v	v		v	
	n41	-	-	-	v	-				v				v	v				v	v	v		v	
	n66	v			v	-			v	-	-	-	-	-	v	v				v	v	v		v
	n70	v	v	v	-	-	-	-	-	-	-	-	-	-	v	v				v	v	v		v
Conducted Spurious Emission	n7	v			v			v	-	-	-	-	-	v	v				v		v	v	v	
	n38	-	v	v		v		-	-	-	-	-	-	v	v				v		v	v	v	
	n41	-	-	-	v	-				v				v	v				v		v	v	v	
	n66	v			v	-			v	-	-	-	-	-	v	v				v		v	v	
	n70	v	v	v	-	-	-	-	-	-	-	-	-	-	v	v				v		v	v	v
Frequency Stability	n7				v				-	-	-	-	-		v				v		v			
	n38	-	v					-	-	-	-	-	-		v				v		v			
	n41	-	-	-	v	-									v				v		v			
	n66				v	-				-	-	-	-	-		v				v		v		
	n70		v		-	-	-	-	-	-	-	-	-	-		v				v		v		
E.R.P / E.I.R.P	n7	v	v	v	v	v	v	v	-	-	-	-	-	v	v	v	v	v	v	v	v	v	v	
	n38	-	v	v	v	v	v	-	-	-	-	-	-	v	v	v	v	v	v	v	v	v	v	
	n41	-	-	-	v	-	v	v	v	v	v	v	v	v	v	v	v	v	v	v	v	v	v	
	n66	v	v	v	v	-	v	v	-	-	-	-	-	-	v	v	v	v	v	v	v	v	v	
	n70	v	v	v	-	-	-	-	-	-	-	-	-	-	v	v	v	v	v	v	v	v	v	
Radiated Spurious Emission	n7	Worst Case																			v	v	v	
	n41	Worst Case																			v	v	v	
	n66	Worst Case																			v	v	v	
	n70	Worst Case																			v	v	v	
Note	1. The mark "v" means that this configuration is chosen for testing 2. The mark "-" means that this bandwidth is not supported. 3. The device is investigated from 30MHz to 10 times of fundamental signal for radiated spurious emission test under different RB size/offset and modulations in exploratory test. Subsequently, only the worst case emissions are reported. 4. Frequency Stability : Normal Voltage = 3.91V ; Low Voltage =3.40V. ; High Voltage =4.50V																							

2.2 Connection Diagram of Test System

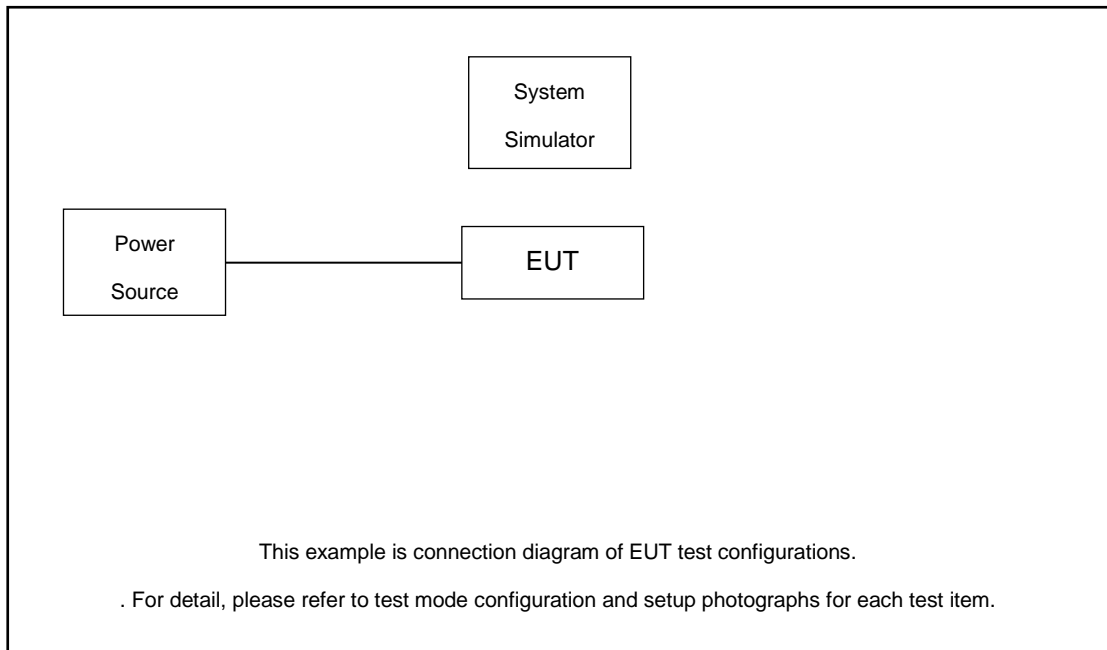

The EUT has been configuration operated in a manner tended to maximize its emission characteristics in a typical application.

2.3 Support Unit used in test configuration and system

Item	Equipment	Trade Name	Model No.	FCC ID	Data Cable	Power Cord
1.	DC Power Supply	GW	GPS-3030D	N/A	N/A	Unshielded, 1.8 m
2.	LTE Base Station	Anritsu	MT8821C	N/A	N/A	Unshielded, 1.8 m
3.	NR Base Station	Anritsu	MT8000A	N/A	N/A	Unshielded, 1.8 m

2.4 Measurement Results Explanation Example

For all conducted test items:

The offset level is set in the spectrum analyzer to compensate the RF cable loss and attenuator factor between EUT conducted output port and spectrum analyzer. With the offset compensation, the spectrum analyzer reading level is exactly the EUT RF output level.

The spectrum analyzer offset is derived from RF cable loss and attenuator factor.

Offset = RF cable loss.

Following shows an offset computation example with cable loss 8.4 dB.

Example :

Offset(dB) = RF cable loss(dB).

= 8.4 (dB)



2.5 Frequency List of Low/Middle/High Channels

5G NR n7 Channel and Frequency List				
BW [MHz]	Channel/Frequency(MHz)	Lowest	Middle	Highest
40	Channel	504000	507000	510000
	Frequency	2520	2535	2550
30	Channel	503000	507000	511000
	Frequency	2515	2535	2555
25	Channel	502500	507000	511500
	Frequency	2512.5	2535	2557.5
20	Channel	502000	507000	512000
	Frequency	2510	2535	2560
15	Channel	501500	507000	512500
	Frequency	2507.5	2535	2562.5
10	Channel	501000	507000	513000
	Frequency	2505	2535	2565
5	Channel	500500	507000	513500
	Frequency	2502.5	2535	2567.5

5G NR n38 Channel and Frequency List				
BW [MHz]	Channel/Frequency(MHz)	Lowest	Middle	Highest
30	Channel	517000	519000	521000
	Frequency	2585	2595	2605
25	Channel	516500	519000	521500
	Frequency	2582.5	2595	2607.5
20	Channel	516000	519000	522000
	Frequency	2580	2595	2610
15	Channel	515500	519000	522500
	Frequency	2577.5	2595	2612.5
10	Channel	515000	519000	523000
	Frequency	2575	2595	2615



5G NR n41 Channel and Frequency List				
BW [MHz]	Channel/Frequency(MHz)	Lowest	Middle	Highest
100	Channel	509202	518598	528000
	Frequency	2546.01	2592.99	2640
90	Channel	508200	518598	528996
	Frequency	2541	2592.99	2644.98
80	Channel	507204	518598	529998
	Frequency	2536.02	2592.99	2649.99
70	Channel	506202	518598	531000
	Frequency	2531.01	2592.99	2655
60	Channel	505200	518598	531996
	Frequency	2526	2592.99	2659.98
50	Channel	504204	518598	532998
	Frequency	2521.02	2592.99	2664.99
40	Channel	503202	518598	534000
	Frequency	2516.01	2592.99	2670
30	Channel	502200	518598	534996
	Frequency	2511	2592.99	2674.98
20	Channel	501204	518598	535998
	Frequency	2506.02	2592.99	2679.99



5G NR n66 Channel and Frequency List				
BW [MHz]	Channel/Frequency(MHz)	Lowest	Middle	Highest
40	Channel	346000	349000	352000
	Frequency	1730	1745	1760
30	Channel	345000	349000	353000
	Frequency	1725	1745	1765
20	Channel	344000	349000	354000
	Frequency	1720	1745	1770
15	Channel	343500	349000	354500
	Frequency	1717.5	1745	1772.5
10	Channel	343000	349000	355000
	Frequency	1715	1745	1775
5	Channel	342500	349000	355500
	Frequency	1712.5	1745	1777.5

5G NR n70 Channel and Frequency List				
BW [MHz]	Channel/Frequency(MHz)	Lowest	Middle	Highest
15	Channel	340500		
	Frequency	1702.5		
10	Channel	340000	340500	341000
	Frequency	1700	1702.5	1705
5	Channel	399500	340500	341500
	Frequency	1697.5	1702.5	1707.5

3 Conducted Test Items

3.1 Measuring Instruments

See list of measuring instruments of this test report.

3.2 Test Setup

3.2.1 Conducted Output Power



3.2.2 Peak-to-Average Ratio, Occupied Bandwidth ,Conducted Band-Edge and Conducted Spurious Emission

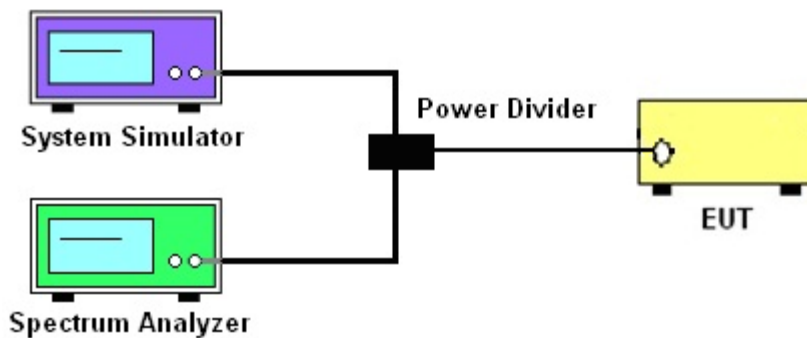

3.2.3 Frequency Stability

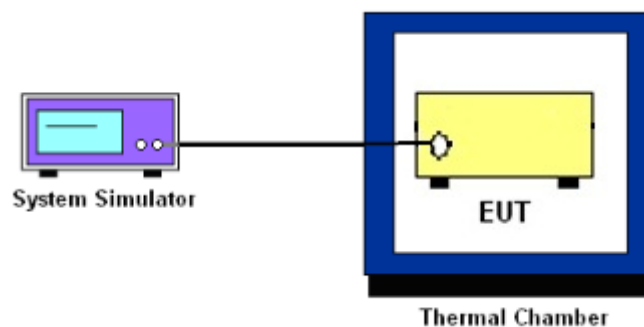

3.3 Test Result of Conducted Test

Please refer to Appendix A.



3.4 Conducted Output Power and EIRP

3.4.1 Description of the Conducted Output Power Measurement and EIRP Measurement

A system simulator was used to establish communication with the EUT. Its parameters were set to force the EUT transmitting at maximum output power. The measured power in the radio frequency on the transmitter output terminals shall be reported.

The EIRP of mobile transmitters must not exceed 2 Watts for 5G NR n7, n38, n41.

The EIRP of mobile transmitters must not exceed 1 Watts for 5G NR n66, n70.

According to KDB 412172 D01 Power Approach,

$EIRP = P_T + G_T - L_C$, $ERP = EIRP - 2.15$, where

P_T = transmitter output power in dBm

G_T = gain of the transmitting antenna in dBi

L_C = signal attenuation in the connecting cable between the transmitter and antenna in dB

3.4.2 Test Procedures

1. The testing follows ANSI C63.26 Section 5.2
2. The transmitter output port was connected to the system simulator.
3. Set EUT at maximum power through the system simulator.
4. Select lowest, middle, and highest channels for each band and different modulation.
5. Measure and record the power level from the system simulator.



3.5 Peak-to-Average Ratio

3.5.1 Description of the PAR Measurement

Power Complementary Cumulative Distribution Function (CCDF) curves provide a means for characterizing the power peaks of a digitally modulated signal on a statistical basis. A CCDF curve depicts the probability of the peak signal amplitude exceeding the average power level. Most contemporary measurement instrumentation include the capability to produce CCDF curves for an input signal provided that the instrument's resolution bandwidth can be set wide enough to accommodate the entire input signal bandwidth. In measuring transmissions in this band using an average power technique, the peak-to-average ratio (PAR) of the transmission may not exceed 13 dB.

3.5.2 Test Procedures

1. The testing follows ANSI C63.26 Section 5.2.3.4 (CCDF).
2. The EUT was connected to spectrum and system simulator via a power divider.
3. Set the CCDF (Complementary Cumulative Distribution Function) option in spectrum analyzer.
4. The highest RF powers were measured and recorded the maximum PAPR level associated with a probability of 0.1 %.
5. Record the deviation as Peak to Average Ratio.



3.6 Occupied Bandwidth

3.6.1 Description of Occupied Bandwidth Measurement

The occupied bandwidth is the width of a frequency band such that, below the lower and above the upper frequency limits, the mean powers emitted are each equal to a specified percentage 0.5% of the total mean transmitted power.

The 26 dB emission bandwidth is defined as the frequency range between two points, one above and one below the carrier frequency, at which the spectral density of the emission is attenuated 26 dB below the maximum in-band spectral density of the modulated signal. Spectral density (power per unit bandwidth) is to be measured with a detector of resolution bandwidth equal to approximately 1.0% of the emission bandwidth.

3.6.2 Test Procedures

1. The testing follows ANSI C63.26 Section 5.4
2. The EUT was connected to spectrum analyzer and system simulator via a power divider.
3. The spectrum analyzer center frequency is set to the nominal EUT channel center frequency. The span range for the spectrum analyzer shall be between two and five times the anticipated OBW.
4. The nominal resolution bandwidth (RBW) shall be in the range of 1 to 5 % of the anticipated OBW, and the VBW shall be at least 3 times the RBW.
5. Set the detection mode to peak, and the trace mode to max hold.
6. Determine the reference value: Set the EUT to transmit a modulated signal. Allow the trace to stabilize. Set the spectrum analyzer marker to the highest level of the displayed trace.
(this is the reference value)
7. Determine the “-26 dB down amplitude” as equal to (Reference Value – X).
8. Place two markers, one at the lowest and the other at the highest frequency of the envelope of the spectral display such that each marker is at or slightly below the “-X dB down amplitude” determined in step 6. If a marker is below this “-X dB down amplitude” value it shall be placed as close as possible to this value. The OBW is the positive frequency difference between the two markers.
9. Use the 99 % power bandwidth function of the spectrum analyzer and report the measured bandwidth.



3.7 Conducted Band Edge

3.7.1 Description of Conducted Band Edge Measurement

27.53 (h)

For operations in the 1695 – 1710 MHz, 1710 – 1755 MHz and 1710 – 1780 MHz band, the FCC limit is $43 + 10\log_{10}(P[\text{Watts}])$ dB below the transmitter power $P(\text{Watts})$ in a 1 MHz bandwidth. However, in the 1MHz bands immediately outside and adjacent to the licensee's frequency block, a resolution bandwidth of at least one percent of the emission bandwidth of the fundamental emission of the transmitter may be employed.

27.53(m)(4)

For mobile digital stations, the attenuation factor shall be not less than $40 + 10 \log (P)$ dB on all frequencies between the channel edge and 5 megahertz from the channel edge, $43 + 10 \log (P)$ dB on all frequencies between 5 megahertz and X megahertz from the channel edge, and $55 + 10 \log (P)$ dB on all frequencies more than X megahertz from the channel edge, where X is the greater of 6 megahertz or the actual emission bandwidth as defined in paragraph (m)(6) of this section. In addition, the attenuation factor shall not be less that $43 + 10 \log (P)$ dB on all frequencies between 2490.5 MHz and 2496 MHz and $55 + 10 \log (P)$ dB at or below 2490.5 MHz. Mobile Satellite Service licensees operating on frequencies below 2495 MHz may also submit a documented interference complaint against BRS licensees operating on channel BRS Channel 1 on the same terms and conditions as adjacent channel BRS or EBS licensees.



3.7.2 Test Procedures

1. The testing follows ANSI C63.26 section 5.7
2. The EUT was connected to spectrum analyzer and system simulator via a power divider.
3. The band edges of low and high channels for the highest RF powers were measured.
4. Set RBW $\geq 1\%/2\%$ EBW in the 1MHz band immediately outside and adjacent to the band edge.
5. Beyond the 1 MHz band from the band edge, RBW=1MHz was used or a narrower RBW was used (generally limited to no less than 1% of the OBW) and the measured power was integrated over the full required measurement bandwidth.
6. Set spectrum analyzer with RMS detector.
7. The RF fundamental frequency should be excluded against the limit line in the operating frequency band.
8. Checked that all the results comply with the emission limit line.

Example:

The limit line is derived from $43 + 10\log(P)$ dB below the transmitter power P(Watts)

$$= P(W) - [43 + 10\log(P)] \text{ (dB)}$$

$$= [30 + 10\log(P)] \text{ (dBm)} - [43 + 10\log(P)] \text{ (dB)} = -13\text{dBm.}$$

9. For 5G NR n7/n38/n41, the other 40 dB, and 55 dB have additionally applied same calculation above.
10. When using the integration method, the starting frequency of the integration shall be centered at one-half of the RBW away from the band edge.



3.8 Conducted Spurious Emission

3.8.1 Description of Conducted Spurious Emission Measurement

The power of any emission outside of the authorized operating frequency ranges must be lower than the transmitter power (P) by a factor of at least $43 + 10 \log (P)$ dB.

For 5G NR n7/n38/n41:

The power of any emission outside of the authorized operating frequency ranges must be lower than the transmitter power (P) by a factor of at least $55 + 10 \log (P)$ dB.

It is measured by means of a calibrated spectrum analyzer and scanned from 30 MHz up to a frequency including its 10th harmonic.

3.8.2 Test Procedures

1. The testing follows ANSI C63.26 section 5.7
2. The EUT was connected to spectrum analyzer and system simulator via a power divider.
3. The RF output of EUT was connected to the spectrum analyzer by RF cable and attenuator.
The path loss was compensated to the results for each measurement.
4. The middle channel for the highest RF power within the transmitting frequency was measured.
5. The conducted spurious emission for the whole frequency range was taken.
6. Make the measurement with the spectrum analyzer's RBW = 1MHz, VBW = 3MHz.
7. Set spectrum analyzer with RMS detector.
8. Taking the record of maximum spurious emission.
9. The RF fundamental frequency should be excluded against the limit line in the operating frequency band.
10. The limit line is derived from $43 + 10\log(P)$ dB below the transmitter power P(Watts)
 $= P(W) - [43 + 10\log(P)]$ (dB)
 $= [30 + 10\log(P)]$ (dBm) - $[43 + 10\log(P)]$ (dB)
 $= -13$ dBm.
11. For 5G NR n7/n38/n41
The limit line is derived from $55 + 10\log(P)$ dB below the transmitter power P(Watts)
 $= P(W) - [55 + 10\log(P)]$ (dB)
 $= [30 + 10\log(P)]$ (dBm) - $[55 + 10\log(P)]$ (dB)
 $= -25$ dBm.



3.9 Frequency Stability

3.9.1 Description of Frequency Stability Measurement

The frequency stability shall be measured by variation of ambient temperature and variation of primary supply voltage to ensure that the fundamental emission stays within the authorized frequency block.

3.9.2 Test Procedures for Temperature Variation

1. The testing follows ANSI C63.26 section 5.6.4
2. The EUT was set up in the thermal chamber and connected with the system simulator.
3. With power OFF, the temperature was decreased to -30°C and the EUT was stabilized before testing. Power was applied and the maximum change in frequency was recorded within one minute.
4. With power OFF, the temperature was raised in 10°C step up to 50°C. The EUT was stabilized at each step for at least half an hour. Power was applied and the maximum frequency change was recorded within one minute.

3.9.3 Test Procedures for Voltage Variation

1. The testing follows ANSI C63.26 section 5.6.5
2. The EUT was placed in a temperature chamber at 20±5°C and connected with the system simulator.
3. The power supply voltage to the EUT was varied from 85% to 115% of the nominal value for other than hand carried battery equipment.
4. For hand carried, battery powered equipment, reduce the primary ac or dc supply voltage to the battery operating end point, which shall be specified by the manufacturer.
5. The variation in frequency was measured for the worst case.

4 Radiated Test Items

4.1 Measuring Instruments

See list of measuring instruments of this test report.

4.2 Test Setup

4.2.1 For radiated test below 30MHz

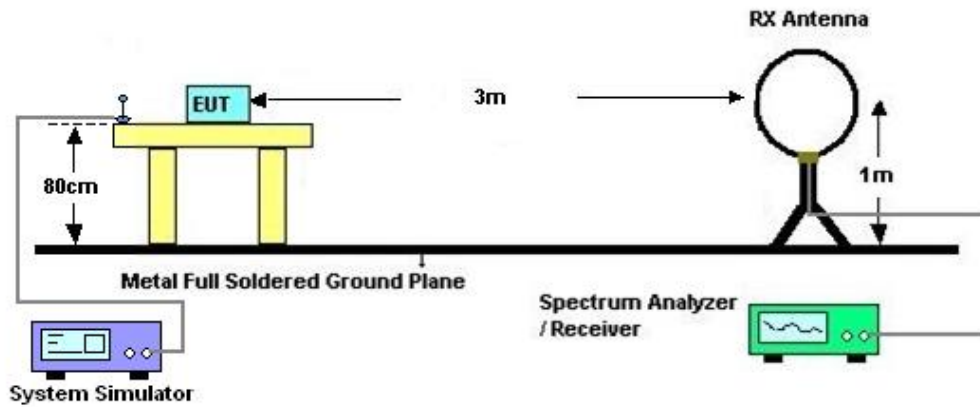

4.2.2 For radiated test from 30MHz to 1GHz

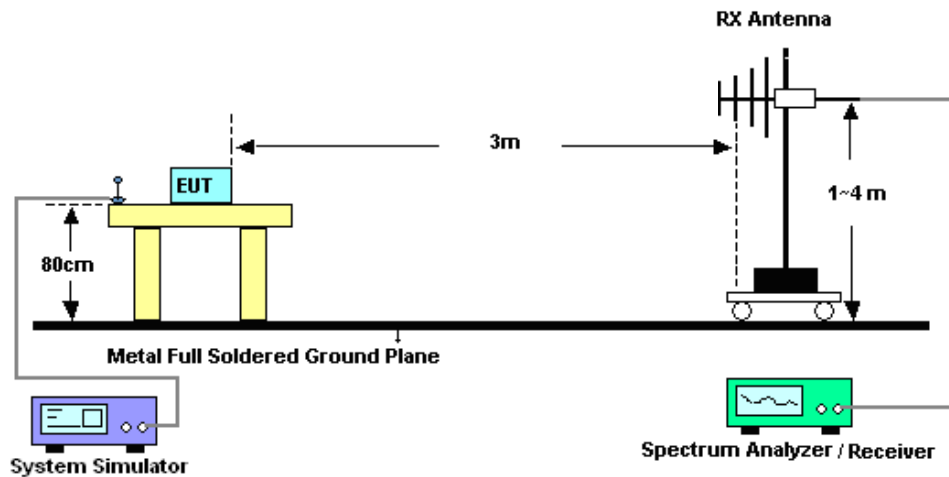

4.2.3 For radiated test above 1GHz

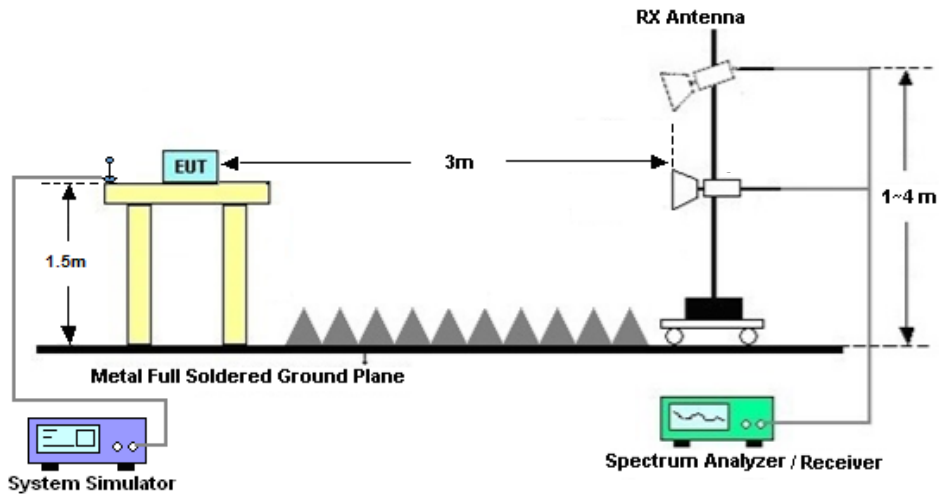

4.3 Test Result of Radiated Test

The low frequency, which started from 9 kHz to 30MHz, was pre-scanned and the result which was 20dB lower than the limit line was not reported.

Please refer to Appendix B.



4.4 Radiated Spurious Emission

4.4.1 Description of Radiated Spurious Emission

The radiated spurious emission was measured by substitution method according to ANSI C63.26. The power of any emission outside of the authorized operating frequency ranges must be attenuated below the transmitter power (P) by a factor of at least $43 + 10 \log (P)$ dB.

For 5G NR n7/n38/n41

The power of any emission outside of the authorized operating frequency ranges must be attenuated below the transmitter power (P) by a factor of at least $55 + 10 \log (P)$ dB.

The spectrum is scanned from 30 MHz up to a frequency including its 10th harmonic.

4.4.2 Test Procedures

1. The testing follows ANSI C63.26 Section 5.5
2. The EUT was placed on a turntable with 0.8 meter height for frequency below 1GHz and 1.5 meter height for frequency above 1GHz respectively above ground.
3. The EUT was set 3 meters from the receiving antenna mounted on the antenna tower.
4. The table was rotated 360 degrees to determine the position of the highest spurious emission.
5. The height of the receiving antenna is varied between 1m to 4m to search the maximum spurious emission for both horizontal and vertical polarizations.
6. During the measurement, the system simulator parameters were set to force the EUT transmitting at maximum output power.
7. Make the measurement with the spectrum analyzer's RBW = 1MHz, VBW = 3MHz, taking the record of maximum spurious emission.
8. A horn antenna was substituted in place of the EUT and was driven by a signal generator.
9. Tune the output power of signal generator to the same emission level with EUT maximum spurious emission.
10. $EIRP (dBm) = S.G. Power - Tx Cable Loss + Tx Antenna Gain$
11. $ERP (dBm) = EIRP - 2.15$
12. The RF fundamental frequency should be excluded against the limit line in the operating frequency band.

The limit line is derived from $43 + 10\log(P)$ dB below the transmitter power P(Watts)
 $= P(W) - [43 + 10\log(P)] (dB)$
 $= [30 + 10\log(P)] (dBm) - [43 + 10\log(P)] (dB)$
 $= -13dBm.$

13. For 5G NR n7/n38/n41:

The limit line is derived from $55 + 10\log(P)$ dB below the transmitter power P(Watts)The limit line is derived from $55 + 10\log(P)$ dB below the transmitter power P(Watts)



5 List of Measuring Equipment

Instrument	Manufacturer	Model No.	Serial No.	Characteristics	Calibration Date	Test Date	Due Date	Remark
EMI Test Receiver&SA	Agilent	N9038A	MY52260185	20Hz~26.5GHz	Dec. 27, 2021	Dec. 22, 2022~ Jan. 18, 2023	Dec. 26, 2022	Conducted (TH01-SZ)
EMI Test Receiver&SA	Agilent	N9038A	MY52260185	20Hz~26.5GHz	Dec. 26, 2022		Dec. 25, 2023	Conducted (TH01-SZ)
Power Divider	TOJOIN	PS-2SM-04 265	60.06.020.007 7	0.4GHz~26.5GHz	Dec. 26, 2021	Dec. 22, 2022~ Jan. 18, 2023	Dec. 25, 2022	Conducted (TH01-SZ)
Power Divider	TOJOIN	PS-2SM-04 265	60.06.020.007 7	0.4GHz~26.5GHz	Dec. 25, 2022		Dec. 24, 2023	Conducted (TH01-SZ)
Thermal Chamber	Ten Billion Hongzhangroup	LP-150U	H2014081803	-40~+150°C	Jul. 07, 2022	Dec. 22, 2022~ Jan. 18, 2023	Jul. 06, 2023	Conducted (TH01-SZ)
EMI Test Receiver&SA	Agilent	N9038A	MY52260185	20Hz~26.5GHz	Dec. 26, 2022	Jan. 12, 2023	Dec. 25, 2023	Radiation (03CH01-SZ)
Loop Antenna	R&S	HFH2-Z2	100354	9kHz~30MHz	Jul. 28, 2022	Jan. 12, 2023	Jul. 27, 2024	Radiation (03CH01-SZ)
HF Amplifier	KEYSIGHT	83017A	MY53270105	0.5GHz~26.5GHz	Oct. 19, 2022	Jan. 12, 2023	Oct. 18, 2023	Radiation (03CH01-SZ)
Bilog Antenna	TeseQ	CBL6112D	35407	30MHz-2GHz	Sep. 28, 2022	Jan. 12, 2023	Sep. 27, 2023	Radiation (03CH01-SZ)
Double Ridge Horn Antenna	ETS-Lindgren	3117	00119436	1GHz~18GHz	Jul. 07, 2022	Jan. 12, 2023	Jul. 06, 2023	Radiation (03CH01-SZ)
SHF-EHF Horn	com-power	AH-840	101071	18GHz-40GHz	Apr. 10, 2022	Jan. 12, 2023	Apr. 09, 2023	Radiation (03CH01-SZ)
LF Amplifier	Burgeon	BPA-530	102209	0.01~3000Mhz	Apr. 06, 2022	Jan. 12, 2023	Apr. 05, 2023	Radiation (03CH01-SZ)
HF Amplifier	MITEQ	AMF-7D-00 101800-30-1 0P-R	1943528	1GHz~18GHz	Oct. 19, 2022	Jan. 12, 2023	Oct. 18, 2023	Radiation (03CH01-SZ)
HF Amplifier	MITEQ	TTA1840-35 -HG	1871923	18GHz~40GHz	Jul. 06, 2022	Jan. 12, 2023	Jul. 05, 2023	Radiation (03CH01-SZ)
AC Power Source	Chroma	61601	616010001985	N/A	Nov. 10, 2022	Jan. 12, 2023	Nov. 09, 2023	Radiation (03CH01-SZ)
Turn Table	EM	EM1000	N/A	0~360 degree	NCR	Jan. 12, 2023	NCR	Radiation (03CH01-SZ)
Antenna Mast	EM	EM1000	N/A	1 m~4 m	NCR	Jan. 12, 2023	NCR	Radiation (03CH01-SZ)

NCR: No Calibration Required



6 Uncertainty of Evaluation

The measurement uncertainties shown below were calculated in accordance with the requirements of ANSI 63.26-2015. All the measurement uncertainty value were shown with a coverage K=2 to indicate 95% level of confidence. The measurement data show herein meets or exceeds the CISPR measurement uncertainty values specified in CISPR 16-4-2 and can be compared directly to specified limit to determine compliance.

Uncertainty of Conducted Measurement

Test Item	Uncertainty
Conducted Power	±1.34 dB
Conducted Emissions	±1.34 dB
Occupied Channel Bandwidth	±0.13 %

Uncertainty of Radiated Emission Measurement (30 MHz ~ 1000 MHz)

Measuring Uncertainty for a Level of Confidence of 95% (U = 2Uc(y))	2.48 dB
---	---------

Uncertainty of Radiated Emission Measurement (1 GHz ~ 18 GHz)

Measuring Uncertainty for a Level of Confidence of 95% (U = 2Uc(y))	3.53 dB
---	---------

Uncertainty of Radiated Emission Measurement (18 GHz ~ 40 GHz)

Measuring Uncertainty for a Level of Confidence of 95% (U = 2Uc(y))	4.02 dB
---	---------

----- THE END -----



Appendix A. Test Results of Conducted Test

Test Engineer :	Jung Kuo	Temperature :	22~23°C
		Relative Humidity :	40~42%

FR1 B2_N7(ANT3+ANT2)

Transmitter Conducted Output Power and EIRP, ($G_T - L_C$)=-0.86dB

NR Band	SCS (kHz)	Bandwidth (MHz)	Arfcn	Freq (MHz)	Modulation	RB	Conducted Power(dBm)	EIRP (dBm)	EIRP (W)
7	15	5	500500	2502.5	DFT-s-OFDM QPSK	1@1	22.13	21.27	0.1340
7	15	5	500500	2502.5	DFT-s-OFDM 16 QAM	1@1	20.96	20.1	0.1023
7	15	5	507000	2535.0	DFT-s-OFDM QPSK	1@1	22.98	22.12	0.1629
7	15	5	507000	2535.0	DFT-s-OFDM 16 QAM	1@1	22.08	21.22	0.1324
7	15	5	513500	2567.5	DFT-s-OFDM QPSK	1@1	22.57	21.71	0.1483
7	15	5	513500	2567.5	DFT-s-OFDM 16 QAM	1@1	21.43	20.57	0.1140
7	15	10	501000	2505.0	DFT-s-OFDM QPSK	1@1	22.24	21.38	0.1374
7	15	10	501000	2505.0	DFT-s-OFDM 16 QAM	1@1	21.02	20.16	0.1038
7	15	10	507000	2535.0	DFT-s-OFDM QPSK	1@1	22.93	22.07	0.1611
7	15	10	507000	2535.0	DFT-s-OFDM 16 QAM	1@1	21.67	20.81	0.1205
7	15	10	513000	2565.0	DFT-s-OFDM QPSK	1@1	22.56	21.7	0.1479
7	15	10	513000	2565.0	DFT-s-OFDM 16 QAM	1@1	21.33	20.47	0.1114
7	15	15	501500	2507.5	DFT-s-OFDM QPSK	1@1	22.18	21.32	0.1355
7	15	15	501500	2507.5	DFT-s-OFDM 16 QAM	1@1	20.93	20.07	0.1016
7	15	15	507000	2535.0	DFT-s-OFDM QPSK	1@1	23	22.14	0.1637
7	15	15	507000	2535.0	DFT-s-OFDM 16 QAM	1@1	21.67	20.81	0.1205
7	15	15	512500	2562.5	DFT-s-OFDM QPSK	1@1	23.09	22.23	0.1671
7	15	15	512500	2562.5	DFT-s-OFDM 16 QAM	1@1	21.8	20.94	0.1242
7	15	20	502000	2510.0	DFT-s-OFDM QPSK	1@1	22.33	21.47	0.1403
7	15	20	502000	2510.0	DFT-s-OFDM 16 QAM	1@1	21.1	20.24	0.1057
7	15	20	507000	2535.0	DFT-s-OFDM QPSK	1@1	22.63	21.77	0.1503
7	15	20	507000	2535.0	DFT-s-OFDM 16 QAM	1@1	21.34	20.48	0.1117

7	15	20	512000	2560.0	DFT-s-OFDM QPSK	1@1	23.25	22.39	0.1734
7	15	20	512000	2560.0	DFT-s-OFDM 16 QAM	1@1	22.3	21.44	0.1393
7	15	25	502500	2512.5	DFT-s-OFDM QPSK	1@1	22.43	21.57	0.1435
7	15	25	502500	2512.5	DFT-s-OFDM 16 QAM	1@1	21.16	20.3	0.1072
7	15	25	507000	2535.0	DFT-s-OFDM QPSK	1@1	22.99	22.13	0.1633
7	15	25	507000	2535.0	DFT-s-OFDM 16 QAM	1@1	21.58	20.72	0.1180
7	15	25	511500	2557.5	DFT-s-OFDM QPSK	1@1	23.31	22.45	0.1758
7	15	25	511500	2557.5	DFT-s-OFDM 16 QAM	1@1	22.12	21.26	0.1337
7	15	30	503000	2515.0	DFT-s-OFDM QPSK	1@1	22.28	21.42	0.1387
7	15	30	503000	2515.0	DFT-s-OFDM 16 QAM	1@1	21	20.14	0.1033
7	15	30	507000	2535.0	DFT-s-OFDM QPSK	1@1	22.3	21.44	0.1393
7	15	30	507000	2535.0	DFT-s-OFDM 16 QAM	1@1	21.05	20.19	0.1045
7	15	30	511000	2555.0	DFT-s-OFDM QPSK	1@1	23.22	22.36	0.1722
7	15	30	511000	2555.0	DFT-s-OFDM 16 QAM	1@1	22.14	21.28	0.1343
7	15	40	504000	2520.0	DFT-s-OFDM PI/2 BPSK	108@54	23.06	22.2	0.1660
7	15	40	504000	2520.0	DFT-s-OFDM PI/2 BPSK	1@1	23.01	22.15	0.1641
7	15	40	504000	2520.0	DFT-s-OFDM PI/2 BPSK	1@214	23.08	22.22	0.1667
7	15	40	504000	2520.0	DFT-s-OFDM QPSK	108@54	23.02	22.16	0.1644
7	15	40	504000	2520.0	DFT-s-OFDM QPSK	1@1	22.57	21.71	0.1483
7	15	40	504000	2520.0	DFT-s-OFDM QPSK	1@214	23.1	22.24	0.1675
7	15	40	504000	2520.0	DFT-s-OFDM 16 QAM	108@54	23.03	22.17	0.1648
7	15	40	504000	2520.0	DFT-s-OFDM 16 QAM	1@1	22.37	21.51	0.1416
7	15	40	504000	2520.0	DFT-s-OFDM 16 QAM	1@214	22.95	22.09	0.1618
7	15	40	504000	2520.0	DFT-s-OFDM 64 QAM	108@54	21.15	20.29	0.1069
7	15	40	504000	2520.0	DFT-s-OFDM 64 QAM	1@1	21.37	20.51	0.1125
7	15	40	504000	2520.0	DFT-s-OFDM 64 QAM	1@214	21.92	21.06	0.1276
7	15	40	504000	2520.0	DFT-s-OFDM 256 QAM	108@54	19.46	18.6	0.0724

7	15	40	504000	2520.0	DFT-s-OFDM 256 QAM	1@1	18.94	18.08	0.0643
7	15	40	504000	2520.0	DFT-s-OFDM 256 QAM	1@214	19.15	18.29	0.0675
7	15	40	504000	2520.0	CP-OFDM QPSK	108@54	22.59	21.73	0.1489
7	15	40	504000	2520.0	CP-OFDM QPSK	1@1	21.45	20.59	0.1146
7	15	40	504000	2520.0	CP-OFDM QPSK	1@214	22.3	21.44	0.1393
7	15	40	507000	2535.0	DFT-s-OFDM PI/2 BPSK	108@54	23.07	22.21	0.1663
7	15	40	507000	2535.0	DFT-s-OFDM PI/2 BPSK	1@1	22.86	22	0.1585
7	15	40	507000	2535.0	DFT-s-OFDM PI/2 BPSK	1@214	22.57	21.71	0.1483
7	15	40	507000	2535.0	DFT-s-OFDM QPSK	108@54	23.1	22.24	0.1675
7	15	40	507000	2535.0	DFT-s-OFDM QPSK	1@1	22.65	21.79	0.1510
7	15	40	507000	2535.0	DFT-s-OFDM QPSK	1@214	22.48	21.62	0.1452
7	15	40	507000	2535.0	DFT-s-OFDM 16 QAM	108@54	22.53	21.67	0.1469
7	15	40	507000	2535.0	DFT-s-OFDM 16 QAM	1@1	21.61	20.75	0.1189
7	15	40	507000	2535.0	DFT-s-OFDM 16 QAM	1@214	21.49	20.63	0.1156
7	15	40	507000	2535.0	DFT-s-OFDM 64 QAM	108@54	20.95	20.09	0.1021
7	15	40	507000	2535.0	DFT-s-OFDM 64 QAM	1@1	20.45	19.59	0.0910
7	15	40	507000	2535.0	DFT-s-OFDM 64 QAM	1@214	20.36	19.5	0.0891
7	15	40	507000	2535.0	DFT-s-OFDM 256 QAM	108@54	19.49	18.63	0.0729
7	15	40	507000	2535.0	DFT-s-OFDM 256 QAM	1@1	18.46	17.6	0.0575
7	15	40	507000	2535.0	DFT-s-OFDM 256 QAM	1@214	18.53	17.67	0.0585
7	15	40	507000	2535.0	CP-OFDM QPSK	108@54	21.91	21.05	0.1274
7	15	40	507000	2535.0	CP-OFDM QPSK	1@1	21.94	21.08	0.1282
7	15	40	507000	2535.0	CP-OFDM QPSK	1@214	21.83	20.97	0.1250
7	15	40	510000	2550.0	DFT-s-OFDM PI/2 BPSK	108@54	23.19	22.33	0.1710
7	15	40	510000	2550.0	DFT-s-OFDM PI/2 BPSK	1@1	23.07	22.21	0.1663
7	15	40	510000	2550.0	DFT-s-OFDM PI/2 BPSK	1@214	23.18	22.32	0.1706
7	15	40	510000	2550.0	DFT-s-OFDM QPSK	108@54	23.35	22.49	0.1774

7	15	40	510000	2550.0	DFT-s-OFDM QPSK	1@1	23.13	22.27	0.1687
7	15	40	510000	2550.0	DFT-s-OFDM QPSK	1@214	23.1	22.24	0.1675
7	15	40	510000	2550.0	DFT-s-OFDM 16 QAM	108@54	22.59	21.73	0.1489
7	15	40	510000	2550.0	DFT-s-OFDM 16 QAM	1@1	22.56	21.7	0.1479
7	15	40	510000	2550.0	DFT-s-OFDM 16 QAM	1@214	22.27	21.41	0.1384
7	15	40	510000	2550.0	DFT-s-OFDM 64 QAM	108@54	20.87	20.01	0.1002
7	15	40	510000	2550.0	DFT-s-OFDM 64 QAM	1@1	21.64	20.78	0.1197
7	15	40	510000	2550.0	DFT-s-OFDM 64 QAM	1@214	21.48	20.62	0.1153
7	15	40	510000	2550.0	DFT-s-OFDM 256 QAM	108@54	19.5	18.64	0.0731
7	15	40	510000	2550.0	DFT-s-OFDM 256 QAM	1@1	19.25	18.39	0.0690
7	15	40	510000	2550.0	DFT-s-OFDM 256 QAM	1@214	19.44	18.58	0.0721
7	15	40	510000	2550.0	CP-OFDM QPSK	108@54	22.15	21.29	0.1346
7	15	40	510000	2550.0	CP-OFDM QPSK	1@1	21.63	20.77	0.1194
7	15	40	510000	2550.0	CP-OFDM QPSK	1@214	21.22	20.36	0.1086

Frequency Stability

NR Band	SCS (kHz)	Bandwidth (MHz)	Arfcn	Freq (MHz)	Modulation	RB	Deviation (ppm)	Verdict	Environment
7	15	20	507000	2535.0	DFT-s-OFDM QPSK	100@0	0.0000	PASS	NV
7	15	20	507000	2535.0	DFT-s-OFDM QPSK	100@0	0.0005	PASS	LV
7	15	20	507000	2535.0	DFT-s-OFDM QPSK	100@0	0.0019	PASS	HV
7	15	20	507000	2535.0	DFT-s-OFDM QPSK	100@0	0.0020	PASS	-30°C
7	15	20	507000	2535.0	DFT-s-OFDM QPSK	100@0	0.0009	PASS	-20°C
7	15	20	507000	2535.0	DFT-s-OFDM QPSK	100@0	0.0016	PASS	-10°C
7	15	20	507000	2535.0	DFT-s-OFDM QPSK	100@0	0.0002	PASS	0°C
7	15	20	507000	2535.0	DFT-s-OFDM QPSK	100@0	0.0018	PASS	10°C
7	15	20	507000	2535.0	DFT-s-OFDM QPSK	100@0	0.0000	PASS	20°C
7	15	20	507000	2535.0	DFT-s-OFDM QPSK	100@0	0.0004	PASS	30°C
7	15	20	507000	2535.0	DFT-s-OFDM QPSK	100@0	0.0021	PASS	40°C
7	15	20	507000	2535.0	DFT-s-OFDM QPSK	100@0	0.0021	PASS	50°C

Peak to Average Ratio

NR Band	SCS (kHz)	Bandwidth (MHz)	Arcfn	Freq (MHz)	Modulation	RB	Result (dB)	Limit (dB)	Verdict
7	15	20	502000	2510.0	DFT-s-OFDM PI/2 BPSK	100@0	4.46	13	PASS
7	15	20	502000	2510.0	DFT-s-OFDM PI/2 BPSK	1@0	5.21	13	PASS
7	15	20	502000	2510.0	DFT-s-OFDM QPSK	100@0	4.52	13	PASS
7	15	20	502000	2510.0	DFT-s-OFDM QPSK	1@0	4.85	13	PASS
7	15	20	507000	2535.0	DFT-s-OFDM PI/2 BPSK	100@0	4.58	13	PASS
7	15	20	507000	2535.0	DFT-s-OFDM PI/2 BPSK	1@0	5.23	13	PASS
7	15	20	507000	2535.0	DFT-s-OFDM QPSK	100@0	4.67	13	PASS
7	15	20	507000	2535.0	DFT-s-OFDM QPSK	1@0	5.25	13	PASS
7	15	20	512000	2560.0	DFT-s-OFDM PI/2 BPSK	100@0	4.54	13	PASS
7	15	20	512000	2560.0	DFT-s-OFDM PI/2 BPSK	1@0	4.75	13	PASS
7	15	20	512000	2560.0	DFT-s-OFDM QPSK	100@0	4.58	13	PASS
7	15	20	512000	2560.0	DFT-s-OFDM QPSK	1@0	5.68	13	PASS

B2_N7(20M)_DFT-s-OFDM_PI_2-BPSK_Outer_Full_Low_CH

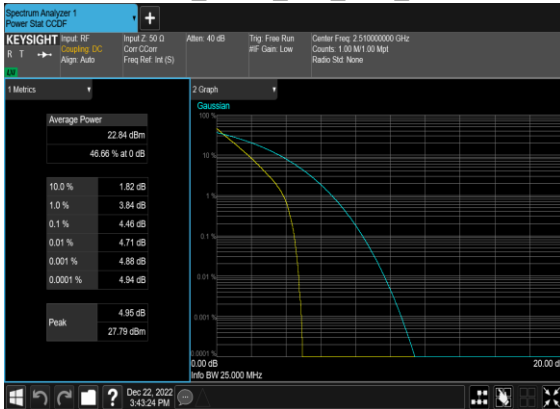

B2_N7(20M)_DFT-s-OFDM_PI_2-BPSK_Edge_1RB_Left_Low_CH



B2_N7(20M)_DFT-s-OFDM_QPSK_Outer_Full_Low_CH



B2_N7(20M)_DFT-s-OFDM_QPSK_Edge_1RB_Left_Low_CH

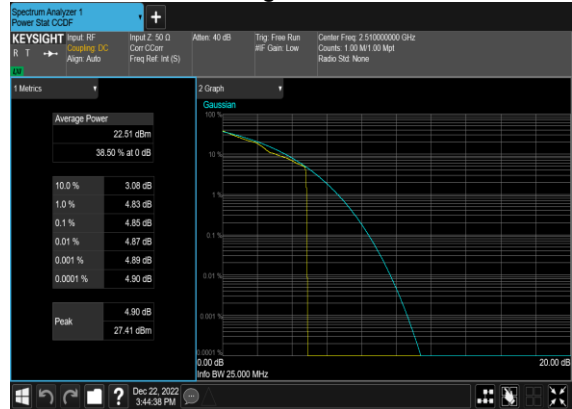

B2_N7(20M)_DFT-s-OFDM_PI_2-BPSK_Outer_Full_Mid_CH

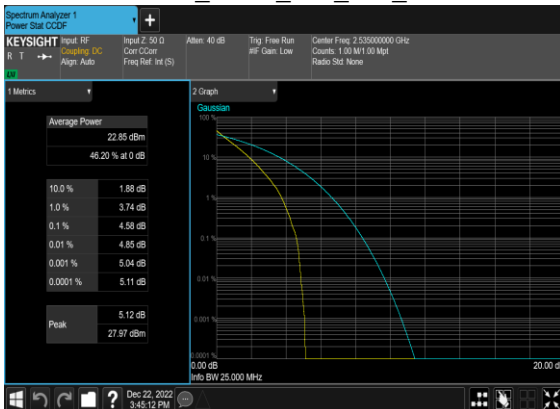

B2_N7(20M)_DFT-s-OFDM_PI_2-BPSK_Edge_1RB_Left_Mid_CH



B2_N7(20M)_DFT-s-OFDM_QPSK_Outer_Full_Mid_CH

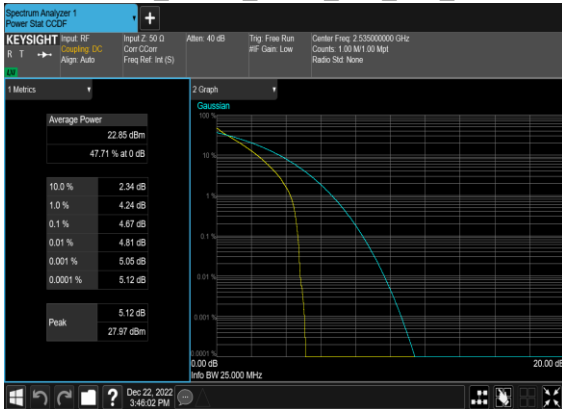

B2_N7(20M)_DFT-s-OFDM_QPSK_Edge_1RB_Left_Mid_CH



B2_N7(20M)_DFT-s-OFDM_PI_2-BPSK_Outer_Full_High_CH

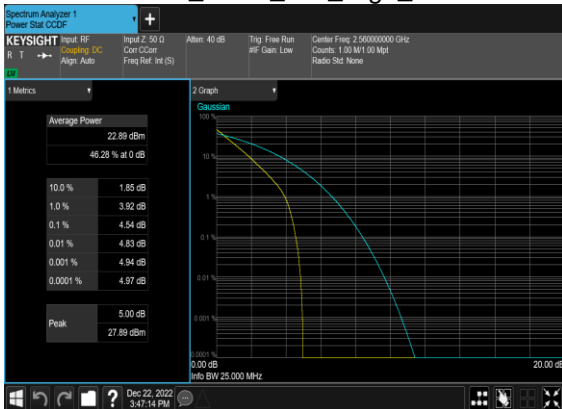

B2_N7(20M)_DFT-s-OFDM_PI_2-BPSK_Edge_1RB_Left_High_CH



B2_N7(20M)_DFT-s-OFDM_QPSK_Outer_Full_High_CH

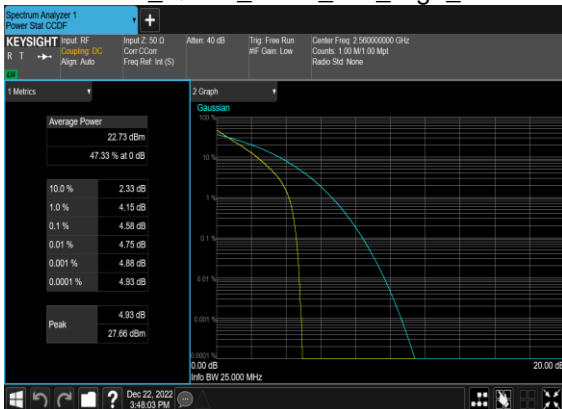

B2_N7(20M)_DFT-s-OFDM_QPSK_Edge_1RB_Left_High_CH

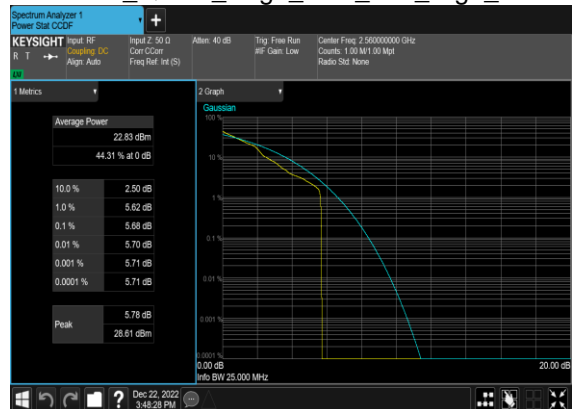

Occupied Bandwidth

NR Band	SCS (kHz)	Bandwidth (MHz)	Arfcn	Freq (MHz)	Modulation	RB	OBW (MHz)	26dB BW (MHz)
7	15	5	507000	2535.0	DFT-s-OFDM PI/2 BPSK	25@0	4.4769	4.843
7	15	5	507000	2535.0	DFT-s-OFDM QPSK	25@0	4.471	5.051
7	15	5	507000	2535.0	CP-OFDM QPSK	25@0	4.4652	4.987
7	15	5	507000	2535.0	CP-OFDM 16 QAM	25@0	4.501	5.161
7	15	5	507000	2535.0	CP-OFDM 64 QAM	25@0	4.4653	4.979
7	15	5	507000	2535.0	CP-OFDM 256 QAM	25@0	4.4872	5.044
7	15	10	507000	2535.0	DFT-s-OFDM PI/2 BPSK	50@0	8.8956	9.563
7	15	10	507000	2535.0	DFT-s-OFDM QPSK	50@0	8.8982	9.646
7	15	10	507000	2535.0	CP-OFDM QPSK	52@0	9.2656	10.03
7	15	10	507000	2535.0	CP-OFDM 16 QAM	52@0	9.2907	9.953
7	15	10	507000	2535.0	CP-OFDM 64 QAM	52@0	9.2531	9.997
7	15	10	507000	2535.0	CP-OFDM 256 QAM	52@0	9.2799	9.97
7	15	15	507000	2535.0	DFT-s-OFDM PI/2 BPSK	75@0	13.382	14.3
7	15	15	507000	2535.0	DFT-s-OFDM QPSK	75@0	13.395	14.18
7	15	15	507000	2535.0	CP-OFDM QPSK	79@0	14.107	14.85
7	15	15	507000	2535.0	CP-OFDM 16 QAM	79@0	14.08	14.76
7	15	15	507000	2535.0	CP-OFDM 64 QAM	79@0	14.083	14.87
7	15	15	507000	2535.0	CP-OFDM 256 QAM	79@0	14.081	14.88
7	15	20	507000	2535.0	DFT-s-OFDM PI/2 BPSK	100@0	17.924	18.68
7	15	20	507000	2535.0	DFT-s-OFDM QPSK	100@0	17.852	18.65
7	15	20	507000	2535.0	CP-OFDM QPSK	106@0	18.904	19.93
7	15	20	507000	2535.0	CP-OFDM 16 QAM	106@0	18.911	19.82
7	15	20	507000	2535.0	CP-OFDM 64 QAM	106@0	18.904	19.7
7	15	20	507000	2535.0	CP-OFDM 256 QAM	106@0	18.927	19.74
7	15	25	507000	2535.0	DFT-s-OFDM PI/2 BPSK	128@0	22.847	23.9

7	15	25	507000	2535.0	DFT-s-OFDM QPSK	128@0	22.873	23.88
7	15	25	507000	2535.0	CP-OFDM QPSK	133@0	23.69	24.86
7	15	25	507000	2535.0	CP-OFDM 16 QAM	133@0	23.736	24.88
7	15	25	507000	2535.0	CP-OFDM 64 QAM	133@0	23.771	24.6
7	15	25	507000	2535.0	CP-OFDM 256 QAM	133@0	23.749	24.58
7	15	30	507000	2535.0	DFT-s-OFDM PI/2 BPSK	160@0	28.644	29.61
7	15	30	507000	2535.0	DFT-s-OFDM QPSK	160@0	28.461	29.57
7	15	30	507000	2535.0	CP-OFDM QPSK	160@0	28.531	29.63
7	15	30	507000	2535.0	CP-OFDM 16 QAM	160@0	28.554	29.52
7	15	30	507000	2535.0	CP-OFDM 64 QAM	160@0	28.573	29.65
7	15	30	507000	2535.0	CP-OFDM 256 QAM	160@0	28.507	29.63
7	15	40	507000	2535.0	DFT-s-OFDM PI/2 BPSK	216@0	38.582	40.08
7	15	40	507000	2535.0	DFT-s-OFDM QPSK	216@0	38.478	39.98
7	15	40	507000	2535.0	CP-OFDM QPSK	216@0	38.578	40.01
7	15	40	507000	2535.0	CP-OFDM 16 QAM	216@0	38.512	39.92
7	15	40	507000	2535.0	CP-OFDM 64 QAM	216@0	38.585	39.88
7	15	40	507000	2535.0	CP-OFDM 256 QAM	216@0	38.526	39.88

B2_N7(5M)_DFT-s-OFDM_PI_2-
BPSK_Outer_Full_Mid_CH



B2_N7(5M)_DFT-s-
OFDM_QPSK_Outer_Full_Mid_CH



B2_N7(5M)_CP-
OFDM_QPSK_Outer_Full_Mid_CH



B2_N7(5M)_CP-OFDM_16
QAM_Outer_Full_Mid_CH



B2_N7(5M)_CP-OFDM_64
QAM_Outer_Full_Mid_CH

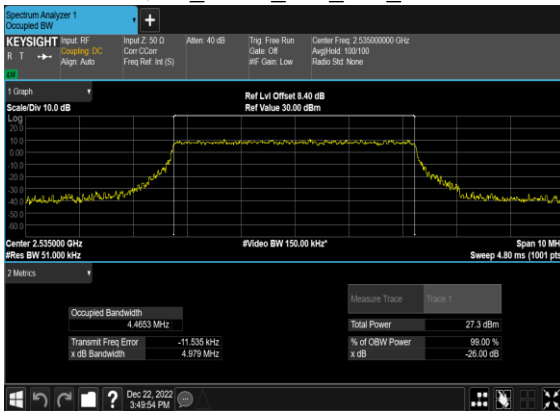

B2_N7(5M)_CP-OFDM_256
QAM_Outer_Full_Mid_CH

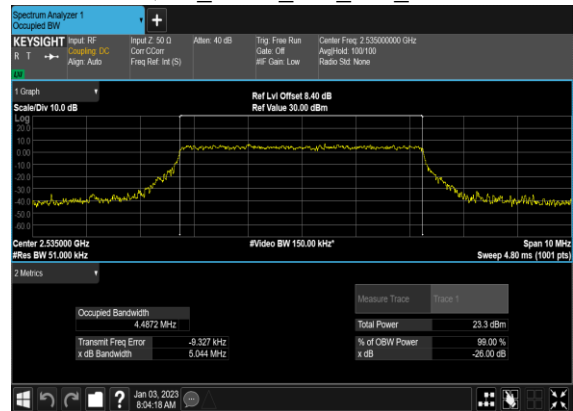

B2_N7(10M)_DFT-s-OFDM_PI_2-
BPSK_Outer_Full_Mid_CH

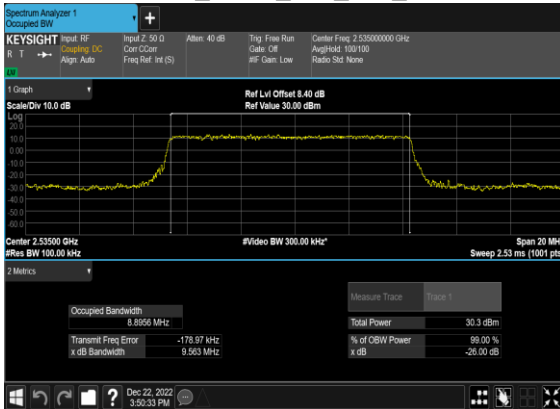

B2_N7(10M)_DFT-s-
OFDM_QPSK_Outer_Full_Mid_CH

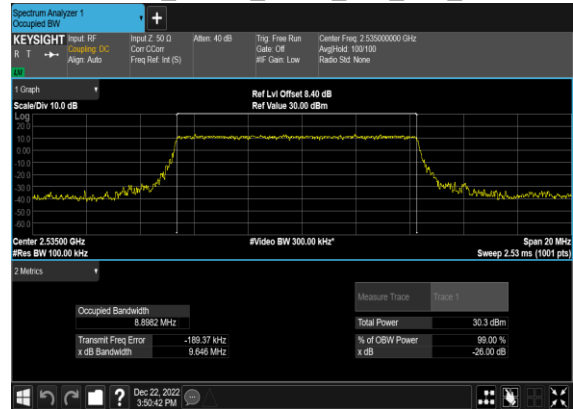

B2_N7(10M)_CP-
OFDM_QPSK_Outer_Full_Mid_CH



B2_N7(10M)_CP-OFDM_16
QAM_Outer_Full_Mid_CH

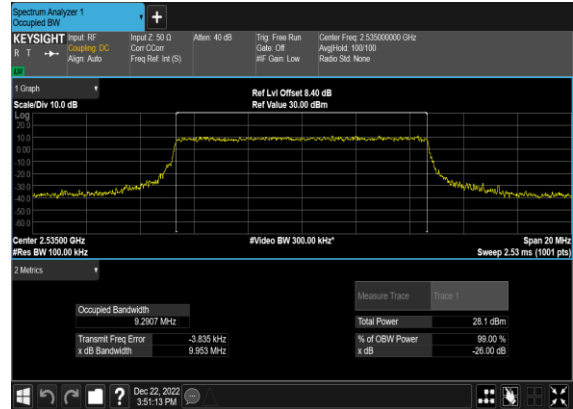

B2_N7(10M)_CP-OFDM_64
QAM_Outer_Full_Mid_CH

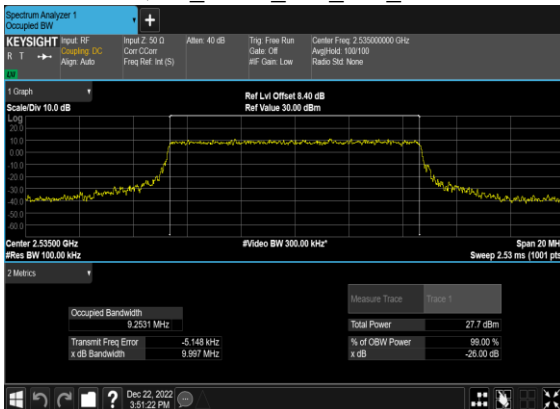

B2_N7(10M)_CP-OFDM_256
QAM_Outer_Full_Mid_CH

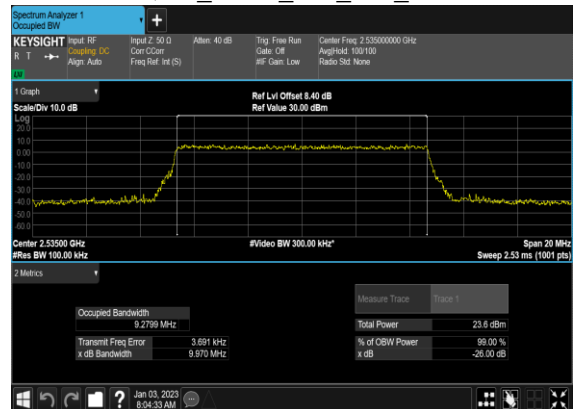

B2_N7(15M)_DFT-s-OFDM_PI_2-
BPSK_Outer_Full_Mid_CH

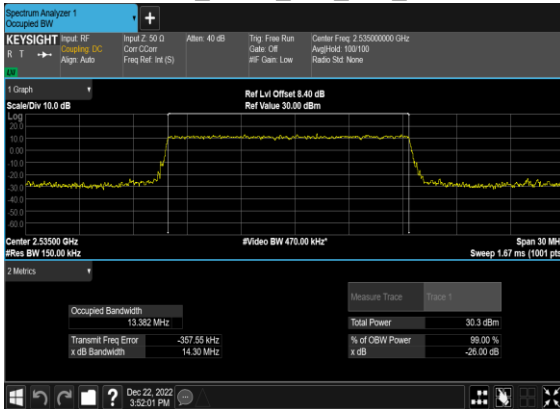

B2_N7(15M)_DFT-s-
OFDM_QPSK_Outer_Full_Mid_CH

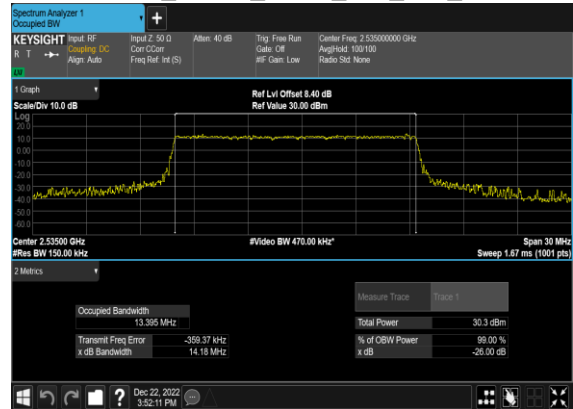

B2_N7(15M)_CP-
OFDM_QPSK_Outer_Full_Mid_CH



B2_N7(15M)_CP-OFDM_16
QAM_Outer_Full_Mid_CH

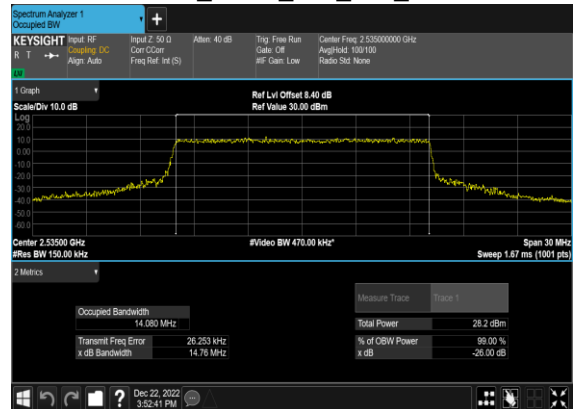

B2_N7(15M)_CP-OFDM_64
QAM_Outer_Full_Mid_CH

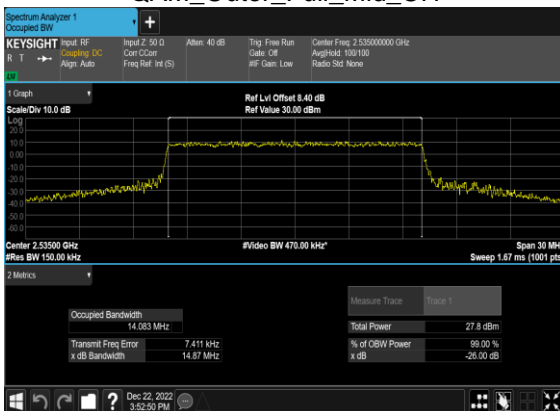

B2_N7(15M)_CP-OFDM_256
QAM_Outer_Full_Mid_CH

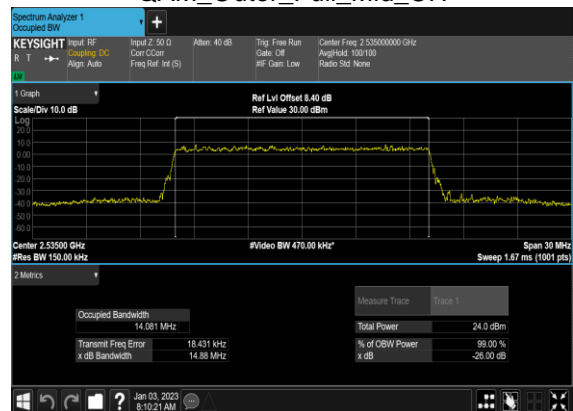

B2_N7(20M)_DFT-s-OFDM_PI_2-
BPSK_Outer_Full_Mid_CH

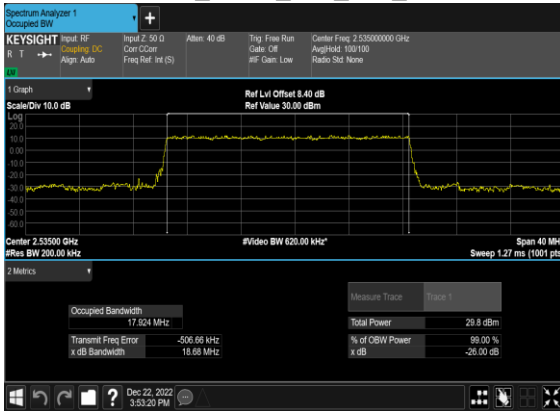

B2_N7(20M)_DFT-s-
OFDM_QPSK_Outer_Full_Mid_CH



B2_N7(20M)_CP-
OFDM_QPSK_Outer_Full_Mid_CH

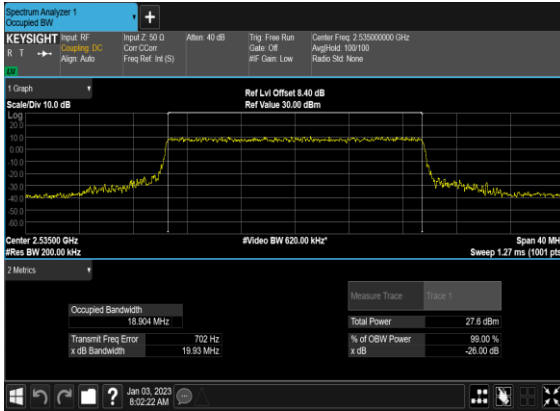

B2_N7(20M)_CP-OFDM_16
QAM_Outer_Full_Mid_CH



B2_N7(20M)_CP-OFDM_64
QAM_Outer_Full_Mid_CH

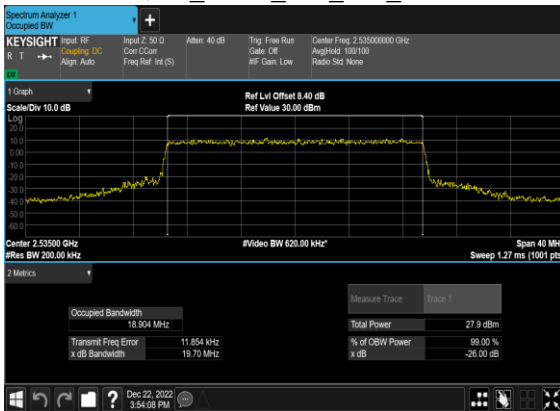

B2_N7(20M)_CP-OFDM_256
QAM_Outer_Full_Mid_CH

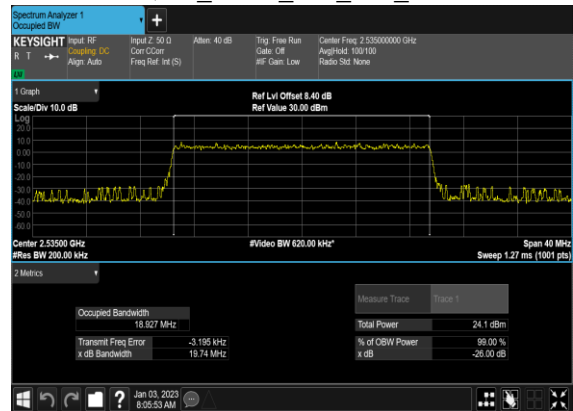

B2_N7(25M)_DFT-s-OFDM_PI_2-
BPSK_Outer_Full_Mid_CH

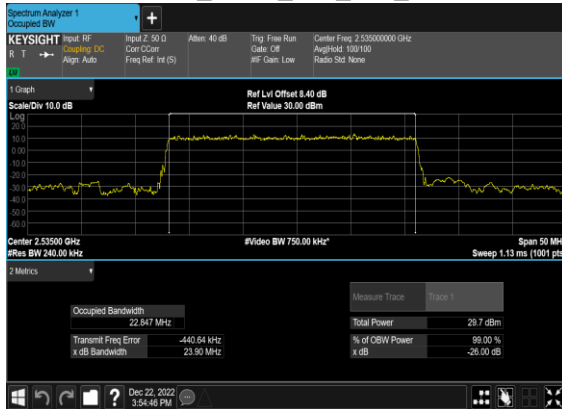

B2_N7(25M)_DFT-s-
OFDM_QPSK_Outer_Full_Mid_CH

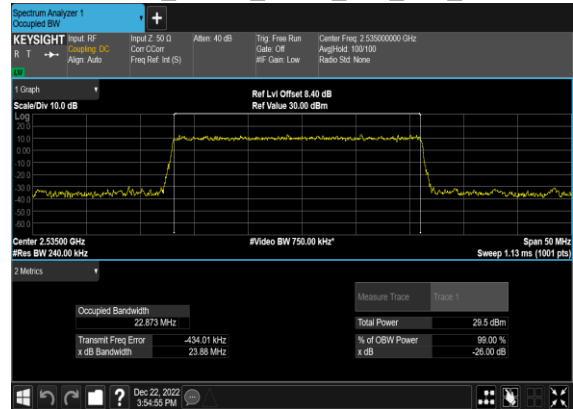

B2_N7(25M)_CP-
OFDM_QPSK_Outer_Full_Mid_CH

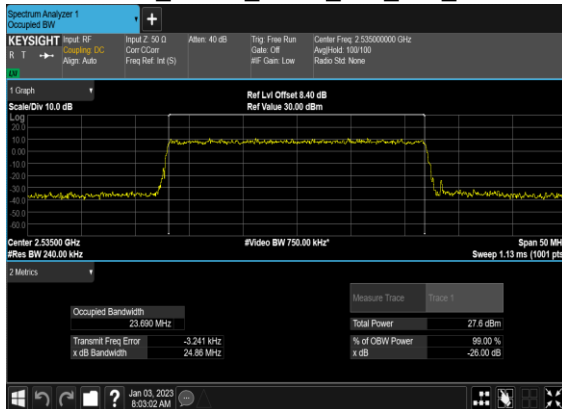

B2_N7(25M)_CP-OFDM_16
QAM_Outer_Full_Mid_CH

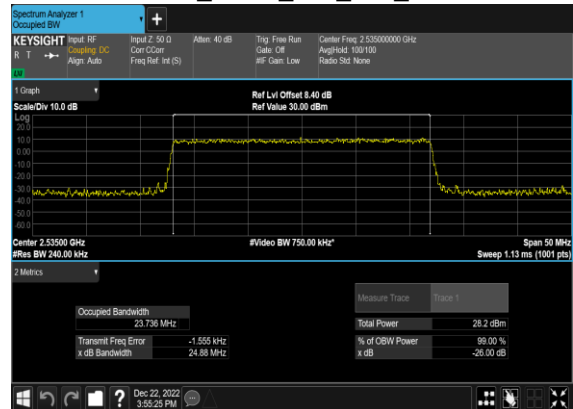

B2_N7(25M)_CP-OFDM_64
QAM_Outer_Full_Mid_CH

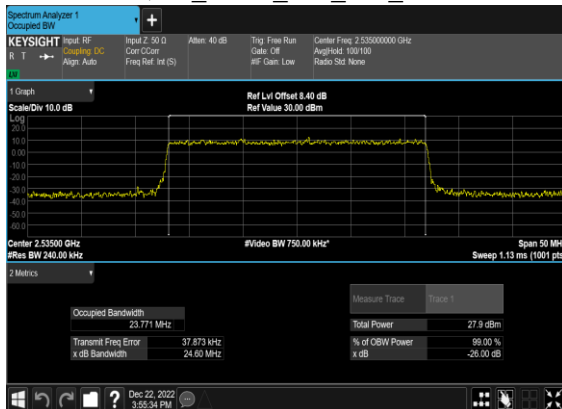

B2_N7(25M)_CP-OFDM_256
QAM_Outer_Full_Mid_CH

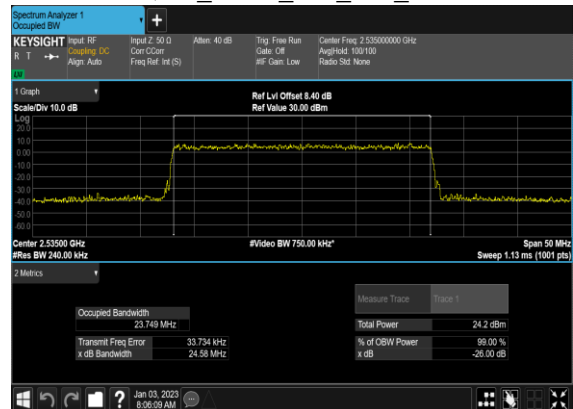

B2_N7(30M)_DFT-s-OFDM_PI_2-
BPSK_Outer_Full_Mid_CH

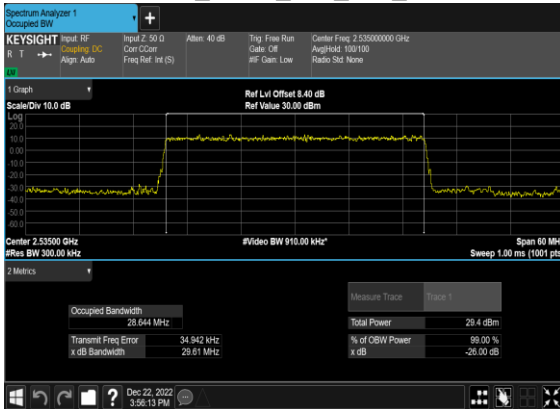

B2_N7(30M)_DFT-s-
OFDM_QPSK_Outer_Full_Mid_CH

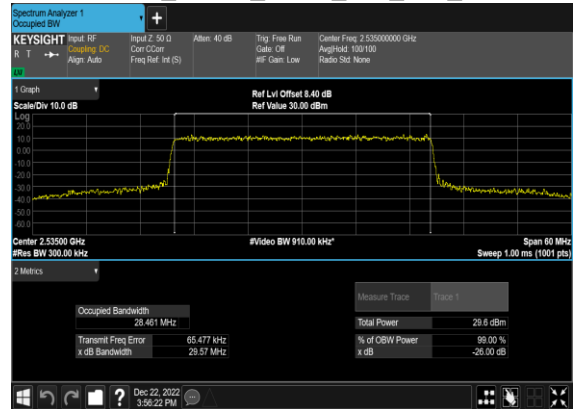

B2_N7(30M)_CP-
OFDM_QPSK_Outer_Full_Mid_CH



B2_N7(30M)_CP-OFDM_16
QAM_Outer_Full_Mid_CH

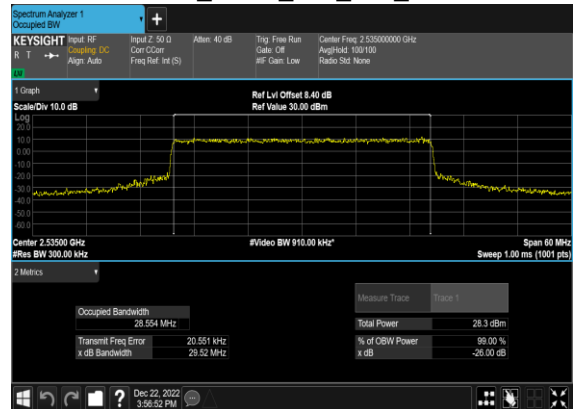

B2_N7(30M)_CP-OFDM_64
QAM_Outer_Full_Mid_CH

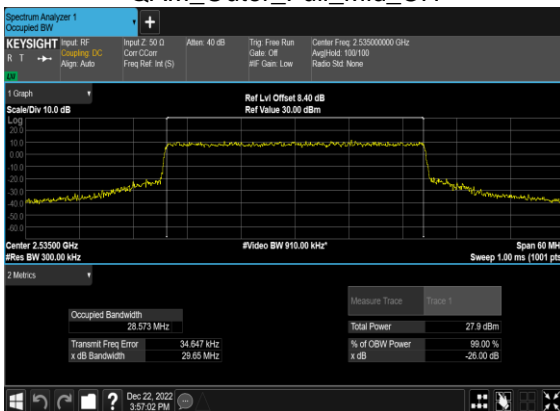

B2_N7(30M)_CP-OFDM_256
QAM_Outer_Full_Mid_CH

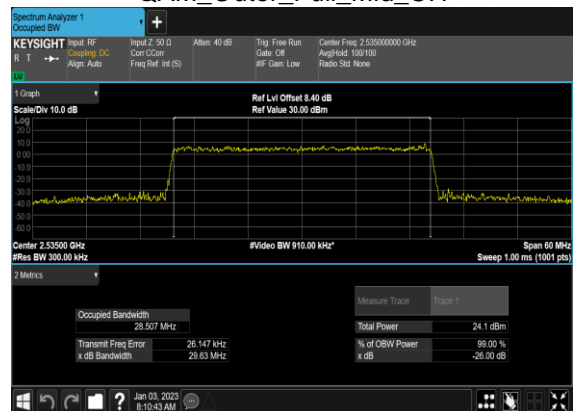

B2_N7(40M)_DFT-s-OFDM_PI_2-
BPSK_Outer_Full_Mid_CH

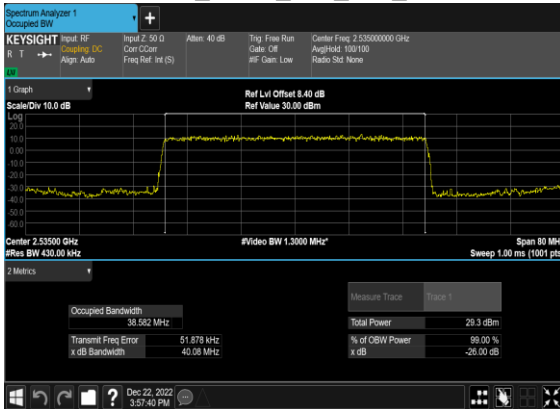

B2_N7(40M)_DFT-s-
OFDM_QPSK_Outer_Full_Mid_CH

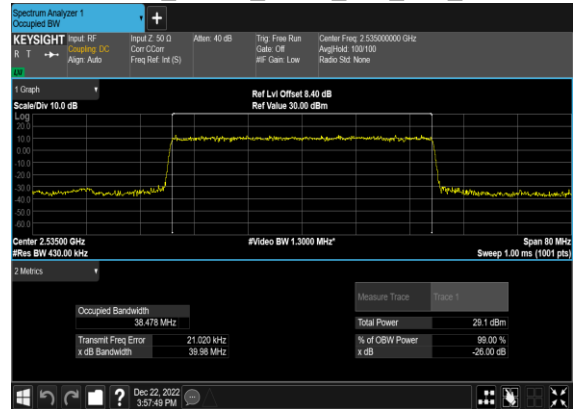

B2_N7(40M)_CP-
OFDM_QPSK_Outer_Full_Mid_CH

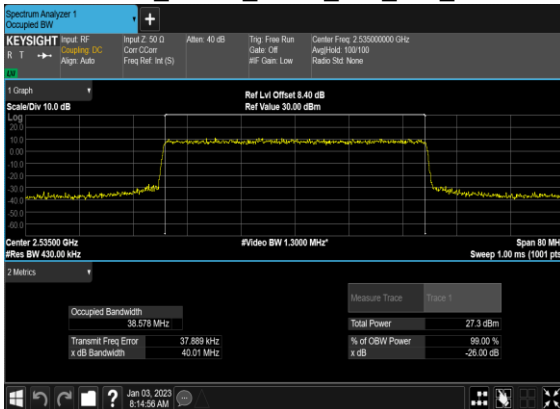

B2_N7(40M)_CP-OFDM_16
QAM_Outer_Full_Mid_CH

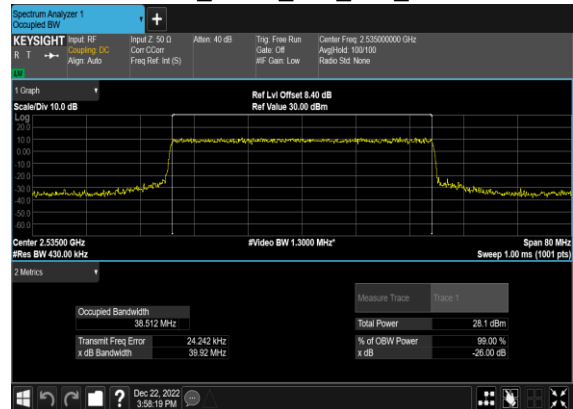

B2_N7(40M)_CP-OFDM_64
QAM_Outer_Full_Mid_CH

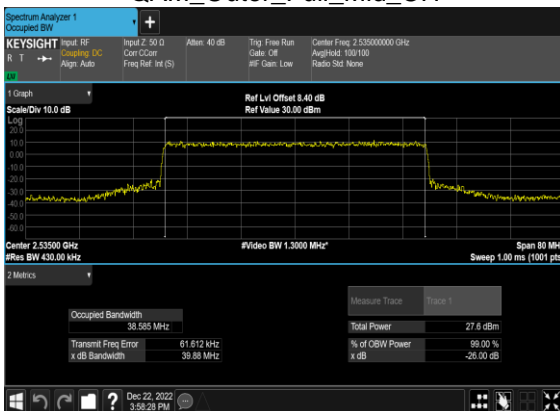

B2_N7(40M)_CP-OFDM_256
QAM_Outer_Full_Mid_CH

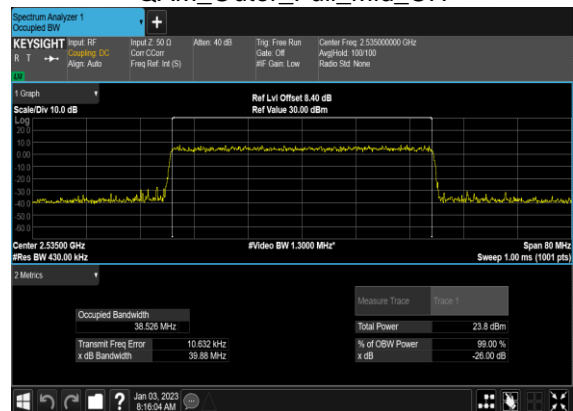

Conducted Spurious Emissions

NR Band	SCS (kHz)	Bandwidth (MHz)	Arfcn	Freq (MHz)	Modulation	RB	Result	Verdict
7	15	5	500500	2502.5	DFT-s-OFDM BPSK	1@0	see graph	---
7	15	5	500500	2502.5	DFT-s-OFDM BPSK	1@0	see graph	PASS
7	15	5	500500	2502.5	DFT-s-OFDM BPSK	1@0	see graph	PASS
7	15	5	500500	2502.5	DFT-s-OFDM QPSK	1@0	see graph	---
7	15	5	500500	2502.5	DFT-s-OFDM QPSK	1@0	see graph	PASS
7	15	5	500500	2502.5	DFT-s-OFDM QPSK	1@0	see graph	PASS
7	15	5	507000	2535.0	DFT-s-OFDM BPSK	1@0	see graph	---
7	15	5	507000	2535.0	DFT-s-OFDM BPSK	1@0	see graph	PASS
7	15	5	507000	2535.0	DFT-s-OFDM BPSK	1@0	see graph	PASS
7	15	5	507000	2535.0	DFT-s-OFDM QPSK	1@0	see graph	---
7	15	5	507000	2535.0	DFT-s-OFDM QPSK	1@0	see graph	PASS
7	15	5	507000	2535.0	DFT-s-OFDM QPSK	1@0	see graph	PASS
7	15	5	513500	2567.5	DFT-s-OFDM BPSK	1@0	see graph	---
7	15	5	513500	2567.5	DFT-s-OFDM BPSK	1@0	see graph	PASS
7	15	5	513500	2567.5	DFT-s-OFDM BPSK	1@0	see graph	PASS
7	15	5	513500	2567.5	DFT-s-OFDM QPSK	1@0	see graph	---
7	15	5	513500	2567.5	DFT-s-OFDM QPSK	1@0	see graph	PASS
7	15	5	513500	2567.5	DFT-s-OFDM QPSK	1@0	see graph	PASS
7	15	20	502000	2510.0	DFT-s-OFDM BPSK	1@0	see graph	---
7	15	20	502000	2510.0	DFT-s-OFDM BPSK	1@0	see graph	PASS
7	15	20	502000	2510.0	DFT-s-OFDM BPSK	1@0	see graph	PASS
7	15	20	502000	2510.0	DFT-s-OFDM QPSK	1@0	see graph	---

7	15	20	502000	2510.0	DFT-s-OFDM QPSK	1@0	see graph	PASS
7	15	20	502000	2510.0	DFT-s-OFDM QPSK	1@0	see graph	PASS
7	15	20	507000	2535.0	DFT-s-OFDM BPSK	1@0	see graph	---
7	15	20	507000	2535.0	DFT-s-OFDM BPSK	1@0	see graph	PASS
7	15	20	507000	2535.0	DFT-s-OFDM BPSK	1@0	see graph	PASS
7	15	20	507000	2535.0	DFT-s-OFDM QPSK	1@0	see graph	---
7	15	20	507000	2535.0	DFT-s-OFDM QPSK	1@0	see graph	PASS
7	15	20	507000	2535.0	DFT-s-OFDM QPSK	1@0	see graph	PASS
7	15	20	512000	2560.0	DFT-s-OFDM BPSK	1@0	see graph	---
7	15	20	512000	2560.0	DFT-s-OFDM BPSK	1@0	see graph	PASS
7	15	20	512000	2560.0	DFT-s-OFDM BPSK	1@0	see graph	PASS
7	15	20	512000	2560.0	DFT-s-OFDM QPSK	1@0	see graph	---
7	15	20	512000	2560.0	DFT-s-OFDM QPSK	1@0	see graph	PASS
7	15	20	512000	2560.0	DFT-s-OFDM QPSK	1@0	see graph	PASS
7	15	40	504000	2520.0	DFT-s-OFDM BPSK	1@0	see graph	---
7	15	40	504000	2520.0	DFT-s-OFDM BPSK	1@0	see graph	PASS
7	15	40	504000	2520.0	DFT-s-OFDM BPSK	1@0	see graph	PASS
7	15	40	504000	2520.0	DFT-s-OFDM QPSK	1@0	see graph	---
7	15	40	504000	2520.0	DFT-s-OFDM QPSK	1@0	see graph	PASS
7	15	40	504000	2520.0	DFT-s-OFDM QPSK	1@0	see graph	PASS
7	15	40	507000	2535.0	DFT-s-OFDM BPSK	1@0	see graph	---
7	15	40	507000	2535.0	DFT-s-OFDM BPSK	1@0	see graph	PASS
7	15	40	507000	2535.0	DFT-s-OFDM BPSK	1@0	see graph	PASS
7	15	40	507000	2535.0	DFT-s-OFDM QPSK	1@0	see graph	---

7	15	40	507000	2535.0	DFT-s-OFDM QPSK	1@0	see graph	PASS
7	15	40	507000	2535.0	DFT-s-OFDM QPSK	1@0	see graph	PASS
7	15	40	510000	2550.0	DFT-s-OFDM BPSK	1@0	see graph	---
7	15	40	510000	2550.0	DFT-s-OFDM BPSK	1@0	see graph	PASS
7	15	40	510000	2550.0	DFT-s-OFDM BPSK	1@0	see graph	PASS
7	15	40	510000	2550.0	DFT-s-OFDM QPSK	1@0	see graph	---
7	15	40	510000	2550.0	DFT-s-OFDM QPSK	1@0	see graph	PASS
7	15	40	510000	2550.0	DFT-s-OFDM QPSK	1@0	see graph	PASS

B2_N7(5M)_DFT-s-OFDM_QPSK_Edge_1RB_Left_Mid_CH

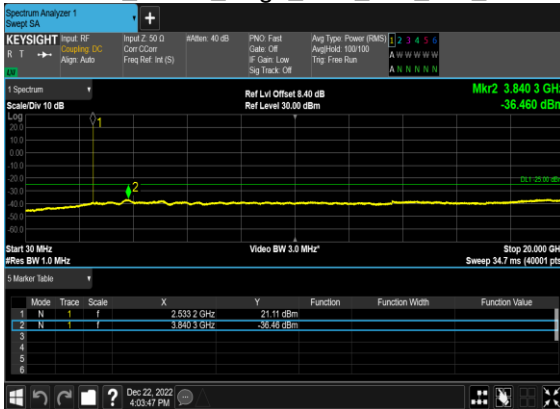

B2_N7(5M)_DFT-s-OFDM_QPSK_Edge_1RB_Left_Mid_CH

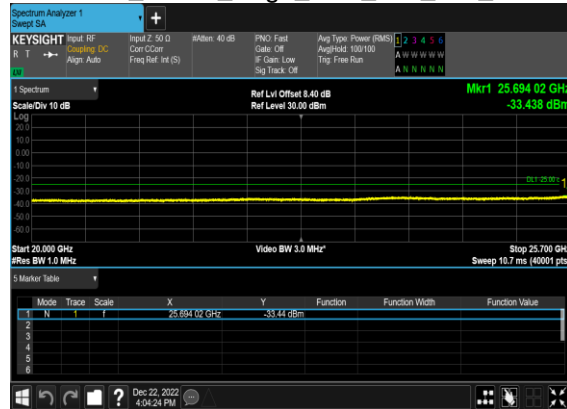

B2_N7(5M)_DFT-s-OFDM_BPSK_Edge_1RB_Left_High_CH

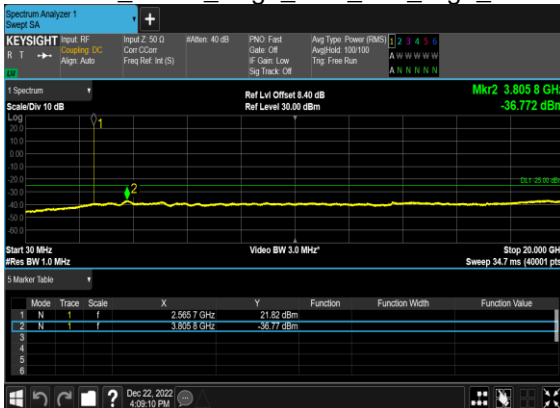

B2_N7(5M)_DFT-s-OFDM_BPSK_Edge_1RB_Left_High_CH

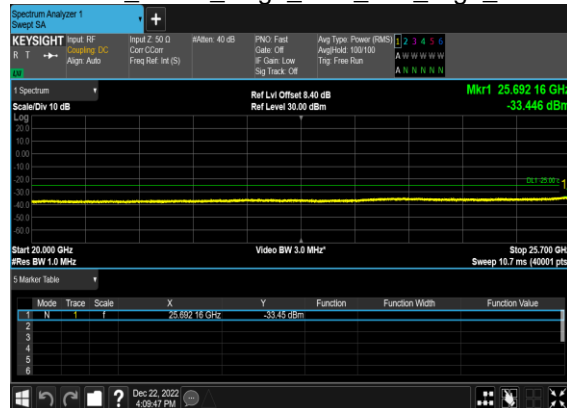

B2_N7(5M)_DFT-s-OFDM_QPSK_Edge_1RB_Left_High_CH



B2_N7(5M)_DFT-s-OFDM_QPSK_Edge_1RB_Left_High_CH

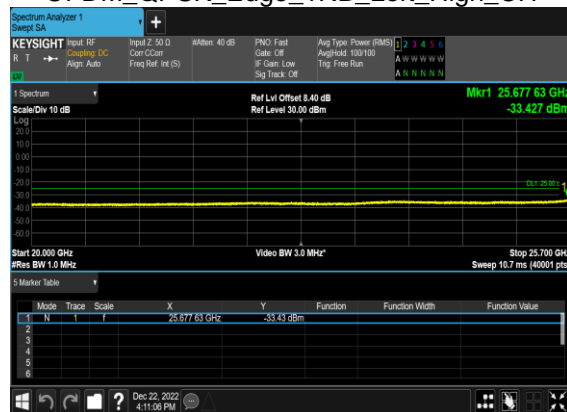

B2_N7(20M)_DFT-s-OFDM_QPSK_Edge_1RB_Left_Mid_CH

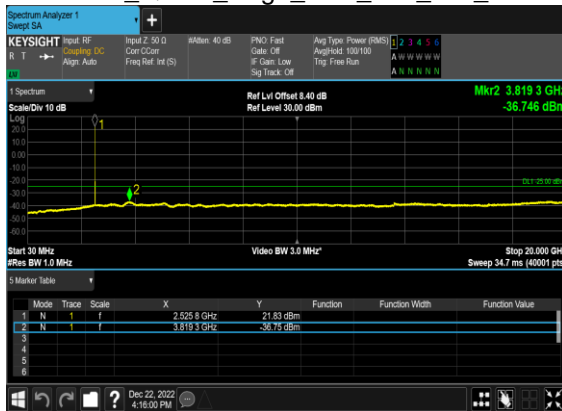

B2_N7(20M)_DFT-s-OFDM_QPSK_Edge_1RB_Left_Mid_CH

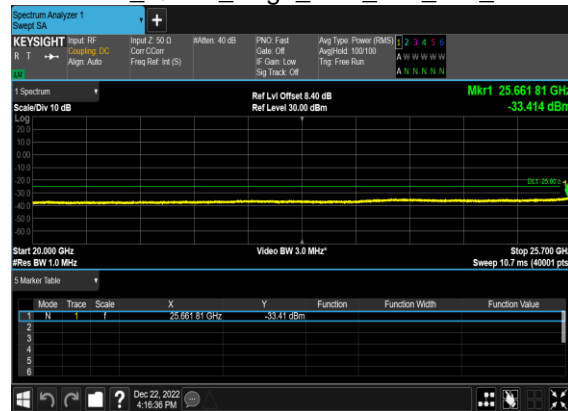

B2_N7(20M)_DFT-s-OFDM_BPSK_Edge_1RB_Left_High_CH



B2_N7(20M)_DFT-s-OFDM_BPSK_Edge_1RB_Left_High_CH



B2_N7(20M)_DFT-s-OFDM_QPSK_Edge_1RB_Left_High_CH



B2_N7(20M)_DFT-s-OFDM_QPSK_Edge_1RB_Left_High_CH

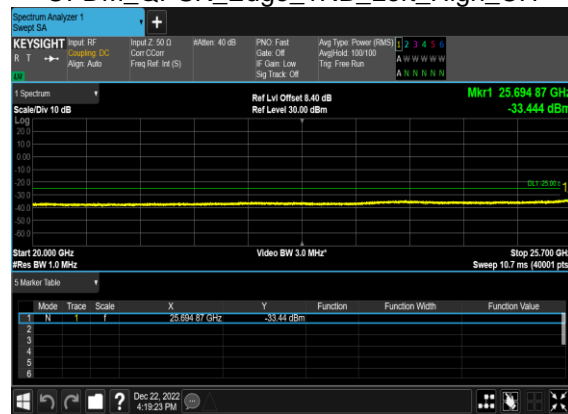

B2_N7(40M)_DFT-s-OFDM_BPSK_Edge_1RB_Left_Low_CH

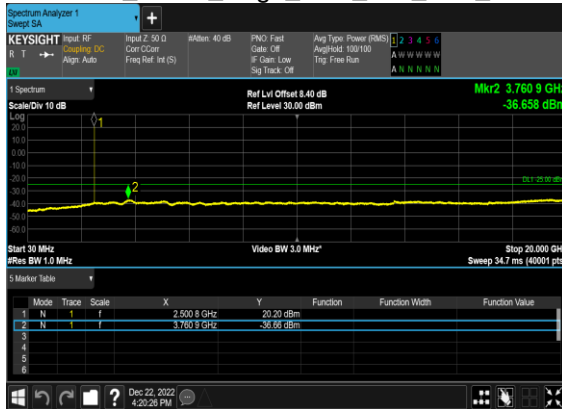

B2_N7(40M)_DFT-s-OFDM_BPSK_Edge_1RB_Left_Low_CH

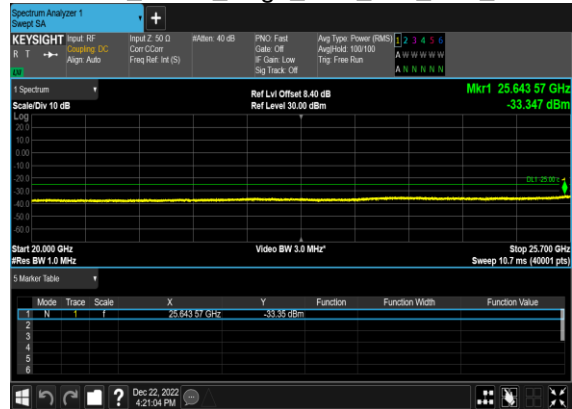

B2_N7(40M)_DFT-s-OFDM_QPSK_Edge_1RB_Left_Low_CH

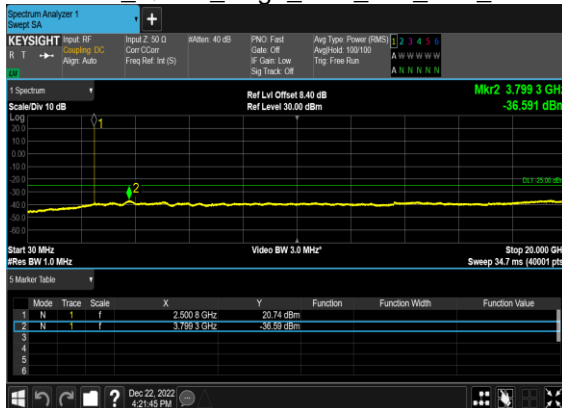

B2_N7(40M)_DFT-s-OFDM_QPSK_Edge_1RB_Left_Low_CH



B2_N7(40M)_DFT-s-OFDM_BPSK_Edge_1RB_Left_Mid_CH



B2_N7(40M)_DFT-s-OFDM_BPSK_Edge_1RB_Left_Mid_CH

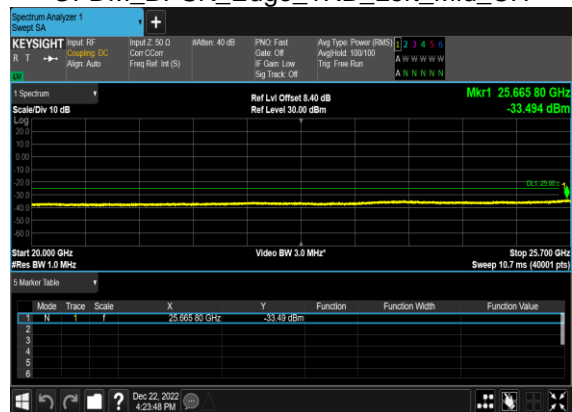

B2_N7(40M)_DFT-s-OFDM_QPSK_Edge_1RB_Left_Mid_CH



B2_N7(40M)_DFT-s-OFDM_QPSK_Edge_1RB_Left_Mid_CH

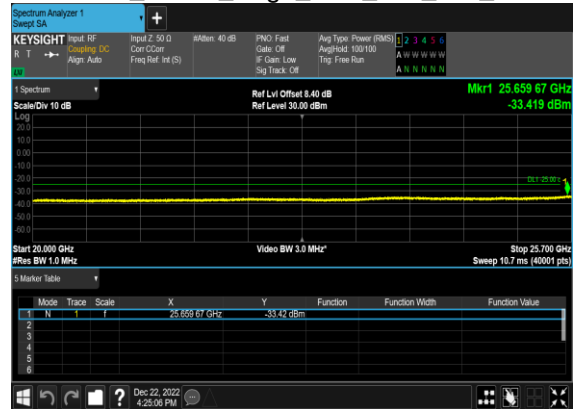

B2_N7(40M)_DFT-s-OFDM_BPSK_Edge_1RB_Left_High_CH



B2_N7(40M)_DFT-s-OFDM_BPSK_Edge_1RB_Left_High_CH

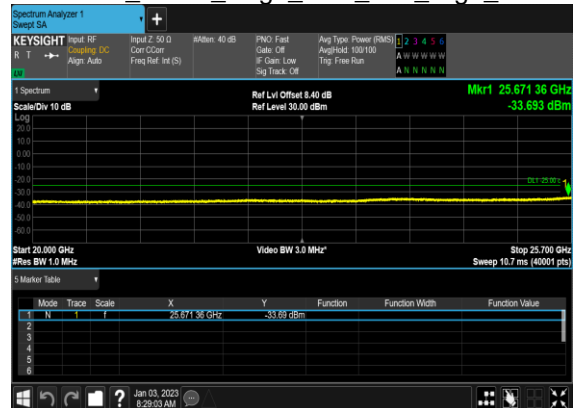

B2_N7(40M)_DFT-s-OFDM_QPSK_Edge_1RB_Left_High_CH



B2_N7(40M)_DFT-s-OFDM_QPSK_Edge_1RB_Left_High_CH



Conducted Band Edge

NR Band	SCS (kHz)	Bandwidth (MHz)	Arfcn	Freq (MHz)	Modulation	RB	Result	Verdict
7	15	5	500500	2502.5	DFT-s-OFDM BPSK	1@0	see graph	PASS
7	15	5	500500	2502.5	DFT-s-OFDM QPSK	1@0	see graph	PASS
7	15	5	500500	2502.5	DFT-s-OFDM BPSK	25@0	see graph	PASS
7	15	5	500500	2502.5	DFT-s-OFDM QPSK	25@0	see graph	PASS
7	15	5	513500	2567.5	DFT-s-OFDM BPSK	1@24	see graph	PASS
7	15	5	513500	2567.5	DFT-s-OFDM QPSK	1@24	see graph	PASS
7	15	5	513500	2567.5	DFT-s-OFDM BPSK	25@0	see graph	PASS
7	15	5	513500	2567.5	DFT-s-OFDM QPSK	25@0	see graph	PASS
7	15	20	502000	2510.0	DFT-s-OFDM BPSK	1@0	see graph	PASS
7	15	20	502000	2510.0	DFT-s-OFDM QPSK	1@0	see graph	PASS
7	15	20	502000	2510.0	DFT-s-OFDM BPSK	100@0	see graph	PASS
7	15	20	502000	2510.0	DFT-s-OFDM QPSK	100@0	see graph	PASS
7	15	20	512000	2560.0	DFT-s-OFDM BPSK	1@105	see graph	PASS
7	15	20	512000	2560.0	DFT-s-OFDM QPSK	1@105	see graph	PASS
7	15	20	512000	2560.0	DFT-s-OFDM BPSK	100@0	see graph	PASS
7	15	20	512000	2560.0	DFT-s-OFDM QPSK	100@0	see graph	PASS
7	15	40	504000	2520.0	DFT-s-OFDM BPSK	1@0	see graph	PASS
7	15	40	504000	2520.0	DFT-s-OFDM QPSK	1@0	see graph	PASS
7	15	40	504000	2520.0	DFT-s-OFDM BPSK	216@0	see graph	PASS
7	15	40	504000	2520.0	DFT-s-OFDM QPSK	216@0	see graph	PASS
7	15	40	510000	2550.0	DFT-s-OFDM BPSK	1@215	see graph	PASS
7	15	40	510000	2550.0	DFT-s-OFDM QPSK	1@215	see graph	PASS
7	15	40	510000	2550.0	DFT-s-OFDM BPSK	216@0	see graph	PASS
7	15	40	510000	2550.0	DFT-s-OFDM QPSK	216@0	see graph	PASS