

### 46\_LTE Band 26\_15M\_QPSK\_1RB\_0Offset\_Back\_5mm\_Ch26865

Communication System: UID 0, LTE-FDD (0); Frequency: 831.5 MHz; Duty Cycle: 1:1  
Medium: HSL\_835 Medium parameters used:  $f = 831.5$  MHz;  $\sigma = 0.932$  S/m;  $\epsilon_r = 41.179$ ;  $\rho = 1000$  kg/m<sup>3</sup>

Ambient Temperature : 23.3 °C; Liquid Temperature : 22.8 °C

#### DASY5 Configuration:

- Probe: EX3DV4 - SN3826; ConvF(9.31, 9.31, 9.31); Calibrated: 2022/8/8
- Sensor-Surface: 1.4mm (Mechanical Surface Detection)
- Electronics: DAE4 Sn1303; Calibrated: 2022/11/24
- Phantom: SAM Twin Phantom; Type: SAM Twin; Serial: TP-1842
- Measurement SW: DASY52, Version 52.10 (4); SEMCAD X Version 14.6.14 (7501)

**Area Scan (71x91x1):** Interpolated grid: dx=1.500 mm, dy=1.500 mm

Maximum value of SAR (interpolated) = 0.925 W/kg

**Zoom Scan (5x5x7)/Cube 0:** Measurement grid: dx=8mm, dy=8mm, dz=5mm

Reference Value = 2.728 V/m; Power Drift = -0.07 dB

Peak SAR (extrapolated) = 1.51 W/kg

**SAR(1 g) = 0.759 W/kg; SAR(10 g) = 0.419 W/kg**

Maximum value of SAR (measured) = 0.949 W/kg

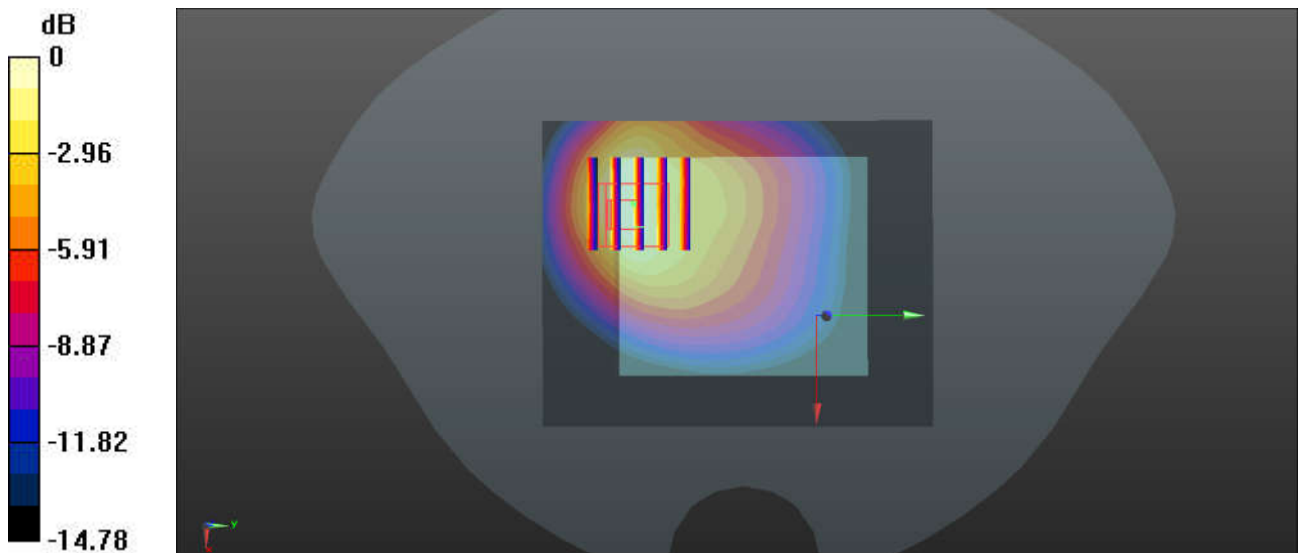

0 dB = 0.949 W/kg = -0.23 dBW/kg

### 47\_FR1 n26\_20M\_QPSK\_1RB\_1Offset\_Back\_5mm\_Ch166300

Communication System: UID 0, 5G NR (0); Frequency: 831.5 MHz; Duty Cycle: 1:1

Medium: HSL\_835 Medium parameters used:  $f = 831.5$  MHz;  $\sigma = 0.909$  S/m;  $\epsilon_r = 41.973$ ;  $\rho = 1000$  kg/m<sup>3</sup>

Ambient Temperature : 23.1 °C; Liquid Temperature : 22.5 °C

#### DASY5 Configuration:

- Probe: EX3DV4 - SN3826; ConvF(9.31, 9.31, 9.31); Calibrated: 2022/8/8
- Sensor-Surface: 1.4mm (Mechanical Surface Detection)
- Electronics: DAE4 Sn1303; Calibrated: 2022/11/24
- Phantom: SAM Twin Phantom; Type: SAM Twin; Serial: TP-1842
- Measurement SW: DASY52, Version 52.10 (4); SEMCAD X Version 14.6.14 (7501)

**Area Scan (71x141x1):** Interpolated grid: dx=1.500 mm, dy=1.500 mm

Maximum value of SAR (interpolated) = 1.14 W/kg

**Zoom Scan (5x5x7)/Cube 0:** Measurement grid: dx=8mm, dy=8mm, dz=5mm

Reference Value = 10.25 V/m; Power Drift = -0.07 dB

Peak SAR (extrapolated) = 1.81 W/kg

**SAR(1 g) = 0.803 W/kg; SAR(10 g) = 0.430 W/kg**

Maximum value of SAR (measured) = 1.42 W/kg

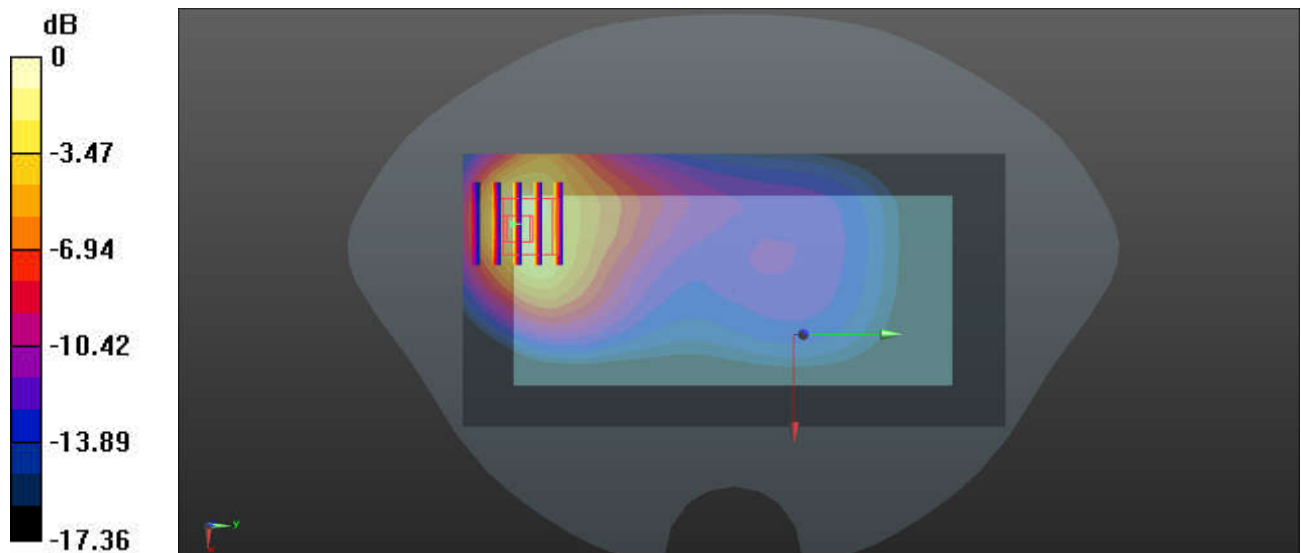

0 dB = 1.42 W/kg = 1.52 dBW/kg

### 48\_FR1 n5\_20M\_QPSK\_1RB\_1Offset\_Top Side\_5mm\_Ch167300

Communication System: UID 0, 5G NR (0); Frequency: 836.5 MHz; Duty Cycle: 1:1  
Medium: HSL\_835 Medium parameters used:  $f = 836.5$  MHz;  $\sigma = 0.913$  S/m;  $\epsilon_r = 41.948$ ;  $\rho = 1000$  kg/m<sup>3</sup>

Ambient Temperature : 23.1 °C; Liquid Temperature : 22.5 °C

#### DASY5 Configuration:

- Probe: EX3DV4 - SN3826; ConvF(9.31, 9.31, 9.31); Calibrated: 2022/8/8
- Sensor-Surface: 1.4mm (Mechanical Surface Detection)
- Electronics: DAE4 Sn1303; Calibrated: 2022/11/24
- Phantom: SAM Twin Phantom; Type: SAM Twin; Serial: TP-1842
- Measurement SW: DASY52, Version 52.10 (4); SEMCAD X Version 14.6.14 (7501)

**Area Scan (41x81x1):** Interpolated grid: dx=1.500 mm, dy=1.500 mm

Maximum value of SAR (interpolated) = 0.791 W/kg

**Zoom Scan (5x6x7)/Cube 0:** Measurement grid: dx=8mm, dy=8mm, dz=5mm

Reference Value = 8.186 V/m; Power Drift = -0.15 dB

Peak SAR (extrapolated) = 1.10 W/kg

**SAR(1 g) = 0.373 W/kg; SAR(10 g) = 0.181 W/kg**

Maximum value of SAR (measured) = 0.779 W/kg

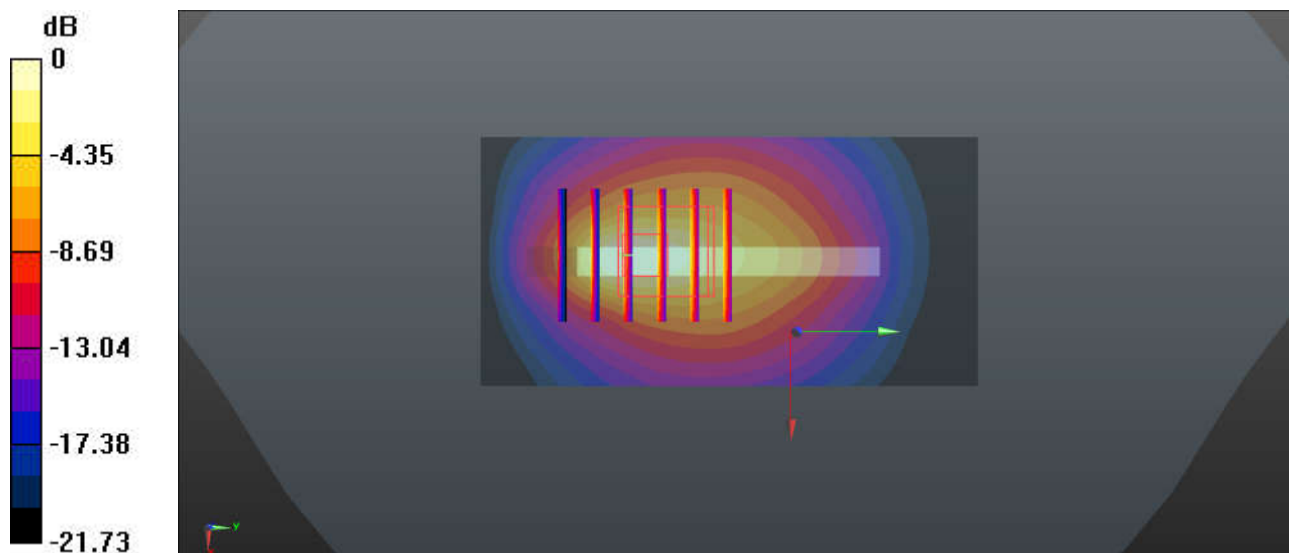

0 dB = 0.779 W/kg = -1.08 dBW/kg

### 49\_WCDMA IV\_RMC 12.2Kbps\_Bottom Side\_5mm\_Ch1312

Communication System: UID 0, WCDMA (0); Frequency: 1712.4 MHz; Duty Cycle: 1:1  
Medium: HSL\_1750 Medium parameters used:  $f = 1712.4$  MHz;  $\sigma = 1.292$  S/m;  $\epsilon_r = 40.444$ ;  $\rho = 1000$  kg/m<sup>3</sup>  
Ambient Temperature : 23.1 °C; Liquid Temperature : 22.6 °C

#### DASY5 Configuration:

- Probe: EX3DV4 - SN3826; ConvF(8.56, 8.56, 8.56); Calibrated: 2022/8/8
- Sensor-Surface: 1.4mm (Mechanical Surface Detection)
- Electronics: DAE4 Sn1303; Calibrated: 2022/11/24
- Phantom: SAM Twin Phantom; Type: SAM Twin; Serial: TP-1842
- Measurement SW: DASY52, Version 52.10 (4); SEMCAD X Version 14.6.14 (7501)

**Area Scan (41x81x1):** Interpolated grid: dx=1.500 mm, dy=1.500 mm  
Maximum value of SAR (interpolated) = 1.43 W/kg

**Zoom Scan (5x5x7)/Cube 0:** Measurement grid: dx=8mm, dy=8mm, dz=5mm  
Reference Value = 17.60 V/m; Power Drift = 0.03 dB  
Peak SAR (extrapolated) = 1.86 W/kg  
**SAR(1 g) = 0.901 W/kg; SAR(10 g) = 0.428 W/kg**  
Maximum value of SAR (measured) = 1.48 W/kg

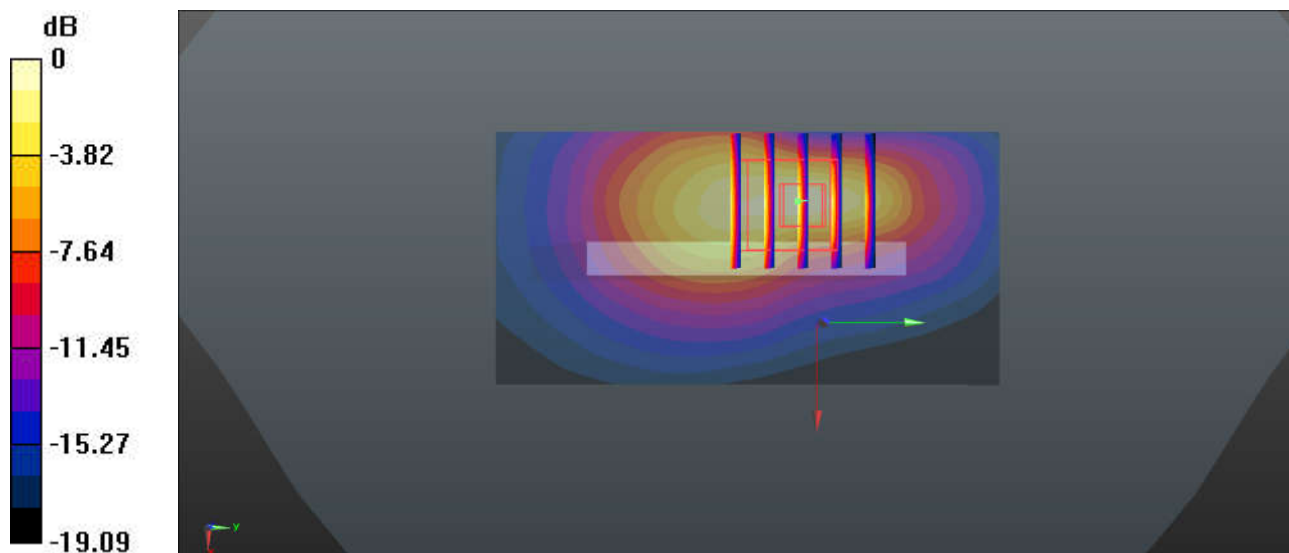

0 dB = 1.48 W/kg = 1.70 dBW/kg

### 50\_LTE Band 66\_20M\_QPSK\_1RB\_0Offset\_Bottom Side\_5mm\_Ch132072

Communication System: UID 0, LTE-FDD (0); Frequency: 1720 MHz; Duty Cycle: 1:1  
Medium: HSL\_1750 Medium parameters used:  $f = 1720$  MHz;  $\sigma = 1.294$  S/m;  $\epsilon_r = 40.387$ ;  $\rho = 1000$  kg/m<sup>3</sup>

Ambient Temperature : 23.1 °C; Liquid Temperature : 22.6 °C

#### DASY5 Configuration:

- Probe: EX3DV4 - SN3826; ConvF(8.56, 8.56, 8.56); Calibrated: 2022/8/8
- Sensor-Surface: 1.4mm (Mechanical Surface Detection)
- Electronics: DAE4 Sn1303; Calibrated: 2022/11/24
- Phantom: SAM Twin Phantom; Type: SAM Twin; Serial: TP-1842
- Measurement SW: DASY52, Version 52.10 (4); SEMCAD X Version 14.6.14 (7501)

**Area Scan (41x81x1):** Interpolated grid: dx=1.500 mm, dy=1.500 mm

Maximum value of SAR (interpolated) = 1.37 W/kg

**Zoom Scan (5x5x7)/Cube 0:** Measurement grid: dx=8mm, dy=8mm, dz=5mm

Reference Value = 8.380 V/m; Power Drift = 0.09 dB

Peak SAR (extrapolated) = 1.94 W/kg

**SAR(1 g) = 0.903 W/kg; SAR(10 g) = 0.375 W/kg**

Maximum value of SAR (measured) = 1.57 W/kg

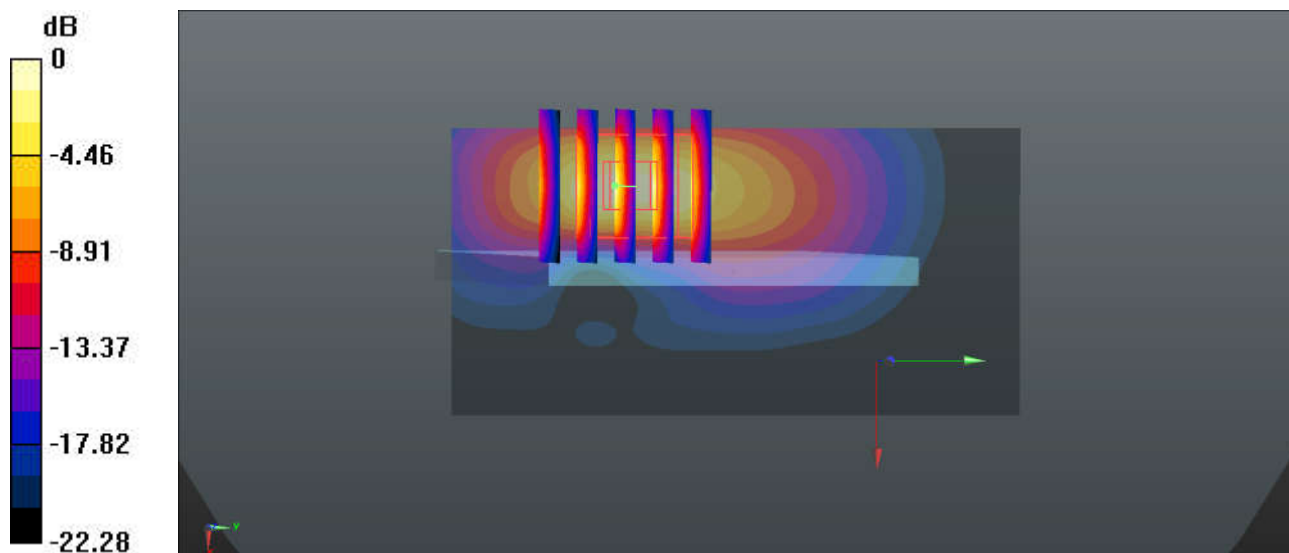

0 dB = 1.57 W/kg = 1.96 dBW/kg

### 51\_FR1 n66\_40M\_QPSK\_108RB\_54Offset\_Back\_5mm\_Ch349000

Communication System: UID 0, 5G NR (0); Frequency: 1745 MHz; Duty Cycle: 1:1  
Medium: HSL\_1750 Medium parameters used:  $f = 1745$  MHz;  $\sigma = 1.311$  S/m;  $\epsilon_r = 40.238$ ;  $\rho = 1000$  kg/m<sup>3</sup>  
Ambient Temperature : 23.1 °C; Liquid Temperature : 22.6 °C

#### DASY5 Configuration:

- Probe: EX3DV4 - SN3826; ConvF(8.56, 8.56, 8.56); Calibrated: 2022/8/8
- Sensor-Surface: 1.4mm (Mechanical Surface Detection)
- Electronics: DAE4 Sn1303; Calibrated: 2022/11/24
- Phantom: SAM Twin Phantom; Type: SAM Twin; Serial: TP-1842
- Measurement SW: DASY52, Version 52.10 (4); SEMCAD X Version 14.6.14 (7501)

**Area Scan (71x141x1):** Interpolated grid: dx=1.500 mm, dy=1.500 mm  
Maximum value of SAR (interpolated) = 1.58 W/kg

**Zoom Scan (5x5x7)/Cube 0:** Measurement grid: dx=8mm, dy=8mm, dz=5mm  
Reference Value = 2.739 V/m; Power Drift = 0.17 dB  
Peak SAR (extrapolated) = 2.16 W/kg  
**SAR(1 g) = 0.981 W/kg; SAR(10 g) = 0.450 W/kg**  
Maximum value of SAR (measured) = 1.82 W/kg

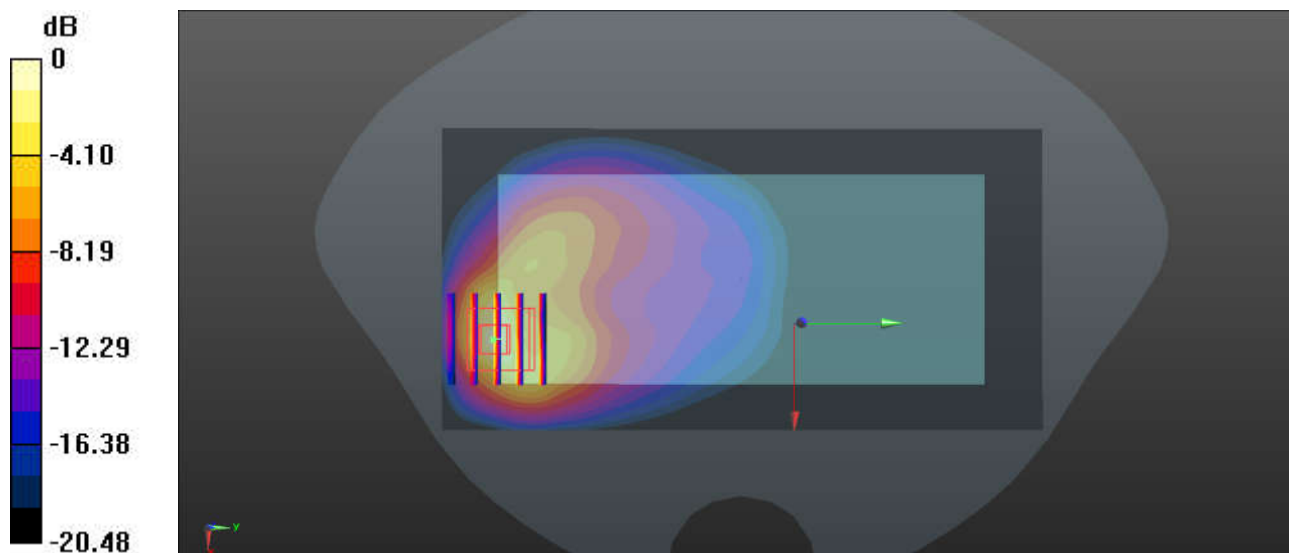

0 dB = 1.82 W/kg = 2.60 dBW/kg

**52\_FR1 n70\_15M\_QPSK\_36RB\_22Offset\_Bottom Side\_5mm\_Ch340500**

Communication System: UID 0, 5G NR (0); Frequency: 1702.5 MHz; Duty Cycle: 1:1  
Medium: HSL\_1750 Medium parameters used:  $f = 1702.5$  MHz;  $\sigma = 1.366$  S/m;  $\epsilon_r = 40.604$ ;  $\rho = 1000$  kg/m<sup>3</sup>  
Ambient Temperature : 23.3 °C; Liquid Temperature : 22.9 °C

**DASY5 Configuration:**

- Probe: EX3DV4 - SN3826; ConvF(8.56, 8.56, 8.56); Calibrated: 2022/8/8
- Sensor-Surface: 1.4mm (Mechanical Surface Detection)
- Electronics: DAE4 Sn1303; Calibrated: 2022/11/24
- Phantom: SAM Twin Phantom; Type: SAM Twin; Serial: TP-1842
- Measurement SW: DASY52, Version 52.10 (4); SEMCAD X Version 14.6.14 (7501)

**Area Scan (41x91x1):** Interpolated grid: dx=1.500 mm, dy=1.500 mm  
Maximum value of SAR (interpolated) = 1.05 W/kg

**Zoom Scan (5x5x7)/Cube 0:** Measurement grid: dx=8mm, dy=8mm, dz=5mm  
Reference Value = 9.087 V/m; Power Drift = 0.01 dB  
Peak SAR (extrapolated) = 1.78 W/kg  
**SAR(1 g) = 0.705 W/kg; SAR(10 g) = 0.318 W/kg**  
Maximum value of SAR (measured) = 0.93 W/kg

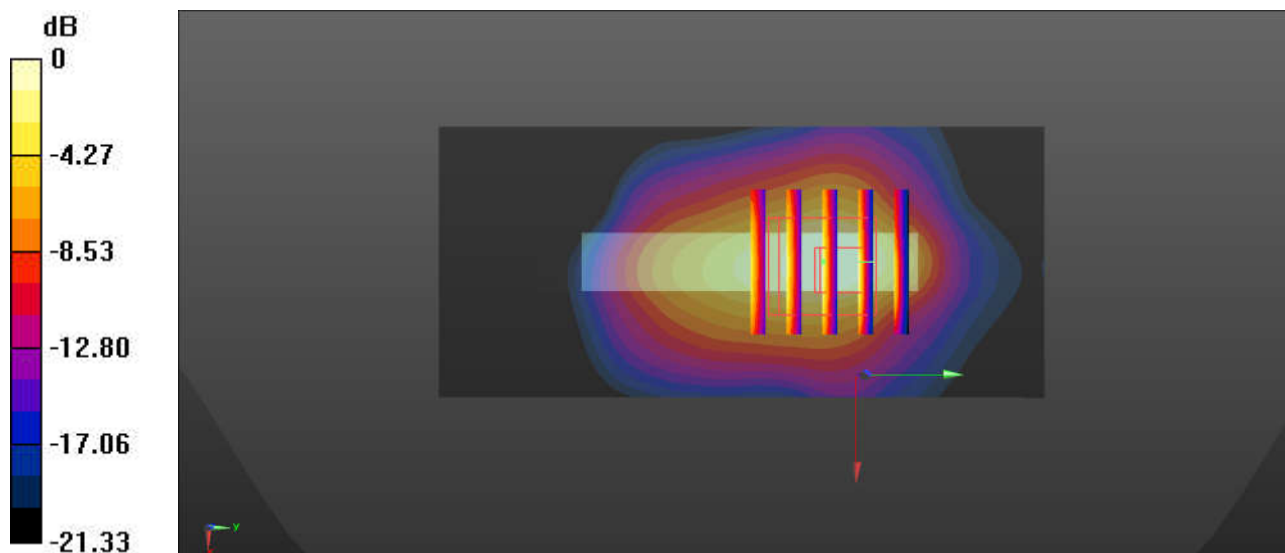

0 dB = 0.93 W/kg = -0.33 dBW/kg

### 53\_GSM1900\_GPRS (3 Tx slots)\_Top Side\_5mm\_Ch661

Communication System: UID 0, PCS (0); Frequency: 1880 MHz; Duty Cycle: 1:2.77  
Medium: HSL\_1900 Medium parameters used:  $f = 1880$  MHz;  $\sigma = 1.406$  S/m;  $\epsilon_r = 40.168$ ;  $\rho = 1000$  kg/m<sup>3</sup>  
Ambient Temperature : 23.2 °C; Liquid Temperature : 22.8 °C

#### DASY5 Configuration:

- Probe: EX3DV4 - SN3826; ConvF(8.24, 8.24, 8.24); Calibrated: 2022/8/8
- Sensor-Surface: 1.4mm (Mechanical Surface Detection)
- Electronics: DAE4 Sn1303; Calibrated: 2022/11/24
- Phantom: SAM Twin Phantom; Type: SAM Twin; Serial: TP-1842
- Measurement SW: DASY52, Version 52.10 (4); SEMCAD X Version 14.6.14 (7501)

**Area Scan (31x81x1):** Interpolated grid: dx=1.500 mm, dy=1.500 mm  
Maximum value of SAR (interpolated) = 1.28 W/kg

**Zoom Scan (5x5x7)/Cube 0:** Measurement grid: dx=8mm, dy=8mm, dz=5mm  
Reference Value = 11.61 V/m; Power Drift = -0.18 dB  
Peak SAR (extrapolated) = 1.43 W/kg  
**SAR(1 g) = 0.734 W/kg; SAR(10 g) = 0.395 W/kg**  
Maximum value of SAR (measured) = 1.18 W/kg

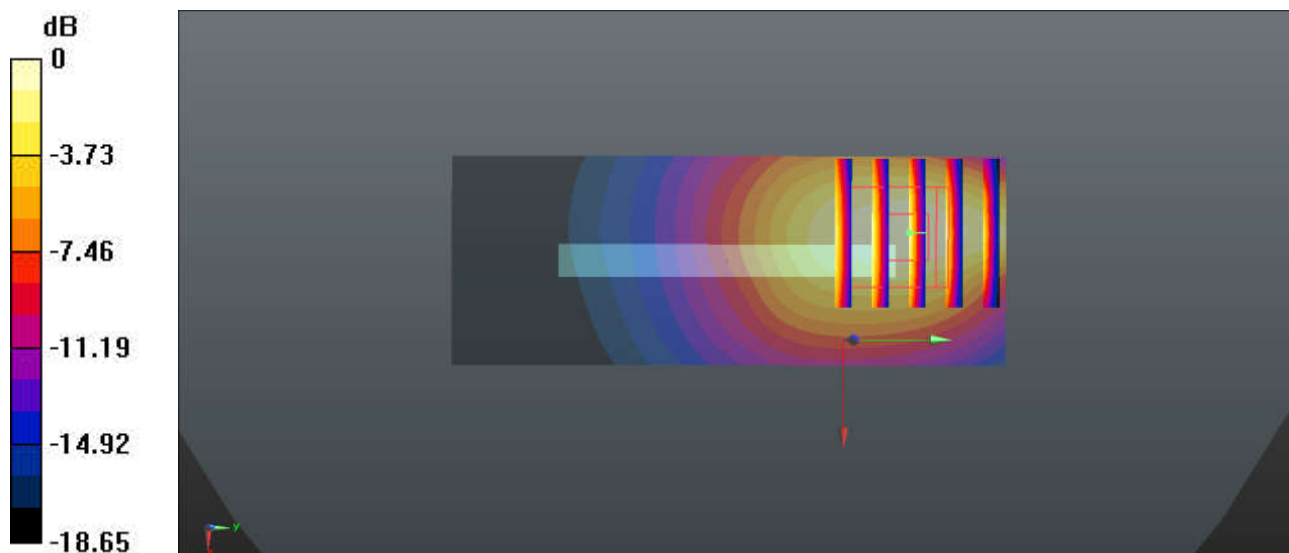

0 dB = 1.18 W/kg = 0.72 dBW/kg



### 54\_WCDMA II\_RMC 12.2Kbps\_Back\_5mm\_Ch9400

Communication System: UID 0, WCDMA (0); Frequency: 1880 MHz; Duty Cycle: 1:1  
Medium: HSL\_1900 Medium parameters used:  $f = 1880$  MHz;  $\sigma = 1.406$  S/m;  $\epsilon_r = 40.168$ ;  $\rho = 1000$  kg/m<sup>3</sup>  
Ambient Temperature : 23.2 °C; Liquid Temperature : 22.8 °C

#### DASY5 Configuration:

- Probe: EX3DV4 - SN3826; ConvF(8.24, 8.24, 8.24); Calibrated: 2022/8/8
- Sensor-Surface: 1.4mm (Mechanical Surface Detection)
- Electronics: DAE4 Sn1303; Calibrated: 2022/11/24
- Phantom: SAM Twin Phantom; Type: SAM Twin; Serial: TP-1842
- Measurement SW: DASY52, Version 52.10 (4); SEMCAD X Version 14.6.14 (7501)

**Area Scan (71x141x1):** Interpolated grid: dx=1.500 mm, dy=1.500 mm  
Maximum value of SAR (interpolated) = 1.35 W/kg

**Zoom Scan (5x5x7)/Cube 0:** Measurement grid: dx=8mm, dy=8mm, dz=5mm  
Reference Value = 8.254 V/m; Power Drift = -0.08 dB  
Peak SAR (extrapolated) = 2.00 W/kg  
**SAR(1 g) = 0.892 W/kg; SAR(10 g) = 0.386 W/kg**  
Maximum value of SAR (measured) = 1.53 W/kg

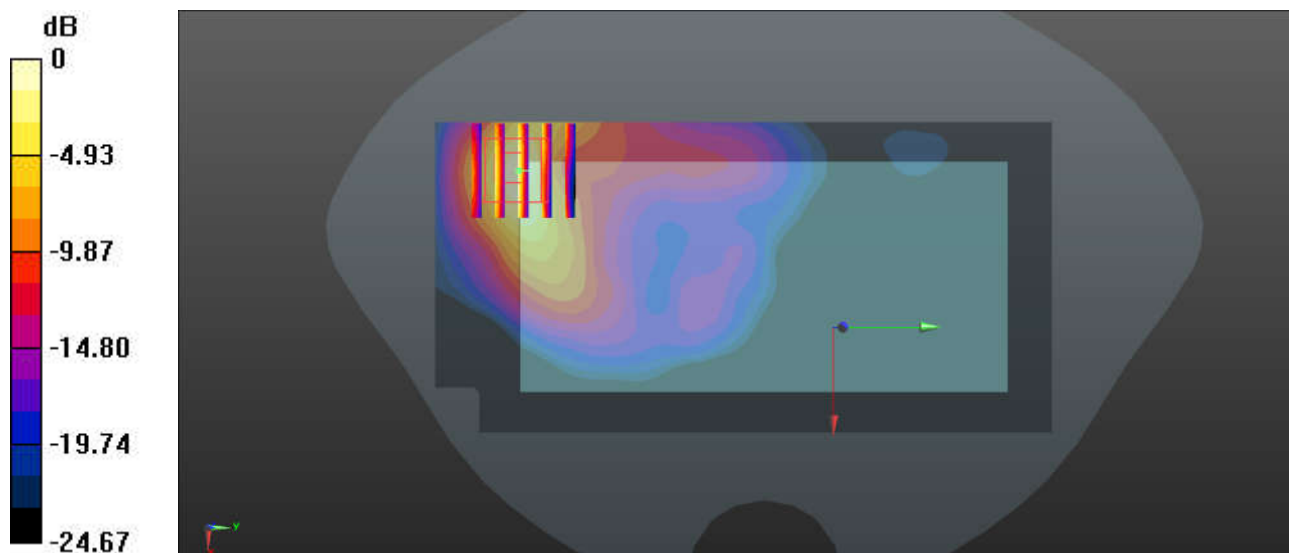

0 dB = 1.53 W/kg = 1.85 dBW/kg

### 55\_LTE Band 25\_20M\_QPSK\_1RB\_0Offset\_Bottom Side\_5mm\_Ch26340

Communication System: UID 0, LTE-FDD (0); Frequency: 1880 MHz; Duty Cycle: 1:1  
Medium: HSL\_1900 Medium parameters used:  $f = 1880$  MHz;  $\sigma = 1.406$  S/m;  $\epsilon_r = 40.168$ ;  $\rho = 1000$  kg/m<sup>3</sup>  
Ambient Temperature : 23.2 °C; Liquid Temperature : 22.8 °C

#### DASY5 Configuration:

- Probe: EX3DV4 - SN3826; ConvF(8.24, 8.24, 8.24); Calibrated: 2022/8/8
- Sensor-Surface: 1.4mm (Mechanical Surface Detection)
- Electronics: DAE4 Sn1303; Calibrated: 2022/11/24
- Phantom: SAM Twin Phantom; Type: SAM Twin; Serial: TP-1842
- Measurement SW: DASY52, Version 52.10 (4); SEMCAD X Version 14.6.14 (7501)

**Area Scan (41x81x1):** Interpolated grid: dx=1.500 mm, dy=1.500 mm  
Maximum value of SAR (interpolated) = 0.81 W/kg

**Zoom Scan (5x5x7)/Cube 0:** Measurement grid: dx=8mm, dy=8mm, dz=5mm  
Reference Value = 16.79 V/m; Power Drift = 0.15 dB  
Peak SAR (extrapolated) = 2.35 W/kg  
**SAR(1 g) = 0.960 W/kg; SAR(10 g) = 0.375 W/kg**  
Maximum value of SAR (measured) = 1.49 W/kg

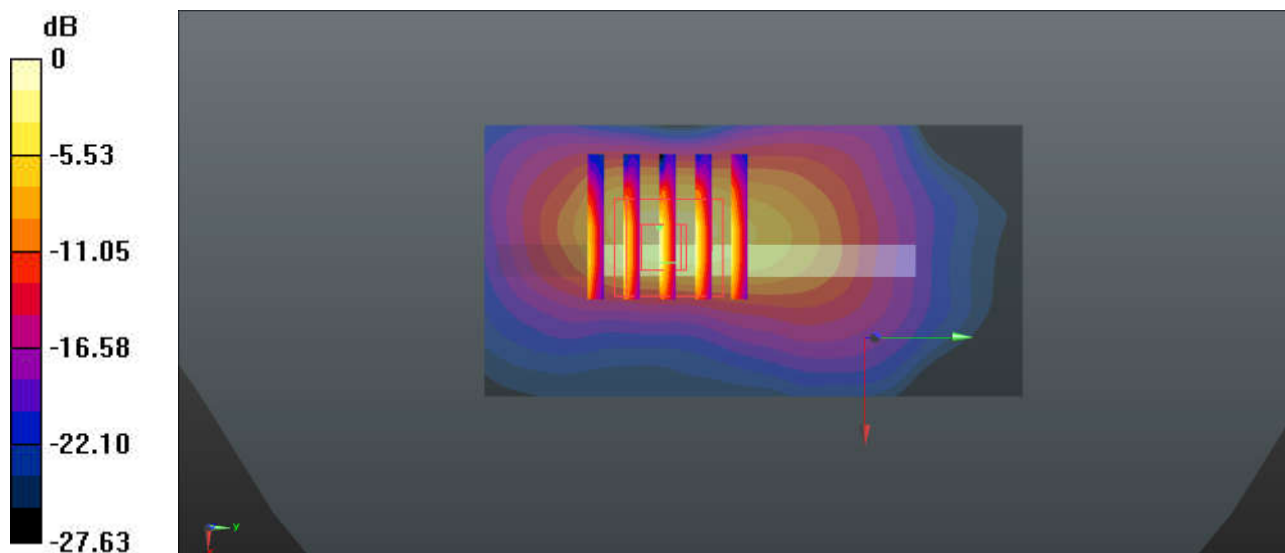

0 dB = 1.49 W/kg = 1.74 dBW/kg

**56\_FR1 n25\_40M\_QPSK\_108RB\_54Offset\_Back\_5mm\_Ch376500**

Communication System: UID 0, 5G NR (0); Frequency: 1882.5 MHz; Duty Cycle: 1:1  
Medium: HSL\_1900 Medium parameters used:  $f = 1882.5$  MHz;  $\sigma = 1.407$  S/m;  $\epsilon_r = 40.181$ ;  $\rho = 1000$  kg/m<sup>3</sup>  
Ambient Temperature : 23.2 °C; Liquid Temperature : 22.8 °C

**DASY5 Configuration:**

- Probe: EX3DV4 - SN3826; ConvF(8.24, 8.24, 8.24); Calibrated: 2022/8/8
- Sensor-Surface: 1.4mm (Mechanical Surface Detection)
- Electronics: DAE4 Sn1303; Calibrated: 2022/11/24
- Phantom: SAM Twin Phantom; Type: SAM Twin; Serial: TP-1842
- Measurement SW: DASY52, Version 52.10 (4); SEMCAD X Version 14.6.14 (7501)

**Area Scan (71x141x1):** Interpolated grid: dx=1.500 mm, dy=1.500 mm  
Maximum value of SAR (interpolated) = 1.64 W/kg

**Zoom Scan (5x6x7)/Cube 0:** Measurement grid: dx=8mm, dy=8mm, dz=5mm  
Reference Value = 1.382 V/m; Power Drift = -0.08 dB  
Peak SAR (extrapolated) = 1.85 W/kg  
**SAR(1 g) = 0.874 W/kg; SAR(10 g) = 0.399 W/kg**  
Maximum value of SAR (measured) = 1.45 W/kg

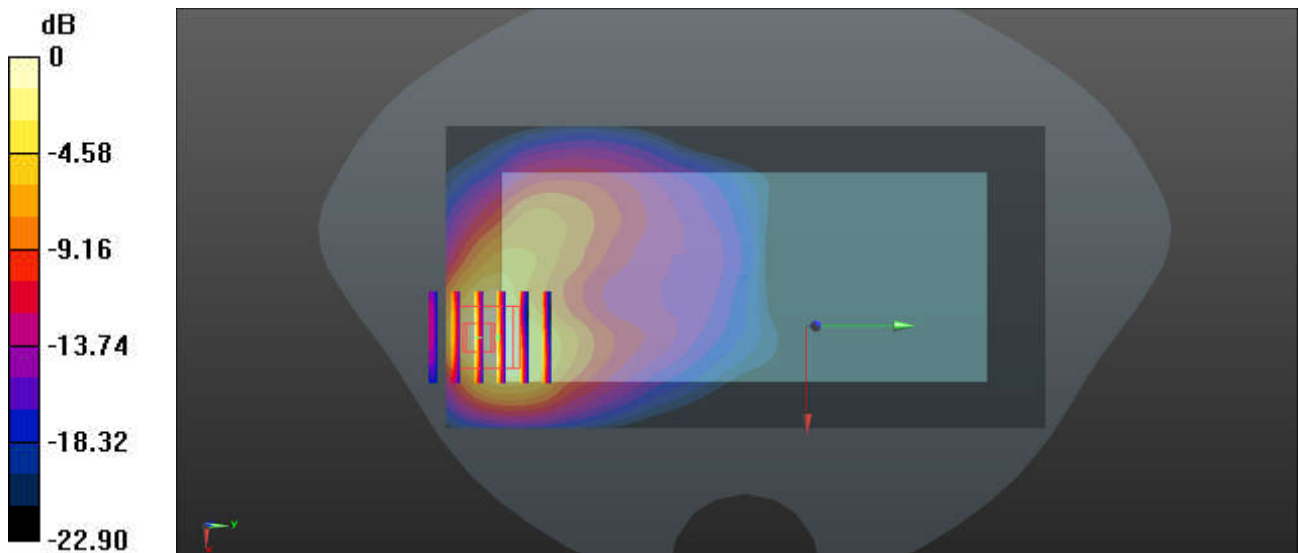

0 dB = 1.45 W/kg = 1.61 dBW/kg

**57\_LTE Band 30\_10M\_QPSK\_50RB\_0Offset\_Bottom Side\_5mm\_Ch27710**

Communication System: UID 0, LTE-FDD (0); Frequency: 2310 MHz; Duty Cycle: 1:1  
 Medium: HSL\_2300 Medium parameters used:  $f = 2310$  MHz;  $\sigma = 1.651$  S/m;  $\epsilon = 39.636$ ;  $\rho = 1000$

kg/m<sup>3</sup>

Ambient Temperature : 23.3 °C; Liquid Temperature : 22.9 °C

**DASY5 Configuration:**

- Probe: EX3DV4 - SN3826; ConvF(7.79, 7.79, 7.79); Calibrated: 2022/8/8
- Sensor-Surface: 1.4mm (Mechanical Surface Detection)
- Electronics: DAE4 Sn1303; Calibrated: 2022/11/24
- Phantom: SAM Twin Phantom; Type: SAM Twin; Serial: TP-1842
- Measurement SW: DASY52, Version 52.10 (4); SEMCAD X Version 14.6.14 (7501)

**Area Scan (51x91x1):** Interpolated grid: dx=1.200 mm, dy=1.200 mm

Maximum value of SAR (interpolated) = 1.73 W/kg

**Zoom Scan (7x7x7)/Cube 0:** Measurement grid: dx=5mm, dy=5mm, dz=5mm

Reference Value = 9.771 V/m; Power Drift = 0.03 dB

Peak SAR (extrapolated) = 2.35 W/kg

**SAR(1 g) = 0.989 W/kg; SAR(10 g) = 0.382 W/kg**

Maximum value of SAR (measured) = 1.82 W/kg

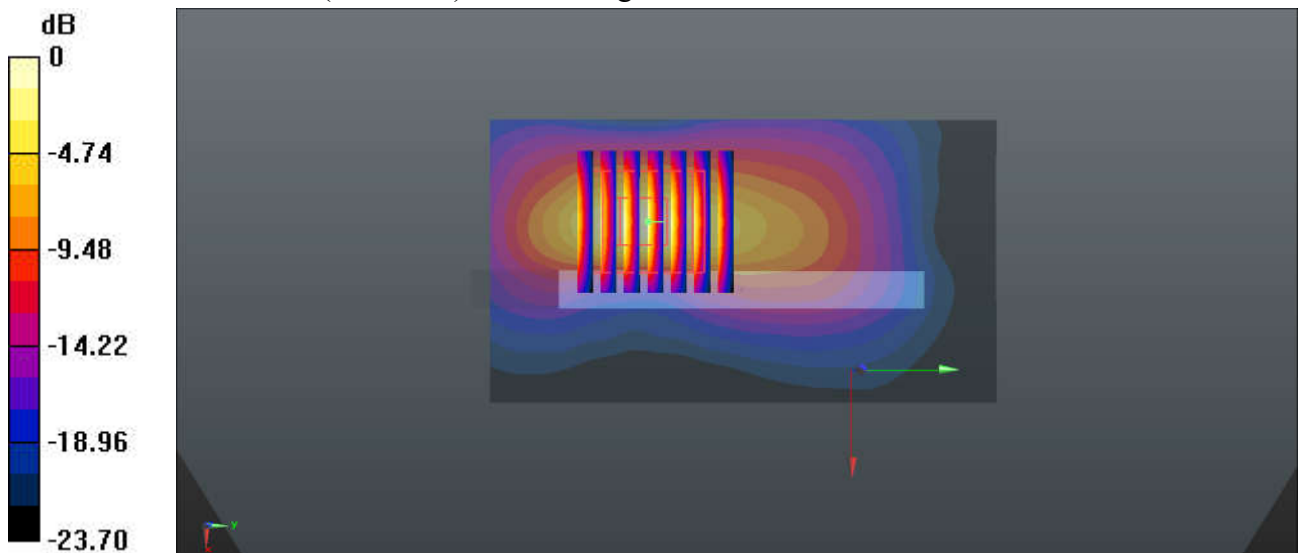

0 dB = 1.82 W/kg = 2.60 dBW/kg

**58\_FR1 n30\_10M\_QPSK\_25RB\_14Offset\_Bottom Side\_5mm\_Ch462000**

Communication System: UID 0, 5G NR (0); Frequency: 2310 MHz; Duty Cycle: 1:1  
Medium: HSL\_2300 Medium parameters used:  $f = 2310$  MHz;  $\sigma = 1.651$  S/m;  $\epsilon_r = 39.636$ ;  $\rho = 1000$  kg/m<sup>3</sup>  
Ambient Temperature : 23.3 °C; Liquid Temperature : 22.9 °C

**DASY5 Configuration:**

- Probe: EX3DV4 - SN3826; ConvF(7.79, 7.79, 7.79); Calibrated: 2022/8/8
- Sensor-Surface: 1.4mm (Mechanical Surface Detection)
- Electronics: DAE4 Sn1303; Calibrated: 2022/11/24
- Phantom: SAM Twin Phantom; Type: SAM Twin; Serial: TP-1842
- Measurement SW: DASY52, Version 52.10 (4); SEMCAD X Version 14.6.14 (7501)

**Area Scan (51x101x1):** Interpolated grid: dx=1.200 mm, dy=1.200 mm  
Maximum value of SAR (interpolated) = 1.87 W/kg

**Zoom Scan (7x7x7)/Cube 0:** Measurement grid: dx=5mm, dy=5mm, dz=5mm  
Reference Value = 20.80 V/m; Power Drift = -0.01 dB  
Peak SAR (extrapolated) = 2.44 W/kg  
**SAR(1 g) = 1 W/kg; SAR(10 g) = 0.387 W/kg**  
Maximum value of SAR (measured) = 1.90 W/kg

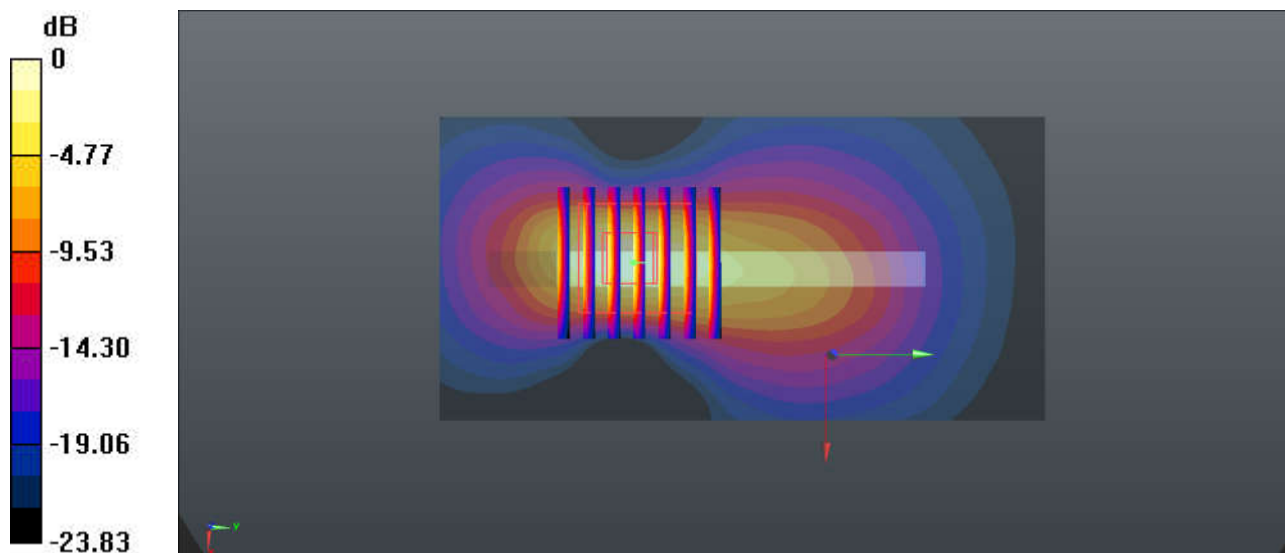

0 dB = 1.90 W/kg = 2.79 dBW/kg

### 59\_LTE Band 7\_20M\_QPSK\_1RB\_0Offset\_Bottom Side\_5mm\_Ch21100

Communication System: UID 0, LTE-FDD (0); Frequency: 2535 MHz; Duty Cycle: 1:1  
Medium: HSL\_2600 Medium parameters used:  $f = 2535$  MHz;  $\sigma = 1.954$  S/m;  $\epsilon_r = 40.37$ ;  $\rho = 1000$  kg/m<sup>3</sup>

Ambient Temperature : 23.2 °C; Liquid Temperature : 22.6 °C

#### DASY5 Configuration:

- Probe: EX3DV4 - SN3826; ConvF(7.35, 7.35, 7.35); Calibrated: 2022/8/8
- Sensor-Surface: 1.4mm (Mechanical Surface Detection)
- Electronics: DAE4 Sn1303; Calibrated: 2022/11/24
- Phantom: SAM Twin Phantom; Type: SAM Twin; Serial: TP-1842
- Measurement SW: DASY52, Version 52.10 (4); SEMCAD X Version 14.6.14 (7501)

**Area Scan (51x101x1):** Interpolated grid: dx=1.200 mm, dy=1.200 mm  
Maximum value of SAR (interpolated) = 1.71 W/kg

**Zoom Scan (7x7x7)/Cube 0:** Measurement grid: dx=5mm, dy=5mm, dz=5mm  
Reference Value = 8.545 V/m; Power Drift = 0.05 dB  
Peak SAR (extrapolated) = 2.57 W/kg  
**SAR(1 g) = 0.989 W/kg; SAR(10 g) = 0.346 W/kg**  
Maximum value of SAR (measured) = 1.90 W/kg

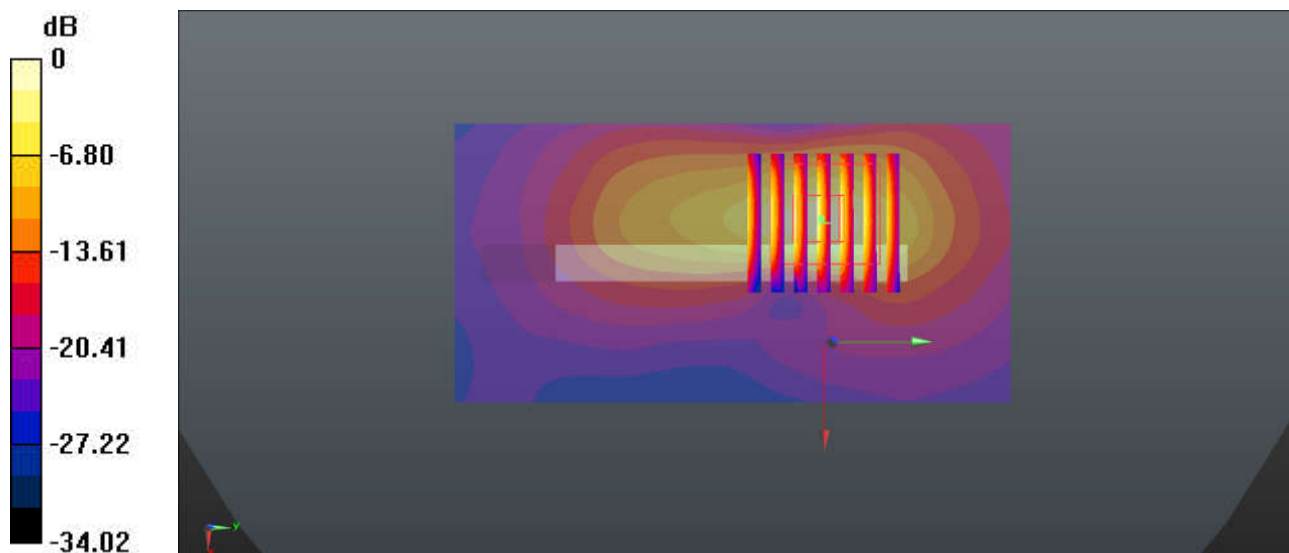

0 dB = 1.90 W/kg = 2.79 dBW/kg

### 60\_LTE Band 41\_20M\_QPSK\_1RB\_0Offset\_Bottom Side\_5mm\_Ch41490

Communication System: UID 0, LTE-TDD (0); Frequency: 2680 MHz; Duty Cycle: 1:1.59  
Medium: HSL\_2600 Medium parameters used:  $f = 2680$  MHz;  $\sigma = 2.105$  S/m;  $\epsilon_r = 40.081$ ;  $\rho = 1000$  kg/m<sup>3</sup>

Ambient Temperature : 23.2 °C; Liquid Temperature : 22.6 °C

#### DASY5 Configuration:

- Probe: EX3DV4 - SN3826; ConvF(7.35, 7.35, 7.35); Calibrated: 2022/8/8
- Sensor-Surface: 1.4mm (Mechanical Surface Detection)
- Electronics: DAE4 Sn1303; Calibrated: 2022/11/24
- Phantom: SAM Twin Phantom; Type: SAM Twin; Serial: TP-1842
- Measurement SW: DASY52, Version 52.10 (4); SEMCAD X Version 14.6.14 (7501)

**Area Scan (51x101x1):** Interpolated grid: dx=1.200 mm, dy=1.200 mm  
Maximum value of SAR (interpolated) = 1.98 W/kg

**Zoom Scan (7x7x7)/Cube 0:** Measurement grid: dx=5mm, dy=5mm, dz=5mm  
Reference Value = 8.607 V/m; Power Drift = 0.18 dB  
Peak SAR (extrapolated) = 2.92 W/kg  
**SAR(1 g) = 0.990 W/kg; SAR(10 g) = 0.365 W/kg**  
Maximum value of SAR (measured) = 2.15 W/kg

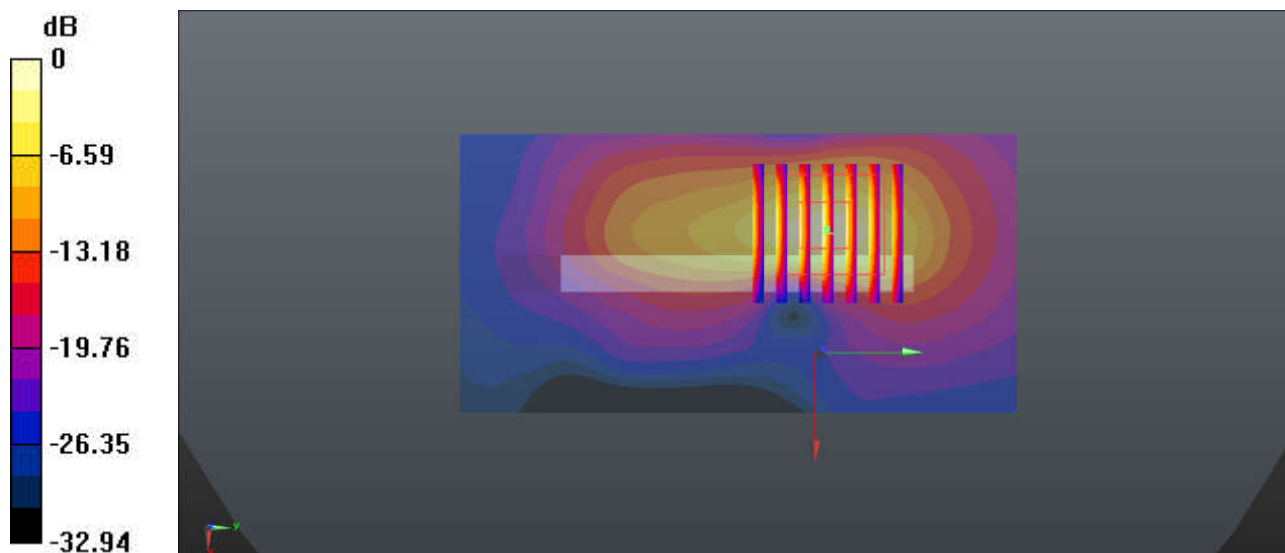

0 dB = 2.15 W/kg = 3.32 dBW/kg

### 61\_FR1 n7\_40M\_QPSK\_108RB\_54Offset\_Bottom Side\_5mm\_Ch507000

Communication System: UID 0, 5G NR (0); Frequency: 2535 MHz; Duty Cycle: 1:1  
Medium: HSL\_2600 Medium parameters used:  $f = 2535$  MHz;  $\sigma = 1.954$  S/m;  $\epsilon_r = 40.37$ ;  $\rho = 1000$  kg/m<sup>3</sup>  
Ambient Temperature : 23.2 °C; Liquid Temperature : 22.6 °C

#### DASY5 Configuration:

- Probe: EX3DV4 - SN3826; ConvF(7.35, 7.35, 7.35); Calibrated: 2022/8/8
- Sensor-Surface: 1.4mm (Mechanical Surface Detection)
- Electronics: DAE4 Sn1303; Calibrated: 2022/11/24
- Phantom: SAM Twin Phantom; Type: SAM Twin; Serial: TP-1842
- Measurement SW: DASY52, Version 52.10 (4); SEMCAD X Version 14.6.14 (7501)

**Area Scan (51x101x1):** Interpolated grid: dx=1.200 mm, dy=1.200 mm  
Maximum value of SAR (interpolated) = 1.52 W/kg

**Zoom Scan (7x7x7)/Cube 0:** Measurement grid: dx=5mm, dy=5mm, dz=5mm  
Reference Value = 4.571 V/m; Power Drift = 0.03 dB  
Peak SAR (extrapolated) = 2.44 W/kg  
**SAR(1 g) = 0.933 W/kg; SAR(10 g) = 0.324 W/kg**  
Maximum value of SAR (measured) = 1.81 W/kg

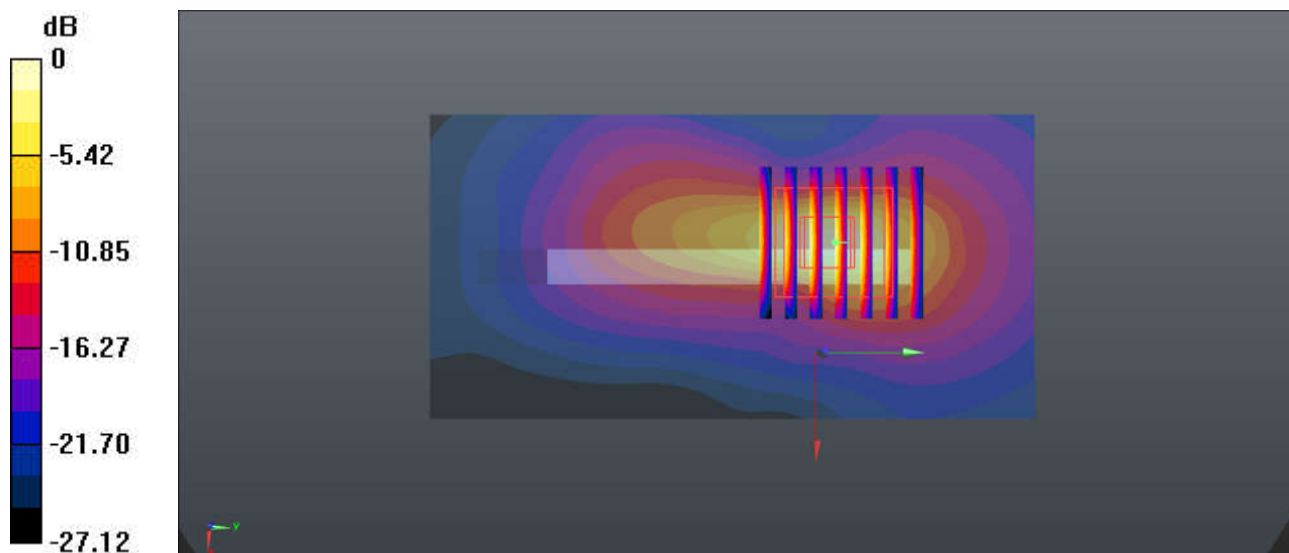

0 dB = 1.81 W/kg = 2.58 dBW/kg



### 62\_FR1 n41\_100M\_QPSK\_1RB\_1Offset\_Bottom Side\_5mm\_Ch518598

Communication System: UID 0, 5G NR (0); Frequency: 2592.99 MHz; Duty Cycle: 1:1  
Medium: HSL\_2600 Medium parameters used:  $f = 2592.99$  MHz;  $\sigma = 2.032$  S/m;  $\epsilon_r = 40.339$ ;  $\rho = 1000$  kg/m<sup>3</sup>  
Ambient Temperature : 23.2 °C; Liquid Temperature : 22.6 °C

#### DASY5 Configuration:

- Probe: EX3DV4 - SN3826; ConvF(7.35, 7.35, 7.35); Calibrated: 2022/8/8
- Sensor-Surface: 1.4mm (Mechanical Surface Detection)
- Electronics: DAE4 Sn1303; Calibrated: 2022/11/24
- Phantom: SAM Twin Phantom; Type: SAM Twin; Serial: TP-1842
- Measurement SW: DASY52, Version 52.10 (4); SEMCAD X Version 14.6.14 (7501)

**Area Scan (51x101x1):** Interpolated grid: dx=1.200 mm, dy=1.200 mm  
Maximum value of SAR (interpolated) = 1.45 W/kg

**Zoom Scan (7x7x7)/Cube 0:** Measurement grid: dx=5mm, dy=5mm, dz=5mm  
Reference Value = 6.540 V/m; Power Drift = 0.08 dB  
Peak SAR (extrapolated) = 2.22 W/kg  
**SAR(1 g) = 0.934 W/kg; SAR(10 g) = 0.357 W/kg**  
Maximum value of SAR (measured) = 1.68 W/kg

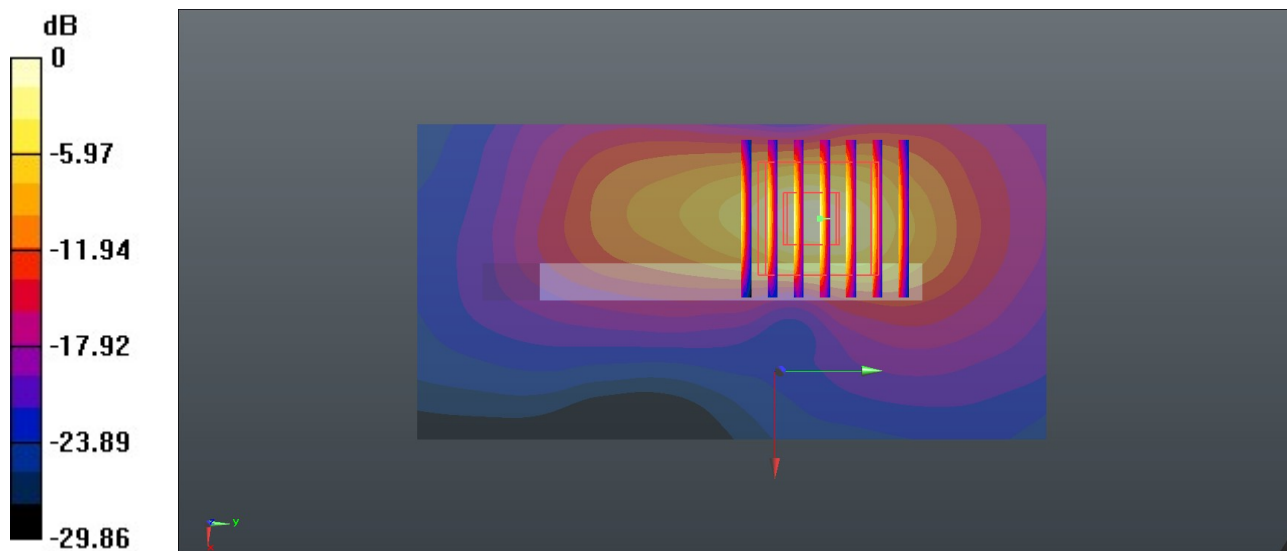

0 dB = 1.68 W/kg = 2.25 dBW/kg

### 63\_LTE Band 48\_20M\_QPSK\_1RB\_0Offset\_Bottom Side\_5mm\_Ch55830

Communication System: UID 0, LTE-TDD (0); Frequency: 3609 MHz; Duty Cycle: 1:1.59  
Medium: HSL\_3700 Medium parameters used:  $f = 3609$  MHz;  $\sigma = 2.967$  S/m;  $\epsilon_r = 38.818$ ;  $\rho = 1000$  kg/m<sup>3</sup>

Ambient Temperature : 23.1 °C; Liquid Temperature : 22.6 °C

#### DASY5 Configuration:

- Probe: EX3DV4 - SN3826; ConvF(6.98, 6.98, 6.98); Calibrated: 2022/8/8
- Sensor-Surface: 1.4mm (Mechanical Surface Detection)
- Electronics: DAE4 Sn1303; Calibrated: 2022/11/24
- Phantom: SAM Twin Phantom; Type: SAM Twin; Serial: TP-1842
- Measurement SW: DASY52, Version 52.10 (4); SEMCAD X Version 14.6.14 (7501)

**Area Scan (61x121x1):** Interpolated grid: dx=1.000 mm, dy=1.000 mm

Maximum value of SAR (interpolated) = 2.13 W/kg

**Zoom Scan (9x9x7)/Cube 0:** Measurement grid: dx=4mm, dy=4mm, dz=1.4mm

Reference Value = 20.38 V/m; Power Drift = -0.17 dB

Peak SAR (extrapolated) = 2.65 W/kg

**SAR(1 g) = 0.801 W/kg; SAR(10 g) = 0.227 W/kg**

Maximum value of SAR (measured) = 1.82 W/kg

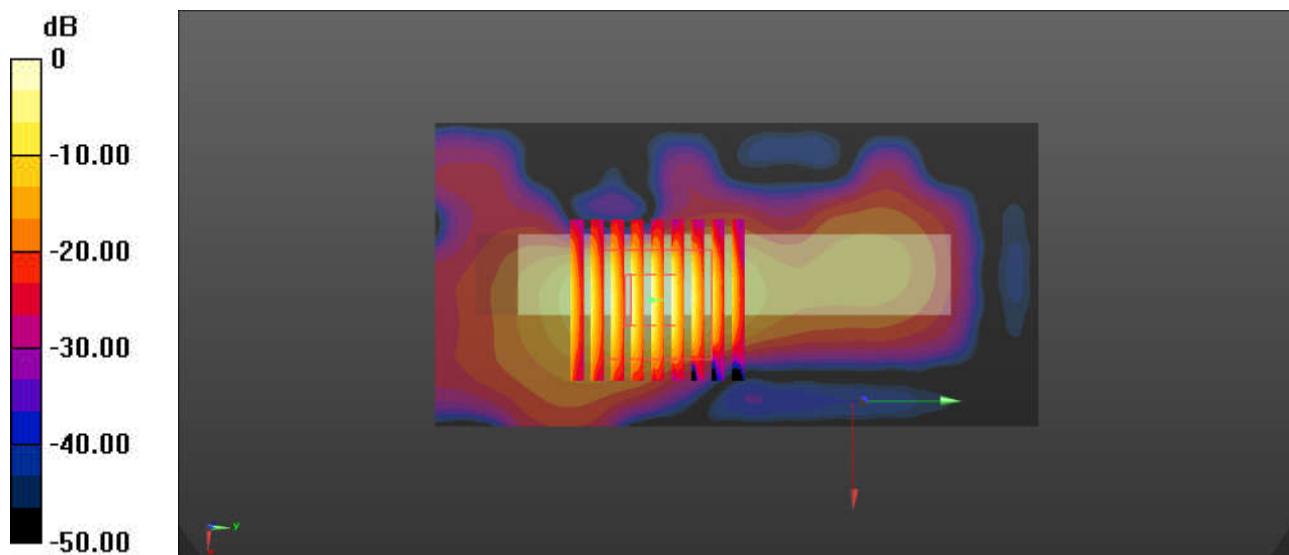

0 dB = 1.82 W/kg = 2.61 dBW/kg

**64\_FR1 n48\_40M\_QPSK\_100RB\_0Offset\_Bottom Side\_5mm\_Ch641666**

Communication System: UID 0, 5G NR (0); Frequency: 3624.99 MHz; Duty Cycle: 1:1  
Medium: HSL\_3700 Medium parameters used:  $f = 3625$  MHz;  $\sigma = 2.952$  S/m;  $\epsilon_r = 38.833$ ;  $\rho = 1000$  kg/m<sup>3</sup>

Ambient Temperature : 23.1 °C; Liquid Temperature : 22.6 °C

**DASY5 Configuration:**

- Probe: EX3DV4 - SN3826; ConvF(6.98, 6.98, 6.98); Calibrated: 2022/8/8
- Sensor-Surface: 1.4mm (Mechanical Surface Detection)
- Electronics: DAE4 Sn1303; Calibrated: 2022/11/24
- Phantom: SAM Twin Phantom; Type: SAM Twin; Serial: TP-1842
- Measurement SW: DASY52, Version 52.10 (4); SEMCAD X Version 14.6.14 (7501)

**Area Scan (61x121x1):** Interpolated grid: dx=1.000 mm, dy=1.000 mm

Maximum value of SAR (interpolated) = 1.94 W/kg

**Zoom Scan (9x9x7)/Cube 0:** Measurement grid: dx=4mm, dy=4mm, dz=1.4mm

Reference Value = 20.28 V/m; Power Drift = -0.09 dB

Peak SAR (extrapolated) = 2.41 W/kg

**SAR(1 g) = 0.720 W/kg; SAR(10 g) = 0.205 W/kg**

Maximum value of SAR (measured) = 1.66 W/kg

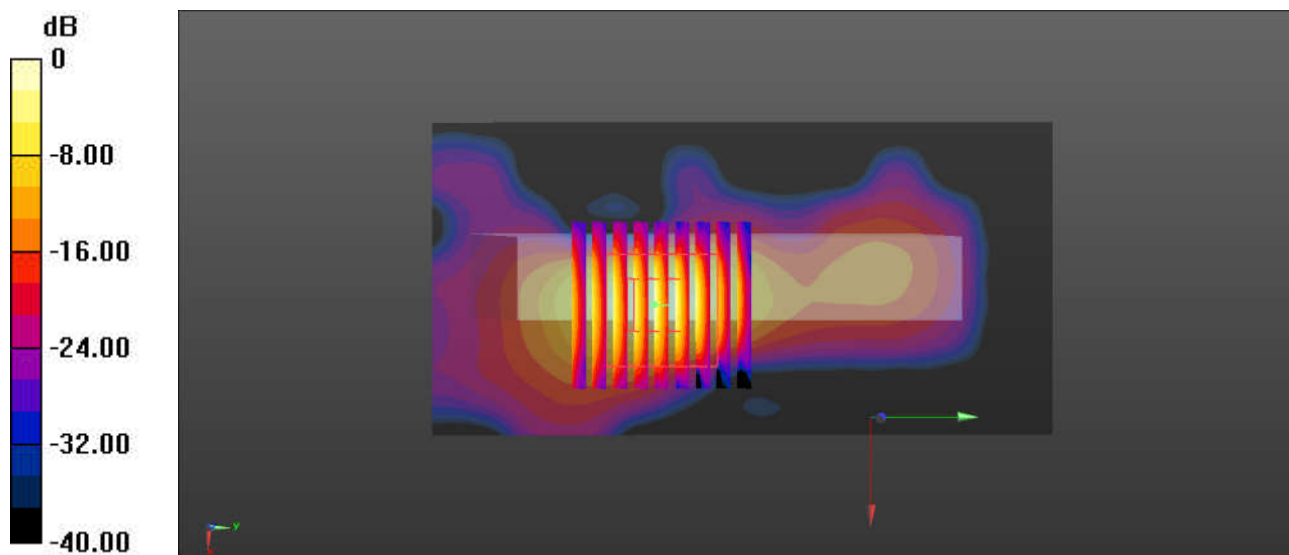

0 dB = 1.66 W/kg = 2.20 dBW/kg

**65\_FR1 n77\_Part27O\_100M\_QPSK\_1RB\_1Offset\_Bottom Side\_5mm\_Ch656000**

Communication System: UID 0, 5G NR (0); Frequency: 3840 MHz; Duty Cycle: 1:2  
Medium: HSL\_3900 Medium parameters used:  $f = 3840$  MHz;  $\sigma = 3.159$  S/m;  $\epsilon_r = 38.144$ ;  $\rho = 1000$  kg/m<sup>3</sup>  
Ambient Temperature : 23.2 °C; Liquid Temperature : 22.8 °C

**DASY5 Configuration:**

- Probe: EX3DV4 - SN3826; ConvF(6.42, 6.42, 6.42); Calibrated: 2022/8/8
- Sensor-Surface: 1.4mm (Mechanical Surface Detection)
- Electronics: DAE4 Sn1303; Calibrated: 2022/11/24
- Phantom: SAM Twin Phantom; Type: SAM Twin; Serial: TP-1842
- Measurement SW: DASY52, Version 52.10 (4); SEMCAD X Version 14.6.14 (7501)

**Area Scan (61x121x1):** Interpolated grid: dx=1.000 mm, dy=1.000 mm  
Maximum value of SAR (interpolated) = 1.69 W/kg

**Zoom Scan (8x8x7)/Cube 0:** Measurement grid: dx=4mm, dy=4mm, dz=1.4mm  
Reference Value = 5.680 V/m; Power Drift = 0.08 dB  
Peak SAR (extrapolated) = 2.86 W/kg  
**SAR(1 g) = 0.900 W/kg; SAR(10 g) = 0.273 W/kg**  
Maximum value of SAR (measured) = 1.93 W/kg

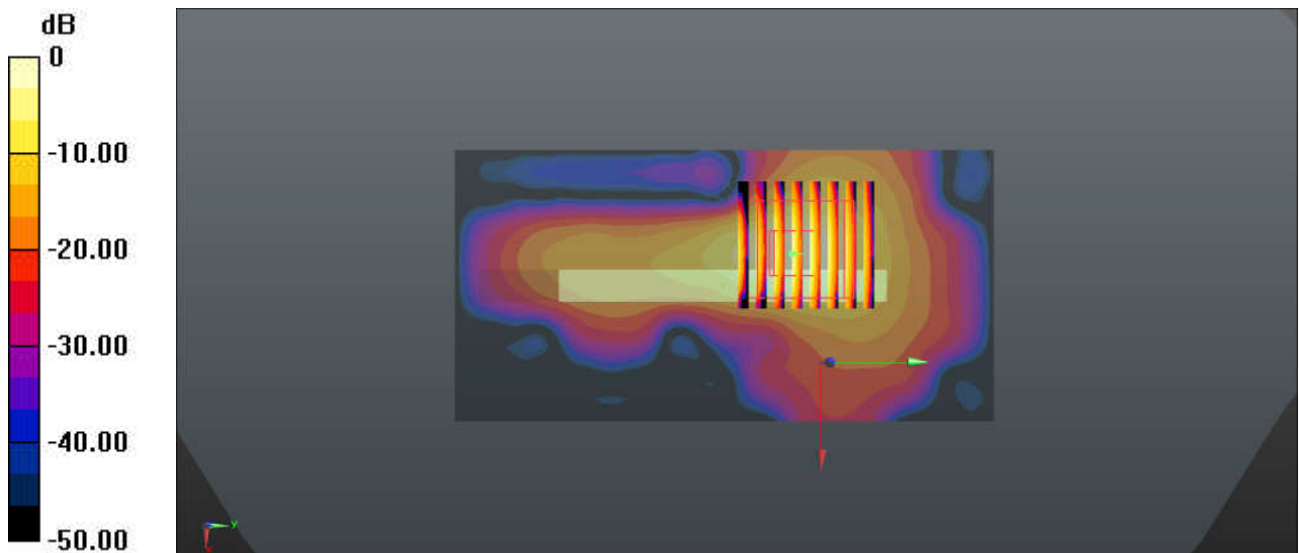

0 dB = 1.93 W/kg = 2.86 dBW/kg

### 66\_WLAN2.4GHz\_802.11b 1Mbps\_Left Side\_5mm\_Ch11

Communication System: UID 0, WLAN2.4GHz (0); Frequency: 2462 MHz; Duty Cycle: 1:1  
Medium: HSL\_2450 Medium parameters used:  $f = 2462$  MHz;  $\sigma = 1.845$  S/m;  $\epsilon_r = 39.851$ ;  $\rho = 1000$  kg/m<sup>3</sup>

Ambient Temperature : 23.2 °C; Liquid Temperature : 22.6 °C

#### DASY5 Configuration:

- Probe: EX3DV4 - SN3826; ConvF(7.57, 7.57, 7.57); Calibrated: 2022/8/8
- Sensor-Surface: 1.4mm (Mechanical Surface Detection)
- Electronics: DAE4 Sn1303; Calibrated: 2022/11/24
- Phantom: SAM Twin Phantom; Type: SAM Twin; Serial: TP-1842
- Measurement SW: DASY52, Version 52.10 (4); SEMCAD X Version 14.6.14 (7501)

**Area Scan (51x111x1):** Interpolated grid: dx=1.200 mm, dy=1.200 mm  
Maximum value of SAR (interpolated) = 0.653 W/kg

**Zoom Scan (7x7x7)/Cube 0:** Measurement grid: dx=5mm, dy=5mm, dz=5mm  
Reference Value = 16.84 V/m; Power Drift = -0.05 dB  
Peak SAR (extrapolated) = 0.646 W/kg  
**SAR(1 g) = 0.263 W/kg; SAR(10 g) = 0.098 W/kg**  
Maximum value of SAR (measured) = 0.498 W/kg

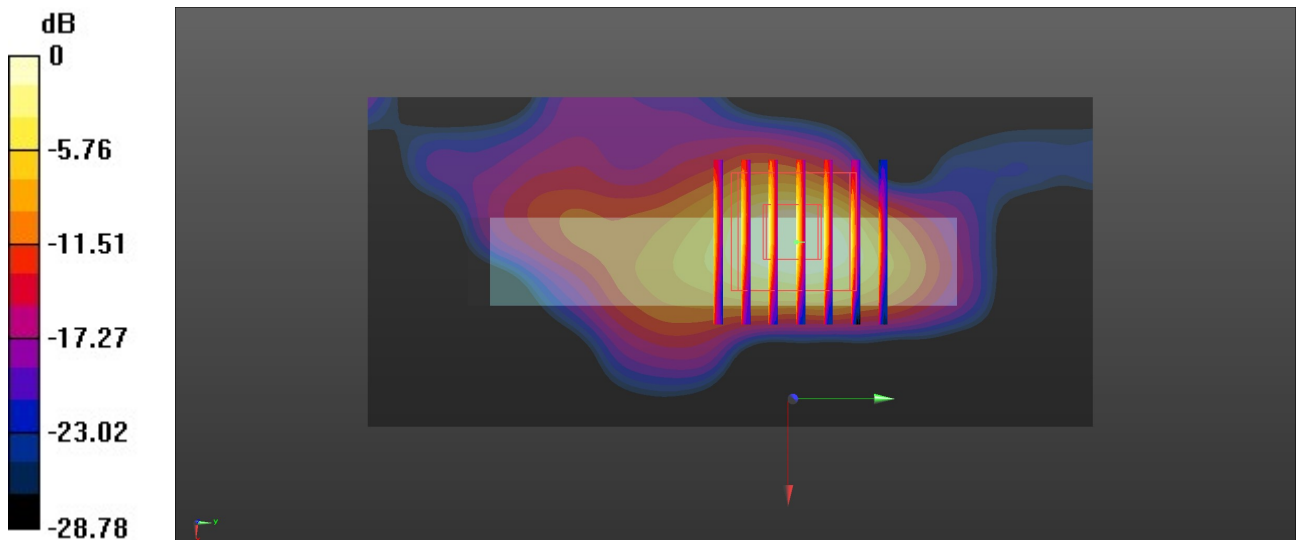

0 dB = 0.498 W/kg = -3.03 dBW/kg

### 67\_Bluetooth\_1Mbps\_Left Side\_5mm\_Ch39

Communication System: UID 0, Bluetooth (0); Frequency: 2441 MHz; Duty Cycle: 1:1.298  
Medium: HSL\_2450 Medium parameters used:  $f = 2441$  MHz;  $\sigma = 1.842$  S/m;  $\epsilon_r = 39.091$ ;  $\rho = 1000$  kg/m<sup>3</sup>

Ambient Temperature : 23.2 °C; Liquid Temperature : 22.5 °C

#### DASY5 Configuration:

- Probe: EX3DV4 - SN3826; ConvF(7.57, 7.57, 7.57); Calibrated: 2022/8/8
- Sensor-Surface: 1.4mm (Mechanical Surface Detection)
- Electronics: DAE4 Sn1303; Calibrated: 2022/11/24
- Phantom: SAM Twin Phantom; Type: SAM Twin; Serial: TP-1842
- Measurement SW: DASY52, Version 52.10 (4); SEMCAD X Version 14.6.14 (7501)

**Area Scan (51x171x1):** Interpolated grid: dx=1.200 mm, dy=1.200 mm  
Maximum value of SAR (interpolated) = 0.241 W/kg

**Zoom Scan (7x7x7)/Cube 0:** Measurement grid: dx=5mm, dy=5mm, dz=5mm  
Reference Value = 8.106 V/m; Power Drift = -0.01 dB  
Peak SAR (extrapolated) = 0.403 W/kg  
**SAR(1 g) = 0.148 W/kg; SAR(10 g) = 0.055 W/kg**  
Maximum value of SAR (measured) = 0.284 W/kg

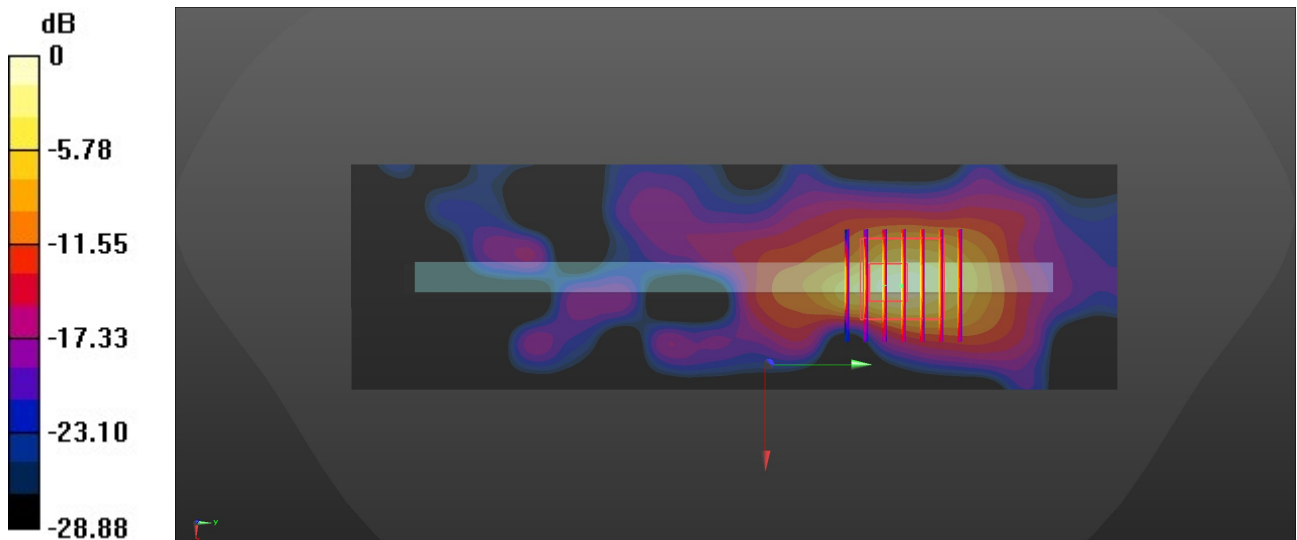

0 dB = 0.284 W/kg = -5.47 dBW/kg

### 68\_WLAN5GHz\_802.11ac-VHT80 MCS0\_Left Side\_5mm\_Ch42

Communication System: UID 0, WLAN5GHz (0); Frequency: 5210 MHz; Duty Cycle: 1:1  
Medium: HSL\_5000 Medium parameters used:  $f = 5210$  MHz;  $\sigma = 4.538$  S/m;  $\epsilon_r = 36.359$ ;  $\rho = 1000$  kg/m<sup>3</sup>

Ambient Temperature : 23.3 °C; Liquid Temperature : 22.6 °C

#### DASY5 Configuration:

- Probe: EX3DV4 - SN3826; ConvF(5.1, 5.1, 5.1); Calibrated: 2022/8/8
- Sensor-Surface: 1.4mm (Mechanical Surface Detection)
- Electronics: DAE4 Sn1303; Calibrated: 2022/11/24
- Phantom: SAM Twin Phantom; Type: SAM Twin; Serial: TP-1842
- Measurement SW: DASY52, Version 52.10 (4); SEMCAD X Version 14.6.14 (7501)

**Area Scan (51x131x1):** Interpolated grid: dx=1.000 mm, dy=1.000 mm  
Maximum value of SAR (interpolated) = 0.92 W/kg

**Zoom Scan (9x9x7)/Cube 0:** Measurement grid: dx=4mm, dy=4mm, dz=1.4mm  
Reference Value = 9.075 V/m; Power Drift = 0.11 dB  
Peak SAR (extrapolated) = 1.07 W/kg  
**SAR(1 g) = 0.236 W/kg; SAR(10 g) = 0.052 W/kg**  
Maximum value of SAR (measured) = 0.65 W/kg

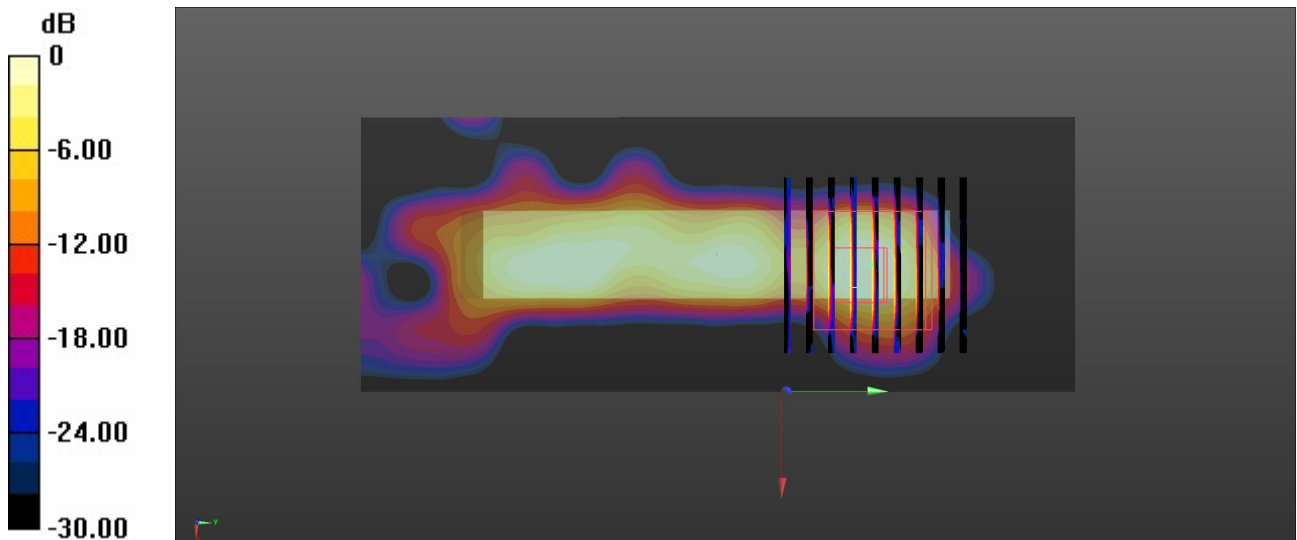

0 dB = 0.65 W/kg = -1.88 dBW/kg

### 69\_WLAN5GHz\_802.11ac-VHT80 MCS0\_Left Side\_5mm\_Ch155

Communication System: UID 0, WLAN5GHz (0); Frequency: 5775 MHz; Duty Cycle: 1:1  
Medium: HSL\_5000 Medium parameters used:  $f = 5775$  MHz;  $\sigma = 5.153$  S/m;  $\epsilon_r = 34.09$ ;  $\rho = 1000$  kg/m<sup>3</sup>

Ambient Temperature : 23.4 °C; Liquid Temperature : 22.9 °C

#### DASY5 Configuration:

- Probe: EX3DV4 - SN3826; ConvF(4.45, 4.45, 4.45); Calibrated: 2022/8/8
- Sensor-Surface: 1.4mm (Mechanical Surface Detection)
- Electronics: DAE4 Sn1303; Calibrated: 2022/11/24
- Phantom: SAM Twin Phantom; Type: SAM Twin; Serial: TP-1842
- Measurement SW: DASY52, Version 52.10 (4); SEMCAD X Version 14.6.14 (7501)

**Area Scan (51x211x1):** Interpolated grid: dx=1.000 mm, dy=1.000 mm  
Maximum value of SAR (interpolated) = 0.726 W/kg

**Zoom Scan (9x9x7)/Cube 0:** Measurement grid: dx=4mm, dy=4mm, dz=1.4mm  
Reference Value = 9.231 V/m; Power Drift = 0.08 dB  
Peak SAR (extrapolated) = 1.25 W/kg  
**SAR(1 g) = 0.240 W/kg; SAR(10 g) = 0.050 W/kg**  
Maximum value of SAR (measured) = 0.791 W/kg

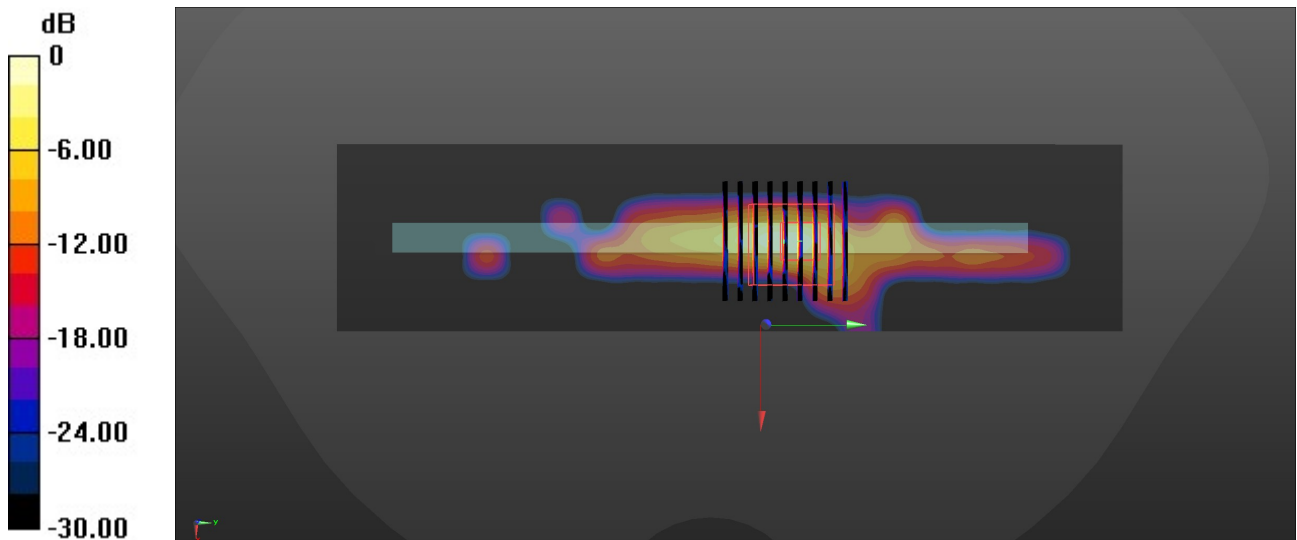

0 dB = 0.791 W/kg = -1.02 dBW/kg



### 70\_LTE Band 71\_20M\_QPSK\_1RB\_0Offset\_Back\_5mm\_Ch133322

Communication System: UID 0, LTE-FDD (0); Frequency: 683 MHz; Duty Cycle: 1:1  
Medium: HSL\_750 Medium parameters used:  $f = 683$  MHz;  $\sigma = 0.881$  S/m;  $\epsilon_r = 41.597$ ;  $\rho = 1000$  kg/m<sup>3</sup>

Ambient Temperature : 23.2 °C; Liquid Temperature : 22.7 °C

#### DASY5 Configuration:

- Probe: EX3DV4 - SN3826; ConvF(9.67, 9.67, 9.67); Calibrated: 2022/8/8
- Sensor-Surface: 1.4mm (Mechanical Surface Detection)
- Electronics: DAE4 Sn1303; Calibrated: 2022/11/24
- Phantom: SAM Twin Phantom; Type: SAM Twin; Serial: TP-1842
- Measurement SW: DASY52, Version 52.10 (4); SEMCAD X Version 14.6.14 (7501)

**Area Scan (71x131x1):** Interpolated grid: dx=1.500 mm, dy=1.500 mm  
Maximum value of SAR (interpolated) = 0.94 W/kg

**Zoom Scan (6x6x7)/Cube 0:** Measurement grid: dx=8mm, dy=8mm, dz=5mm  
Reference Value = 8.982 V/m; Power Drift = -0.02 dB  
Peak SAR (extrapolated) = 1.14 W/kg  
**SAR(1 g) = 0.471 W/kg; SAR(10 g) = 0.275 W/kg**  
Maximum value of SAR (measured) = 0.76 W/kg

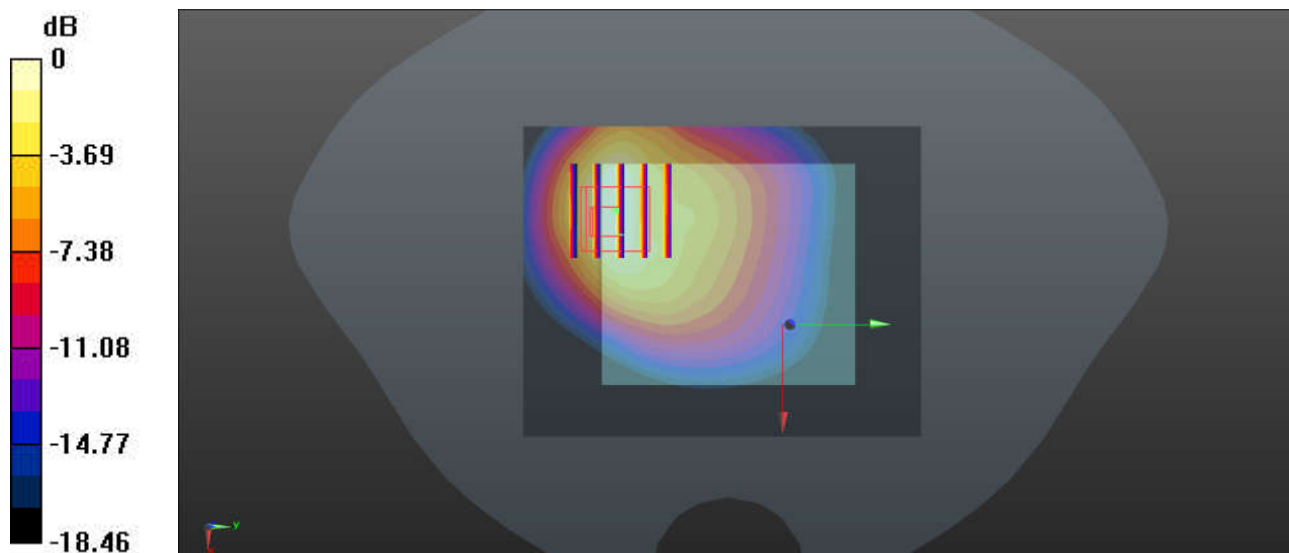

0 dB = 0.76 W/kg = -1.20 dBW/kg

### 71\_LTE Band 12\_10M\_QPSK\_1RB\_0Offset\_Back\_5mm\_Ch23095

Communication System: UID 0, LTE-FDD (0); Frequency: 707.5 MHz; Duty Cycle: 1:1  
Medium: HSL\_750 Medium parameters used:  $f = 707.5$  MHz;  $\sigma = 0.863$  S/m;  $\epsilon_r = 42.575$ ;  $\rho = 1000$  kg/m<sup>3</sup>

Ambient Temperature : 23.2 °C; Liquid Temperature : 22.7 °C

#### DASY5 Configuration:

- Probe: EX3DV4 - SN3826; ConvF(9.67, 9.67, 9.67); Calibrated: 2022/8/8
- Sensor-Surface: 1.4mm (Mechanical Surface Detection)
- Electronics: DAE4 Sn1303; Calibrated: 2022/11/24
- Phantom: SAM Twin Phantom; Type: SAM Twin; Serial: TP-1842
- Measurement SW: DASY52, Version 52.10 (4); SEMCAD X Version 14.6.14 (7501)

**Area Scan (71x131x1):** Interpolated grid: dx=1.500 mm, dy=1.500 mm  
Maximum value of SAR (interpolated) = 0.783 W/kg

**Zoom Scan (6x6x7)/Cube 0:** Measurement grid: dx=8mm, dy=8mm, dz=5mm  
Reference Value = 10.32 V/m; Power Drift = 0.18 dB  
Peak SAR (extrapolated) = 0.964 W/kg  
**SAR(1 g) = 0.404 W/kg; SAR(10 g) = 0.239 W/kg**  
Maximum value of SAR (measured) = 0.648 W/kg

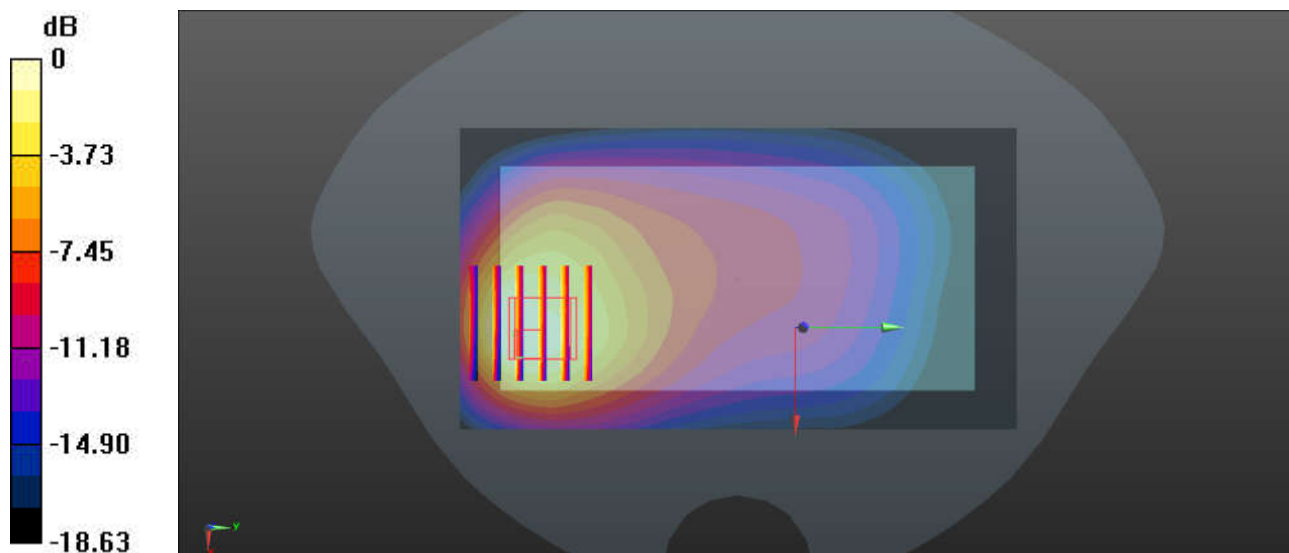

0 dB = 0.648 W/kg = -1.88 dBW/kg

### 72\_LTE Band 13\_10M\_QPSK\_25RB\_0Offset\_Back\_5mm\_Ch23230

Communication System: UID 0, LTE-FDD (0); Frequency: 782 MHz; Duty Cycle: 1:1  
Medium: HSL\_750 Medium parameters used:  $f = 782 \text{ MHz}$ ;  $\sigma = 0.895 \text{ S/m}$ ;  $\epsilon_r = 42.455$ ;  $\rho = 1000 \text{ kg/m}^3$

Ambient Temperature : 23.2 °C; Liquid Temperature : 22.7 °C

#### DASY5 Configuration:

- Probe: EX3DV4 - SN3826; ConvF(9.67, 9.67, 9.67); Calibrated: 2022/8/8
- Sensor-Surface: 1.4mm (Mechanical Surface Detection)
- Electronics: DAE4 Sn1303; Calibrated: 2022/11/24
- Phantom: SAM Twin Phantom; Type: SAM Twin; Serial: TP-1842
- Measurement SW: DASY52, Version 52.10 (4); SEMCAD X Version 14.6.14 (7501)

**Area Scan (71x141x1):** Interpolated grid:  $dx=1.500 \text{ mm}$ ,  $dy=1.500 \text{ mm}$   
Maximum value of SAR (interpolated) = 1.24 W/kg

**Zoom Scan (7x6x7)/Cube 0:** Measurement grid:  $dx=8\text{mm}$ ,  $dy=8\text{mm}$ ,  $dz=5\text{mm}$   
Reference Value = 10.34 V/m; Power Drift = -0.17 dB  
Peak SAR (extrapolated) = 1.44 W/kg  
**SAR(1 g) = 0.625 W/kg; SAR(10 g) = 0.334 W/kg**  
Maximum value of SAR (measured) = 1.08 W/kg

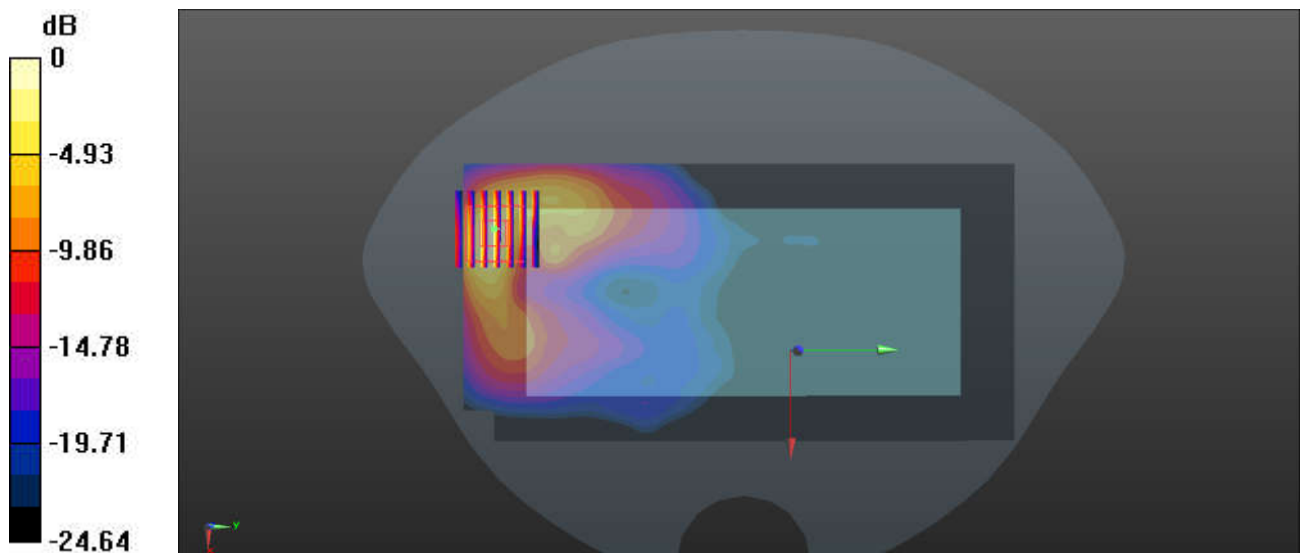

0 dB = 1.08 W/kg = 0.33 dBW/kg

### 73\_LTE Band 14\_10M\_QPSK\_1RB\_0Offset\_Back\_5mm\_Ch23330

Communication System: UID 0, LTE-FDD (0); Frequency: 793 MHz; Duty Cycle: 1:1  
Medium: HSL\_750 Medium parameters used:  $f = 793 \text{ MHz}$ ;  $\sigma = 0.919 \text{ S/m}$ ;  $\epsilon_r = 41.297$ ;  $\rho = 1000 \text{ kg/m}^3$

Ambient Temperature : 23.2 °C; Liquid Temperature : 22.5 °C

#### DASY5 Configuration:

- Probe: EX3DV4 - SN3826; ConvF(9.67, 9.67, 9.67); Calibrated: 2022/8/8
- Sensor-Surface: 1.4mm (Mechanical Surface Detection)
- Electronics: DAE4 Sn1303; Calibrated: 2022/11/24
- Phantom: SAM Twin Phantom; Type: SAM Twin; Serial: TP-1842
- Measurement SW: DASY52, Version 52.10 (4); SEMCAD X Version 14.6.14 (7501)

**Area Scan (71x91x1):** Interpolated grid:  $dx=1.500 \text{ mm}$ ,  $dy=1.500 \text{ mm}$

Maximum value of SAR (interpolated) = 0.774 W/kg

**Zoom Scan (5x5x7)/Cube 0:** Measurement grid:  $dx=8\text{mm}$ ,  $dy=8\text{mm}$ ,  $dz=5\text{mm}$

Reference Value = 2.467 V/m; Power Drift = -0.11 dB

Peak SAR (extrapolated) = 1.25 W/kg

**SAR(1 g) = 0.626 W/kg; SAR(10 g) = 0.350 W/kg**

Maximum value of SAR (measured) = 0.778 W/kg

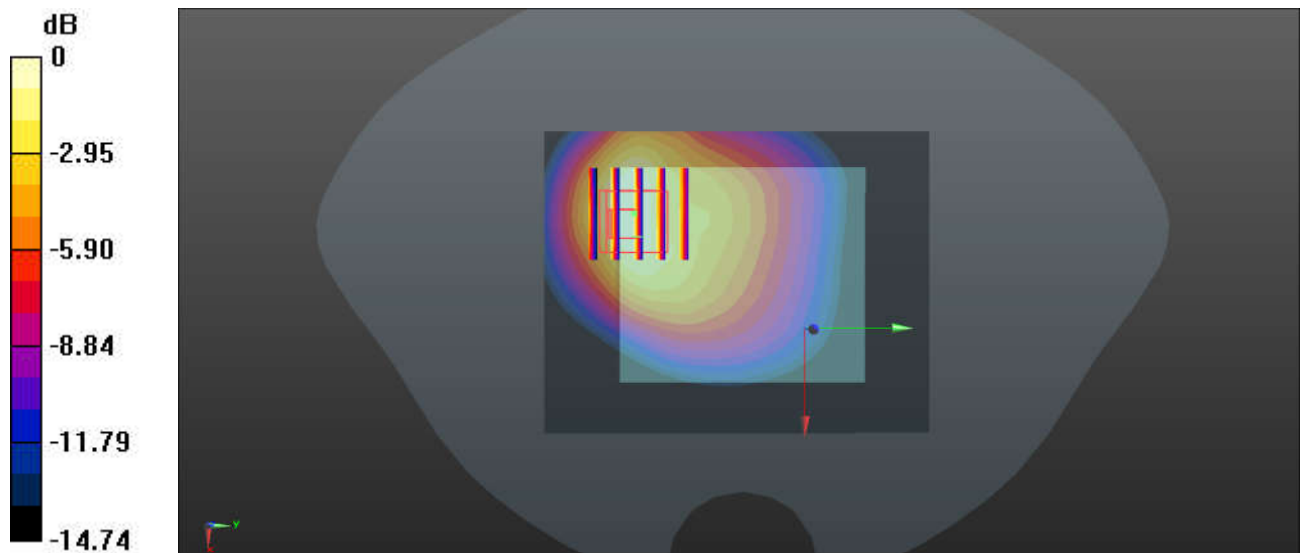

0 dB = 0.778 W/kg = -1.09 dBW/kg

### 74\_FR1 n71\_20M\_QPSK\_1RB\_1Offset\_Back\_5mm\_Ch136100

Communication System: UID 0, 5G NR (0); Frequency: 680.5 MHz; Duty Cycle: 1:1  
Medium: HSL\_750 Medium parameters used:  $f = 680.5$  MHz;  $\sigma = 0.862$  S/m;  $\epsilon_r = 42.796$ ;  $\rho = 1000$  kg/m<sup>3</sup>  
Ambient Temperature : 23.2 °C; Liquid Temperature : 22.7 °C

#### DASY5 Configuration:

- Probe: EX3DV4 - SN3826; ConvF(9.67, 9.67, 9.67); Calibrated: 2022/8/8
- Sensor-Surface: 1.4mm (Mechanical Surface Detection)
- Electronics: DAE4 Sn1303; Calibrated: 2022/11/24
- Phantom: SAM Twin Phantom; Type: SAM Twin; Serial: TP-1842
- Measurement SW: DASY52, Version 52.10 (4); SEMCAD X Version 14.6.14 (7501)

**Area Scan (71x141x1):** Interpolated grid: dx=1.500 mm, dy=1.500 mm  
Maximum value of SAR (interpolated) = 0.496 W/kg

**Zoom Scan (6x6x7)/Cube 0:** Measurement grid: dx=8mm, dy=8mm, dz=5mm  
Reference Value = 10.63 V/m; Power Drift = 0.17 dB  
Peak SAR (extrapolated) = 0.723 W/kg  
**SAR(1 g) = 0.319 W/kg; SAR(10 g) = 0.172 W/kg**  
Maximum value of SAR (measured) = 0.556 W/kg

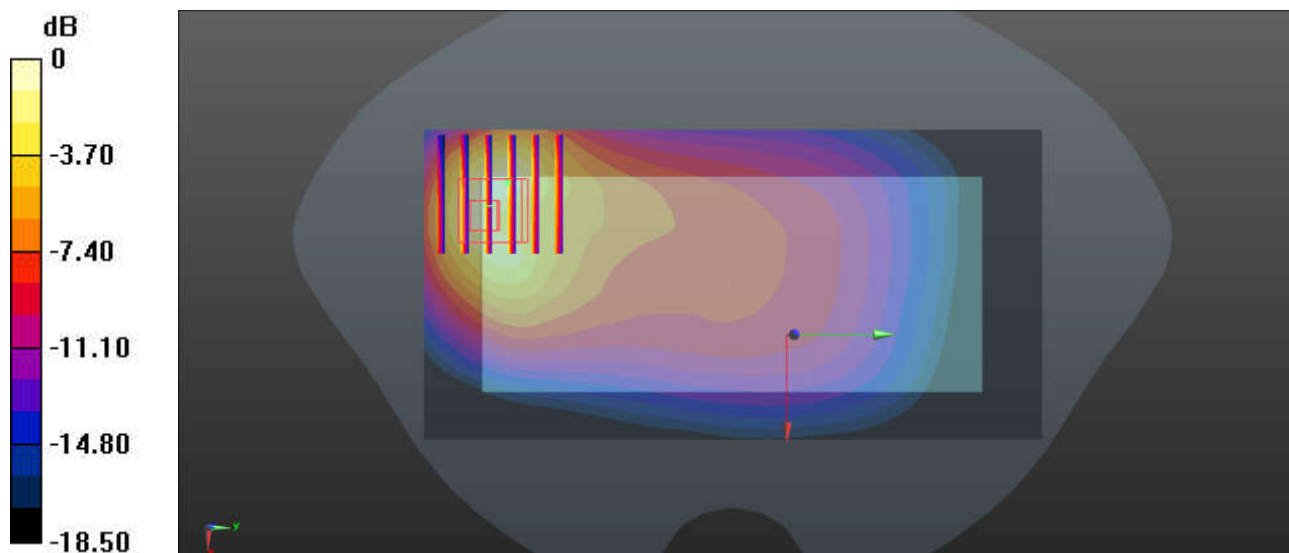

0 dB = 0.556 W/kg = -2.55 dBW/kg

### 75\_FR1 n12\_15M\_QPSK\_1RB\_1Offset\_Back\_5mm\_Ch141500

Communication System: UID 0, 5G NR (0); Frequency: 707.5 MHz; Duty Cycle: 1:1  
Medium: HSL\_750 Medium parameters used:  $f = 707.5$  MHz;  $\sigma = 0.863$  S/m;  $\epsilon_r = 42.575$ ;  $\rho = 1000$  kg/m<sup>3</sup>  
Ambient Temperature : 23.2 °C; Liquid Temperature : 22.7 °C

#### DASY5 Configuration:

- Probe: EX3DV4 - SN3826; ConvF(9.67, 9.67, 9.67); Calibrated: 2022/8/8
- Sensor-Surface: 1.4mm (Mechanical Surface Detection)
- Electronics: DAE4 Sn1303; Calibrated: 2022/11/24
- Phantom: SAM Twin Phantom; Type: SAM Twin; Serial: TP-1842
- Measurement SW: DASY52, Version 52.10 (4); SEMCAD X Version 14.6.14 (7501)

**Area Scan (71x141x1):** Interpolated grid: dx=1.500 mm, dy=1.500 mm  
Maximum value of SAR (interpolated) = 0.68 W/kg

**Zoom Scan (6x6x7)/Cube 0:** Measurement grid: dx=8mm, dy=8mm, dz=5mm  
Reference Value = 7.928 V/m; Power Drift = -0.03 dB  
Peak SAR (extrapolated) = 0.91 W/kg  
**SAR(1 g) = 0.380 W/kg; SAR(10 g) = 0.227 W/kg**  
Maximum value of SAR (measured) = 0.62 W/kg

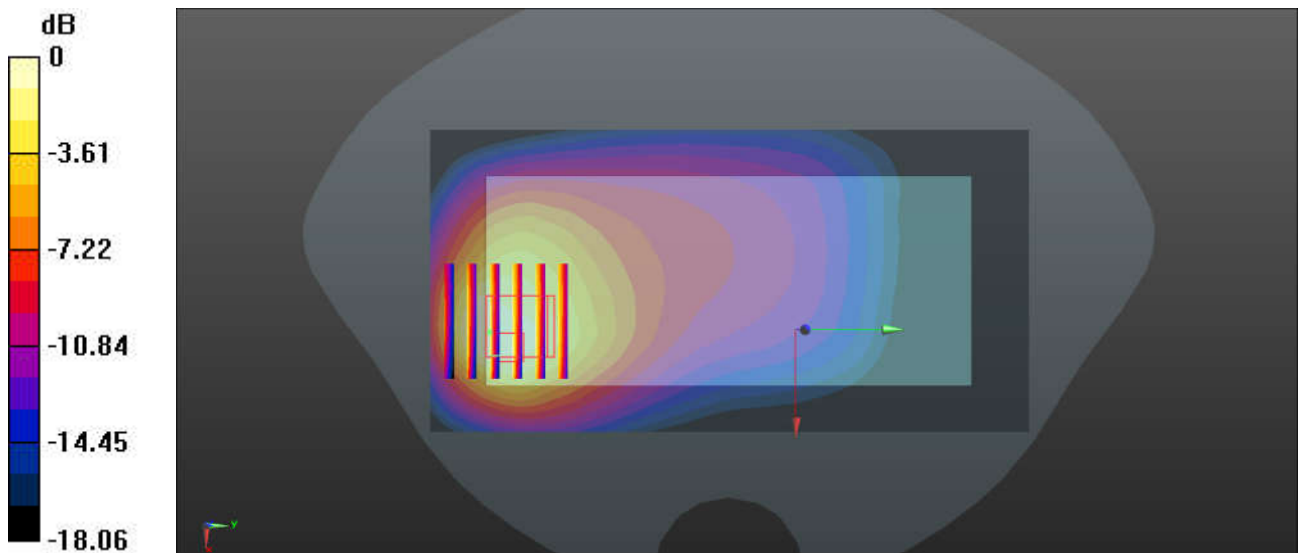

0 dB = 0.62 W/kg = -2.04 dBW/kg

### 76\_FR1 n13\_10M\_QPSK\_25RB\_14Offset\_Back\_5mm\_Ch156400

Communication System: UID 0, 5G NR (0); Frequency: 782 MHz; Duty Cycle: 1:1  
Medium: HSL\_750 Medium parameters used:  $f = 782 \text{ MHz}$ ;  $\sigma = 0.895 \text{ S/m}$ ;  $\epsilon_r = 42.455$ ;  $\rho = 1000 \text{ kg/m}^3$   
Ambient Temperature : 23.2 °C; Liquid Temperature : 22.7 °C

#### DASY5 Configuration:

- Probe: EX3DV4 - SN3826; ConvF(9.67, 9.67, 9.67); Calibrated: 2022/8/8
- Sensor-Surface: 1.4mm (Mechanical Surface Detection)
- Electronics: DAE4 Sn1303; Calibrated: 2022/11/24
- Phantom: SAM Twin Phantom; Type: SAM Twin; Serial: TP-1842
- Measurement SW: DASY52, Version 52.10 (4); SEMCAD X Version 14.6.14 (7501)

**Area Scan (71x141x1):** Interpolated grid:  $dx=1.500 \text{ mm}$ ,  $dy=1.500 \text{ mm}$   
Maximum value of SAR (interpolated) = 0.733 W/kg

**Zoom Scan (5x5x7)/Cube 0:** Measurement grid:  $dx=8\text{mm}$ ,  $dy=8\text{mm}$ ,  $dz=5\text{mm}$   
Reference Value = 9.907 V/m; Power Drift = 0.17 dB  
Peak SAR (extrapolated) = 0.891 W/kg  
**SAR(1 g) = 0.408 W/kg; SAR(10 g) = 0.225 W/kg**  
Maximum value of SAR (measured) = 0.705 W/kg

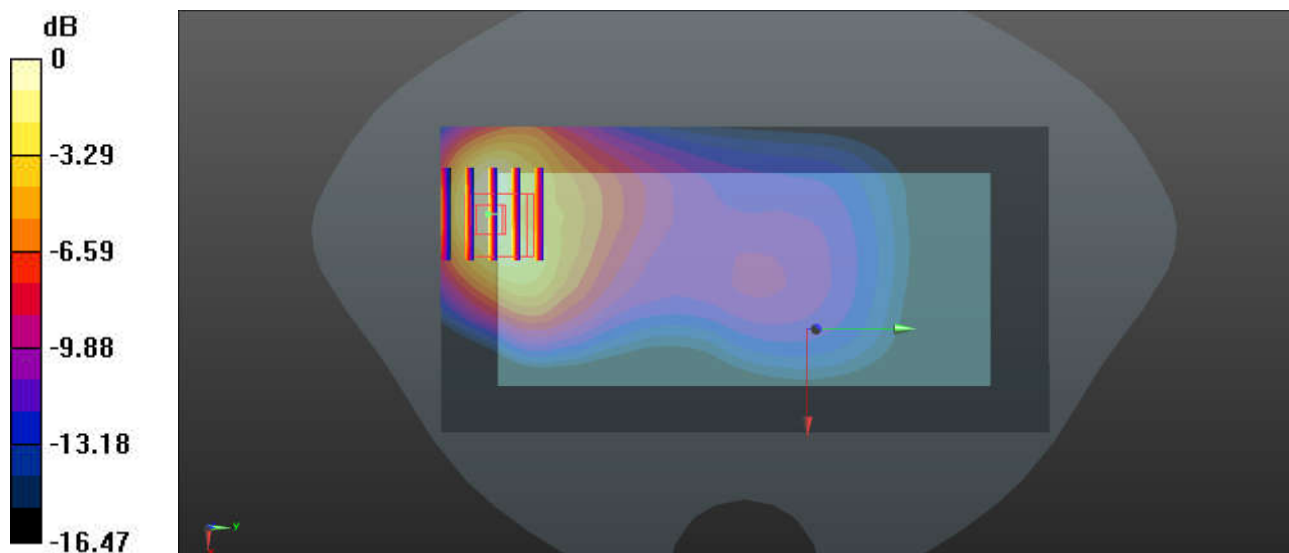

0 dB = 0.705 W/kg = -1.52 dBW/kg

### 77\_FR1 n14\_10M\_QPSK\_25RB\_14Offset\_Back\_5mm\_Ch158600

Communication System: UID 0, 5G NR (0); Frequency: 793 MHz; Duty Cycle: 1:1  
Medium: HSL\_750 Medium parameters used:  $f = 793 \text{ MHz}$ ;  $\sigma = 0.895 \text{ S/m}$ ;  $\epsilon_r = 42.417$ ;  $\rho = 1000 \text{ kg/m}^3$   
Ambient Temperature : 23.2 °C; Liquid Temperature : 22.7 °C

#### DASY5 Configuration:

- Probe: EX3DV4 - SN3826; ConvF(9.67, 9.67, 9.67); Calibrated: 2022/8/8
- Sensor-Surface: 1.4mm (Mechanical Surface Detection)
- Electronics: DAE4 Sn1303; Calibrated: 2022/11/24
- Phantom: SAM Twin Phantom; Type: SAM Twin; Serial: TP-1842
- Measurement SW: DASY52, Version 52.10 (4); SEMCAD X Version 14.6.14 (7501)

**Area Scan (71x141x1):** Interpolated grid:  $dx=1.500 \text{ mm}$ ,  $dy=1.500 \text{ mm}$   
Maximum value of SAR (interpolated) = 0.856 W/kg

**Zoom Scan (5x5x7)/Cube 0:** Measurement grid:  $dx=8\text{mm}$ ,  $dy=8\text{mm}$ ,  $dz=5\text{mm}$   
Reference Value = 11.18 V/m; Power Drift = 0.05 dB  
Peak SAR (extrapolated) = 1.04 W/kg  
**SAR(1 g) = 0.477 W/kg; SAR(10 g) = 0.258 W/kg**  
Maximum value of SAR (measured) = 0.824 W/kg

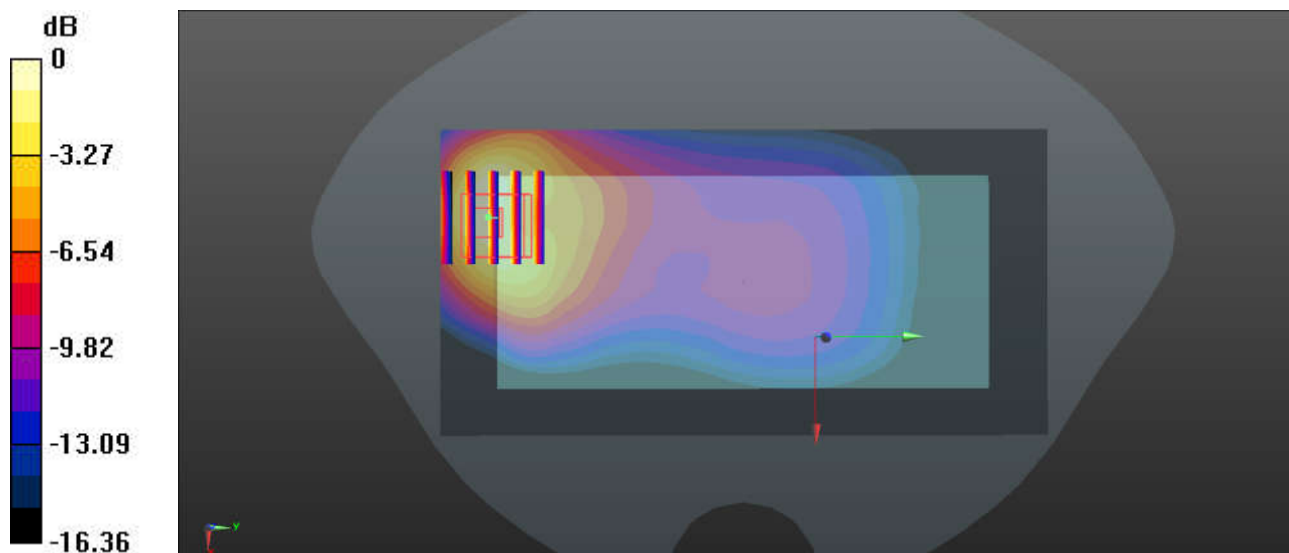

0 dB = 0.824 W/kg = -0.84 dBW/kg



### 78\_GSM850\_GPRS (3 Tx slots)\_Back\_5mm\_Ch189

Communication System: UID 0, GSM850 (0); Frequency: 836.4 MHz; Duty Cycle: 1:2.77  
Medium: HSL\_835 Medium parameters used:  $f = 836.4$  MHz;  $\sigma = 0.913$  S/m;  $\epsilon_r = 41.948$ ;  $\rho = 1000$  kg/m<sup>3</sup>

Ambient Temperature : 23.1 °C; Liquid Temperature : 22.5 °C

#### DASY5 Configuration:

- Probe: EX3DV4 - SN3826; ConvF(9.31, 9.31, 9.31); Calibrated: 2022/8/8
- Sensor-Surface: 1.4mm (Mechanical Surface Detection)
- Electronics: DAE4 Sn1303; Calibrated: 2022/11/24
- Phantom: SAM Twin Phantom; Type: SAM Twin; Serial: TP-1842
- Measurement SW: DASY52, Version 52.10 (4); SEMCAD X Version 14.6.14 (7501)

**Area Scan (81x141x1):** Interpolated grid: dx=1.500 mm, dy=1.500 mm  
Maximum value of SAR (interpolated) = 1.10 W/kg

**Zoom Scan (5x5x7)/Cube 0:** Measurement grid: dx=8mm, dy=8mm, dz=5mm  
Reference Value = 9.293 V/m; Power Drift = 0.14 dB  
Peak SAR (extrapolated) = 1.31 W/kg  
**SAR(1 g) = 0.618 W/kg; SAR(10 g) = 0.331 W/kg**  
Maximum value of SAR (measured) = 1.05 W/kg

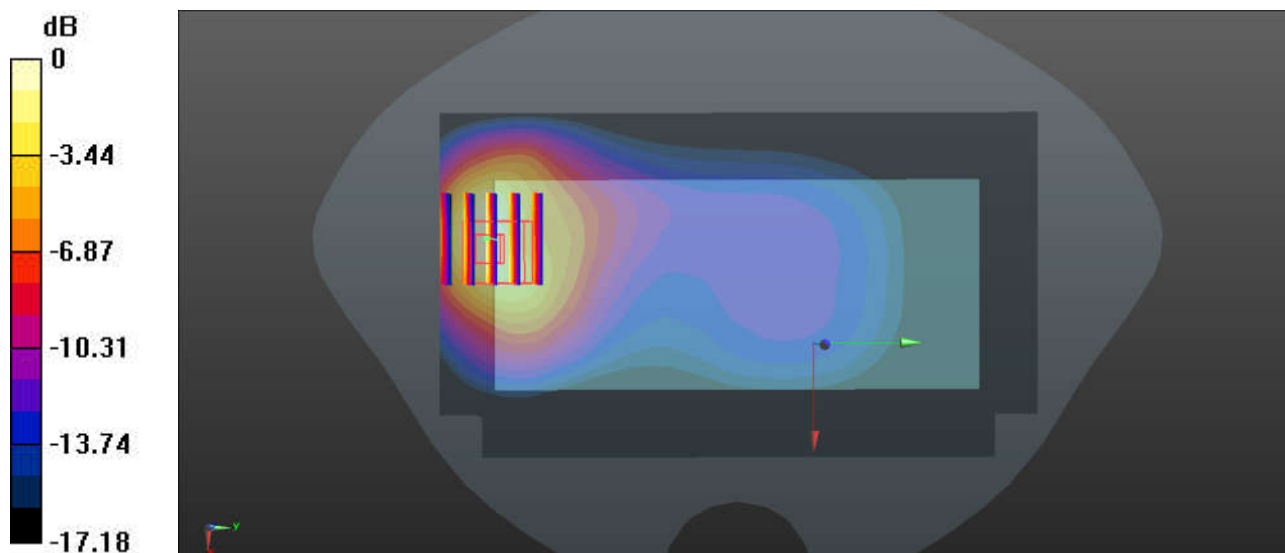

0 dB = 1.05 W/kg = 0.21 dBW/kg

### 79\_WCDMA V\_RMC 12.2Kbps\_Back\_5mm\_Ch4182

Communication System: UID 0, WCDMA (0); Frequency: 836.4 MHz; Duty Cycle: 1:1  
Medium: HSL\_835 Medium parameters used:  $f = 836.4$  MHz;  $\sigma = 0.913$  S/m;  $\epsilon_r = 41.948$ ;  $\rho = 1000$  kg/m<sup>3</sup>

Ambient Temperature : 23.1 °C; Liquid Temperature : 22.5 °C

#### DASY5 Configuration:

- Probe: EX3DV4 - SN3826; ConvF(9.31, 9.31, 9.31); Calibrated: 2022/8/8
- Sensor-Surface: 1.4mm (Mechanical Surface Detection)
- Electronics: DAE4 Sn1303; Calibrated: 2022/11/24
- Phantom: SAM Twin Phantom; Type: SAM Twin; Serial: TP-1842
- Measurement SW: DASY52, Version 52.10 (4); SEMCAD X Version 14.6.14 (7501)

**Area Scan (81x141x1):** Interpolated grid: dx=1.500 mm, dy=1.500 mm  
Maximum value of SAR (interpolated) = 1.13 W/kg

**Zoom Scan (5x5x7)/Cube 0:** Measurement grid: dx=8mm, dy=8mm, dz=5mm  
Reference Value = 7.297 V/m; Power Drift = -0.17 dB  
Peak SAR (extrapolated) = 1.40 W/kg  
**SAR(1 g) = 0.651 W/kg; SAR(10 g) = 0.342 W/kg**  
Maximum value of SAR (measured) = 1.08 W/kg

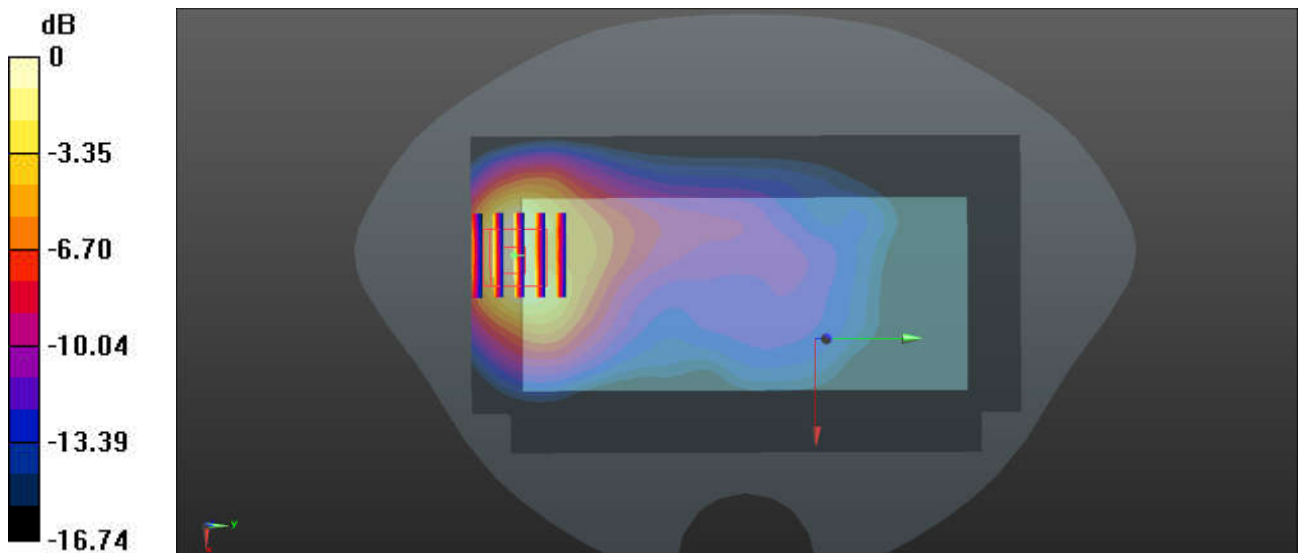

0 dB = 1.08 W/kg = 0.34 dBW/kg

### 80\_LTE Band 26\_15M\_QPSK\_1RB\_0Offset\_Back\_5mm\_Ch26865

Communication System: UID 0, LTE-FDD (0); Frequency: 831.5 MHz; Duty Cycle: 1:1  
Medium: HSL\_835 Medium parameters used:  $f = 831.5$  MHz;  $\sigma = 0.932$  S/m;  $\epsilon_r = 41.179$ ;  $\rho = 1000$  kg/m<sup>3</sup>

Ambient Temperature : 23.3 °C; Liquid Temperature : 22.8 °C

#### DASY5 Configuration:

- Probe: EX3DV4 - SN3826; ConvF(9.31, 9.31, 9.31); Calibrated: 2022/8/8
- Sensor-Surface: 1.4mm (Mechanical Surface Detection)
- Electronics: DAE4 Sn1303; Calibrated: 2022/11/24
- Phantom: SAM Twin Phantom; Type: SAM Twin; Serial: TP-1842
- Measurement SW: DASY52, Version 52.10 (4); SEMCAD X Version 14.6.14 (7501)

**Area Scan (71x91x1):** Interpolated grid: dx=1.500 mm, dy=1.500 mm

Maximum value of SAR (interpolated) = 0.925 W/kg

**Zoom Scan (5x5x7)/Cube 0:** Measurement grid: dx=8mm, dy=8mm, dz=5mm

Reference Value = 2.728 V/m; Power Drift = -0.07 dB

Peak SAR (extrapolated) = 1.51 W/kg

**SAR(1 g) = 0.759 W/kg; SAR(10 g) = 0.419 W/kg**

Maximum value of SAR (measured) = 0.949 W/kg

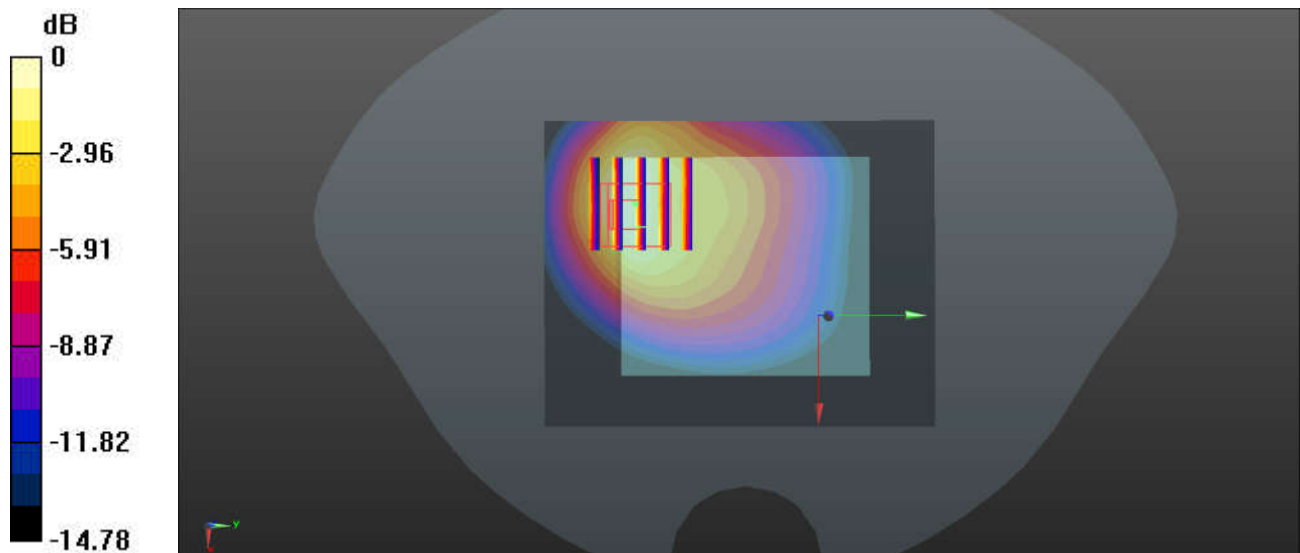

0 dB = 0.949 W/kg = -0.23 dBW/kg

### 81\_FR1 n26\_20M\_QPSK\_1RB\_1Offset\_Back\_5mm\_Ch166300

Communication System: UID 0, 5G NR (0); Frequency: 831.5 MHz; Duty Cycle: 1:1

Medium: HSL\_835 Medium parameters used:  $f = 831.5$  MHz;  $\sigma = 0.909$  S/m;  $\epsilon_r = 41.973$ ;  $\rho = 1000$  kg/m<sup>3</sup>

Ambient Temperature : 23.1 °C; Liquid Temperature : 22.5 °C

#### DASY5 Configuration:

- Probe: EX3DV4 - SN3826; ConvF(9.31, 9.31, 9.31); Calibrated: 2022/8/8
- Sensor-Surface: 1.4mm (Mechanical Surface Detection)
- Electronics: DAE4 Sn1303; Calibrated: 2022/11/24
- Phantom: SAM Twin Phantom; Type: SAM Twin; Serial: TP-1842
- Measurement SW: DASY52, Version 52.10 (4); SEMCAD X Version 14.6.14 (7501)

**Area Scan (71x141x1):** Interpolated grid: dx=1.500 mm, dy=1.500 mm

Maximum value of SAR (interpolated) = 1.14 W/kg

**Zoom Scan (5x5x7)/Cube 0:** Measurement grid: dx=8mm, dy=8mm, dz=5mm

Reference Value = 10.25 V/m; Power Drift = -0.07 dB

Peak SAR (extrapolated) = 1.81 W/kg

**SAR(1 g) = 0.803 W/kg; SAR(10 g) = 0.430 W/kg**

Maximum value of SAR (measured) = 1.42 W/kg

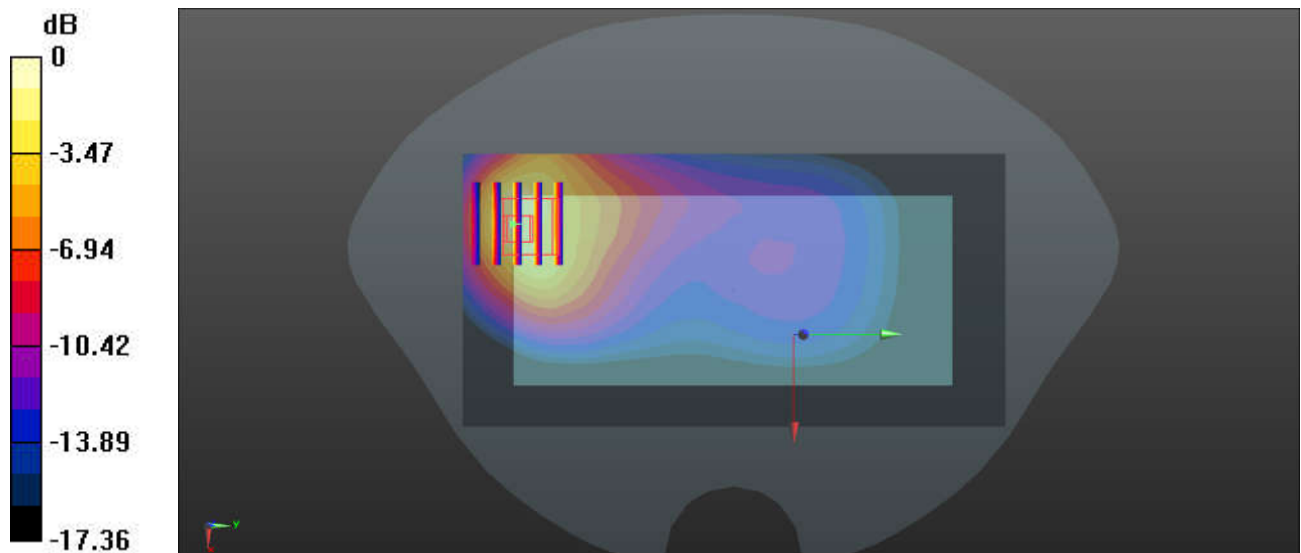

0 dB = 1.42 W/kg = 1.52 dBW/kg

### 82\_FR1 n5\_20M\_QPSK\_1RB\_1Offset\_Back\_5mm\_Ch167300

Communication System: UID 0, 5G NR (0); Frequency: 836.5 MHz; Duty Cycle: 1:1  
Medium: HSL\_835 Medium parameters used:  $f = 836.5$  MHz;  $\sigma = 0.913$  S/m;  $\epsilon_r = 41.948$ ;  $\rho = 1000$  kg/m<sup>3</sup>  
Ambient Temperature : 23.1 °C; Liquid Temperature : 22.5 °C

#### DASY5 Configuration:

- Probe: EX3DV4 - SN3826; ConvF(9.31, 9.31, 9.31); Calibrated: 2022/8/8
- Sensor-Surface: 1.4mm (Mechanical Surface Detection)
- Electronics: DAE4 Sn1303; Calibrated: 2022/11/24
- Phantom: SAM Twin Phantom; Type: SAM Twin; Serial: TP-1842
- Measurement SW: DASY52, Version 52.10 (4); SEMCAD X Version 14.6.14 (7501)

**Area Scan (71x141x1):** Interpolated grid: dx=1.500 mm, dy=1.500 mm  
Maximum value of SAR (interpolated) = 0.332 W/kg

**Zoom Scan (6x6x7)/Cube 0:** Measurement grid: dx=8mm, dy=8mm, dz=5mm  
Reference Value = 9.149 V/m; Power Drift = 0.01 dB  
Peak SAR (extrapolated) = 0.452 W/kg  
**SAR(1 g) = 0.236 W/kg; SAR(10 g) = 0.144 W/kg**  
Maximum value of SAR (measured) = 0.340 W/kg

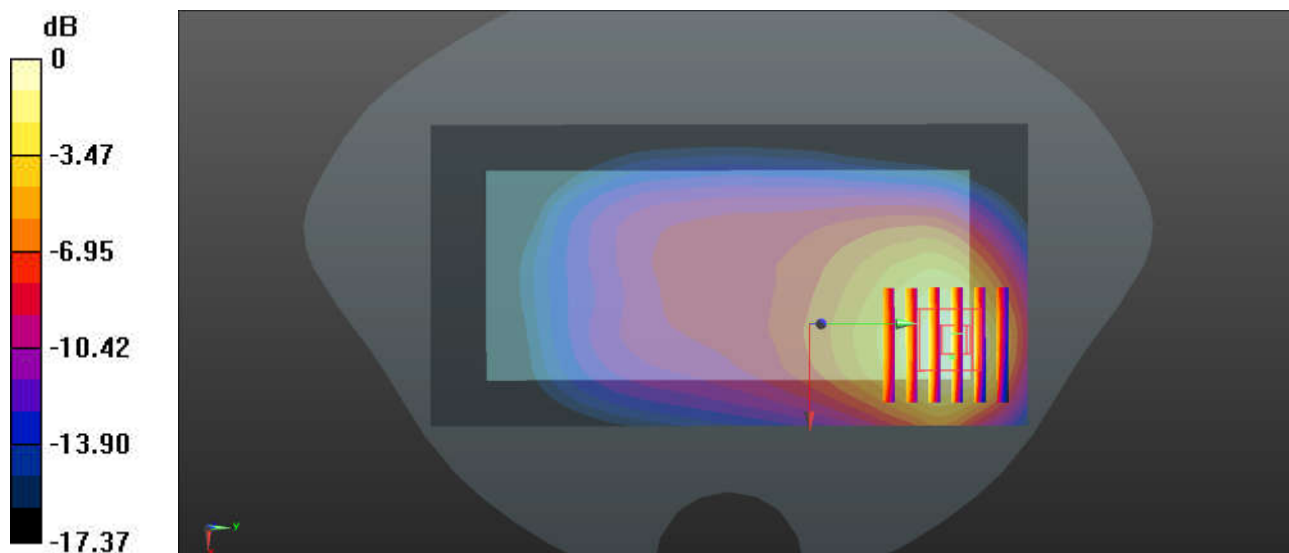

0 dB = 0.340 W/kg = -4.69 dBW/kg

### 83\_WCDMA IV\_RMC 12.2Kbps\_Back\_5mm\_Ch1312

Communication System: UID 0, WCDMA (0); Frequency: 1712.4 MHz; Duty Cycle: 1:1  
Medium: HSL\_1750 Medium parameters used:  $f = 1712.4$  MHz;  $\sigma = 1.373$  S/m;  $\epsilon_r = 40.584$ ;  $\rho = 1000$  kg/m<sup>3</sup>  
Ambient Temperature : 23.3 °C; Liquid Temperature : 22.9 °C

#### DASY5 Configuration:

- Probe: EX3DV4 - SN3826; ConvF(8.56, 8.56, 8.56); Calibrated: 2022/8/8
- Sensor-Surface: 1.4mm (Mechanical Surface Detection)
- Electronics: DAE4 Sn1303; Calibrated: 2022/11/24
- Phantom: SAM Twin Phantom; Type: SAM Twin; Serial: TP-1842
- Measurement SW: DASY52, Version 52.10 (4); SEMCAD X Version 14.6.14 (7501)

**Area Scan (81x81x1):** Interpolated grid: dx=1.500 mm, dy=1.500 mm  
Maximum value of SAR (interpolated) = 1.45 W/kg

**Zoom Scan (5x5x7)/Cube 0:** Measurement grid: dx=8mm, dy=8mm, dz=5mm  
Reference Value = 7.509 V/m; Power Drift = 0.09 dB  
Peak SAR (extrapolated) = 1.98 W/kg  
**SAR(1 g) = 0.983 W/kg; SAR(10 g) = 0.468 W/kg**  
Maximum value of SAR (measured) = 1.35 W/kg

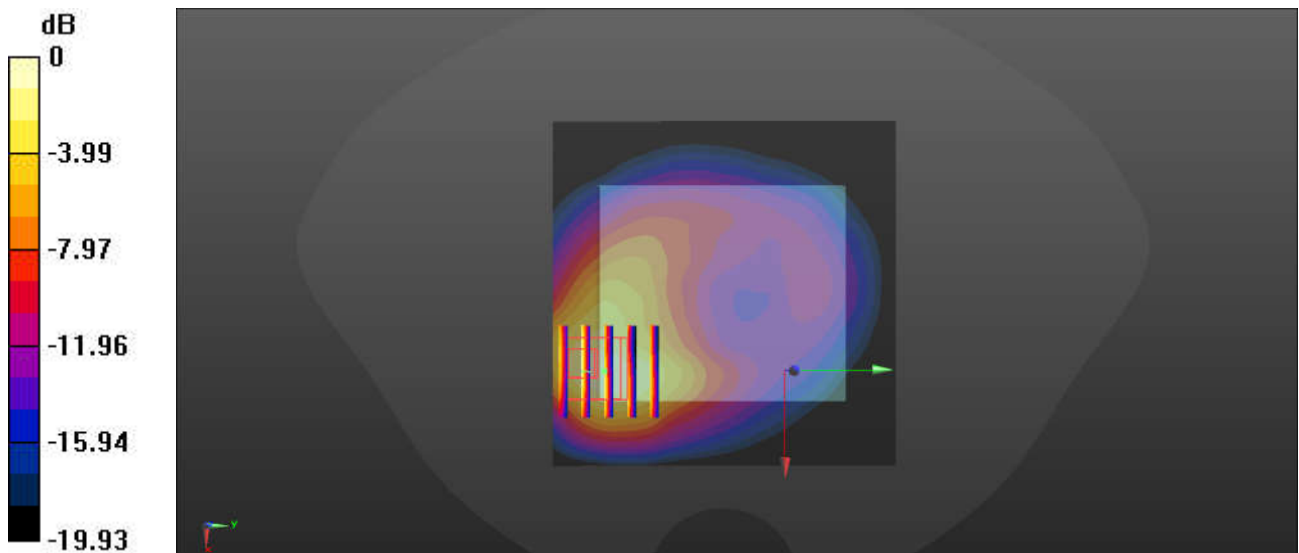

0 dB = 1.35 W/kg = 1.30 dBW/kg

### 84\_LTE Band 66\_20M\_QPSK\_1RB\_0Offset\_Front\_5mm\_Ch132322

Communication System: UID 0, LTE-FDD (0); Frequency: 1745 MHz; Duty Cycle: 1:1  
Medium: HSL\_1750 Medium parameters used:  $f = 1745$  MHz;  $\sigma = 1.311$  S/m;  $\epsilon_r = 40.238$ ;  $\rho = 1000$  kg/m<sup>3</sup>

Ambient Temperature : 23.1 °C; Liquid Temperature : 22.6 °C

#### DASY5 Configuration:

- Probe: EX3DV4 - SN3826; ConvF(8.56, 8.56, 8.56); Calibrated: 2022/8/8
- Sensor-Surface: 1.4mm (Mechanical Surface Detection)
- Electronics: DAE4 Sn1303; Calibrated: 2022/11/24
- Phantom: SAM Twin Phantom; Type: SAM Twin; Serial: TP-1842
- Measurement SW: DASY52, Version 52.10 (4); SEMCAD X Version 14.6.14 (7501)

**Area Scan (71x141x1):** Interpolated grid: dx=1.500 mm, dy=1.500 mm  
Maximum value of SAR (interpolated) = 1.44 W/kg

**Zoom Scan (6x5x7)/Cube 0:** Measurement grid: dx=8mm, dy=8mm, dz=5mm  
Reference Value = 9.608 V/m; Power Drift = 0.13 dB  
Peak SAR (extrapolated) = 1.63 W/kg  
**SAR(1 g) = 0.972 W/kg; SAR(10 g) = 0.618 W/kg**  
Maximum value of SAR (measured) = 1.34 W/kg

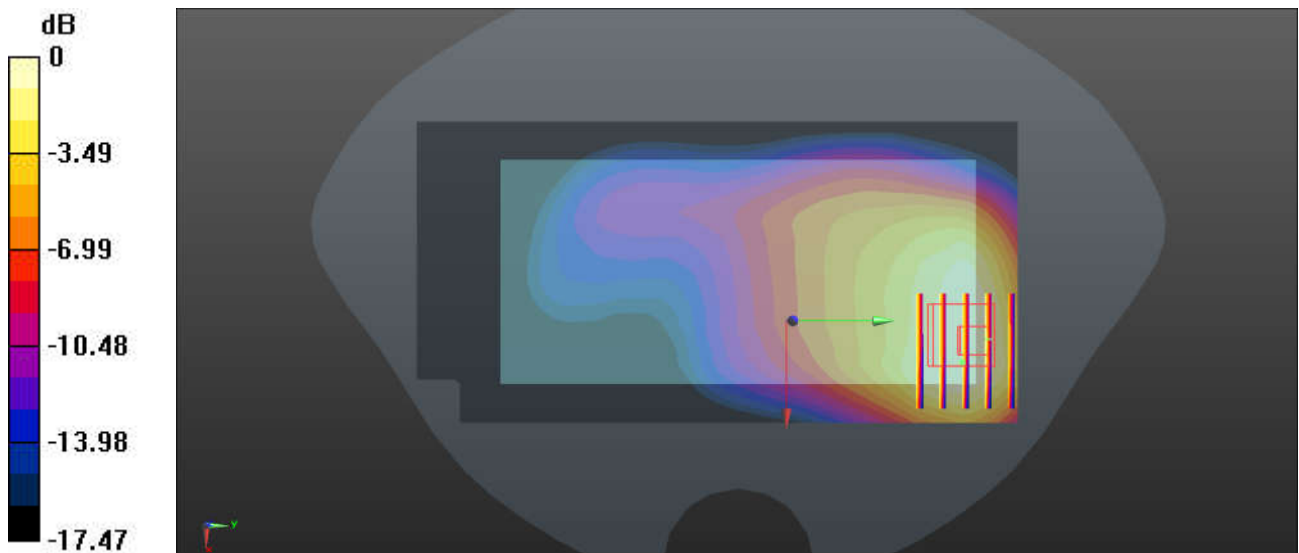

0 dB = 1.34 W/kg = 1.27 dBW/kg

### 85\_FR1 n66\_40M\_QPSK\_108RB\_54Offset\_Back\_5mm\_Ch349000

Communication System: UID 0, 5G NR (0); Frequency: 1745 MHz; Duty Cycle: 1:1  
Medium: HSL\_1750 Medium parameters used:  $f = 1745$  MHz;  $\sigma = 1.311$  S/m;  $\epsilon_r = 40.238$ ;  $\rho = 1000$  kg/m<sup>3</sup>  
Ambient Temperature : 23.1 °C; Liquid Temperature : 22.6 °C

#### DASY5 Configuration:

- Probe: EX3DV4 - SN3826; ConvF(8.56, 8.56, 8.56); Calibrated: 2022/8/8
- Sensor-Surface: 1.4mm (Mechanical Surface Detection)
- Electronics: DAE4 Sn1303; Calibrated: 2022/11/24
- Phantom: SAM Twin Phantom; Type: SAM Twin; Serial: TP-1842
- Measurement SW: DASY52, Version 52.10 (4); SEMCAD X Version 14.6.14 (7501)

**Area Scan (71x141x1):** Interpolated grid: dx=1.500 mm, dy=1.500 mm  
Maximum value of SAR (interpolated) = 1.58 W/kg

**Zoom Scan (5x5x7)/Cube 0:** Measurement grid: dx=8mm, dy=8mm, dz=5mm  
Reference Value = 2.739 V/m; Power Drift = 0.17 dB  
Peak SAR (extrapolated) = 2.16 W/kg  
**SAR(1 g) = 0.981 W/kg; SAR(10 g) = 0.450 W/kg**  
Maximum value of SAR (measured) = 1.82 W/kg

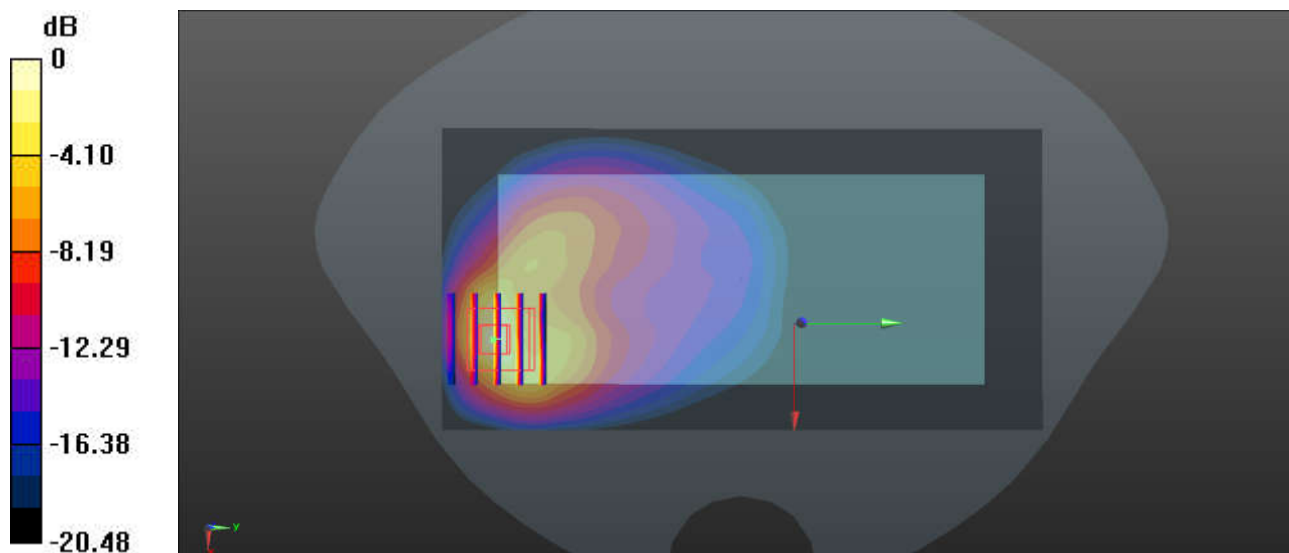

0 dB = 1.82 W/kg = 2.60 dBW/kg



### 86\_FR1 n70\_15M\_QPSK\_36RB\_22Offset\_Back\_5mm\_Ch340500

Communication System: UID 0, 5G NR (0); Frequency: 1702.5 MHz; Duty Cycle: 1:1  
Medium: HSL\_1750 Medium parameters used:  $f = 1702.5$  MHz;  $\sigma = 1.292$  S/m;  $\epsilon_r = 40.499$ ;  $\rho = 1000$  kg/m<sup>3</sup>  
Ambient Temperature : 23.1 °C; Liquid Temperature : 22.6 °C

#### DASY5 Configuration:

- Probe: EX3DV4 - SN3826; ConvF(8.56, 8.56, 8.56); Calibrated: 2022/8/8
- Sensor-Surface: 1.4mm (Mechanical Surface Detection)
- Electronics: DAE4 Sn1303; Calibrated: 2022/11/24
- Phantom: SAM Twin Phantom; Type: SAM Twin; Serial: TP-1842
- Measurement SW: DASY52, Version 52.10 (4); SEMCAD X Version 14.6.14 (7501)

**Area Scan (71x141x1):** Interpolated grid: dx=1.500 mm, dy=1.500 mm  
Maximum value of SAR (interpolated) = 0.886 W/kg

**Zoom Scan (5x5x7)/Cube 0:** Measurement grid: dx=8mm, dy=8mm, dz=5mm  
Reference Value = 4.812 V/m; Power Drift = 0.19 dB  
Peak SAR (extrapolated) = 1.54 W/kg  
**SAR(1 g) = 0.736 W/kg; SAR(10 g) = 0.342 W/kg**  
Maximum value of SAR (measured) = 1.09 W/kg

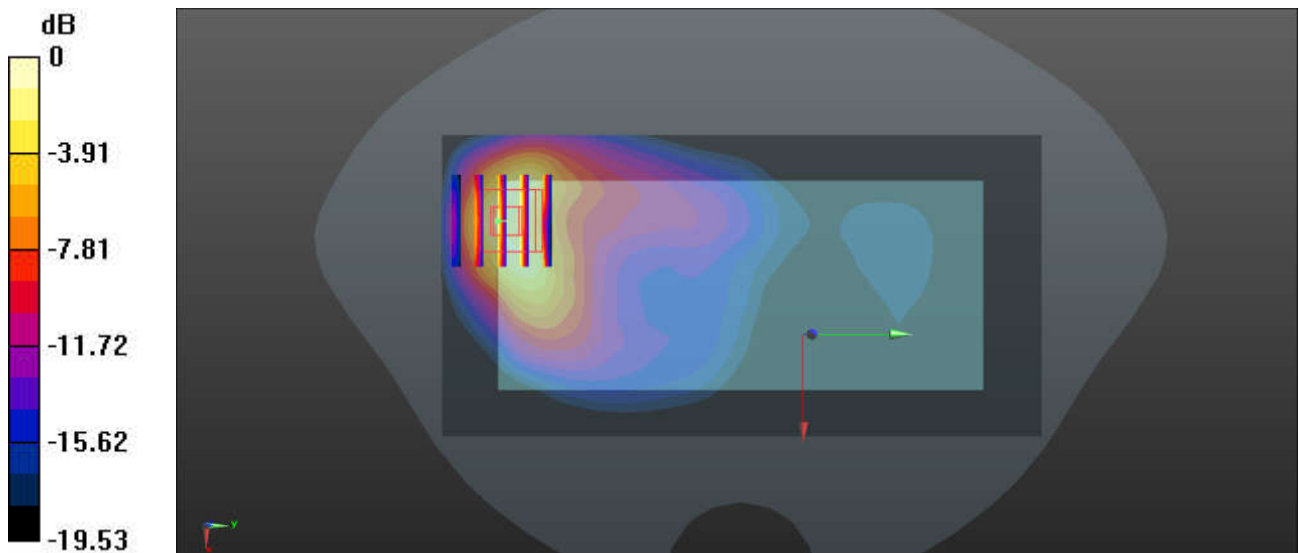

0 dB = 1.09 W/kg = 0.37 dBW/kg

### 87\_GSM1900\_GPRS (3 Tx slots)\_Front\_5mm\_Ch661

Communication System: UID 0, PCS (0); Frequency: 1880 MHz; Duty Cycle: 1:2.77

Medium: HSL\_1900 Medium parameters used:  $f = 1880$  MHz;  $\sigma = 1.406$  S/m;  $\epsilon_r = 40.168$ ;  $\rho = 1000$  kg/m<sup>3</sup>

Ambient Temperature : 23.2 °C; Liquid Temperature : 22.8 °C

#### DASY5 Configuration:

- Probe: EX3DV4 - SN3826; ConvF(8.24, 8.24, 8.24); Calibrated: 2022/8/8
- Sensor-Surface: 1.4mm (Mechanical Surface Detection)
- Electronics: DAE4 Sn1303; Calibrated: 2022/11/24
- Phantom: SAM Twin Phantom; Type: SAM Twin; Serial: TP-1842
- Measurement SW: DASY52, Version 52.10 (4); SEMCAD X Version 14.6.14 (7501)

**Area Scan (81x131x1):** Interpolated grid: dx=1.500 mm, dy=1.500 mm

Maximum value of SAR (interpolated) = 1.45 W/kg

**Zoom Scan (7x6x7)/Cube 0:** Measurement grid: dx=8mm, dy=8mm, dz=5mm

Reference Value = 9.425 V/m; Power Drift = 0.04 dB

Peak SAR (extrapolated) = 1.52 W/kg

**SAR(1 g) = 0.897 W/kg; SAR(10 g) = 0.575 W/kg**

Maximum value of SAR (measured) = 1.24 W/kg

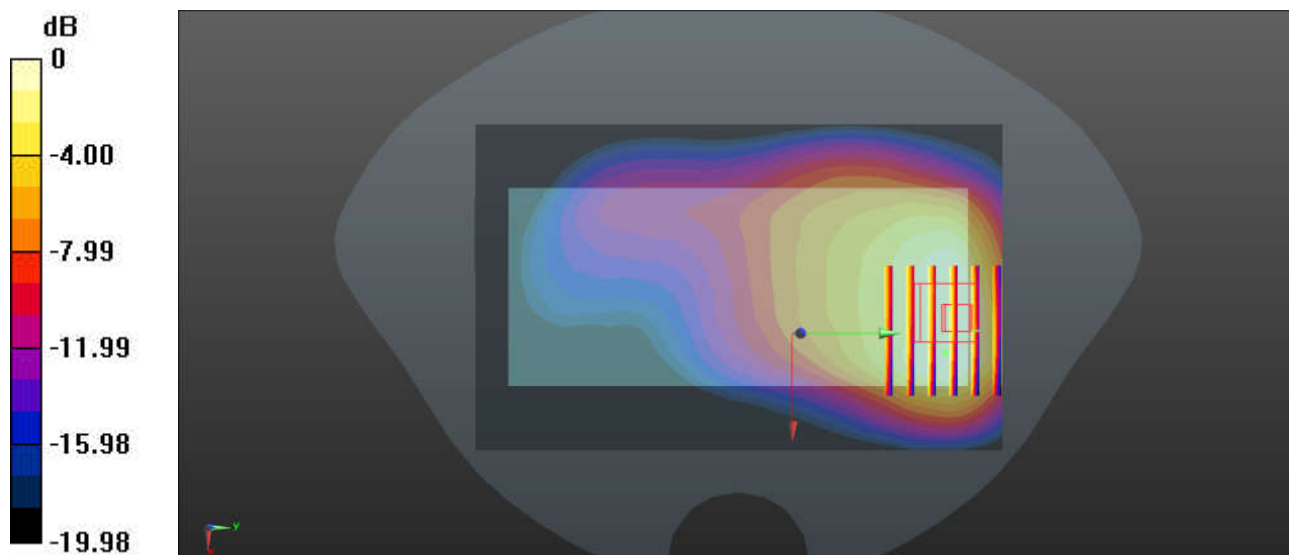

0 dB = 1.24 W/kg = 0.93 dBW/kg

### 88\_WCDMA II\_RMC 12.2Kbps\_Back\_5mm\_Ch9400

Communication System: UID 0, WCDMA (0); Frequency: 1880 MHz; Duty Cycle: 1:1  
Medium: HSL\_1900 Medium parameters used:  $f = 1880$  MHz;  $\sigma = 1.446$  S/m;  $\epsilon_r = 39.827$ ;  $\rho = 1000$  kg/m<sup>3</sup>

Ambient Temperature : 23.3 °C; Liquid Temperature : 22.8 °C

#### DASY5 Configuration:

- Probe: EX3DV4 - SN3826; ConvF(8.24, 8.24, 8.24); Calibrated: 2022/8/8
- Sensor-Surface: 1.4mm (Mechanical Surface Detection)
- Electronics: DAE4 Sn1303; Calibrated: 2022/11/24
- Phantom: SAM Twin Phantom; Type: SAM Twin; Serial: TP-1842
- Measurement SW: DASY52, Version 52.10 (4); SEMCAD X Version 14.6.14 (7501)

**Area Scan (81x91x1):** Interpolated grid: dx=1.500 mm, dy=1.500 mm  
Maximum value of SAR (interpolated) = 0.880 W/kg

**Zoom Scan (6x6x7)/Cube 0:** Measurement grid: dx=8mm, dy=8mm, dz=5mm  
Reference Value = 7.700 V/m; Power Drift = 0.09 dB  
Peak SAR (extrapolated) = 1.78 W/kg  
**SAR(1 g) = 0.903 W/kg; SAR(10 g) = 0.391 W/kg**  
Maximum value of SAR (measured) = 1.08 W/kg

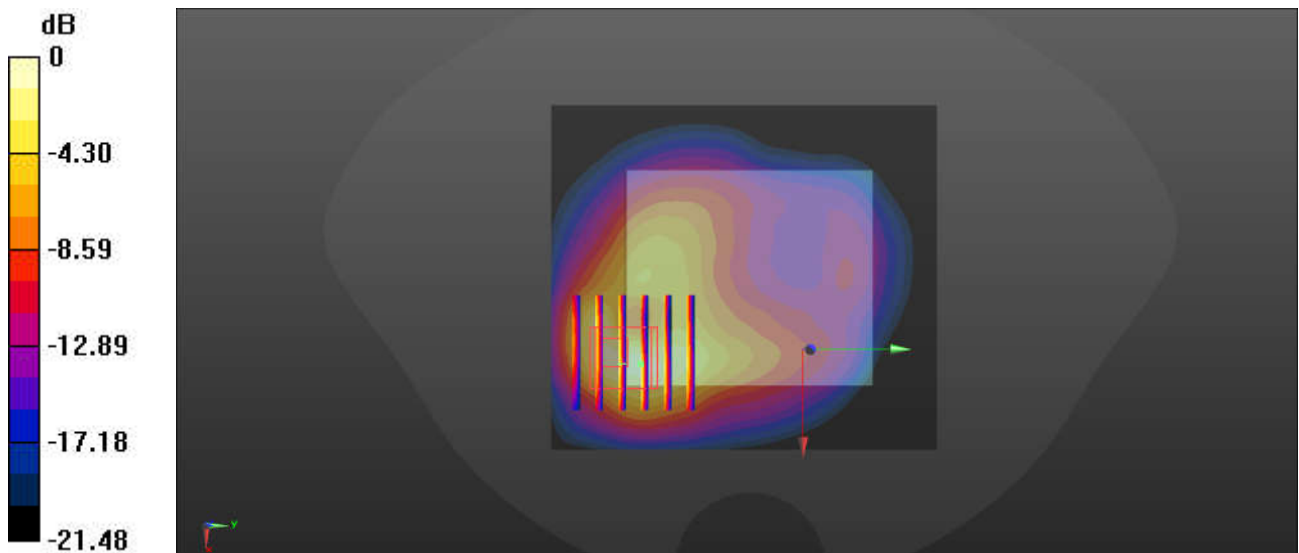

0 dB = 1.08 W/kg = 0.33 dBW/kg

### 89\_LTE Band 25\_20M\_QPSK\_1RB\_0Offset\_Front\_5mm\_Ch26340

Communication System: UID 0, LTE-FDD (0); Frequency: 1880 MHz; Duty Cycle: 1:1  
Medium: HSL\_1900 Medium parameters used:  $f = 1880$  MHz;  $\sigma = 1.446$  S/m;  $\epsilon_r = 39.827$ ;  $\rho = 1000$  kg/m<sup>3</sup>

Ambient Temperature : 23.3 °C; Liquid Temperature : 22.8 °C

#### DASY5 Configuration:

- Probe: EX3DV4 - SN3826; ConvF(8.24, 8.24, 8.24); Calibrated: 2022/8/8
- Sensor-Surface: 1.4mm (Mechanical Surface Detection)
- Electronics: DAE4 Sn1303; Calibrated: 2022/11/24
- Phantom: SAM Twin Phantom; Type: SAM Twin; Serial: TP-1842
- Measurement SW: DASY52, Version 52.10 (4); SEMCAD X Version 14.6.14 (7501)

**Area Scan (81x81x1):** Interpolated grid: dx=1.500 mm, dy=1.500 mm

Maximum value of SAR (interpolated) = 1.13 W/kg

**Zoom Scan (6x5x7)/Cube 0:** Measurement grid: dx=8mm, dy=8mm, dz=5mm

Reference Value = 19.42 V/m; Power Drift = 0.08 dB

Peak SAR (extrapolated) = 1.51 W/kg

**SAR(1 g) = 0.944 W/kg; SAR(10 g) = 0.577 W/kg**

Maximum value of SAR (measured) = 1.10 W/kg

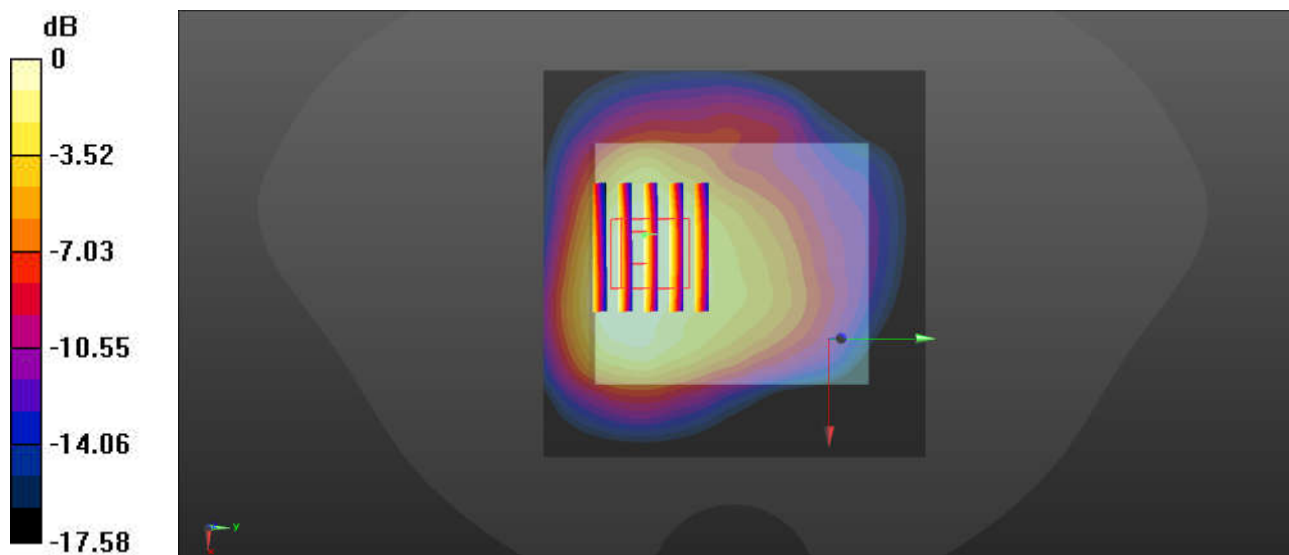

**90\_FR1 n25\_40M\_QPSK\_108RB\_54Offset\_Back\_5mm\_Ch376500**

Communication System: UID 0, 5G NR (0); Frequency: 1882.5 MHz; Duty Cycle: 1:1  
Medium: HSL\_1900 Medium parameters used:  $f = 1882.5$  MHz;  $\sigma = 1.407$  S/m;  $\epsilon_r = 40.181$ ;  $\rho = 1000$  kg/m<sup>3</sup>  
Ambient Temperature : 23.2 °C; Liquid Temperature : 22.8 °C

**DASY5 Configuration:**

- Probe: EX3DV4 - SN3826; ConvF(8.24, 8.24, 8.24); Calibrated: 2022/8/8
- Sensor-Surface: 1.4mm (Mechanical Surface Detection)
- Electronics: DAE4 Sn1303; Calibrated: 2022/11/24
- Phantom: SAM Twin Phantom; Type: SAM Twin; Serial: TP-1842
- Measurement SW: DASY52, Version 52.10 (4); SEMCAD X Version 14.6.14 (7501)

**Area Scan (71x141x1):** Interpolated grid: dx=1.500 mm, dy=1.500 mm  
Maximum value of SAR (interpolated) = 1.63 W/kg

**Zoom Scan (6x6x7)/Cube 0:** Measurement grid: dx=8mm, dy=8mm, dz=5mm  
Reference Value = 12.29 V/m; Power Drift = 0.16 dB  
Peak SAR (extrapolated) = 1.81 W/kg  
**SAR(1 g) = 0.954 W/kg; SAR(10 g) = 0.389 W/kg**  
Maximum value of SAR (measured) = 1.49 W/kg

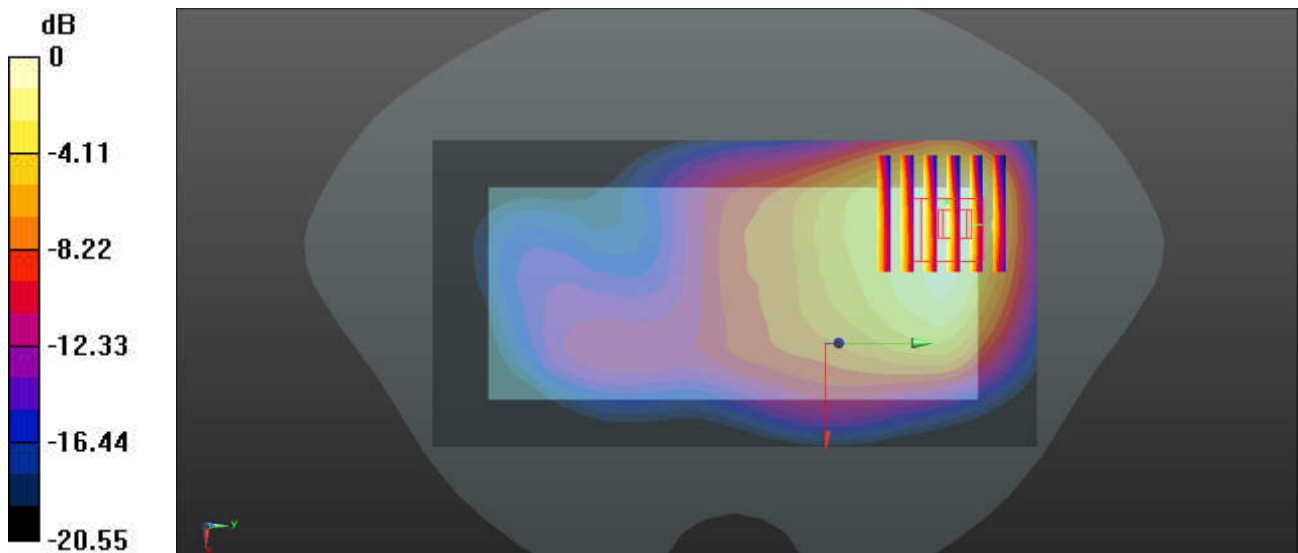

0 dB = 1.49 W/kg = 1.73 dBW/kg