



FCC RF Test Report

APPLICANT : Motorola Mobility LLC
EQUIPMENT : Mobile Cellular Phone
BRAND NAME : Motorola
MODEL NAME : XT2321-3, XT2321-5
FCC ID : IHDT56AJ3
STANDARD : 47 CFR Part 2, 27 Subpart O
CLASSIFICATION : PCS Licensed Transmitter Held to Ear (PCE)
TEST DATE(S) : Dec. 22, 2022 ~ Jan. 12, 2023

We, Sporton International Inc. (ShenZhen), would like to declare that the tested sample has been evaluated in accordance with the procedures given in ANSI C63.26-2015 and shown compliance with the applicable technical standards.

The test results in this report apply exclusively to the tested model / sample. Without written approval of Sporton International Inc. (ShenZhen), the test report shall not be reproduced except in full.

Jason Jia



Approved by: Jason Jia

Sporton International Inc. (ShenZhen)

1/F, 2/F, Bldg 5, Shiling Industrial Zone, Xinwei Village, Xili, Nanshan, Shenzhen, 518055

People's Republic of China



TABLE OF CONTENTS

REVISION HISTORY...3
SUMMARY OF TEST RESULT...4
1 GENERAL DESCRIPTION...5
1.1 Applicant...5
1.2 Manufacturer...5
1.3 Product Feature of Equipment Under Test...5
1.4 Product Specification of Equipment Under Test...5
1.5 Modification of EUT...6
1.6 Specification of Accessory...6
1.7 Maximum EIRP and Emission Designator...7
1.8 Testing Location...9
1.9 Test Software...9
1.10 Applicable Standards...9
2 TEST CONFIGURATION OF EQUIPMENT UNDER TEST...10
2.1 Test Mode...10
2.2 Connection Diagram of Test System...11
2.3 Support Unit used in test configuration and system...11
2.4 Measurement Results Explanation Example...11
2.5 Frequency List of Low/Middle/High Channels...12
3 CONDUCTED TEST ITEMS...14
3.1 Measuring Instruments...14
3.2 Test Setup...14
3.3 Test Result of Conducted Test...14
3.4 Conducted Output Power and EIRP...15
3.5 Peak-to-Average Ratio...16
3.6 Occupied Bandwidth...17
3.7 Conducted Band Edge...18
3.8 Conducted Spurious Emission...19
3.9 Frequency Stability...20
4 RADIATED TEST ITEMS...21
4.1 Measuring Instruments...21
4.2 Test Setup...21
4.3 Test Result of Radiated Test...22
4.4 Radiated Spurious Emission...23
5 LIST OF MEASURING EQUIPMENT...24
6 UNCERTAINTY OF EVALUATION...25
APPENDIX A. TEST RESULTS OF CONDUCTED TEST
APPENDIX B. TEST RESULTS OF RADIATED TEST
APPENDIX C. TEST SETUP PHOTOGRAPHS



SUMMARY OF TEST RESULT

Report Section	FCC Rule	Description	Limit	Result	Remark
3.4	§2.1046	Conducted Output Power	Reporting Only	PASS	-
	§27.50(j)(3)	Equivalent Isotropic Radiated Power (5G NR n77, n78)	EIRP < 1Watt		
3.5	§27.50(j)(4)	Peak-to-Average Ratio	<13 dB	PASS	-
3.6	§2.1049	Occupied Bandwidth	Reporting Only	PASS	-
3.7	§2.1051 §27.53(l)(2)	Conducted Band Edge Measurement (5G NR n77)	< 43+10log ₁₀ (P[Watts])	PASS	-
3.8	§2.1051 §27.53(l)(2)	Conducted Spurious Emission (5G NR n77)	< 43+10log ₁₀ (P[Watts])	PASS	-
3.9	§27.54	Frequency Stability Temperature & Voltage	Within Authorized Band	PASS	-
4.4	§2.1053 §27.53(l)(2)	Radiated Spurious Emission (5G NR n77)	< 43+10log ₁₀ (P[Watts])	PASS	Under limit 17.13 dB at 9240.000 MHz

Declaration of Conformity:
The test results with all measurement uncertainty excluded are presented in accordance with the regulation limits or requirements declared by manufacturers.
Comments and Explanations:
The declared of product specification for EUT presented in the report are provided by the manufacturer, and the manufacturer takes all the responsibilities for the accuracy of product specification.



1 General Description

1.1 Applicant

Motorola Mobility LLC
222 W, Merchandise Mart Plaza, Chicago IL 60654 USA

1.2 Manufacturer

Motorola Mobility LLC
222 W, Merchandise Mart Plaza, Chicago IL 60654 USA

1.3 Product Feature of Equipment Under Test

Product Feature	
Equipment	Mobile Cellular Phone
Brand Name	Motorola
Model Name	XT2321-3, XT2321-5
FCC ID	IHDT56AJ3
IMEI Code	Conducted : 358041760020174 Radiation : 358041760025637/358041760025645
HW Version	DVT2
SW Version	TTZ 33.50
EUT Stage	Identical Prototype

Remark: The two model names XT2321-3, XT2321-5 are the same product except model name different for market segment.

1.4 Product Specification of Equipment Under Test

Standards-related Product Specification	
Tx/Rx Frequency	5G NR n77: 3700 MHz ~ 3980 MHz 5G NR n78: 3700 MHz ~ 3800 MHz
SCS	30kHz
Bandwidth	10 / 15 / 20 / 30 / 40 / 50 / 60 / 70 / 80 / 90 / 100MHz
Antenna Gain	Ant. 0: 5G NR n77: -10.26 dBi 5G NR n78: -10.26 dBi Ant. 1: 5G NR n77: -8.68 dBi 5G NR n78: -9.62 dBi Ant. 2: 5G NR n77: -6.68 dBi 5G NR n78: -6.68 dBi Ant. 3: 5G NR n77: -6.76 dBi 5G NR n78: -6.76 dBi
Type of Modulation	CP-OFDM: QPSK / 16QAM / 64QAM / 256QAM DFT-s-OFDM: PI/2 BPSK / QPSK / 16QAM / 64QAM / 256QAM



Remark:

1. The maximum EIRP is calculated from max output power and max antenna gain, only the maximum EIRP is shown in the report, 5G NR n77/n78 for Antenna 3.
2. The device supports n77/n78(1T4R) SRS resources on Antenna 0/1/2/3, only the test data of worst Antenna 3 is showed in the report according to the maximum power.
3. 5G NR n77/n78 support SA and NSA mode. The whole testing has assessed SA mode by referring to the higher conducted power for conducted test items.
4. 5G NR Band n77 overlaps the entire frequency range of Band n78, and n77 power > n78 power, therefore the conducted test results of n77 provided in this report cover n78.
5. The device supports HPUE mode for 5G NR n77/n78 single carrier.
6. 5G NR n77/n78 support UL MIMO mode, 5G NR n77 for Power class 1.5 and n78 for Power class 2.
7. 5G NR n77/n78 support UL MIMO mode, only the worst test data of Ant(2+3) is shown in the report.
8. The UL_MIMO mode of 5G NR n77/n78 is completely uncorrelated, so the directional gain is selected the maximum gain among all antennas.
9. 5G NR n78 UL_MIMO mode only supports CP-OFDM Modulation.
10. For UL MIMO mode, the conducted BE/Spurious are tested at single antenna port and add 10*log(NANT) according to KDB 662911 D01.
11. The device supports two PAs for 5G NR n77(main PA for Ant.3 and other PA for Ant .2), the maximum power of Main PA is higher than the other PA, therefore, we chose higher power to calculate the EIRP and show in the report.
12. For 5G NR n77/n78, all the supported EN-DC combinations are verified conducted power, only the EN-DC combination with highest power are shown in the report.
13. The EN-DC mode combination could be referred to the product spec.
14. The EUT has two working states, flip open state and flip close state, by verifying these two states, we choose the worst flip open state for all tests.

1.5 Modification of EUT

No modifications are made to the EUT during all test items.

1.6 Specification of Accessory

Specification of Accessory				
AC Adapter	Brand Name	Motorola(Salom)	Model Name	MC-301
Battery	Brand Name	Motorola(ATL)	Model Name	PM29
USB Cable 1	Brand Name	Motorola(Cabletech)	Model Name	SC18D13216
USB Cable 2	Brand Name	Motorola(Luxshare)	Model Name	SC18D13217
USB Cable 3	Brand Name	Motorola(Saibao)	Model Name	SC18D86732



1.7 Maximum EIRP and Emission Designator

5G NR n77 SA		PI/2 BPSK / QPSK		16QAM / 64QAM / 256QAM	
BW (MHz)	Frequency Range (MHz)	Maximum EIRP(W)	Emission Designator (99%OBW)	Maximum EIRP(W)	Emission Designator (99%OBW)
10	3705.00 ~ 3975.00	0.1045	8M59G7D	0.0859	8M60W7D
15	3705.52 ~ 3972.48	0.1038	13M6G7D	0.0762	13M6W7D
20	3710.01 ~ 3969.99	0.1042	18M2G7D	0.0839	18M3W7D
30	3715.02 ~ 3964.98	0.1019	27M9G7D	0.0828	27M9W7D
40	3720.00 ~ 3960.00	0.1005	37M9G7D	0.0853	37M9W7D
50	3725.01 ~ 3954.99	0.1028	47M5G7D	0.0863	47M5W7D
60	3730.02 ~ 3949.98	0.1035	58M0G7D	0.0883	57M9W7D
70	3735.00 ~ 3945.00	0.1005	67M6G7D	0.0807	67M5W7D
80	3740.01 ~ 3939.99	0.1026	77M7G7D	0.0813	77M7W7D
90	3745.02 ~ 3934.98	0.1023	87M4G7D	0.0822	87M6W7D
100	3750.00 ~ 3930.00	0.1052	97M5G7D	0.0721	97M5W7D

5G NR n78 SA		PI/2 BPSK / QPSK		16QAM / 64QAM / 256QAM	
BW (MHz)	Frequency Range (MHz)	Maximum EIRP(W)	Emission Designator (99%OBW)	Maximum EIRP(W)	Emission Designator (99%OBW)
10	3705.00 ~ 3795.00	0.0986	8M59G7D	0.0813	8M60W7D
15	3707.52 ~ 3792.48	0.0991	13M6G7D	0.0826	13M6W7D
20	3710.01 ~ 3789.99	0.0975	18M2G7D	0.0794	18M3W7D
30	3715.02 ~ 3784.98	0.1007	27M9G7D	0.0828	27M9W7D
40	3720.00 ~ 3780.00	0.0979	37M9G7D	0.0809	37M9W7D
50	3725.01 ~ 3774.99	0.0993	47M5G7D	0.0828	47M5W7D
60	3730.02 ~ 3769.98	0.0998	58M0G7D	0.0780	57M9W7D
70	3735.00 ~ 3765.00	0.1019	67M6G7D	0.0855	67M5W7D
80	3740.01 ~ 3759.99	0.1033	77M7G7D	0.0853	77M7W7D
90	3745.02 ~ 3754.98	0.1014	87M4G7D	0.0853	87M6W7D
100	3750.00	0.1042	97M5G7D	0.0760	97M5W7D



5G NR n77 UL MIMO		PI/2 BPSK / QPSK		16QAM / 64QAM / 256QAM	
BW (MHz)	Frequency Range (MHz)	Maximum EIRP(W)	Emission Designator (99%OBW)	Maximum EIRP(W)	Emission Designator (99%OBW)
10	3705.00 ~ 3975.00	0.1754	8M59G7D	0.1358	8M62W7D
15	3705.52 ~ 3972.48	0.1841	13M6G7D	0.1445	13M6W7D
20	3710.01 ~ 3969.99	0.1854	18M2G7D	0.1445	18M2W7D
30	3715.02 ~ 3964.98	0.1849	27M9G7D	0.1442	27M9W7D
40	3720.00 ~ 3960.00	0.1828	37M8G7D	0.1483	37M8W7D
50	3725.01 ~ 3954.99	0.1820	47M6G7D	0.1432	47M5W7D
60	3730.02 ~ 3949.98	0.1795	57M9G7D	0.1371	58M0W7D
70	3735.00 ~ 3945.00	0.1766	67M5G7D	0.1346	67M6W7D
80	3740.01 ~ 3939.99	0.1726	77M5G7D	0.1358	77M5W7D
90	3745.02 ~ 3934.98	0.1726	87M4G7D	0.1352	87M7W7D
100	3750.00 ~ 3930.00	0.1884	97M6G7D	0.1476	97M5W7D

5G NR n78 UL MIMO		QPSK		16QAM / 64QAM / 256QAM	
BW (MHz)	Frequency Range (MHz)	Maximum EIRP(W)	Emission Designator (99%OBW)	Maximum EIRP(W)	Emission Designator (99%OBW)
10	3705.00 ~ 3795.00	0.0693	8M59G7D	0.0604	8M62W7D
15	3707.52 ~ 3792.48	0.0718	13M6G7D	0.0634	13M6W7D
20	3710.01 ~ 3789.99	0.0716	18M2G7D	0.0621	18M2W7D
30	3715.02 ~ 3784.98	0.0740	27M9G7D	0.0644	27M9W7D
40	3720.00 ~ 3780.00	0.0752	37M8G7D	0.0647	37M8W7D
50	3725.01 ~ 3774.99	0.0706	47M6G7D	0.0608	47M5W7D
60	3730.02 ~ 3769.98	0.0681	57M9G7D	0.0600	58M0W7D
70	3735.00 ~ 3765.00	0.0685	67M5G7D	0.0597	67M6W7D
80	3740.01 ~ 3759.99	0.0668	77M5G7D	0.0583	77M5W7D
90	3745.02 ~ 3754.98	0.0670	87M4G7D	0.0585	87M7W7D
100	3750.00	0.0755	97M6G7D	0.0597	97M5W7D

Note:

- 5G NR Band n77 overlaps the entire frequency range of Band n78, and n77 power > n78 power, therefore the conducted test results of n77 provided in this report cover n78.
- All modulations have been tested, and only the worst test results of PSK & QAM are shown in the report.



1.8 Testing Location

Sporton International Inc. (Shenzhen) is accredited to ISO/IEC 17025:2017 by American Association for Laboratory Accreditation with Certificate Number 5145.01.

Test Firm	Sporton International Inc. (Shenzhen)		
Test Site Location	1/F, 2/F, Bldg 5, Shiling Industrial Zone, Xinwei Village, Xili, Nanshan, Shenzhen, 518055 People's Republic of China TEL: +86-755-86379589 FAX: +86-755-86379595		
Test Site No.	Sporton Site No.	FCC Designation No.	FCC Test Firm Registration No.
	TH01-SZ	CN1256	421272

Test Firm	Sporton International Inc. (Shenzhen)		
Test Site Location	101, 1st Floor, Block B, Building 1, No. 2, Tengfeng 4th Road, Fenghuang Community, Fuyong Street, Baoan District, Shenzhen City Guangdong Province China 518103 TEL: +86-755-33202398		
Test Site No.	Sporton Site No.	FCC Designation No.	FCC Test Firm Registration No.
	03CH01-SZ	CN1256	421272

1.9 Test Software

Item	Site	Manufacturer	Name	Version
1.	03CH01-SZ	AUDIX	E3	6.2009-8-24

1.10 Applicable Standards

According to the specifications of the manufacturer, the EUT must comply with the requirements of the following standards:

- 47 CFR Part 2, 27O
- ANSI C63.26-2015
- FCC KDB 971168 D01 Power Meas License Digital Systems v03r01
- FCC KDB 412172 D01 Determining ERP and EIRP v01r01

Remark: All test items were verified and recorded according to the standards and without any deviation during the test.



2 Test Configuration of Equipment Under Test

2.1 Test Mode

Antenna port conducted and radiated test items are performed according to KDB 971168 D01 Power Meas License Digital Systems v03r01 with maximum output power.

For radiated measurement, pre-scanned in three orthogonal panels, X, Y, Z. The worst cases (Y plane) were recorded in this report.

The device is investigated from 30MHz to 10 times of fundamental signal for radiated spurious emission test under different RB size/offset and modulations in exploratory test. Subsequently, only the worst case emissions are reported.

Orthogonal Planes of EUT	X Plane	Y Plane	Z Plane
			

Test Items	5G NR	Bandwidth (MHz)									Modulation					RB #		Test Channel			
		10	15	20	25	30	40	50	60-90	100	PI/2 BPSK	QPSK	16QAM	64QAM	256 QAM	1	Full	L	M	H	
Max. Output Power	n77	v	v	v	-	v	v	v	v	v	v	v	v	v	v	v	v	v	v	v	v
	n78	v	v	v	-	v	v	v	v	v	v	v	v	v	v	v	v	v	v	v	v
Peak-to-Average Ratio	n77			v	-						v	v				v	v	v	v	v	
26dB and 99% Bandwidth	n77	v	v	v	-	v	v	v	v	v	v	v	v	v	v		v		v		
Conducted Band Edge	n77	v			-			v		v	v	v				v	v	v		v	
Conducted Spurious Emission	n77	v			-			v		v	v					v		v	v	v	
Frequency Stability	n77			v	-							v					v		v		
E.I.R.P.	n77	v	v	v	-	v	v	v	v	v	v	v	v	v	v	v	v	v	v	v	
	n78	v	v	v	-	v	v	v	v	v	v	v	v	v	v	v	v	v	v	v	
Radiated Spurious Emission	n77	Worst Case															v	v	v		
Note	1. The mark "v" means that this configuration is chosen for testing 2. The mark "-" means that this bandwidth is not supported. 3. The device is investigated from 30MHz to 10 times of fundamental signal for radiated spurious emission test under different RB size/offset and modulations in exploratory test. Subsequently, only the worst case emissions are reported. 4. Frequency Stability : Normal Voltage = 3.91V ; Low Voltage =3.40V. ; High Voltage =4.50V																				

2.2 Connection Diagram of Test System

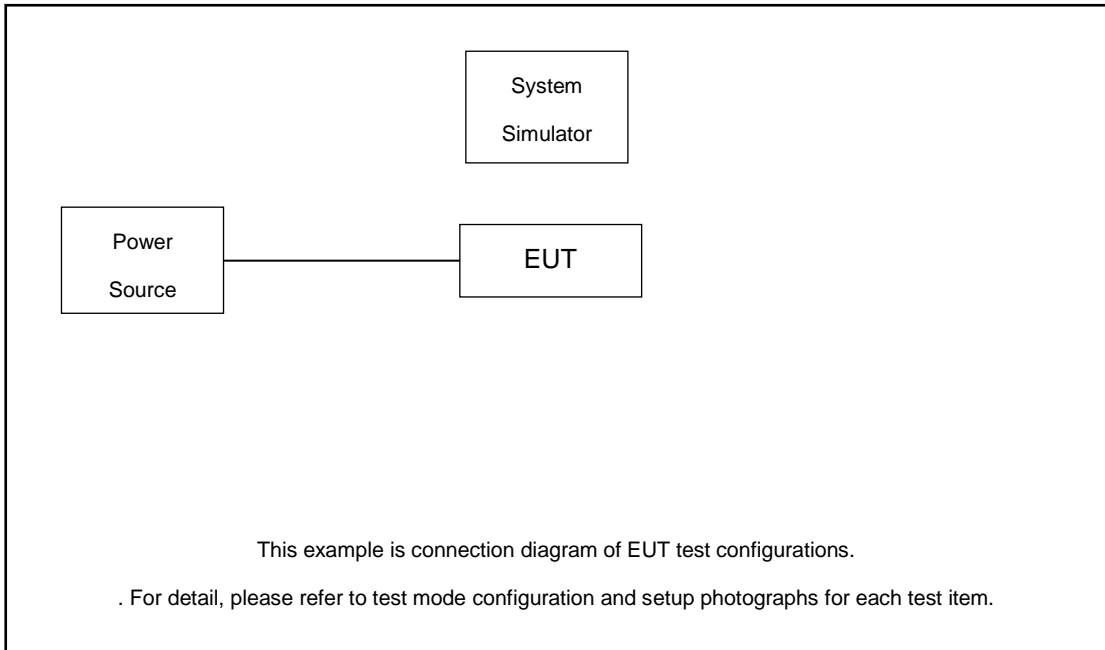

2.3 Support Unit used in test configuration and system

Item	Equipment	Trade Name	Model No.	FCC ID	Data Cable	Power Cord
1.	DC Power Supply	GW	GPS-3030D	N/A	N/A	Unshielded, 1.8 m
2.	LTE Base Station	Anritsu	MT8821C	N/A	N/A	Unshielded, 1.8 m
3.	NR Base Station	Anritsu	MT8000A	N/A	N/A	Unshielded, 1.8 m

2.4 Measurement Results Explanation Example

For all conducted test items:

The offset level is set in the spectrum analyzer to compensate the RF cable loss between EUT conducted output port and spectrum analyzer. With the offset compensation, the spectrum analyzer reading level is exactly the EUT RF output level.

The spectrum analyzer offset is derived from RF cable loss.

$$\text{Offset} = \text{RF cable loss.}$$

Following shows an offset computation example with cable loss 8.7 dB.

Example :

$$\begin{aligned} \text{Offset(dB)} &= \text{RF cable loss(dB)}. \\ &= 8.7 \text{ (dB)} \end{aligned}$$



2.5 Frequency List of Low/Middle/High Channels

5G n77 Channel and Frequency List				
BW [MHz]	Channel/Frequency(MHz)	Lowest	Middle	Highest
100	Channel	650000	656000	662000
	Frequency	3750	3840	3930
90	Channel	649668	656000	662332
	Frequency	3745.02	3840	3934.98
80	Channel	649334	656000	662666
	Frequency	3740.01	3840	3939.99
70	Channel	649000	656000	663000
	Frequency	3735	3840	3945
60	Channel	648668	656000	663332
	Frequency	3730.02	3840	3949.98
50	Channel	648334	656000	663666
	Frequency	3725.01	3840	3954.99
40	Channel	648000	656000	664000
	Frequency	3720	3840	3960
30	Channel	647668	656000	664332
	Frequency	3715.02	3840	3964.98
20	Channel	647334	656000	664666
	Frequency	3710.01	3840	3969.99
15	Channel	647168	656000	664832
	Frequency	3707.52	3840	3972.48
10	Channel	647000	656000	665000
	Frequency	3705	3840	3975



5G n78 Channel and Frequency List				
BW [MHz]	Channel/Frequency(MHz)	Lowest	Middle	Highest
100	Channel	650000		
	Frequency	3750		
90	Channel	649668	650000	650332
	Frequency	3745.02	3750	3754.98
80	Channel	649334	650000	650666
	Frequency	3740.01	3750	3759.99
70	Channel	649000	650000	651000
	Frequency	3735	3750	3765
60	Channel	648668	650000	651332
	Frequency	3730.02	3750	3769.98
50	Channel	648334	650000	651666
	Frequency	3725.01	3750	3774.99
40	Channel	648000	650000	652000
	Frequency	3720	3750	3780
30	Channel	647668	650000	652332
	Frequency	3715.02	3750	3784.98
20	Channel	647334	650000	652666
	Frequency	3710.01	3750	3789.99
15	Channel	647168	650000	652832
	Frequency	3707.52	3750	3792.48
10	Channel	647000	650000	653000
	Frequency	3705	3750	3795

3 Conducted Test Items

3.1 Measuring Instruments

See list of measuring instruments of this test report.

3.2 Test Setup

3.2.1 Conducted Output Power



3.2.2 Peak-to-Average Ratio, Occupied Bandwidth, Conducted Band-Edge and Conducted Spurious Emission

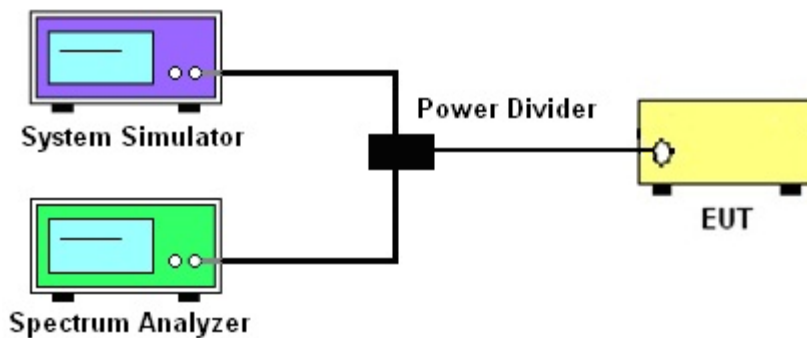

3.2.3 Frequency Stability

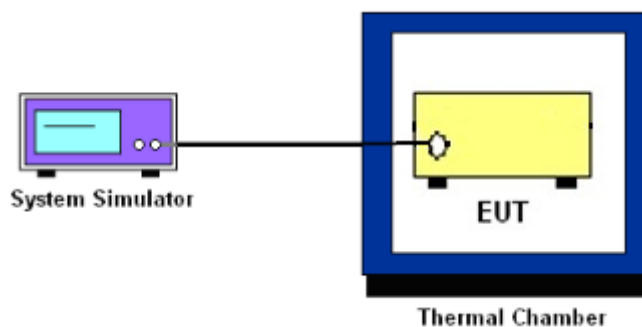

3.3 Test Result of Conducted Test

Please refer to Appendix A.



3.4 Conducted Output Power and EIRP

3.4.1 Description of the Conducted Output Power Measurement and EIRP Measurement

A system simulator was used to establish communication with the EUT. Its parameters were set to force the EUT transmitting at maximum output power. The measured power in the radio frequency on the transmitter output terminals shall be reported.

The EIRP of mobile transmitters must not exceed 1 Watts for 5G NR n77, n78.

According to KDB 412172 D01 Power Approach,

$EIRP = P_T + G_T - L_C$, $ERP = EIRP - 2.15$, where

P_T = transmitter output power in dBm

G_T = gain of the transmitting antenna in dBi

L_C = signal attenuation in the connecting cable between the transmitter and antenna in dB

3.4.2 Test Procedures

1. The testing follows ANSI C63.26 Section 5.2
2. The transmitter output port was connected to the system simulator.
3. Set EUT at maximum power through the system simulator.
4. Select lowest, middle, and highest channels for each band and different modulation.
5. Measure and record the power level from the system simulator.



3.5 Peak-to-Average Ratio

3.5.1 Description of the PAR Measurement

Power Complementary Cumulative Distribution Function (CCDF) curves provide a means for characterizing the power peaks of a digitally modulated signal on a statistical basis. A CCDF curve depicts the probability of the peak signal amplitude exceeding the average power level. Most contemporary measurement instrumentation include the capability to produce CCDF curves for an input signal provided that the instrument's resolution bandwidth can be set wide enough to accommodate the entire input signal bandwidth. In measuring transmissions in this band using an average power technique, the peak-to-average ratio (PAR) of the transmission may not exceed 13 dB.

3.5.2 Test Procedures

1. The testing follows ANSI C63.26 Section 5.2.3.4 (CCDF).
2. The EUT was connected to spectrum and system simulator via a power divider.
3. Set the CCDF (Complementary Cumulative Distribution Function) option in spectrum analyzer.
4. The highest RF powers were measured and recorded the maximum PAPR level associated with a probability of 0.1 %.
5. Record the deviation as Peak to Average Ratio.



3.6 Occupied Bandwidth

3.6.1 Description of Occupied Bandwidth Measurement

The occupied bandwidth is the width of a frequency band such that, below the lower and above the upper frequency limits, the mean powers emitted are each equal to a specified percentage 0.5% of the total mean transmitted power.

The 26 dB emission bandwidth is defined as the frequency range between two points, one above and one below the carrier frequency, at which the spectral density of the emission is attenuated 26 dB below the maximum in-band spectral density of the modulated signal. Spectral density (power per unit bandwidth) is to be measured with a detector of resolution bandwidth equal to approximately 1.0% of the emission bandwidth.

3.6.2 Test Procedures

1. The testing follows ANSI C63.26 Section 5.4
2. The EUT was connected to spectrum analyzer and system simulator via a power divider.
3. The spectrum analyzer center frequency is set to the nominal EUT channel center frequency. The span range for the spectrum analyzer shall be between two and five times the anticipated OBW.
4. The nominal resolution bandwidth (RBW) shall be in the range of 1 to 5 % of the anticipated OBW, and the VBW shall be at least 3 times the RBW.
5. Set the detection mode to peak, and the trace mode to max hold.
6. Determine the reference value: Set the EUT to transmit a modulated signal. Allow the trace to stabilize. Set the spectrum analyzer marker to the highest level of the displayed trace.
(this is the reference value)
7. Determine the “-26 dB down amplitude” as equal to (Reference Value – X).
8. Place two markers, one at the lowest and the other at the highest frequency of the envelope of the spectral display such that each marker is at or slightly below the “-X dB down amplitude” determined in step 6. If a marker is below this “-X dB down amplitude” value it shall be placed as close as possible to this value. The OBW is the positive frequency difference between the two markers.
9. Use the 99 % power bandwidth function of the spectrum analyzer and report the measured bandwidth.



3.7 Conducted Band Edge

3.7.1 Description of Conducted Band Edge Measurement

27.53(l)(2)

For mobile operations in the 3700-3980 MHz band, the conducted power of any emission outside the licensee's authorized bandwidth shall not exceed -13 dBm/MHz. Compliance with this paragraph is based on the use of measurement instrumentation employing a resolution bandwidth of 1 megahertz or greater. However, in the 1 megahertz bands immediately outside and adjacent to the licensee's frequency block, the minimum resolution bandwidth for the measurement shall be either one percent of the emission bandwidth of the fundamental emission of the transmitter or 350 kHz. In the bands between 1 and 5 MHz removed from the licensee's frequency block, the minimum resolution bandwidth for the measurement shall be 500 kHz.

3.7.2 Test Procedures

1. The testing follows ANSI C63.26 section 5.7
2. The EUT was connected to spectrum analyzer and system simulator via a power divider.
3. The band edges of low and high channels for the highest RF powers were measured.
4. Set RBW \geq 1% EBW in the 1MHz band immediately outside and adjacent to the band edge.
5. Beyond the 1 MHz band from the band edge, RBW=1MHz was used.
6. Set spectrum analyzer with RMS detector.
7. The RF fundamental frequency should be excluded against the limit line in the operating frequency band.
8. Checked that all the results comply with the emission limit line.

Example:

$$\begin{aligned} &\text{The limit line is derived from } 43 + 10\log(P)\text{dB below the transmitter power } P(\text{Watts}) \\ &= P(\text{W}) - [43 + 10\log(P)] \text{ (dB)} \\ &= [30 + 10\log(P)] \text{ (dBm)} - [43 + 10\log(P)] \text{ (dB)} = -13\text{dBm}. \end{aligned}$$

9. When using the integration method, the starting frequency of the integration shall be centered at one-half of the RBW away from the band edge.



3.8 Conducted Spurious Emission

3.8.1 Description of Conducted Spurious Emission Measurement

The power of any emission outside of the authorized operating frequency ranges must be lower than the transmitter power (P) by a factor of at least $43 + 10 \log (P)$ dB.

It is measured by means of a calibrated spectrum analyzer and scanned from 30 MHz up to a frequency including its 10th harmonic.

3.8.2 Test Procedures

1. The testing follows ANSI C63.26 section 5.7
2. The EUT was connected to spectrum analyzer and system simulator via a power divider.
3. The RF output of EUT was connected to the spectrum analyzer by RF cable and attenuator. The path loss was compensated to the results for each measurement.
4. The middle channel for the highest RF power within the transmitting frequency was measured.
5. The conducted spurious emission for the whole frequency range was taken.
6. Make the measurement with the spectrum analyzer's RBW = 1MHz, VBW = 3MHz.
7. Set spectrum analyzer with RMS detector.
8. Taking the record of maximum spurious emission.
9. The RF fundamental frequency should be excluded against the limit line in the operating frequency band.
10. The limit line is derived from $43 + 10\log(P)$ dB below the transmitter power P(Watts)
= P(W)- [43 + 10log(P)] (dB)
= [30 + 10log(P)] (dBm) - [43 + 10log(P)] (dB)
= -13dBm.



3.9 Frequency Stability

3.9.1 Description of Frequency Stability Measurement

The frequency stability shall be measured by variation of ambient temperature and variation of primary supply voltage to ensure that the fundamental emission stays within the authorized frequency block.

3.9.2 Test Procedures for Temperature Variation

1. The testing follows ANSI C63.26 section 5.6.4
2. The EUT was set up in the thermal chamber and connected with the system simulator.
3. With power OFF, the temperature was decreased to -30°C and the EUT was stabilized before testing. Power was applied and the maximum change in frequency was recorded within one minute.
4. With power OFF, the temperature was raised in 10°C step up to 50°C. The EUT was stabilized at each step for at least half an hour. Power was applied and the maximum frequency change was recorded within one minute.

3.9.3 Test Procedures for Voltage Variation

1. The testing follows ANSI C63.26 section 5.6.5
2. The EUT was placed in a temperature chamber at 20±5°C and connected with the system simulator.
3. The power supply voltage to the EUT was varied from 85% to 115% of the nominal value for other than hand carried battery equipment.
4. For hand carried, battery powered equipment, reduce the primary ac or dc supply voltage to the battery operating end point, which shall be specified by the manufacturer.
5. The variation in frequency was measured for the worst case.

4 Radiated Test Items

4.1 Measuring Instruments

See list of measuring instruments of this test report.

4.2 Test Setup

4.2.1 For radiated test below 30MHz

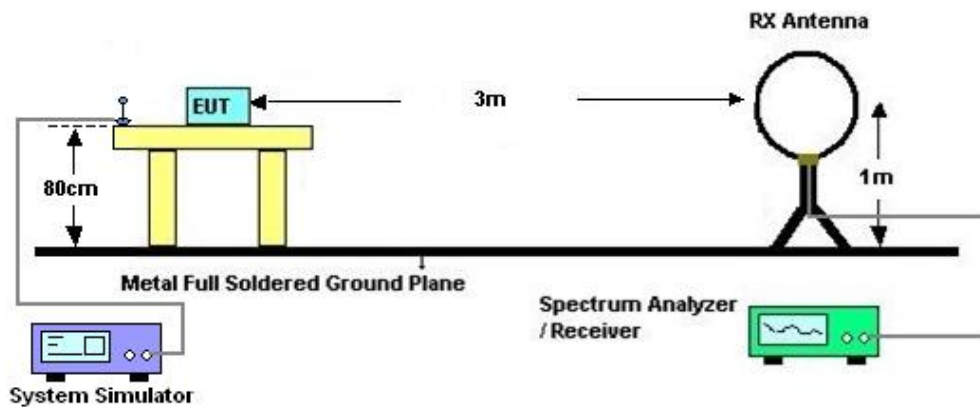

4.2.2 For radiated test from 30MHz to 1GHz

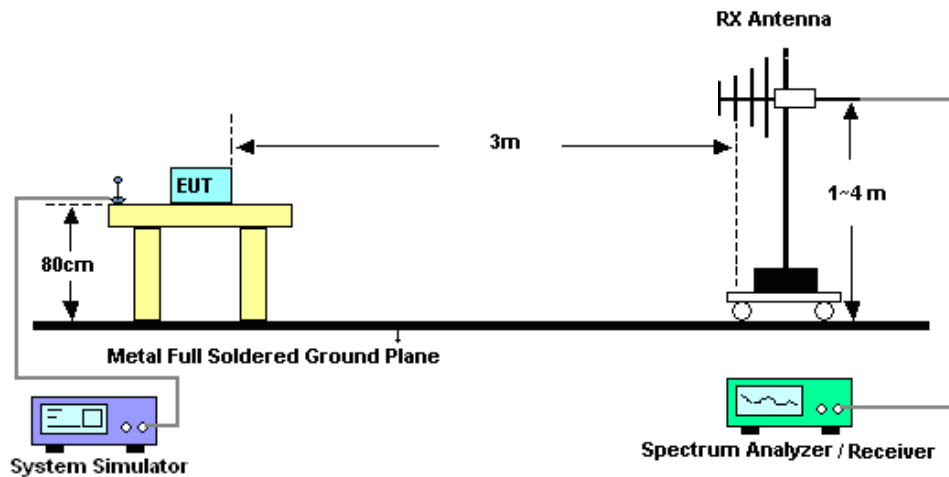

4.2.3 For radiated test above 1GHz

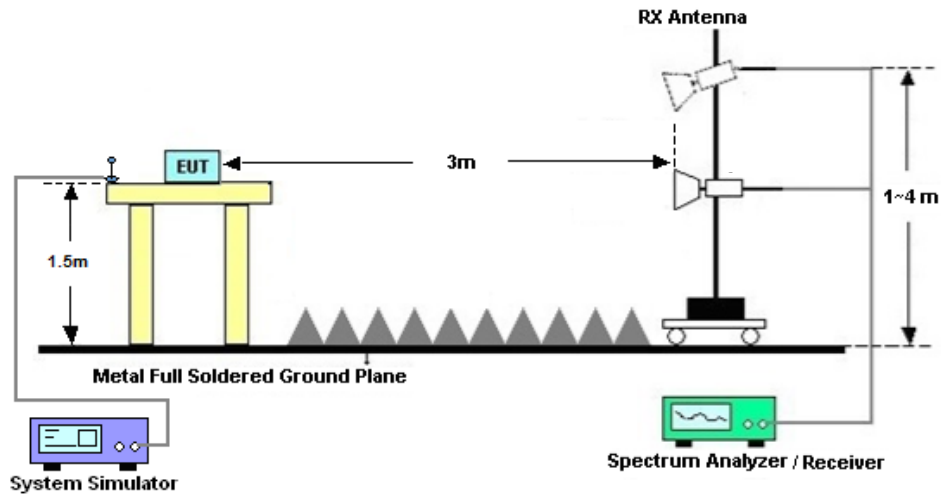

4.3 Test Result of Radiated Test

The low frequency, which started from 9 kHz to 30MHz, was pre-scanned and the result which was 20dB lower than the limit line was not reported.

Please refer to Appendix B.



4.4 Radiated Spurious Emission

4.4.1 Description of Radiated Spurious Emission

The radiated spurious emission was measured by substitution method according to ANSI C63.26. The power of any emission outside of the authorized operating frequency ranges must be attenuated below the transmitter power (P) by a factor of at least $43 + 10 \log (P)$ dB.

The spectrum is scanned from 30 MHz up to a frequency including its 10th harmonic.

4.4.2 Test Procedures

1. The testing follows ANSI C63.26 Section 5.5
2. The EUT was placed on a turntable with 0.8 meter height for frequency below 1GHz and 1.5 meter height for frequency above 1GHz respectively above ground.
3. The EUT was set 3 meters from the receiving antenna mounted on the antenna tower.
4. The table was rotated 360 degrees to determine the position of the highest spurious emission.
5. The height of the receiving antenna is varied between 1m to 4m to search the maximum spurious emission for both horizontal and vertical polarizations.
6. During the measurement, the system simulator parameters were set to force the EUT transmitting at maximum output power.
7. Make the measurement with the spectrum analyzer's RBW = 1MHz, VBW = 3MHz, taking the record of maximum spurious emission.
8. A horn antenna was substituted in place of the EUT and was driven by a signal generator.
9. Tune the output power of signal generator to the same emission level with EUT maximum spurious emission.
10. $EIRP \text{ (dBm)} = S.G. \text{ Power} - Tx \text{ Cable Loss} + Tx \text{ Antenna Gain}$
11. $ERP \text{ (dBm)} = EIRP - 2.15$
12. The RF fundamental frequency should be excluded against the limit line in the operating frequency band.

The limit line is derived from $43 + 10\log(P)$ dB below the transmitter power P(Watts)
= $P(W) - [43 + 10\log(P)] \text{ (dB)}$
= $[30 + 10\log(P)] \text{ (dBm)} - [43 + 10\log(P)] \text{ (dB)}$
= -13dBm.



5 List of Measuring Equipment

Instrument	Manufacturer	Model No.	Serial No.	Characteristics	Calibration Date	Test Date	Due Date	Remark
EMI Test Receiver&SA	Agilent	N9038A	MY52260185	20Hz~26.5GHz	Dec. 27, 2021	Dec. 22, 2022~ Jan. 12, 2023	Dec. 26, 2022	Conducted (TH01-SZ)
EMI Test Receiver&SA	Agilent	N9038A	MY52260185	20Hz~26.5GHz	Dec. 26, 2022		Dec. 25, 2023	Conducted (TH01-SZ)
Power Divider	TOJOIN	PS-2SM-04 265	60.06.020.007 7	0.4GHz~26.5GHz	Dec. 26, 2021	Dec. 22, 2022~ Jan. 12, 2023	Dec. 25, 2022	Conducted (TH01-SZ)
Power Divider	TOJOIN	PS-2SM-04 265	60.06.020.007 7	0.4GHz~26.5GHz	Dec. 25, 2022		Dec. 24, 2023	Conducted (TH01-SZ)
Thermal Chamber	Ten Billion Hongzhangroup	LP-150U	H2014081803	-40~+150°C	Jul. 07, 2022	Dec. 22, 2022~ Jan. 12, 2023	Jul. 06, 2023	Conducted (TH01-SZ)
EMI Test Receiver&SA	Agilent	N9038A	MY52260185	20Hz~26.5GHz	Dec. 26, 2022	Jan. 12, 2023	Dec. 25, 2023	Radiation (03CH01-SZ)
Loop Antenna	R&S	HFH2-Z2	100354	9kHz~30MHz	Jul. 28, 2022	Jan. 12, 2023	Jul. 27, 2024	Radiation (03CH01-SZ)
HF Amplifier	KEYSIGHT	83017A	MY53270105	0.5GHz~26.5Ghz	Oct. 19, 2022	Jan. 12, 2023	Oct. 18, 2023	Radiation (03CH01-SZ)
Bilog Antenna	TeseQ	CBL6112D	35407	30MHz-2GHz	Sep. 28, 2022	Jan. 12, 2023	Sep. 27, 2023	Radiation (03CH01-SZ)
Double Ridge Horn Antenna	ETS-Lindgren	3117	00119436	1GHz~18GHz	Jul. 07, 2022	Jan. 12, 2023	Jul. 06, 2023	Radiation (03CH01-SZ)
SHF-EHF Horn	com-power	AH-840	101071	18Ghz-40GHz	Apr. 10, 2022	Jan. 12, 2023	Apr. 09, 2023	Radiation (03CH01-SZ)
LF Amplifier	Burgeon	BPA-530	102209	0.01~3000Mhz	Apr. 06, 2022	Jan. 12, 2023	Apr. 05, 2023	Radiation (03CH01-SZ)
HF Amplifier	MITEQ	AMF-7D-00 101800-30-1 0P-R	1943528	1GHz~18GHz	Oct. 19, 2022	Jan. 12, 2023	Oct. 18, 2023	Radiation (03CH01-SZ)
HF Amplifier	MITEQ	TTA1840-35 -HG	1871923	18GHz~40GHz	Jul. 06, 2022	Jan. 12, 2023	Jul. 05, 2023	Radiation (03CH01-SZ)
AC Power Source	Chroma	61601	616010001985	N/A	Nov. 10, 2022	Jan. 12, 2023	Nov. 09, 2023	Radiation (03CH01-SZ)
Turn Table	EM	EM1000	N/A	0~360 degree	NCR	Jan. 12, 2023	NCR	Radiation (03CH01-SZ)
Antenna Mast	EM	EM1000	N/A	1 m~4 m	NCR	Jan. 12, 2023	NCR	Radiation (03CH01-SZ)

NCR: No Calibration Required



6 Uncertainty of Evaluation

The measurement uncertainties shown below were calculated in accordance with the requirements of ANSI 63.26-2015. All the measurement uncertainty value were shown with a coverage K=2 to indicate 95% level of confidence. The measurement data show herein meets or exceeds the CISPR measurement uncertainty values specified in CISPR 16-4-2 and can be compared directly to specified limit to determine compliance.

Uncertainty of Conducted Measurement

Test Item	Uncertainty
Conducted Power	±1.34 dB
Conducted Emissions	±1.34 dB
Occupied Channel Bandwidth	±0.13 %

Uncertainty of Radiated Emission Measurement (30 MHz ~ 1000 MHz)

Measuring Uncertainty for a Level of Confidence of 95% (U = 2Uc(y))	2.48dB
---	--------

Uncertainty of Radiated Emission Measurement (1 GHz ~ 18 GHz)

Measuring Uncertainty for a Level of Confidence of 95% (U = 2Uc(y))	3.53dB
---	--------

Uncertainty of Radiated Emission Measurement (18 GHz ~ 40 GHz)

Measuring Uncertainty for a Level of Confidence of 95% (U = 2Uc(y))	4.02dB
---	--------

----- THE END -----



Appendix A. Test Results of Conducted Test

Test Engineer :	Jung Guo	Temperature :	22~23°C
		Relative Humidity :	40~42%

FR1 N77-Ant 3

Transmitter Conducted Output Power And EIRP, (G_T - L_C)=-6.76dB

NR Band	SCS (kHz)	Bandwidth (MHz)	Arfcn	Freq (MHz)	Modulation	RB	Conducted Power(dBm)	ERP(dBm)	ERP(W)
77	30	10	647000	3705	DFT-s-OFDM QPSK	1@1	26.95	20.19	0.1045
77	30	10	647000	3705	DFT-s-OFDM 16 QAM	1@1	26.1	19.34	0.0859
77	30	10	656000	3840	DFT-s-OFDM QPSK	1@1	26.33	19.57	0.0906
77	30	10	656000	3840	DFT-s-OFDM 16 QAM	1@1	25.48	18.72	0.0745
77	30	10	665000	3975	DFT-s-OFDM QPSK	1@1	25.8	19.04	0.0802
77	30	10	665000	3975	DFT-s-OFDM 16 QAM	1@1	24.91	18.15	0.0653
77	30	15	647168	3707.52	DFT-s-OFDM QPSK	1@1	26.92	20.16	0.1038
77	30	15	647168	3707.52	DFT-s-OFDM 16 QAM	1@1	25.41	18.65	0.0733
77	30	15	656000	3840	DFT-s-OFDM QPSK	1@1	26.36	19.6	0.0912
77	30	15	656000	3840	DFT-s-OFDM 16 QAM	1@1	25.58	18.82	0.0762
77	30	15	664832	3972.48	DFT-s-OFDM QPSK	1@1	25.73	18.97	0.0789
77	30	15	664832	3972.48	DFT-s-OFDM 16 QAM	1@1	24.87	18.11	0.0647
77	30	20	647334	3710.01	DFT-s-OFDM QPSK	1@1	26.94	20.18	0.1042
77	30	20	647334	3710.01	DFT-s-OFDM 16 QAM	1@1	26	19.24	0.0839
77	30	20	656000	3840	DFT-s-OFDM QPSK	1@1	26.36	19.6	0.0912
77	30	20	656000	3840	DFT-s-OFDM 16 QAM	1@1	25.48	18.72	0.0745
77	30	20	664666	3969.99	DFT-s-OFDM QPSK	1@1	25.71	18.95	0.0785
77	30	20	664666	3969.99	DFT-s-OFDM 16 QAM	1@1	24.8	18.04	0.0637
77	30	30	647668	3715.02	DFT-s-OFDM QPSK	1@1	26.8	20.08	0.1019
77	30	30	647668	3715.02	DFT-s-OFDM 16 QAM	1@1	25.9	19.18	0.0828
77	30	30	656000	3840	DFT-s-OFDM QPSK	1@1	26.4	19.68	0.0929
77	30	30	656000	3840	DFT-s-OFDM 16 QAM	1@1	25.57	18.81	0.0760
77	30	30	664332	3964.98	DFT-s-OFDM QPSK	1@1	25.66	18.9	0.0776
77	30	30	664332	3964.98	DFT-s-OFDM 16 QAM	1@1	24.74	17.98	0.0628
77	30	40	648000	3720	DFT-s-OFDM QPSK	1@1	26.78	20.02	0.1005
77	30	40	648000	3720	DFT-s-OFDM 16 QAM	1@1	26.07	19.31	0.0853
77	30	40	656000	3840	DFT-s-OFDM QPSK	1@1	26.44	19.68	0.0929
77	30	40	656000	3840	DFT-s-OFDM 16 QAM	1@1	25.37	18.61	0.0726

77	30	40	664000	3960	DFT-s-OFDM QPSK	1@1	25.71	18.95	0.0785
77	30	40	664000	3960	DFT-s-OFDM 16 QAM	1@1	24.8	18.04	0.0637
77	30	50	648334	3725.01	DFT-s-OFDM QPSK	1@1	26.88	20.12	0.1028
77	30	50	648334	3725.01	DFT-s-OFDM 16 QAM	1@1	26.1	19.34	0.0859
77	30	50	656000	3840	DFT-s-OFDM QPSK	1@1	26.36	19.6	0.0912
77	30	50	656000	3840	DFT-s-OFDM 16 QAM	1@1	26.12	19.36	0.0863
77	30	50	663666	3954.99	DFT-s-OFDM QPSK	1@1	25.87	19.11	0.0815
77	30	50	663666	3954.99	DFT-s-OFDM 16 QAM	1@1	24.94	18.18	0.0658
77	30	60	648668	3730.02	DFT-s-OFDM QPSK	1@1	26.91	20.15	0.1035
77	30	60	648668	3730.02	DFT-s-OFDM 16 QAM	1@1	26.22	19.46	0.0883
77	30	60	656000	3840	DFT-s-OFDM QPSK	1@1	26.48	19.72	0.0938
77	30	60	656000	3840	DFT-s-OFDM 16 QAM	1@1	25.59	18.83	0.0764
77	30	60	663332	3949.98	DFT-s-OFDM QPSK	1@1	25.55	18.79	0.0757
77	30	60	663332	3949.98	DFT-s-OFDM 16 QAM	1@1	24.68	17.92	0.0619
77	30	70	649000	3735	DFT-s-OFDM QPSK	1@1	26.78	20.02	0.1005
77	30	70	649000	3735	DFT-s-OFDM 16 QAM	1@1	25.83	19.07	0.0807
77	30	70	656000	3840	DFT-s-OFDM QPSK	1@1	26.53	19.77	0.0948
77	30	70	656000	3840	DFT-s-OFDM 16 QAM	1@1	25.66	18.9	0.0776
77	30	70	663000	3945	DFT-s-OFDM QPSK	1@1	25.56	18.8	0.0759
77	30	70	663000	3945	DFT-s-OFDM 16 QAM	1@1	24.67	17.91	0.0618
77	30	80	649334	3740.01	DFT-s-OFDM QPSK	1@1	26.87	20.11	0.1026
77	30	80	649334	3740.01	DFT-s-OFDM 16 QAM	1@1	25.86	19.1	0.0813
77	30	80	656000	3840	DFT-s-OFDM QPSK	1@1	26.49	19.73	0.0940
77	30	80	656000	3840	DFT-s-OFDM 16 QAM	1@1	25.59	18.83	0.0764
77	30	80	662666	3939.99	DFT-s-OFDM QPSK	1@1	25.47	18.71	0.0743
77	30	80	662666	3939.99	DFT-s-OFDM 16 QAM	1@1	24.57	17.81	0.0604
77	30	90	649668	3745.02	DFT-s-OFDM QPSK	1@1	26.86	20.1	0.1023
77	30	90	649668	3745.02	DFT-s-OFDM 16 QAM	1@1	25.91	19.15	0.0822
77	30	90	656000	3840	DFT-s-OFDM QPSK	1@1	26.49	19.73	0.0940
77	30	90	656000	3840	DFT-s-OFDM 16 QAM	1@1	25.63	18.87	0.0771
77	30	90	662332	3934.98	DFT-s-OFDM QPSK	1@1	25.49	18.73	0.0746
77	30	90	662332	3934.98	DFT-s-OFDM 16 QAM	1@1	24.65	17.89	0.0615
77	30	100	650000	3750	DFT-s-OFDM PI/2 BPSK	135@67	26.2	19.44	0.0879
77	30	100	650000	3750	DFT-s-OFDM PI/2 BPSK	1@1	26.49	19.73	0.0940
77	30	100	650000	3750	DFT-s-OFDM PI/2 BPSK	1@271	26.08	19.32	0.0855

77	30	100	650000	3750	DFT-s-OFDM QPSK	135@67	26.1	19.34	0.0859
77	30	100	650000	3750	DFT-s-OFDM QPSK	1@1	26.4	19.64	0.0920
77	30	100	650000	3750	DFT-s-OFDM QPSK	1@271	26.05	19.29	0.0849
77	30	100	650000	3750	DFT-s-OFDM 16 QAM	135@67	25.01	18.25	0.0668
77	30	100	650000	3750	DFT-s-OFDM 16 QAM	1@1	25.34	18.58	0.0721
77	30	100	650000	3750	DFT-s-OFDM 16 QAM	1@271	25.14	18.38	0.0689
77	30	100	650000	3750	DFT-s-OFDM 64 QAM	135@67	23.93	17.17	0.0521
77	30	100	650000	3750	DFT-s-OFDM 64 QAM	1@1	24.29	17.53	0.0566
77	30	100	650000	3750	DFT-s-OFDM 64 QAM	1@271	23.8	17.04	0.0506
77	30	100	650000	3750	DFT-s-OFDM 256 QAM	135@67	22.33	15.57	0.0361
77	30	100	650000	3750	DFT-s-OFDM 256 QAM	1@1	22.96	16.2	0.0417
77	30	100	650000	3750	DFT-s-OFDM 256 QAM	1@271	22.63	15.87	0.0386
77	30	100	650000	3750	CP-OFDM QPSK	137@68	25.33	18.57	0.0719
77	30	100	650000	3750	CP-OFDM QPSK	1@1	24.67	17.91	0.0618
77	30	100	650000	3750	CP-OFDM QPSK	1@271	24.38	17.62	0.0578
77	30	100	656000	3840	DFT-s-OFDM PI/2 BPSK	135@67	25.95	19.19	0.0830
77	30	100	656000	3840	DFT-s-OFDM PI/2 BPSK	1@1	26.98	20.22	0.1052
77	30	100	656000	3840	DFT-s-OFDM PI/2 BPSK	1@271	25.31	18.55	0.0716
77	30	100	656000	3840	DFT-s-OFDM QPSK	135@67	25.84	19.08	0.0809
77	30	100	656000	3840	DFT-s-OFDM QPSK	1@1	26.23	19.47	0.0885
77	30	100	656000	3840	DFT-s-OFDM QPSK	1@271	25.34	18.58	0.0721
77	30	100	656000	3840	DFT-s-OFDM 16 QAM	135@67	24.85	18.09	0.0644
77	30	100	656000	3840	DFT-s-OFDM 16 QAM	1@1	25.25	18.49	0.0706
77	30	100	656000	3840	DFT-s-OFDM 16 QAM	1@271	24.41	17.65	0.0582
77	30	100	656000	3840	DFT-s-OFDM 64 QAM	135@67	23.47	16.71	0.0469
77	30	100	656000	3840	DFT-s-OFDM 64 QAM	1@1	23.86	17.1	0.0513
77	30	100	656000	3840	DFT-s-OFDM 64 QAM	1@271	22.9	16.14	0.0411
77	30	100	656000	3840	DFT-s-OFDM 256 QAM	135@67	22.05	15.29	0.0338
77	30	100	656000	3840	DFT-s-OFDM 256 QAM	1@1	22.71	15.95	0.0394
77	30	100	656000	3840	DFT-s-OFDM 256 QAM	1@271	21.82	15.06	0.0321
77	30	100	656000	3840	CP-OFDM QPSK	137@68	25.08	18.32	0.0679
77	30	100	656000	3840	CP-OFDM QPSK	1@1	24.41	17.65	0.0582
77	30	100	656000	3840	CP-OFDM QPSK	1@271	23.56	16.8	0.0479
77	30	100	662000	3930	DFT-s-OFDM PI/2 BPSK	135@67	25.37	18.61	0.0726
77	30	100	662000	3930	DFT-s-OFDM PI/2 BPSK	1@1	25.4	18.64	0.0731

77	30	100	662000	3930	DFT-s-OFDM PI/2 BPSK	1@271	25.19	18.43	0.0697
77	30	100	662000	3930	DFT-s-OFDM QPSK	135@67	25.27	18.51	0.0710
77	30	100	662000	3930	DFT-s-OFDM QPSK	1@1	25.35	18.59	0.0723
77	30	100	662000	3930	DFT-s-OFDM QPSK	1@271	25.19	18.43	0.0697
77	30	100	662000	3930	DFT-s-OFDM 16 QAM	135@67	24.27	17.51	0.0564
77	30	100	662000	3930	DFT-s-OFDM 16 QAM	1@1	24.33	17.57	0.0571
77	30	100	662000	3930	DFT-s-OFDM 16 QAM	1@271	24.27	17.51	0.0564
77	30	100	662000	3930	DFT-s-OFDM 64 QAM	135@67	22.94	16.18	0.0415
77	30	100	662000	3930	DFT-s-OFDM 64 QAM	1@1	23.05	16.29	0.0426
77	30	100	662000	3930	DFT-s-OFDM 64 QAM	1@271	22.84	16.08	0.0406
77	30	100	662000	3930	DFT-s-OFDM 256 QAM	135@67	21.43	14.67	0.0293
77	30	100	662000	3930	DFT-s-OFDM 256 QAM	1@1	21.77	15.01	0.0317
77	30	100	662000	3930	DFT-s-OFDM 256 QAM	1@271	21.65	14.89	0.0308
77	30	100	662000	3930	CP-OFDM QPSK	137@68	24.79	18.03	0.0635
77	30	100	662000	3930	CP-OFDM QPSK	1@1	23.54	16.78	0.0476
77	30	100	662000	3930	CP-OFDM QPSK	1@271	23.42	16.66	0.0463

Frequency Stability

NR Band	SCS (kHz)	Bandwidth (MHz)	Arfcn	Freq (MHz)	Modulation	RB	Deviation (ppm)	Verdict	Environment
77	30	20	656000	3840.0	DFT-s-OFDM QPSK	50@0	0.0057	PASS	NV
77	30	20	656000	3840.0	DFT-s-OFDM QPSK	50@0	0.0039	PASS	LV
77	30	20	656000	3840.0	DFT-s-OFDM QPSK	50@0	0.0049	PASS	HV
77	30	20	656000	3840.0	DFT-s-OFDM QPSK	50@0	0.0052	PASS	-30°C
77	30	20	656000	3840.0	DFT-s-OFDM QPSK	50@0	0.0065	PASS	-20°C
77	30	20	656000	3840.0	DFT-s-OFDM QPSK	50@0	0.0028	PASS	-10°C
77	30	20	656000	3840.0	DFT-s-OFDM QPSK	50@0	0.0040	PASS	0°C
77	30	20	656000	3840.0	DFT-s-OFDM QPSK	50@0	0.0051	PASS	10°C
77	30	20	656000	3840.0	DFT-s-OFDM QPSK	50@0	0.0057	PASS	20°C
77	30	20	656000	3840.0	DFT-s-OFDM QPSK	50@0	0.0057	PASS	30°C
77	30	20	656000	3840.0	DFT-s-OFDM QPSK	50@0	0.0020	PASS	40°C
77	30	20	656000	3840.0	DFT-s-OFDM QPSK	50@0	0.0032	PASS	50°C

Peak to Average Ratio

NR Band	SCS (kHz)	Bandwidth (MHz)	Arfcn	Freq (MHz)	Modulation	RB	Result (dB)	Limit (dB)	Verdict
77	30	20	647334	3710.01	DFT-s-OFDM PI/2 BPSK	50@0	6.78	13	PASS
77	30	20	647334	3710.01	DFT-s-OFDM PI/2 BPSK	1@0	6.76	13	PASS
77	30	20	647334	3710.01	DFT-s-OFDM QPSK	50@0	7.27	13	PASS
77	30	20	647334	3710.01	DFT-s-OFDM QPSK	1@0	6.38	13	PASS
77	30	20	656000	3840.0	DFT-s-OFDM PI/2 BPSK	50@0	6.74	13	PASS
77	30	20	656000	3840.0	DFT-s-OFDM PI/2 BPSK	1@0	6.64	13	PASS
77	30	20	656000	3840.0	DFT-s-OFDM QPSK	50@0	7.18	13	PASS
77	30	20	656000	3840.0	DFT-s-OFDM QPSK	1@0	6.37	13	PASS
77	30	20	664666	3969.99	DFT-s-OFDM PI/2 BPSK	50@0	6.77	13	PASS
77	30	20	664666	3969.99	DFT-s-OFDM PI/2 BPSK	1@0	6.89	13	PASS
77	30	20	664666	3969.99	DFT-s-OFDM QPSK	50@0	7.29	13	PASS
77	30	20	664666	3969.99	DFT-s-OFDM QPSK	1@0	6.9	13	PASS

N77(20M)_DFT-s-OFDM_PI_2-BPSK_Outer_Full_Low_CH



N77(20M)_DFT-s-OFDM_PI_2-BPSK_Edge_1RB_Left_Low_CH

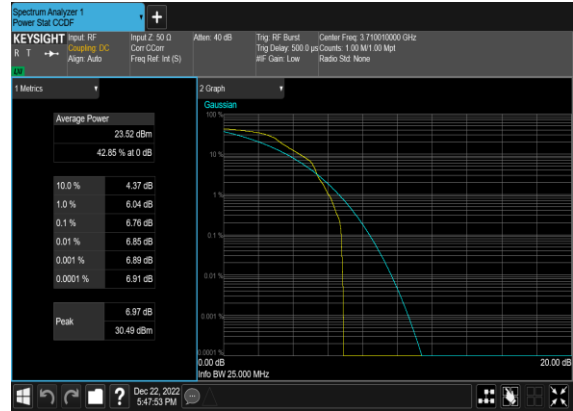

N77(20M)_DFT-s-OFDM_QPSK_Outer_Full_Low_CH



N77(20M)_DFT-s-OFDM_QPSK_Edge_1RB_Left_Low_CH

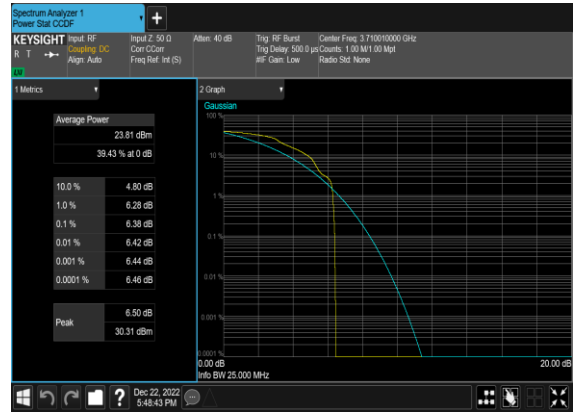

N77(20M)_DFT-s-OFDM_PI_2-BPSK_Outer_Full_Mid_CH

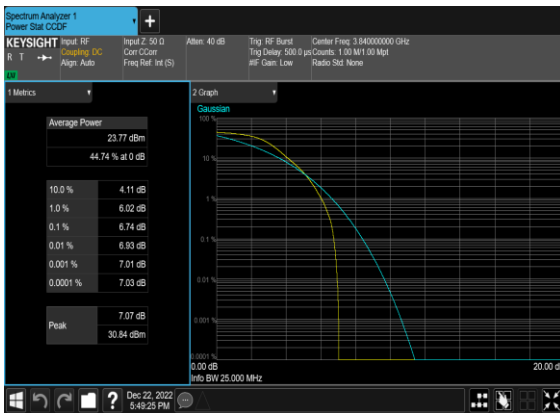

N77(20M)_DFT-s-OFDM_PI_2-BPSK_Edge_1RB_Left_Mid_CH



N77(20M)_DFT-s-OFDM_QPSK_Outer_Full_Mid_CH



N77(20M)_DFT-s-OFDM_QPSK_Edge_1RB_Left_Mid_CH



N77(20M)_DFT-s-OFDM_PI_2-BPSK_Outer_Full_High_CH

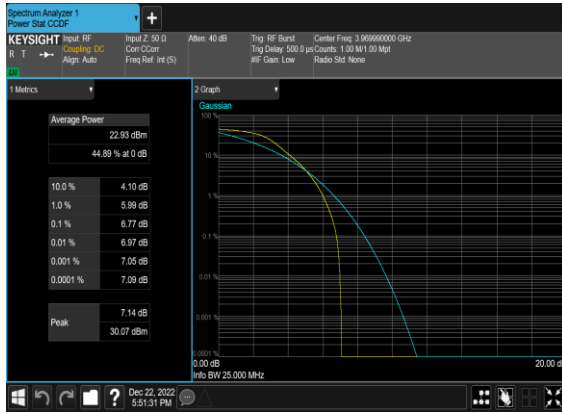

N77(20M)_DFT-s-OFDM_PI_2-BPSK_Edge_1RB_Left_High_CH

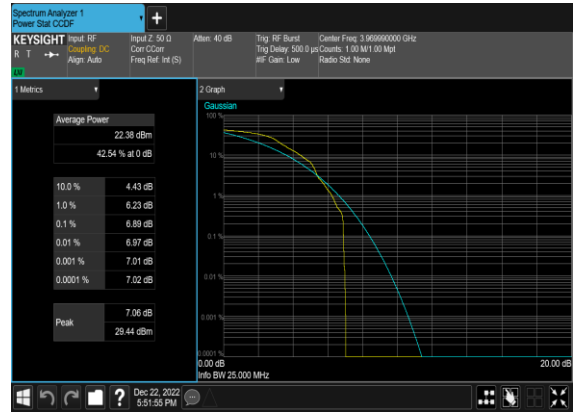

N77(20M)_DFT-s-OFDM_QPSK_Outer_Full_High_CH



N77(20M)_DFT-s-OFDM_QPSK_Edge_1RB_Left_High_CH

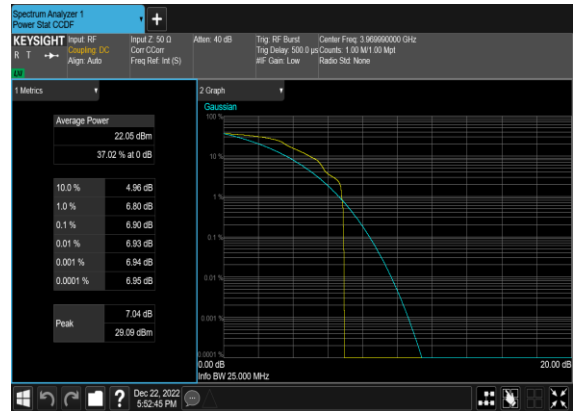

Occupied Bandwidth

NR Band	SCS (kHz)	Bandwidth (MHz)	Arfcn	Freq (MHz)	Modulation	RB	OBW (MHz)	26dB BW (MHz)
77	30	10	656000	3840.0	DFT-s-OFDM PI/2 BPSK	24@0	8.5563	9.449
77	30	10	656000	3840.0	DFT-s-OFDM QPSK	24@0	8.5925	9.791
77	30	10	656000	3840.0	CP-OFDM QPSK	24@0	8.571	9.686
77	30	10	656000	3840.0	CP-OFDM 16 QAM	24@0	8.5769	9.622
77	30	10	656000	3840.0	CP-OFDM 64 QAM	24@0	8.6004	9.68
77	30	10	656000	3840.0	CP-OFDM 256 QAM	24@0	8.5869	9.866
77	30	15	656000	3840.0	DFT-s-OFDM PI/2 BPSK	36@0	12.83	13.78
77	30	15	656000	3840.0	DFT-s-OFDM QPSK	36@0	12.835	13.79
77	30	15	656000	3840.0	CP-OFDM QPSK	38@0	13.622	14.95
77	30	15	656000	3840.0	CP-OFDM 16 QAM	38@0	13.593	14.56
77	30	15	656000	3840.0	CP-OFDM 64 QAM	38@0	13.554	14.88
77	30	15	656000	3840.0	CP-OFDM 256 QAM	38@0	13.563	14.82
77	30	20	656000	3840.0	DFT-s-OFDM PI/2 BPSK	50@0	17.872	18.7
77	30	20	656000	3840.0	DFT-s-OFDM QPSK	50@0	17.826	19.04
77	30	20	656000	3840.0	CP-OFDM QPSK	51@0	18.181	20.08
77	30	20	656000	3840.0	CP-OFDM 16 QAM	51@0	18.286	19.64
77	30	20	656000	3840.0	CP-OFDM 64 QAM	51@0	18.201	19.35
77	30	20	656000	3840.0	CP-OFDM 256 QAM	51@0	18.215	19.22
77	30	30	656000	3840.0	DFT-s-OFDM PI/2 BPSK	75@0	26.791	28.08
77	30	30	656000	3840.0	DFT-s-OFDM QPSK	75@0	26.736	27.94
77	30	30	656000	3840.0	CP-OFDM QPSK	78@0	27.858	28.91
77	30	30	656000	3840.0	CP-OFDM 16 QAM	78@0	27.887	29.18
77	30	30	656000	3840.0	CP-OFDM 64 QAM	78@0	27.893	29.5
77	30	30	656000	3840.0	CP-OFDM 256 QAM	78@0	27.849	29.02

77	30	40	656000	3840.0	DFT-s-OFDM PI/2 BPSK	100@0	35.649	37.43
77	30	40	656000	3840.0	DFT-s-OFDM QPSK	100@0	35.758	37.42
77	30	40	656000	3840.0	CP-OFDM QPSK	106@0	37.827	39.47
77	30	40	656000	3840.0	CP-OFDM 16 QAM	106@0	37.812	39.2
77	30	40	656000	3840.0	CP-OFDM 64 QAM	106@0	37.851	39.61
77	30	40	656000	3840.0	CP-OFDM 256 QAM	106@0	37.925	39.16
77	30	50	656000	3840.0	DFT-s-OFDM PI/2 BPSK	128@0	45.647	47.28
77	30	50	656000	3840.0	DFT-s-OFDM QPSK	128@0	45.718	51.74
77	30	50	656000	3840.0	CP-OFDM QPSK	133@0	47.45	49.46
77	30	50	656000	3840.0	CP-OFDM 16 QAM	133@0	47.512	49.21
77	30	50	656000	3840.0	CP-OFDM 64 QAM	133@0	47.531	49.13
77	30	50	656000	3840.0	CP-OFDM 256 QAM	133@0	47.467	49.17
77	30	60	656000	3840.0	DFT-s-OFDM PI/2 BPSK	162@0	58.03	60.13
77	30	60	656000	3840.0	DFT-s-OFDM QPSK	162@0	57.769	60.14
77	30	60	656000	3840.0	CP-OFDM QPSK	162@0	57.838	59.81
77	30	60	656000	3840.0	CP-OFDM 16 QAM	162@0	57.739	59.59
77	30	60	656000	3840.0	CP-OFDM 64 QAM	162@0	57.843	59.65
77	30	60	656000	3840.0	CP-OFDM 256 QAM	162@0	57.923	59.74
77	30	70	656000	3840.0	DFT-s-OFDM PI/2 BPSK	180@0	64.297	66.38
77	30	70	656000	3840.0	DFT-s-OFDM QPSK	180@0	64.429	66.38
77	30	70	656000	3840.0	CP-OFDM QPSK	189@0	67.592	69.59
77	30	70	656000	3840.0	CP-OFDM 16 QAM	189@0	67.429	69.79
77	30	70	656000	3840.0	CP-OFDM 64 QAM	189@0	67.432	69.56
77	30	70	656000	3840.0	CP-OFDM 256 QAM	189@0	67.326	69.69
77	30	80	656000	3840.0	DFT-s-OFDM PI/2 BPSK	216@0	77.34	79.76
77	30	80	656000	3840.0	DFT-s-OFDM	216@0	76.93	79.77

QPSK								
77	30	80	656000	3840.0	CP-OFDM QPSK	217@0	77.377	79.94
77	30	80	656000	3840.0	CP-OFDM 16 QAM	217@0	77.509	79.83
77	30	80	656000	3840.0	CP-OFDM 64 QAM	217@0	77.367	79.82
77	30	80	656000	3840.0	CP-OFDM 256 QAM	217@0	77.427	79.9
77	30	90	656000	3840.0	DFT-s- OFDM PI/2 BPSK	240@0	85.941	88.59
77	30	90	656000	3840.0	DFT-s- OFDM QPSK	240@0	85.503	88.5
77	30	90	656000	3840.0	CP-OFDM QPSK	245@0	87.375	90.52
77	30	90	656000	3840.0	CP-OFDM 16 QAM	245@0	87.449	90.5
77	30	90	656000	3840.0	CP-OFDM 64 QAM	245@0	87.424	90.21
77	30	90	656000	3840.0	CP-OFDM 256 QAM	245@0	87.491	90.25
77	30	100	656000	3840.0	DFT-s- OFDM PI/2 BPSK	270@0	96.5	99.41
77	30	100	656000	3840.0	DFT-s- OFDM QPSK	270@0	96.616	99.47
77	30	100	656000	3840.0	CP-OFDM QPSK	273@0	97.42	100.5
77	30	100	656000	3840.0	CP-OFDM 16 QAM	273@0	97.548	100.6
77	30	100	656000	3840.0	CP-OFDM 64 QAM	273@0	97.504	100.5
77	30	100	656000	3840.0	CP-OFDM 256 QAM	273@0	97.279	100.7

N77(10M)_DFT-s-OFDM_PI_2-BPSK_Outer_Full_Mid_CH

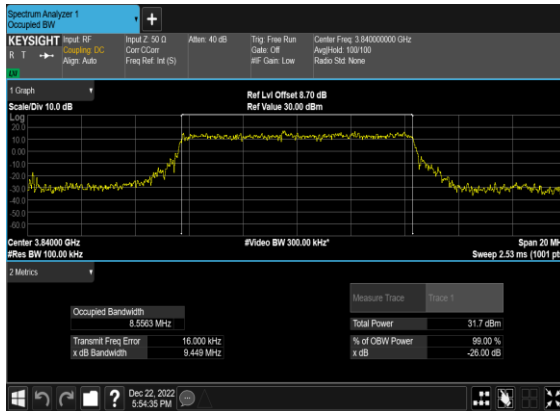

N77(10M)_DFT-s-OFDM_QPSK_Outer_Full_Mid_CH

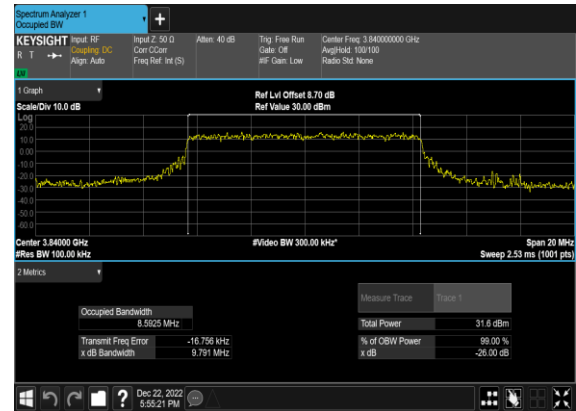

N77(10M)_CP-OFDM_QPSK_Outer_Full_Mid_CH

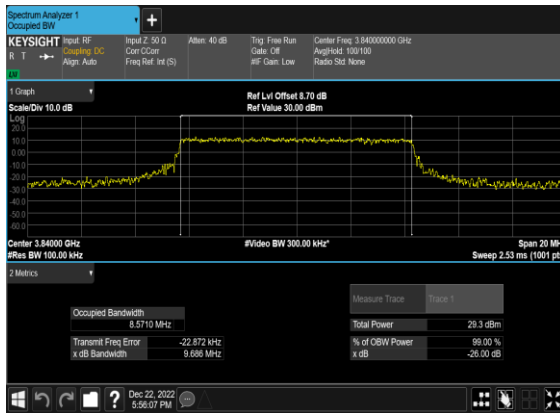

N77(10M)_CP-OFDM_16QAM_Outer_Full_Mid_CH



N77(10M)_CP-OFDM_64QAM_Outer_Full_Mid_CH

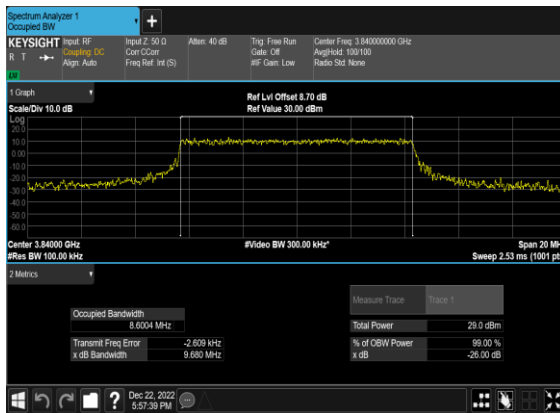

N77(10M)_CP-OFDM_256QAM_Outer_Full_Mid_CH

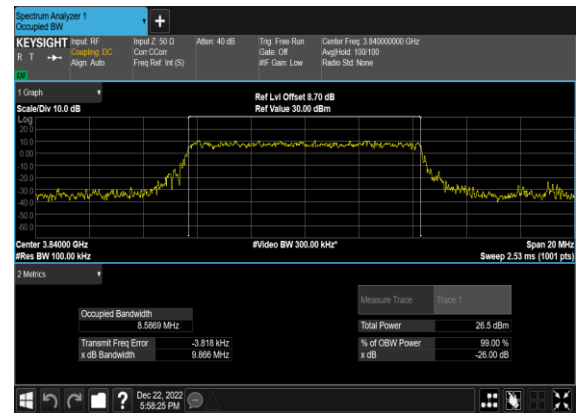

N77(15M)_DFT-s-OFDM_PI_2- BPSK_Outer_Full_Mid_CH

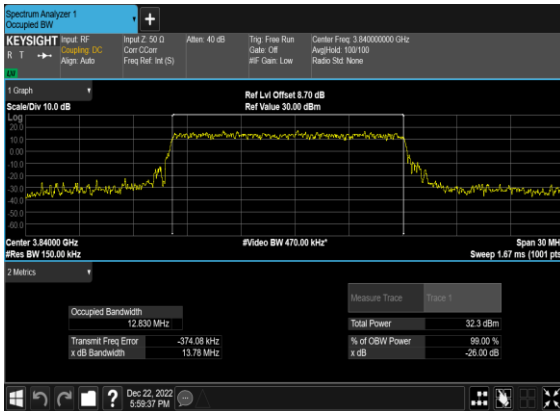

N77(15M)_DFT-s- OFDM_QPSK_Outer_Full_Mid_CH

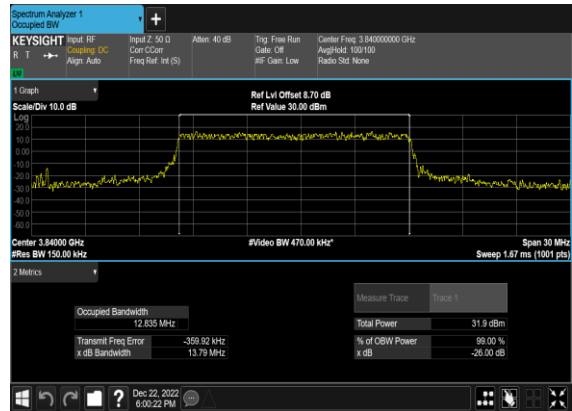

N77(15M)_CP- OFDM_QPSK_Outer_Full_Mid_CH



N77(15M)_CP-OFDM_16 QAM_Outer_Full_Mid_CH



N77(15M)_CP-OFDM_64 QAM_Outer_Full_Mid_CH



N77(15M)_CP-OFDM_256 QAM_Outer_Full_Mid_CH

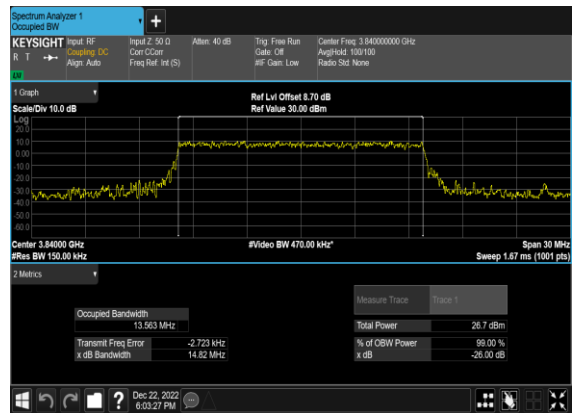

N77(20M)_DFT-s-OFDM_PI_2- BPSK_Outer_Full_Mid_CH

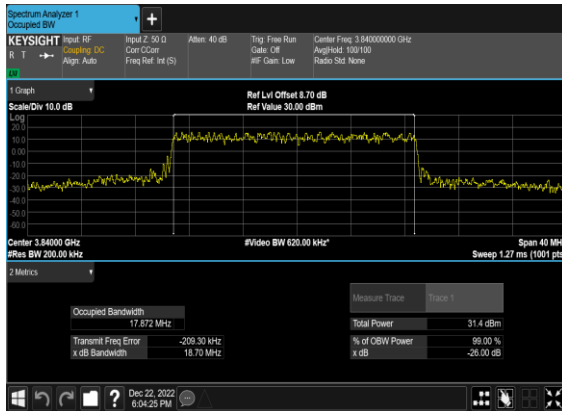

N77(20M)_DFT-s- OFDM_QPSK_Outer_Full_Mid_CH

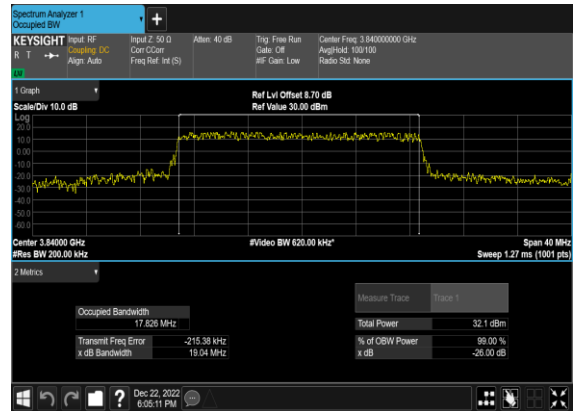

N77(20M)_CP- OFDM_QPSK_Outer_Full_Mid_CH



N77(20M)_CP-OFDM_16 QAM_Outer_Full_Mid_CH



N77(20M)_CP-OFDM_64 QAM_Outer_Full_Mid_CH

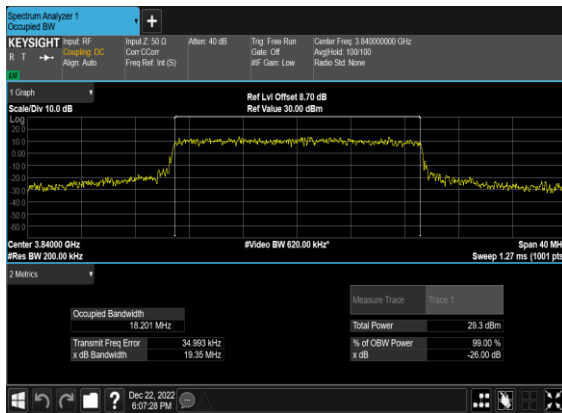

N77(20M)_CP-OFDM_256 QAM_Outer_Full_Mid_CH

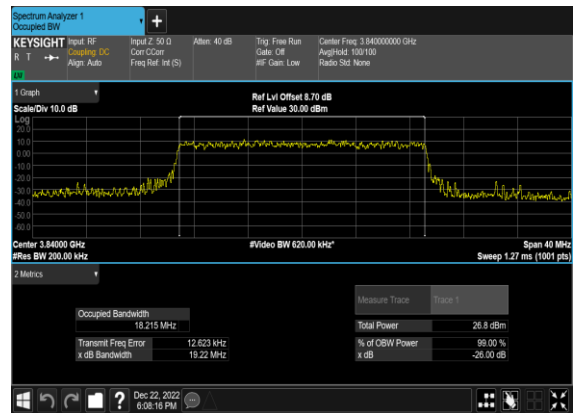

N77(30M)_DFT-s-OFDM_PI_2-BPSK_Outer_Full_Mid_CH

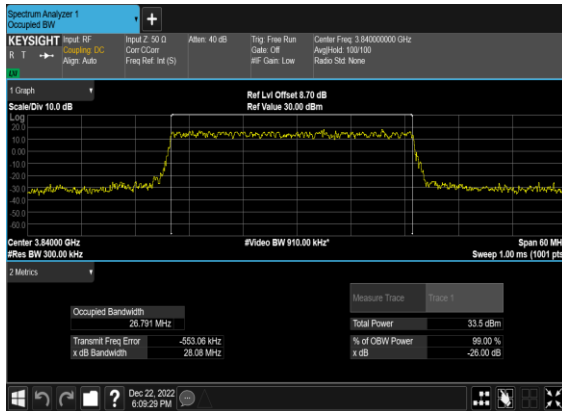

N77(30M)_DFT-s-OFDM_QPSK_Outer_Full_Mid_CH

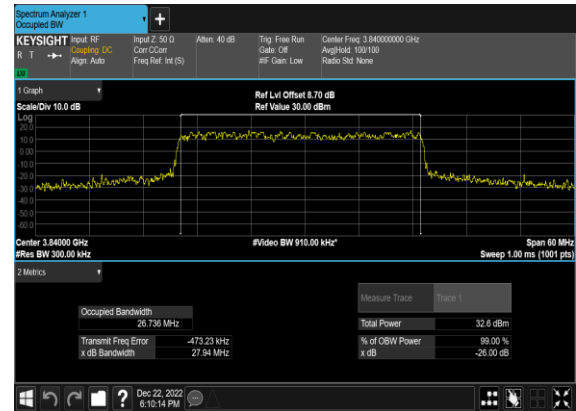

N77(30M)_CP-OFDM_QPSK_Outer_Full_Mid_CH



N77(30M)_CP-OFDM_16QAM_Outer_Full_Mid_CH



N77(30M)_CP-OFDM_64QAM_Outer_Full_Mid_CH

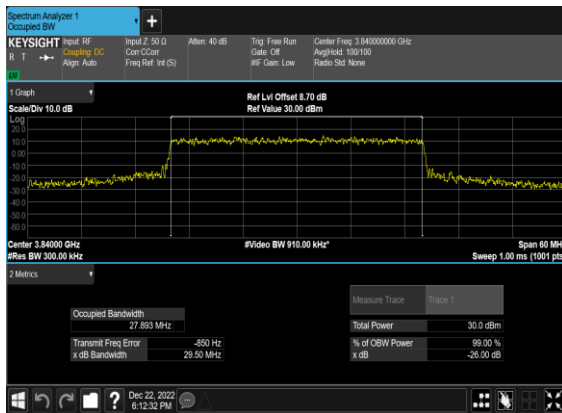

N77(30M)_CP-OFDM_256QAM_Outer_Full_Mid_CH

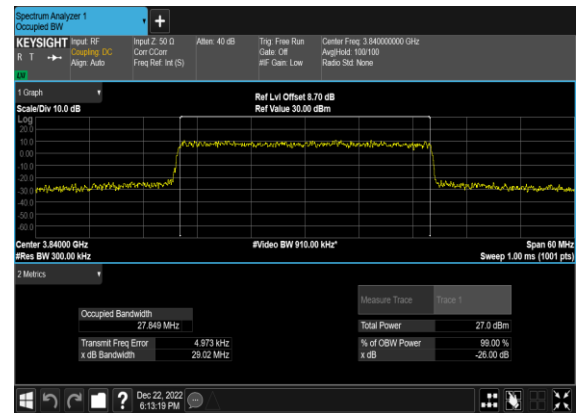

N77(40M)_DFT-s-OFDM_PI_2- BPSK_Outer_Full_Mid_CH

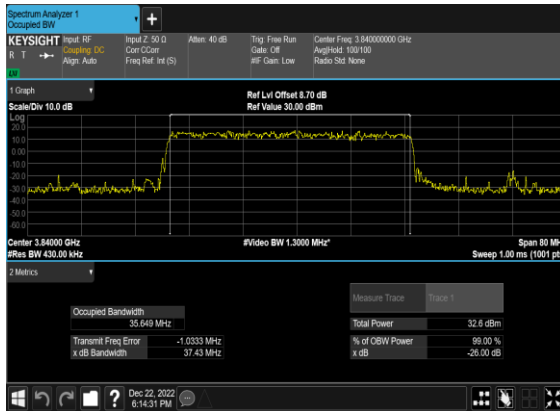

N77(40M)_DFT-s- OFDM_QPSK_Outer_Full_Mid_CH

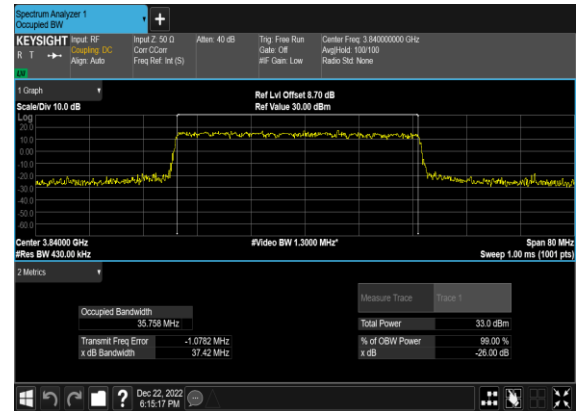

N77(40M)_CP- OFDM_QPSK_Outer_Full_Mid_CH

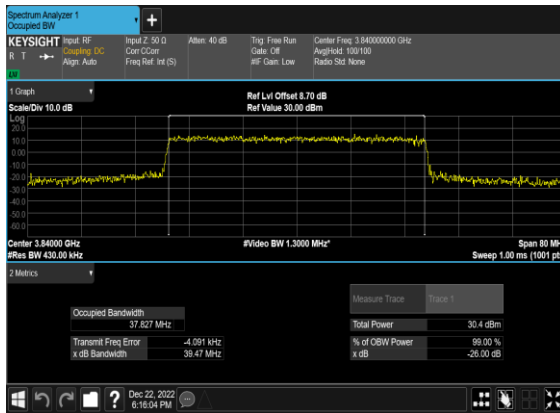

N77(40M)_CP-OFDM_16 QAM_Outer_Full_Mid_CH

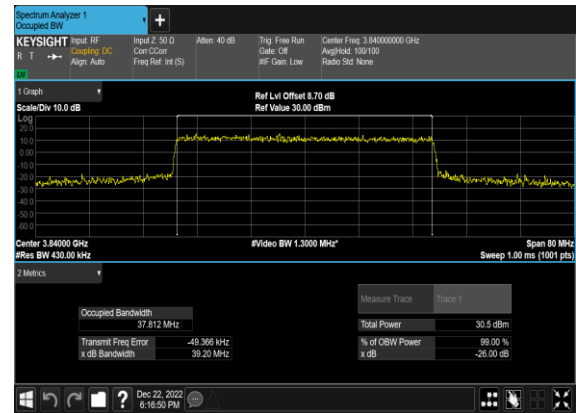

N77(40M)_CP-OFDM_64 QAM_Outer_Full_Mid_CH

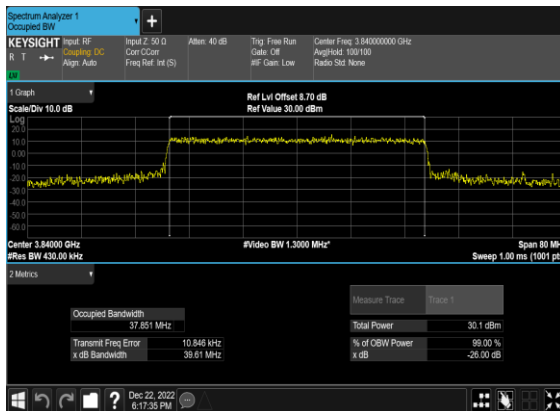

N77(40M)_CP-OFDM_256 QAM_Outer_Full_Mid_CH

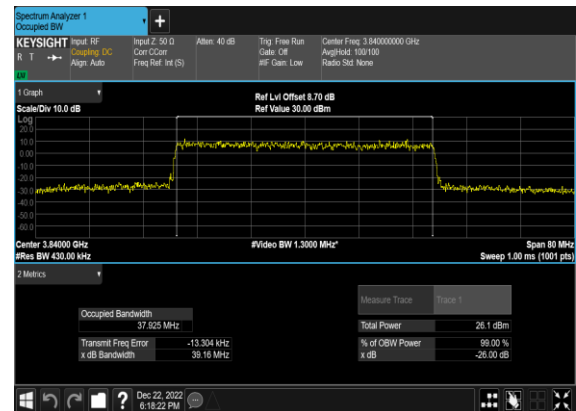

N77(50M)_DFT-s-OFDM_PI_2-
BPSK_Outer_Full_Mid_CH

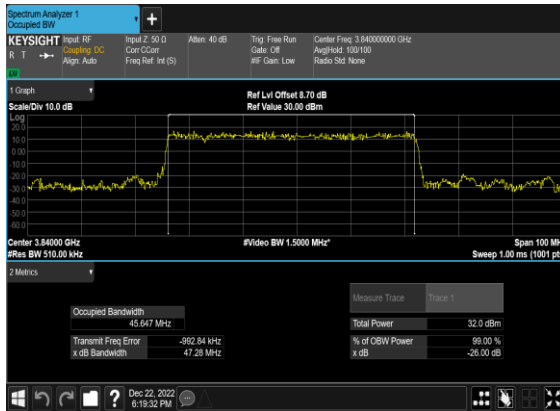

N77(50M)_DFT-s-
OFDM_QPSK_Outer_Full_Mid_CH

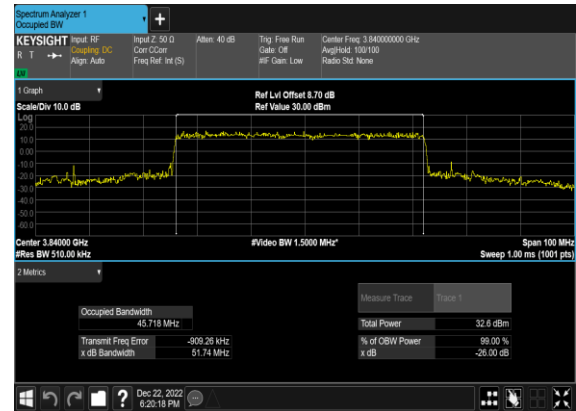

N77(50M)_CP-
OFDM_QPSK_Outer_Full_Mid_CH

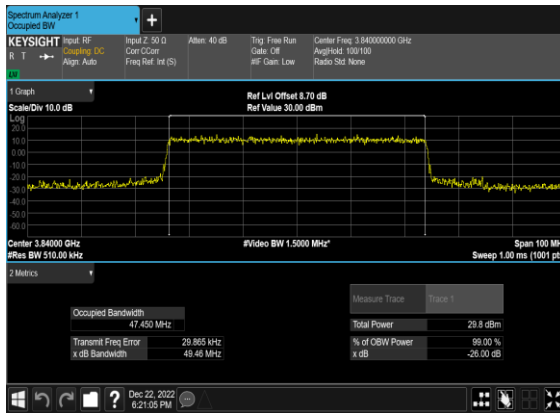

N77(50M)_CP-OFDM_16
QAM_Outer_Full_Mid_CH

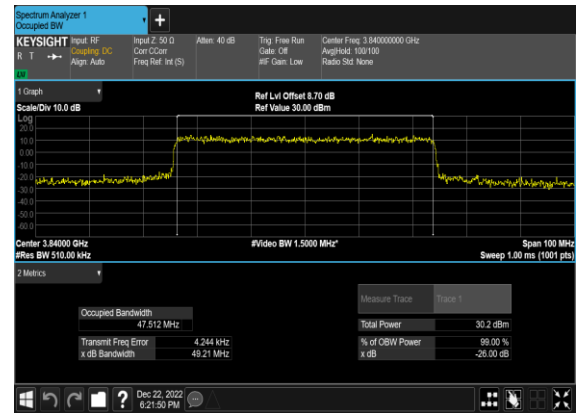

N77(50M)_CP-OFDM_64
QAM_Outer_Full_Mid_CH

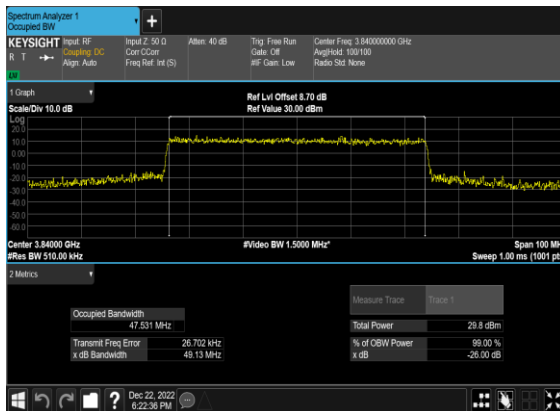

N77(50M)_CP-OFDM_256
QAM_Outer_Full_Mid_CH

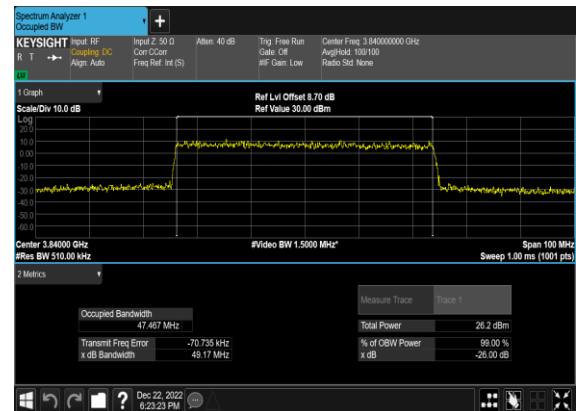

N77(60M)_DFT-s-OFDM_PI_2-BPSK_Outer_Full_Mid_CH

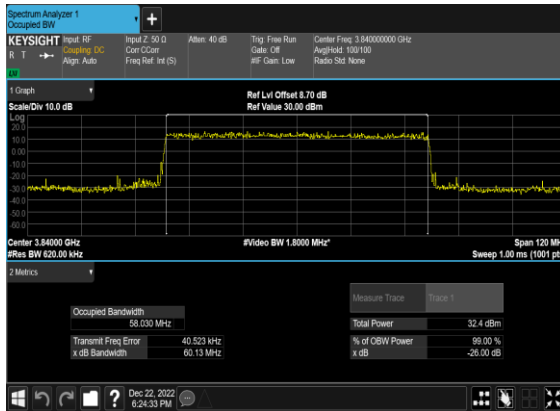

N77(60M)_DFT-s-OFDM_QPSK_Outer_Full_Mid_CH

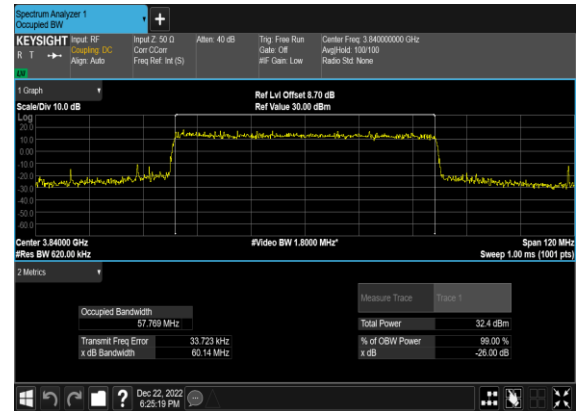

N77(60M)_CP-OFDM_QPSK_Outer_Full_Mid_CH

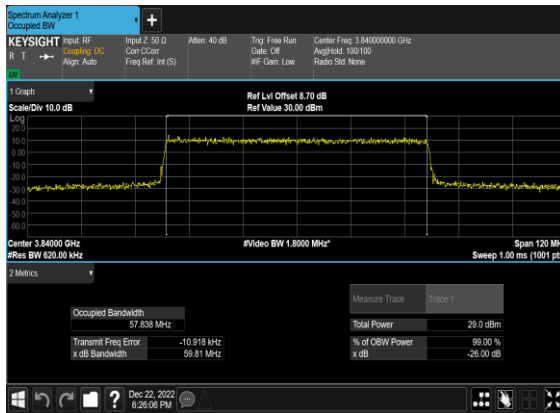

N77(60M)_CP-OFDM_16QAM_Outer_Full_Mid_CH

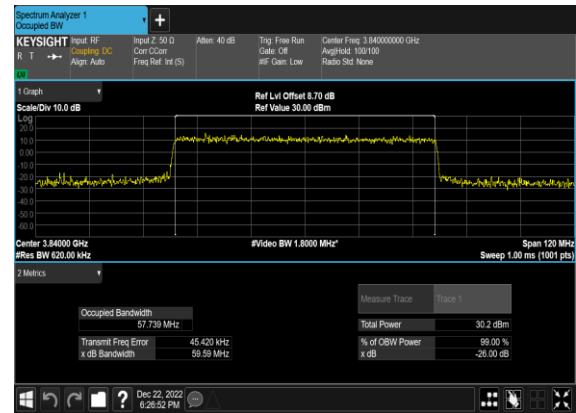

N77(60M)_CP-OFDM_64QAM_Outer_Full_Mid_CH

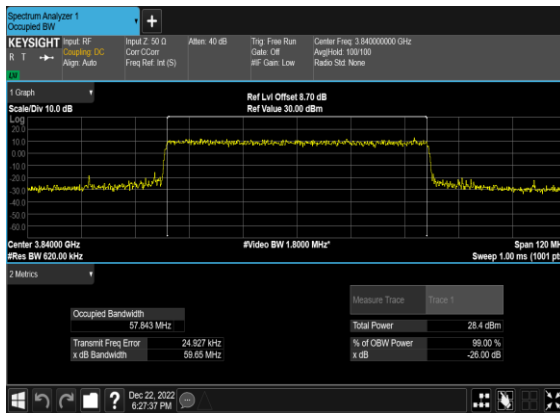

N77(60M)_CP-OFDM_256QAM_Outer_Full_Mid_CH

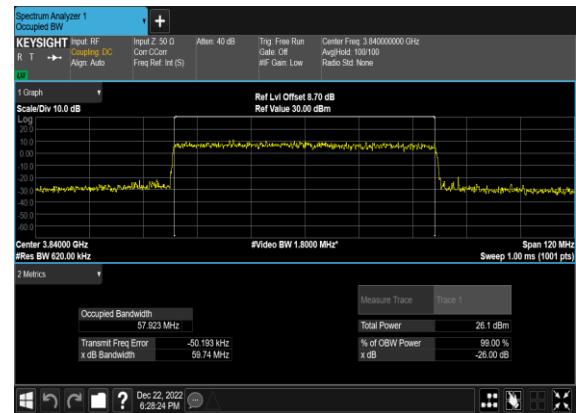

N77(70M)_DFT-s-OFDM_PI_2-BPSK_Outer_Full_Mid_CH

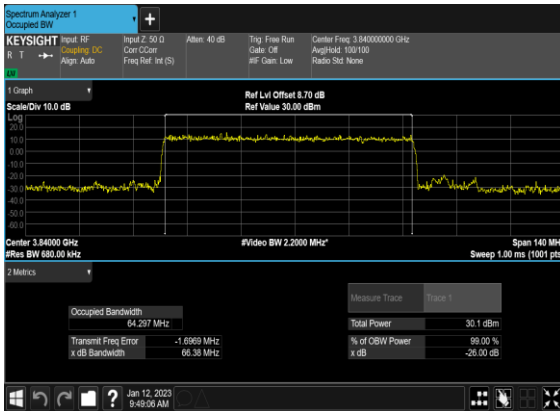

N77(70M)_DFT-s-OFDM_QPSK_Outer_Full_Mid_CH

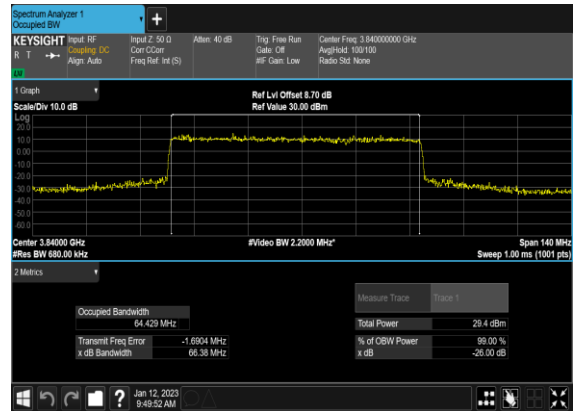

N77(70M)_CP-OFDM_QPSK_Outer_Full_Mid_CH



N77(70M)_CP-OFDM_16QAM_Outer_Full_Mid_CH

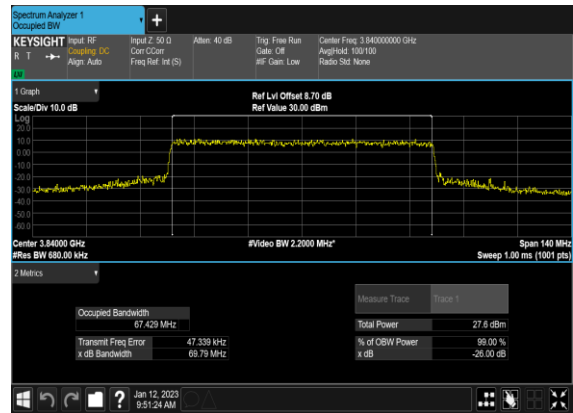

N77(70M)_CP-OFDM_64QAM_Outer_Full_Mid_CH



N77(70M)_CP-OFDM_256QAM_Outer_Full_Mid_CH

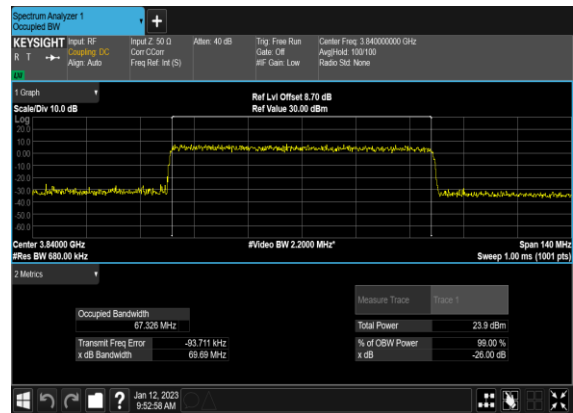

N77(80M)_DFT-s-OFDM_PI_2- BPSK_Outer_Full_Mid_CH

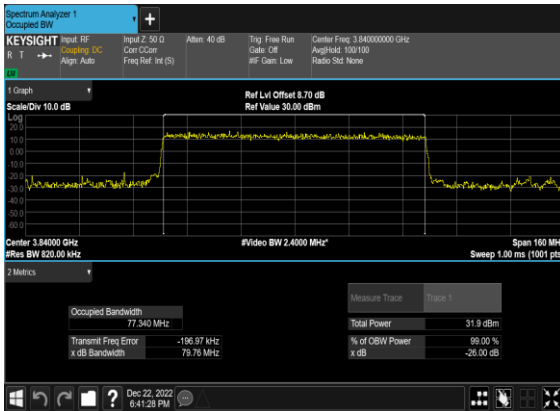

N77(80M)_DFT-s- OFDM_QPSK_Outer_Full_Mid_CH

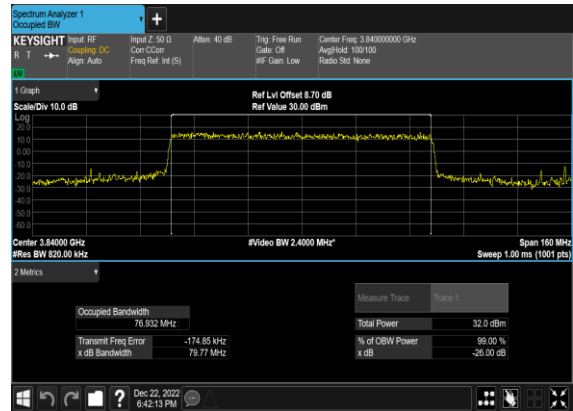

N77(80M)_CP- OFDM_QPSK_Outer_Full_Mid_CH

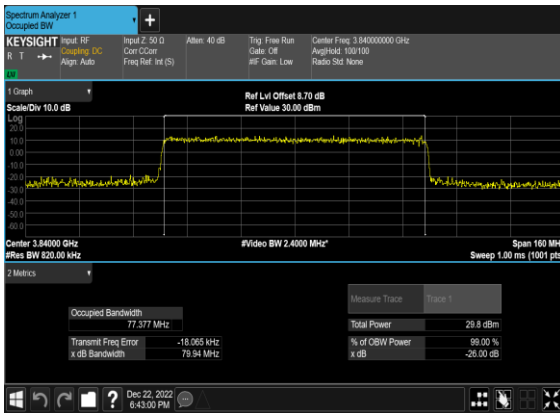

N77(80M)_CP-OFDM_16 QAM_Outer_Full_Mid_CH

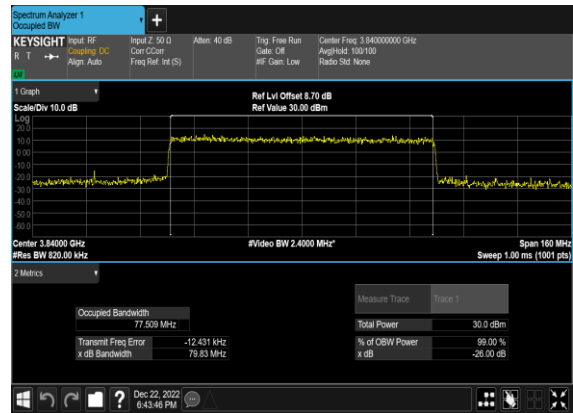

N77(80M)_CP-OFDM_64 QAM_Outer_Full_Mid_CH

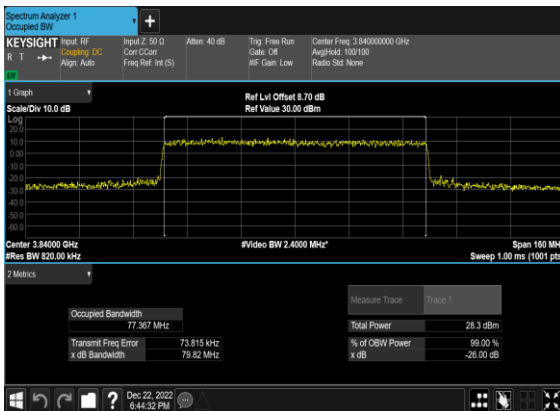

N77(80M)_CP-OFDM_256 QAM_Outer_Full_Mid_CH

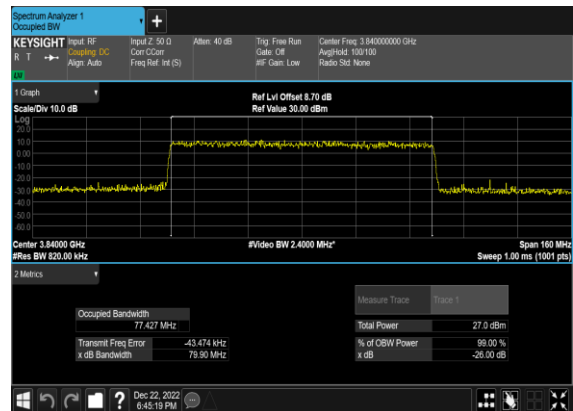

N77(90M)_DFT-s-OFDM_PI_2-BPSK_Outer_Full_Mid_CH

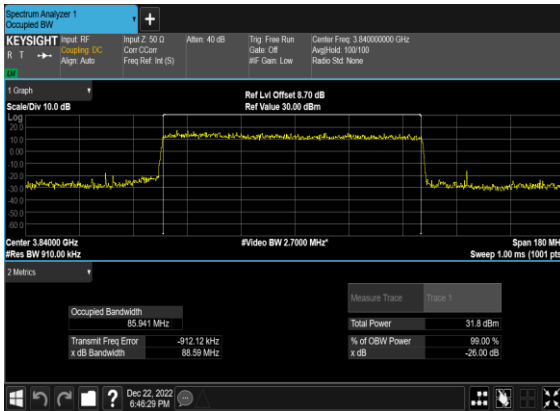

N77(90M)_DFT-s-OFDM_QPSK_Outer_Full_Mid_CH

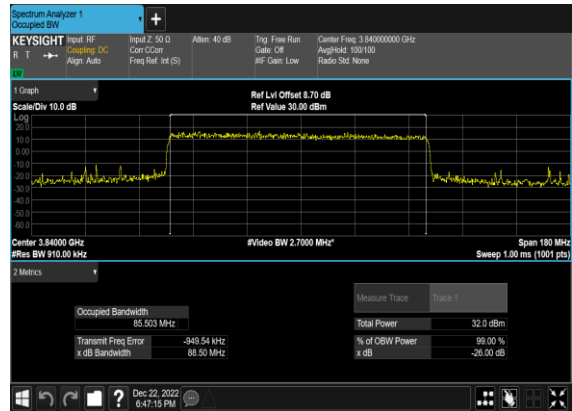

N77(90M)_CP-OFDM_QPSK_Outer_Full_Mid_CH

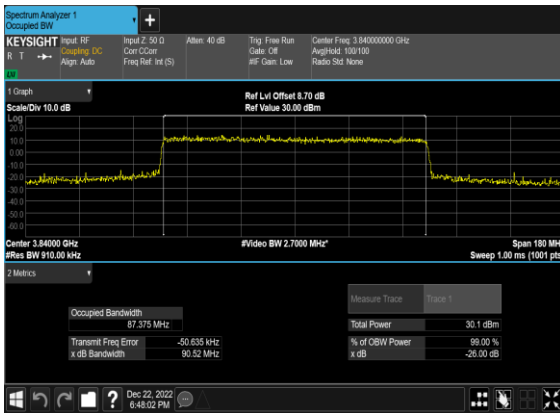

N77(90M)_CP-OFDM_16QAM_Outer_Full_Mid_CH

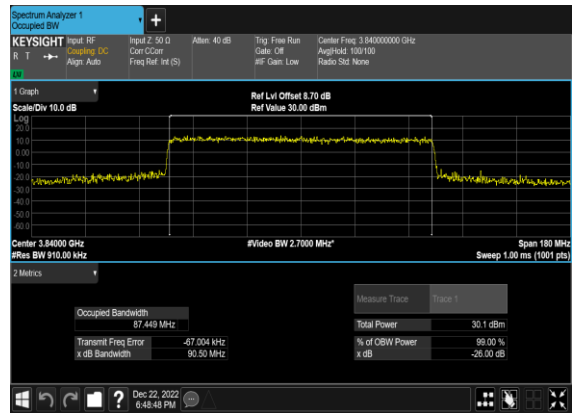

N77(90M)_CP-OFDM_64QAM_Outer_Full_Mid_CH

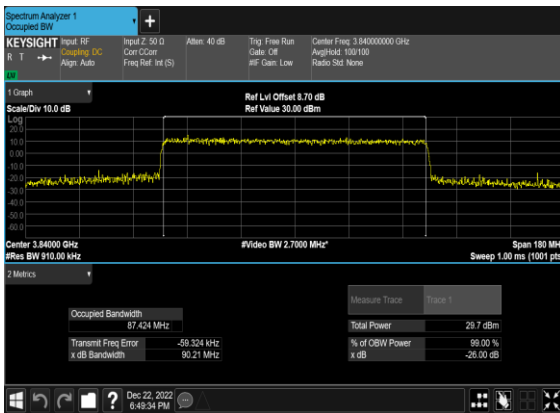

N77(90M)_CP-OFDM_256QAM_Outer_Full_Mid_CH

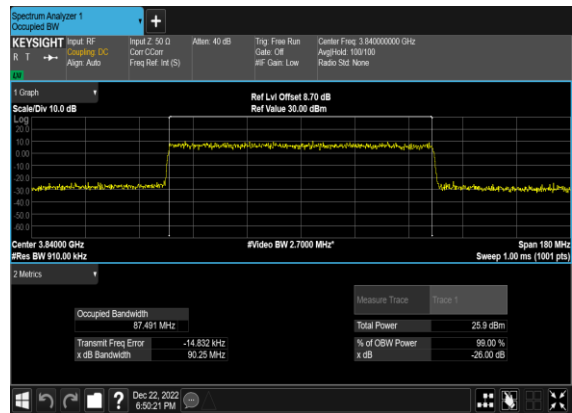

N77(100M)_DFT-s-OFDM_PI_2- BPSK_Outer_Full_Mid_CH

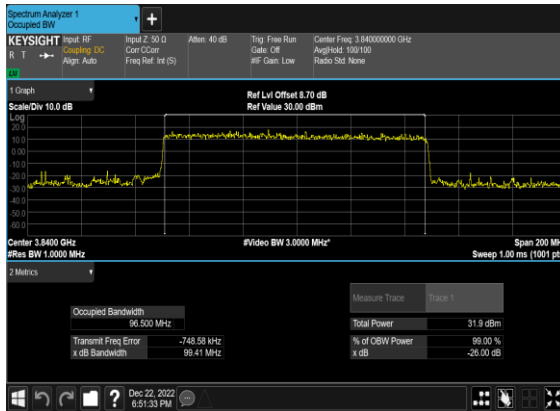

N77(100M)_DFT-s- OFDM_QPSK_Outer_Full_Mid_CH

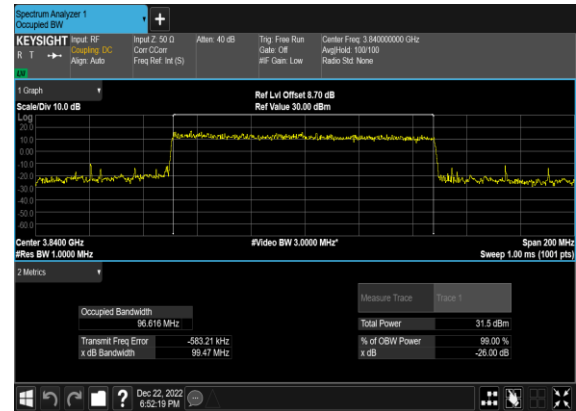

N77(100M)_CP- OFDM_QPSK_Outer_Full_Mid_CH

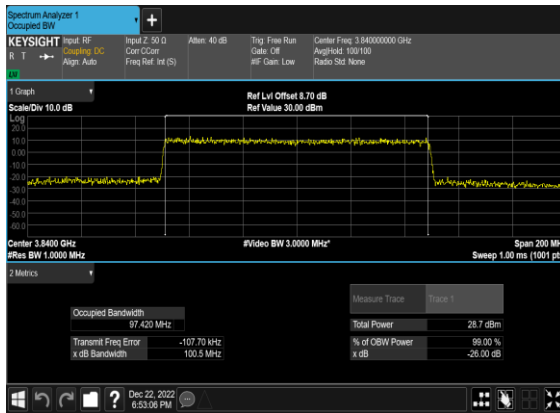

N77(100M)_CP-OFDM_16 QAM_Outer_Full_Mid_CH

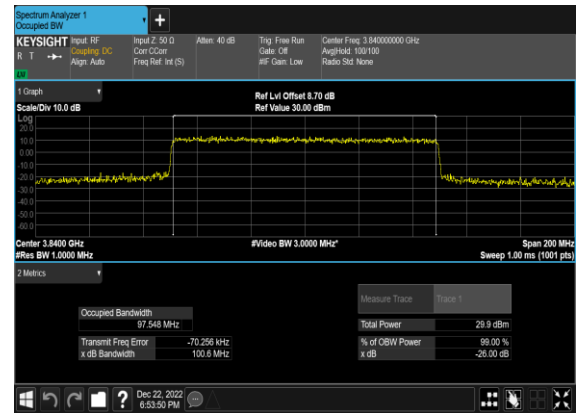

N77(100M)_CP-OFDM_64 QAM_Outer_Full_Mid_CH

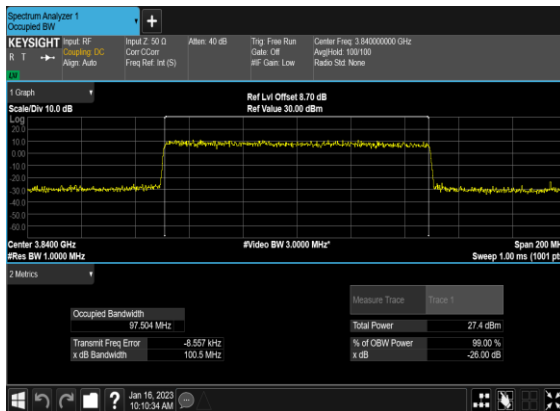

N77(100M)_CP-OFDM_256 QAM_Outer_Full_Mid_CH

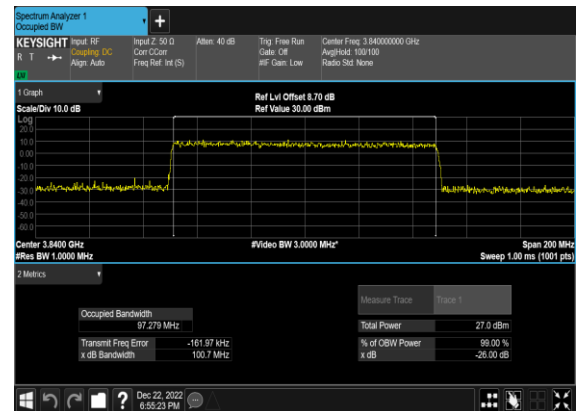

Conducted Spurious Emissions

NR Band	SCS (kHz)	Bandwidth (MHz)	Arfcn	Freq (MHz)	Modulation	RB	Result	Verdict
77	30	10	647000	3705.0	DFT-s-OFDM BPSK	1@0	see graph	---
77	30	10	647000	3705.0	DFT-s-OFDM BPSK	1@0	see graph	PASS
77	30	10	647000	3705.0	DFT-s-OFDM BPSK	1@0	see graph	PASS
77	30	10	647000	3705.0	DFT-s-OFDM QPSK	1@0	see graph	---
77	30	10	647000	3705.0	DFT-s-OFDM QPSK	1@0	see graph	PASS
77	30	10	647000	3705.0	DFT-s-OFDM QPSK	1@0	see graph	PASS
77	30	10	656000	3840.0	DFT-s-OFDM BPSK	1@0	see graph	---
77	30	10	656000	3840.0	DFT-s-OFDM BPSK	1@0	see graph	PASS
77	30	10	656000	3840.0	DFT-s-OFDM BPSK	1@0	see graph	PASS
77	30	10	656000	3840.0	DFT-s-OFDM QPSK	1@0	see graph	---
77	30	10	656000	3840.0	DFT-s-OFDM QPSK	1@0	see graph	PASS
77	30	10	656000	3840.0	DFT-s-OFDM QPSK	1@0	see graph	PASS
77	30	10	665000	3975.0	DFT-s-OFDM BPSK	1@0	see graph	---
77	30	10	665000	3975.0	DFT-s-OFDM BPSK	1@0	see graph	PASS
77	30	10	665000	3975.0	DFT-s-OFDM BPSK	1@0	see graph	PASS
77	30	10	665000	3975.0	DFT-s-OFDM QPSK	1@0	see graph	---
77	30	10	665000	3975.0	DFT-s-OFDM QPSK	1@0	see graph	PASS
77	30	10	665000	3975.0	DFT-s-OFDM QPSK	1@0	see graph	PASS
77	30	50	648334	3725.01	DFT-s-OFDM BPSK	1@0	see graph	---
77	30	50	648334	3725.01	DFT-s-OFDM BPSK	1@0	see graph	PASS
77	30	50	648334	3725.01	DFT-s-OFDM BPSK	1@0	see graph	PASS
77	30	50	648334	3725.01	DFT-s-OFDM QPSK	1@0	see graph	---

77	30	50	648334	3725.01	DFT-s-OFDM QPSK	1@0	see graph	PASS
77	30	50	648334	3725.01	DFT-s-OFDM QPSK	1@0	see graph	PASS
77	30	50	656000	3840.0	DFT-s-OFDM BPSK	1@0	see graph	---
77	30	50	656000	3840.0	DFT-s-OFDM BPSK	1@0	see graph	PASS
77	30	50	656000	3840.0	DFT-s-OFDM BPSK	1@0	see graph	PASS
77	30	50	656000	3840.0	DFT-s-OFDM QPSK	1@0	see graph	---
77	30	50	656000	3840.0	DFT-s-OFDM QPSK	1@0	see graph	PASS
77	30	50	656000	3840.0	DFT-s-OFDM QPSK	1@0	see graph	PASS
77	30	50	663666	3954.99	DFT-s-OFDM BPSK	1@0	see graph	---
77	30	50	663666	3954.99	DFT-s-OFDM BPSK	1@0	see graph	PASS
77	30	50	663666	3954.99	DFT-s-OFDM BPSK	1@0	see graph	PASS
77	30	50	663666	3954.99	DFT-s-OFDM QPSK	1@0	see graph	---
77	30	50	663666	3954.99	DFT-s-OFDM QPSK	1@0	see graph	PASS
77	30	50	663666	3954.99	DFT-s-OFDM QPSK	1@0	see graph	PASS
77	30	100	650000	3750.0	DFT-s-OFDM BPSK	1@0	see graph	---
77	30	100	650000	3750.0	DFT-s-OFDM BPSK	1@0	see graph	PASS
77	30	100	650000	3750.0	DFT-s-OFDM BPSK	1@0	see graph	PASS
77	30	100	650000	3750.0	DFT-s-OFDM QPSK	1@0	see graph	---
77	30	100	650000	3750.0	DFT-s-OFDM QPSK	1@0	see graph	PASS
77	30	100	650000	3750.0	DFT-s-OFDM QPSK	1@0	see graph	PASS
77	30	100	656000	3840.0	DFT-s-OFDM BPSK	1@0	see graph	---
77	30	100	656000	3840.0	DFT-s-OFDM BPSK	1@0	see graph	PASS
77	30	100	656000	3840.0	DFT-s-OFDM BPSK	1@0	see graph	PASS
77	30	100	656000	3840.0	DFT-s-OFDM QPSK	1@0	see graph	---

77	30	100	656000	3840.0	DFT-s-OFDM QPSK	1@0	see graph	PASS
77	30	100	656000	3840.0	DFT-s-OFDM QPSK	1@0	see graph	PASS
77	30	100	662000	3930.0	DFT-s-OFDM BPSK	1@0	see graph	---
77	30	100	662000	3930.0	DFT-s-OFDM BPSK	1@0	see graph	PASS
77	30	100	662000	3930.0	DFT-s-OFDM BPSK	1@0	see graph	PASS
77	30	100	662000	3930.0	DFT-s-OFDM QPSK	1@0	see graph	---
77	30	100	662000	3930.0	DFT-s-OFDM QPSK	1@0	see graph	PASS
77	30	100	662000	3930.0	DFT-s-OFDM QPSK	1@0	see graph	PASS

N77(10M)_DFT-s-OFDM_BPSK_Edge_1RB_Left_Low_CH



N77(10M)_DFT-s-OFDM_BPSK_Edge_1RB_Left_Low_CH

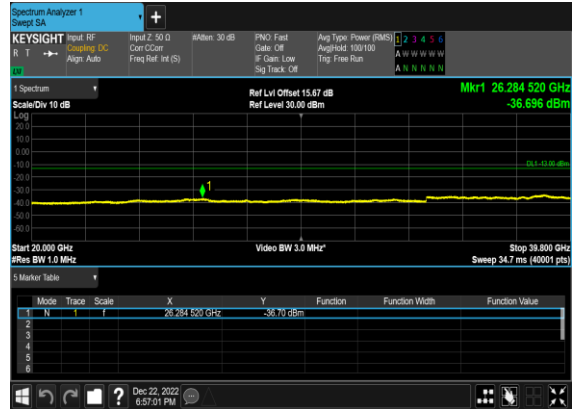

N77(10M)_DFT-s-OFDM_QPSK_Edge_1RB_Left_Low_CH

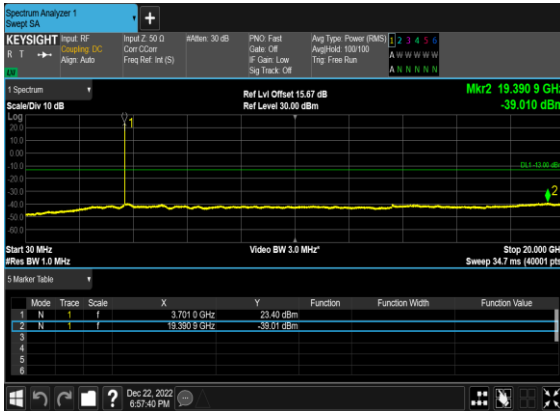

N77(10M)_DFT-s-OFDM_QPSK_Edge_1RB_Left_Low_CH

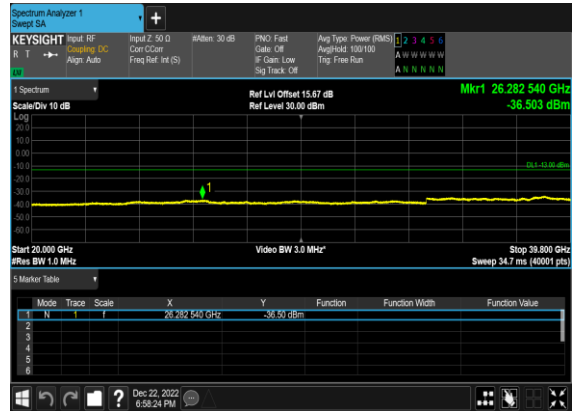

N77(10M)_DFT-s-OFDM_BPSK_Edge_1RB_Left_Mid_CH

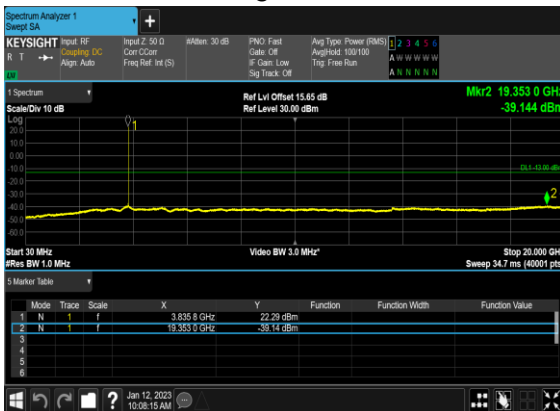

N77(10M)_DFT-s-OFDM_BPSK_Edge_1RB_Left_Mid_CH

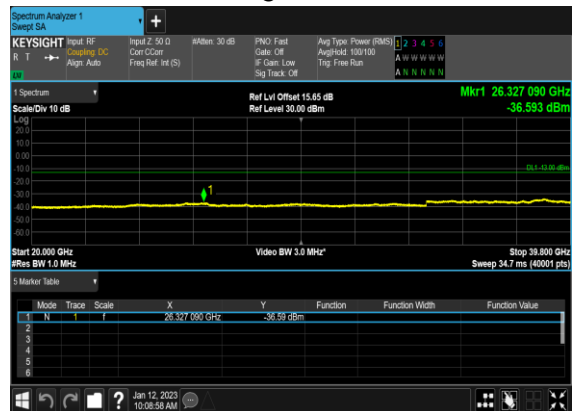

N77(10M)_DFT-s-OFDM_QPSK_Edge_1RB_Left_Mid_CH

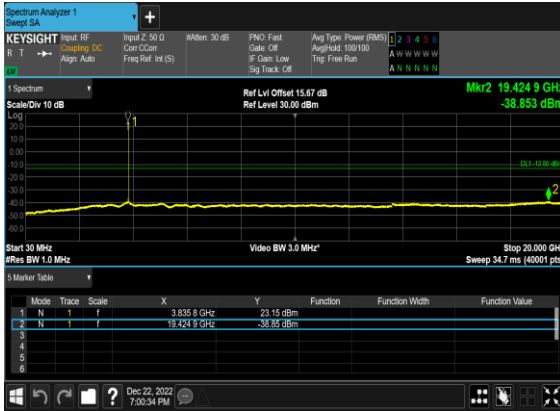

N77(10M)_DFT-s-OFDM_QPSK_Edge_1RB_Left_Mid_CH

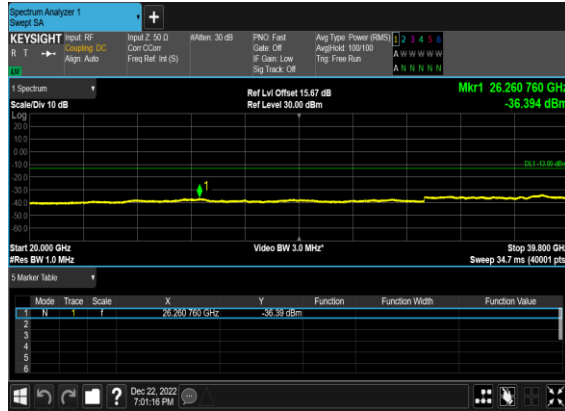

N77(10M)_DFT-s-OFDM_BPSK_Edge_1RB_Left_High_CH

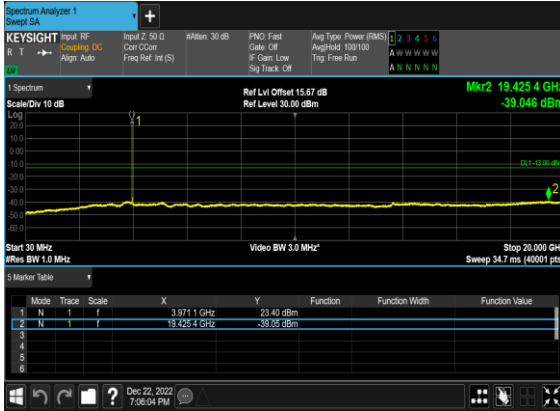

N77(10M)_DFT-s-OFDM_BPSK_Edge_1RB_Left_High_CH

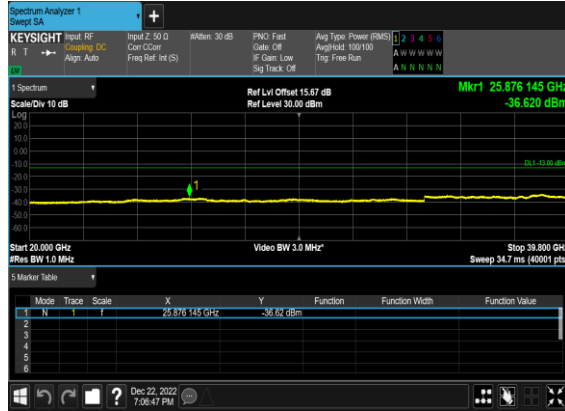

N77(10M)_DFT-s-OFDM_QPSK_Edge_1RB_Left_High_CH

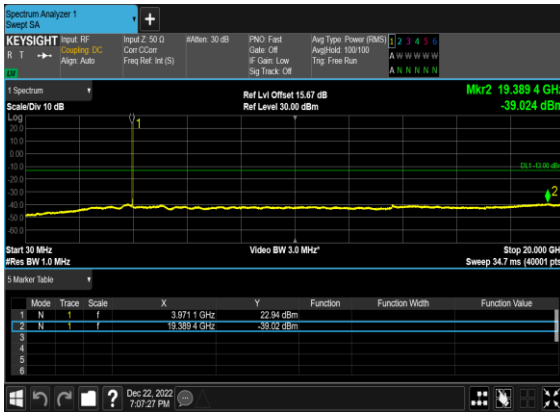

N77(10M)_DFT-s-OFDM_QPSK_Edge_1RB_Left_High_CH

