



# FCC RF Test Report

**APPLICANT** : Motorola Mobility LLC  
**EQUIPMENT** : Mobile Cellular Phone  
**BRAND NAME** : Motorola  
**MODEL NAME** : XT2321-3, XT2321-5  
**FCC ID** : IHDT56AJ3  
**STANDARD** : 47 CFR Part 2, 96  
**CLASSIFICATION** : Citizens Band End User Devices (CBE)  
**EQUIPMENT TYPE** : End User Equipment  
**TEST DATE(S)** : Jan. 02, 2023 ~ Jan. 28, 2023

We, Sporton International Inc. (Kunshan), would like to declare that the tested sample has been evaluated in accordance with the procedures given in ANSI C63.26 and shown compliance with the applicable technical standards.

This report contains data that were produced under subcontract by Sporton International Inc. (ShenZhen)

The test results in this report apply exclusively to the tested model / sample. Without written approval of Sporton International Inc. (Kunshan), the test report shall not be reproduced except in full.

*Jason Jia*

Approved by: Jason Jia



**Sporton International Inc. (Kunshan)**

**No. 1098, Pengxi North Road, Kunshan Economic Development Zone Jiangsu Province 215300  
People's Republic of China**



# Table of Contents

History of this test report..... 3

Summary of Test Result..... 4

**1 General Description ..... 5**

    1.1 Applicant..... 5

    1.2 Manufacturer ..... 5

    1.3 Feature of Equipment Under Test..... 5

    1.4 Specification of Accessory ..... 6

    1.5 Maximum EIRP Power and Emission Designator ..... 6

    1.6 Testing Site..... 7

    1.7 Test Software ..... 7

    1.8 Applied Standards ..... 8

**2 Test Configuration of Equipment Under Test ..... 9**

    2.1 Test Mode..... 9

    2.2 Connection Diagram of Test System ..... 11

    2.3 Support Unit used in test configuration ..... 11

    2.4 Measurement Results Explanation Example ..... 11

    2.5 Frequency List of Low/Middle/High Channels..... 12

**3 Conducted Test Items ..... 14**

    3.1 Measuring Instruments..... 14

    3.2 Conducted Output Power ..... 15

    3.3 EIRP ..... 16

    3.4 Occupied Bandwidth ..... 17

    3.5 Conducted Band Edge ..... 18

    3.6 Conducted Spurious Emission ..... 19

    3.7 Frequency Stability..... 20

**4 Radiated Test Items ..... 21**

    4.1 Measuring Instruments..... 21

    4.2 Test Setup ..... 21

    4.3 Test Result of Radiated Test..... 22

    4.4 Radiated Spurious Emission ..... 23

**5 List of Measuring Equipment..... 24**

**6 Uncertainty of Evaluation ..... 25**

**Appendix A. Test Results of Conducted Test**

**Appendix B. Test Results of Radiated Test**

**Appendix C. Test Setup Photographs**



### History of this test report

Report No.	Version	Description	Issued Date
FG2D0913G	01	Initial issue of report	Feb. 01, 2023



### Summary of Test Result

Report Clause	Ref Std. Clause	Test Items	Result (PASS/FAIL)	Remark
3.2	§2.1046	Conducted Output Power	Reporting only	-
-	§96.41	Peak-to-Average Ratio	Not Applicable	Not applicable for End User Devices
3.3	§96.41	Maximum E.I.R.P	Pass	-
		Maximum Power Spectral Density	Not Applicable	Not applicable for End User Devices
3.4	§2.1049 §96.41	Occupied Bandwidth	Reporting only	-
3.5	§2.1051 §96.41	Conducted Band Edge Measurement Adjacent Channel Leakage Ratio	Pass	-
3.6	§2.1051 §96.41	Conducted Spurious Emission	Pass	
3.7	§2.1055	Frequency Stability for Temperature & Voltage	Pass	-
4.4	§2.1051 §96.41	Radiated Spurious Emission	Pass	Under limit 12.16 dB at 10953.00 MHz

<b>Declaration of Conformity:</b>
The test results with all measurement uncertainty excluded are presented in accordance with the regulation limits or requirements declared by manufacturers.
<b>Comments and Explanations:</b>
The declared of product specification for EUT presented in the report are provided by the manufacturer, and the manufacturer takes all the responsibilities for the accuracy of product specification.



# 1 General Description

## 1.1 Applicant

Motorola Mobility LLC  
222 W,Merchandise Mart Plaza, Chicago IL 60654 USA

## 1.2 Manufacturer

Motorola Mobility LLC  
222 W,Merchandise Mart Plaza, Chicago IL 60654 USA

## 1.3 Feature of Equipment Under Test

Product Feature	
Equipment	Mobile Cellular Phone
Brand Name	Motorola
Model Name	XT2321-3, XT2321-5
FCC ID	IHDT56AJ3
Tx Frequency	LTE Band 48: 3550 MHz ~ 3700 MHz
Rx Frequency	LTE Band 48: 3550 MHz ~ 3700 MHz
Bandwidth	5MHz / 10MHz / 15MHz / 20MHz
Maximum Output Power to Antenna	<Ant.3>: LTE Band 48: 23.18dBm LTE Band 48C: 22.99dBm
Antenna Gain	<Ant.0>:-10.26 dBm <Ant.1>: -8.68 dBm <Ant.2>:-6.68 dBm <Ant.3>: -6.76 dBm
Type of Modulation	QPSK / 16QAM / 64QAM / 256QAM
IMEI Code	Conducted: 358041760019911/358041760019929 Radiation: 358041760025637/358041760025645
HW Version	DVT2
SW Version	TTZ 33.50
EUT Stage	Identical Prototype

**Remark:**

1. The above EUT's information was declared by manufacturer. Please refer to the specifications or user's manual for more detailed description.
2. The maximum EIRP is calculated from max output power and antenna gain, only the maximum EIRP of antenna 3 is shown in the report.
3. The EUT has two working states, flip open state and flip close state, by verifying these two states, we choose the worst flip open state for all tests.

### 1.4 Specification of Accessory

Specification of Accessory				
AC Adapter	Brand Name	Motorola (Salom)	Model Name	MC-301
Battery	Brand Name	Motorola (ATL)	Model Name	PM29
USB Cable 1	Brand Name	Motorola (Cabletech)	Model Name	SC18D13216
USB Cable 2	Brand Name	Motorola (Luxshare)	Model Name	SC18D13217
USB Cable 3	Brand Name	Motorola (Saibao)	Model Name	SC18D86732

### 1.5 Maximum EIRP Power and Emission Designator

LTE Band 48		QPSK		16QAM/64QAM/256QAM	
BW (MHz)	Frequency Range (MHz)	Maximum EIRP(W)	Emission Designator (99%OBW)	Maximum EIRP(W)	Emission Designator (99%OBW)
5	3552.5~3697.5	0.0431	4M49G7D	0.0429	4M49W7D
10	3555~3695	0.0431	9M05G7D	0.0431	9M01W7D
15	3557.5~3692.5	0.0436	13M5G7D	0.0430	13M6W7D
20	3560~3690	0.0439	17M9G7D	0.0437	17M9W7D

LTE Band 48 CA		QPSK		16QAM/64QAM/256QAM	
BW (MHz)	Frequency (MHz)	Maximum EIRP(W)	Emission Designator (99%OBW)	Maximum EIRP(W)	Emission Designator (99%OBW)
5MHz+20MHz	(3553.5 ~ 3690 MHz)	0.0416	23M5G7D	0.0416	23M2W7D
10MHz+20MHz	(3555.5 ~ 3690 MHz)	0.0414	28M2G7D	0.0410	28M2W7D
15MHz+20MHz	(3557.8 ~ 3690 MHz)	0.0417	32M9G7D	0.0415	32M9W7D
20MHz+5MHz	(3560 ~ 3696.7 MHz)	0.0412	23M3G7D	0.0410	23M2W7D
20MHz+10MHz	(3560 ~ 3694.5 MHz)	0.0417	28M2G7D	0.0416	28M1W7D
20MHz+15MHz	(3560 ~ 3692.2 MHz)	0.0416	32M7G7D	0.0414	32M9W7D
20MHz+20MHz	(3560 ~ 3690 MHz)	0.0420	37M8G7D	0.0414	37M7W7D

Note: All modulations have been tested, only the worst test results of PSK & QAM are shown in the report.



### 1.6 Testing Site

Sporton International Inc. (Kunshan) is accredited to ISO/IEC 17025:2017 by American Association for Laboratory Accreditation with Certificate Number 5145.02.

<b>Test Firm</b>	Sporton International Inc. (Kunshan)		
<b>Test Site Location</b>	No. 1098, Pengxi North Road, Kunshan Economic Development Zone Jiangsu Province 215300 People's Republic of China TEL : +86-512-57900158 FAX : +86-512-57900958		
<b>Test Site No.</b>	<b>Sporton Site No.</b>	<b>FCC Designation No.</b>	<b>FCC Test Firm Registration No.</b>
	TH01-KS	CN1257	314309

Sporton International Inc. (ShenZhen) is accredited to ISO/IEC 17025:2017 by American Association for Laboratory Accreditation with Certificate Number 5145.01.

<b>Test Firm</b>	Sporton International Inc. (ShenZhen)		
<b>Test Site Location</b>	101, 1st Floor, Block B, Building 1, No. 2, Tengfeng 4th Road, Fenghuang Community, Fuyong Street, Baoan District, Shenzhen City Guangdong Province China 518103 TEL: +86-755-33202398		
<b>Test Site No.</b>	<b>Sporton Site No.</b>	<b>FCC Designation No.</b>	<b>FCC Test Firm Registration No.</b>
	03CH01-SZ	CN1256	421272

### 1.7 Test Software

Item	Site	Manufacturer	Name	Version
1.	03CH01-SZ	AUDIX	E3	6.2009-8-24



## 1.8 Applied Standards

According to the specifications of the manufacturer, the EUT must comply with the requirements of the following standards:

- ♦ ANSI C63.26-2015
- ♦ 47 CFR Part 2, 96
- ♦ FCC KDB 971168 D01 Power Meas. License Digital Systems v03r01
- ♦ FCC KDB 940660 D01 Part 96 CBRS v03
- ♦ FCC KDB 412172 D01 Determining ERP and EIRP v01r01

**Remark:**

1. All test items were verified and recorded according to the standards and without any deviation during the test.
2. This EUT has also been tested and complied with the requirements of FCC Part 15, Subpart B, recorded in a separate test report.





## 2 Test Configuration of Equipment Under Test

### 2.1 Test Mode

Antenna port conducted and radiated test items listed below are performed according to KDB 971168 D01 Power Meas. License Digital Systems v03r01 with maximum output power.

For radiated measurement, pre-scanned in three orthogonal panels, X, Y, Z. The worst cases (Z plane) were recorded in this report.

Test Items	Band	Bandwidth (MHz)						Modulation				RB #			Test Channel			
		1.4	3	5	10	15	20	QPSK	16QAM	64QAM	256QAM	1	Half	Full	L	M	H	
Max. Output Power	48	-	-	v	v	v	v	v	v	v	v	v	v	v	v	v	v	
26dB and 99% Bandwidth	48	-	-	v	v	v	v	v	v					v		v		
Conducted Band Edge	48	-	-	v	v	v	v	v	v	v	v	v		v	v	v	v	
Conducted Spurious Emission	48	-	-	v	v	v	v	v					v			v	v	v
ACLR	48	-	-	v	v	v	v	v	v	v			v		v	v	v	v
E.I.R.P.	48	-	-	v	v	v	v	v	v	v	v		v	v	v	v	v	v
Frequency Stability	48	-	-		v			v					v				v	
Radiated Spurious Emission	48	Worst Case													v	v	v	
Remark	<ol style="list-style-type: none"> <li>The mark "v" means that this configuration is chosen for testing</li> <li>The mark "-" means that this bandwidth is not supported.</li> <li>The device is investigated from 30MHz to 10 times of fundamental signal for radiated spurious emission test under different RB size/offset and modulations in exploratory test. Subsequently, only the worst case emissions are reported.</li> <li>All the radiated test cases were performed with Adapter and USB cable 1.</li> </ol>																	



Test Items	Band	Bandwidth (MHz)								Modulation				RB #			Test Channel		
		20+20	20+15	15+20	20+10	10+20	10+10	20+5	5+20	QPSK	16QAM	64QAM	256 QAM	1	Half	Full	L	M	H
Max. Output Power	48C	v	v	v	v	v	-	v	v	v	v	v	v	v		v	v	v	v
26dB and 99% Bandwidth	48C	v	v	v	v	v	-	v	v	v	v					v		v	
Conducted Band Edge	48C	v	v	v	v	v	-	v	v	v	v	v		v		v	v	v	v
Conducted Spurious Emission	48C	v	v	v	v	v	-	v	v	v	v	v		v		v	v	v	v
Adjacent Channel Leakage Ratio	48C	v	v	v	v	v	-	v	v	v	v	v	v	v		v	v	v	v
E.I.R.P.	48C	v	v	v	v	v	-	v	v	v	v	v	v	v		v	v	v	v
Radiated Spurious Emission	48C	Worst Case														v	v	v	
Note	<ol style="list-style-type: none"> <li>The mark "v " means that this configuration is chosen for testing</li> <li>The mark "-" means that this bandwidth is not supported.</li> <li>The device is investigated from 30MHz to 10 times of fundamental signal for radiated spurious emission test under different RB size/offset and modulations in exploratory test. Subsequently, only the worst case emissions are reported.</li> <li>All test items are based on engineering evaluation.</li> <li>All the radiated test cases were performed with Adapter and USB Cable 1.</li> </ol>																		

## 2.2 Connection Diagram of Test System

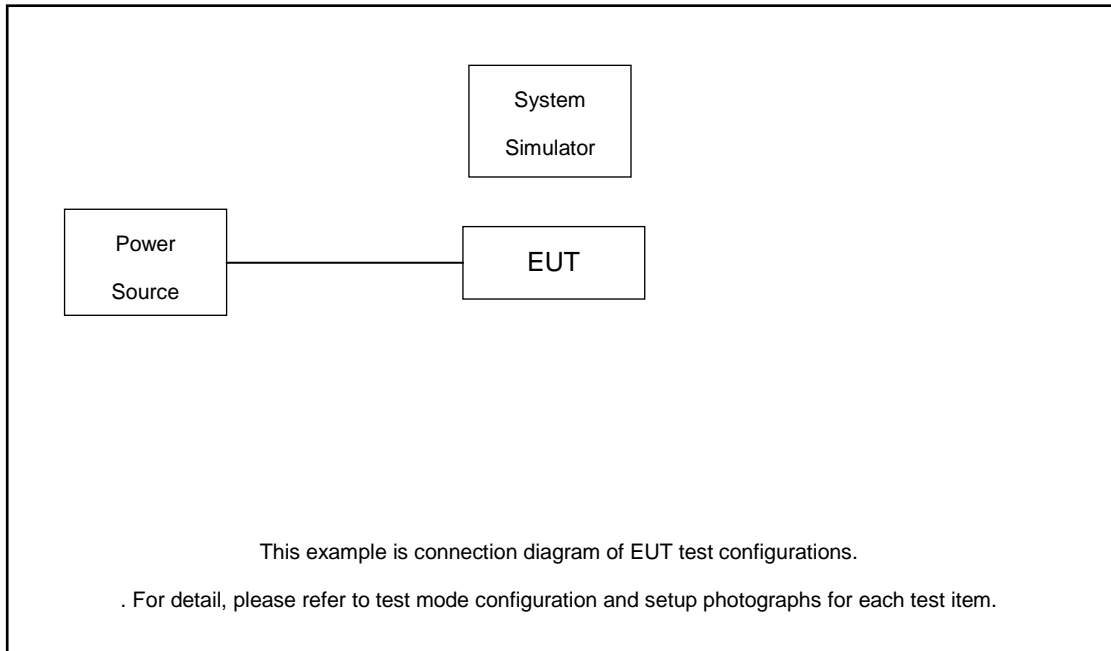

## 2.3 Support Unit used in test configuration

Item	Equipment	Trade Name	Model No.	FCC ID	Data Cable	Power Cord
1.	Power Supply	GWINSTEK	PSS-2002	N/A	N/A	Unshielded, 1.8 m
2.	LTE Base Station	Anritsu	MT8821C	N/A	N/A	Unshielded, 1.8 m

## 2.4 Measurement Results Explanation Example

### For all conducted test items:

The offset level is set in the spectrum analyzer to compensate the RF cable loss between EUT conducted output port and spectrum analyzer. With the offset compensation, the spectrum analyzer reading level is exactly the EUT RF output level.

The spectrum analyzer offset is derived from RF cable loss.

*Offset = RF cable loss.*

Following shows an offset computation example with cable loss 8.72 dB.

Example :

$$\begin{aligned} \text{Offset(dB)} &= \text{RF cable loss(dB)}. \\ &= 8.72 \text{ (dB)} \end{aligned}$$



## 2.5 Frequency List of Low/Middle/High Channels

LTE Band 48 Channel and Frequency List				
BW [MHz]	Channel/Frequency(MHz)	Lowest	Middle	Highest
20	Channel	55340	55990	56640
	Frequency	3560.0	3625.0	3690.0
15	Channel	55315	55990	56665
	Frequency	3557.5	3625.0	3692.5
10	Channel	55290	55990	56690
	Frequency	3555.0	3625.0	3695.0
5	Channel	55265	55990	56715
	Frequency	3552.5	3625.0	3697.5



LTE Band 48C_CA Channel and Frequency List					
BW [MHz]	Channel/Frequency(MHz)		Lowest	Middle	Highest
5 + 20	PCC	Channel	55273	55898	56523
		Frequency	3553.3	3615.8	3678.3
	SCC	Channel	55390	56015	56640
		Frequency	3565	3627.5	3690
20 + 5	PCC	Channel	55340	55965	56590
		Frequency	3560	3622.5	3685
	SCC	Channel	55457	56082	56707
		Frequency	3571.7	3634.2	3696.7
10 + 20	PCC	Channel	55295	55896	56496
		Frequency	3555.5	3615.6	3675.6
	SCC	Channel	55439	56040	56640
		Frequency	3569.9	3630	3690
20 + 10	PCC	Channel	55340	55941	56541
		Frequency	3560	3620.1	3680.1
	SCC	Channel	55484	56085	56685
		Frequency	3574.4	3634.5	3694.5
15 + 20	PCC	Channel	55318	55893	56469
		Frequency	3557.8	3615.3	3672.9
	SCC	Channel	55489	56064	56640
		Frequency	3574.9	3632.4	3690
20 + 15	PCC	Channel	55340	55916	56491
		Frequency	3560	3617.6	3675.1
	SCC	Channel	55511	56087	56662
		Frequency	3577.1	3634.7	3692.2
20 + 20	PCC	Channel	55340	55891	56442
		Frequency	3560	3615.1	3670.2
	SCC	Channel	55538	56089	56640
		Frequency	3579.8	3634.9	3690

### 3 Conducted Test Items

#### 3.1 Measuring Instruments

See list of measuring instruments of this test report.

##### 3.1.1 Test Setup

##### 3.1.2 Conducted Output Power

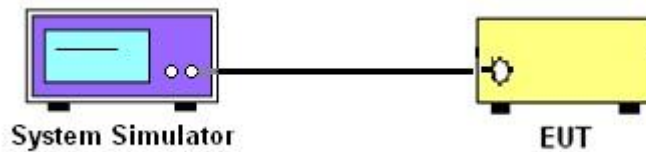

##### 3.1.3 PSD, Peak-to-Average Ratio, Occupied Bandwidth, Conducted Band-Edge and Conducted Spurious Emission

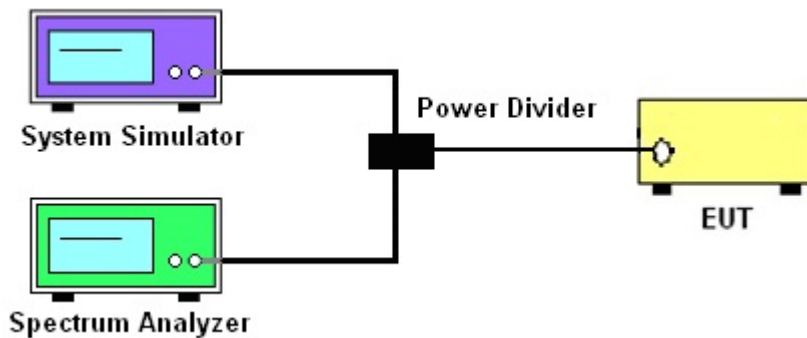

##### 3.1.4 Frequency Stability

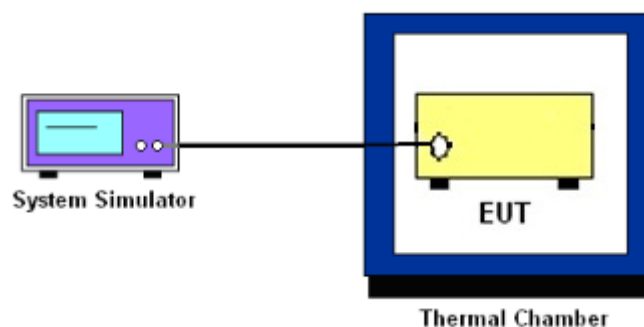

##### 3.1.5 Test Result of Conducted Test

Please refer to Appendix A.



## **3.2 Conducted Output Power**

### **3.2.1 Description of the Conducted Output Power Measurement**

A system simulator was used to establish communication with the EUT. Its parameters were set to force the EUT transmitting at maximum output power. The measured power in the radio frequency on the transmitter output terminals shall be reported.

### **3.2.2 Test Procedures**

1. The transmitter output port was connected to the system simulator.
2. Set EUT at maximum power through the system simulator.
3. Select lowest, middle, and highest channels for each band and different modulation.
4. Measure and record the power level from the system simulator.

### 3.3 EIRP

#### 3.3.1 Description of the EIRP Measurement

EIRP and PSD limits for CBRS equipment as below table:

Device		Maximum EIRP (dBm/10 MHz)	Maximum PSD (dBm/MHz)
Applied	End User Device	23	n/a
<input type="checkbox"/>	Category A CBSD	30	20
<input type="checkbox"/>	Category B CBSD	47	37

**Remark:**

1. The worst case EIRP shown in this section is found with LTE operating only using 1RB. As such, the EIRP/10MHz and full channel EIRP values will be identical since 1RB is fully contained within all available channel bandwidths for LTE Band 48 (i.e. 5, 10, 15, 20MHz)

#### 3.3.2 Test Procedures for EIRP

1. Establishing a communications link with the call box (Base station) to measure the Maximum conducted power, the parameters were set to force the EUT transmitting at maximum output power level. Use the average power measurement function to measure total channel power of each channel bandwidth (per ANSI C63.26-2015 Section 5.2.1)
2. Determining ERP and/or EIRP from conducted RF output power measurements (Per ANSI C63.26-2015 Section 5.2.5.5)
 

$EIRP = P_T + G_T - L_C$ ,  $ERP = EIRP - 2.15$ , where  
 $P_T$  = transmitter output power in dBm  
 $G_T$  = gain of the transmitting antenna in dBi  
 $L_C$  = signal attenuation in the connecting cable between the transmitter and antenna in dB





### 3.4 Occupied Bandwidth

#### 3.4.1 Description of Occupied Bandwidth Measurement

The occupied bandwidth is the width of a frequency band such that, below the lower and above the upper frequency limits, the mean powers emitted are each equal to a specified percentage 0.5% of the total mean transmitted power.

The 26 dB emission bandwidth is defined as the frequency range between two points, one above and one below the carrier frequency, at which the spectral density of the emission is attenuated 26 dB below the maximum in-band spectral density of the modulated signal. Spectral density (power per unit bandwidth) is to be measured with a detector of resolution bandwidth equal to approximately 1.0% of the emission bandwidth.

#### 3.4.2 Test Procedures

The testing follows ANSI C63.26-2015 Section 5.4.3 (26dB) and Section 5.4.4 (99OB)

1. The EUT was connected to spectrum analyzer and system simulator via a power divider.
2. The spectrum analyzer center frequency is set to the nominal EUT channel center frequency. The span range for the spectrum analyzer shall be between two and five times the anticipated OBW.
3. The nominal resolution bandwidth (RBW) shall be in the range of 1 to 5 % of the anticipated OBW, and the VBW shall be at least 3 times the RBW.
4. Set the detection mode to peak, and the trace mode to max hold.
5. Determine the reference value: Set the EUT to transmit a modulated signal. Allow the trace to stabilize. Set the spectrum analyzer marker to the highest level of the displayed trace.  
(this is the reference value)
6. Determine the “-26 dB down amplitude” as equal to (Reference Value – X).
7. Place two markers, one at the lowest and the other at the highest frequency of the envelope of the spectral display such that each marker is at or slightly below the “-X dB down amplitude” determined in step 6. If a marker is below this “-X dB down amplitude” value it shall be placed as close as possible to this value. The OBW is the positive frequency difference between the two markers.
8. Use the 99 % power bandwidth function of the spectrum analyzer and report the measured bandwidth.



### 3.5 Conducted Band Edge

#### 3.5.1 Description of Conducted Band Edge Measurement

Part 96.41 (e) (1) (i)

For CBSD the emission limits outside the fundamental are as follows:

Within 0 MHz to 10 MHz above and below the assigned channel  $\leq -13$  dBm/MHz

Greater than 10 MHz above and below the assigned channel  $\leq -25$  dBm/MHz

Part 96.41 (e) (1) (ii)

For End User Devices the emission limits outside the fundamental are as follows:

Within 0 MHz to B MHz above and below the assigned channel  $\leq -13$  dBm/MHz

Greater than B MHz above and below the assigned channel  $\leq -25$  dBm/MHz

where B is the bandwidth in megahertz of the assigned channel or multiple contiguous channels of the End User Device.

Notwithstanding the emission limits in this paragraph, the Adjacent Channel Leakage Ratio for End User Devices shall be at least 30 dB.

Part 96.41 (e) (2)

For CBSDs and End User Devices, the conducted power of emissions below 3540 MHz or above 3710 MHz shall not exceed  $-25$  dBm/MHz, and the conducted power of emissions below 3530 MHz or above 3720 MHz shall not exceed  $-40$ dBm/MHz

#### 3.5.2 Test Procedures

The testing follows FCC KDB 971168 D01 v03r01 Section 6.1.

1. The EUT was connected to spectrum analyzer and system simulator via a power divider.
2. The band edges of low and high channels for the highest RF powers were measured.
3. Set RBW  $\geq 1\%$  EBW in the 1MHz band immediately outside and adjacent to the band edge.
4. Beyond the 1 MHz band from the band edge, RBW=1MHz was used
5. Offset has included the duty factor for LTE Band 48. Duty factor  $=10 \log (1/x)$ , where x is the measured duty cycle.
6. Set spectrum analyzer with RMS detector.
7. The RF fundamental frequency should be excluded against the limit line in the operating frequency band.



## 3.6 Conducted Spurious Emission

### 3.6.1 Description of Conducted Spurious Emission Measurement

96.41 (e)(2)

The conducted power of any emissions below 3530 MHz or above 3720 MHz shall not exceed -40dBm/MHz.

### 3.6.2 Test Procedures

The testing follows FCC KDB 971168 D01 v03r01 Section 6.1.

1. The EUT was connected to spectrum analyzer and system simulator via a power divider.
2. The RF output of EUT was connected to the spectrum analyzer by RF cable and attenuator. The path loss was compensated to the results for each measurement.
3. The middle channel for the highest RF power within the transmitting frequency was measured.
4. The conducted spurious emission for the whole frequency range was taken.
5. Make the measurement with the spectrum analyzer's RBW = 1MHz, VBW = 3MHz.
6. Set spectrum analyzer with RMS detector.
7. Taking the record of maximum spurious emission.
8. The RF fundamental frequency should be excluded against the limit line in the operating frequency band.
9. The limit line is -40dBm/MHz.

## 3.7 Frequency Stability

### 3.7.1 Description of Frequency Stability Measurement

The frequency stability shall be measured by variation of ambient temperature and variation of primary supply voltage to ensure that the fundamental emission stays within the authorized frequency block. The frequency stability of the transmitter shall be maintained within  $\pm 0.00025\%$  ( $\pm 2.5\text{ppm}$ ) of the center frequency

### 3.7.2 Test Procedures for Temperature Variation

The testing follows FCC KDB 971168 D01 v03r01 Section 9.0.

1. The EUT was set up in the thermal chamber and connected with the system simulator.
2. With power OFF, the temperature was decreased to  $-30^{\circ}\text{C}$  and the EUT was stabilized before testing. Power was applied and the maximum change in frequency was recorded within one minute.
3. With power OFF, the temperature was raised in  $10^{\circ}\text{C}$  step up to  $50^{\circ}\text{C}$ . The EUT was stabilized at each step for at least half an hour. Power was applied and the maximum frequency change was recorded within one minute.

### 3.7.3 Test Procedures for Voltage Variation

The testing follows FCC KDB 971168 D01 v03r01 Section 9.0.

1. The EUT was placed in a temperature chamber at  $25\pm 5^{\circ}\text{C}$  and connected with the system simulator.
2. The power supply voltage to the EUT was varied from 85% to 115% of the nominal value measured at the input to the EUT.
3. The variation in frequency was measured for the worst case.

## 4 Radiated Test Items

### 4.1 Measuring Instruments

See list of measuring instruments of this test report.

### 4.2 Test Setup

#### 4.2.1 For radiated test below 30MHz

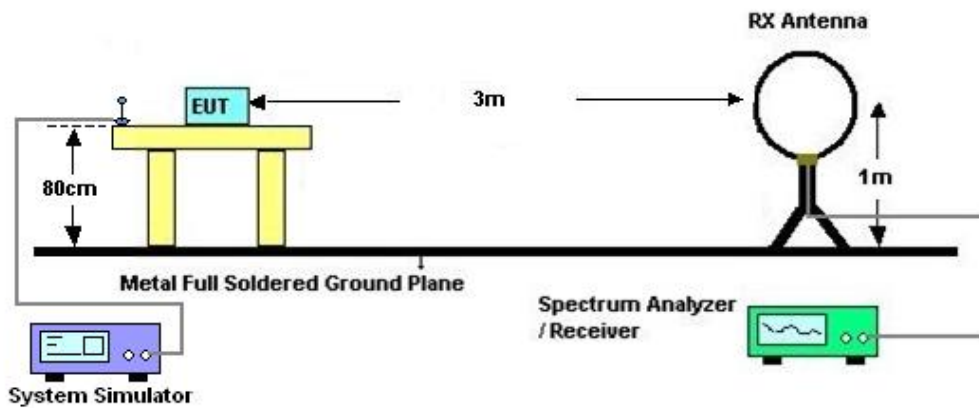

#### 4.2.2 For radiated test from 30MHz to 1GHz

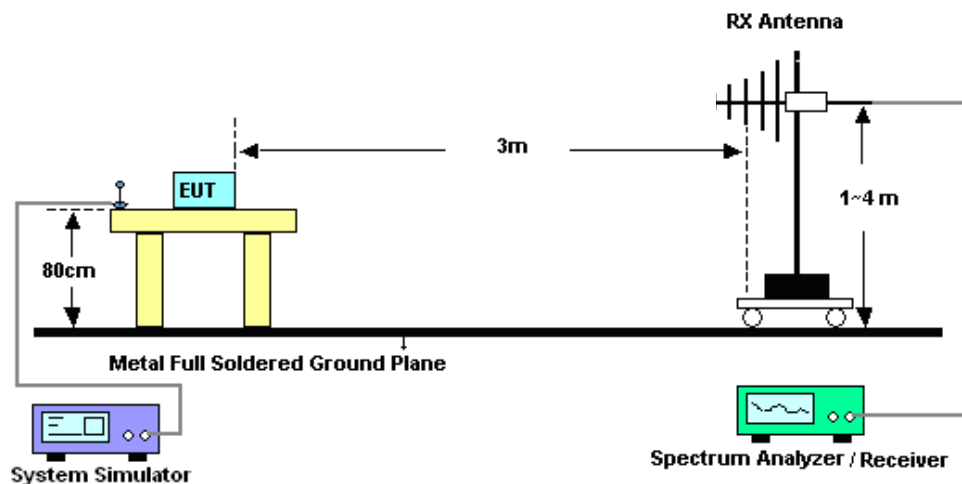

### 4.2.3 For radiated test above 1GHz

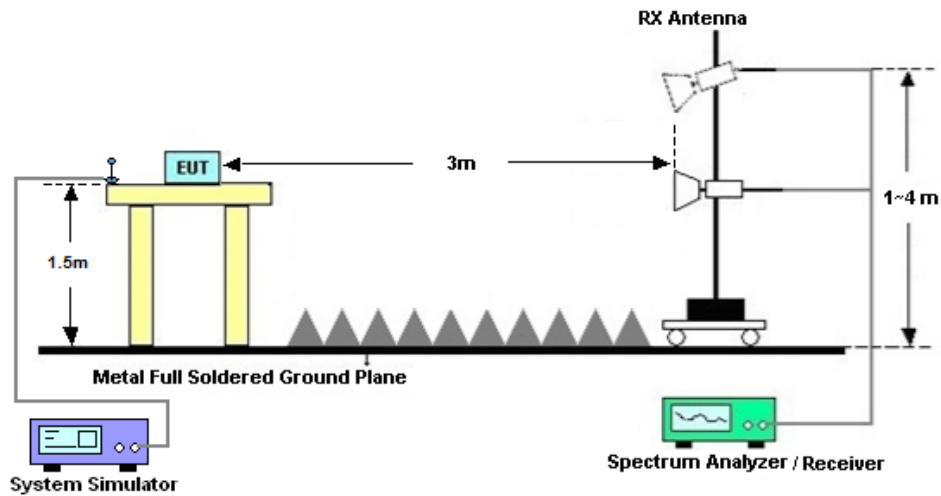

### 4.3 Test Result of Radiated Test

The low frequency, which started from 9 kHz to 30MHz, was pre-scanned and the result which was 20dB lower than the limit line was not reported.

Please refer to Appendix B.



## 4.4 Radiated Spurious Emission

### 4.4.1 Description of Radiated Spurious Emission Measurement

The radiated spurious emission was measured by substitution method according to ANSI C63.26-2015. The power of any emission outside of the authorized operating frequency ranges must be attenuated below the transmitter power (P) by a factor of at least -40dBm / MHz. The spectrum is scanned from 30 MHz up to a frequency including its 10th harmonic.

### 4.4.2 Test Procedures

1. The EUT was placed on a turntable with 0.8 meter height for frequency below 1GHz and 1.5 meter height for frequency above 1GHz respectively above ground.
2. The EUT was set 3 meters from the receiving antenna mounted on the antenna tower.
3. The table was rotated 360 degrees to determine the position of the highest spurious emission.
4. The height of the receiving antenna is varied between 1m to 4m to search the maximum spurious emission for both horizontal and vertical polarizations.
5. During the measurement, the system simulator parameters were set to force the EUT transmitting at maximum output power.
6. Make the measurement with the spectrum analyzer's RBW = 1MHz, VBW = 3MHz, taking the record of maximum spurious emission.
7. A horn antenna was substituted in place of the EUT and was driven by a signal generator. Tune the output power of signal generator to the same emission level with EUT maximum spurious emission.  
$$\text{EIRP (dBm)} = \text{S.G. Power} - \text{Tx Cable Loss} + \text{Tx Antenna Gain}$$
$$\text{ERP (dBm)} = \text{EIRP} - 2.15$$
8. The RF fundamental frequency should be excluded against the limit line in the operating frequency band.  
The limit line is -40dBm/MHz



## 5 List of Measuring Equipment

Instrument	Manufacturer	Model No.	Serial No.	Characteristics	Calibration Date	Test Date	Due Date	Remark
Spectrum Analyzer	R&S	FSV40	101040	10Hz~40GHz	Oct. 12, 2022	Jan. 02, 2023~Jan. 28, 2023	Oct. 11, 2023	Conducted (TH01-KS)
Power divider	STI	STI08-0055	-	0.5~40GHz	Aug. 26, 2022	Jan. 02, 2023~Jan. 28, 2023	Aug. 25, 2023	Conducted (TH01-KS)
Temperature & humidity chamber	Hongzhan	LP-150U	H2014011440	-40~+150°C 20%~95%RH	Jul. 15, 2022	Jan. 02, 2023~Jan. 28, 2023	Jul. 14, 2023	Conducted (TH01-KS)
EMI Test Receiver&SA	Agilent	N9038A	MY52260185	20Hz~26.5GHz	Dec. 26, 2022	Jan. 09, 2023	Dec. 25, 2023	Radiation (03CH01-SZ)
Loop Antenna	R&S	HFH2-Z2	100354	9kHz~30MHz	Jul. 28, 2022	Jan. 09, 2023	Jul. 27, 2024	Radiation (03CH01-SZ)
HF Amplifier	KEYSIGHT	83017A	MY53270105	0.5GHz~26.5Ghz	Oct.19, 2022	Jan. 09, 2023	Oct.18, 2023	Radiation (03CH01-SZ)
Bilog Antenna	TeseQ	CBL6112D	35407	30MHz-2GHz	Sep. 28, 2021	Jan. 09, 2023	Sep. 27, 2023	Radiation (03CH01-SZ)
Double Ridge Horn Antenna	ETS-Lindgren	3117	00119436	1GHz~18GHz	Jul. 07, 2022	Jan. 09, 2023	Jul. 06, 2023	Radiation (03CH01-SZ)
SHF-EHF Horn	com-power	AH-840	101071	18Ghz-40GHz	Apr. 10, 2022	Jan. 09, 2023	Apr. 09, 2023	Radiation (03CH01-SZ)
LF Amplifier	Burgeon	BPA-530	102209	0.01~3000Mhz	Apr. 06, 2022	Jan. 09, 2023	Apr. 05, 2023	Radiation (03CH01-SZ)
HF Amplifier	MITEQ	AMF-7D-00 101800-30-1 0P-R	1943528	1GHz~18GHz	Oct. 19, 2022	Jan. 09, 2023	Oct. 18, 2023	Radiation (03CH01-SZ)
HF Amplifier	MITEQ	TTA1840-35 -HG	1871923	18GHz~40GHz	Jul. 06, 2022	Jan. 09, 2023	Jul. 05, 2023	Radiation (03CH01-SZ)
AC Power Source	Chroma	61601	61601000198 5	N/A	Nov. 10, 2022	Jan. 09, 2023	Nov. 09, 2023	Radiation (03CH01-SZ)
Turn Table	EM	EM1000	N/A	0~360 degree	NCR	Jan. 09, 2023	NCR	Radiation (03CH01-SZ)
Antenna Mast	EM	EM1000	N/A	1 m~4 m	NCR	Jan. 09, 2023	NCR	Radiation (03CH01-SZ)

NCR: No Calibration Required





## 6 Uncertainty of Evaluation

### Uncertainty of Conducted Measurement

Test Item	Uncertainty
Conducted Power	±0.46 dB
Conducted Emissions	±0.48 dB
Occupied Channel Bandwidth	±0.1 %

### Uncertainty of Radiated Emission Measurement (30 MHz ~ 1000 MHz)

Measuring Uncertainty for a Level of Confidence of 95% (U = 2Uc(y))	2.48dB
---	--------

### Uncertainty of Radiated Emission Measurement (1GHz ~ 18GHz)

Measuring Uncertainty for a Level of Confidence of 95% (U = 2Uc(y))	3.53dB
---	--------

### Uncertainty of Radiated Emission Measurement (18GHz ~ 40GHz)

Measuring Uncertainty for a Level of Confidence of 95% (U = 2Uc(y))	4.02dB
---	--------

----- THE END -----



# Appendix A. Test Results of Conducted Test

## Conducted Output Power(Average power)

BW [MHz]	Modulation	RB Size	RB Offset	Power Low Ch. / Freq.	for EMC Power Middle Ch. / Freq.	Power High Ch. / Freq.
Channel				55340	55990	56640
Frequency (MHz)				3560	3625	3690
20	QPSK	1	0	23.12	23.18	23.15
20	QPSK	1	49	23.07	23.05	23.00
20	QPSK	1	99	22.99	23.02	23.05
20	QPSK	50	0	23.09	23.16	23.08
20	QPSK	50	24	23.04	22.99	23.03
20	QPSK	50	50	22.96	22.97	22.97
20	QPSK	100	0	22.88	23.05	23.07
20	16QAM	1	0	23.01	23.08	23.16
20	16QAM	1	49	22.95	22.96	22.96
20	16QAM	1	99	22.87	23.02	22.92
20	16QAM	50	0	23.06	23.16	23.14
20	16QAM	50	24	22.97	22.96	22.98
20	16QAM	50	50	22.96	22.91	22.86
20	16QAM	100	0	22.85	23.03	23.01
20	64QAM	1	0	22.90	23.01	23.12
20	64QAM	1	49	22.93	22.95	22.94
20	64QAM	1	99	22.81	22.84	22.77
20	64QAM	50	0	22.93	23.09	23.04
20	64QAM	50	24	22.98	22.97	22.90
20	64QAM	50	50	22.82	22.92	22.92
20	64QAM	100	0	22.92	23.00	22.92
20	256QAM	1	0	19.90	20.03	20.04
20	256QAM	1	49	19.87	20.10	20.02
20	256QAM	1	99	19.76	19.90	19.96
20	256QAM	50	0	20.03	20.20	20.17
20	256QAM	50	24	19.94	19.94	19.98
20	256QAM	50	50	19.93	19.96	20.05
20	256QAM	100	0	20.01	20.19	20.20
Channel				55315	55990	56665
Frequency (MHz)				3557.5	3625	3692.5
15	QPSK	1	0	22.99	23.15	23.11
15	QPSK	1	37	22.99	23.01	22.97
15	QPSK	1	74	22.90	22.96	22.94
15	QPSK	36	0	22.97	23.05	22.99
15	QPSK	36	20	22.93	22.95	22.94
15	QPSK	36	39	22.86	22.84	22.89
15	QPSK	75	0	22.84	22.98	22.98
15	16QAM	1	0	22.87	23.02	23.04
15	16QAM	1	37	22.85	22.84	22.81



15	16QAM	1	74	22.81	22.99	22.89
15	16QAM	36	0	22.92	23.04	23.09
15	16QAM	36	20	22.85	22.82	22.87
15	16QAM	36	39	22.81	22.80	22.78
15	16QAM	75	0	22.75	22.99	22.87
15	64QAM	1	0	22.78	22.95	23.08
15	64QAM	1	37	22.81	22.84	22.79
15	64QAM	1	74	22.67	22.74	22.69
15	64QAM	36	0	22.86	22.95	22.92
15	64QAM	36	20	22.87	22.85	22.83
15	64QAM	36	39	22.74	22.80	22.78
15	64QAM	75	0	22.86	22.90	22.87
15	256QAM	1	0	19.86	19.94	19.99
15	256QAM	1	37	19.80	19.97	19.93
15	256QAM	1	74	19.62	19.86	19.84
15	256QAM	36	0	20.00	20.08	20.05
15	256QAM	36	20	19.80	19.91	19.91
15	256QAM	36	39	19.83	19.92	19.99
15	256QAM	75	0	19.89	20.09	20.07
Channel				55290	55990	56690
Frequency (MHz)				3555	3625	3695
10	QPSK	1	0	22.97	23.08	23.10
10	QPSK	1	25	23.01	22.95	22.96
10	QPSK	1	49	22.89	22.91	22.93
10	QPSK	25	0	23.05	23.05	22.93
10	QPSK	25	12	22.92	22.87	22.89
10	QPSK	25	25	22.92	22.94	22.86
10	QPSK	50	0	22.78	23.02	22.92
10	16QAM	1	0	22.91	22.94	23.02
10	16QAM	1	25	22.85	22.88	22.88
10	16QAM	1	49	22.76	22.88	22.86
10	16QAM	25	0	22.91	23.06	23.10
10	16QAM	25	12	22.90	22.93	22.85
10	16QAM	25	25	22.86	22.80	22.83
10	16QAM	50	0	22.81	22.95	22.89
10	64QAM	1	0	22.82	22.88	23.03
10	64QAM	1	25	22.87	22.89	22.89
10	64QAM	1	49	22.72	22.71	22.73
10	64QAM	25	0	22.90	22.98	22.94
10	64QAM	25	12	22.86	22.88	22.75
10	64QAM	25	25	22.78	22.85	22.77
10	64QAM	50	0	22.86	22.91	22.87
10	256QAM	1	0	19.77	19.97	19.92
10	256QAM	1	25	19.83	19.98	19.98
10	256QAM	1	49	19.72	19.80	19.83
10	256QAM	25	0	19.88	20.13	20.03
10	256QAM	25	12	19.83	19.91	19.94
10	256QAM	25	25	19.85	19.84	19.97
10	256QAM	50	0	19.96	20.14	20.05
Channel				55265	55990	56715



Frequency (MHz)				3552.5	3625	3697.5
5	QPSK	1	0	23.08	23.07	23.10
5	QPSK	1	12	23.03	22.97	22.88
5	QPSK	1	24	22.90	22.98	22.98
5	QPSK	12	0	22.96	23.02	23.00
5	QPSK	12	7	22.95	22.93	22.97
5	QPSK	12	13	22.83	22.87	22.88
5	QPSK	25	0	22.79	22.94	22.93
5	16QAM	1	0	22.94	22.99	23.08
5	16QAM	1	12	22.84	22.87	22.93
5	16QAM	1	24	22.83	22.92	22.80
5	16QAM	12	0	23.02	23.04	23.01
5	16QAM	12	7	22.83	22.92	22.92
5	16QAM	12	13	22.87	22.85	22.74
5	16QAM	25	0	22.79	22.98	22.89
5	64QAM	1	0	22.82	22.93	23.02
5	64QAM	1	12	22.88	22.85	22.90
5	64QAM	1	24	22.75	22.79	22.72
5	64QAM	12	0	22.80	22.99	22.99
5	64QAM	12	7	22.87	22.90	22.75
5	64QAM	12	13	22.76	22.82	22.82
5	64QAM	25	0	22.87	22.87	22.77
5	256QAM	1	0	19.81	19.97	19.99
5	256QAM	1	12	19.81	19.96	19.98
5	256QAM	1	24	19.70	19.85	19.82
5	256QAM	12	0	20.00	20.16	20.09
5	256QAM	12	7	19.79	19.87	19.83
5	256QAM	12	13	19.87	19.83	20.02
5	256QAM	25	0	19.94	20.06	20.08



**CA Power& EIRP**

BW [MHz]	Modulation	RB Size	RB Offset	Power Low	for EMC Power	Power High	Gain	EIRP	EIRP	EIRP
				Ch. / Freq.	Middle Ch. / Freq.	Ch. / Freq.		L	M	H
Channel				L	M	H		L	M	H
20+20	QPSK	1RB01RBMAX		2.06	2.80	2.62	-6.76	0.0003	0.0004	0.0004
	QPSK	1RBMAX1RB0		19.67	22.99	20.51	-6.76	0.0195	0.0420	0.0237
	QPSK	FULL		13.53	20.89	14.38	-6.76	0.0048	0.0259	0.0058
	16QAM	1RB01RBMAX		2.05	2.75	2.52	-6.76	0.0003	0.0004	0.0004
	16QAM	1RBMAX1RB0		19.65	22.93	20.45	-6.76	0.0195	0.0414	0.0234
	16QAM	FULL		13.57	20.88	14.23	-6.76	0.0048	0.0258	0.0056
	64QAM	1RB01RBMAX		2.18	2.76	2.67	-6.76	0.0003	0.0004	0.0004
	64QAM	1RBMAX1RB0		19.63	22.77	20.46	-6.76	0.0194	0.0399	0.0234
	64QAM	FULL		13.51	20.87	14.24	-6.76	0.0047	0.0258	0.0056
	256QAM	1RB01RBMAX		1.14	1.82	1.53	-6.76	0.0003	0.0003	0.0003
	256QAM	1RBMAX1RB0		19.33	20.31	20.04	-6.76	0.0181	0.0226	0.0213
	256QAM	FULL		13.56	20.37	14.15	-6.76	0.0048	0.0230	0.0055
20+15	QPSK	1RB01RBMAX		1.96	2.81	2.61	-6.76	0.0003	0.0004	0.0004
	QPSK	1RBMAX1RB0		18.05	22.95	18.87	-6.76	0.0135	0.0416	0.0163
	QPSK	FULL		13.53	20.97	14.22	-6.76	0.0048	0.0264	0.0056
	16QAM	1RB01RBMAX		1.85	2.72	2.58	-6.76	0.0003	0.0004	0.0004
	16QAM	1RBMAX1RB0		18.11	22.93	18.86	-6.76	0.0136	0.0414	0.0162
	16QAM	FULL		13.47	20.94	14.23	-6.76	0.0047	0.0262	0.0056
	64QAM	1RB01RBMAX		1.94	2.75	2.77	-6.76	0.0003	0.0004	0.0004
	64QAM	1RBMAX1RB0		18.31	22.92	19.03	-6.76	0.0143	0.0413	0.0169
	64QAM	FULL		13.42	20.92	14.19	-6.76	0.0046	0.0261	0.0055
	256QAM	1RB01RBMAX		0.90	1.78	1.65	-6.76	0.0003	0.0003	0.0003
	256QAM	1RBMAX1RB0		18.11	20.34	18.87	-6.76	0.0136	0.0228	0.0163
	256QAM	FULL		13.46	20.44	14.21	-6.76	0.0047	0.0233	0.0056
20+10	QPSK	1RB01RBMAX		1.89	2.84	2.61	-6.76	0.0003	0.0004	0.0004
	QPSK	1RBMAX1RB0		18.17	22.96	18.82	-6.76	0.0138	0.0417	0.0161
	QPSK	FULL		13.44	20.96	14.15	-6.76	0.0047	0.0263	0.0055
	16QAM	1RB01RBMAX		1.83	2.83	2.50	-6.76	0.0003	0.0004	0.0004
	16QAM	1RBMAX1RB0		18.15	22.95	18.86	-6.76	0.0138	0.0416	0.0162
	16QAM	FULL		13.37	20.91	14.13	-6.76	0.0046	0.0260	0.0055
	64QAM	1RB01RBMAX		1.87	2.79	2.66	-6.76	0.0003	0.0004	0.0004
	64QAM	1RBMAX1RB0		18.23	22.74	19.14	-6.76	0.0140	0.0396	0.0173
	64QAM	FULL		13.43	20.92	14.12	-6.76	0.0046	0.0261	0.0054
	256QAM	1RB01RBMAX		0.87	1.58	1.52	-6.76	0.0003	0.0003	0.0003
	256QAM	1RBMAX1RB0		18.20	20.38	18.99	-6.76	0.0139	0.0230	0.0167
	256QAM	FULL		13.47	20.42	14.20	-6.76	0.0047	0.0232	0.0055
20+5	QPSK	1RB01RBMAX		1.93	2.90	2.61	-6.76	0.0003	0.0004	0.0004
	QPSK	1RBMAX1RB0		19.11	22.91	19.84	-6.76	0.0172	0.0412	0.0203
	QPSK	FULL		12.46	21.43	13.19	-6.76	0.0037	0.0293	0.0044
	16QAM	1RB01RBMAX		1.83	2.83	2.50	-6.76	0.0003	0.0004	0.0004
	16QAM	1RBMAX1RB0		19.35	22.89	19.90	-6.76	0.0182	0.0410	0.0206
	16QAM	FULL		12.44	21.45	13.25	-6.76	0.0037	0.0294	0.0045



	64QAM	1RB01RBMAX	1.96	2.89	2.53	-6.76	0.0003	0.0004	0.0004
	64QAM	1RBMAX1RB0	19.35	22.88	20.14	-6.76	0.0182	0.0409	0.0218
	64QAM	FULL	12.41	21.46	13.22	-6.76	0.0037	0.0295	0.0044
	256QAM	1RB01RBMAX	0.73	1.83	1.64	-6.76	0.0002	0.0003	0.0003
	256QAM	1RBMAX1RB0	19.33	20.28	19.99	-6.76	0.0181	0.0225	0.0210
	256QAM	FULL	12.40	20.40	13.15	-6.76	0.0037	0.0231	0.0044
15+20	QPSK	1RB01RBMAX	2.01	2.76	2.60	-6.76	0.0003	0.0004	0.0004
	QPSK	1RBMAX1RB0	18.09	22.96	18.89	-6.76	0.0136	0.0417	0.0163
	QPSK	FULL	13.44	20.89	14.16	-6.76	0.0047	0.0259	0.0055
	16QAM	1RB01RBMAX	1.95	2.66	2.58	-6.76	0.0003	0.0004	0.0004
	16QAM	1RBMAX1RB0	18.17	22.94	18.92	-6.76	0.0138	0.0415	0.0164
	16QAM	FULL	13.41	20.82	14.17	-6.76	0.0046	0.0255	0.0055
	64QAM	1RB01RBMAX	2.02	2.80	2.65	-6.76	0.0003	0.0004	0.0004
	64QAM	1RBMAX1RB0	18.21	22.93	19.08	-6.76	0.0140	0.0414	0.0171
	64QAM	FULL	13.48	20.88	14.13	-6.76	0.0047	0.0258	0.0055
	256QAM	1RB01RBMAX	0.97	1.70	1.61	-6.76	0.0003	0.0003	0.0003
	256QAM	1RBMAX1RB0	18.29	20.33	19.03	-6.76	0.0142	0.0228	0.0169
	256QAM	FULL	13.52	20.39	14.18	-6.76	0.0047	0.0231	0.0055
10+20	QPSK	1RB01RBMAX	1.94	2.77	2.64	-6.76	0.0003	0.0004	0.0004
	QPSK	1RBMAX1RB0	18.08	22.93	18.95	-6.76	0.0136	0.0414	0.0166
	QPSK	FULL	13.41	20.87	14.20	-6.76	0.0046	0.0258	0.0055
	16QAM	1RB01RBMAX	1.89	2.69	2.63	-6.76	0.0003	0.0004	0.0004
	16QAM	1RBMAX1RB0	18.12	22.89	18.94	-6.76	0.0137	0.0410	0.0165
	16QAM	FULL	13.43	20.89	14.12	-6.76	0.0046	0.0259	0.0054
	64QAM	1RB01RBMAX	1.95	2.84	2.62	-6.76	0.0003	0.0004	0.0004
	64QAM	1RBMAX1RB0	18.25	22.84	19.12	-6.76	0.0141	0.0406	0.0172
	64QAM	FULL	13.34	20.85	14.22	-6.76	0.0045	0.0256	0.0056
	256QAM	1RB01RBMAX	1.03	1.77	1.54	-6.76	0.0003	0.0003	0.0003
	256QAM	1RBMAX1RB0	18.23	20.38	19.02	-6.76	0.0140	0.0230	0.0168
	256QAM	FULL	13.42	20.36	14.25	-6.76	0.0046	0.0229	0.0056
5+20	QPSK	1RB01RBMAX	1.90	2.86	2.60	-6.76	0.0003	0.0004	0.0004
	QPSK	1RBMAX1RB0	18.67	22.95	19.45	-6.76	0.0155	0.0416	0.0186
	QPSK	FULL	12.45	21.43	13.26	-6.76	0.0037	0.0293	0.0045
	16QAM	1RB01RBMAX	1.81	2.74	2.62	-6.76	0.0003	0.0004	0.0004
	16QAM	1RBMAX1RB0	18.65	22.91	19.69	-6.76	0.0155	0.0412	0.0196
	16QAM	FULL	12.38	21.49	13.23	-6.76	0.0036	0.0297	0.0044
	64QAM	1RB01RBMAX	1.84	2.96	2.66	-6.76	0.0003	0.0004	0.0004
	64QAM	1RBMAX1RB0	18.87	22.95	19.72	-6.76	0.0163	0.0416	0.0198
	64QAM	FULL	12.41	21.46	13.20	-6.76	0.0037	0.0295	0.0044
	256QAM	1RB01RBMAX	0.79	1.84	1.49	-6.76	0.0003	0.0003	0.0003
	256QAM	1RBMAX1RB0	18.75	20.41	19.54	-6.76	0.0158	0.0232	0.0190
	256QAM	FULL	12.32	20.42	13.24	-6.76	0.0036	0.0232	0.0044



**EIRP**

The worst case EIRP shown in this section is found with LTE operating only using 1RB. As such, the EIRP/10MHz and full channel EIRP values will be identical since 1RB is fully contained within all available channel bandwidths for LTE Band 48 (i.e. 5, 10, 15, 20MHz)

LTE Band 48 (GT - LC = -6.76 dB) QPSK									
Bandwidth	5M			10M			15M		
Channel	(Low)	(Mid)	(High)	(Low)	(Mid)	(High)	(Low)	(Mid)	(High)
Conducted Power (dBm/10MHz)	23.08	23.07	23.10	22.97	23.08	23.10	22.99	23.15	23.11
Conducted Power (Watts/10MHz)	0.2032	0.2028	0.2042	0.1982	0.2032	0.2042	0.1991	0.2065	0.2046
EIRP (dBm/10MHz)	16.32	16.31	16.34	16.21	16.32	16.34	16.23	16.39	16.35
EIRP (Watts/10MHz)	0.0429	0.0428	0.0431	0.0418	0.0429	0.0431	0.0420	0.0436	0.0432

LTE Band 48 (GT - LC = -6.76 dB) QPSK			
Bandwidth	20M		
Channel	(Low)	(Mid)	(High)
Conducted Power (dBm/10MHz)	23.12	23.18	23.15
Conducted Power (Watts/10MHz)	0.2051	0.2080	0.2065
EIRP (dBm/10MHz)	16.36	16.42	16.39
EIRP (Watts/10MHz)	0.0433	0.0439	0.0436



LTE Band 48 (GT - LC = -6.76 dB) 16QAM									
Bandwidth	5M			10M			15M		
Channel	(Low)	(Mid)	(High)	(Low)	(Mid)	(High)	(Low)	(Mid)	(High)
Conducted Power (dBm/10MHz)	22.94	22.99	23.08	22.91	23.06	23.10	22.92	23.04	23.09
Conducted Power (Watts/10MHz)	0.1968	0.1991	0.2032	0.1954	0.2023	0.2042	0.1959	0.2014	0.2037
EIRP (dBm/10MHz)	16.18	16.23	16.32	16.15	16.30	16.34	16.16	16.28	16.33
EIRP (Watts/10MHz)	0.0415	0.0420	0.0429	0.0412	0.0427	0.0431	0.0413	0.0425	0.0430

LTE Band 48 (GT - LC = -6.76 dB) 16QAM			
Bandwidth	20M		
Channel	(Low)	(Mid)	(High)
Conducted Power (dBm/10MHz)	23.01	23.08	23.16
Conducted Power (Watts/10MHz)	0.2000	0.2032	0.2070
EIRP (dBm/10MHz)	16.25	16.32	16.40
EIRP (Watts/10MHz)	0.0422	0.0429	0.0437





LTE Band 48 (GT - LC = -6.76 dB) 64QAM									
Bandwidth	5M			10M			15M		
Channel	(Low)	(Mid)	(High)	(Low)	(Mid)	(High)	(Low)	(Mid)	(High)
Conducted Power (dBm/10MHz)	22.82	22.93	23.02	22.82	22.88	23.03	22.78	22.95	23.08
Conducted Power (Watts/10MHz)	0.1914	0.1963	0.2004	0.1914	0.1941	0.2009	0.1897	0.1972	0.2032
EIRP (dBm/10MHz)	16.06	16.17	16.26	16.06	16.12	16.27	16.02	16.19	16.32
EIRP (Watts/10MHz)	0.0404	0.0414	0.0423	0.0404	0.0409	0.0424	0.0400	0.0416	0.0429

LTE Band 48 (GT - LC = -6.76 dB) 64QAM			
Bandwidth	20M		
Channel	(Low)	(Mid)	(High)
Conducted Power (dBm/10MHz)	22.90	23.01	23.12
Conducted Power (Watts/10MHz)	0.1950	0.2000	0.2051
EIRP (dBm/10MHz)	16.14	16.25	16.36
EIRP (Watts/10MHz)	0.0411	0.0422	0.0433



LTE Band 48 (GT - LC = -6.76 dB) 256QAM									
Bandwidth	5M			10M			15M		
Channel	(Low)	(Mid)	(High)	(Low)	(Mid)	(High)	(Low)	(Mid)	(High)
Conducted Power (dBm/10MHz)	20.00	20.16	20.09	19.96	20.14	20.05	19.89	20.09	20.07
Conducted Power (Watts/10MHz)	0.1000	0.1038	0.1021	0.0991	0.1033	0.1012	0.0975	0.1021	0.1016
EIRP (dBm/10MHz)	13.24	13.40	13.33	13.20	13.38	13.29	13.13	13.33	13.31
EIRP (Watts/10MHz)	0.0211	0.0219	0.0215	0.0209	0.0218	0.0213	0.0206	0.0215	0.0214

LTE Band 48 (GT - LC = -6.76 dB) 256QAM			
Bandwidth	20M		
Channel	(Low)	(Mid)	(High)
Conducted Power (dBm/10MHz)	20.03	20.20	20.17
Conducted Power (Watts/10MHz)	0.1007	0.1047	0.1040
EIRP (dBm/10MHz)	13.27	13.44	13.41
EIRP (Watts/10MHz)	0.0212	0.0221	0.0219



# LTE Band 48

## ACLR

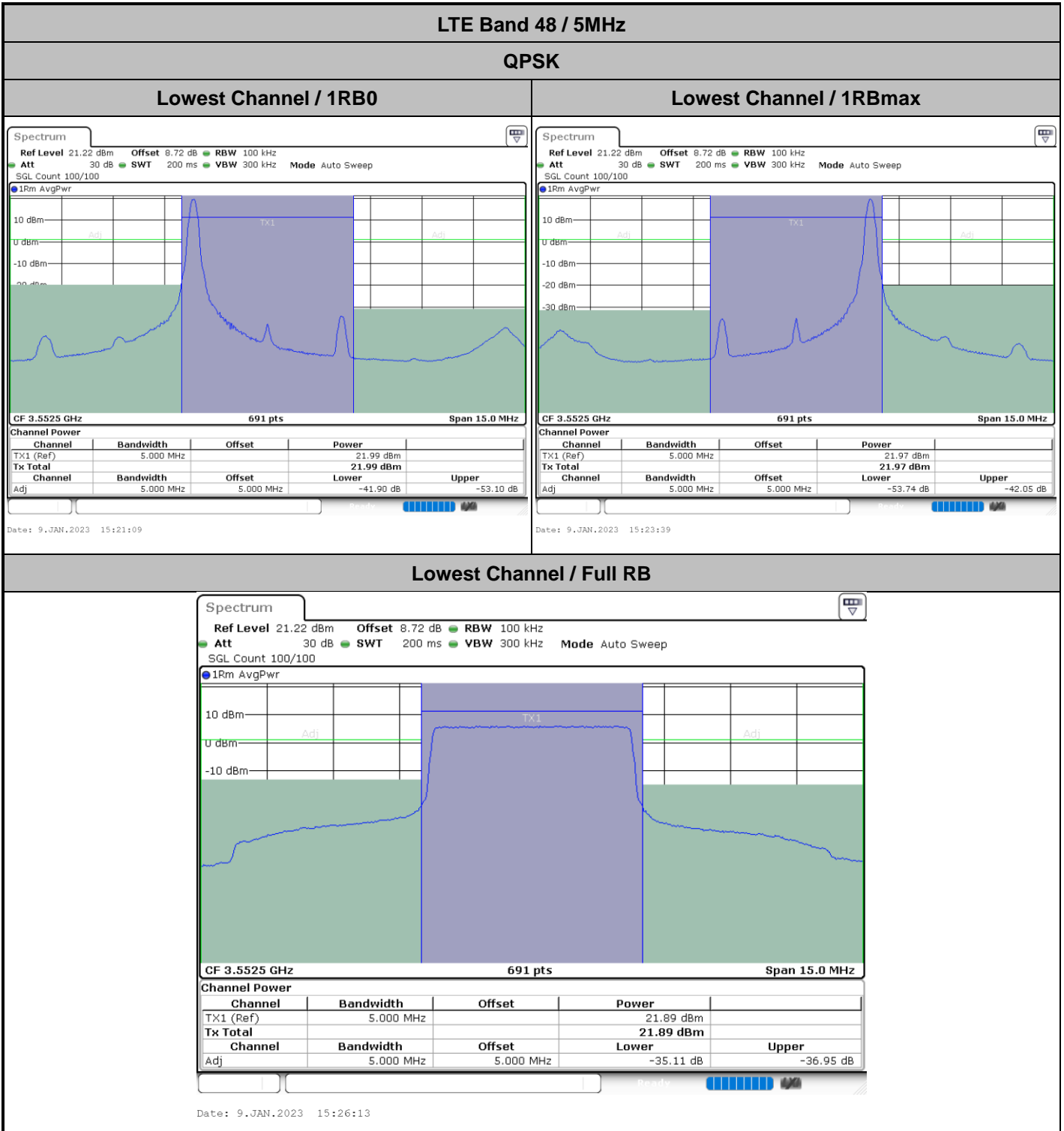



**LTE Band 48 / 5MHz**

**QPSK**

**Middle Channel / 1RB0**

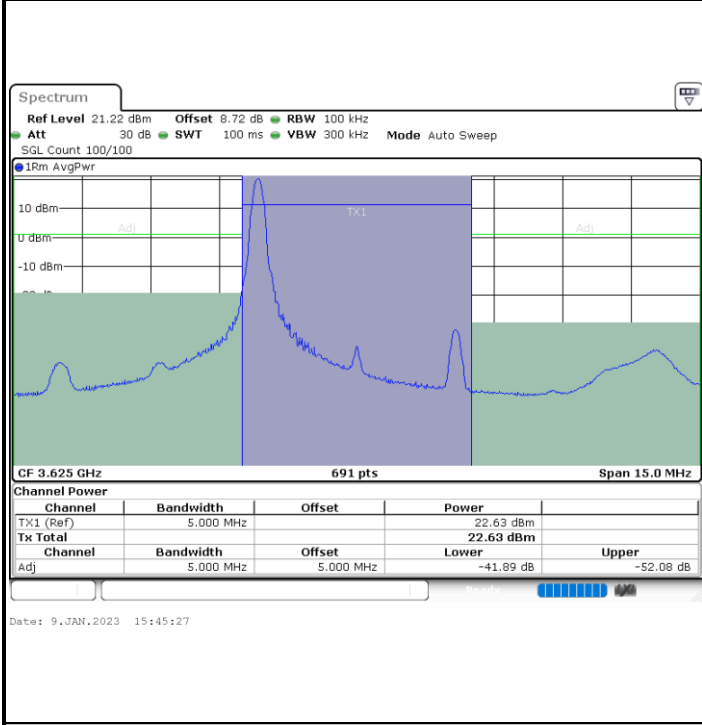

**Middle Channel / 1RBmax**

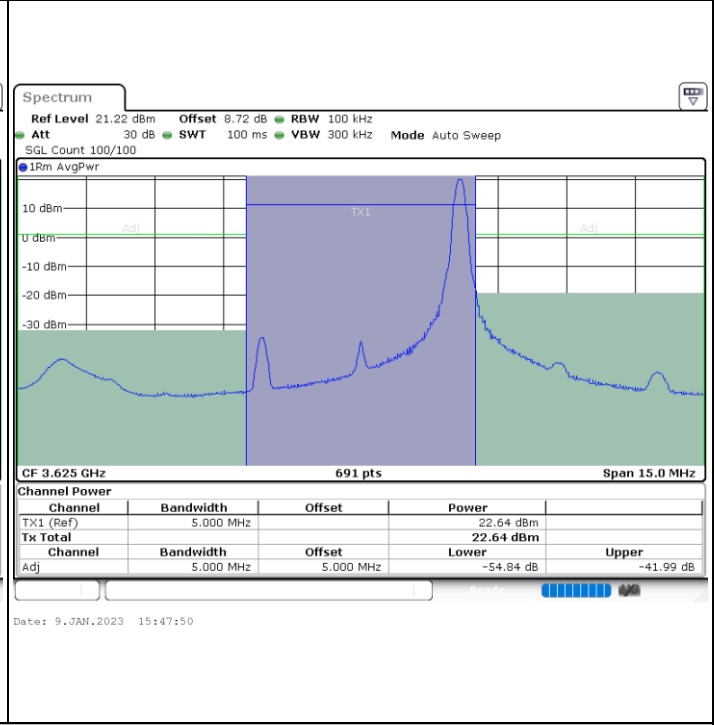

**Middle Channel / Full RB**

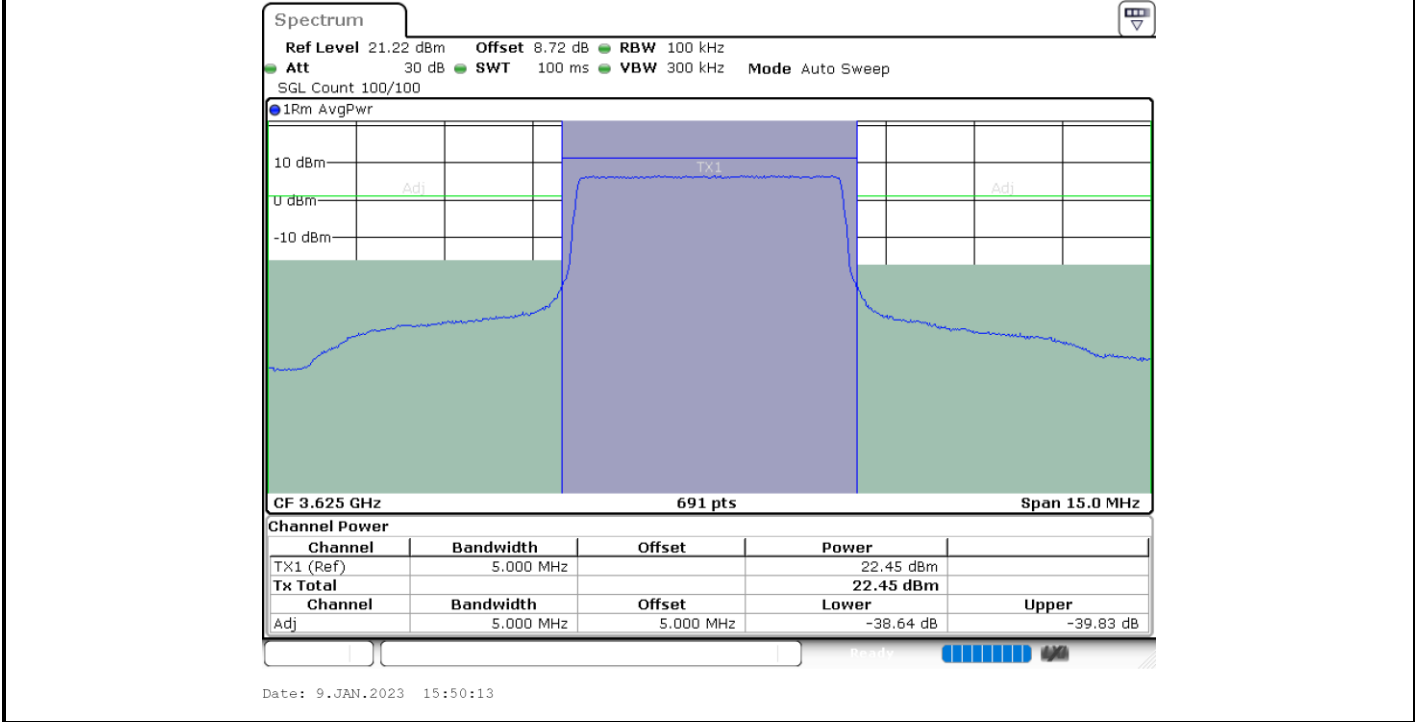



LTE Band 48 / 5MHz

QPSK

Highest Channel / 1RB0

Highest Channel / 1RBmax

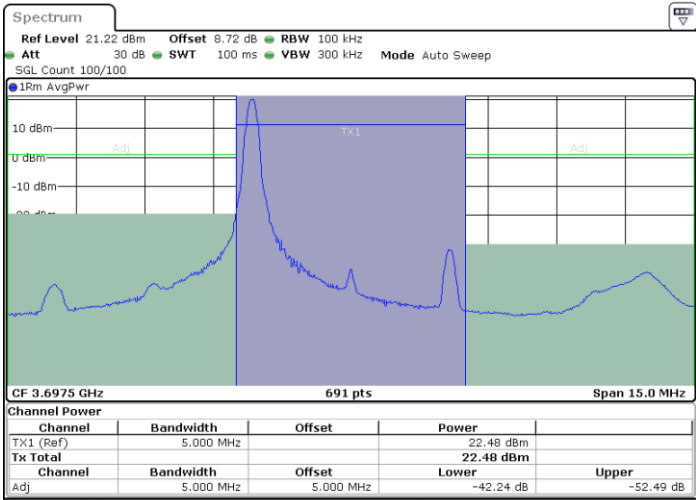

Date: 9.JAN.2023 15:52:37

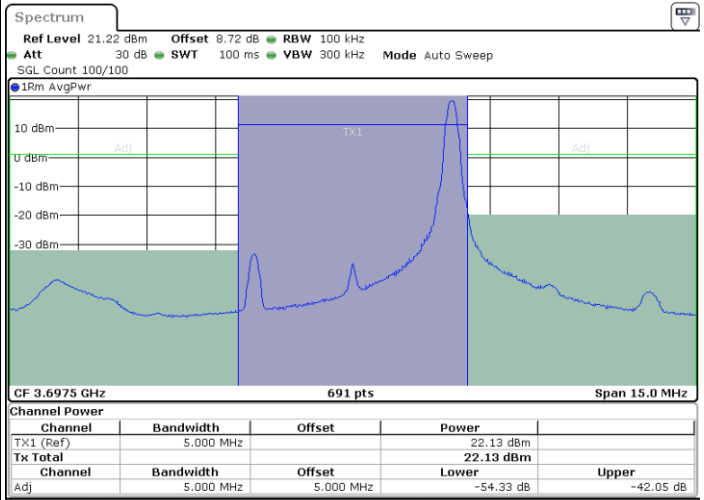

Date: 9.JAN.2023 15:55:03

Highest Channel / Full RB

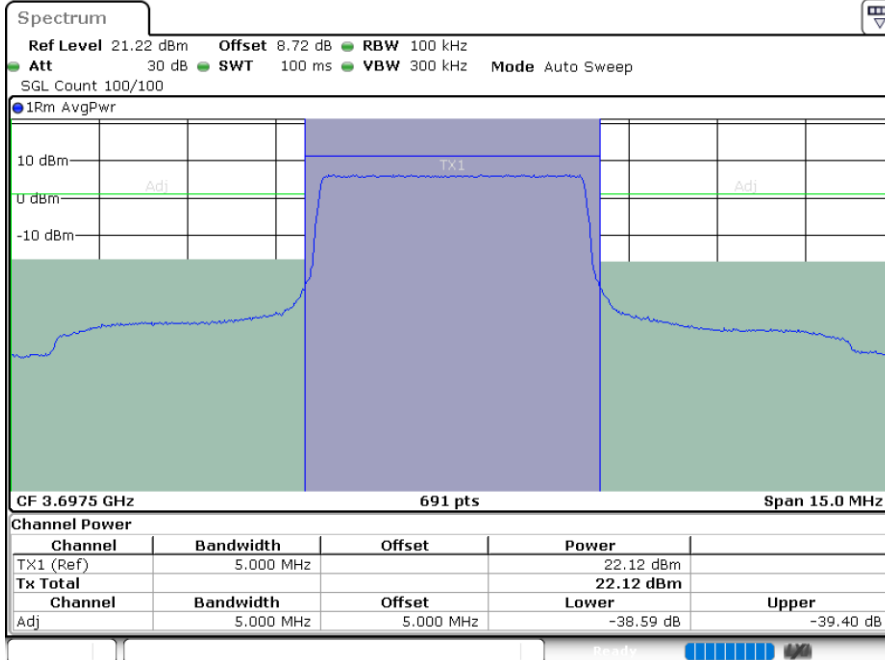

Date: 9.JAN.2023 15:57:30



LTE Band 48 / 5MHz

16QAM

Lowest Channel / 1RB0

Lowest Channel / 1RBmax

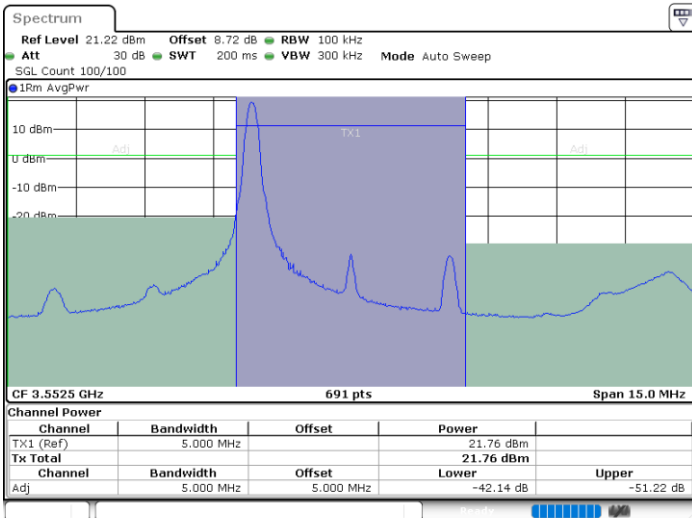

Date: 9.JAN.2023 15:21:46

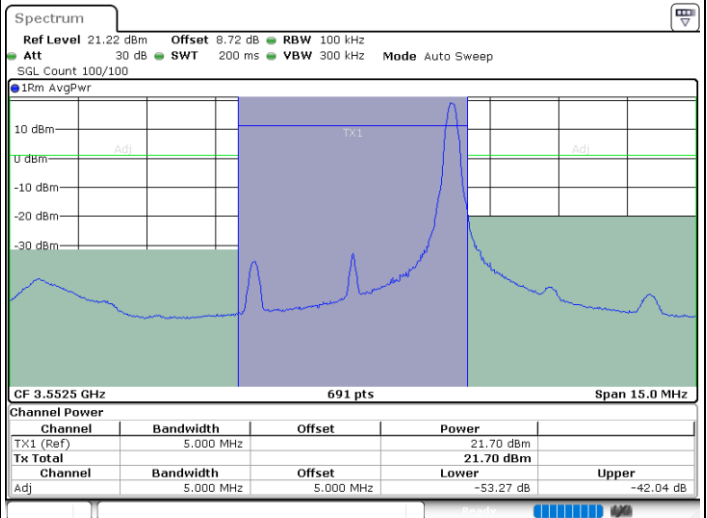

Date: 9.JAN.2023 15:24:17

Lowest Channel / Full RB

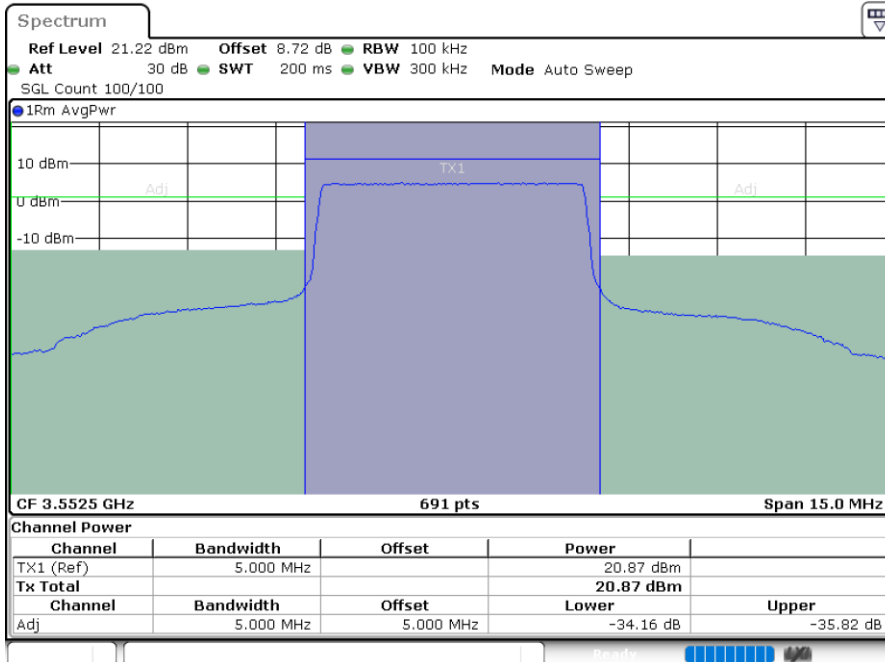

Date: 9.JAN.2023 15:26:51



LTE Band 48 / 5MHz

16QAM

Middle Channel / 1RB0

Middle Channel / 1RBmax

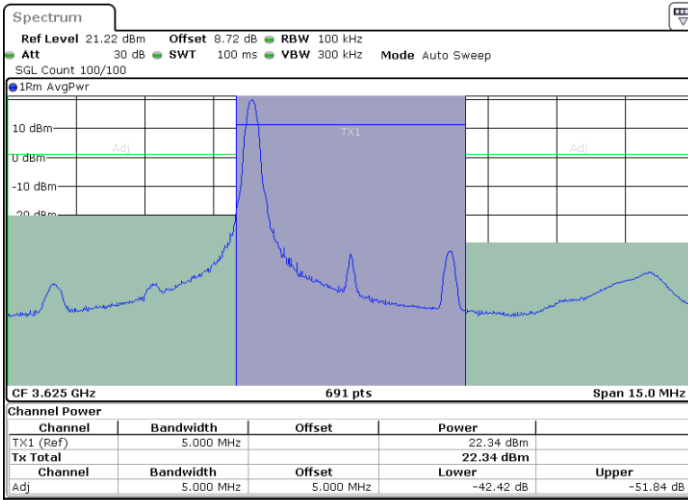

Date: 9.JAN.2023 15:46:03

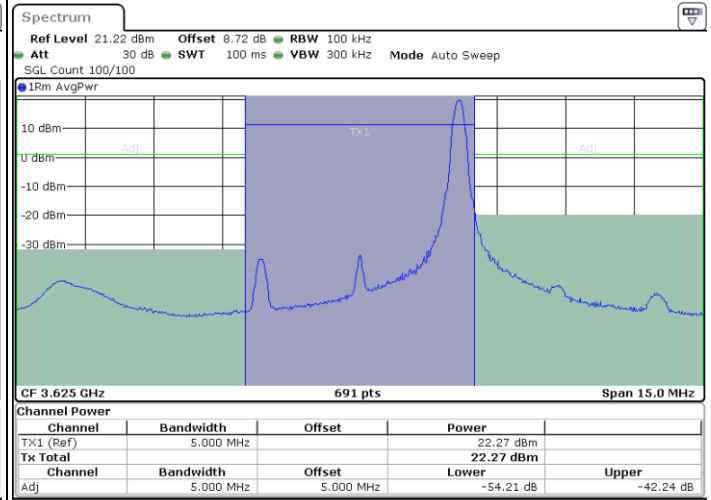

Date: 9.JAN.2023 15:48:26

Middle Channel / Full RB

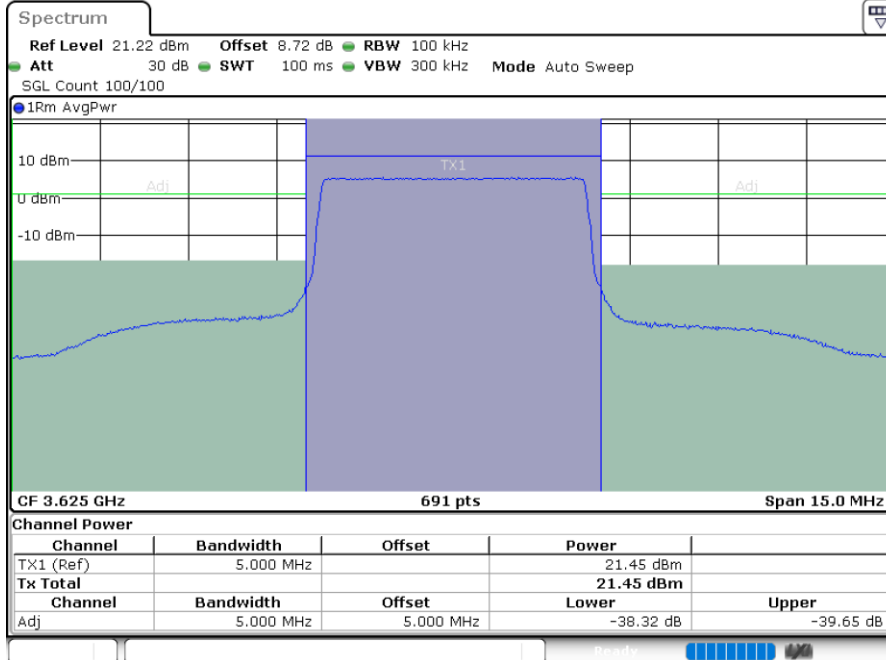

Date: 9.JAN.2023 15:50:49



LTE Band 48 / 5MHz

16QAM

Highest Channel / 1RB0

Highest Channel / 1RBmax

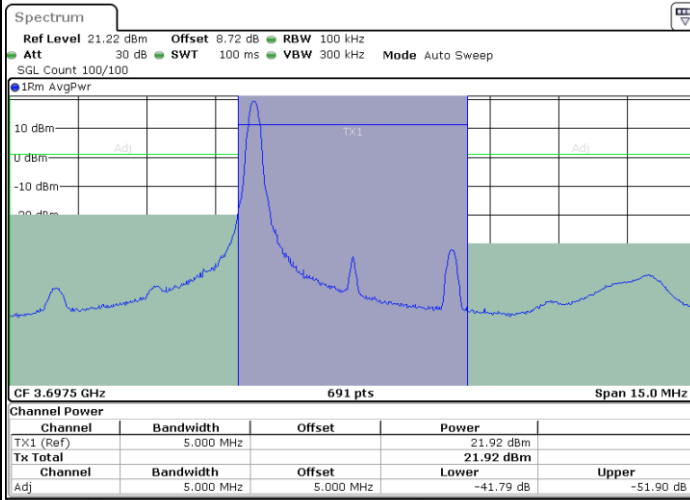

Date: 9.JAN.2023 15:53:14

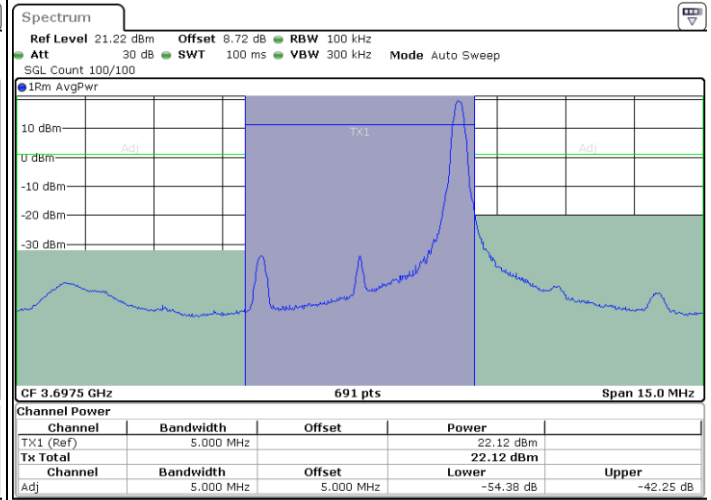

Date: 9.JAN.2023 15:55:40

Highest Channel / Full RB

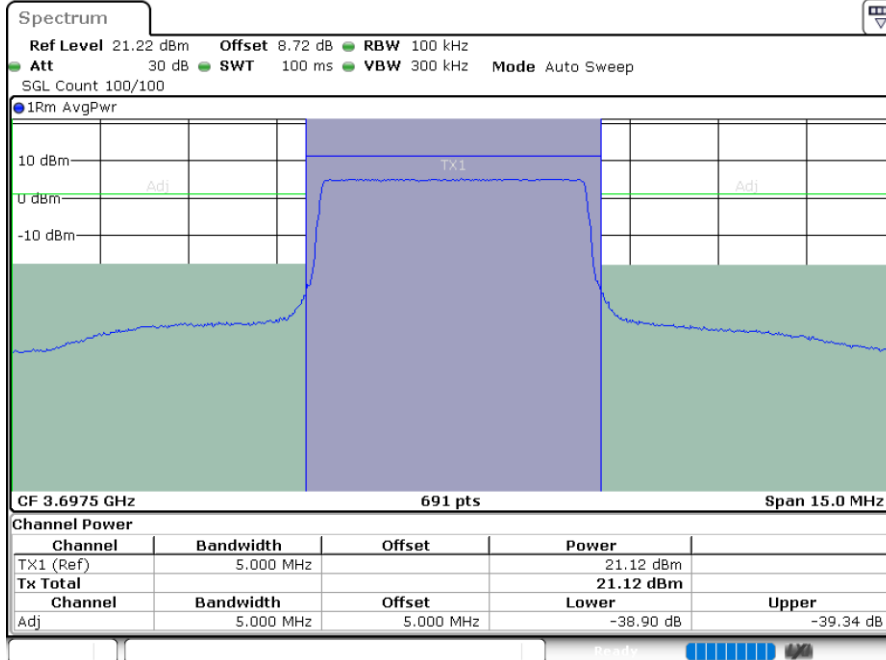

Date: 9.JAN.2023 15:58:06





LTE Band 48 / 5MHz

64QAM

Lowest Channel / 1RB0

Lowest Channel / 1RBmax

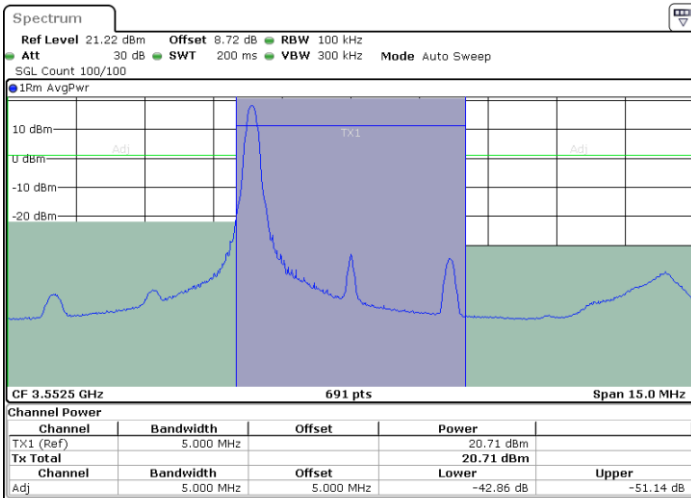

Date: 9.JAN.2023 15:22:24

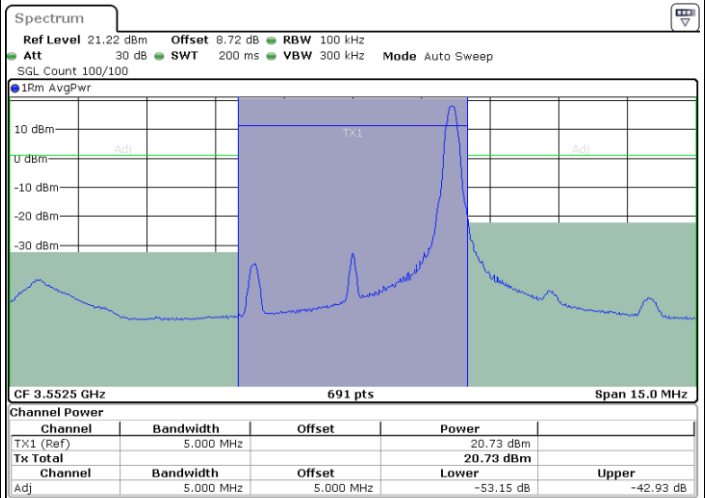

Date: 9.JAN.2023 15:24:55

Lowest Channel / Full RB

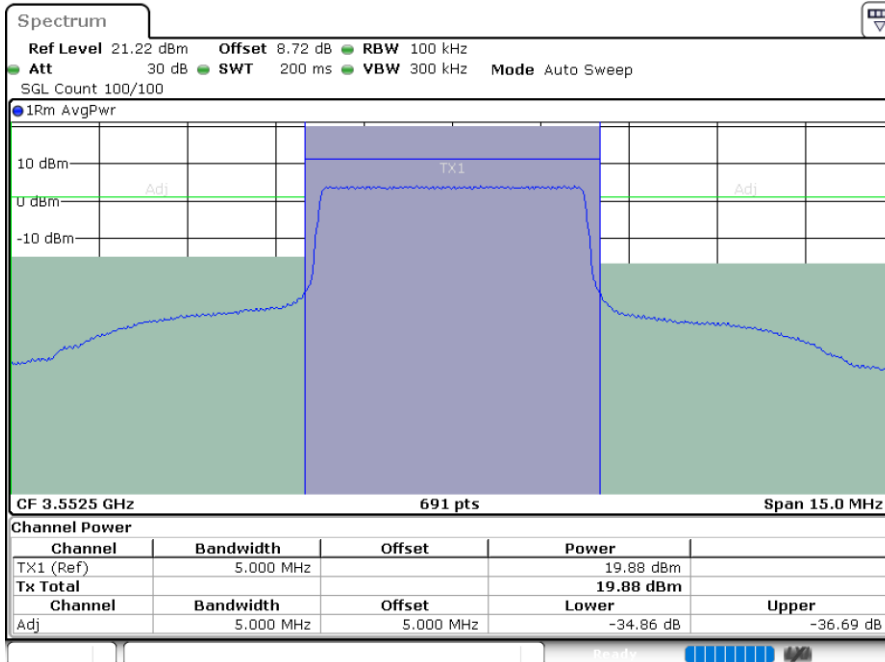

Date: 9.JAN.2023 15:27:29



LTE Band 48 / 5MHz

64QAM

Middle Channel / 1RB0

Middle Channel / 1RBmax

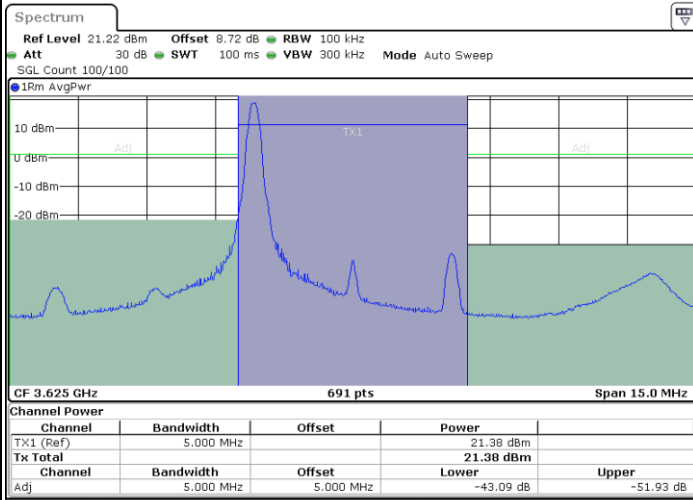

Date: 9.JAN.2023 15:46:38

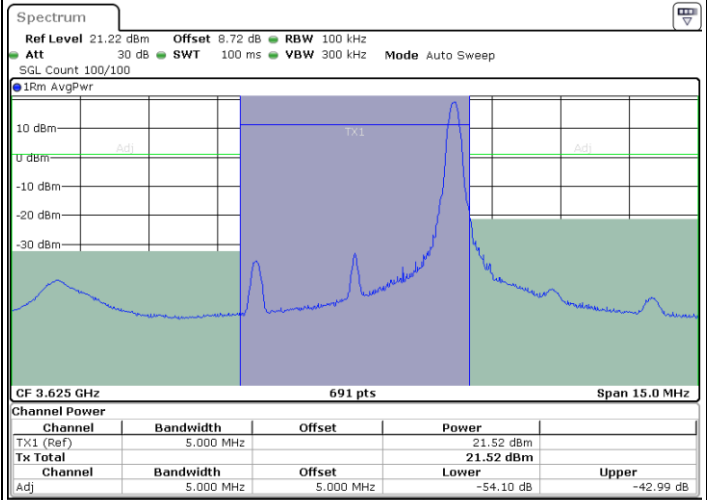

Date: 9.JAN.2023 15:49:02

Middle Channel / Full RB

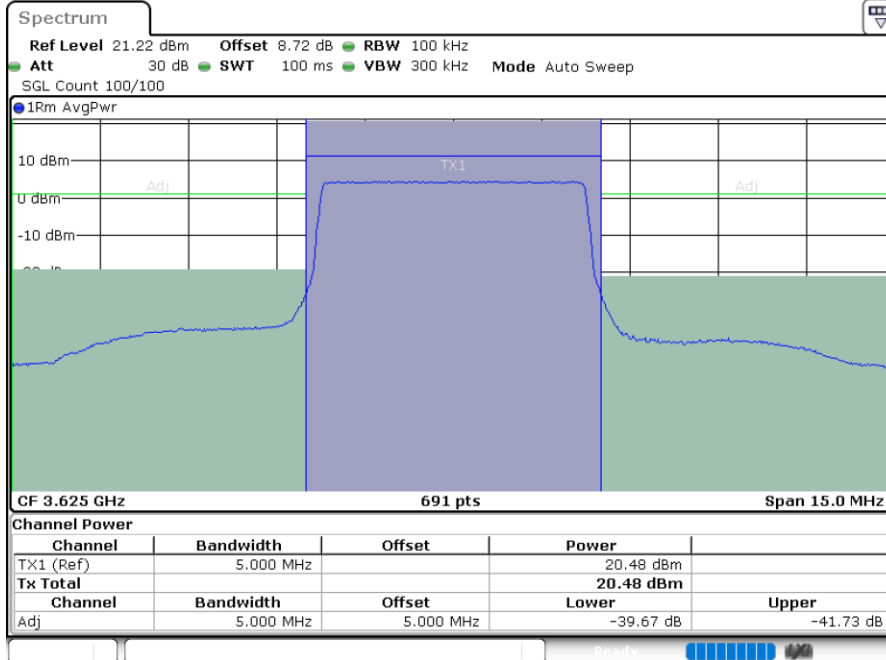

Date: 9.JAN.2023 15:51:25



LTE Band 48 / 5MHz

64QAM

Highest Channel / 1RB0

Highest Channel / 1RBmax

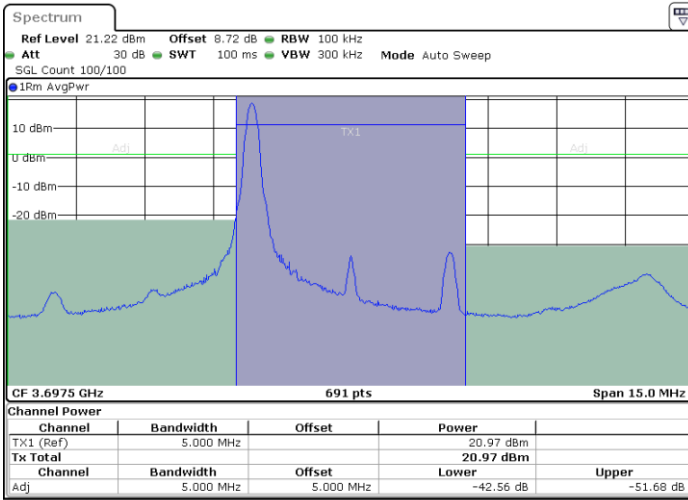

Date: 9.JAN.2023 15:53:50

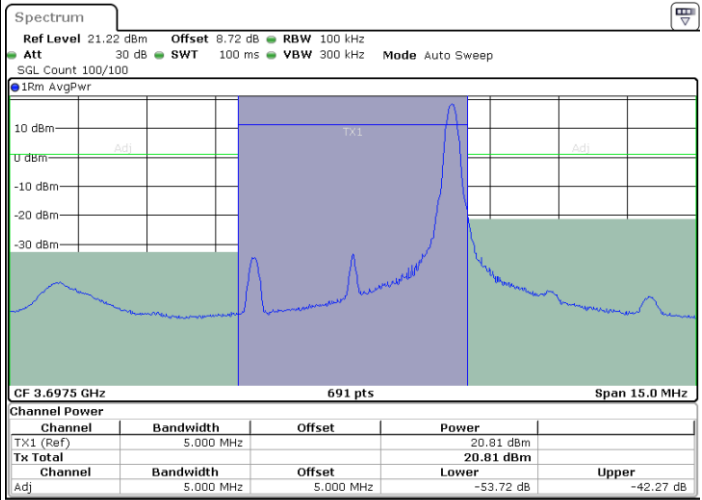

Date: 9.JAN.2023 15:56:16

Highest Channel / Full RB

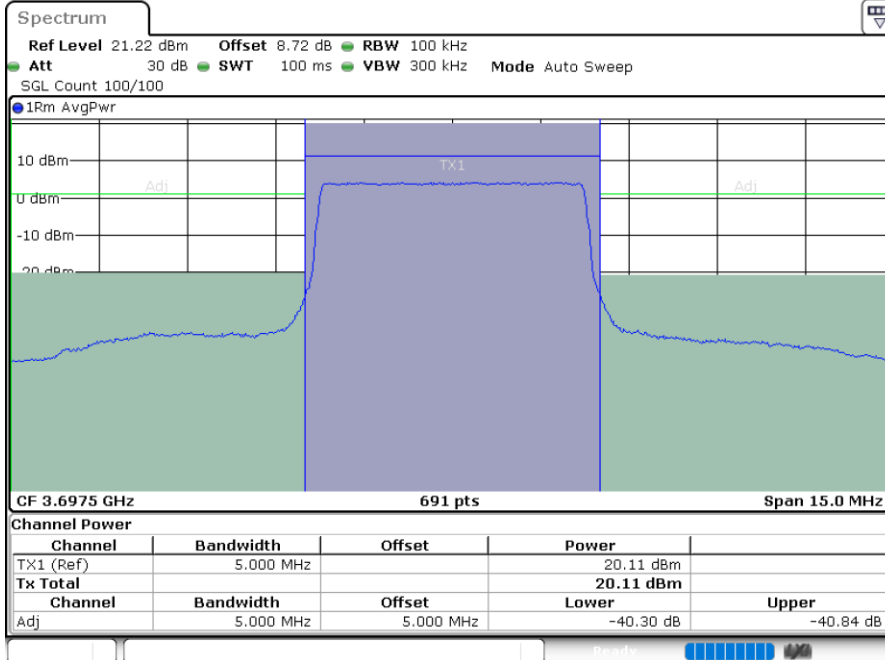

Date: 9.JAN.2023 15:58:42



LTE Band 48 / 5MHz

256QAM

Lowest Channel / 1RB0

Lowest Channel / 1RBmax

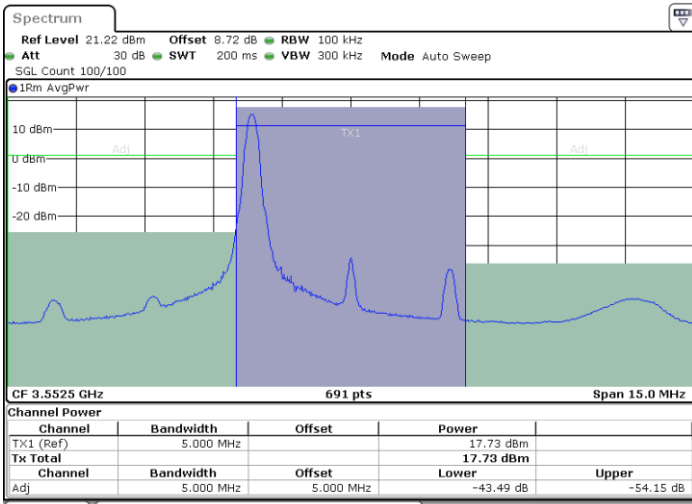

Date: 9.JAN.2023 15:23:02

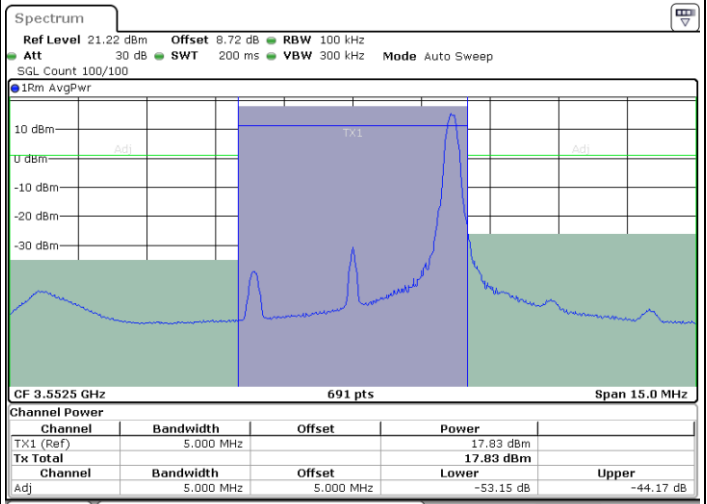

Date: 9.JAN.2023 15:25:32

Lowest Channel / Full RB

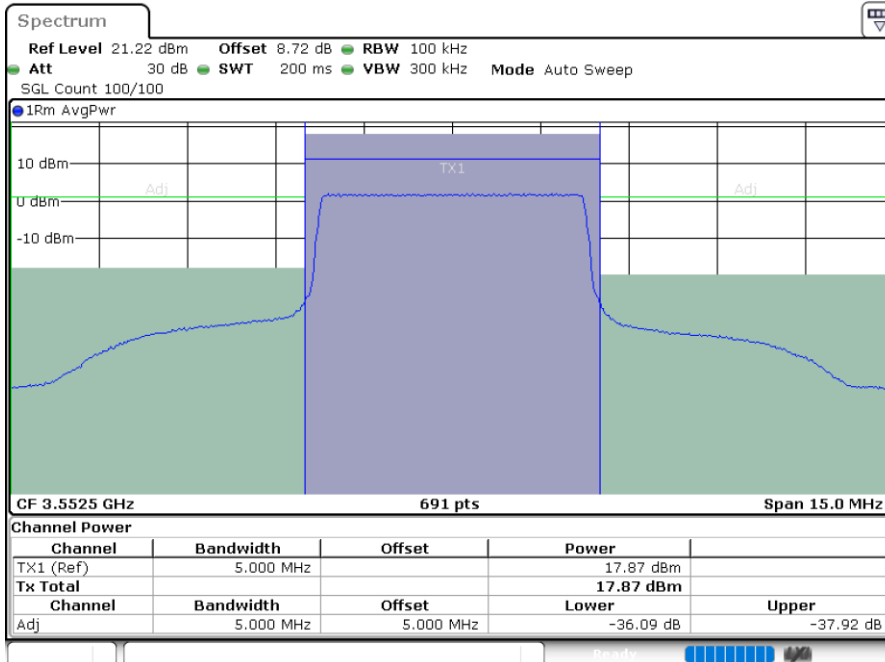

Date: 9.JAN.2023 15:28:06



LTE Band 48 / 5MHz

256QAM

Middle Channel / 1RB0

Middle Channel / 1RBmax

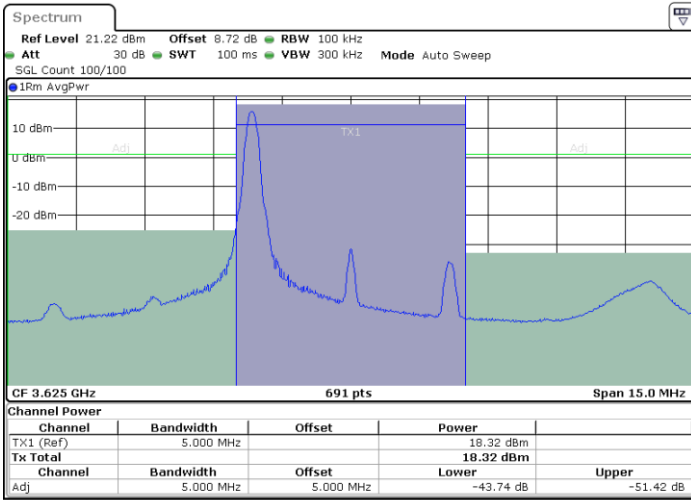

Date: 9.JAN.2023 15:47:14

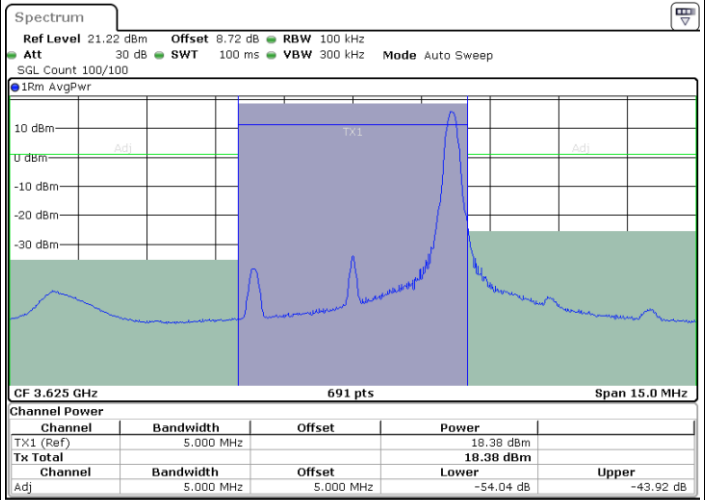

Date: 9.JAN.2023 15:49:37

Middle Channel / Full RB

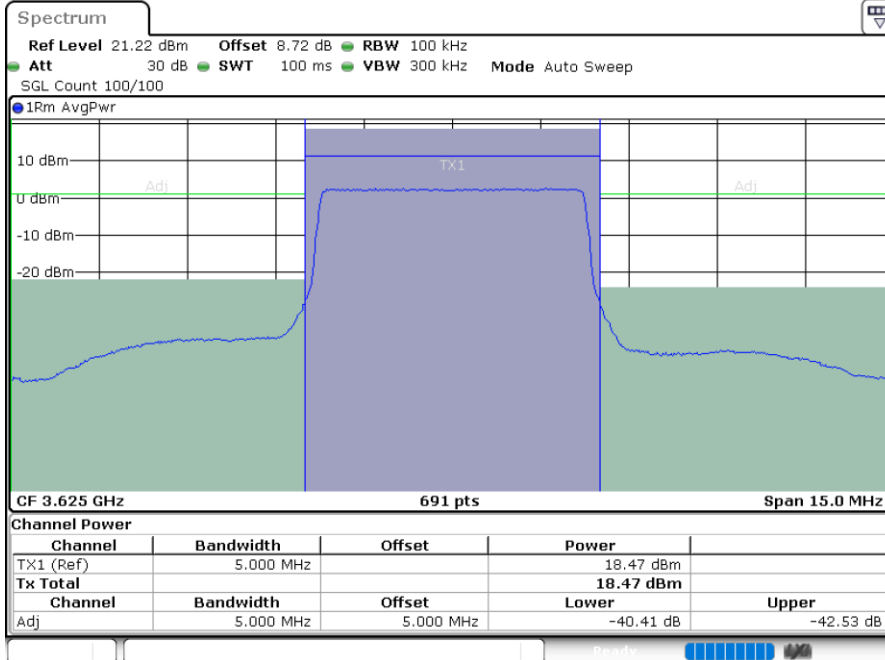

Date: 9.JAN.2023 15:52:01



LTE Band 48 / 5MHz

256QAM

Highest Channel / 1RB0

Highest Channel / 1RBmax

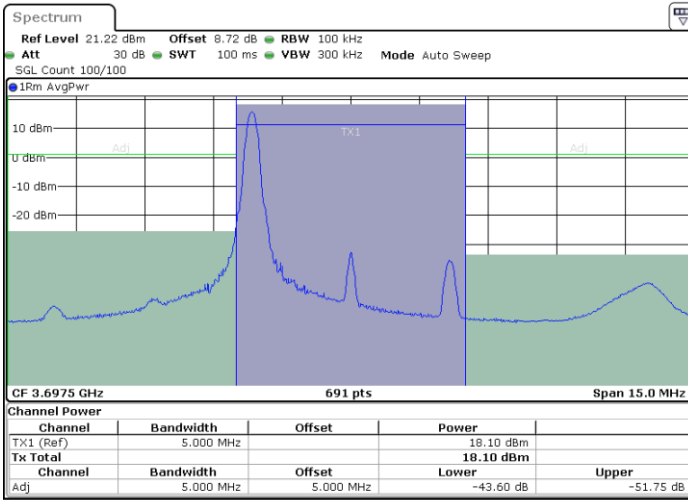

Date: 9.JAN.2023 15:54:27

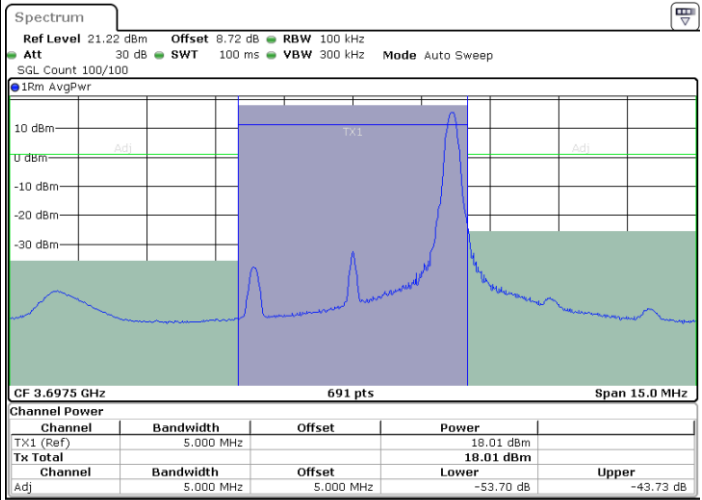

Date: 9.JAN.2023 15:56:53

Highest Channel / Full RB

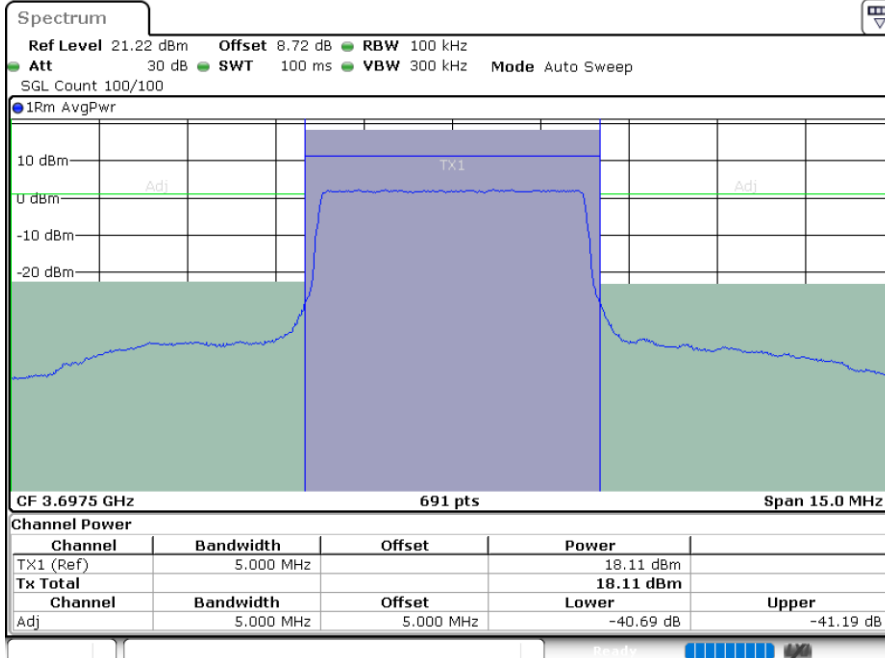

Date: 9.JAN.2023 15:59:19



LTE Band 48 / 10MHz

QPSK

Lowest Channel / 1RB0

Lowest Channel / 1RBmax

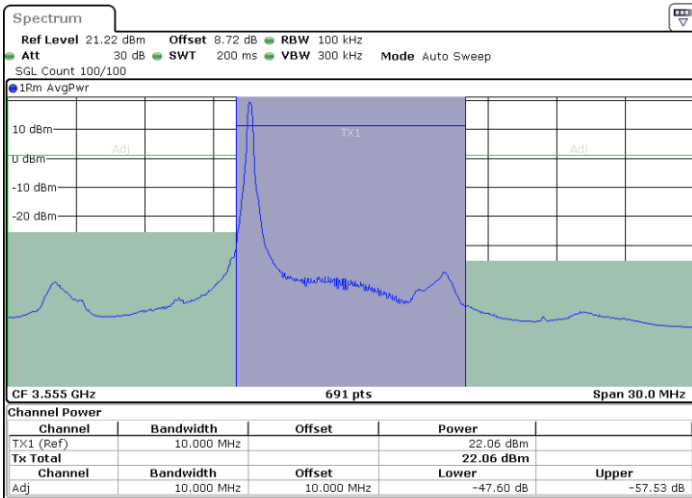

Date: 9.JAN.2023 16:03:52

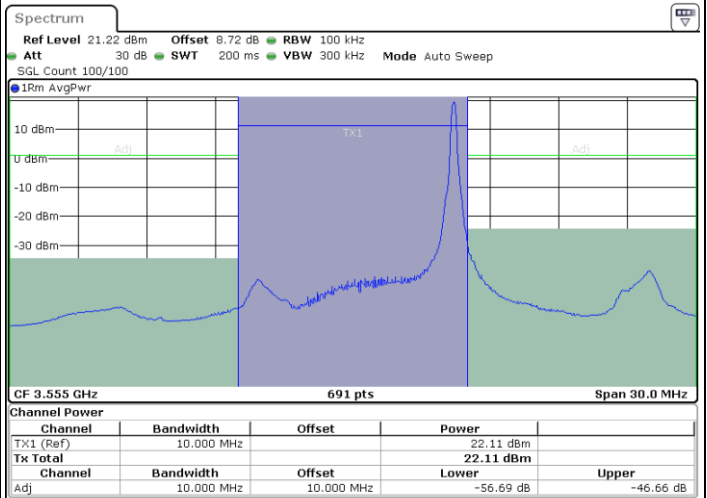

Date: 9.JAN.2023 16:06:24

Lowest Channel / Full RB

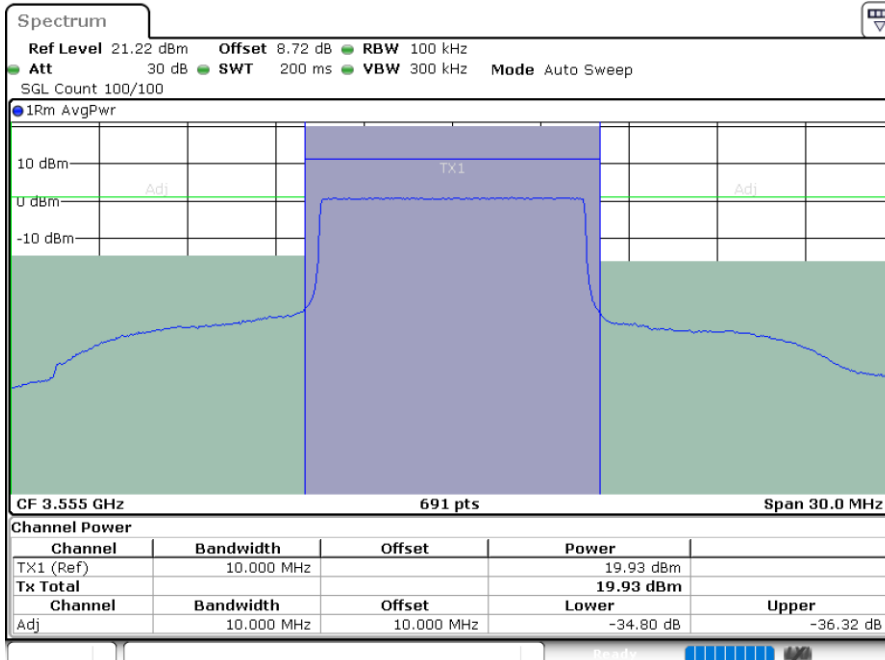

Date: 9.JAN.2023 16:08:55



**LTE Band 48 / 10MHz**

**QPSK**

**Middle Channel / 1RB0**

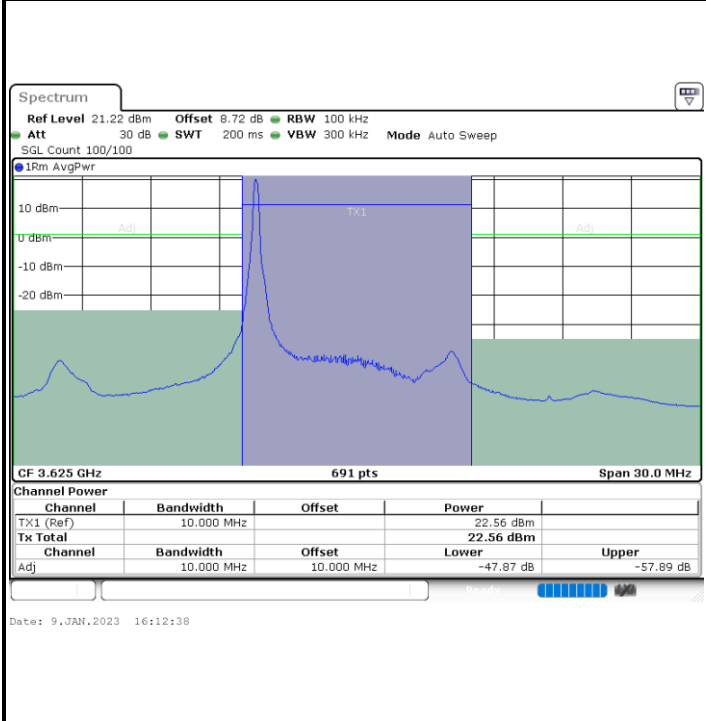

**Middle Channel / 1RBmax**

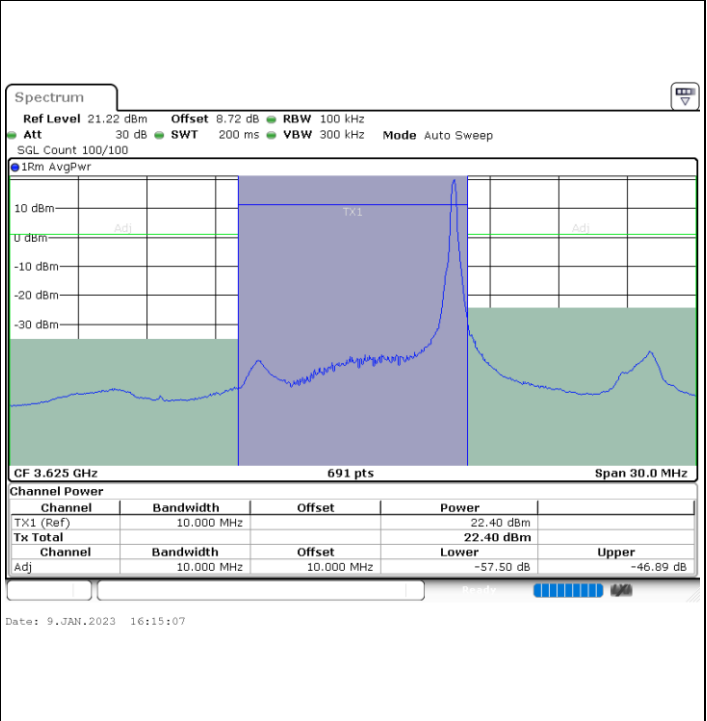

**Middle Channel / Full RB**

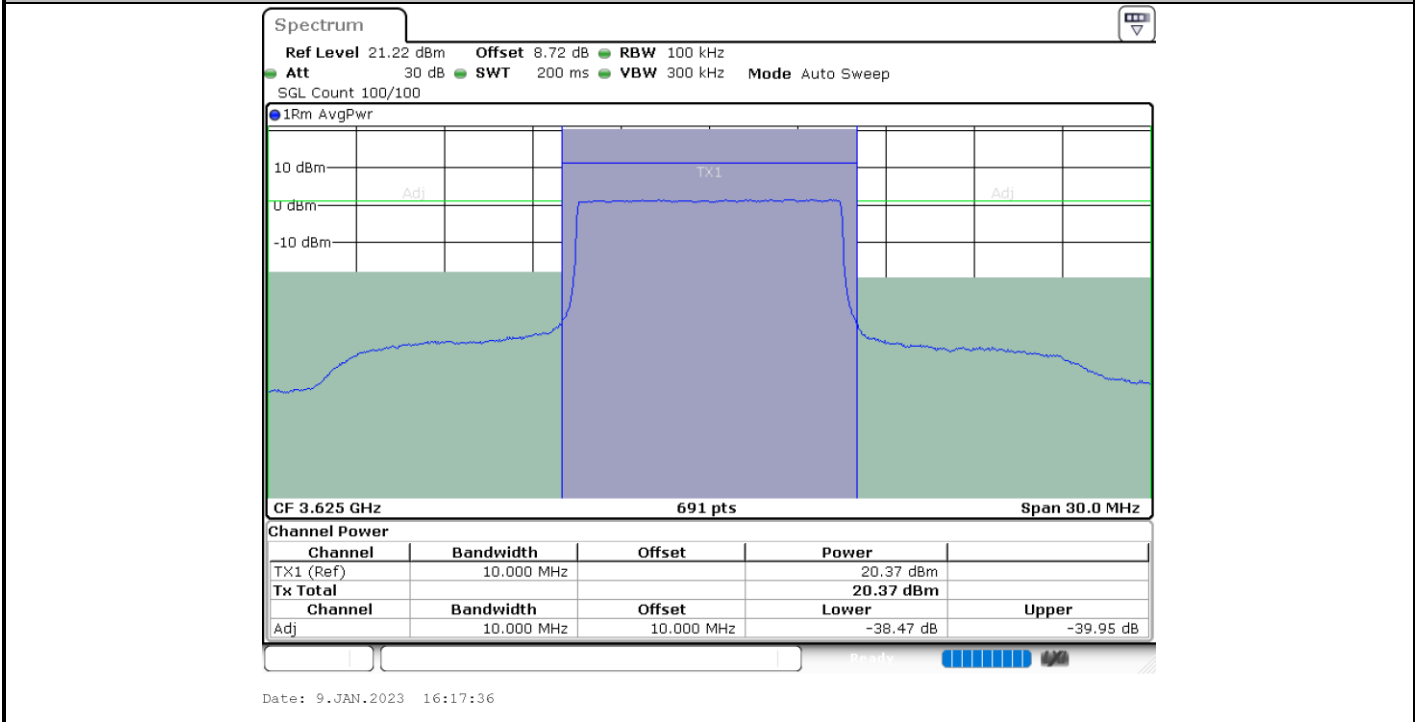





**LTE Band 48 / 10MHz**

**QPSK**

**Highest Channel / 1RB0**

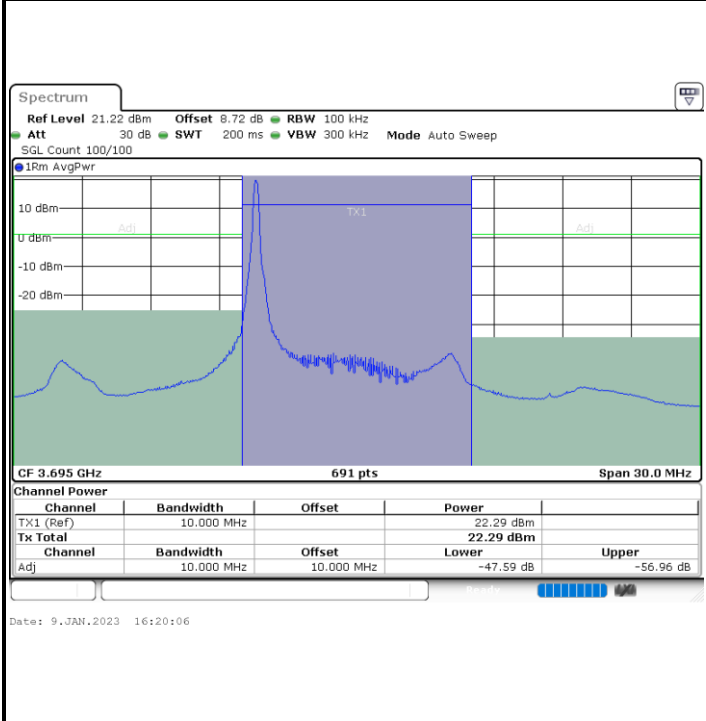

**Highest Channel / 1RBmax**

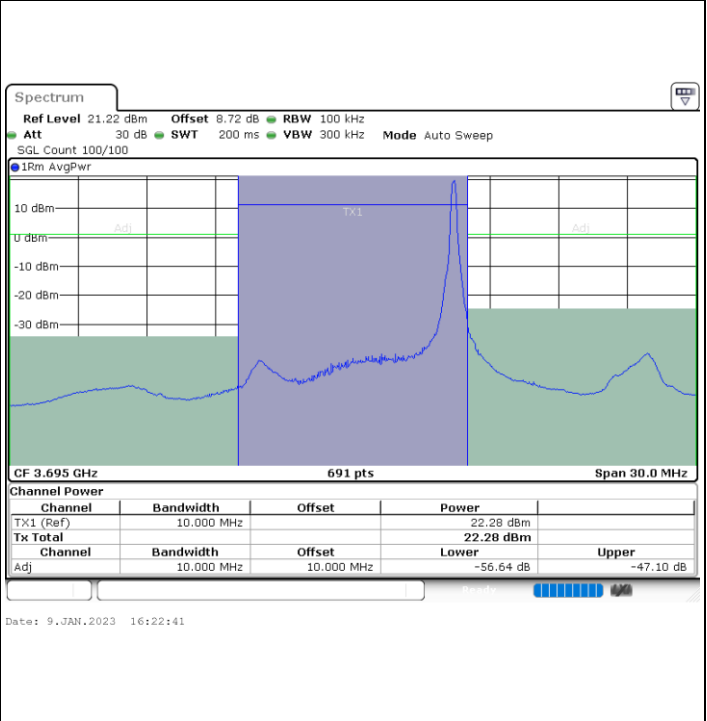

**Highest Channel / Full RB**

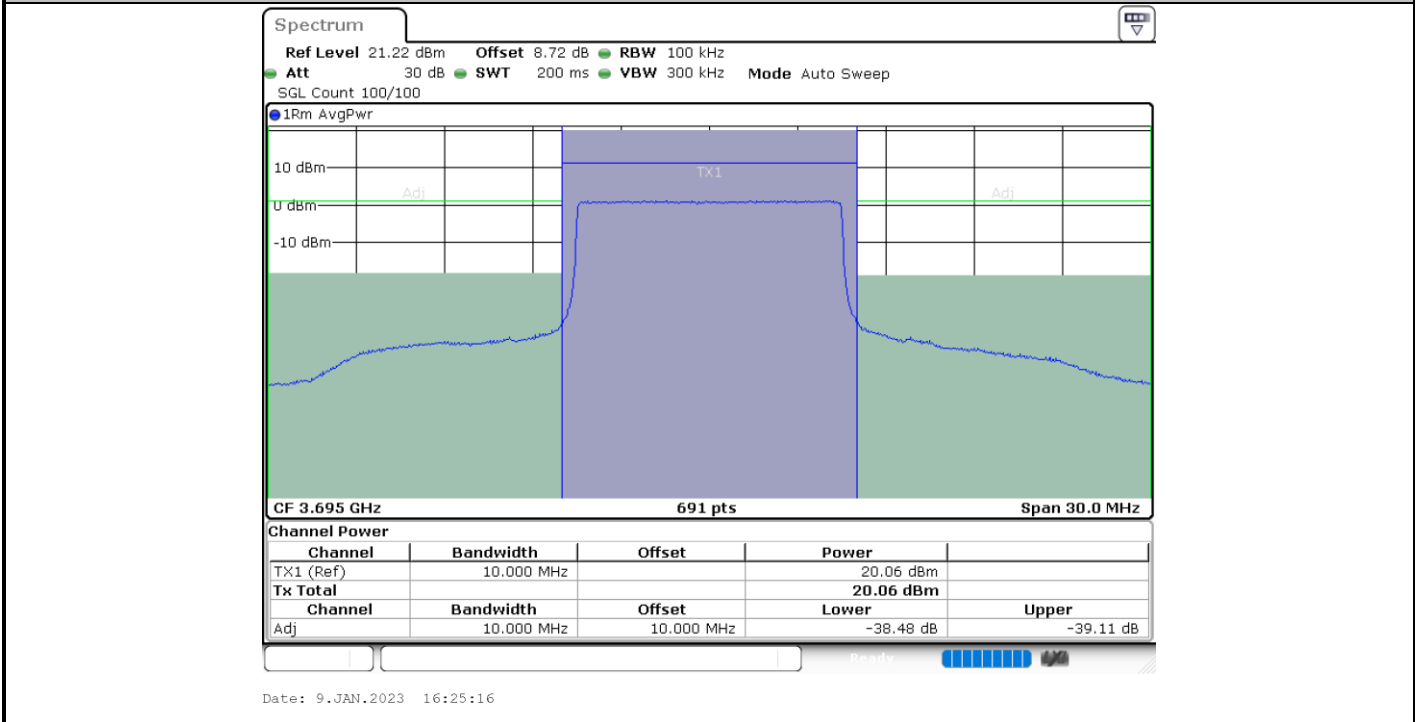



LTE Band 48 / 10MHz

16QAM

Lowest Channel / 1RB0

Lowest Channel / 1RBmax

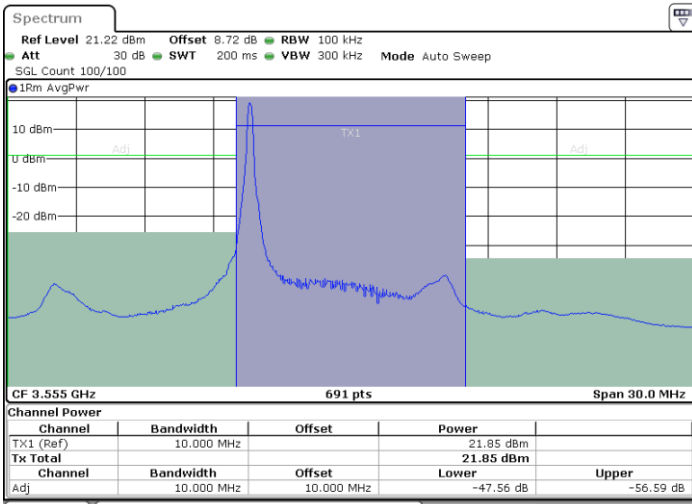

Date: 9.JAN.2023 16:04:30

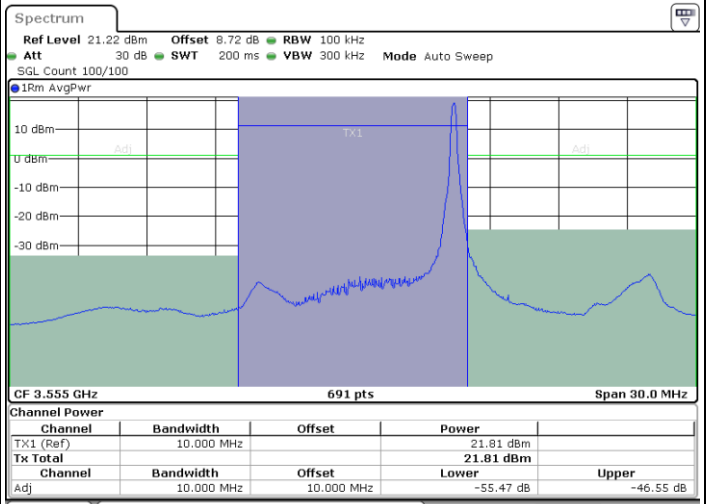

Date: 9.JAN.2023 16:07:01

Lowest Channel / Full RB

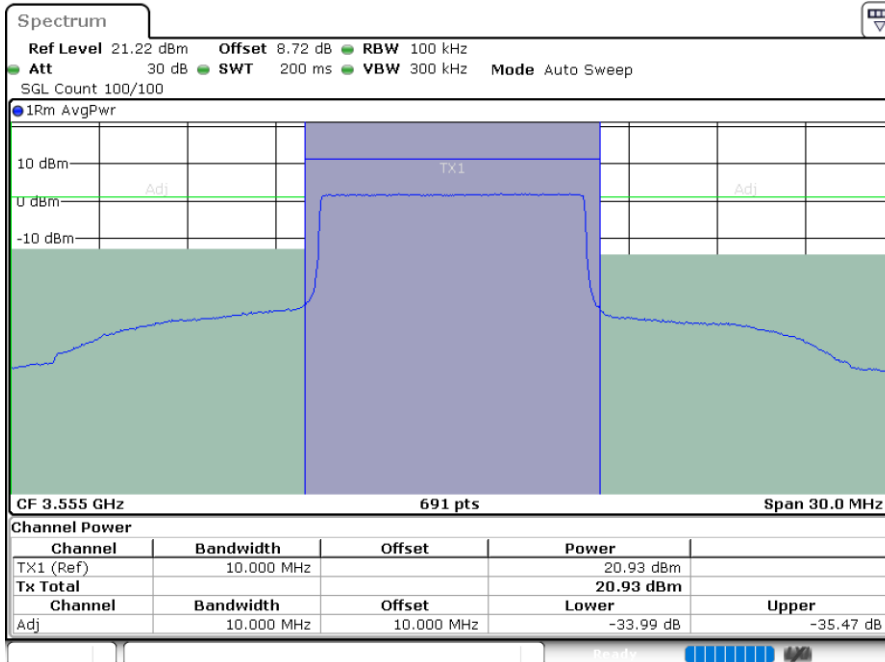

Date: 9.JAN.2023 16:09:33



LTE Band 48 / 10MHz

16QAM

Middle Channel / 1RB0

Middle Channel / 1RBmax

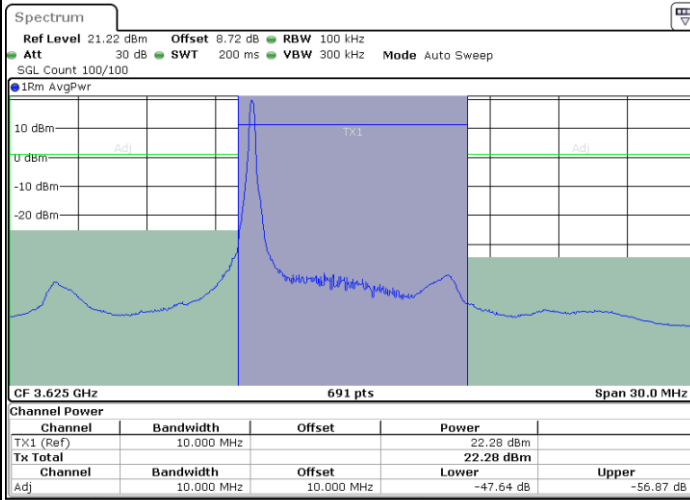

Date: 9.JAN.2023 16:13:16

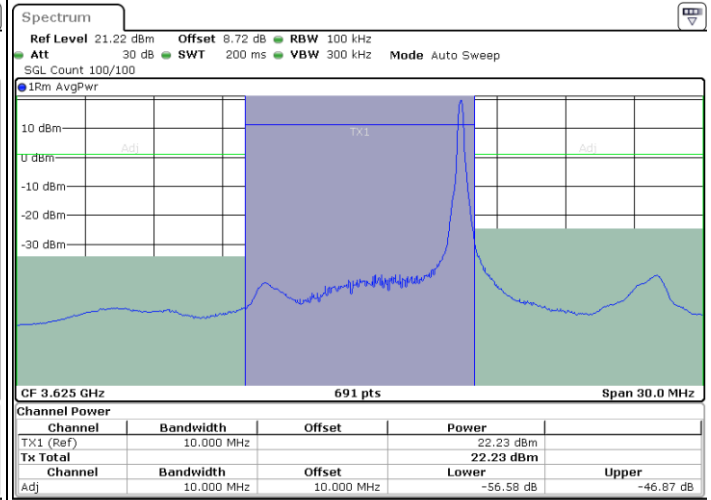

Date: 9.JAN.2023 16:15:44

Middle Channel / Full RB

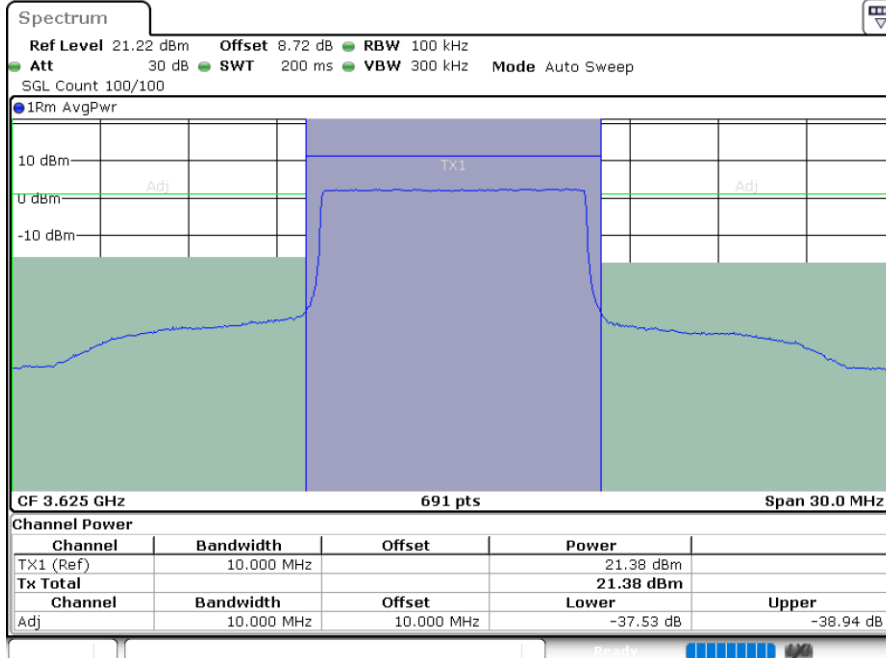

Date: 9.JAN.2023 16:18:13



LTE Band 48 / 10MHz

16QAM

Highest Channel / 1RB0

Highest Channel / 1RBmax

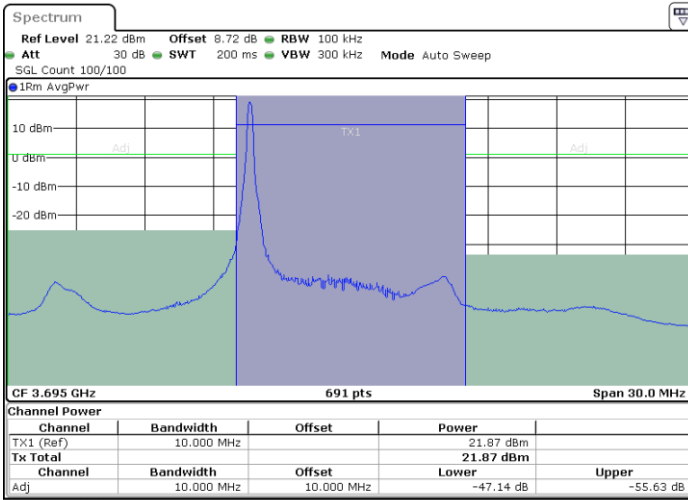

Date: 9.JAN.2023 16:20:44

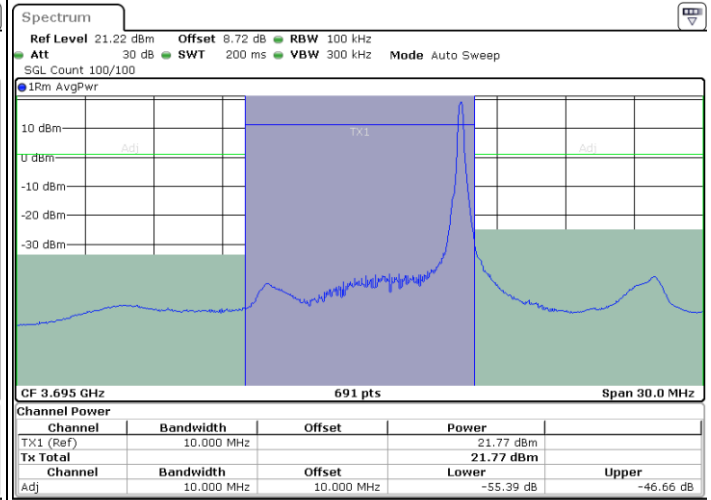

Date: 9.JAN.2023 16:23:19

Highest Channel / Full RB

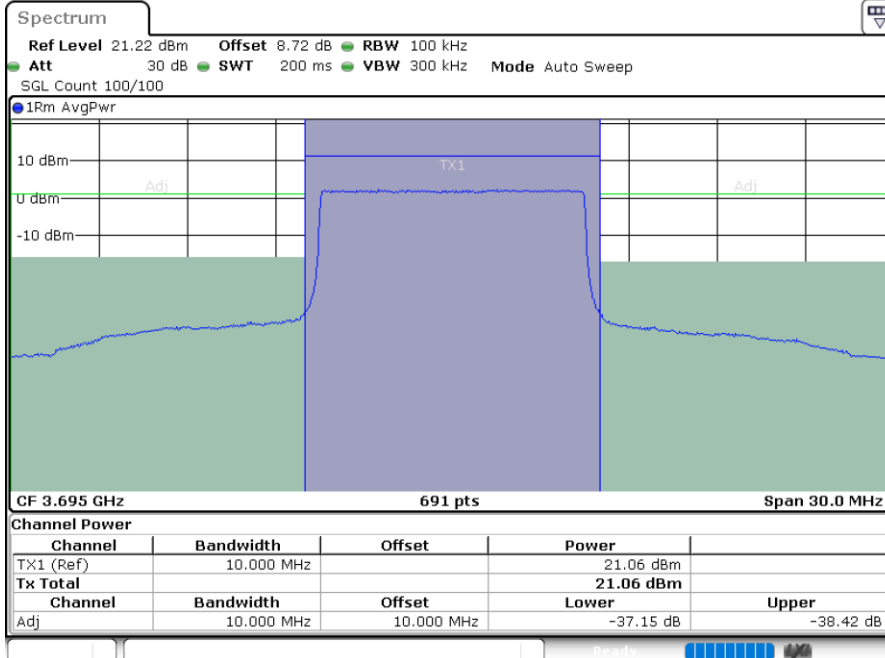

Date: 9.JAN.2023 16:25:54



LTE Band 48 / 10MHz

64QAM

Lowest Channel / 1RB0

Lowest Channel / 1RBmax

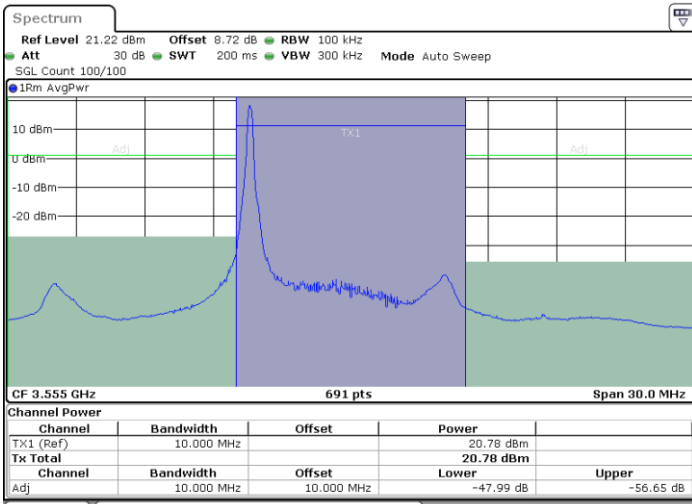

Date: 9.JAN.2023 16:05:08

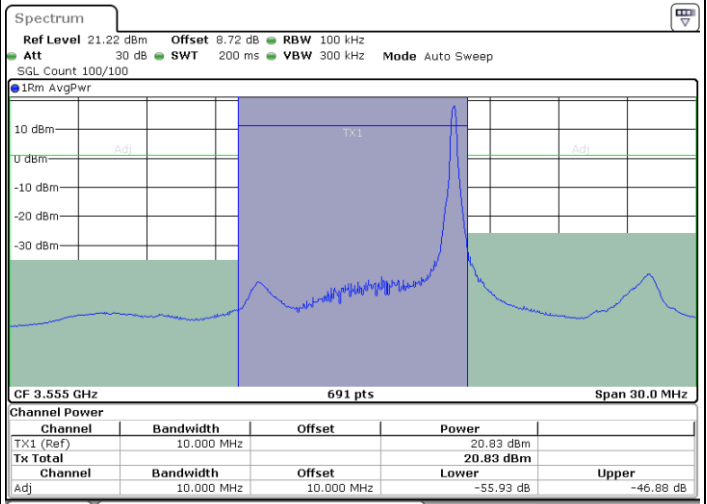

Date: 9.JAN.2023 16:07:39

Lowest Channel / Full RB

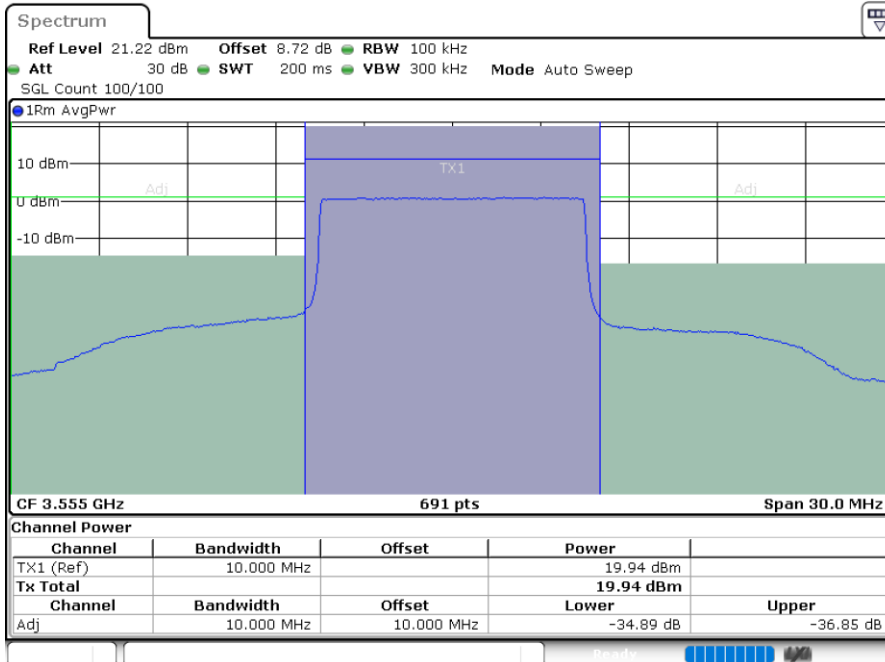

Date: 9.JAN.2023 16:10:11



LTE Band 48 / 10MHz

64QAM

Middle Channel / 1RB0

Middle Channel / 1RBmax

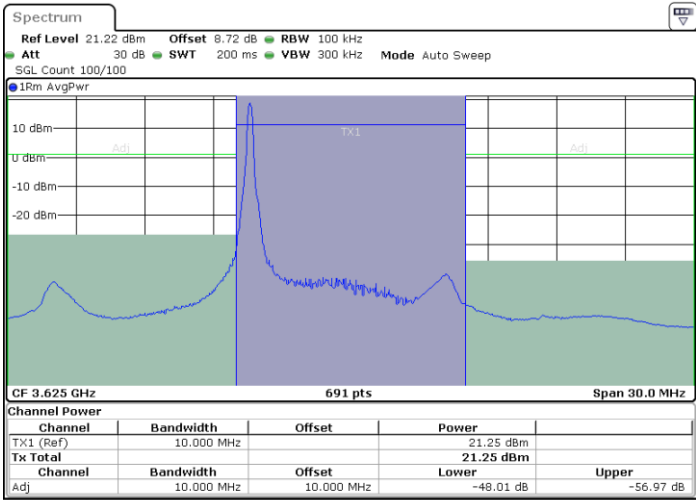

Date: 9.JAN.2023 16:13:53

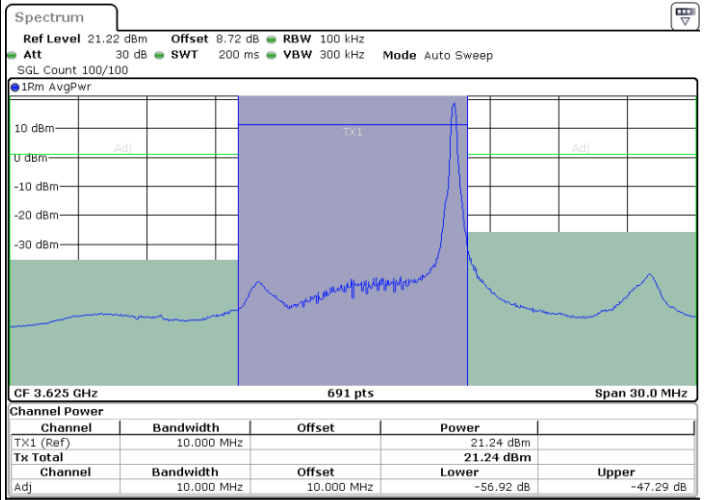

Date: 9.JAN.2023 16:16:22

Middle Channel / Full RB

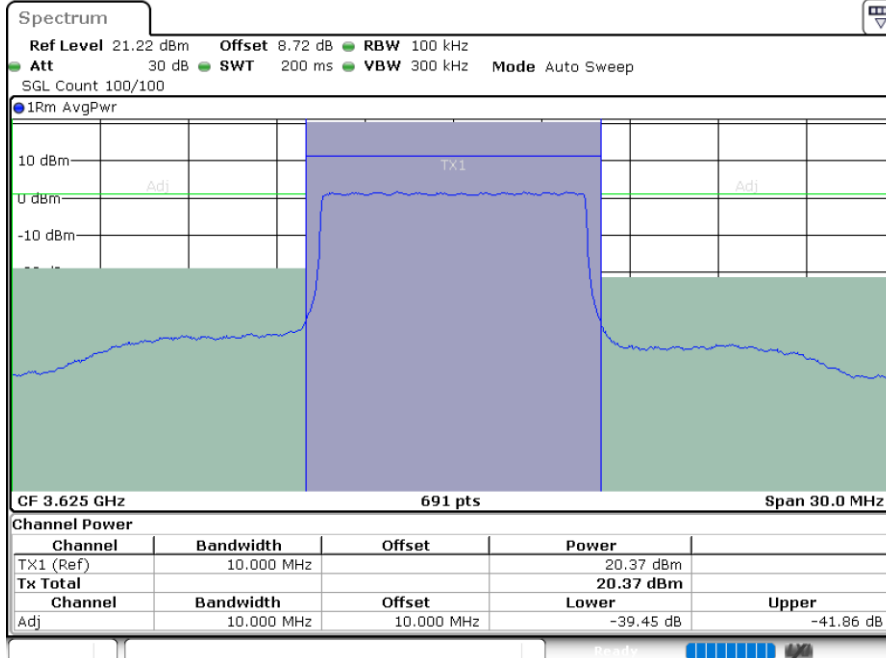

Date: 9.JAN.2023 16:18:50



LTE Band 48 / 10MHz

64QAM

Highest Channel / 1RB0

Highest Channel / 1RBmax

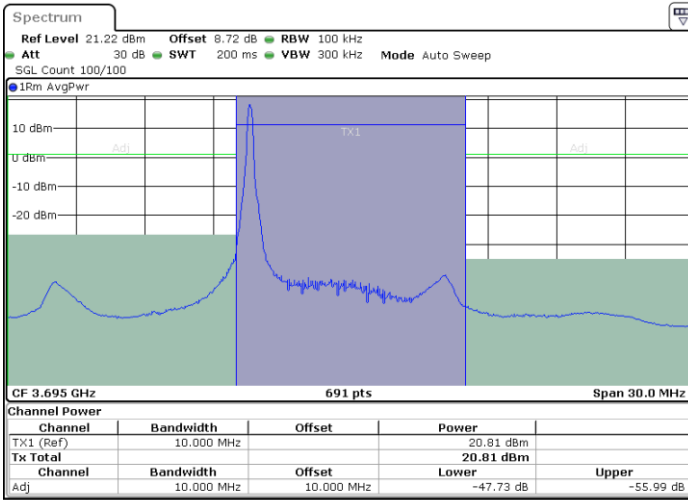

Date: 9.JAN.2023 16:21:23

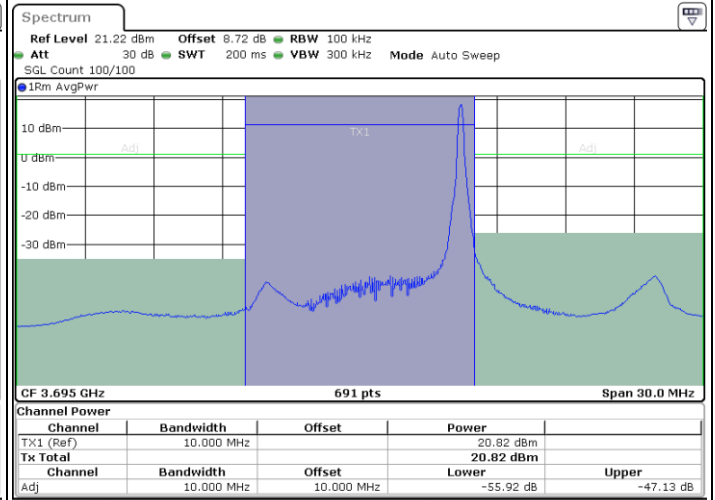

Date: 9.JAN.2023 16:23:58

Highest Channel / Full RB

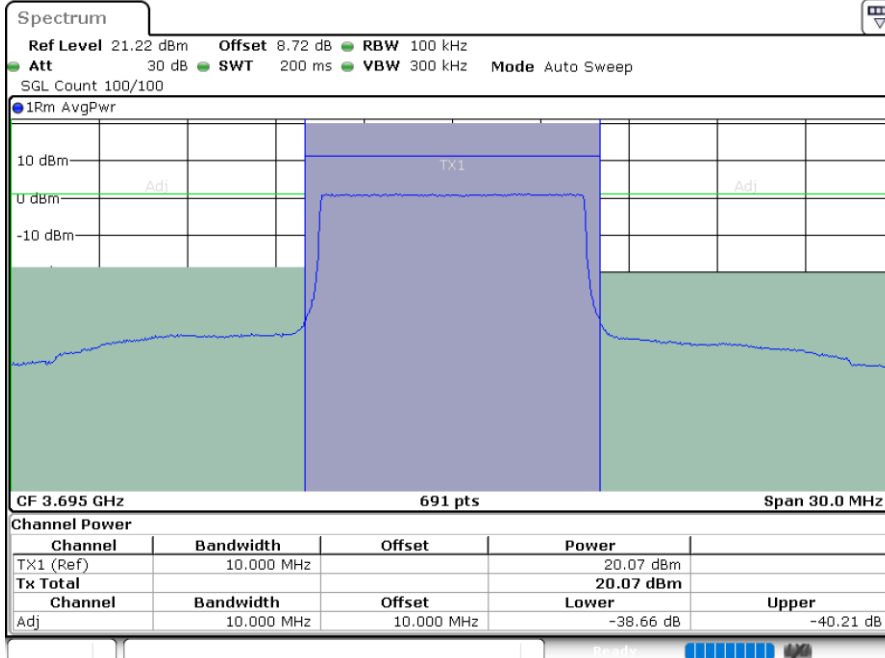

Date: 9.JAN.2023 16:26:33



LTE Band 48 / 10MHz

256QAM

Lowest Channel / 1RB0

Lowest Channel / 1RBmax

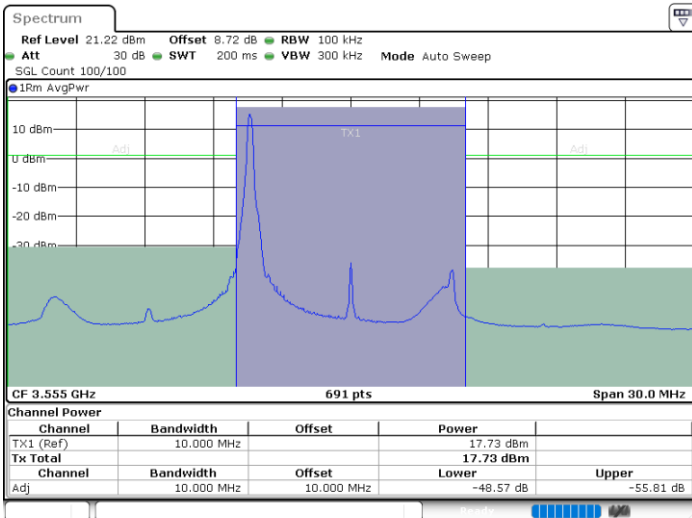

Date: 9.JAN.2023 16:05:46

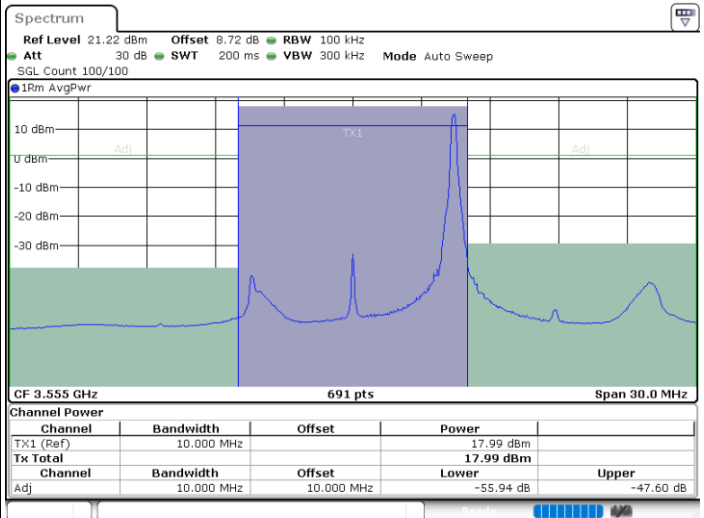

Date: 9.JAN.2023 16:08:17

Lowest Channel / Full RB

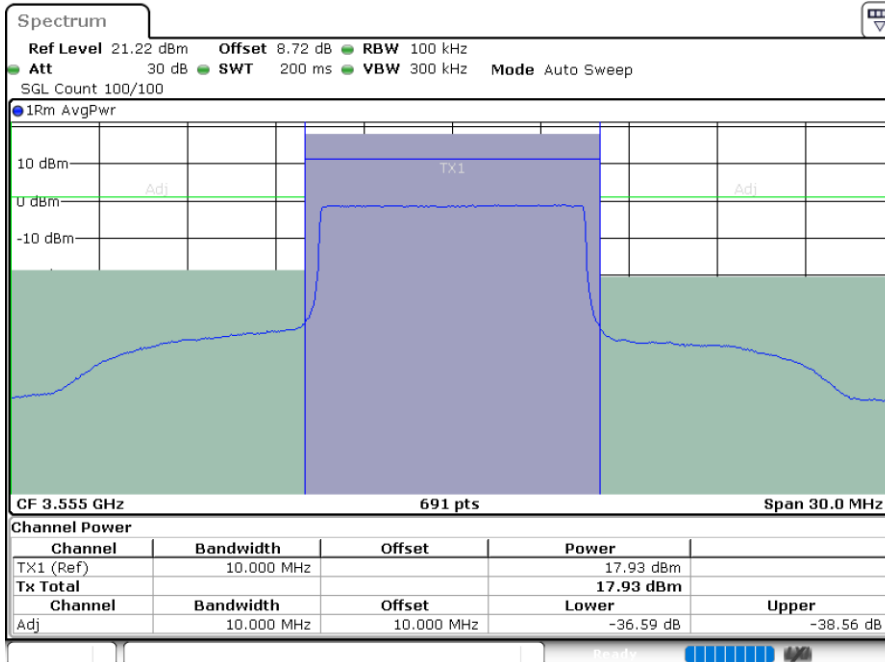

Date: 9.JAN.2023 16:10:49





LTE Band 48 / 10MHz

256QAM

Middle Channel / 1RB0

Middle Channel / 1RBmax

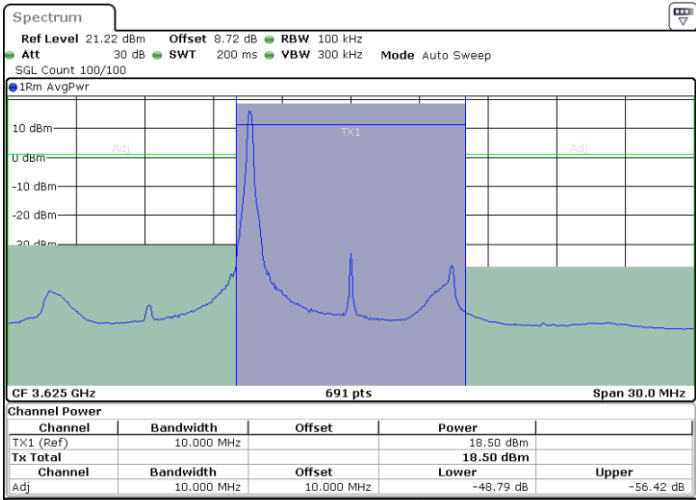

Date: 9.JAN.2023 16:14:30

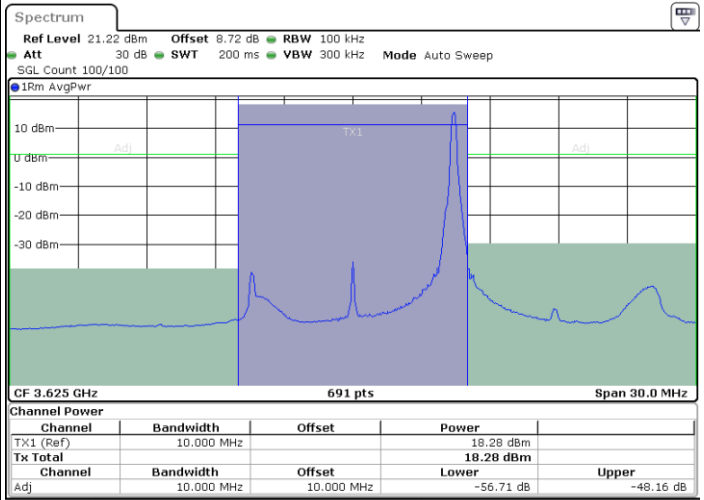

Date: 9.JAN.2023 16:16:59

Middle Channel / Full RB

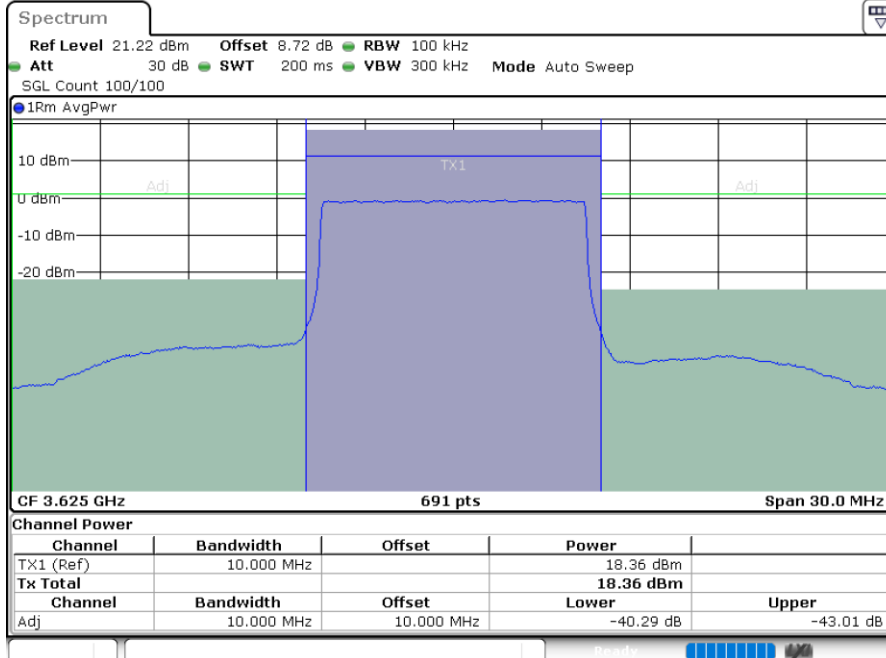

Date: 9.JAN.2023 16:19:27



**LTE Band 48 / 10MHz**

**256QAM**

**Highest Channel / 1RB0**

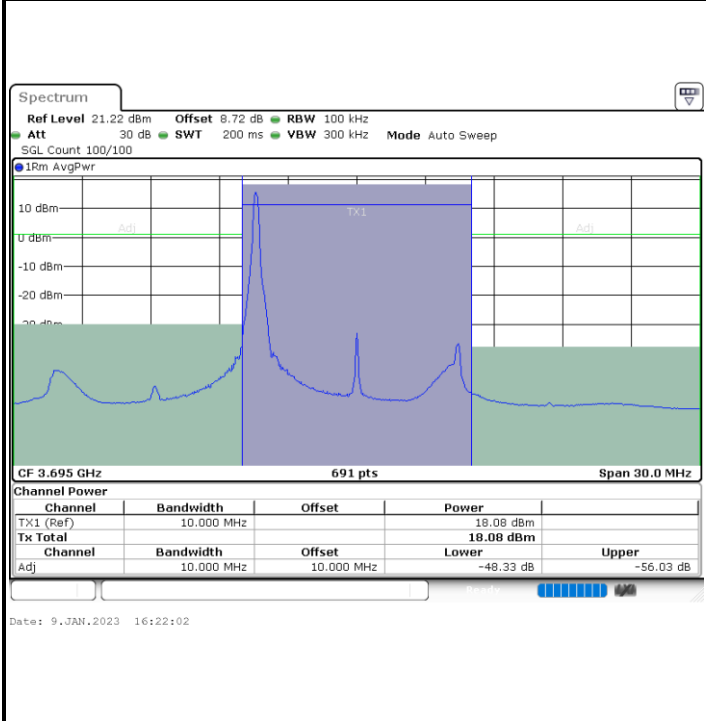

**Highest Channel / 1RBmax**

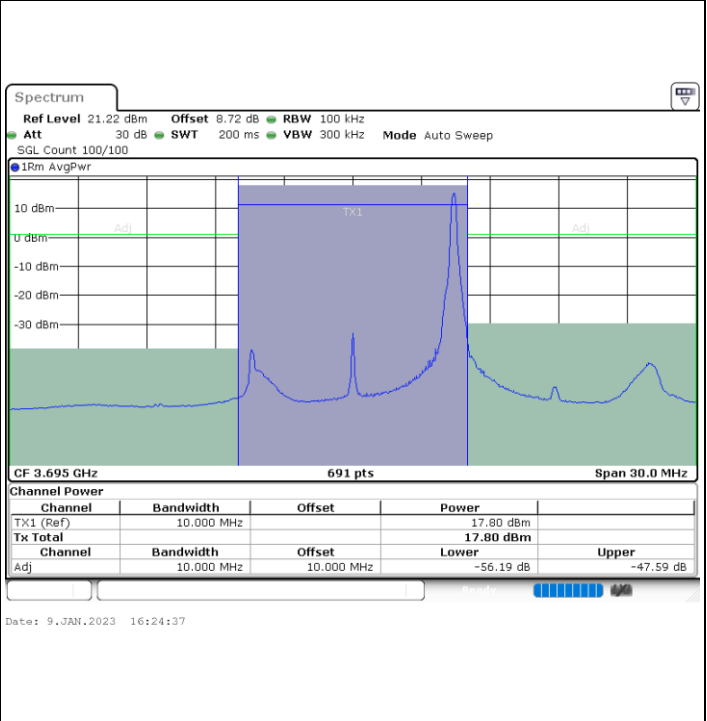

**Highest Channel / Full RB**

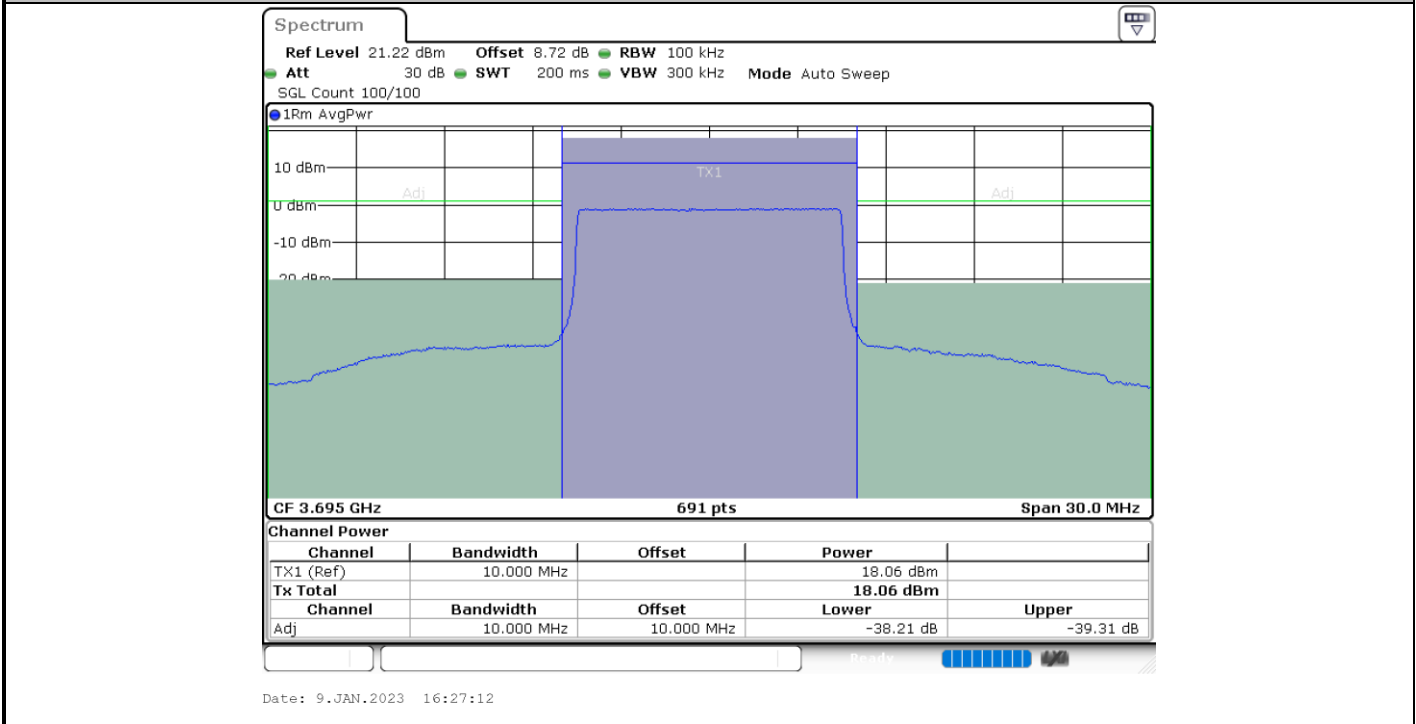



LTE Band 48 / 15MHz

QPSK

Lowest Channel / 1RB0

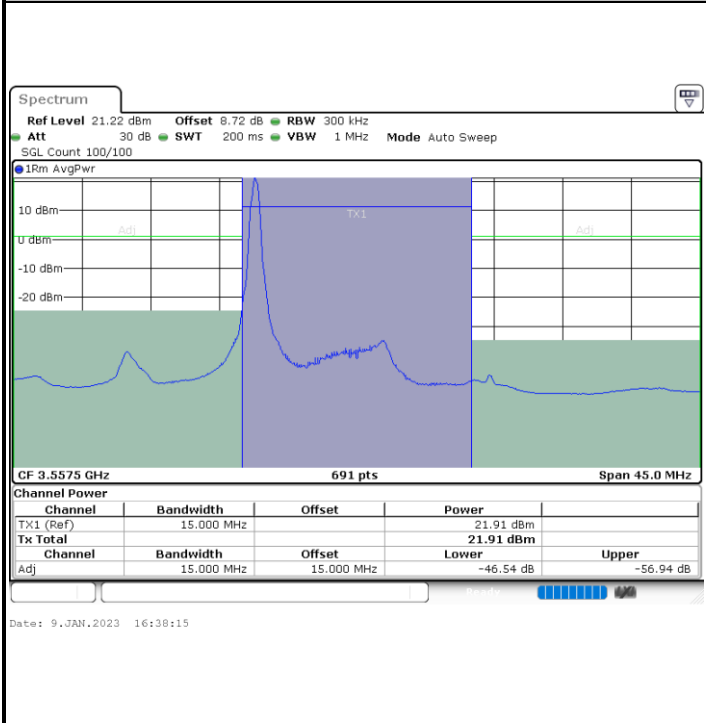

Lowest Channel / 1RBmax

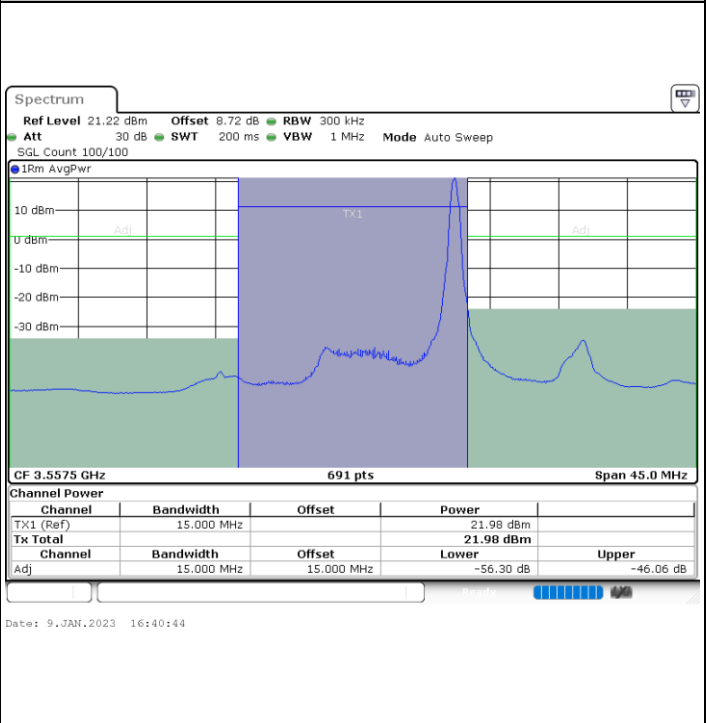

Lowest Channel / Full RB

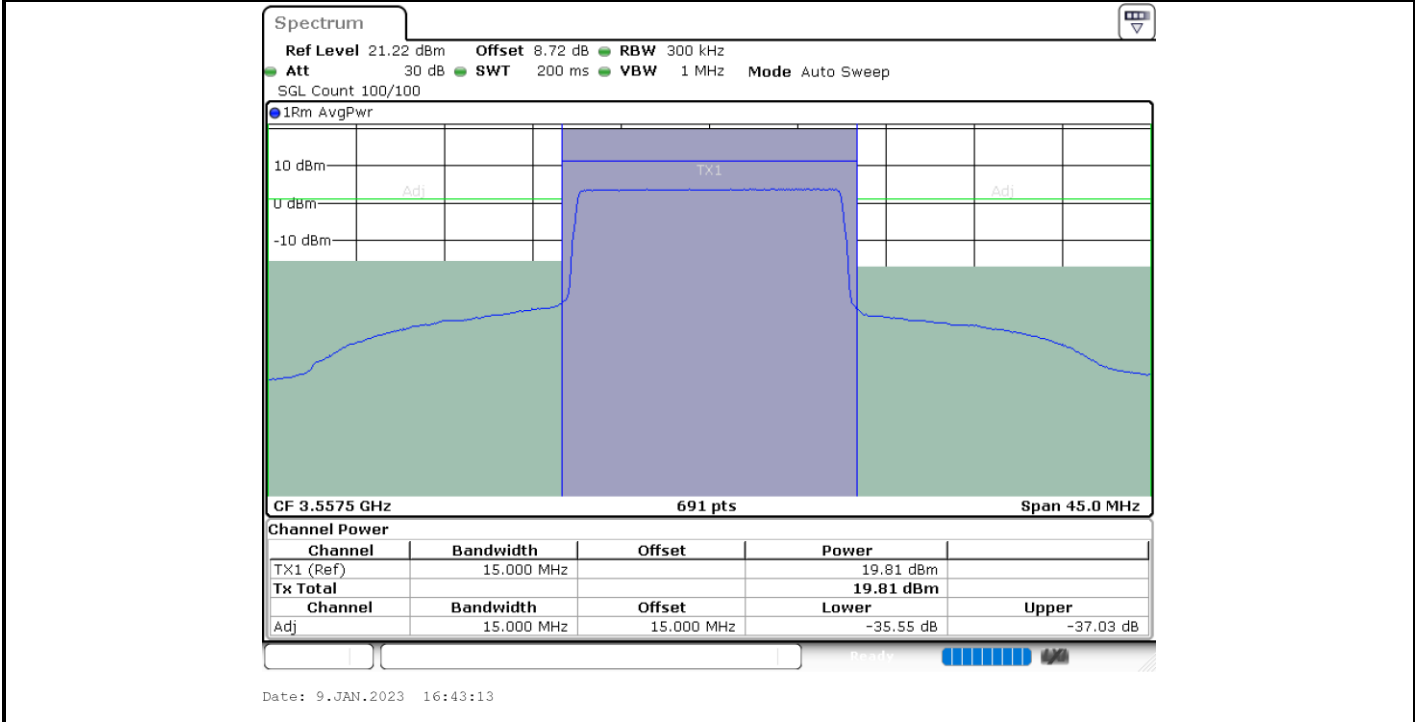



**LTE Band 48 / 15MHz**

**QPSK**

**Middle Channel / 1RB0**

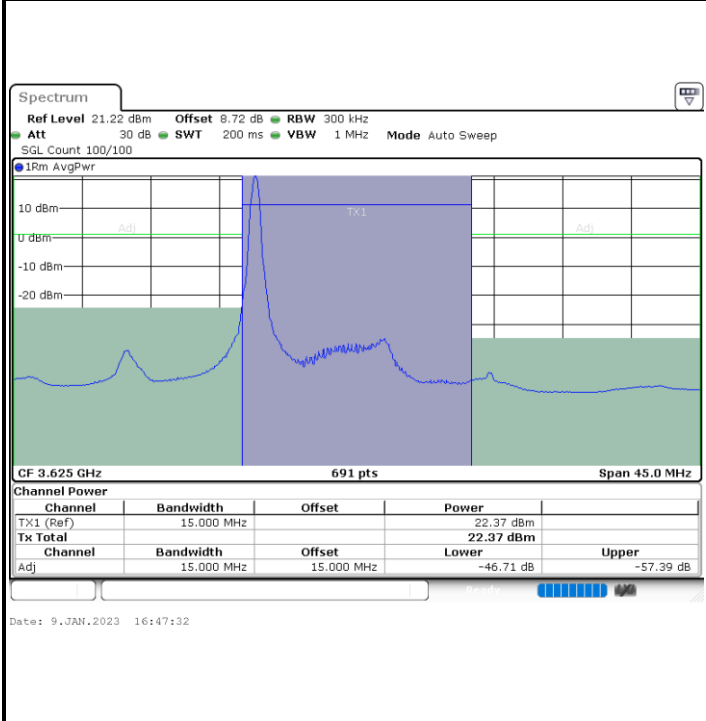

**Middle Channel / 1RBmax**

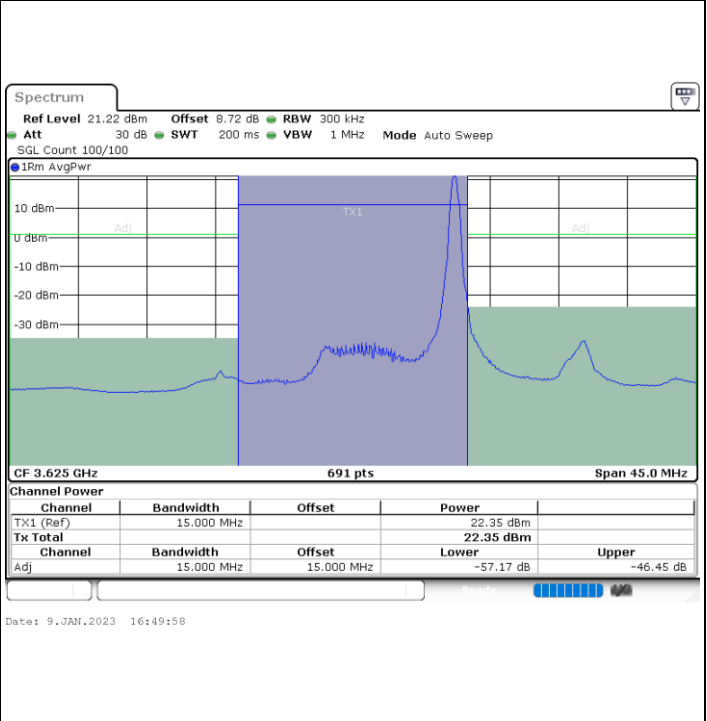

**Middle Channel / Full RB**

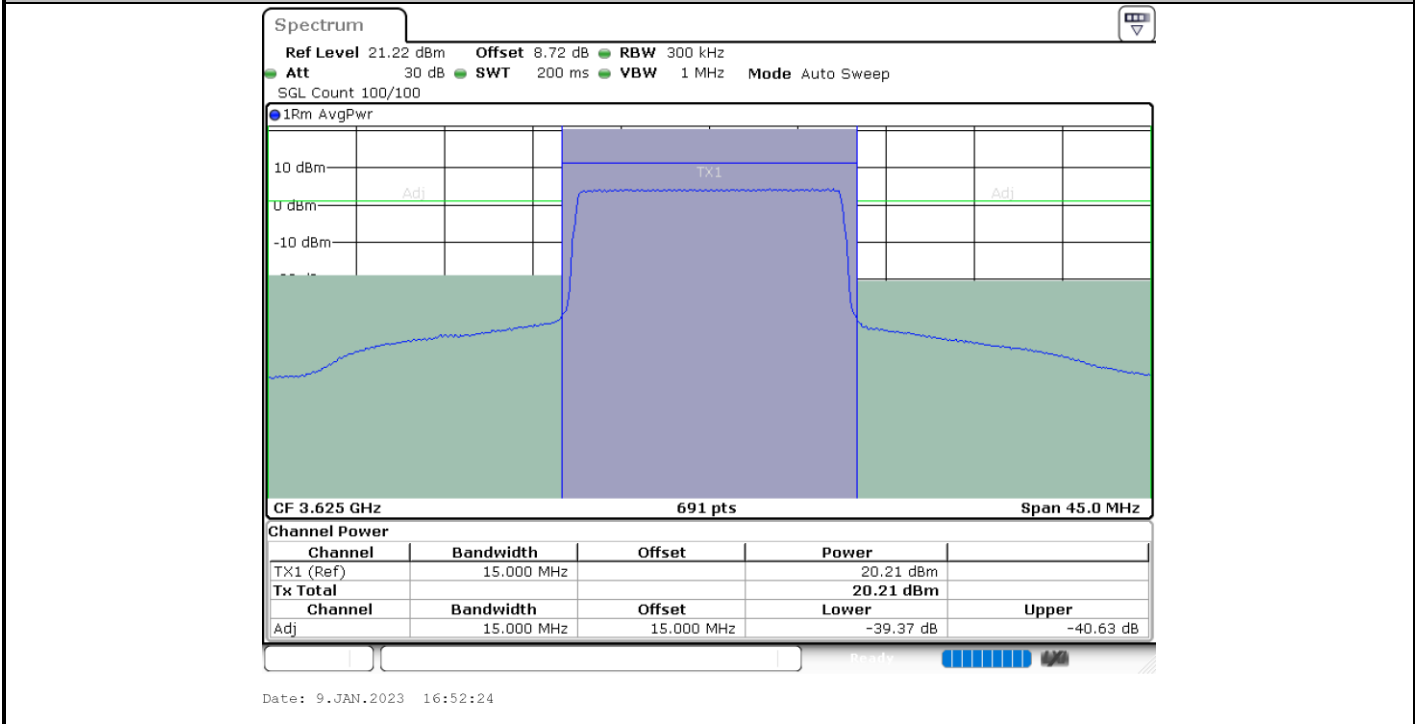



LTE Band 48 / 15MHz

QPSK

Highest Channel / 1RB0

Highest Channel / 1RBmax

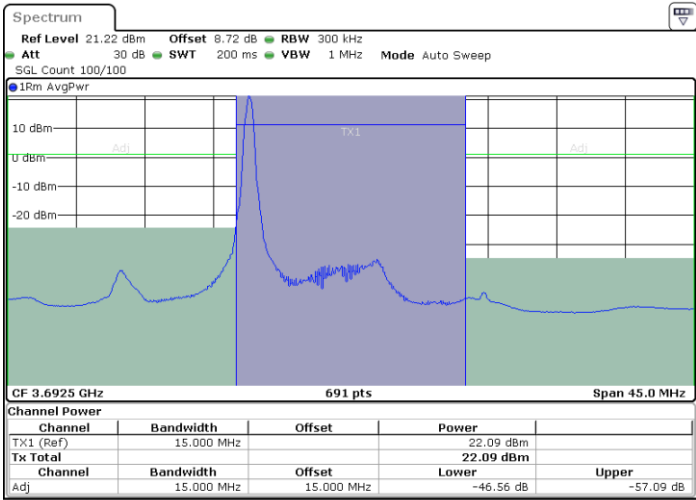

Date: 9.JAN.2023 16:54:50

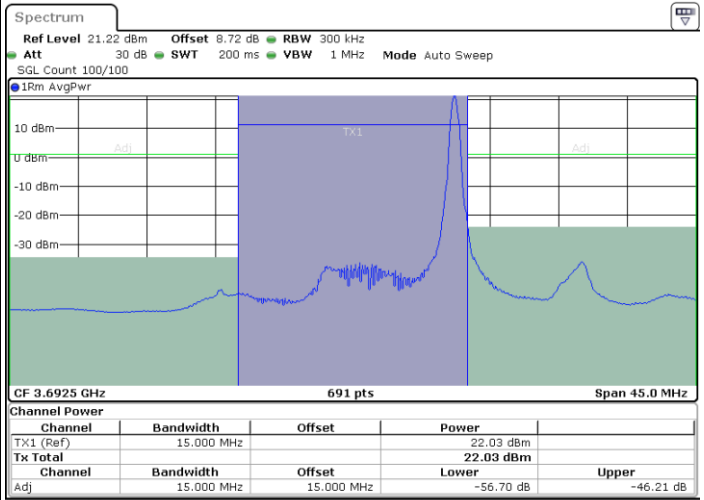

Date: 9.JAN.2023 16:57:18

Highest Channel / Full RB

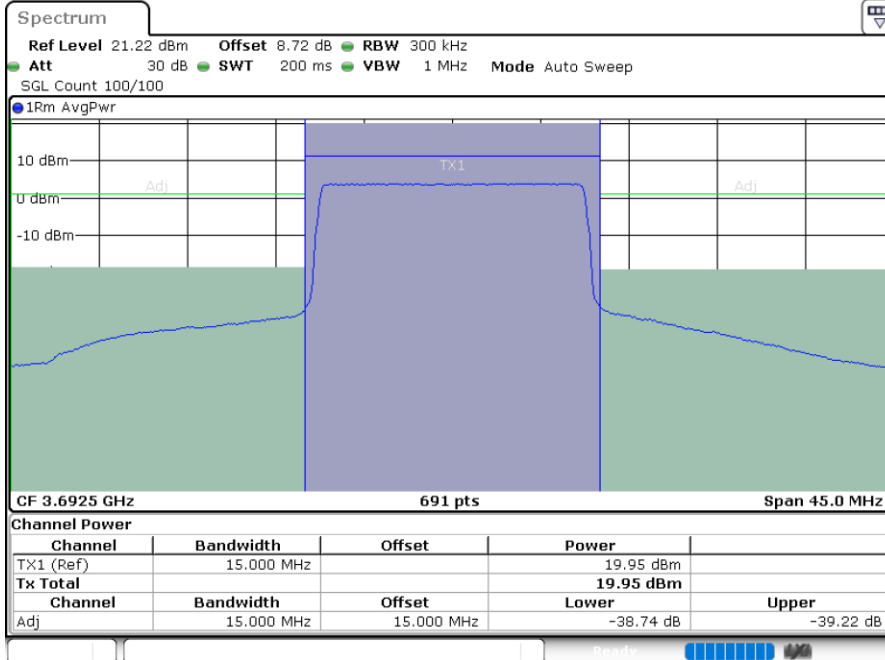

Date: 9.JAN.2023 16:59:50



LTE Band 48 / 15MHz

16QAM

Lowest Channel / 1RB0

Lowest Channel / 1RBmax

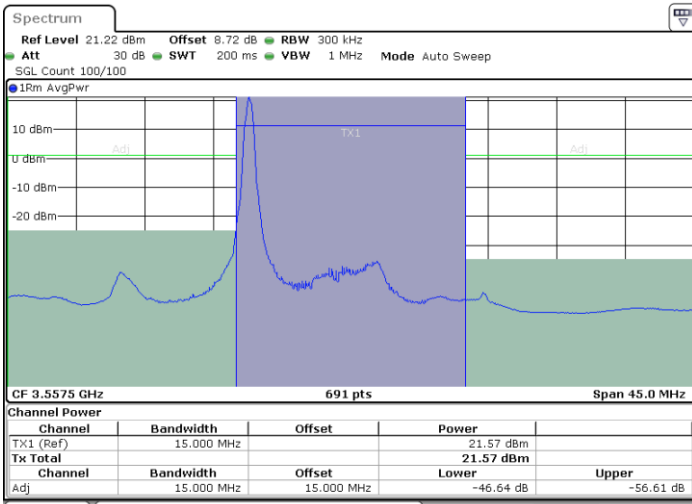

Date: 9.JAN.2023 16:38:52

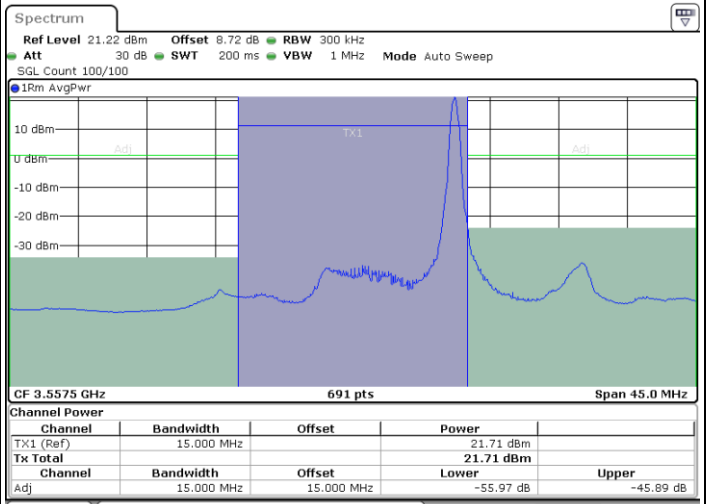

Date: 9.JAN.2023 16:41:21

Lowest Channel / Full RB

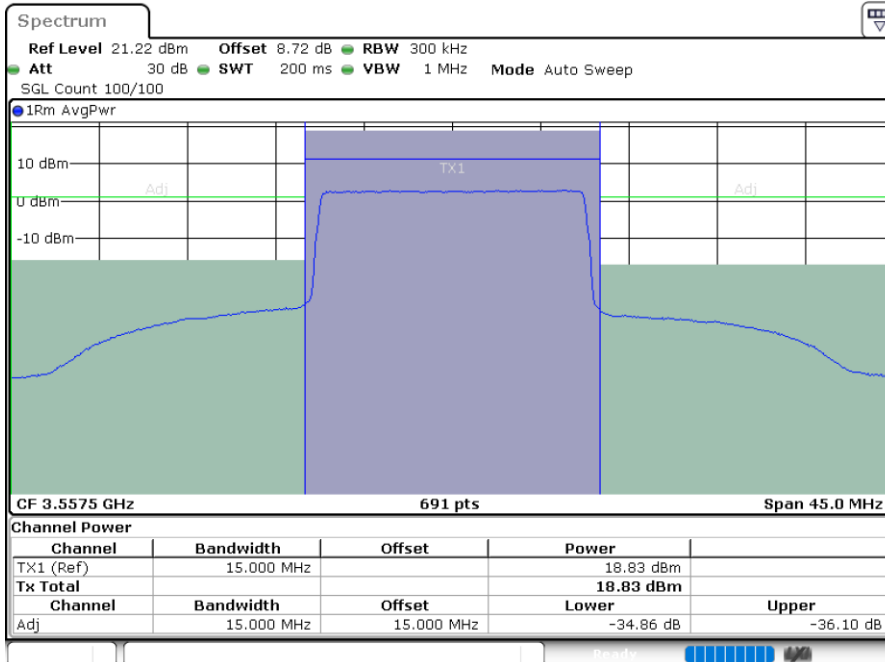

Date: 9.JAN.2023 16:43:50



**LTE Band 48 / 15MHz**

**16QAM**

**Middle Channel / 1RB0**

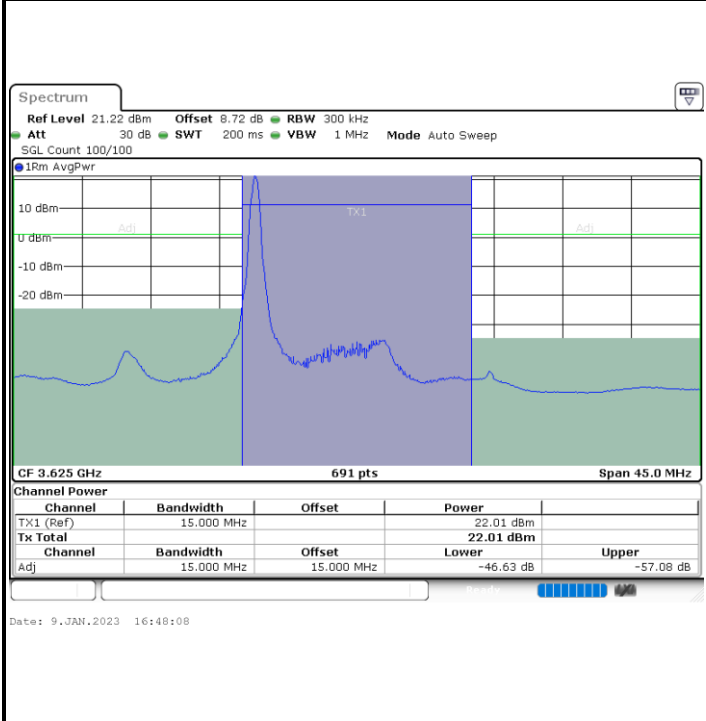

**Middle Channel / 1RBmax**

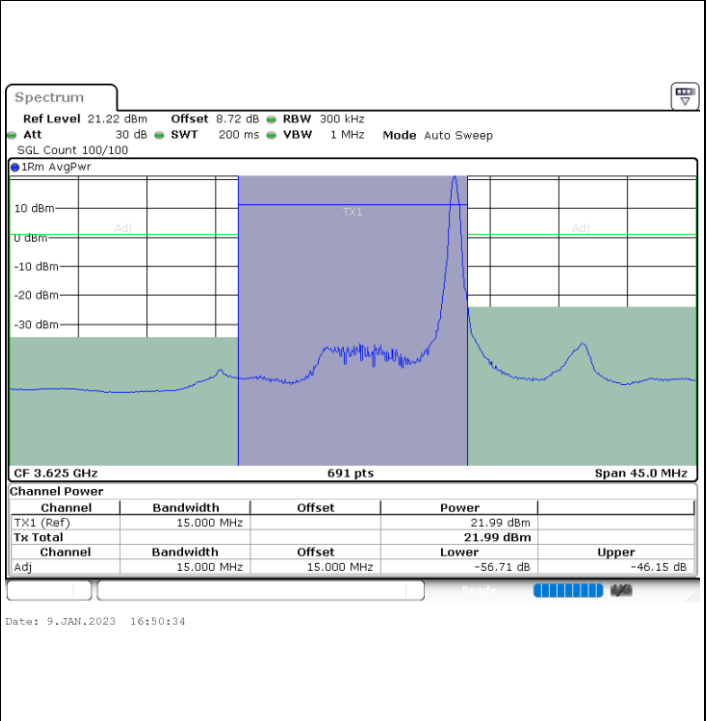

**Middle Channel / Full RB**

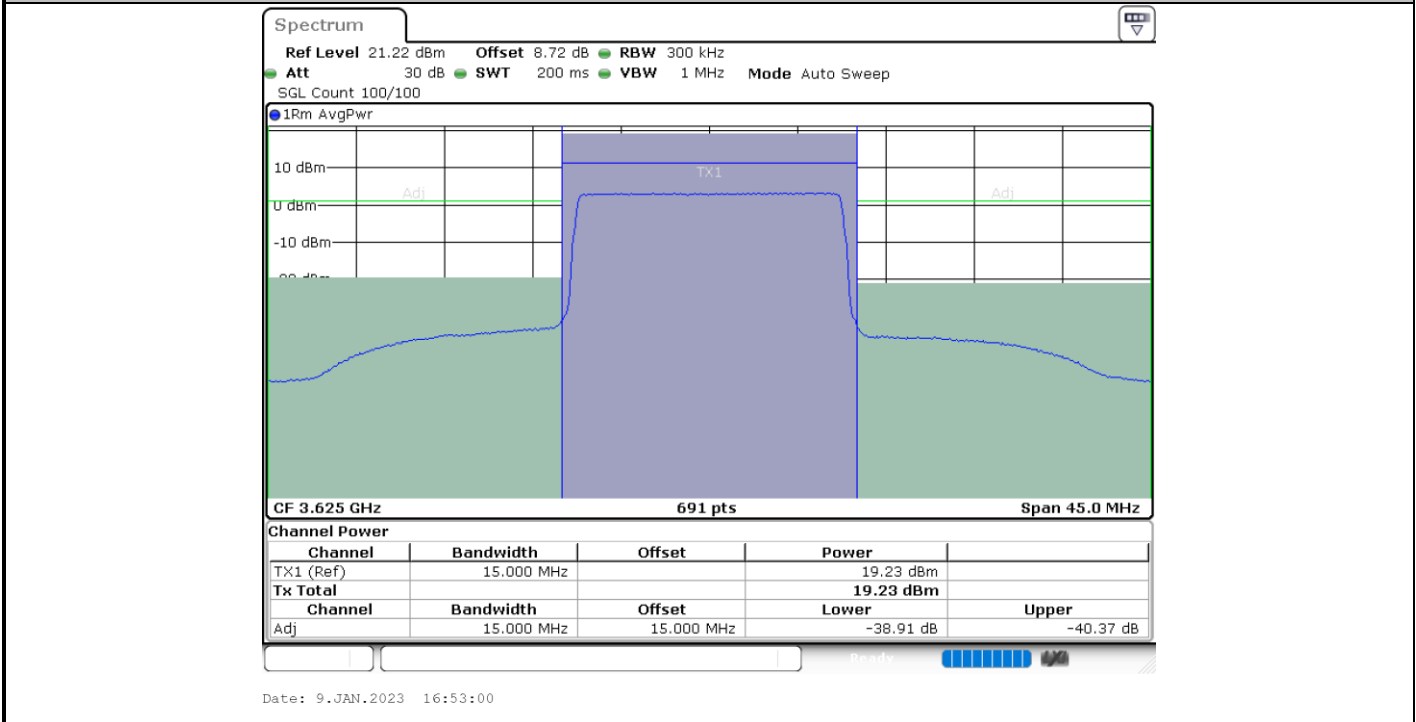



LTE Band 48 / 15MHz

16QAM

Highest Channel / 1RB0

Highest Channel / 1RBmax

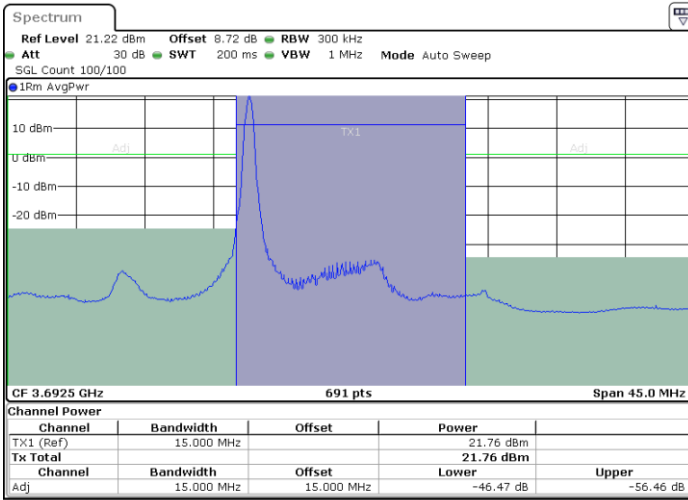

Date: 9.JAN.2023 16:55:27

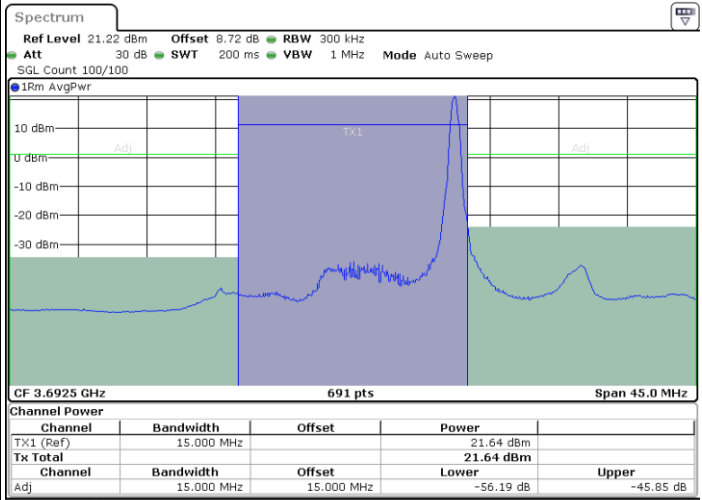

Date: 9.JAN.2023 16:57:55

Highest Channel / Full RB

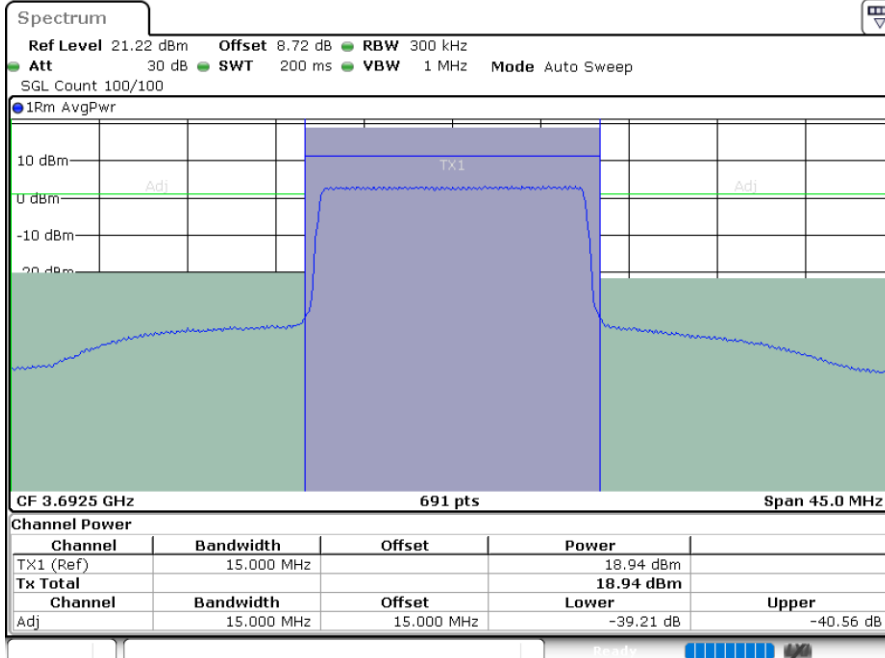

Date: 9.JAN.2023 17:00:27





LTE Band 48 / 15MHz

64QAM

Lowest Channel / 1RB0

Lowest Channel / 1RBmax

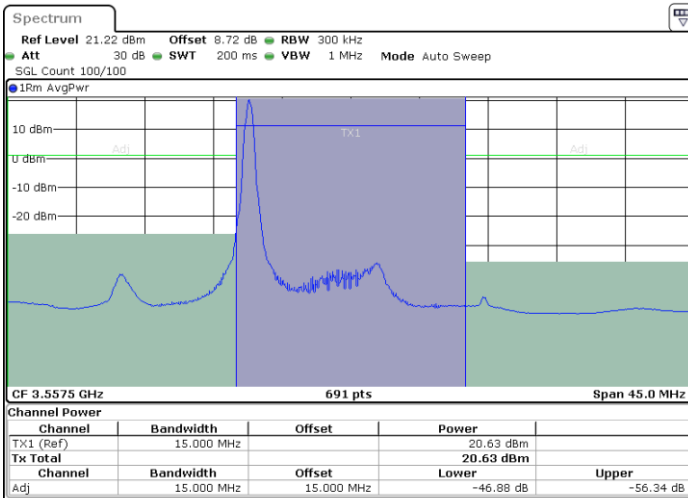

Date: 9.JAN.2023 16:39:29

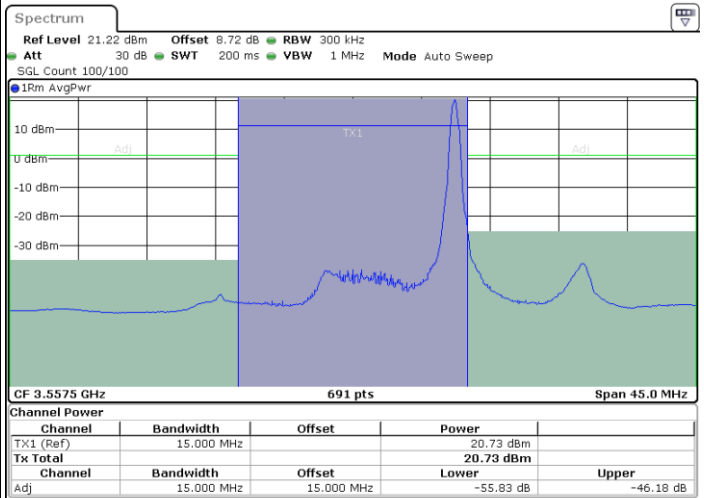

Date: 9.JAN.2023 16:41:58

Lowest Channel / Full RB

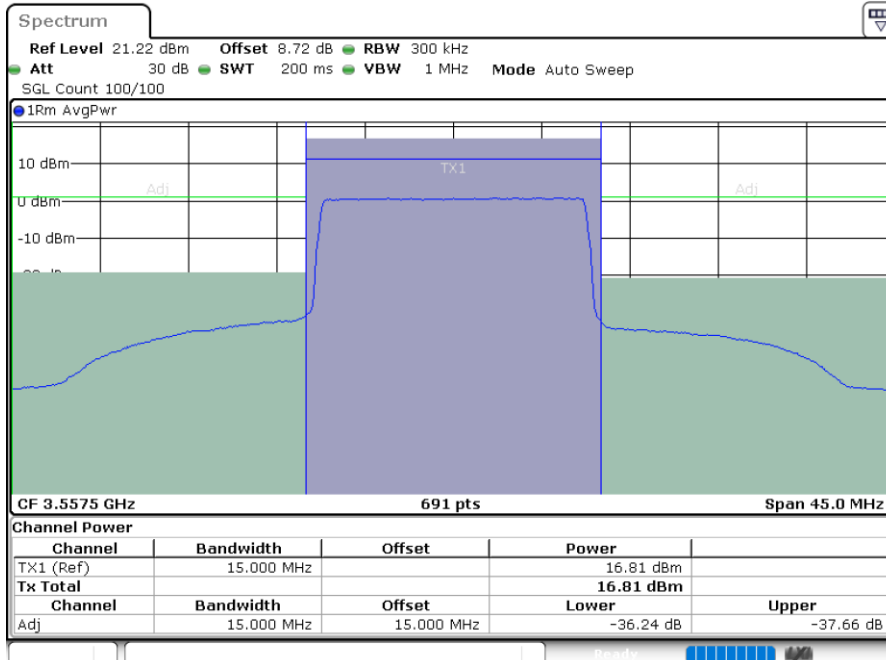

Date: 9.JAN.2023 16:44:28