



# FCC RF Test Report

**APPLICANT** : Motorola Mobility LLC  
**EQUIPMENT** : Mobile Cellular Phone  
**BRAND NAME** : Motorola  
**MODEL NAME** : XT2311-3, XT2311-4, XT2311DL  
**FCC ID** : IHDT56AH4  
**STANDARD** : FCC Part 15 Subpart E §15.407  
**CLASSIFICATION** : (NII) Unlicensed National Information Infrastructure  
**TEST DATE(S)** : Oct. 08, 2022 ~ Oct. 28, 2022

We, Sporton International Inc. (Kunshan), would like to declare that the tested sample has been evaluated in accordance with the test procedures and has been in compliance with the applicable technical standards.

The test results in this report apply exclusively to the tested model / sample. Without written approval of Sporton International Inc. (Kunshan), the test report shall not be reproduced except in full.

Jason Jia



Approved by: Jason Jia

**Sporton International Inc. (Kunshan)**

**No. 1098, Pengxi North Road, Kunshan Economic Development Zone Jiangsu Province 215300  
People's Republic of China**



# TABLE OF CONTENTS

**REVISION HISTORY..... 3**

**SUMMARY OF TEST RESULT ..... 4**

**1 GENERAL DESCRIPTION ..... 5**

    1.1 Applicant ..... 5

    1.2 Manufacturer ..... 5

    1.3 Product Feature of Equipment Under Test ..... 5

    1.4 Product Specification of Equipment Under Test ..... 6

    1.5 Specification of Accessory ..... 7

    1.6 Modification of EUT ..... 7

    1.7 Testing Location ..... 7

    1.8 Test Software ..... 7

    1.9 Applicable Standards ..... 8

**2 TEST CONFIGURATION OF EQUIPMENT UNDER TEST ..... 9**

    2.1 Carrier Frequency and Channel ..... 9

    2.2 Test Mode ..... 11

    2.3 Connection Diagram of Test System ..... 13

    2.4 Support Unit used in test configuration and system ..... 14

    2.5 EUT Operation Test Setup ..... 14

    2.6 Measurement Results Explanation Example ..... 14

**3 TEST RESULT ..... 15**

    3.1 26dB & 99% Occupied Bandwidth Measurement ..... 15

    3.2 Maximum Conducted Output Power Measurement ..... 19

    3.3 Power Spectral Density Measurement ..... 21

    3.4 Unwanted Emissions Measurement ..... 23

    3.5 AC Conducted Emission Measurement ..... 28

    3.6 Antenna Requirements ..... 30

**4 LIST OF MEASURING EQUIPMENT ..... 31**

**5 UNCERTAINTY OF EVALUATION ..... 32**

**APPENDIX A. CONDUCTED TEST RESULTS**

**APPENDIX B. AC CONDUCTED EMISSION TEST RESULT**

**APPENDIX C. RADIATED SPURIOUS EMISSION**

**APPENDIX D. DUTY CYCLE PLOTS**

**APPENDIX E. SETUP PHOTOGRAPHS**





### SUMMARY OF TEST RESULT

Report Section	FCC Rule	Description	Limit	Result	Remark
3.1	2.1049 & 15.403(i)	26dB & 99% Bandwidth	-	Report only	-
3.2	15.407(a)	Maximum Conducted Output Power	≤ 24 dBm	Pass	-
3.3	15.407(a)	Power Spectral Density	≤ 11 dBm	Pass	-
3.4	15.407(b)	Unwanted Emissions	15.407(b) & 15.209(a)	Pass	Under limit 2.31 dB at 41.64 MHz
3.5	15.207	AC Conducted Emission	15.207(a)	Pass	Under limit 9.26 dB at 0.151 MHz
3.6	15.203 & 15.407(a)	Antenna Requirement	15.203 & 15.407(a)	Pass	-

<b>Declaration of Conformity:</b>
The test results with all measurement uncertainty excluded are presented in accordance with the regulation limits or requirements declared by manufacturers.
<b>Comments and Explanations:</b>
The declared of product specification for EUT presented in the report are provided by the manufacturer, and the manufacturer takes all the responsibilities for the accuracy of product specification.



# 1 General Description

## 1.1 Applicant

Motorola Mobility LLC  
222 W,Merchandise Mart Plaza, Chicago IL 60654 USA

## 1.2 Manufacturer

Motorola Mobility LLC  
222 W,Merchandise Mart Plaza, Chicago IL 60654 USA

## 1.3 Product Feature of Equipment Under Test

Product Feature	
Equipment	Mobile Cellular Phone
Brand Name	Motorola
Model Name	XT2311-3, XT2311-4, XT2311DL
FCC ID	IHDT56AH4
IMEI Code	Conducted: 358373300033767 Conduction: 358373300025292 Radiation: 358373300025870
HW Version	DVT2
SW Version	TTO33.44
EUT Stage	Identical Prototype

**Remark:** The above EUT's information was declared by manufacturer. Please refer to the specifications or user's manual for more detailed description.



### 1.4 Product Specification of Equipment Under Test

Standards-related Product Specification	
<b>Tx/Rx Frequency Range</b>	5180 MHz ~ 5240 MHz 5260 MHz ~ 5320 MHz 5500 MHz ~ 5720 MHz
<b>Maximum Output Power to Antenna</b>	<p><b>&lt;5180 MHz ~ 5240 MHz&gt;</b>  802.11a : 19.09 dBm / 0.0811 W  802.11n HT20 : 19.17 dBm / 0.0826 W  802.11n HT40 : 17.88 dBm / 0.0614 W  802.11ac VHT20 : 17.69 dBm / 0.0587 W  802.11ac VHT40 : 16.77 dBm / 0.0475 W  802.11ac VHT80 : 15.78 dBm / 0.0378 W</p> <p><b>&lt;5260 MHz ~ 5320 MHz&gt;</b>  802.11a : 19.06 dBm / 0.0805 W  802.11n HT20 : 19.04 dBm / 0.0802 W  802.11n HT40 : 17.84 dBm / 0.0608 W  802.11ac VHT20 : 17.53 dBm / 0.0566 W  802.11ac VHT40 : 16.61 dBm / 0.0458 W  802.11ac VHT80 : 15.70 dBm / 0.0372 W</p> <p><b>&lt;5500 MHz ~ 5720 MHz &gt;</b>  802.11a : 18.99 dBm / 0.0793 W  802.11n HT20 : 18.94 dBm / 0.0783 W  802.11n HT40 : 17.91 dBm / 0.0618 W  802.11ac VHT20 : 17.53 dBm / 0.0566 W  802.11ac VHT40 : 16.74 dBm / 0.0472 W  802.11ac VHT80 : 15.90 dBm / 0.0389 W</p>
<b>99% Occupied Bandwidth</b>	<p><b>&lt;5180 MHz ~ 5240 MHz&gt;</b>  802.11a : 17.13 MHz  802.11n HT20 : 18.23 MHz  802.11n HT40 : 36.86 MHz  802.11ac VHT80 : 75.16 MHz</p> <p><b>&lt;5260 MHz ~ 5320 MHz&gt;</b>  802.11a : 17.18 MHz  802.11n HT20 : 18.13 MHz  802.11n HT40 : 37.46 MHz  802.11ac VHT80 : 75.16 MHz</p> <p><b>&lt;5500 MHz ~ 5720 MHz &gt;</b>  802.11a : 17.08 MHz  802.11n HT20 : 18.13 MHz  802.11n HT40 : 37.46 MHz  802.11ac VHT80 : 75.28 MHz</p>
<b>Antenna Type / Gain</b>	<p><b>&lt;5180 MHz ~ 5240 MHz&gt;</b>  IFA Antenna with gain -5.5 dBi</p> <p><b>&lt;5260 MHz ~ 5320 MHz&gt;</b>  IFA Antenna with gain -5.8 dBi</p> <p><b>&lt;5500 MHz ~ 5720 MHz&gt;</b>  IFA Antenna with gain -5.2 dBi</p>
<b>Type of Modulation</b>	802.11a/n : OFDM (BPSK / QPSK / 16QAM / 64QAM) 802.11ac : OFDM (BPSK / QPSK / 16QAM / 64QAM / 256QAM)

**Note:** For 802.11n HT20 / ac VHT20 and 802.11n HT40 / ac VHT40 mode, the whole testing have assessed only 802.11n HT20/HT40 by referring to their maximum output power.



### 1.5 Specification of Accessory

Specification of Accessory				
AC Adapter 1	Brand Name	Motorola(AOHAI)	Model Name	MC-101
AC Adapter 2	Brand Name	Motorola(Chenyang)	Model Name	MC-101
AC Adapter 3	Brand Name	Motorola(Salcomp)	Model Name	MC-101
Battery 1	Brand Name	Motorola (Sunwoda)	Model Name	PD50
Battery 2	Brand Name	Motorola (SCUD)	Model Name	PD50
USB Cable 1	Brand Name	HX	Model Name	S928D43190
USB Cable 2	Brand Name	NAEE	Model Name	S928D43191

### 1.6 Modification of EUT

No modifications are made to the EUT during all test items.

### 1.7 Testing Location

Sporton International Inc. (Kunshan) is accredited to ISO/IEC 17025:2017 by American Association for Laboratory Accreditation with Certificate Number 5145.02.

Test Firm	Sporton International Inc. (Kunshan)		
Test Site Location	No. 1098, Pengxi North Road, Kunshan Economic Development Zone Jiangsu Province 215300 People’s Republic of China TEL : +86-512-57900158 FAX : +86-512-57900958		
Test Site No.	Sporton Site No.	FCC Designation No.	FCC Test Firm Registration No.
	CO01-KS 03CH05-KS TH01-KS	CN1257	314309

### 1.8 Test Software

Item	Site	Manufacturer	Name	Version
1.	03CH05-KS	AUDIX	E3	6.2009-8-24
2.	CO01-KS	AUDIX	E3	6.2009-8-24



## **1.9 Applicable Standards**

According to the specifications of the manufacturer, the EUT must comply with the requirements of the following standards:

- ♦ 47 CFR Part 15 Subpart E
- ♦ FCC KDB 789033 D02 General UNII Test Procedures New Rules v02r01.
- ♦ FCC KDB 662911 D01 Multiple Transmitter Output v02r01.
- ♦ ANSI C63.10-2013

**Remark:**

1. All test items were verified and recorded according to the standards and without any deviation during the test.
2. This EUT has also been tested and complied with the requirements of FCC Part 15, Subpart B, recorded in a separate test report.



## 2 Test Configuration of Equipment Under Test

- a. The EUT has been associated with peripherals and configuration operated in a manner tended to maximize its emission characteristics in a typical application. Frequency range investigated: conduction emission (150 kHz to 30 MHz), radiation emission (9 kHz to the 10th harmonic of the highest fundamental frequency or to 40 GHz, whichever is lower). For radiated measurement, pre-scanned in three orthogonal panels, X, Y, Z. The worst cases (Z plane) were recorded in this report.
- b. AC power line Conducted Emission was tested under maximum output power.

### 2.1 Carrier Frequency and Channel

Frequency Band	Channel	Freq. (MHz)	Channel	Freq. (MHz)
5180-5240 MHz U-NII-1	36	5180	44	5220
	38*	5190	46*	5230
	40	5200	48	5240
	42 <sup>#</sup>	5210		

Frequency Band	Channel	Freq. (MHz)	Channel	Freq. (MHz)
5260-5320 MHz U-NII-2A	52	5260	60	5300
	54*	5270	62*	5310
	56	5280	64	5320
	58 <sup>#</sup>	5290		

Frequency Band	Channel	Freq. (MHz)	Channel	Freq. (MHz)
5500- 5720 MHz MHz U-NII-2C	100	5500	112	5560
	102*	5510	116	5580
	104	5520	132	5660
	106 <sup>#</sup>	5530	134*	5670
	108	5540	136	5680
	110*	5550	140	5700



Frequency Band	Channel	Freq. (MHz)	Channel	Freq. (MHz)
TDWR Channel	118*	5590	124	5620
	120	5600	126*	5630
	122 <sup>#</sup>	5610	128	5640

Frequency Band	Channel	Freq. (MHz)	Channel	Freq. (MHz)
Straddle Channel	138 <sup>#</sup>	5690	144	5720
	142*	5710		

**Note:**

1. The above Frequency and Channel in "\*" were 802.11n HT40 and 802.11ac VHT40.
2. The above Frequency and Channel in "<sup>#</sup>" were 802.11ac VHT80.



## 2.2 Test Mode

Final test modes are considering the modulation and worse data rates as below table.

Modulation	Data Rate
802.11a	6 Mbps
802.11n HT20	MCS0
802.11n HT40	MCS0

Test Cases	
AC Conducted Emission	Mode 1 : GSM850 Idle+ BT Link +WLAN Link(5G)+ Adaptor 3 + USB Cable2 + Earphone

RSE Co-location
WIFI 802.11a CH64 TX + LTE Band48 Link

**Remark:**

1. For Radiated Test Cases, The tests were performance with Adapter 2, USB Cable 2 and Earphone.
2. The accessories are from the worse mode of Part 15B report.
3. The RSE Co-location mode is form the worst combination of WLAN TX + WWAN Link mode.



Ch. #		U-NII-1 : 5180-5240 MHz	U-NII-2A : 5260-5320 MHz	U-NII-2C : 5500- 5720 MHz
		802.11a	802.11a	802.11a
L	Low	36	52	100
M	Middle	44	60	116
H	High	48	64	140
Straddle		-	-	144

Ch. #		U-NII-1 : 5180-5240 MHz	U-NII-2A : 5260-5320 MHz	U-NII-2C : 5500- 5720 MHz
		802.11n HT20	802.11n HT20	802.11n HT20
L	Low	36	52	100
M	Middle	44	60	116
H	High	48	64	140
Straddle		-	-	144

Ch. #		U-NII-1 : 5180-5240 MHz	U-NII-2A : 5260-5320 MHz	U-NII-2C : 5500- 5720 MHz
		802.11n HT40	802.11n HT40	802.11n HT40
L	Low	38	54	102
M	Middle	-	-	110
H	High	46	62	134
Straddle		-	-	142

Ch. #		U-NII-1 : 5150-5250 MHz	U-NII-2A : 5250-5350 MHz	U-NII-2C : 5470-5725MHz
		802.11ac VHT80	802.11ac VHT80	802.11ac VHT80
L	Low	-	-	106
M	Middle	42	58	122
H	High	-	-	-
Straddle		-	-	138

## 2.3 Connection Diagram of Test System

AC Conducted Emission:

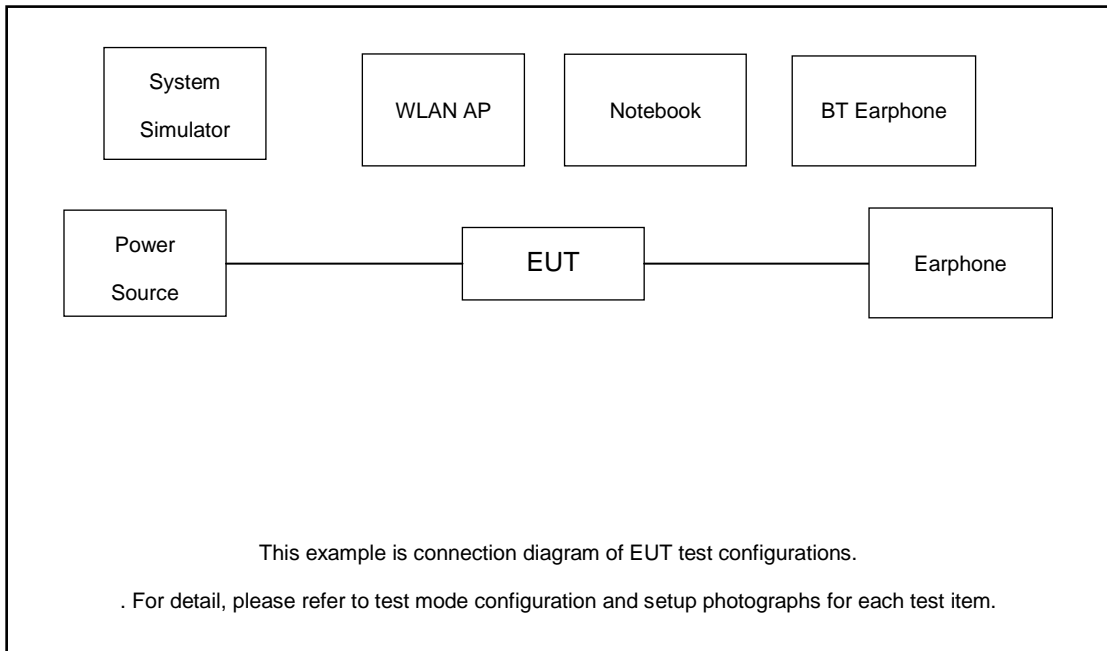

Radiated Emission:

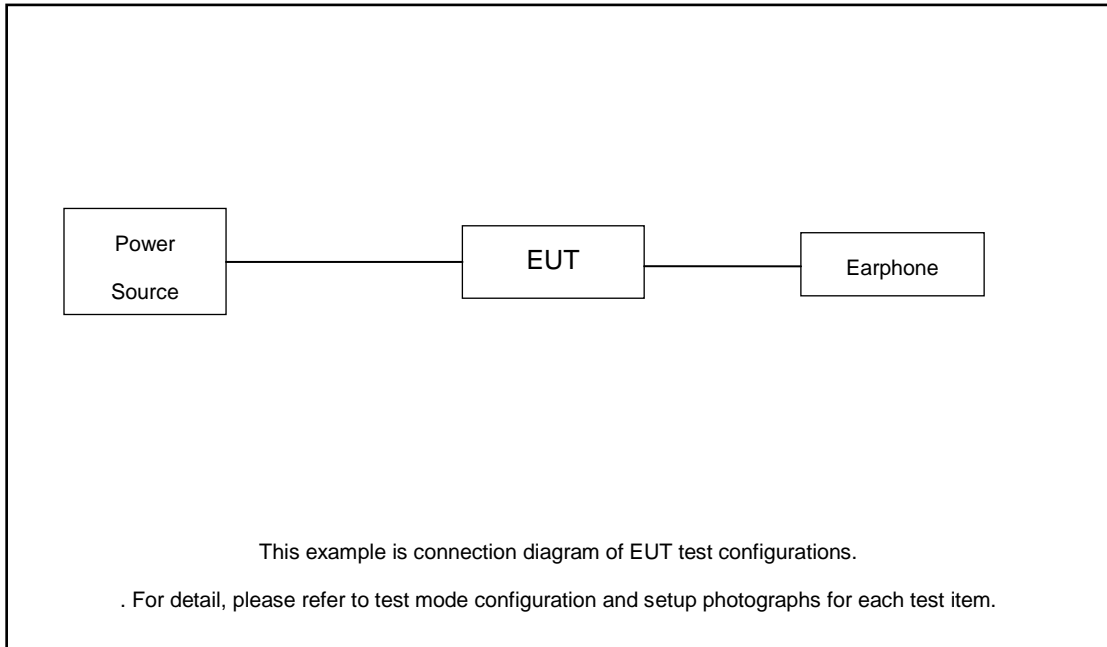

## 2.4 Support Unit used in test configuration and system

Item	Equipment	Trade Name	Model Name	FCC ID	Data Cable	Power Cord
1.	Bluetooth Earphone	Lenovo	LBH308	N/A	N/A	N/A
2.	Earphone	Lenovo	P121	N/A	N/A	Unshielded,1.2m
3.	WLAN AP	D-link	DIR-655	KA21R655B1	N/A	Unshielded,1.8m
4.	Notebook	Lenovo	G480	QDS-BRCM1050I	N/A	shielded cable DC O/P 1.8m , Unshielded AC I/P cable 1.8m
5.	SD Card	Kingston	8GB	N/A	N/A	N/A

## 2.5 EUT Operation Test Setup

For WLAN RF test items, an engineering test program was provided and enabled to make EUT continuous transmit.

For AC power line conducted emissions, the EUT was set to connect with the WLAN AP under large package sizes transmission.

## 2.6 Measurement Results Explanation Example

For all conducted test items:

The offset level is set in the spectrum analyzer to compensate the RF cable loss and attenuator factor between EUT conducted output port and spectrum analyzer. With the offset compensation, the spectrum analyzer reading level is exactly the EUT RF output level.

Example :

The spectrum analyzer offset is derived from RF cable loss  $Offset = RF\ cable\ loss$

Following shows an offset computation example with cable loss 7.50 dB

$$Offset(dB) = RF\ cable\ loss(dB)$$

$$= 7.50\ (dB)$$

### 3 Test Result

#### 3.1 26dB & 99% Occupied Bandwidth Measurement

##### 3.1.1 Description of 26dB & 99% Occupied Bandwidth

This section is for reporting purpose only.

There is no restriction limits for bandwidth.

For Straddle Channel, According to KDB 789033 D02 General UNII Test Procedures New Rules v02r01, If the power and PSD of the devices are uniform and comply with the lower limits specified for the U-NII-2 bands, a single measurement over the entire emission bandwidth can be performed to show compliance.

##### 3.1.2 Measuring Instruments

The measuring equipment is listed in the section 4 of this test report.

##### 3.1.3 Test Procedures

1. The testing follows FCC KDB 789033 D02 General UNII Test Procedures New Rules v02r01. Section C) Emission bandwidth
2. Set RBW = approximately 1% of the emission bandwidth.
3. Set the VBW > RBW.
4. Detector = Peak.
5. Trace mode = max hold
6. Measure the maximum width of the emission that is 26 dB down from the peak of the emission. Compare this with the RBW setting of the analyzer. Readjust RBW and repeat measurement as needed until the RBW/EBW ratio is approximately 1%.
7. For 99% Bandwidth Measurement, the spectrum analyzer's resolution bandwidth (RBW) is set 1% to 5% of the OBW and set the Video bandwidth (VBW)  $\geq 3 * RBW$ .
8. Measure and record the results in the test report.

##### 3.1.4 Test Setup

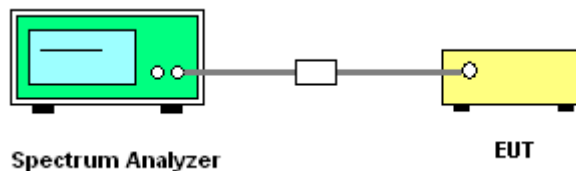



### 3.1.5 Test Result of 26dB & 99% Occupied Bandwidth

Please refer to Appendix A.

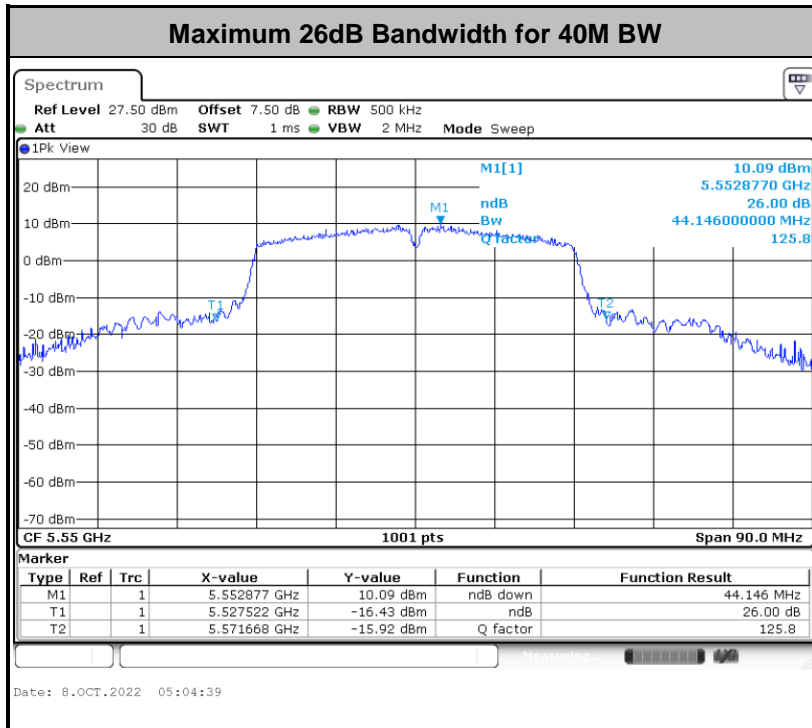
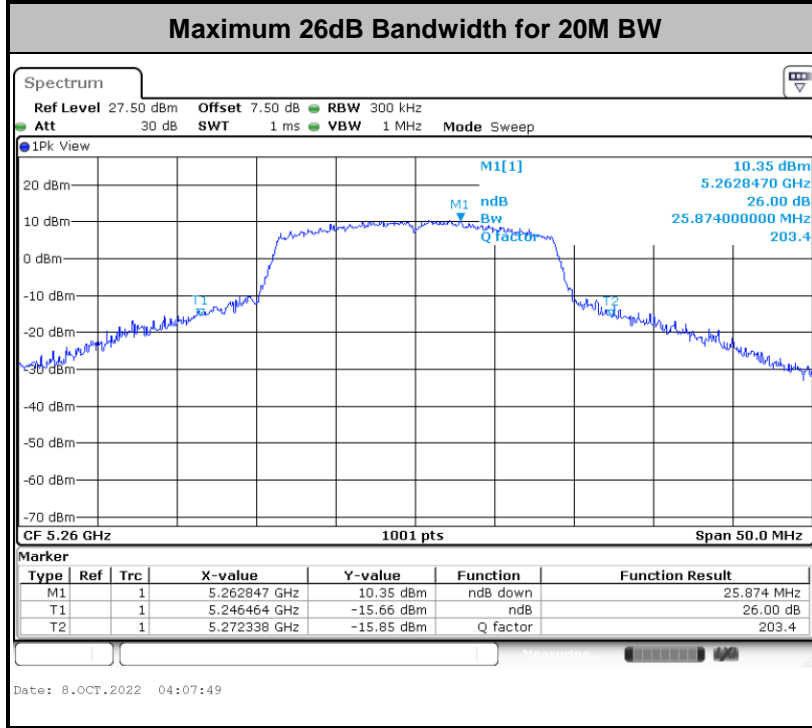



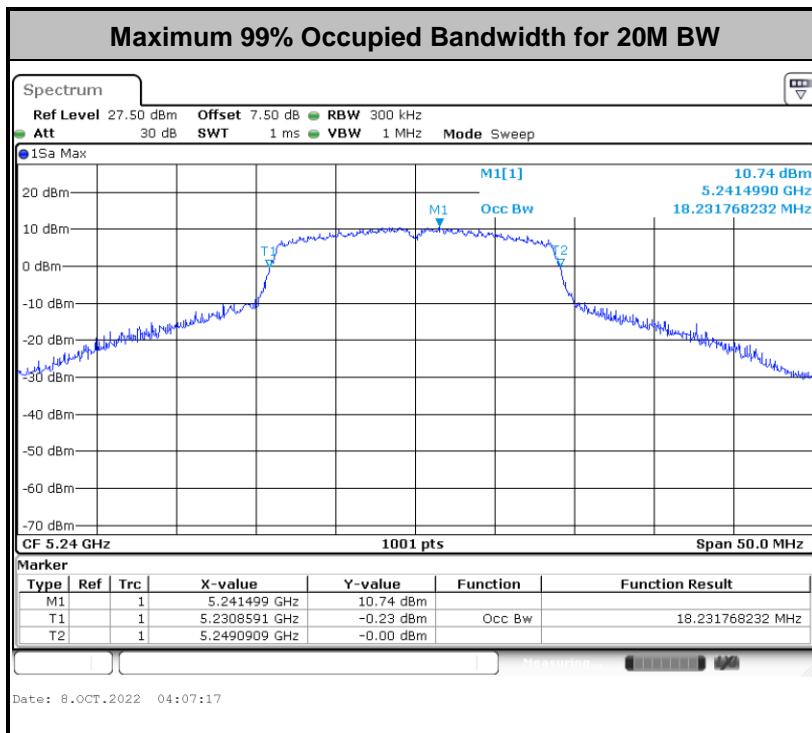
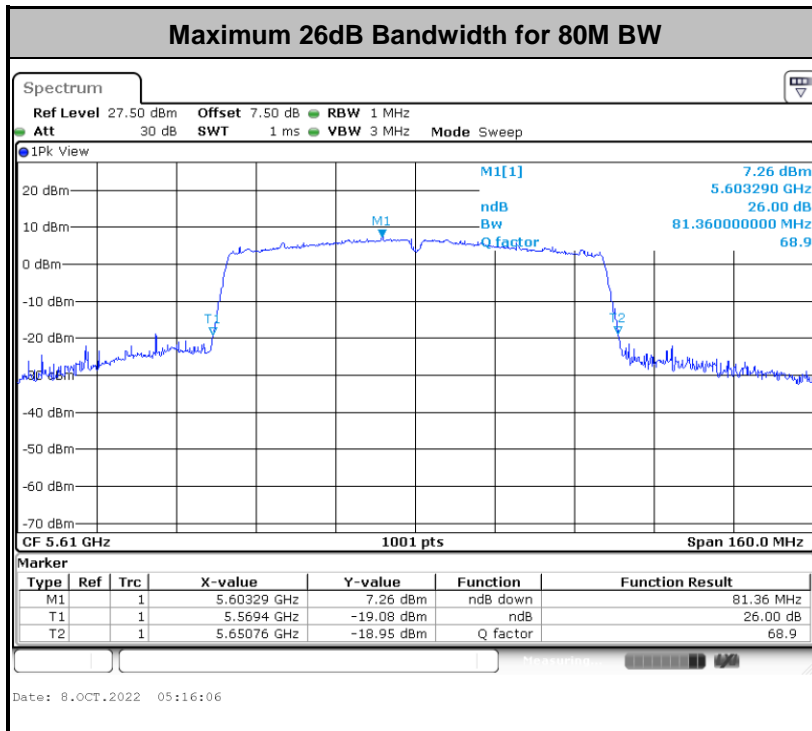

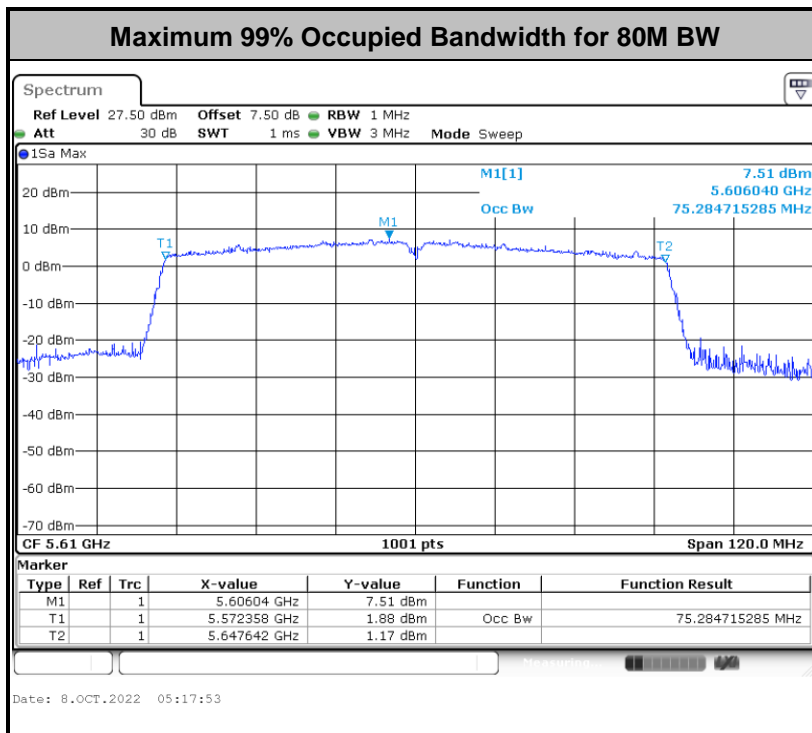
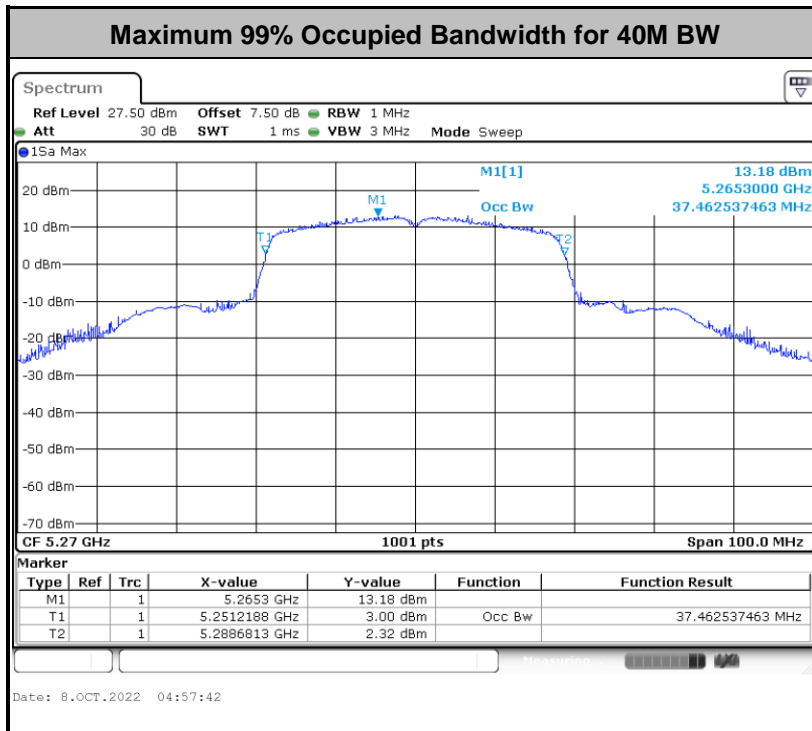

**Note:** The occupied channel bandwidth is maintained within the band of operation for all of the modulations.



## 3.2 Maximum Conducted Output Power Measurement

### 3.2.1 Limit of Maximum Conducted Output Power

<FCC 14-30 CFR 15.407>

For mobile and portable client devices in the 5.15–5.25 GHz band, the maximum conducted output power over the frequency band of operation shall not exceed 250 mW.

For the 5.25–5.725 GHz bands, the maximum conducted output power over the frequency bands of operation shall not exceed the lesser of 250 mW or  $11 \text{ dBm} + 10 \log_{10} B$ , where B is the 26 dB emission bandwidth in megahertz.

For the 5.47–5.6 GHz and 5.65–5.725 GHz band, the maximum conducted output power shall not exceed 250 mW or  $11 + 10 \log_{10} B$ , dBm, whichever power is less. The maximum e.i.r.p. shall not exceed 1.0 W or  $17 + 10 \log_{10} B$ , dBm, whichever is less. B is the 99% emission bandwidth in megahertz.

For Straddle Channel, According to KDB 789033 D02 General UNII Test Procedures New Rules v02r01, If the power and PSD of the devices are uniform and comply with the lower limits specified for the U-NII-2 bands, a single measurement over the entire emission bandwidth can be performed to show compliance.

If transmitting antennas of directional gain greater than 6 dBi are used, the peak output power shall be reduced by the amount in dB that the directional gain of the antenna exceeds 6 dBi.

Note that U-NII-2 band, devices with a maximum e.i.r.p. greater than 500 mW shall implement TPC in order to have the capability to operate at least 6 dB below the maximum permitted e.i.r.p. of 1 W.

### 3.2.2 Measuring Instruments

The measuring equipment is listed in the section 4 of this test report.

### 3.2.3 Test Procedures

The testing follows Method PM of FCC KDB 789033 D02 General UNII Test Procedures New Rules v02r01.

Method PM (Measurement using an RF average power meter):

1. Measurement is performed using a wideband RF power meter.
2. The EUT is configured to transmit continuously with a consistent duty cycle at its maximum power control level.
3. Measure the average power of the transmitter, and the average power is corrected with duty factor,  $10 \log(1/x)$ , where  $x$  is the duty cycle.

For Straddle Channel, According to KDB 789033 D02 General UNII Test Procedures New Rules v02r01, If the power and PSD of the devices are uniform and comply with the lower limits specified for the U-NII-2 bands, a single measurement over the entire emission bandwidth can be performed to show compliance.

### 3.2.4 Test Setup

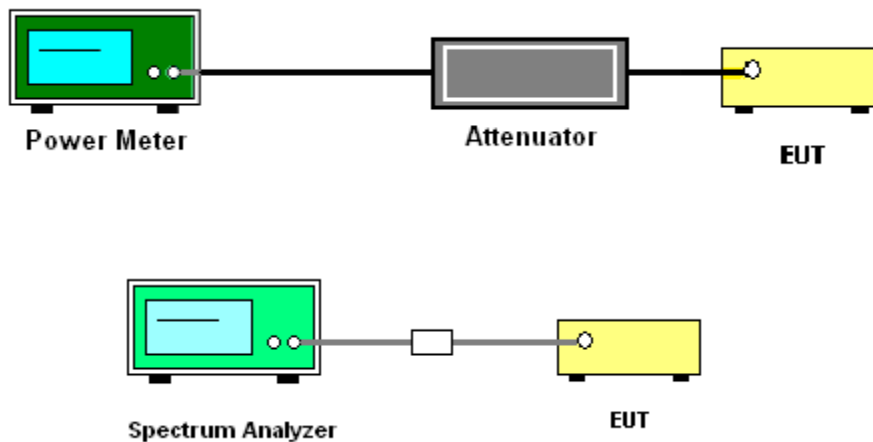

### 3.2.5 Test Result of Maximum Conducted Output Power

Please refer to Appendix A.



### 3.3 Power Spectral Density Measurement

#### 3.3.1 Limit of Power Spectral Density

<FCC 14-30 CFR 15.407>

For mobile and portable client devices in the 5.15–5.25 GHz band, the maximum power spectral density shall not exceed 11dBm in any 1 megahertz band.

For the 5.25–5.725 GHz bands, the maximum power spectral density shall not exceed 11 dBm in any 1 megahertz band.

For Straddle Channel, According to KDB 789033 D02 General UNII Test Procedures New Rules v02r01, If the power and PSD of the devices are uniform and comply with the lower limits specified for the U-NII-2 bands, a single measurement over the entire emission bandwidth can be performed to show compliance.

If transmitting antennas of directional gain greater than 6 dBi are used, the peak output power shall be reduced by the amount in dB that the directional gain of the antenna exceeds 6 dBi.

#### 3.3.2 Measuring Instruments

The measuring equipment is listed in the section 4 of this test report.

### 3.3.3 Test Procedures

The testing follows FCC KDB 789033 D02 General UNII Test Procedures New Rules v02r01.  
Section F) Maximum power spectral density.

#### # Method SA-2 #

(trace averaging across on and off times of the EUT transmissions, followed by duty cycle correction).

- Measure the duty cycle.
- Set span to encompass the entire emission bandwidth (EBW) of the signal.
- Set RBW = 1 MHz.
- Set VBW  $\geq$  3 MHz.
- Number of points in sweep  $\geq$  2 Span / RBW.
- Sweep time = auto.
- Detector = RMS
- Trace average at least 100 traces in power averaging mode.
- Add  $10 \log(1/x)$ , where  $x$  is the duty cycle, to the measured power in order to compute the average power during the actual transmission times. For example, add  $10 \log(1/0.25) = 6$  dB if the duty cycle is 25 percent.

### 3.3.4 Test Setup

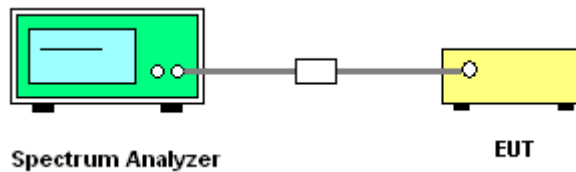

### 3.3.5 Test Result of Power Spectral Density

Please refer to Appendix A.



### 3.4 Unwanted Emissions Measurement

This section is to measure unwanted emissions through radiated measurement for band edge spurious emissions and out of band emissions measurement.

#### 3.4.1 Limit of Unwanted Emissions

- (1) For transmitters operating in the 5150-5250 MHz band: all emissions outside of the 5150-5350 MHz band shall not exceed an EIRP of -27dBm/MHz.

For transmitters operating in the 5250-5350 MHz band: all emissions outside of the 5150-5350 MHz band shall not exceed an EIRP of -27 dBm/MHz. Devices operating in the 5250-5350 MHz band that generate emissions in the 5150-5250 MHz band must meet all applicable technical requirements for operation in the 5150-5250 MHz band (including indoor use) or alternatively meet an out-of-band emission EIRP limit of -27 dBm/MHz in the 5150-5250 MHz band.

For transmitters operating in the 5470-5725 MHz band: all emissions outside of the 5470-5725 MHz band shall not exceed an EIRP of -27 dBm/MHz.

- (2) Unwanted spurious emissions fallen in restricted bands shall comply with the general field strength limits as below table,

Frequency (MHz)	Field Strength (microvolts/meter)	Measurement Distance (meters)
0.009 – 0.490	2400/F(kHz)	300
0.490 – 1.705	24000/F(kHz)	30
1.705 – 30.0	30	30
30 – 88	100	3
88 – 216	150	3
216 - 960	200	3
Above 960	500	3



EIRP (dBm)	Field Strength at 3m (dBµV/m)
- 27	68.2

**Note:** The following formula is used to convert the EIRP to field strength.

$$EIRP = E_{Meas} + 20\log (d_{Meas}) - 104.7$$

where

EIRP is the equivalent isotropically radiated power, in dBm

$E_{Meas}$  is the field strength of the emission at the measurement distance, in dBµV/m

$d_{Meas}$  is the measurement distance, in m

(3) ANSI C63.10-2013 clause 12.7.3 note 97

As specified by regulatory requirements, emissions above 1000 MHz that are outside of the restricted bands are subject to a peak emission limit. However, an out-of-band emission that complies with both the average and peak general regulatory limits is not required to satisfy the peak emission limit.

### 3.4.2 Measuring Instruments

The measuring equipment is listed in the section 4 of this test report.





### 3.4.3 Test Procedures

1. The testing follows FCC KDB 789033 D02 General UNII Test Procedures New Rules v02r01. Section G) Unwanted emissions measurement.
  - (1) Procedure for Unwanted Emissions Measurements Below 1000MHz
    - RBW = 120 kHz
    - VBW = 300 kHz
    - Detector = Peak
    - Trace mode = max hold
  - (2) Procedure for Peak Unwanted Emissions Measurements Above 1000 MHz
    - RBW = 1 MHz
    - VBW  $\geq$  3 MHz
    - Detector = Peak
    - Sweep time = auto
    - Trace mode = max hold
  - (3) Procedures for Average Unwanted Emissions Measurements Above 1000MHz
    - RBW = 1 MHz
    - VBW = 10 Hz, when duty cycle is no less than 98 percent.
    - VBW  $\geq$  1/T, when duty cycle is less than 98 percent where T is the minimum transmission duration over which the transmitter is on and is transmitting at its maximum power control level for the tested mode of operation.
2. The EUT was placed on a turntable with 0.8 meter for frequency below 1GHz and 1.5 meter for frequency above 1GHz respectively above ground.
3. The EUT was set 3 meters from the interference receiving antenna which was mounted on the top of a variable height antenna tower.
4. The antenna is a broadband antenna and its height is adjusted between one meter and four meters above ground to find the maximum value of the field strength for both horizontal polarization and vertical polarization of the antenna.
5. For each suspected emission, the EUT was arranged to its worst case and then adjust the antenna tower (from 1 m to 4 m) and turntable (from 0 degree to 360 degrees) to find the maximum reading.
6. For testing below 1GHz, if the emission level of the EUT in peak mode was 3 dB lower than the limit specified, then peak values of EUT will be reported, otherwise, the emissions will be repeated one by one using the CISPR quasi-peak method and reported.
7. For testing above 1GHz, the emission level of the EUT in peak mode was 20dB lower than peak limit (that means the emission level in average mode also complies with the limit in average mode), then peak values of EUT will be reported, otherwise, the emissions will be measured in average mode again and reported.

### 3.4.4 Test Setup

For radiated emissions below 30MHz

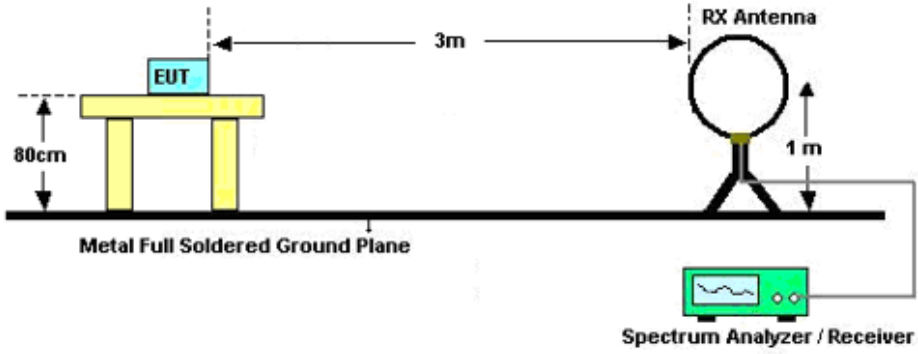

For radiated emissions from 30MHz to 1GHz

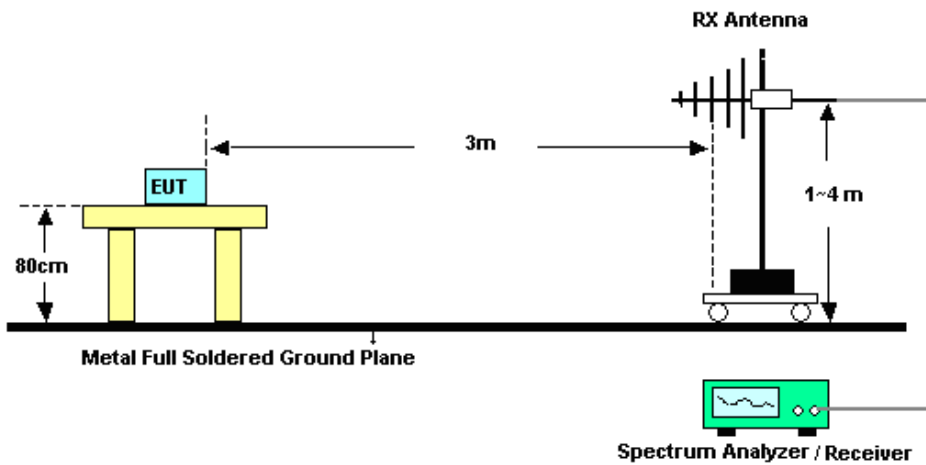

For radiated emissions above 1GHz

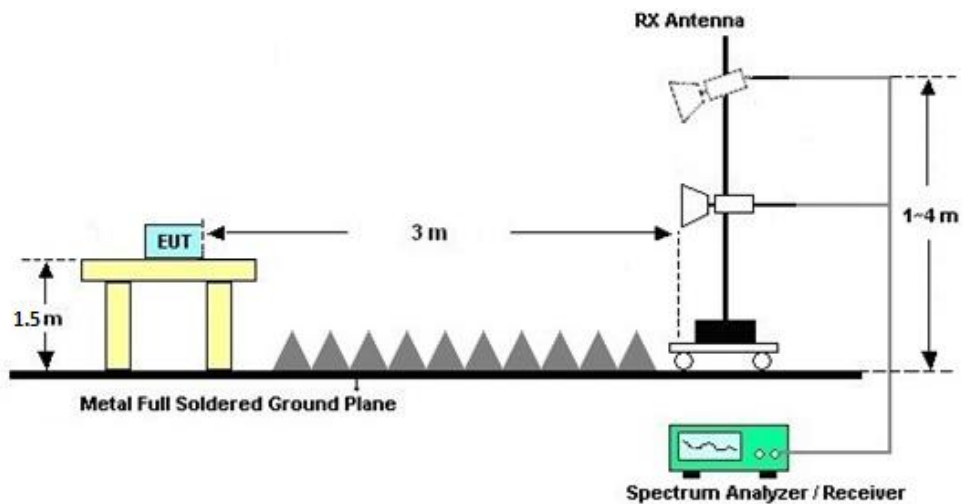



### **3.4.5 Test Results of Radiated Spurious Emissions (9 kHz ~ 30 MHz)**

The low frequency, which started from 9 kHz to 30MHz, was pre-scanned and the result which was 20dB lower than the limit line was not reported.

There is a comparison data of both open-field test site and semi-Anechoic chamber, and the result came out very similar.

### **3.4.6 Test Result of Radiated Spurious at Band Edges**

Please refer to Appendix C.

### **3.4.7 Duty Cycle**

Please refer to Appendix D.

### **3.4.8 Test Result of Radiated Spurious Emissions (30MHz ~ 10th Harmonic or 40GHz, whichever is lower)**

Please refer to Appendix C.



### 3.5 AC Conducted Emission Measurement

#### 3.5.1 Limit of AC Conducted Emission

For equipment that is designed to be connected to the public utility (AC) power line, the radio frequency voltage that is conducted back onto the AC power line on any frequency or frequencies within the band 150 kHz to 30 MHz shall not exceed the limits in the following table.

Frequency of emission (MHz)	Conducted limit (dBµV)	
	Quasi-peak	Average
0.15-0.5	66 to 56*	56 to 46*
0.5-5	56	46
5-30	60	50

\*Decreases with the logarithm of the frequency.

#### 3.5.2 Measuring Instruments

The measuring equipment is listed in the section 4 of this test report.

#### 3.5.3 Test Procedures

1. The EUT was placed 0.4 meter from the conducting wall of the shielding room was kept at least 80 centimeters from any other grounded conducting surface.
2. Connect EUT to the power mains through a line impedance stabilization network (LISN).
3. All the support units are connecting to the other LISN.
4. The LISN provides 50 ohm coupling impedance for the measuring instrument.
5. The FCC states that a 50 ohm, 50 microhenry LISN should be used.
6. Both sides of AC line were checked for maximum conducted interference.
7. The frequency range from 150 kHz to 30 MHz was searched.
8. Set the test-receiver system to Peak Detect Function and specified bandwidth with Maximum Hold Mode.

### 3.5.4 Test Setup



### 3.5.5 Test Result of AC Conducted Emission

Please refer to Appendix B.



## **3.6 Antenna Requirements**

### **3.6.1 Standard Applicable**

If transmitting antenna directional gain is greater than 6 dBi, both the peak transmit power and the peak power spectral density shall be reduced by the amount in dB that the directional gain of the antenna exceeds 6 dBi.

### **3.6.2 Antenna Anti-Replacement Construction**

An embedded-in antenna design is used.

### **3.6.3 Antenna Gain**

The antenna peak gain of EUT is less than 6 dBi. Therefore, it is not necessary to reduce maximum peak output power limit.



## 4 List of Measuring Equipment

Instrument	Manufacturer	Model No.	Serial No.	Characteristics	Calibration Date	Test Date	Due Date	Remark
Spectrum Analyzer	R&S	FSV40	101040	10Hz~40GHz	Oct. 14, 2021	Oct. 08, 2022	Oct. 13, 2022	Conducted (TH01-KS)
Pulse Power Sensor	Anritsu	MA2411B	0917070	300MHz~40GHz	Jan. 05, 2022	Oct. 08, 2022	Jan. 04, 2023	Conducted (TH01-KS)
Power Meter	Anritsu	ML2495A	1005002	50MHz Bandwidth	Jan. 05, 2022	Oct. 08, 2022	Jan. 04, 2023	Conducted (TH01-KS)
EMI Test Receiver	Keysight	N9038A	MY56400004	3Hz~8.5GHz;Max 30dBm	Oct. 13, 2022	Oct. 28, 2022	Oct. 12, 2023	Radiation (03CH06-KS)
EXA Spectrum Analyzer	Keysight	N9010B	MY60242126	10Hz~44GHz	Oct. 13, 2022	Oct. 28, 2022	Oct. 12, 2023	Radiation (03CH06-KS)
Loop Antenna	R&S	HFH2-Z2	100321	9kHz~30MHz	Oct. 16, 2022	Oct. 28, 2022	Oct. 15, 2023	Radiation (03CH06-KS)
Bilog Antenna	TeseQ	CBL6111D	49921	30MHz~1GHz	May 24, 2022	Oct. 28, 2022	May 23, 2023	Radiation (03CH06-KS)
Double Ridge Horn Antenna	ETS-Lindgren	3117	00218642	1GHz~18GHz	Apr. 18, 2022	Oct. 28, 2022	Apr. 17, 2023	Radiation (03CH06-KS)
SHF-EHF Horn	Com-power	AH-840	101093	18GHz~40GHz	Jan. 05, 2022	Oct. 28, 2022	Jan. 04, 2023	Radiation (03CH06-KS)
Amplifier	SONOMA	310N	380827	9KHz ~1GHZ	Jul. 11, 2022	Oct. 28, 2022	Jul. 10, 2023	Radiation (03CH06-KS)
Amplifier	MITEQ	EM18G40GGA	060728	18~40GHz	Jan. 05, 2022	Oct. 28, 2022	Jan. 04, 2023	Radiation (03CH06-KS)
high gain Amplifier	MITEQ	AMF-7D-00101800-30-10P	2082395	1Ghz-18Ghz	Jan. 05, 2022	Oct. 28, 2022	Jan. 04, 2023	Radiation (03CH06-KS)
Amplifier	Keysight	83017A	MY53270319	500MHz~26.5GHz	Oct. 12, 2022	Oct. 28, 2022	Oct. 12, 2023	Radiation (03CH06-KS)
AC Power Source	Chroma	61601	F104090004	N/A	NCR	Oct. 28, 2022	NCR	Radiation (03CH06-KS)
Turn Table	ChamPro	EM 1000-T	060762-T	0~360 degree	NCR	Oct. 28, 2022	NCR	Radiation (03CH06-KS)
Antenna Mast	ChamPro	EM 1000-A	060762-A	1 m~4 m	NCR	Oct. 28, 2022	NCR	Radiation (03CH06-KS)
EMI Receiver	R&S	ESC17	100768	9kHz~7GHz;	May. 24, 2022	Oct. 14, 2022	May. 23, 2023	Conduction (CO01-KS)
AC LISN (for auxiliary equipment)	MessTec	AN3016	060103	9kHz~30MHz	Oct. 13, 2022	Oct. 14, 2022	Oct. 12, 2023	Conduction (CO01-KS)
AC LISN	MessTec	AN3016	060105	9kHz~30MHz	May. 24, 2022	Oct. 14, 2022	May. 23, 2023	Conduction (CO01-KS)
AC Power Source	Chroma	61602	ABP00000811	AC 0V~300V, 45Hz~1000Hz	Oct. 12, 2022	Oct. 14, 2022	Oct. 11, 2023	Conduction (CO01-KS)

NCR: No Calibration Required



## 5 Uncertainty of Evaluation

The measurement uncertainties shown below were calculated in accordance with the requirements of ANSI 63.10-2013. All the measurement uncertainty value were shown with a coverage K=2 to indicate 95% level of confidence. The measurement data show herein meets or exceeds the CISPR measurement uncertainty values specified in CISPR 16-4-2 and can be compared directly to specified limit to determine compliance.

### Uncertainty of Conducted Measurement

Test Item	Uncertainty
Conducted Power	±0.46 dB
Conducted Emissions	±0.48 dB
Occupied Channel Bandwidth	±0.001 %
Conducted Power Spectral Density	±0.40 dB

### Uncertainty of Conducted Emission Measurement (150kHz ~ 30MHz)

Measuring Uncertainty for a Level of Confidence of 95% (U = 2Uc(y))	2.78 dB
---	---------

### Uncertainty of Radiated Emission Measurement (30 MHz ~ 1000 MHz)

Measuring Uncertainty for a Level of Confidence of 95% (U = 2Uc(y))	5.0dB
---	-------

### Uncertainty of Radiated Emission Measurement (1000 MHz ~ 18000 MHz)

Measuring Uncertainty for a Level of Confidence of 95% (U = 2Uc(y))	5.0dB
---	-------

### Uncertainty of Radiated Emission Measurement (18000 MHz ~ 40000 MHz)

Measuring Uncertainty for a Level of Confidence of 95% (U = 2Uc(y))	5.0dB
---	-------

----- THE END -----





## Appendix A. Conducted Test Results

## A1. Conducted Test Results

Test Engineer:	Jacob Zhang	Temperature:	21~25	°C
Test Date:	2022/10/8	Relative Humidity:	51~54	%

**TEST RESULTS DATA**  
**26dB and 99% OBW**

U-NII-1 single antenna							
Mod.	Data Rate	NTX	CH.	Freq. (MHz)	99% Bandwidth (MHz)	26 dB Bandwidth (MHz)	IC 99% Bandwidth EIRP Limit (dBm)
					Ant 1	Ant 1	Ant 1
11a	6Mbps	1	36	5180	16.83	20.23	22.26
11a	6Mbps	1	44	5220	17.03	21.83	22.31
11a	6Mbps	1	48	5240	17.13	24.48	22.34
HT20	MCS0	1	36	5180	17.93	21.43	22.54
HT20	MCS0	1	44	5220	18.03	13.88	22.56
HT20	MCS0	1	48	5240	18.23	25.03	22.61
HT40	MCS0	1	38	5190	36.76	41.36	23.01
HT40	MCS0	1	46	5230	36.86	41.00	23.01
VHT80	MCS0	1	42	5210	75.16	80.72	23.01

**TEST RESULTS DATA**  
**Average Power Table**

FCC U-NII-1 single antenna									
Mod.	Data Rate	NTX	CH.	Freq. (MHz)	Average Conducted Power with duty	FCC Conducted Power Limit (dBm)		DG (dBi)	Pass/Fail
					Ant 1	Ant 1	Ant 2		
11a	6Mbps	1	36	5180	19.06	24.00	-	-5.50	Pass
11a	6Mbps	1	44	5220	18.97	24.00	-	-5.50	Pass
11a	6Mbps	1	48	5240	19.09	24.00	-	-5.50	Pass
HT20	MCS0	1	36	5180	19.17	24.00	-	-5.50	Pass
HT20	MCS0	1	44	5220	18.96	24.00	-	-5.50	Pass
HT20	MCS0	1	48	5240	19.01	24.00	-	-5.50	Pass
HT40	MCS0	1	38	5190	17.15	24.00	-	-5.50	Pass
HT40	MCS0	1	46	5230	17.88	24.00	-	-5.50	Pass
VHT20	MCS0	1	36	5180	17.69	24.00	-	-5.50	Pass
VHT20	MCS0	1	44	5220	17.62	24.00	-	-5.50	Pass
VHT20	MCS0	1	48	5240	17.55	24.00	-	-5.50	Pass
VHT40	MCS0	1	38	5190	16.77	24.00	-	-5.50	Pass
VHT40	MCS0	1	46	5230	16.58	24.00	-	-5.50	Pass
VHT80	MCS0	1	42	5210	15.78	24.00	-	-5.50	Pass

**TEST RESULTS DATA**  
**Power Spectral Density**

FCC U-NII-1 single antenna									
Mod.	Data Rate	N <sub>TX</sub>	CH.	Freq. (MHz)	Average Power Density (dBm/MHz)	Average PSD Limit (dBm/MHz)		DG (dBi)	Pass /Fail
					Ant 1	Ant 1	Ant 2	Ant 1	
11a	6Mbps	1	36	5180	8.02	11.00	-	-5.50	Pass
11a	6Mbps	1	44	5220	8.40	11.00	-	-5.50	Pass
11a	6Mbps	1	48	5240	8.00	11.00	-	-5.50	Pass
HT20	MCS0	1	36	5180	7.75	11.00	-	-5.50	Pass
HT20	MCS0	1	44	5220	8.08	11.00	-	-5.50	Pass
HT20	MCS0	1	48	5240	7.88	11.00	-	-5.50	Pass
HT40	MCS0	1	38	5190	3.96	11.00	-	-5.50	Pass
HT40	MCS0	1	46	5230	4.00	11.00	-	-5.50	Pass
VHT80	MCS0	1	42	5210	-1.26	11.00	-	-5.50	Pass

**TEST RESULTS DATA**  
**26dB and 99% OBW**

U-NII-2A single antenna									
Mod.	Data Rate	NTX	CH.	Freq. (MHz)	99% Bandwidth (MHz)	26 dB Bandwidth (MHz)	IC 99% Bandwidth Power Limit (dBm)	IC 99% Bandwidth EIRP Limit (dBm)	FCC 26dB Bandwidth Power Limit (dBm)
					Ant 1	Ant 1	Ant 1	Ant 1	Ant 1
11a	6Mbps	1	52	5260	17.03	22.78	23.31	29.31	23.98
11a	6Mbps	1	60	5300	17.18	24.43	23.35	29.35	23.98
11a	6Mbps	1	64	5320	17.13	24.28	23.34	29.34	23.98
HT20	MCS0	1	52	5260	18.13	25.87	23.58	29.58	23.98
HT20	MCS0	1	60	5300	18.13	25.87	23.58	29.58	23.98
HT20	MCS0	1	64	5320	18.13	25.33	23.58	29.58	23.98
HT40	MCS0	1	54	5270	37.46	41.27	23.98	30.00	23.98
HT40	MCS0	1	62	5310	36.96	40.82	23.98	30.00	23.98
VHT80	MCS0	1	58	5290	75.16	81.20	23.98	30.00	23.98

**TEST RESULTS DATA**  
**Average Power Table**

FCC U-NII-2A single antenna										
Mod.	Data Rate	NTX	CH.	Freq. (MHz)	Average Conducted Power with duty factor	FCC Conducted Power Limit (dBm)		DG (dBi)	EIRP Power Limit (dBm)	Pass/Fail
					Ant 1	Ant 1	Ant 2	Ant 1		
11a	6Mbps	1	52	5260	19.06	23.98	-	-5.80	26.99	Pass
11a	6Mbps	1	60	5300	18.82	23.98	-	-5.80	26.99	Pass
11a	6Mbps	1	64	5320	18.89	23.98	-	-5.80	26.99	Pass
HT20	MCS0	1	52	5260	19.04	23.98	-	-5.80	26.99	Pass
HT20	MCS0	1	60	5300	18.80	23.98	-	-5.80	26.99	Pass
HT20	MCS0	1	64	5320	18.74	23.98	-	-5.80	26.99	Pass
HT40	MCS0	1	54	5270	17.84	23.98	-	-5.80	26.99	Pass
HT40	MCS0	1	62	5310	17.11	23.98	-	-5.80	26.99	Pass
VHT20	MCS0	1	52	5260	17.53	23.98	-	-5.80	26.99	Pass
VHT20	MCS0	1	60	5300	17.35	23.98	-	-5.80	26.99	Pass
VHT20	MCS0	1	64	5320	17.19	23.98	-	-5.80	26.99	Pass
VHT40	MCS0	1	54	5270	16.61	23.98	-	-5.80	26.99	Pass
VHT40	MCS0	1	62	5310	16.38	23.98	-	-5.80	26.99	Pass
VHT80	MCS0	1	58	5290	15.70	23.98	-	-5.80	26.99	Pass

**TEST RESULTS DATA**  
**Power Spectral Density**

U-NII-2A single antenna									
Mod.	Data Rate	NTX	CH.	Freq. (MHz)	Average Power Density (dBm/MHz)	Average PSD Limit (dBm/MHz)		DG (dBi)	Pass /Fail
					Ant 1	Ant 1	Ant 2		
11a	6Mbps	1	52	5260	8.16	11.00	-	-5.80	Pass
11a	6Mbps	1	60	5300	7.82	11.00	-	-5.80	Pass
11a	6Mbps	1	64	5320	7.97	11.00	-	-5.80	Pass
HT20	MCS0	1	52	5260	7.92	11.00	-	-5.80	Pass
HT20	MCS0	1	60	5300	7.59	11.00	-	-5.80	Pass
HT20	MCS0	1	64	5320	7.67	11.00	-	-5.80	Pass
HT40	MCS0	1	54	5270	4.04	11.00	-	-5.80	Pass
HT40	MCS0	1	62	5310	3.26	11.00	-	-5.80	Pass
VHT80	MCS0	1	58	5290	-2.15	11.00	-	-5.80	Pass



**TEST RESULTS DATA**  
**26dB and 99% OBW**

U-NII-2C single antenna									
Mod.	Data Rate	NTX	CH.	Freq. (MHz)	99% Bandwidth In U-NII 2C (MHz)	26 dB Bandwidth In U-NII 2C (MHz)	IC 99% Bandwidth Power Limit (dBm)	IC 99% Bandwidth EIRP Limit (dBm)	FCC 26dB Bandwidth Power Limit (dBm)
					Ant 1	Ant 1	Ant 1	Ant 1	Ant 1
11a	6Mbps	1	100	5500	17.08	23.53	23.32	29.32	23.98
11a	6Mbps	1	116	5580	17.03	21.98	23.31	29.31	23.98
11a	6Mbps	1	140	5700	16.93	21.78	23.29	29.29	23.98
HT20	MCS0	1	100	5500	18.03	24.63	23.56	29.56	23.98
HT20	MCS0	1	116	5580	18.08	23.98	23.57	29.57	23.98
HT20	MCS0	1	140	5700	18.03	23.43	23.56	29.56	23.98
HT40	MCS0	1	102	5510	37.16	43.07	23.98	30.00	23.98
HT40	MCS0	1	110	5550	37.46	44.15	23.98	30.00	23.98
HT40	MCS0	1	134	5670	37.16	41.90	23.98	30.00	23.98
VHT80	MCS0	1	106	5530	75.28	81.20	23.98	30.00	23.98
VHT80	MCS0	1	122	5610	75.28	81.36	23.98	30.00	23.98

U-NII-2C straddle channel single antenna									
Mod.	Data Rate	NTX	CH.	Freq. (MHz)	99% Bandwidth In U-NII 2C (MHz)	26 dB Bandwidth In U-NII 2C (MHz)	IC 99% Bandwidth Power Limit (dBm)	IC 99% Bandwidth EIRP Limit (dBm)	FCC 26dB Bandwidth Power Limit (dBm)
					Ant 1	Ant 1	Ant 1	Ant 1	Ant 1
11a	6Mbps	1	144	5720	17.03	22.08	23.31	29.31	23.98
HT20	MCS0	1	144	5720	18.13	23.28	23.58	29.58	23.98
HT40	MCS0	1	142	5710	36.96	41.72	23.98	30.00	23.98
VHT80	MCS0	1	138	5690	75.16	81.20	23.98	30.00	23.98

**TEST RESULTS DATA**  
**Average Power Table**

FCC U-NII-2C single antenna										
Mod.	Data Rate	NTX	CH.	Freq. (MHz)	Average Conducted Power with duty factor	FCC Conducted Power Limit (dBm)		DG (dBi)	EIRP Power Limit (dBm)	Pass/Fail
						Ant 1	Ant 2	Ant 1		
11a	6Mbps	1	100	5500	18.43	23.98	-	-5.20	26.98	Pass
11a	6Mbps	1	116	5580	18.99	23.98	-	-5.20	26.98	Pass
11a	6Mbps	1	140	5700	18.76	23.98	-	-5.20	26.98	Pass
HT20	MCS0	1	100	5500	16.56	23.98	-	-5.20	26.98	Pass
HT20	MCS0	1	116	5580	18.94	23.98	-	-5.20	26.98	Pass
HT20	MCS0	1	140	5700	18.26	23.98	-	-5.20	26.98	Pass
HT40	MCS0	1	102	5510	14.91	23.98	-	-5.20	26.98	Pass
HT40	MCS0	1	110	5550	17.91	23.98	-	-5.20	26.98	Pass
HT40	MCS0	1	134	5670	17.53	23.98	-	-5.20	26.98	Pass
VHT20	MCS0	1	100	5500	16.46	23.98	-	-5.20	26.98	Pass
VHT20	MCS0	1	116	5580	17.53	23.98	-	-5.20	26.98	Pass
VHT20	MCS0	1	140	5700	17.34	23.98	-	-5.20	26.98	Pass
VHT40	MCS0	1	102	5510	14.78	23.98	-	-5.20	26.98	Pass
VHT40	MCS0	1	110	5550	16.65	23.98	-	-5.20	26.98	Pass
VHT40	MCS0	1	134	5670	16.74	23.98	-	-5.20	26.98	Pass
VHT80	MCS0	1	106	5530	15.85	23.98	-	-5.20	26.98	Pass
VHT80	MCS0	1	122	5610	15.90	23.98	-	-5.20	26.98	Pass

FCC U-NII-2C straddle channel single antenna										
Mod.	Data Rate	NTX	CH.	Freq. (MHz)	Average Conducted Power with duty factor	FCC Conducted Power Limit (dBm)		DG (dBi)	EIRP Power Limit (dBm)	Pass/Fail
						Ant 1	Ant 2	Ant 1		
11a	6Mbps	1	144	5720	18.68	23.98	-	-5.20	26.98	Pass
HT20	MCS0	1	144	5720	18.62	23.98	-	-5.20	26.98	Pass
HT40	MCS0	1	142	5710	17.65	23.98	-	-5.20	26.98	Pass
VHT20	MCS0	1	144	5720	17.49	23.98	-	-5.20	26.98	Pass
VHT40	MCS0	1	142	5710	16.47	23.98	-	-5.20	26.98	Pass
VHT80	MCS0	1	138	5690	15.57	23.98	-	-5.20	26.98	Pass

**TEST RESULTS DATA**  
**Power Spectral Density**

U-NII-2C single antenna									
Mod.	Data Rate	NTX	CH.	Freq. (MHz)	Average Power Density (dBm/MHz)	Average PSD Limit (dBm/MHz)		DG (dBi)	Pass /Fail
					Ant 1	Ant 1	Ant 2		
11a	6Mbps	1	100	5500	7.86	11.00	-	-5.20	Pass
11a	6Mbps	1	116	5580	7.68	11.00	-	-5.20	Pass
11a	6Mbps	1	140	5700	7.80	11.00	-	-5.20	Pass
HT20	MCS0	1	100	5500	5.25	11.00	-	-5.20	Pass
HT20	MCS0	1	116	5580	7.45	11.00	-	-5.20	Pass
HT20	MCS0	1	140	5700	7.19	11.00	-	-5.20	Pass
HT40	MCS0	1	102	5510	2.72	11.00	-	-5.20	Pass
HT40	MCS0	1	110	5550	4.21	11.00	-	-5.20	Pass
HT40	MCS0	1	134	5670	3.97	11.00	-	-5.20	Pass
VHT80	MCS0	1	106	5530	-1.61	11.00	-	-5.20	Pass
VHT80	MCS0	1	122	5610	-1.80	11.00	-	-5.20	Pass

U-NII-2C straddle channel single antenna									
Mod.	Data Rate	NTX	CH.	Freq. (MHz)	Average Power Density (dBm/MHz)	Average PSD Limit (dBm/MHz)		DG (dBi)	Pass /Fail
					Ant 1	Ant 1	Ant 2		
11a	6Mbps	1	144	5720	7.45	11.00	-	-5.20	Pass
HT20	MCS0	1	144	5720	7.32	11.00	-	-5.20	Pass
HT40	MCS0	1	142	5710	3.58	11.00	-	-5.20	Pass
VHT80	MCS0	1	138	5690	-2.02	11.00	-	-5.20	Pass



## Appendix B. AC Conducted Emission Test Results

Test Engineer :	Amos	Temperature :	25.3~26.2°C
		Relative Humidity :	38~40%
Test Voltage :	120Vac / 60Hz	Phase :	Line
Remark :	All emissions not reported here are more than 10 dB below the prescribed limit.		

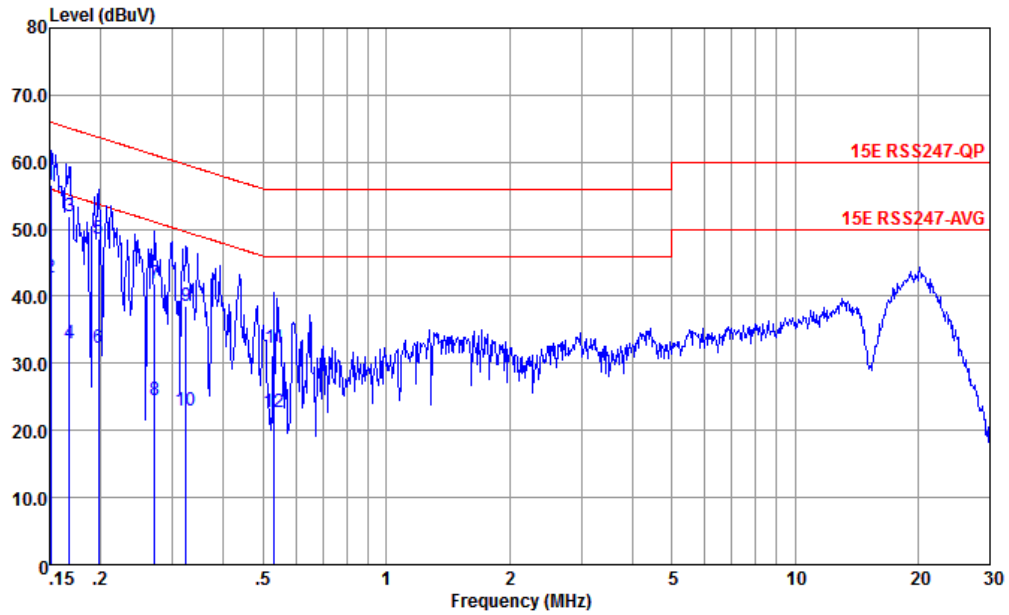

Site : CO01-KS  
 Condition : 15E RSS247-QP LISN-060105-LINE LINE

	Freq	Level	Over	Limit	Read	LISN	Cable	
	MHz	dBuV	Limit	Line	Level	Factor	Loss	Remark
			dB	dBuV	dBuV	dB	dB	
1 *	0.151	56.70	-9.26	65.96	46.20	0.07	10.43	QP
2	0.151	42.70	-23.26	65.96	32.20	0.07	10.43	Average
3	0.168	51.98	-13.10	65.08	41.50	0.05	10.43	QP
4	0.168	33.08	-32.00	65.08	22.60	0.05	10.43	Average
5	0.198	48.64	-15.07	63.71	38.20	0.02	10.42	QP
6	0.198	32.34	-31.37	63.71	21.90	0.02	10.42	Average
7	0.272	41.92	-19.15	61.07	31.50	0.05	10.37	QP
8	0.272	24.62	-36.45	61.07	14.20	0.05	10.37	Average
9	0.323	38.58	-21.04	59.62	28.19	0.05	10.34	QP
10	0.323	22.98	-36.64	59.62	12.59	0.05	10.34	Average
11	0.532	32.36	-23.64	56.00	22.20	-0.04	10.20	QP
12	0.532	22.66	-33.34	56.00	12.50	-0.04	10.20	Average



Test Engineer :	Amos	Temperature :	25.3~26.2°C
		Relative Humidity :	38~40%
Test Voltage :	120Vac / 60Hz	Phase :	Neutral
Remark :	All emissions not reported here are more than 10 dB below the prescribed limit.		

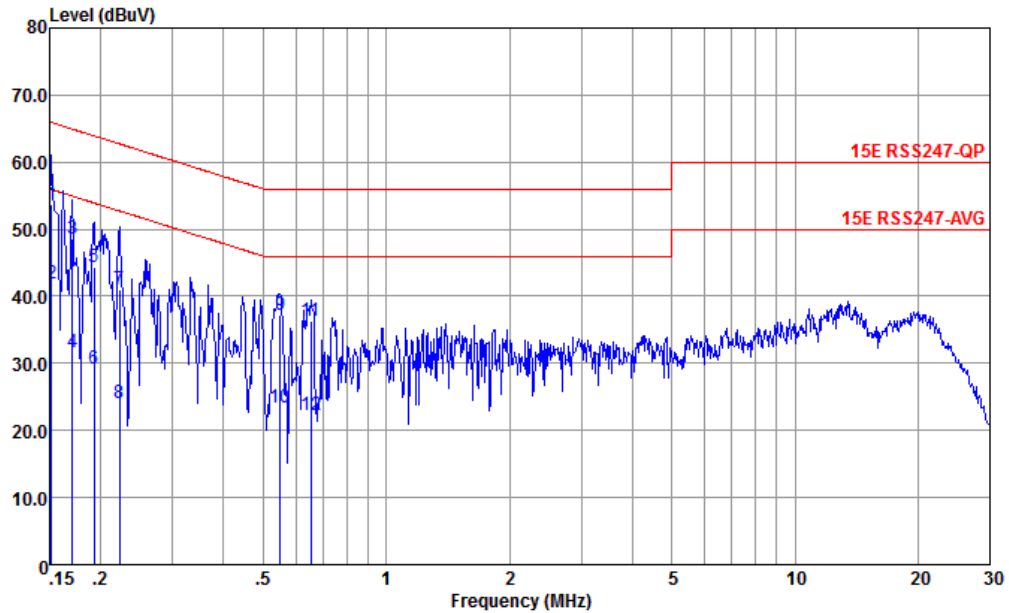

Site : CO01-KS  
 Condition : 15E RSS247-QP LISN-060105-NEUTRAL NEUTRAL

	Freq	Level	Over	Limit	Read	LISN	Cable	Remark
	MHz	dBuV	Limit	Line	Level	Factor	Loss	
			dB	dBuV	dBuV	dB	dB	
1 *	0.152	53.76	-12.15	65.91	43.30	0.03	10.43	QP
2	0.152	41.96	-23.95	65.91	31.50	0.03	10.43	Average
3	0.170	48.66	-16.28	64.94	38.19	0.04	10.43	QP
4	0.170	31.56	-33.38	64.94	21.09	0.04	10.43	Average
5	0.192	44.27	-19.66	63.93	33.80	0.05	10.42	QP
6	0.192	29.27	-34.66	63.93	18.80	0.05	10.42	Average
7	0.222	40.93	-21.81	62.74	30.51	0.02	10.40	QP
8	0.222	24.03	-38.71	62.74	13.61	0.02	10.40	Average
9	0.549	37.31	-18.69	56.00	27.19	-0.08	10.20	QP
10	0.549	23.41	-32.59	56.00	13.29	-0.08	10.20	Average
11	0.654	36.28	-19.72	56.00	26.20	-0.09	10.17	QP
12	0.654	22.28	-33.72	56.00	12.20	-0.09	10.17	Average

Note:

- Level(dBμV) = Read Level(dBμV) + LISN Factor(dB) + Cable Loss(dB)
- Over Limit(dB) = Level(dBμV) – Limit Line(dBμV)



## Appendix C. Radiated Spurious Emission

Only worst mode are shown in the report.

### UNII-2A- 5250~5350MHz WIFI 802.11a (Band Edge @ 3m)

WIFI Ant. 1	Note	Frequency ( MHz )	Level ( dBμV/m )	Over Limit ( dB )	Limit Line ( dBμV/m )	Read Level ( dBμV )	Antenna Factor ( dB/m )	Path Loss ( dB )	Preamp Factor ( dB )	Ant Pos ( cm )	Table Pos ( deg )	Peak Avg. ( P/A )	Pol. ( H/V )
802.11a CH 64 5320MHz		5352	61.53	-12.47	74	48.9	34.65	9.91	31.93	100	30	P	H
		5350	48.79	-5.21	54	36.16	34.65	9.91	31.93	100	30	A	H
	*	5320	106.27	-	-	93.73	34.55	9.89	31.9	100	30	P	H
	*	5320	99.97	-	-	87.43	34.55	9.89	31.9	100	30	A	H
		5353.8	65.93	-8.07	74	53.3	34.65	9.91	31.93	288	29	P	V
		5350.3	50.65	-3.35	54	38.02	34.65	9.91	31.93	288	29	A	V
	*	5320	108.24	-	-	95.7	34.55	9.89	31.9	288	29	P	V
	*	5320	101.87	-	-	89.33	34.55	9.89	31.9	288	29	A	V
Remark	1. No other spurious found. 2. All results are PASS against Peak and Average limit line.												

### UNII-2A5250~5350MHz WIFI 802.11a (Harmonic @ 3m)

WIFI Ant. 1	Note	Frequency ( MHz )	Level ( dBμV/m )	Over Limit ( dB )	Limit Line ( dBμV/m )	Read Level ( dBμV )	Antenna Factor ( dB/m )	Path Loss ( dB )	Preamp Factor ( dB )	Ant Pos ( cm )	Table Pos ( deg )	Peak Avg. ( P/A )	Pol. ( H/V )
802.11a CH 64 5320MHz		10641	45.41	-28.59	74	54.96	37.78	14.32	61.65	300	0	P	H
		10641	44.54	-29.46	74	54.09	37.78	14.32	61.65	100	0	P	V
Remark	1. No other spurious found. 2. All results are PASS against Peak and Average limit line.												



**UNII-2A5250~5350MHz  
WIFI 802.11n HT40 (Band Edge @ 3m)**

WIFI Ant.	Note	Frequency ( MHz )	Level ( dBμV/m )	Over Limit ( dB )	Limit Line ( dBμV/m )	Read Level (dBμV)	Antenna Factor ( dB/m )	Path Loss ( dB )	Preamp Factor ( dB )	Ant Pos ( cm )	Table Pos ( deg )	Peak Avg. (P/A)	Pol. (H/V)
802.11n HT40 CH 62 5310MHz		5127.04	53.13	-20.87	74	41.05	34.1	9.77	31.79	274	333	P	H
		5102.24	43.83	-10.17	54	31.77	34.1	9.74	31.78	274	333	A	H
	*	5308	100.89	-	-	88.4	34.5	9.89	31.9	274	333	P	H
	*	5308	94.41	-	-	81.92	34.5	9.89	31.9	274	333	A	H
		5351.5	64.27	-9.73	74	51.64	34.65	9.91	31.93	274	333	P	H
		5350.4	50.55	-3.45	54	37.92	34.65	9.91	31.93	274	333	A	H
		5141.6	54.15	-19.85	74	42.06	34.1	9.78	31.79	115	343	P	V
		5144.48	44.48	-9.52	54	32.41	34.1	9.78	31.81	115	343	A	V
	*	5314	102.88	-	-	90.34	34.55	9.89	31.9	115	343	P	V
	*	5314	96.46	-	-	83.92	34.55	9.89	31.9	115	343	A	V
		5351.9	65.49	-8.51	74	52.86	34.65	9.91	31.93	115	343	P	V
	5350.9	49.93	-4.07	54	37.3	34.65	9.91	31.93	115	343	A	V	
Remark	1. No other spurious found. 2. All results are PASS against Peak and Average limit line.												

**UNII-2A5250~5350MHz  
WIFI 802.11n HT40 (Harmonic @ 3m)**

WIFI Ant.	Note	Frequency ( MHz )	Level ( dBμV/m )	Over Limit ( dB )	Limit Line ( dBμV/m )	Read Level (dBμV)	Antenna Factor ( dB/m )	Path Loss ( dB )	Preamp Factor ( dB )	Ant Pos ( cm )	Table Pos ( deg )	Peak Avg. (P/A)	Pol. (H/V)
802.11n HT40 CH 62 5310MHz		10619	44.54	-29.46	74	54.1	37.77	14.31	61.64	300	0	P	H
		10619	43.83	-30.17	74	53.39	37.77	14.31	61.64	100	0	P	V
Remark	1. No other spurious found. 2. All results are PASS against Peak and Average limit line.												



UNII-2C - 5470~5725MHz

WIFI 802.11n HT20 (Band Edge @ 3m)

WIFI Ant. 1	Note	Frequency ( MHz )	Level ( dBμV/m )	Over Limit ( dB )	Limit Line ( dBμV/m )	Read Level (dBμV)	Antenna Factor ( dB/m )	Path Loss ( dB )	Preamp Factor ( dB )	Ant Pos ( cm )	Table Pos ( deg )	Peak Avg. (P/A)	Pol. (H/V)
802.11n HT20 CH 140 5700MHz	*	5698	103.31	-	-	90.55	34.5	10.32	32.06	297	324	P	H
	*	5698	96.58	-	-	83.82	34.5	10.32	32.06	297	324	A	H
		5729.8	59.44	-8.86	68.3	46.6	34.53	10.35	32.04	297	324	P	H
	*	5698	107.25	-	-	94.49	34.5	10.32	32.06	121	344	P	V
	*	5698	100.25	-	-	87.49	34.5	10.32	32.06	121	344	A	V
		5728.28	64.45	-3.85	68.3	51.61	34.53	10.35	32.04	121	344	P	V
Remark	1. No other spurious found. 2. All results are PASS against Peak and Average limit line.												

UNII-2C - 5470~5725MHz

WIFI 802.11n HT20 (Harmonic @ 3m)

WIFI Ant. 1	Note	Frequency ( MHz )	Level ( dBμV/m )	Over Limit ( dB )	Limit Line ( dBμV/m )	Read Level (dBμV)	Antenna Factor ( dB/m )	Path Loss ( dB )	Preamp Factor ( dB )	Ant Pos ( cm )	Table Pos ( deg )	Peak Avg. (P/A)	Pol. (H/V)
802.11n HT20 CH 140 5700MHz		11400	45.13	-28.87	74	53.59	38.24	14.85	61.55	300	0	P	H
		11400	44.81	-29.19	74	53.27	38.24	14.85	61.55	100	0	P	V
Remark	1. No other spurious found. 2. All results are PASS against Peak and Average limit line.												





**UNII-2C - 5470~5725MHz  
WIFI 802.11ac VHT80 (Band Edge @ 3m)**

WIFI Ant.	Note	Frequency ( MHz )	Level ( dBμV/m )	Over Limit ( dB )	Limit Line ( dBμV/m )	Read Level ( dBμV )	Antenna Factor ( dB/m )	Path Loss ( dB )	Preamp Factor ( dB )	Ant Pos ( cm )	Table Pos ( deg )	Peak Avg. ( P/A )	Pol. ( H/V )
802.11ac VHT80 CH 106 5530MHz		5453.36	57.55	-16.45	74	44.72	34.8	10.02	31.99	255	329	P	H
		5469.68	57.84	-10.46	68.3	44.99	34.8	10.04	31.99	255	329	P	H
		5458.8	46.72	-7.28	54	33.89	34.8	10.02	31.99	255	329	A	H
	*	5524	92.79	-	-	79.92	34.77	10.12	32.02	255	329	P	H
	*	5524	85.94	-	-	73.07	34.77	10.12	32.02	255	329	A	H
		5747.32	53.51	-14.79	68.3	40.61	34.55	10.36	32.01	255	329	P	H
		5455.92	55.89	-18.11	74	43.06	34.8	10.02	31.99	188	338	P	V
		5469.68	57.77	-10.53	68.3	44.92	34.8	10.04	31.99	188	338	P	V
		5457.04	46.84	-7.16	54	34.01	34.8	10.02	31.99	188	338	A	V
	*	5524	93.61	-	-	80.74	34.77	10.12	32.02	188	338	P	V
	*	5524	86.77	-	-	73.9	34.77	10.12	32.02	188	338	A	V
		5748.92	53.59	-14.71	68.3	40.69	34.55	10.36	32.01	188	338	P	V
Remark	1. No other spurious found. 2. All results are PASS against Peak and Average limit line.												

**UNII-2C 5470~5725MHz  
WIFI 802.11ac VHT80 (Harmonic @ 3m)**

WIFI Ant.	Note	Frequency ( MHz )	Level ( dBμV/m )	Over Limit ( dB )	Limit Line ( dBμV/m )	Read Level ( dBμV )	Antenna Factor ( dB/m )	Path Loss ( dB )	Preamp Factor ( dB )	Ant Pos ( cm )	Table Pos ( deg )	Peak Avg. ( P/A )	Pol. ( H/V )
802.11ac VHT80 CH 106 5530MHz		11059	44.42	-29.58	74	53.46	38.04	14.61	61.69	300	0	P	H
		11059	44.33	-29.67	74	53.37	38.04	14.61	61.69	100	0	P	V
Remark	1. No other spurious found. 2. All results are PASS against Peak and Average limit line.												



Emission below 1GHz  
WIFI 802.11a (LF @ 3m)

WIFI	Note	Frequency	Level	Over	Limit	Read	Antenna	Path	Preamp	Ant	Table	Peak	Pol.
Ant.				Limit	Line	Level	Factor	Loss	Factor	Pos	Pos	Avg.	
1		( MHz )	( dBμV/m )	( dB )	( dBμV/m )	(dBμV)	( dB/m )	( dB )	( dB )	( cm )	( deg )	(P/A)	(H/V)
802.11a LF		40.67	22.64	-17.36	40	35	19.01	0.73	32.1	-	-	P	H
		95.96	26.99	-16.51	43.5	42.19	15.43	1.57	32.2	-	-	P	H
		173.56	36.92	-6.58	43.5	51.62	15.28	2.12	32.1	-	-	P	H
		281.23	33.85	-12.15	46	44.63	18.65	2.71	32.14	-	-	P	H
		545.07	25.59	-20.41	46	29.03	25.08	3.79	32.31	-	-	P	H
		768.17	30.1	-15.9	46	29.76	28.13	4.51	32.3	-	-	P	H
		41.64	37.69	-2.31	40	50.6	18.46	0.75	32.12	-	-	P	V
		94.02	29.08	-14.42	43.5	44.58	15.18	1.54	32.22	-	-	P	V
		171.62	37.64	-5.86	43.5	52.21	15.42	2.11	32.1	-	-	P	V
		228.85	30.17	-15.83	46	43.91	15.98	2.44	32.16	-	-	P	V
		282.2	29.56	-16.44	46	40.31	18.67	2.72	32.14	-	-	P	V
	632.37	26.94	-19.06	46	28.94	26.14	4.1	32.24	-	-	P	V	
Remark	1. No other spurious found. 2. All results are PASS against limit line.												



<Co-location>

WIFI 802.11a CH64 + LTE Band 48 Link

(Band Edge @ 3m)

WIFI Ant. 1	Note	Frequency ( MHz )	Level ( dBμV/m )	Over Limit ( dB )	Limit Line ( dBμV/m )	Read Level ( dBμV )	Antenna Factor ( dB/m )	Path Loss ( dB )	Preamp Factor ( dB )	Ant Pos ( cm )	Table Pos ( deg )	Peak Avg. ( P/A )	Pol. ( H/V )
802.11a CH 64 5320MHz		5351.4	59.64	-14.36	74	47.01	34.65	9.91	31.93	374	342	P	H
		5350.2	48	-6	54	35.37	34.65	9.91	31.93	374	342	A	H
	*	5320	107.41	39.11	68.3	94.87	34.55	9.89	31.9	374	342	P	H
		5320	100.97	-	-	88.43	34.55	9.89	31.9	374	342	A	H
		5350	59.64	-14.36	74	47.01	34.65	9.91	31.93	343	21	P	V
		5350	49.27	-4.73	54	36.64	34.65	9.91	31.93	343	21	A	V
	*	5320	109.38	41.08	68.3	96.84	34.55	9.89	31.9	343	21	P	V
		5320	103.06	-	-	90.52	34.55	9.89	31.9	343	21	A	V
Remark	1. No other spurious found. 2. All results are PASS against Peak and Average limit line.												

(Harmonic @ 3m)

WIFI Ant. 1	Note	Frequency ( MHz )	Level ( dBμV/m )	Over Limit ( dB )	Limit Line ( dBμV/m )	Read Level ( dBμV )	Antenna Factor ( dB/m )	Path Loss ( dB )	Preamp Factor ( dB )	Ant Pos ( cm )	Table Pos ( deg )	Peak Avg. ( P/A )	Pol. ( H/V )
802.11a CH 64 5320MHz		10641	44.73	-29.27	74	54.28	37.78	14.32	61.65	300	0	P	H
		10641	44.51	-29.49	74	54.06	37.78	14.32	61.65	100	0	P	V
Remark	1. No other spurious found. 2. All results are PASS against Peak and Average limit line.												



**Note symbol**

*	<b>Fundamental Frequency</b> which can be ignored. However, the level of any unwanted emissions shall not exceed the level of the fundamental frequency.
!	Test result is <b>over limit</b> line.
P/A	<b>Peak</b> or <b>Average</b>
H/V	<b>Horizontal</b> or <b>Vertical</b>



A calculation example for radiated spurious emission is shown as below:

WIFI	Note	Frequency	Level	Over	Limit	Read	Antenna	Path	Preamp	Ant	Table	Peak	Pol.
Ant.				Limit	Line	Level	Factor	Loss	Factor	Pos	Pos	Avg.	
1		( MHz )	( dBμV/m )	( dB )	( dBμV/m )	( dBμV )	( dB/m )	( dB )	( dB )	( cm )	( deg )	( P/A )	( H/V )
802.11b		2390	55.45	-18.55	74	54.51	32.22	4.58	35.86	103	308	P	H
CH 01													
2412MHz		2390	43.54	-10.46	54	42.6	32.22	4.58	35.86	103	308	A	H

1. Path Loss(dB) = Cable loss(dB) + Filter loss(dB) + Attenuator loss(dB)
2. Level(dBμV/m) = Antenna Factor(dB/m) + Path Loss(dB) + Read Level(dBμV) - Preamp Factor(dB)
3. Over Limit(dB) = Level(dBμV/m) – Limit Line(dBμV/m)

**For Peak Limit @ 2390MHz:**

1. Level(dBμV/m)  
= Antenna Factor(dB/m) + Path Loss(dB) + Read Level(dBμV) - Preamp Factor(dB)  
= 32.22(dB/m) + 4.58(dB) + 54.51(dBμV) – 35.86 (dB)  
= 55.45 (dBμV/m)
2. Over Limit(dB)  
= Level(dBμV/m) – Limit Line(dBμV/m)  
= 55.45(dBμV/m) – 74(dBμV/m)  
= -18.55(dB)

**For Average Limit @ 2390MHz:**

1. Level(dBμV/m)  
= Antenna Factor(dB/m) + Path Loss(dB) + Read Level(dBμV) - Preamp Factor(dB)  
= 32.22(dB/m) + 4.58(dB) + 42.6(dBμV) – 35.86 (dB)  
= 43.54 (dBμV/m)
2. Over Limit(dB) = Level(dBμV/m) – Limit Line(dBμV/m)  
= 43.54(dBμV/m) – 54(dBμV/m)  
= -10.46(dB)

**Both peak and average measured complies with the limit line, so test result is “PASS”.**



## Appendix D. Duty Cycle Plots

Band	Duty Cycle(%)	T(ms)	1/T(kHz)	VBW Setting
802.11a	97.46	1.391	0.719	0.75KHz
802.11n HT20	97.28	1.297	0.771	0.82KHz
802.11n HT40	94.90	0.648	1.544	1.6KHz
802.11ac VHT80	90.69	0.325	3.080	3.3KHz

### 802.11a

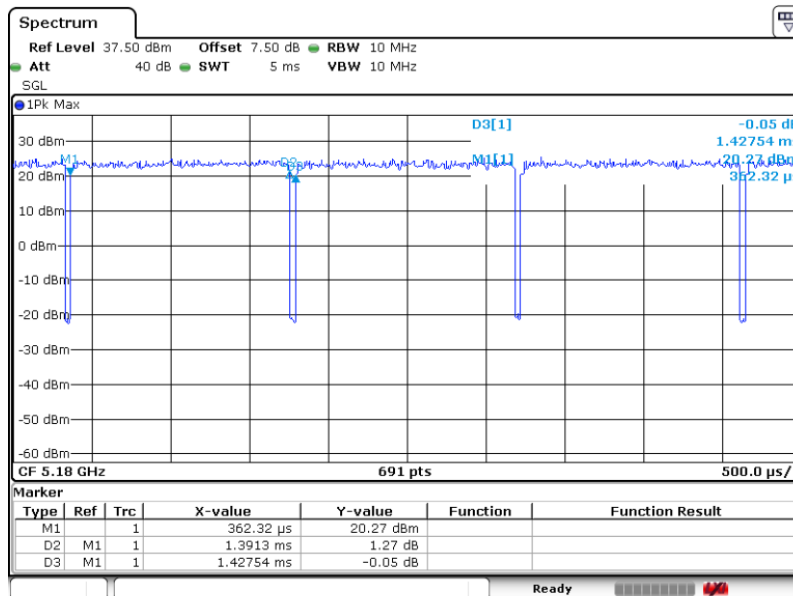



802.11n HT20

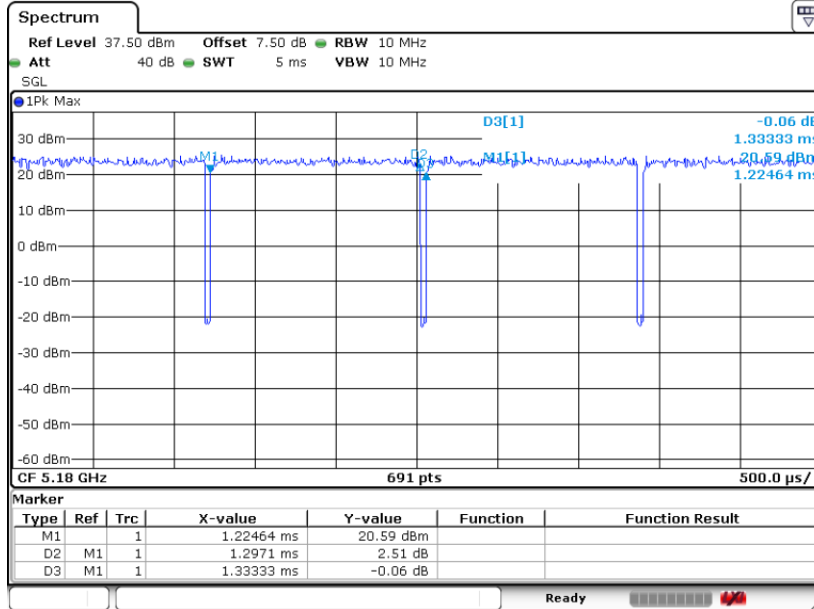

802.11n HT40

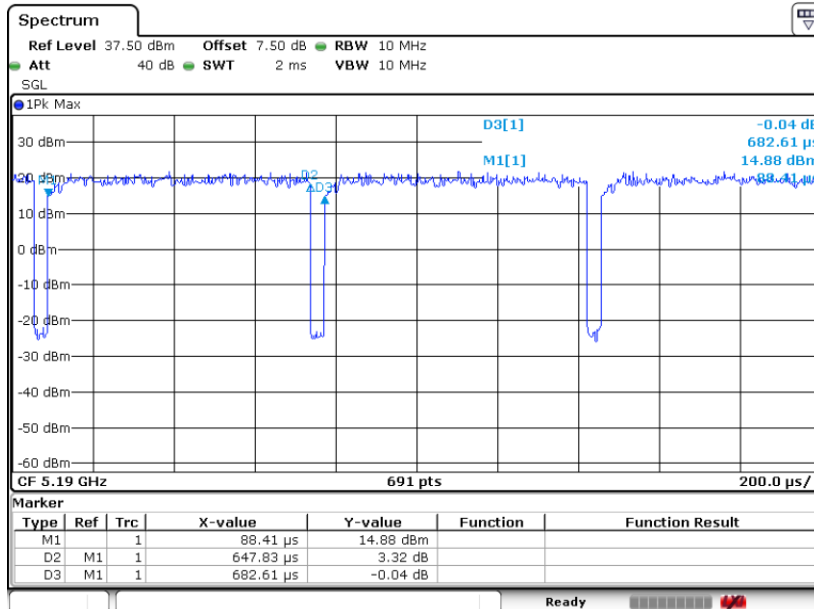



802.11ac VHT80

