



FCC RF Test Report

APPLICANT : Motorola Mobility LLC
EQUIPMENT : Mobile Cellular Phone
BRAND NAME : Motorola
MODEL NAME : XT2301-1
FCC ID : IHDT56AH1
STANDARD : 47 CFR Part 2, 27
CLASSIFICATION : PCS Licensed Transmitter Held to Ear (PCE)
TEST DATE(S) : Oct. 29, 2022 ~ Nov. 24, 2022

We, Sporton International Inc. (ShenZhen), would like to declare that the tested sample has been evaluated in accordance with the procedures given in ANSI C63.26-2015 and shown compliance with the applicable technical standards.

The test results in this report apply exclusively to the tested model / sample. Without written approval of Sporton International Inc. (ShenZhen), the test report shall not be reproduced except in full.

Jason Jia



Approved by: Jason Jia

Sporton International Inc. (ShenZhen)

1/F, 2/F, Bldg 5, Shiling Industrial Zone, Xinwei Village, Xili, Nanshan, Shenzhen, 518055

People's Republic of China



TABLE OF CONTENTS

REVISION HISTORY...3
SUMMARY OF TEST RESULT...4
1 GENERAL DESCRIPTION...5
1.1 Applicant...5
1.2 Manufacturer...5
1.3 Product Feature of Equipment Under Test...5
1.4 Product Specification of Equipment Under Test...5
1.5 Modification of EUT...6
1.6 Specification of Accessory...7
1.7 Maximum ERP/EIRP Power and Emission Designator...7
1.8 Testing Location...9
1.9 Test Software...10
1.10 Applicable Standards...10
2 TEST CONFIGURATION OF EQUIPMENT UNDER TEST...11
2.1 Test Mode...11
2.2 Connection Diagram of Test System...13
2.3 Support Unit used in test configuration and system...13
2.4 Measurement Results Explanation Example...13
2.5 Frequency List of Low/Middle/High Channels...14
3 CONDUCTED TEST ITEMS...17
3.1 Measuring Instruments...17
3.2 Test Setup...17
3.3 Test Result of Conducted Test...17
3.4 Conducted Output Power and ERP/EIRP...18
3.5 Peak-to-Average Ratio...19
3.6 Occupied Bandwidth...20
3.7 Conducted Band Edge...21
3.8 Conducted Spurious Emission...23
3.9 Frequency Stability...24
4 RADIATED TEST ITEMS...25
4.1 Measuring Instruments...25
4.2 Test Setup...25
4.3 Test Result of Radiated Test...26
4.4 Radiated Spurious Emission...27
5 LIST OF MEASURING EQUIPMENT...28
6 UNCERTAINTY OF EVALUATION...29
APPENDIX A. TEST RESULTS OF CONDUCTED TEST
APPENDIX B. TEST RESULTS OF RADIATED TEST
APPENDIX C. TEST SETUP PHOTOGRAPHS



REVISION HISTORY

REPORT NO.	VERSION	DESCRIPTION	ISSUED DATE
FG292622k	Rev. 01	Initial issue of report	Dec. 12, 2022



SUMMARY OF TEST RESULT

Report Section	FCC Rule	Description	Limit	Result	Remark
3.4	§2.1046	Conducted Output Power	Reporting Only	PASS	-
	§27.50(c)(10)	Effective Radiated Power (5G NR n71)	ERP < 3 Watt		
	§27.50(h)(2)	Equivalent Isotropic Radiated Power (5G NR n7, n38, n41)	EIRP < 2Watt		
	§27.50(d)(4)	Equivalent Isotropic Radiated Power (5G NR n70)	EIRP < 1Watt		
3.5	N/A	Peak-to-Average Ratio	<13 dB	PASS	-
3.6	§2.1049	Occupied Bandwidth	Reporting Only	PASS	-
3.7	§2.1051 §27.53(h) §27.53(g)	Conducted Band Edge Measurement (5G NR n70) (5G NR n71)	< 43+10log ₁₀ (P[Watts])	PASS	-
	§27.53(m)(4)	Conducted Band Edge Measurement (5G NR n7, n38, n41)	§27.53(m)(4)		
3.8	§2.1051 §27.53(h) §27.53(g)	Conducted Spurious Emission (5G NR n70) (5G NR n71)	< 43+10log ₁₀ (P[Watts])	PASS	-
	§2.1051 §27.53(m)(4)	Conducted Spurious Emission (5G NR n7, n38, n41)	< 55+10log ₁₀ (P[Watts])		
3.9	§2.1055 §27.54	Frequency Stability Temperature & Voltage	Within Authorized Band	PASS	-
4.4	§2.1053 §27.53(h) §27.53(g)	Radiated Spurious Emission (5G NR n70) (5G NR n71)	< 43+10log ₁₀ (P[Watts])	PASS	Under limit 4.93 dB at 10848.000 MHz
	§2.1053 §27.53(m)(4)	Radiated Spurious Emission (5G NR n7, n38, n41)	< 55+10log ₁₀ (P[Watts])		

Declaration of Conformity:

The test results with all measurement uncertainty excluded are presented in accordance with the regulation limits or requirements declared by manufacturers.

Comments and Explanations:

The declared of product specification for EUT presented in the report are provided by the manufacturer, and the manufacturer takes all the responsibilities for the accuracy of product specification.



1 General Description

1.1 Applicant

Motorola Mobility LLC
222 W,Merchandise Mart Plaza, Chicago IL 60654 USA

1.2 Manufacturer

Motorola Mobility LLC
222 W,Merchandise Mart Plaza, Chicago IL 60654 USA

1.3 Product Feature of Equipment Under Test

Product Feature	
Equipment	Mobile Cellular Phone
Brand Name	Motorola
Model Name	XT2301-1
FCC ID	IHDT56AH1
IMEI Code	Conduction: 350007550013818/350007550013826 Radiation: 350007550014055/350007550014063
HW Version	DVT2
SW Version	TTR33.124
EUT Stage	Identical Prototype

The three model names are only for market differentiation, all the others are the same.

1.4 Product Specification of Equipment Under Test

Standards-related Product Specification	
Tx Frequency	5G NR n7 : 2500 MHz ~ 2570 MHz 5G NR n38 : 2570 MHz ~ 2620 MHz 5G NR n41 : 2496 MHz ~ 2690 MHz 5G NR n70 : 1695 MHz ~ 1710 MHz 5G NR n71: 663 MHz ~ 698 MHz
Rx Frequency	5G NR n7 : 2620 MHz ~ 2690 MHz 5G NR n38 : 2570 MHz ~ 2620 MHz 5G NR n41 : 2496 MHz ~ 2690 MHz 5G NR n70 : 1995 MHz ~ 2020 MHz 5G NR n71: 617 MHz ~ 652 MHz
Bandwidth	n7: 5MHz / 10MHz / 15MHz / 20MHz / 25MHz / 30MHz / 40MHz n38: 10MHz / 15MHz / 20MHz / 25MHz / 30MHz / 40MHz n41: 10MHz / 15MHz / 20MHz / 30 MHz / 40MHz / 50MHz / 60MHz / 70MHz / 80MHz / 90MHz / 100MHz n70: 5MHz / 10MHz / 15MHz n71: 5MHz / 10MHz / 15MHz / 20MHz
SCS	5G NR n7/n70/n71: 15kHz 5G NR n38/n41: 30kHz



Antenna Gain	<p><Ant. 0>: n71 : -4.80 dBi n41 : -4.10 dBi</p> <p><Ant. 1>: n7 : -2.08 dBi n70 : -1.91 dBi n71 : -7.15 dBi n38 : -2.08 dBi n41 : -2.08 dBi</p> <p><Ant. 2>: n70 : -3.50 dBi n41 : -1.20 dBi</p> <p><Ant. 4>: n41 : -6.50 dBi</p>
Type of Modulation	<p>CP-OFDM: QPSK / 16QAM / 64QAM / 256QAM DFT-s-OFDM: PI/2 BPSK / QPSK / 16QAM / 64QAM / 256QAM</p>

Remark:

1. The maximum ERP/EIRP is calculated from max output power and max antenna gain, only the maximum ERP/EIRP are shown in the report, 5G NR n71 for Ant. 0, 5G NR n7/n38/n70 for Ant. 1 and n41 for Ant. 2, and n41 UL MIMO for Antenna 1+2
2. All the supported ENDC combinations are verified conducted power, only the ENDC combination with highest power are shown in the report.
3. 5G NR support SA (n7/n38/n41/n70/n71) mode and NSA(n7/n41/n71) mode. According to the maximum power between SA and NSA mode, SA covers NSA mode.
4. The device supports HPUE(power class 1.5) mode and UL_MIMO mode for 5G NR n41.
5. The device supports n41(1T4R) SRS resources on ant.0/1/2/4, only the test data of worst ant.2 is showed in the report according to the maximum power.
6. The EN-DC mode combination could be referred to the product spec.
7. MIMO Antenna gain = $10 \log[(10^{G1/20} + 10^{G2/20})^2 / 2]$.
8. For n41 MIMO mode, the conducted BE/Spurious are tested at single antenna port and add $10 \cdot \log(N_{ANT})$ according to KDB 662911 D01.

1.5 Modification of EUT

No modifications are made to the EUT during all test items.



1.6 Specification of Accessory

Specification of Accessory				
AC Adapter 1(US)	Brand Name	Motorola (Chenyang)	Model Name	MC-681N
AC Adapter 2(US)	Brand Name	Motorola (Acbel)	Model Name	MC-681N
Battery 1	Brand Name	Motorola(SCUD)	Model Name	PC51
Earphone 1	Brand Name	Motorola (Lyand)	Model Name	MI181C(SH38D62338)
USB Cable 1	Brand Name	Motorola(Saibao)	Model Name	SC18D24968
C to HDMI HDMI/USBC Cable 1	Brand Name	Motorola(Linxee)	Model Name	SC18D02146
C to HDMI HDMI/USBC Cable 2	Brand Name	Motorola(Linxee)	Model Name	SC18D38847

1.7 Maximum ERP/EIRP Power and Emission Designator

5G NR n7		PI/2 BPSK / QPSK		16QAM / 64QAM / 256QAM	
BW (MHz)	Frequency Range (MHz)	Maximum EIRP(W)	Emission Designator (99%OBW)	Maximum EIRP(W)	Emission Designator (99%OBW)
5	2502.5 ~ 2567.5	0.1469	4M49G7D	0.1161	4M50W7D
10	2505.0 ~ 2565.0	0.1426	9M28G7D	0.1169	9M29W7D
15	2507.5 ~ 2562.5	0.1535	14M1G7D	0.1245	14M1W7D
20	2510.0 ~ 2560.0	0.1483	18M9G7D	0.1236	18M9W7D
25	2512.5 ~ 2557.5	0.1528	23M7G7D	0.1236	23M8W7D
30	2515.0 ~ 2555.0	0.1538	28M6G7D	0.1271	28M6W7D
40	2520.0 ~ 2550.0	0.1552	38M6G7D	0.1271	38M6W7D

5G NR n38 SA		PI/2 BPSK / QPSK		16QAM / 64QAM / 256QAM	
BW (MHz)	Frequency Range (MHz)	Maximum EIRP(W)	Emission Designator (99%OBW)	Maximum EIRP(W)	Emission Designator (99%OBW)
10	2575.0 ~ 2615.0	0.1452	8M61G7D	0.1191	8M62W7D
15	2577.5 ~ 2612.5	0.1493	13M6G7D	0.1199	13M6W7D
20	2580.0 ~ 2610.0	0.1452	18M2G7D	0.1189	18M2W7D
25	2582.5 ~ 2607.5	0.1496	23M2G7D	0.1178	23M2W7D
30	2585.0 ~ 2605.0	0.1517	27M9G7D	0.1239	27M9W7D
40	2590.0 ~ 2600.0	0.1538	37M8G7D	0.1225	37M9W7D



5G NR n41		PI/2 BPSK / QPSK		16QAM / 64QAM / 256QAM	
BW (MHz)	Frequency Range (MHz)	Maximum EIRP(W)	Emission Designator (99%OBW)	Maximum EIRP(W)	Emission Designator (99%OBW)
10	2501.01 ~ 2685.00	0.3491	8M61G7D	0.2799	8M62W7D
15	2503.50 ~ 2682.48	0.3516	13M6G7D	0.2805	13M6W7D
20	2506.02 ~ 2679.99	0.3491	18M2G7D	0.2812	18M2W7D
30	2511.00 ~ 2674.98	0.3499	27M9G7D	0.2864	27M9W7D
40	2516.01 ~ 2670.00	0.3614	37M8G7D	0.2897	37M9W7D
50	2521.02 ~ 2664.99	0.3565	47M5G7D	0.2786	47M6W7D
60	2526.00 ~ 2659.98	0.3412	57M9G7D	0.2761	57M9W7D
70	2531.01 ~ 2655.00	0.3357	67M5G7D	0.2698	67M5W7D
80	2536.02 ~ 2649.99	0.3327	77M6G7D	0.2698	77M6W7D
90	2541.00 ~ 2644.98	0.3304	87M6G7D	0.2692	87M8W7D
100	2546.01 ~ 2640.00	0.3639	97M6G7D	0.2938	97M7W7D

5G NR n41-UL MIMO		PI/2 BPSK / QPSK		16QAM / 64QAM / 256QAM	
BW (MHz)	Frequency Range (MHz)	Maximum EIRP(W)	Emission Designator (99%OBW)	Maximum EIRP(W)	Emission Designator (99%OBW)
10	2501.01 ~ 2685.00	0.9141	8M60G7D	0.7015	8M61W7D
15	2503.50 ~ 2682.48	0.9036	13M6G7D	0.6934	13M6W7D
20	2506.02 ~ 2679.99	0.9290	18M2G7D	0.7031	18M3W7D
30	2511.00 ~ 2674.98	0.9057	27M9G7D	0.6792	27M9W7D
40	2516.01 ~ 2670.00	0.9290	37M8G7D	0.7194	38M0W7D
50	2521.02 ~ 2664.99	0.9462	47M6G7D	0.7161	47M6W7D
60	2526.00 ~ 2659.98	0.9484	58M0G7D	0.7096	57M9W7D
70	2531.01 ~ 2655.00	0.9183	67M6G7D	0.7096	67M5W7D
80	2536.02 ~ 2649.99	0.9268	77M5G7D	0.6855	77M7W7D
90	2541.00 ~ 2644.98	0.9141	87M6G7D	0.7362	87M7W7D
100	2546.01 ~ 2640.00	0.9506	97M7G7D	0.8241	97M8W7D



5G NR n70		PI/2 BPSK / QPSK		16QAM / 64QAM / 256QAM	
BW (MHz)	Frequency Range (MHz)	Maximum EIRP(W)	Emission Designator (99%OBW)	Maximum EIRP(W)	Emission Designator (99%OBW)
5	1697.5 ~ 1707.5	0.1538	4M49G7D	0.1245	4M49W7D
10	1700 ~ 1705	0.1493	9M28G7D	0.1219	9M29W7D
15	1702.5	0.1574	14M1G7D	0.1262	14M1W7D

5G NR n71		PI/2 BPSK / QPSK		16QAM / 64QAM / 256QAM	
BW (MHz)	Frequency Range (MHz)	Maximum ERP(W)	Emission Designator (99%OBW)	Maximum ERP(W)	Emission Designator (99%OBW)
5	665.5 ~ 695.5	0.0490	4M48G7D	0.0391	4M49W7D
10	668.0 ~ 693.0	0.0488	9M27G7D	0.0382	9M28W7D
15	670.5 ~ 690.5	0.0483	14M1G7D	0.0384	14M1W7D
20	673.0 ~ 688.0	0.0493	18M9G7D	0.0389	18M9W7D

Note: All modulations have been tested, only the worst test results of PSK & QAM are shown in the report.

1.8 Testing Location

Sporton International Inc. (Shenzhen) is accredited to ISO/IEC 17025:2017 by American Association for Laboratory Accreditation with Certificate Number 5145.01.

Test Firm	Sporton International Inc. (Shenzhen)		
Test Site Location	1/F, 2/F, Bldg 5, Shiling Industrial Zone, Xinwei Village, Xili, Nanshan, Shenzhen, 518055 People's Republic of China TEL: +86-755-86379589 FAX: +86-755-86379595		
Test Site No.	Sporton Site No.	FCC Designation No.	FCC Test Firm Registration No.
	TH01-SZ	CN1256	421272

Test Firm	Sporton International Inc. (Shenzhen)		
Test Site Location	101, 1st Floor, Block B, Building 1, No. 2, Tengfeng 4th Road, Fenghuang Community, Fuyong Street, Baoan District, Shenzhen City Guangdong Province China 518103 TEL: +86-755-33202398		
Test Site No.	Sporton Site No.	FCC Designation No.	FCC Test Firm Registration No.
	03CH03-SZ	CN1256	421272



1.9 Test Software

Item	Site	Manufacturer	Name	Version
1.	03CH03-SZ	AUDIX	E3	6.2009-8-24

1.10 Applicable Standards

According to the specifications of the manufacturer, the EUT must comply with the requirements of the following standards:

- ♦ 47 CFR Part 2, 27
- ♦ ANSI C63.26-2015
- ♦ FCC KDB 971168 D01 Power Meas License Digital Systems v03r01
- ♦ FCC KDB 412172 D01 Determining ERP and EIRP v01r01

Remark: All test items were verified and recorded according to the standards and without any deviation during the test.



2 Test Configuration of Equipment Under Test

2.1 Test Mode

Antenna port conducted and radiated test items are performed according to KDB 971168 D01 Power Meas License Digital Systems v03r01 with maximum output power.

For radiated measurement, pre-scanned in three orthogonal panels, X, Y, Z. The worst cases(X, Y, Z plane) were recorded in this report.

The device is investigated from 30MHz to 10 times of fundamental signal for radiated spurious emission test under different RB size/offset and modulations in exploratory test. Subsequently, only the worst case emissions are reported.

Orthogonal Planes of EUT	X Plane	Y Plane	Z Plane
			

Test Items	5G NR	Bandwidth (MHz)													Modulation					RB #		Test Channel						
		5	10	15	20	25	30	40	50	60	70	80	90	100	PI/2 BPSK	QPSK	16QAM	64QAM	256QAM	1	Full	L	M	H				
Max. Output Power	n7	v	v	v	v	v	v	v	-	-	-	-	-	-	v	v	v	v	v	v	v	v	v	v	v	v	v	
	n41	-	v	v	v	-	v	v	v	v	v	v	v	v	v	v	v	v	v	v	v	v	v	v	v	v	v	v
	n38	-	v	v	v	v	v	v	-	-	-	-	-	-	v	v	v	v	v	v	v	v	v	v	v	v	v	v
	n70	v	v	v	-	-	-	-	-	-	-	-	-	-	v	v	v	v	v	v	v	v	v	v	v	v	v	v
	n71	v	v	v	v	-	-	-	-	-	-	-	-	-	v	v	v	v	v	v	v	v	v	v	v	v	v	v
Peak-to-Average Ratio	n7				v				-	-	-	-	-	v	v					v	v	v	v	v	v	v	v	
	n41	-			v	-								v	v					v	v	v	v	v	v	v	v	
	n70		v		-	-	-	-	-	-	-	-	-	v	v					v	v	v	v	v	v	v	v	
	n71				v	-	-	-	-	-	-	-	-	v	v					v	v	v	v	v	v	v	v	
26dB and 99% Bandwidth	n7	v	v	v	v	v	v	v	-	-	-	-	-	v	v	v	v	v	v		v			v				
	n41	-	v	v	v	-	v	v	v	v	v	v	v	v	v	v	v	v	v	v		v			v			
	n38	-				v			-	-	-	-	-	v	v	v	v	v	v	v		v			v			
	n70	v	v	v	-	-	-	-	-	-	-	-	-	v	v	v	v	v	v	v		v			v			
	n71	v	v	v	v	-	-	-	-	-	-	-	-	v	v	v	v	v	v	v		v			v			



Test Items	5G NR	Bandwidth (MHz)													Modulation					RB #		Test Channel				
		5	10	15	20	25	30	40	50	60	70	80	90	100	PI/2 BPSK	QPSK	16QAM	64QAM	256QAM	1	Full	L	M	H		
Conducted Band Edge	n7	v			v				-	-	-	-	-	-	v	v				v	v	v		v		
	n41	-	v			-			v					v	v	v				v	v	v		v		
	n38	-				v			-	-	-	-	-	-	v	v				v	v	v		v		
	n70	v	v	v	-	-	-	-	-	-	-	-	-	-	v	v				v	v	v		v		
	n71	v	v		v	-	-	-	-	-	-	-	-	-	v	v				v	v	v		v		
Conducted Spurious Emission	n7	v			v				-	-	-	-	-	-	v	v				v		v	v	v		
	n41	-	v			-			v					v	v	v				v		v	v	v		
	n38	-			v				-	-	-	-	-	-	v	v				v		v	v	v		
	n70	v	v	v	-	-	-	-	-	-	-	-	-	-	v	v				v		v	v	v		
	n71	v	v		v	-	-	-	-	-	-	-	-	-	v	v				v		v	v	v		
Frequency Stability	n7				v				-	-	-	-	-	-		v				v		v				
	n41	-			v	-										v				v		v				
	n70		v		-	-	-	-	-	-	-	-	-	-		v				v		v				
	n71				v	-	-	-	-	-	-	-	-	-		v				v		v				
E.R.P / E.I.R.P	n7	v	v	v	v	v	v	v	-	-	-	-	-	-	v	v	v	v	v	v	v	v	v	v		
	n41	-	v	v	v	-	v	v	v	v	v	v	v	v	v	v	v	v	v	v	v	v	v	v		
	n38	-	v	v	v	v	v	v	-	-	-	-	-	-	v	v	v	v	v	v	v	v	v	v		
	n70	v	v	v	-	-	-	-	-	-	-	-	-	-	v	v	v	v	v	v	v	v	v	v		
	n71	v	v	v	v	-	-	-	-	-	-	-	-	-	v	v	v	v	v	v	v	v	v	v		
Radiated Spurious Emission	n7	Worst Case																				v				
	n41	Worst Case																				v				
	n70	Worst Case																				v				
	n71	Worst Case																				v				
Note	1. The mark "v" means that this configuration is chosen for testing 2. The mark "-" means that this bandwidth is not supported. 3. The device is investigated from 30MHz to 10 times of fundamental signal for radiated spurious emission test under different RB size/offset and modulations in exploratory test. Subsequently, only the worst case emissions are reported. 4. Frequency Stability : Normal Voltage = 3.89V ; Low Voltage =3.40V. ; High Voltage =4.48V																									

2.2 Connection Diagram of Test System

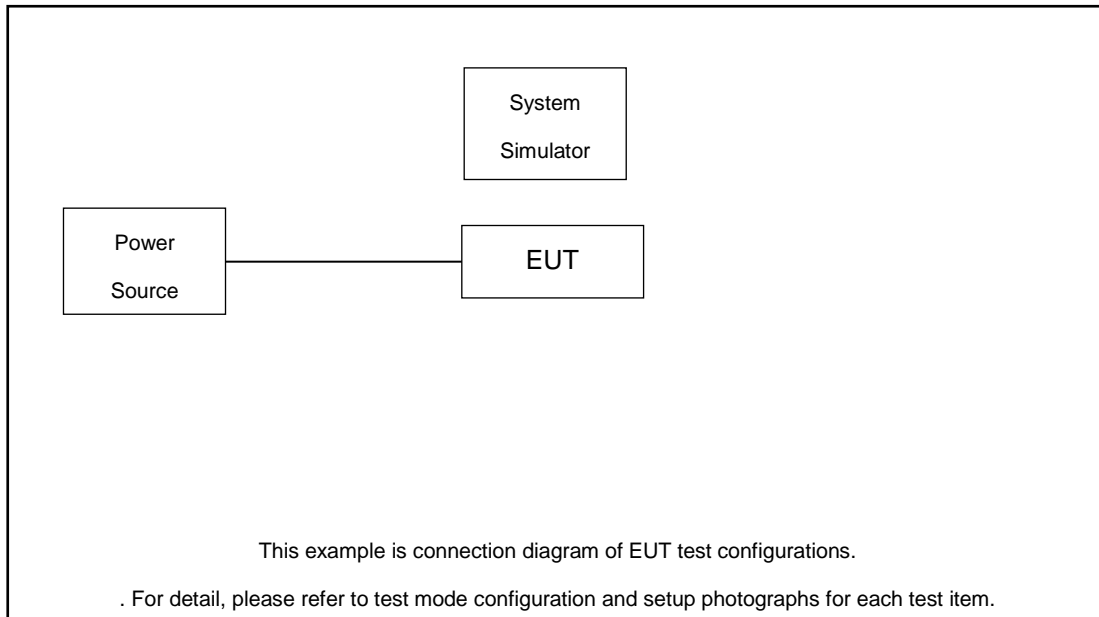

The EUT has been configuration operated in a manner tended to maximize its emission characteristics in a typical application.

2.3 Support Unit used in test configuration and system

Item	Equipment	Trade Name	Model No.	FCC ID	Data Cable	Power Cord
1.	DC Power Supply	GW	GPS-3030D	N/A	N/A	Unshielded, 1.8 m
2.	LTE Base Station	Anritsu	MT8821C	N/A	N/A	Unshielded, 1.8 m
3.	NR Base Station	Anritsu	MT8000A	N/A	N/A	Unshielded, 1.8 m

2.4 Measurement Results Explanation Example

For all conducted test items:

The offset level is set in the spectrum analyzer to compensate the RF cable loss and attenuator factor between EUT conducted output port and spectrum analyzer. With the offset compensation, the spectrum analyzer reading level is exactly the EUT RF output level.

The spectrum analyzer offset is derived from RF cable loss and attenuator factor.

Offset = RF cable loss.

Following shows an offset computation example with cable loss 8.4 dB.

Example :

$$\begin{aligned} \text{Offset(dB)} &= \text{RF cable loss(dB)}. \\ &= 8.4 \text{ (dB)} \end{aligned}$$



2.5 Frequency List of Low/Middle/High Channels

5G NR n7 Channel and Frequency List				
BW [MHz]	Channel/Frequency(MHz)	Lowest	Middle	Highest
40	Channel	504000	507000	510000
	Frequency	2520	2535	2550
30	Channel	503000	507000	511000
	Frequency	2515	2535	2555
25	Channel	502500	507000	511500
	Frequency	2512.5	2535	2557.5
20	Channel	502000	507000	512000
	Frequency	2510	2535	2560
15	Channel	501500	507000	512500
	Frequency	2507.5	2535	2562.5
10	Channel	501000	507000	513000
	Frequency	2505	2535	2565
5	Channel	500500	507000	513500
	Frequency	2502.5	2535	2567.5

5G NR n38 Channel and Frequency List				
BW [MHz]	Channel/Frequency(MHz)	Lowest	Middle	Highest
40	Channel	518000	519000	520000
	Frequency	2590	2595	2600
30	Channel	517000	519000	521000
	Frequency	2585	2595	2605
25	Channel	516500	519000	521500
	Frequency	2582.5	2595	2607.5
20	Channel	516000	519000	522000
	Frequency	2580	2595	2610
15	Channel	515500	519000	522500
	Frequency	2577.5	2595	2612.5
10	Channel	515000	519000	523000
	Frequency	2575	2595	2615



5G NR n41 Channel and Frequency List				
BW [MHz]	Channel/Frequency(MHz)	Lowest	Middle	Highest
100	Channel	509202	518598	528000
	Frequency	2546.01	2592.99	2640
90	Channel	508200	518598	528996
	Frequency	2541	2592.99	2644.98
80	Channel	507204	518598	529998
	Frequency	2536.02	2592.99	2649.99
70	Channel	506202	518598	531000
	Frequency	2531.01	2592.99	2655
60	Channel	505200	518598	531996
	Frequency	2526	2592.99	2659.98
50	Channel	504204	518598	532998
	Frequency	2521.02	2592.99	2664.99
40	Channel	503202	518598	534000
	Frequency	2516.01	2592.99	2670
30	Channel	502200	518598	534996
	Frequency	2511	2592.99	2674.98
20	Channel	501204	518598	535998
	Frequency	2506.02	2592.99	2679.99
15	Channel	500700	518598	536496
	Frequency	2503.5	2592.99	2682.48
10	Channel	500202	518598	537000
	Frequency	2501.01	2592.99	2685



5G NR n70 Channel and Frequency List				
BW [MHz]	Channel/Frequency(MHz)	Lowest	Middle	Highest
15	Channel	400500		
	Frequency	1702.5		
10	Channel	400000	400500	401000
	Frequency	1700	1702.5	1705
5	Channel	399500	400500	401500
	Frequency	1697.5	1702.5	1707.5

5G NR n71 Channel and Frequency List				
BW [MHz]	Channel/Frequency(MHz)	Lowest	Middle	Highest
20	Channel	134600	136100	137600
	Frequency	673	680.5	688
15	Channel	134100	136100	138100
	Frequency	670.5	680.5	690.5
10	Channel	133600	136100	138600
	Frequency	668	680.5	693
5	Channel	133100	136100	139100
	Frequency	665.5	680.5	695.5

3 Conducted Test Items

3.1 Measuring Instruments

See list of measuring instruments of this test report.

3.2 Test Setup

3.2.1 Conducted Output Power



3.2.2 Peak-to-Average Ratio, Occupied Bandwidth ,Conducted Band-Edge and Conducted Spurious Emission

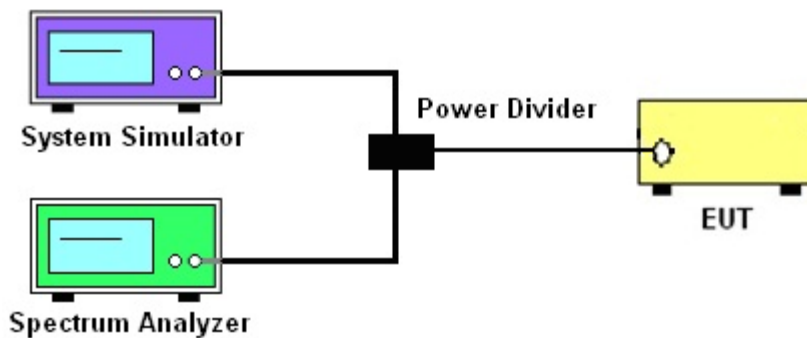

3.2.3 Frequency Stability

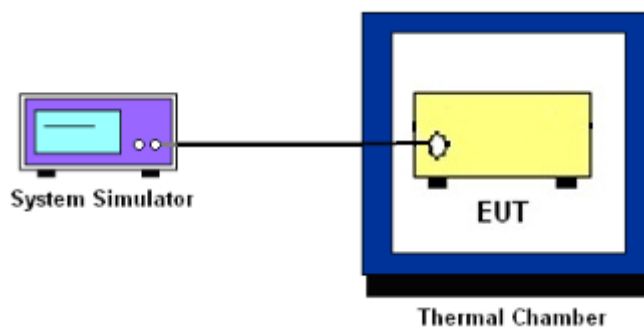

3.3 Test Result of Conducted Test

Please refer to Appendix A.



3.4 Conducted Output Power and ERP/EIRP

3.4.1 Description of the Conducted Output Power Measurement and ERP/EIRP Measurement

A system simulator was used to establish communication with the EUT. Its parameters were set to force the EUT transmitting at maximum output power. The measured power in the radio frequency on the transmitter output terminals shall be reported.

The ERP of mobile transmitters must not exceed 3 Watts for 5G NR n71.

The EIRP of mobile transmitters must not exceed 2 Watts for 5G NR n7, n38, n41.

The EIRP of mobile transmitters must not exceed 1 Watts for 5G NR n70

According to KDB 412172 D01 Power Approach,

$EIRP = P_T + G_T - L_C$, $ERP = EIRP - 2.15$, where

P_T = transmitter output power in dBm

G_T = gain of the transmitting antenna in dBi

L_C = signal attenuation in the connecting cable between the transmitter and antenna in dB

3.4.2 Test Procedures

1. The testing follows ANSI C63.26 Section 5.2
2. The transmitter output port was connected to the system simulator.
3. Set EUT at maximum power through the system simulator.
4. Select lowest, middle, and highest channels for each band and different modulation.
5. Measure and record the power level from the system simulator.



3.5 Peak-to-Average Ratio

3.5.1 Description of the PAR Measurement

Power Complementary Cumulative Distribution Function (CCDF) curves provide a means for characterizing the power peaks of a digitally modulated signal on a statistical basis. A CCDF curve depicts the probability of the peak signal amplitude exceeding the average power level. Most contemporary measurement instrumentation include the capability to produce CCDF curves for an input signal provided that the instrument's resolution bandwidth can be set wide enough to accommodate the entire input signal bandwidth. In measuring transmissions in this band using an average power technique, the peak-to-average ratio (PAR) of the transmission may not exceed 13 dB.

3.5.2 Test Procedures

1. The testing follows ANSI C63.26 Section 5.2.3.4 (CCDF).
2. The EUT was connected to spectrum and system simulator via a power divider.
3. Set the CCDF (Complementary Cumulative Distribution Function) option in spectrum analyzer.
4. The highest RF powers were measured and recorded the maximum PAPR level associated with a probability of 0.1 %.
5. Record the deviation as Peak to Average Ratio.



3.6 Occupied Bandwidth

3.6.1 Description of Occupied Bandwidth Measurement

The occupied bandwidth is the width of a frequency band such that, below the lower and above the upper frequency limits, the mean powers emitted are each equal to a specified percentage 0.5% of the total mean transmitted power.

The 26 dB emission bandwidth is defined as the frequency range between two points, one above and one below the carrier frequency, at which the spectral density of the emission is attenuated 26 dB below the maximum in-band spectral density of the modulated signal. Spectral density (power per unit bandwidth) is to be measured with a detector of resolution bandwidth equal to approximately 1.0% of the emission bandwidth.

3.6.2 Test Procedures

1. The testing follows ANSI C63.26 Section 5.4
2. The EUT was connected to spectrum analyzer and system simulator via a power divider.
3. The spectrum analyzer center frequency is set to the nominal EUT channel center frequency. The span range for the spectrum analyzer shall be between two and five times the anticipated OBW.
4. The nominal resolution bandwidth (RBW) shall be in the range of 1 to 5 % of the anticipated OBW, and the VBW shall be at least 3 times the RBW.
5. Set the detection mode to peak, and the trace mode to max hold.
6. Determine the reference value: Set the EUT to transmit a modulated signal. Allow the trace to stabilize. Set the spectrum analyzer marker to the highest level of the displayed trace.
(this is the reference value)
7. Determine the “-26 dB down amplitude” as equal to (Reference Value – X).
8. Place two markers, one at the lowest and the other at the highest frequency of the envelope of the spectral display such that each marker is at or slightly below the “-X dB down amplitude” determined in step 6. If a marker is below this “-X dB down amplitude” value it shall be placed as close as possible to this value. The OBW is the positive frequency difference between the two markers.
9. Use the 99 % power bandwidth function of the spectrum analyzer and report the measured bandwidth.



3.7 Conducted Band Edge

3.7.1 Description of Conducted Band Edge Measurement

27.53 (h)

For operations in the 1710 – 1755 MHz band, the FCC limit is $43 + 10\log_{10}(P[\text{Watts}])$ dB below the transmitter power P(Watts) in a 1 MHz bandwidth. However, in the 1MHz bands immediately outside and adjacent to the licensee's frequency block, a resolution bandwidth of at least one percent of the emission bandwidth of the fundamental emission of the transmitter may be employed.

27.53 (g)

For operations in the 600MHz band and 698 -746 MHz band, the FCC limit is $43 + 10\log_{10}(P[\text{Watts}])$ dB below the transmitter power P(Watts) in a 100 kHz bandwidth. However, in the 100 kilohertz bands immediately outside and adjacent to a licensee's frequency block, a resolution bandwidth of at least 30 kHz may be employed.

27.53(m)(4)

For mobile digital stations, the attenuation factor shall be not less than $40 + 10 \log (P)$ dB on all frequencies between the channel edge and 5 megahertz from the channel edge, $43 + 10 \log (P)$ dB on all frequencies between 5 megahertz and X megahertz from the channel edge, and $55 + 10 \log (P)$ dB on all frequencies more than X megahertz from the channel edge, where X is the greater of 6 megahertz or the actual emission bandwidth as defined in paragraph (m)(6) of this section. In addition, the attenuation factor shall not be less that $43 + 10 \log (P)$ dB on all frequencies between 2490.5 MHz and 2496 MHz and $55 + 10 \log (P)$ dB at or below 2490.5 MHz. Mobile Satellite Service licensees operating on frequencies below 2495 MHz may also submit a documented interference complaint against BRS licensees operating on channel BRS Channel 1 on the same terms and conditions as adjacent channel BRS or EBS licensees.



3.7.2 Test Procedures

1. The testing follows ANSI C63.26 section 5.7
2. The EUT was connected to spectrum analyzer and system simulator via a power divider.
3. The band edges of low and high channels for the highest RF powers were measured.
4. Set RBW \geq 1% EBW in the 1MHz band immediately outside and adjacent to the band edge.
5. Beyond the 1 MHz band from the band edge, RBW=1MHz was used or a narrower RBW was used (generally limited to no less than 1% of the OBW) and the measured power was integrated over the full required measurement bandwidth.
6. Set spectrum analyzer with RMS detector.
7. The RF fundamental frequency should be excluded against the limit line in the operating frequency band.
8. Checked that all the results comply with the emission limit line.

Example:

The limit line is derived from $43 + 10\log(P)$ dB below the transmitter power P(Watts)
= P(W)- [43 + 10log(P)] (dB)
= [30 + 10log(P)] (dBm) - [43 + 10log(P)] (dB) = -13dBm.

9. For 5G NR n7/n38/n41, the other 40 dB, and 55 dB have additionally applied same calculation above.
10. When using the integration method, the starting frequency of the integration shall be centered at one-half of the RBW away from the band edge.



3.8 Conducted Spurious Emission

3.8.1 Description of Conducted Spurious Emission Measurement

The power of any emission outside of the authorized operating frequency ranges must be lower than the transmitter power (P) by a factor of at least $43 + 10 \log (P)$ dB.

For 5G NR n7/n38/n41:

The power of any emission outside of the authorized operating frequency ranges must be lower than the transmitter power (P) by a factor of at least $55 + 10 \log (P)$ dB.

It is measured by means of a calibrated spectrum analyzer and scanned from 30 MHz up to a frequency including its 10th harmonic.

3.8.2 Test Procedures

1. The testing follows ANSI C63.26 section 5.7
2. The EUT was connected to spectrum analyzer and system simulator via a power divider.
3. The RF output of EUT was connected to the spectrum analyzer by RF cable and attenuator. The path loss was compensated to the results for each measurement.
4. The middle channel for the highest RF power within the transmitting frequency was measured.
5. The conducted spurious emission for the whole frequency range was taken.
6. Make the measurement with the spectrum analyzer's RBW = 1MHz, VBW = 3MHz.
7. Set spectrum analyzer with RMS detector.
8. Taking the record of maximum spurious emission.
9. The RF fundamental frequency should be excluded against the limit line in the operating frequency band.
10. The limit line is derived from $43 + 10\log(P)$ dB below the transmitter power P(Watts)
= $P(W) - [43 + 10\log(P)]$ (dB)
= $[30 + 10\log(P)]$ (dBm) - $[43 + 10\log(P)]$ (dB)
= -13dBm.
11. For 5G NR n7/n38/n41
The limit line is derived from $55 + 10\log(P)$ dB below the transmitter power P(Watts)
= $P(W) - [55 + 10\log(P)]$ (dB)
= $[30 + 10\log(P)]$ (dBm) - $[55 + 10\log(P)]$ (dB)
= -25dBm.



3.9 Frequency Stability

3.9.1 Description of Frequency Stability Measurement

The frequency stability shall be measured by variation of ambient temperature and variation of primary supply voltage to ensure that the fundamental emission stays within the authorized frequency block. The frequency stability of the transmitter shall be maintained within $\pm 0.00025\%$ ($\pm 2.5\text{ppm}$) of the center frequency.

3.9.2 Test Procedures for Temperature Variation

1. The testing follows ANSI C63.26 section 5.6.4
2. The EUT was set up in the thermal chamber and connected with the system simulator.
3. With power OFF, the temperature was decreased to -30°C and the EUT was stabilized before testing. Power was applied and the maximum change in frequency was recorded within one minute.
4. With power OFF, the temperature was raised in 10°C step up to 50°C . The EUT was stabilized at each step for at least half an hour. Power was applied and the maximum frequency change was recorded within one minute.

3.9.3 Test Procedures for Voltage Variation

1. The testing follows ANSI C63.26 section 5.6.5
2. The EUT was placed in a temperature chamber at $20\pm 5^{\circ}\text{C}$ and connected with the system simulator.
3. The power supply voltage to the EUT was varied from 85% to 115% of the nominal value for other than hand carried battery equipment.
4. For hand carried, battery powered equipment, reduce the primary ac or dc supply voltage to the battery operating end point, which shall be specified by the manufacturer.
5. The variation in frequency was measured for the worst case.

4 Radiated Test Items

4.1 Measuring Instruments

See list of measuring instruments of this test report.

4.2 Test Setup

4.2.1 For radiated test below 30MHz

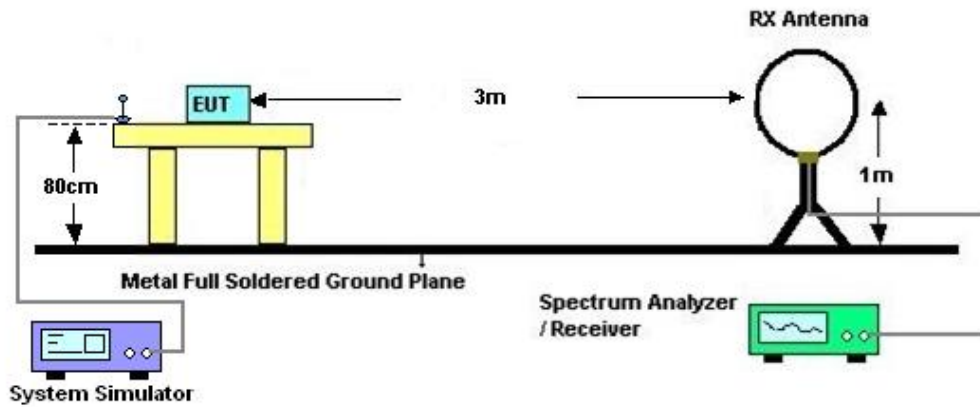

4.2.2 For radiated test from 30MHz to 1GHz

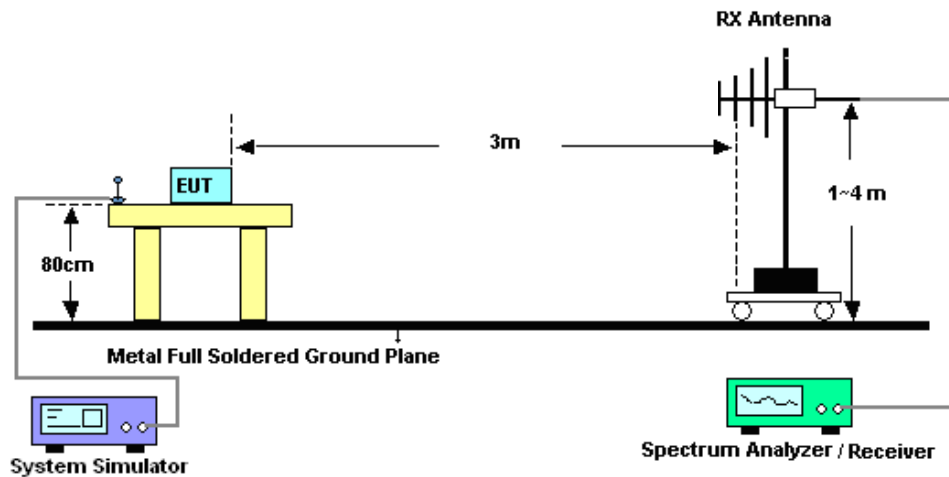

4.2.3 For radiated test above 1GHz

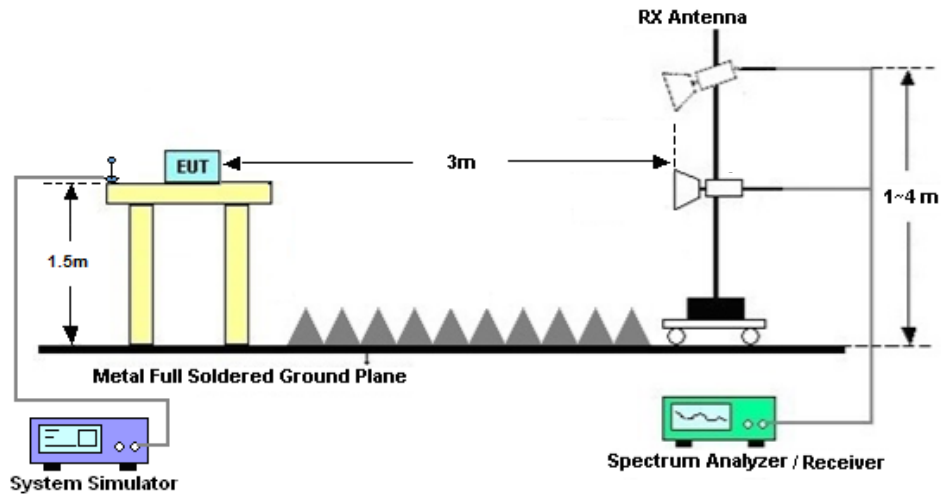

4.3 Test Result of Radiated Test

The low frequency, which started from 9 kHz to 30MHz, was pre-scanned and the result which was 20dB lower than the limit line was not reported.

Please refer to Appendix B.



4.4 Radiated Spurious Emission

4.4.1 Description of Radiated Spurious Emission

The radiated spurious emission was measured by substitution method according to ANSI C63.26. The power of any emission outside of the authorized operating frequency ranges must be attenuated below the transmitter power (P) by a factor of at least $43 + 10 \log (P)$ dB.

For 5G NR n7/n41

The power of any emission outside of the authorized operating frequency ranges must be attenuated below the transmitter power (P) by a factor of at least $55 + 10 \log (P)$ dB.

The spectrum is scanned from 30 MHz up to a frequency including its 10th harmonic.

4.4.2 Test Procedures

1. The testing follows ANSI C63.26 Section 5.5
2. The EUT was placed on a turntable with 0.8 meter height for frequency below 1GHz and 1.5 meter height for frequency above 1GHz respectively above ground.
3. The EUT was set 3 meters from the receiving antenna mounted on the antenna tower.
4. The table was rotated 360 degrees to determine the position of the highest spurious emission.
5. The height of the receiving antenna is varied between 1m to 4m to search the maximum spurious emission for both horizontal and vertical polarizations.
6. During the measurement, the system simulator parameters were set to force the EUT transmitting at maximum output power.
7. Make the measurement with the spectrum analyzer's RBW = 1MHz, VBW = 3MHz, taking the record of maximum spurious emission.
8. A horn antenna was substituted in place of the EUT and was driven by a signal generator.
9. Tune the output power of signal generator to the same emission level with EUT maximum spurious emission.
10. $EIRP (dBm) = S.G. Power - Tx Cable Loss + Tx Antenna Gain$
11. $ERP (dBm) = EIRP - 2.15$
12. The RF fundamental frequency should be excluded against the limit line in the operating frequency band.

The limit line is derived from $43 + 10\log(P)$ dB below the transmitter power P(Watts)
 $= P(W) - [43 + 10\log(P)] (dB)$
 $= [30 + 10\log(P)] (dBm) - [43 + 10\log(P)] (dB)$
 $= -13dBm.$

13. For 5G NR n7/n38/n41:

The limit line is derived from $55 + 10\log(P)$ dB below the transmitter power P(Watts)The limit line is derived from $55 + 10\log(P)$ dB below the transmitter power P(Watts)



5 List of Measuring Equipment

Instrument	Manufacturer	Model No.	Serial No.	Characteristics	Calibration Date	Test Date	Due Date	Remark
Spectrum Analyzer	R&S	FSV40	101078	10Hz~40GHz	Apr. 07, 2022	Oct. 29, 2022~ Nov. 24, 2022	Apr. 08, 2023	Conducted (TH01-SZ)
Power Divider	TOJOIN	PS-2SM-04 265	60.06.020.007 7	0.4GHz~26.5GHz	Dec. 25, 2021	Oct. 29, 2022~ Nov. 24, 2022	Dec. 24, 2022	Conducted (TH01-SZ)
Thermal Chamber	Ten Billion Hongzhangroup	LP-150U	H2014081803	-40~+150°C	Jul. 07, 2022	Oct. 29, 2022~ Nov. 24, 2022	Jul. 06, 2023	Conducted (TH01-SZ)
EMI Test Receiver&SA	KEYSIGHT	N9038A	MY54450083	20Hz~8.4GHz	Apr. 06, 2022	Nov.15, 2022	Apr. 05, 2023	Radiation (03CH03-SZ)
Loop Antenna	R&S	HFH2-Z2	100354	9kHz~30MHz	Jun. 28, 2022	Nov.15, 2022	Jun. 27, 2024	Radiation (03CH03-SZ)
EXA Spectrum Analyzer	KEYSIGHT	N9010A	MY55150246	10Hz~44GHz;	Apr. 06, 2022	Nov.15, 2022	Apr. 05, 2023	Radiation (03CH03-SZ)
Bilog Antenna	TeseQ	CBL6112D	35408	30MHz-2GHz	Aug. 09, 2021	Nov.15, 2022	Aug. 08, 2023	Radiation (03CH03-SZ)
Double Ridge Horn Antenna	SCHWARZBECK	BBHA9120D	9120D-1355	1GHz~18GHz	Apr. 08, 2022	Nov.15, 2022	Apr. 07, 2023	Radiation (03CH03-SZ)
Amplifier	Burgeon	BPA-530	102211	0.01Hz ~3000MHz	Oct. 19, 2022	Nov.15, 2022	Oct. 18, 2023	Radiation (03CH03-SZ)
HF Amplifier	MITEQ	TTA1840-35 -HG	1871923	18GHz~40GHz	Jul. 06, 2022	Nov.15, 2022	Jul. 05, 2023	Radiation (03CH03-SZ)
SHF-EHF Horn	com-power	AH-840	101071	18Ghz-40GHz	Apr. 10, 2022	Nov.15, 2022	Apr. 09, 2023	Radiation (03CH03-SZ)
Amplifier	Agilent Technologies	83017A	MY39501302	500MHz~26.5GHz	Dec. 27,2021	Nov.15, 2022	Dec. 26,2022	Radiation (03CH03-SZ)
AC Power Source	Chroma	61601	616010002729	N/A	Nov. 10, 2022	Nov.15, 2022	Nov. 09, 2023	Radiation (03CH03-SZ)
Turn Table	EM	EM1000	N/A	0~360 degree	NCR	Nov.15, 2022	NCR	Radiation (03CH03-SZ)
Antenna Mast	EM	EM1000	N/A	1 m~4 m	NCR	Nov.15, 2022	NCR	Radiation (03CH03-SZ)

NCR: No Calibration Required



6 Uncertainty of Evaluation

The measurement uncertainties shown below were calculated in accordance with the requirements of ANSI 63.26-2015. All the measurement uncertainty value were shown with a coverage K=2 to indicate 95% level of confidence. The measurement data show herein meets or exceeds the CISPR measurement uncertainty values specified in CISPR 16-4-2 and can be compared directly to specified limit to determine compliance.

Uncertainty of Conducted Measurement

Test Item	Uncertainty
Conducted Power	±1.34 dB
Conducted Emissions	±1.34 dB
Occupied Channel Bandwidth	±1.2 %

Uncertainty of Radiated Emission Measurement (30 MHz ~ 1000 MHz)

Measuring Uncertainty for a Level of Confidence of 95% (U = 2Uc(y))	3.0dB
---	-------

Uncertainty of Radiated Emission Measurement (1 GHz ~ 18 GHz)

Measuring Uncertainty for a Level of Confidence of 95% (U = 2Uc(y))	3.60dB
---	--------

Uncertainty of Radiated Emission Measurement (18 GHz ~ 40 GHz)

Measuring Uncertainty for a Level of Confidence of 95% (U = 2Uc(y))	4.80dB
---	--------

----- THE END -----



Appendix A. Test Results of Conducted Test

Test Engineer :	Jung Kuo	Temperature :	22~23°C
		Relative Humidity :	40~42%

FR1 N7-Ant 1

Transmitter Conducted Output Power And ERP/EIRP, (G_T - L_C)=-2.08dB

NR Band	SCS (kHz)	Bandwidth (MHz)	Arfcn	Freq (MHz)	Modulation	RB	Conducted Power(dBm)	EIRP (dBm)	EIRP (W)
7	15	5	500500	2502.5	DFT-s-OFDM QPSK	1@1	23.15	21.07	0.1279
7	15	5	500500	2502.5	DFT-s-OFDM 16 QAM	1@1	22.33	20.25	0.1059
7	15	5	507000	2535.0	DFT-s-OFDM QPSK	1@1	23.66	21.58	0.1439
7	15	5	507000	2535.0	DFT-s-OFDM 16 QAM	1@1	22.73	20.65	0.1161
7	15	5	513500	2567.5	DFT-s-OFDM QPSK	1@1	23.75	21.67	0.1469
7	15	5	513500	2567.5	DFT-s-OFDM 16 QAM	1@1	22.67	20.59	0.1146
7	15	10	501000	2505.0	DFT-s-OFDM QPSK	1@1	23.39	21.31	0.1352
7	15	10	501000	2505.0	DFT-s-OFDM 16 QAM	1@1	22.37	20.29	0.1069
7	15	10	507000	2535.0	DFT-s-OFDM QPSK	1@1	23.62	21.54	0.1426
7	15	10	507000	2535.0	DFT-s-OFDM 16 QAM	1@1	22.76	20.68	0.1169
7	15	10	513000	2565.0	DFT-s-OFDM QPSK	1@1	23.6	21.52	0.1419
7	15	10	513000	2565.0	DFT-s-OFDM 16 QAM	1@1	22.67	20.59	0.1146
7	15	15	501500	2507.5	DFT-s-OFDM QPSK	1@1	23.34	21.26	0.1337
7	15	15	501500	2507.5	DFT-s-OFDM 16 QAM	1@1	22.37	20.29	0.1069
7	15	15	507000	2535.0	DFT-s-OFDM QPSK	1@1	23.94	21.86	0.1535
7	15	15	507000	2535.0	DFT-s-OFDM 16 QAM	1@1	23.03	20.95	0.1245
7	15	15	512500	2562.5	DFT-s-OFDM QPSK	1@1	23.78	21.7	0.1479
7	15	15	512500	2562.5	DFT-s-OFDM 16 QAM	1@1	22.79	20.71	0.1178
7	15	20	502000	2510.0	DFT-s-OFDM QPSK	1@1	23.39	21.31	0.1352

7	15	20	502000	2510.0	DFT-s-OFDM 16 QAM	1@1	22.42	20.34	0.1081
7	15	20	507000	2510.0	DFT-s-OFDM QPSK	1@1	23.77	21.69	0.1476
7	15	20	507000	2535.0	DFT-s-OFDM 16 QAM	1@1	23	20.92	0.1236
7	15	20	512000	2560.0	DFT-s-OFDM QPSK	1@1	23.79	21.71	0.1483
7	15	20	512000	2560.0	DFT-s-OFDM 16 QAM	1@1	22.84	20.76	0.1191
7	15	25	502500	2512.5	DFT-s-OFDM QPSK	1@1	23.85	21.77	0.1503
7	15	25	502500	2512.5	DFT-s-OFDM 16 QAM	1@1	22.87	20.79	0.1199
7	15	25	507000	2535.0	DFT-s-OFDM QPSK	1@1	23.92	21.84	0.1528
7	15	25	507000	2535.0	DFT-s-OFDM 16 QAM	1@1	23	20.92	0.1236
7	15	25	511500	2557.5	DFT-s-OFDM QPSK	1@1	23.83	21.75	0.1496
7	15	25	511500	2557.5	DFT-s-OFDM 16 QAM	1@1	22.94	20.86	0.1219
7	15	30	503000	2515.0	DFT-s-OFDM QPSK	1@1	23.79	21.71	0.1483
7	15	30	503000	2515.0	DFT-s-OFDM 16 QAM	1@1	22.8	20.72	0.1180
7	15	30	507000	2515.0	DFT-s-OFDM QPSK	1@1	23.7	21.62	0.1452
7	15	30	507000	2535.0	DFT-s-OFDM 16 QAM	1@1	22.94	20.86	0.1219
7	15	30	511000	2555.0	DFT-s-OFDM QPSK	1@1	23.95	21.87	0.1538
7	15	30	511000	2555.0	DFT-s-OFDM 16 QAM	1@1	23.12	21.04	0.1271
7	15	40	504000	2520.0	DFT-s-OFDM PI/2 BPSK	108@54	23.97	21.89	0.1545
7	15	40	504000	2520.0	DFT-s-OFDM PI/2 BPSK	1@1	23.43	21.35	0.1365
7	15	40	504000	2520.0	DFT-s-OFDM PI/2 BPSK	1@214	23.89	21.81	0.1517
7	15	40	504000	2520.0	DFT-s-OFDM QPSK	108@54	23.98	21.9	0.1549
7	15	40	504000	2520.0	DFT-s-OFDM QPSK	1@1	23.97	21.89	0.1545
7	15	40	504000	2520.0	DFT-s-OFDM QPSK	1@214	23.96	21.88	0.1542
7	15	40	504000	2520.0	DFT-s-OFDM 16 QAM	108@54	22.98	20.9	0.1230

7	15	40	504000	2520.0	DFT-s-OFDM 16 QAM	1@1	22.82	20.74	0.1186
7	15	40	504000	2520.0	DFT-s-OFDM 16 QAM	1@214	22.99	20.91	0.1233
7	15	40	504000	2520.0	DFT-s-OFDM 64 QAM	108@54	21.48	19.4	0.0871
7	15	40	504000	2520.0	DFT-s-OFDM 64 QAM	1@1	21.42	19.34	0.0859
7	15	40	504000	2520.0	DFT-s-OFDM 64 QAM	1@214	21.59	19.51	0.0893
7	15	40	504000	2520.0	DFT-s-OFDM 256 QAM	108@54	19.39	17.31	0.0538
7	15	40	504000	2520.0	DFT-s-OFDM 256 QAM	1@1	19.1	17.02	0.0504
7	15	40	504000	2520.0	DFT-s-OFDM 256 QAM	1@214	19.21	17.13	0.0516
7	15	40	504000	2520.0	CP-OFDM QPSK	108@54	22.4	20.32	0.1076
7	15	40	504000	2520.0	CP-OFDM QPSK	1@1	22.11	20.03	0.1007
7	15	40	504000	2520.0	CP-OFDM QPSK	1@214	22.51	20.43	0.1104
7	15	40	507000	2535.0	DFT-s-OFDM PI/2 BPSK	108@54	23.96	21.88	0.1542
7	15	40	507000	2535.0	DFT-s-OFDM PI/2 BPSK	1@1	23.88	21.8	0.1514
7	15	40	507000	2535.0	DFT-s-OFDM PI/2 BPSK	1@214	23.86	21.78	0.1507
7	15	40	507000	2535.0	DFT-s-OFDM QPSK	108@54	23.94	21.86	0.1535
7	15	40	507000	2535.0	DFT-s-OFDM QPSK	1@1	23.99	21.91	0.1552
7	15	40	507000	2535.0	DFT-s-OFDM QPSK	1@214	23.88	21.8	0.1514
7	15	40	507000	2535.0	DFT-s-OFDM 16 QAM	108@54	22.99	20.91	0.1233
7	15	40	507000	2535.0	DFT-s-OFDM 16 QAM	1@1	23.11	21.03	0.1268
7	15	40	507000	2535.0	DFT-s-OFDM 16 QAM	1@214	23.07	20.99	0.1256
7	15	40	507000	2535.0	DFT-s-OFDM 64 QAM	108@54	21.48	19.4	0.0871
7	15	40	507000	2535.0	DFT-s-OFDM 64 QAM	1@1	21.51	19.43	0.0877
7	15	40	507000	2535.0	DFT-s-OFDM 64 QAM	1@214	21.66	19.58	0.0908
7	15	40	507000	2535.0	DFT-s-OFDM 256 QAM	108@54	19.25	17.17	0.0521

7	15	40	507000	2535.0	DFT-s-OFDM 256 QAM	1@1	19.17	17.09	0.0512
7	15	40	507000	2535.0	DFT-s-OFDM 256 QAM	1@214	19.27	17.19	0.0524
7	15	40	507000	2535.0	CP-OFDM QPSK	108@54	22.37	20.29	0.1069
7	15	40	507000	2535.0	CP-OFDM QPSK	1@1	22.51	20.43	0.1104
7	15	40	507000	2535.0	CP-OFDM QPSK	1@214	22.34	20.26	0.1062
7	15	40	510000	2550.0	DFT-s-OFDM PI/2 BPSK	108@54	23.95	21.87	0.1538
7	15	40	510000	2550.0	DFT-s-OFDM PI/2 BPSK	1@1	23.93	21.85	0.1531
7	15	40	510000	2550.0	DFT-s-OFDM PI/2 BPSK	1@214	23.95	21.87	0.1538
7	15	40	510000	2550.0	DFT-s-OFDM QPSK	108@54	23.96	21.88	0.1542
7	15	40	510000	2550.0	DFT-s-OFDM QPSK	1@1	23.95	21.87	0.1538
7	15	40	510000	2550.0	DFT-s-OFDM QPSK	1@214	23.93	21.85	0.1531
7	15	40	510000	2550.0	DFT-s-OFDM 16 QAM	108@54	23.04	20.96	0.1247
7	15	40	510000	2550.0	DFT-s-OFDM 16 QAM	1@1	23.12	21.04	0.1271
7	15	40	510000	2550.0	DFT-s-OFDM 16 QAM	1@214	23.09	21.01	0.1262
7	15	40	510000	2550.0	DFT-s-OFDM 64 QAM	108@54	21.51	19.43	0.0877
7	15	40	510000	2550.0	DFT-s-OFDM 64 QAM	1@1	21.68	19.6	0.0912
7	15	40	510000	2550.0	DFT-s-OFDM 64 QAM	1@214	21.56	19.48	0.0887
7	15	40	510000	2550.0	DFT-s-OFDM 256 QAM	108@54	19.51	17.43	0.0553
7	15	40	510000	2550.0	DFT-s-OFDM 256 QAM	1@1	19.26	17.18	0.0522
7	15	40	510000	2550.0	DFT-s-OFDM 256 QAM	1@214	19.28	17.2	0.0525
7	15	40	510000	2550.0	CP-OFDM QPSK	108@54	22.42	20.34	0.1081
7	15	40	510000	2550.0	CP-OFDM QPSK	1@1	22.59	20.51	0.1125
7	15	40	510000	2550.0	CP-OFDM QPSK	1@214	22.57	20.49	0.1119

Frequency Stability

NR Band	SCS (kHz)	Bandwidth (MHz)	Arfcn	Freq (MHz)	Modulation	RB	Deviation (ppm)	Verdict	Environment
7	15	20	507000	2535.0	DFT-s-OFDM QPSK	100@0	0.0028	PASS	NV
7	15	20	507000	2535.0	DFT-s-OFDM QPSK	100@0	0.0055	PASS	LV
7	15	20	507000	2535.0	DFT-s-OFDM QPSK	100@0	0.0068	PASS	HV
7	15	20	507000	2535.0	DFT-s-OFDM QPSK	100@0	0.0058	PASS	-30°C
7	15	20	507000	2535.0	DFT-s-OFDM QPSK	100@0	0.0054	PASS	-20°C
7	15	20	507000	2535.0	DFT-s-OFDM QPSK	100@0	0.0021	PASS	-10°C
7	15	20	507000	2535.0	DFT-s-OFDM QPSK	100@0	0.0034	PASS	0°C
7	15	20	507000	2535.0	DFT-s-OFDM QPSK	100@0	0.0039	PASS	10°C
7	15	20	507000	2535.0	DFT-s-OFDM QPSK	100@0	0.0028	PASS	20°C
7	15	20	507000	2535.0	DFT-s-OFDM QPSK	100@0	0.0058	PASS	30°C
7	15	20	507000	2535.0	DFT-s-OFDM QPSK	100@0	0.0060	PASS	40°C
7	15	20	507000	2535.0	DFT-s-OFDM QPSK	100@0	0.0030	PASS	50°C

Peak to Average Ratio

NR Band	SCS (kHz)	Bandwidth (MHz)	Arfcn	Freq (MHz)	Modulation	RB	Result (dB)	Limit (dB)	Verdict
7	15	20	502000	2510.0	DFT-s-OFDM PI/2 BPSK	100@0	4.7	13	PASS
7	15	20	502000	2510.0	DFT-s-OFDM PI/2 BPSK	1@0	5.18	13	PASS
7	15	20	502000	2510.0	DFT-s-OFDM QPSK	100@0	5.41	13	PASS
7	15	20	502000	2510.0	DFT-s-OFDM QPSK	1@0	6.06	13	PASS
7	15	20	507000	2535.0	DFT-s-OFDM PI/2 BPSK	100@0	4.87	13	PASS
7	15	20	507000	2535.0	DFT-s-OFDM PI/2 BPSK	1@0	4.14	13	PASS
7	15	20	507000	2535.0	DFT-s-OFDM QPSK	100@0	4.57	13	PASS
7	15	20	507000	2535.0	DFT-s-OFDM QPSK	1@0	4.17	13	PASS
7	15	20	512000	2560.0	DFT-s-OFDM PI/2 BPSK	100@0	4.67	13	PASS
7	15	20	512000	2560.0	DFT-s-OFDM PI/2 BPSK	1@0	4.05	13	PASS
7	15	20	512000	2560.0	DFT-s-OFDM QPSK	100@0	5.66	13	PASS
7	15	20	512000	2560.0	DFT-s-OFDM QPSK	1@0	4.1	13	PASS

N7(20M)_DFT-s-OFDM_PI_2-BPSK_Outer_Full_Low_CH



N7(20M)_DFT-s-OFDM_PI_2-BPSK_Edge_1RB_Left_Low_CH



N7(20M)_DFT-s-OFDM_QPSK_Outer_Full_Low_CH



N7(20M)_DFT-s-OFDM_QPSK_Edge_1RB_Left_Low_CH



N7(20M)_DFT-s-OFDM_PI_2-BPSK_Outer_Full_Mid_CH



N7(20M)_DFT-s-OFDM_PI_2-BPSK_Edge_1RB_Left_Mid_CH



N7(20M)_DFT-s-OFDM_QPSK_Outer_Full_Mid_CH



N7(20M)_DFT-s-OFDM_QPSK_Edge_1RB_Left_Mid_CH



N7(20M)_DFT-s-OFDM_PI_2-BPSK_Outer_Full_High_CH

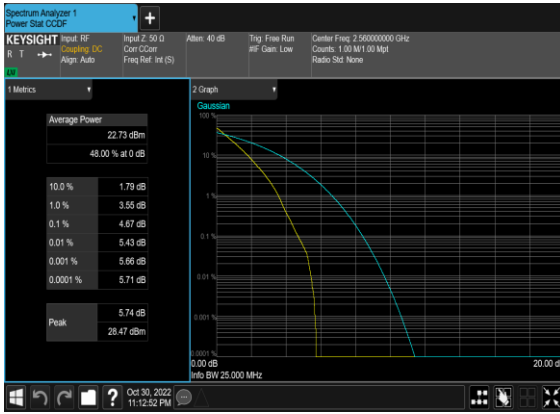

N7(20M)_DFT-s-OFDM_PI_2-BPSK_Edge_1RB_Left_High_CH



N7(20M)_DFT-s-OFDM_QPSK_Outer_Full_High_CH



N7(20M)_DFT-s-OFDM_QPSK_Edge_1RB_Left_High_CH



Occupied Bandwidth

NR Band	SCS (kHz)	Bandwidth (MHz)	Arfcn	Freq (MHz)	Modulation	RB	OBW (MHz)	26dB OBW (MHz)
7	15	5	507000	2535.0	DFT-s-OFDM PI/2 BPSK	25@0	4.4844	4.95
7	15	5	507000	2535.0	DFT-s-OFDM QPSK	25@0	4.4895	5.104
7	15	5	507000	2535.0	CP-OFDM QPSK	25@0	4.475	5.054
7	15	5	507000	2535.0	CP-OFDM 16 QAM	25@0	4.5018	5.229
7	15	5	507000	2535.0	CP-OFDM 64 QAM	25@0	4.4627	5.015
7	15	5	507000	2535.0	CP-OFDM 256 QAM	25@0	4.485	5.057
7	15	10	507000	2535.0	DFT-s-OFDM PI/2 BPSK	50@0	8.9026	9.573
7	15	10	507000	2535.0	DFT-s-OFDM QPSK	50@0	8.9254	9.708
7	15	10	507000	2535.0	CP-OFDM QPSK	52@0	9.2751	10.1
7	15	10	507000	2535.0	CP-OFDM 16 QAM	52@0	9.2861	10.01
7	15	10	507000	2535.0	CP-OFDM 64 QAM	52@0	9.2752	10.03
7	15	10	507000	2535.0	CP-OFDM 256 QAM	52@0	9.2827	10.07
7	15	15	507000	2535.0	DFT-s-OFDM PI/2 BPSK	75@0	13.394	14.4
7	15	15	507000	2535.0	DFT-s-OFDM QPSK	75@0	13.423	14.28
7	15	15	507000	2535.0	CP-OFDM QPSK	79@0	14.093	15.0
7	15	15	507000	2535.0	CP-OFDM 16 QAM	79@0	14.095	14.99
7	15	15	507000	2535.0	CP-OFDM 64 QAM	79@0	14.1	15.04
7	15	15	507000	2535.0	CP-OFDM 256 QAM	79@0	14.08	15.02
7	15	20	507000	2535.0	DFT-s-OFDM PI/2 BPSK	100@0	17.92	18.79
7	15	20	507000	2535.0	DFT-s-OFDM QPSK	100@0	17.856	18.92
7	15	20	507000	2535.0	CP-OFDM QPSK	106@0	18.919	20.01
7	15	20	507000	2535.0	CP-OFDM 16 QAM	106@0	18.934	19.83
7	15	20	507000	2535.0	CP-OFDM 64 QAM	106@0	18.915	19.82
7	15	20	507000	2535.0	CP-OFDM 256 QAM	106@0	18.943	20.0

7	15	25	507000	2535.0	DFT-s-OFDM PI/2 BPSK	128@0	22.852	23.98
7	15	25	507000	2535.0	DFT-s-OFDM QPSK	128@0	22.866	23.95
7	15	25	507000	2535.0	CP-OFDM QPSK	133@0	23.701	24.92
7	15	25	507000	2535.0	CP-OFDM 16 QAM	133@0	23.745	24.81
7	15	25	507000	2535.0	CP-OFDM 64 QAM	133@0	23.768	24.92
7	15	25	507000	2535.0	CP-OFDM 256 QAM	133@0	23.753	24.78
7	15	30	507000	2535.0	DFT-s-OFDM PI/2 BPSK	160@0	28.609	29.83
7	15	30	507000	2535.0	DFT-s-OFDM QPSK	160@0	28.551	29.62
7	15	30	507000	2535.0	CP-OFDM QPSK	160@0	28.565	29.78
7	15	30	507000	2535.0	CP-OFDM 16 QAM	160@0	28.585	29.81
7	15	30	507000	2535.0	CP-OFDM 64 QAM	160@0	28.602	29.8
7	15	30	507000	2535.0	CP-OFDM 256 QAM	160@0	28.547	29.65
7	15	40	507000	2535.0	DFT-s-OFDM PI/2 BPSK	216@0	38.584	40.16
7	15	40	507000	2535.0	DFT-s-OFDM QPSK	216@0	38.484	39.98
7	15	40	507000	2535.0	CP-OFDM QPSK	216@0	38.521	40.09
7	15	40	507000	2535.0	CP-OFDM 16 QAM	216@0	38.56	40.08
7	15	40	507000	2535.0	CP-OFDM 64 QAM	216@0	38.594	40.08
7	15	40	507000	2535.0	CP-OFDM 256 QAM	216@0	38.564	40.02

N7(5M)_DFT-s-OFDM_PI_2-BPSK_Outer_Full_Mid_CH

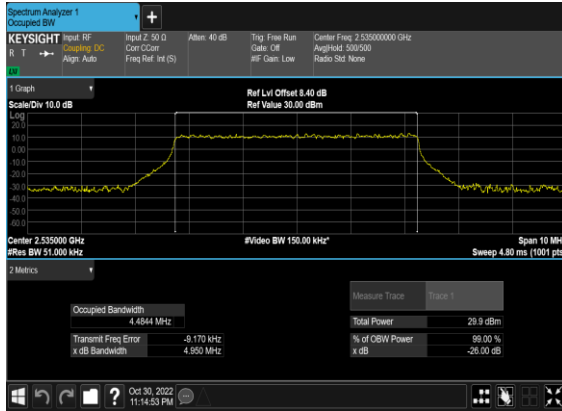

N7(5M)_DFT-s-OFDM_QPSK_Outer_Full_Mid_CH



N7(5M)_CP-OFDM_QPSK_Outer_Full_Mid_CH



N7(5M)_CP-OFDM_16QAM_Outer_Full_Mid_CH



N7(5M)_CP-OFDM_64QAM_Outer_Full_Mid_CH

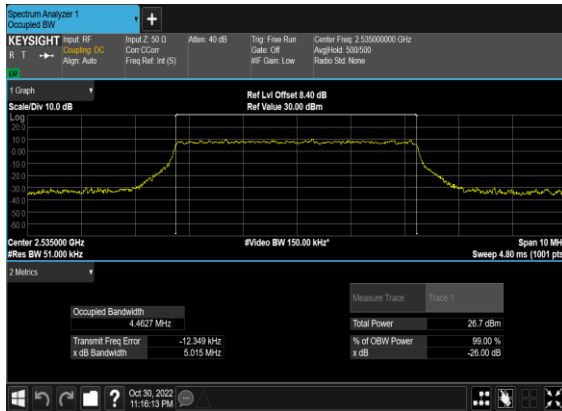

N7(5M)_CP-OFDM_256QAM_Outer_Full_Mid_CH

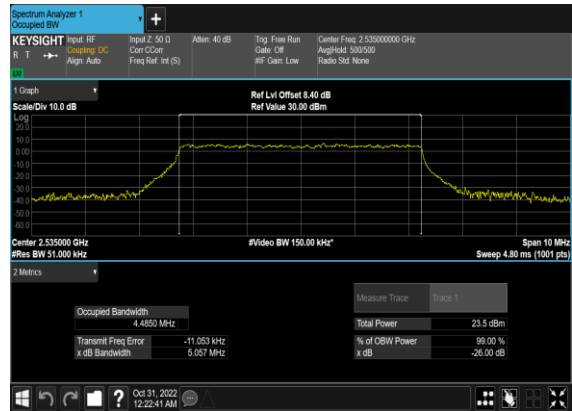

N7(10M)_DFT-s-OFDM_PI_2- BPSK_Outer_Full_Mid_CH

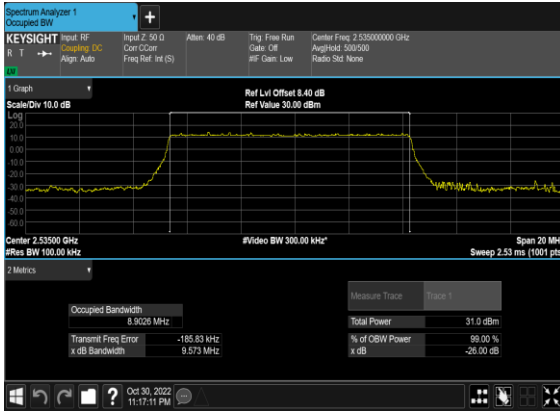

N7(10M)_DFT-s- OFDM_QPSK_Outer_Full_Mid_CH



N7(10M)_CP- OFDM_QPSK_Outer_Full_Mid_CH

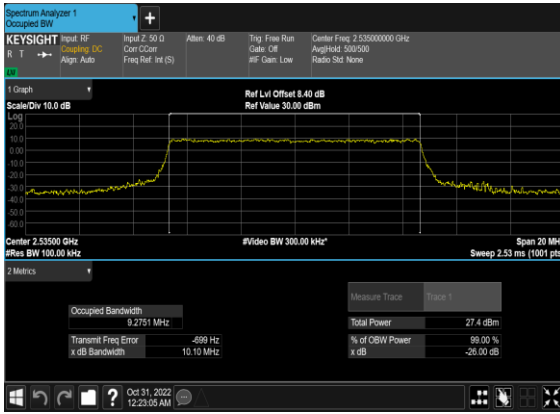

N7(10M)_CP-OFDM_16 QAM_Outer_Full_Mid_CH



N7(10M)_CP-OFDM_64 QAM_Outer_Full_Mid_CH

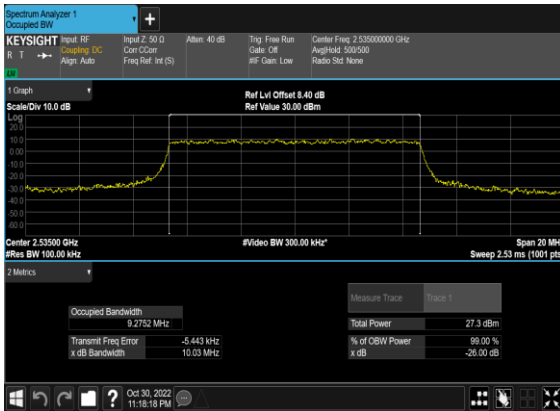

N7(10M)_CP-OFDM_256 QAM_Outer_Full_Mid_CH

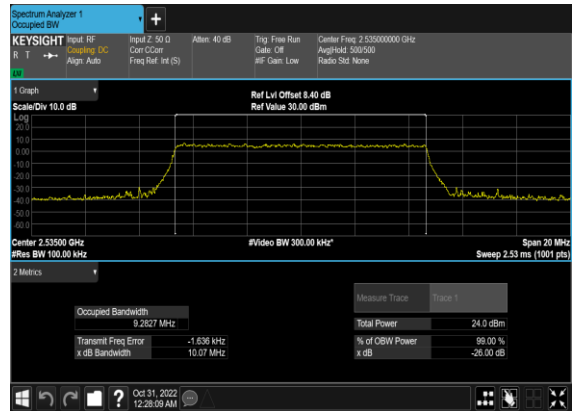

N7(15M)_DFT-s-OFDM_PI_2- BPSK_Outer_Full_Mid_CH

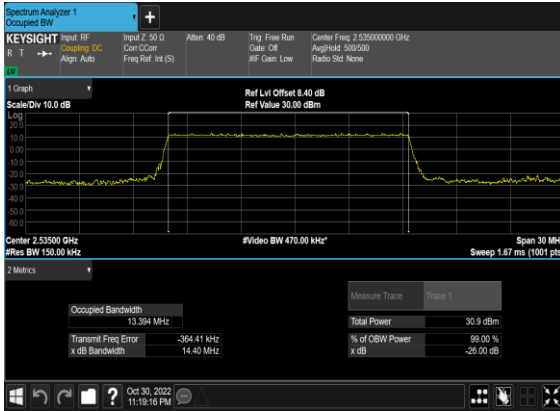

N7(15M)_DFT-s- OFDM_QPSK_Outer_Full_Mid_CH

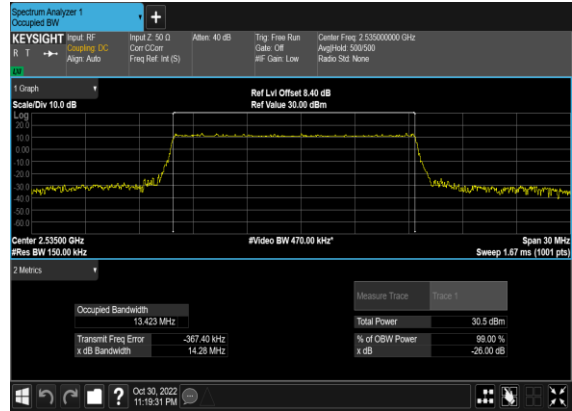

N7(15M)_CP- OFDM_QPSK_Outer_Full_Mid_CH

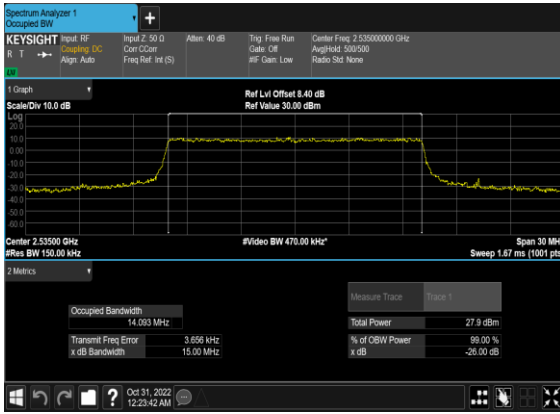

N7(15M)_CP-OFDM_16 QAM_Outer_Full_Mid_CH

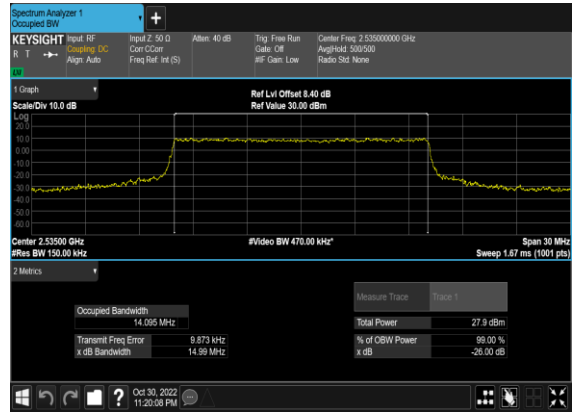

N7(15M)_CP-OFDM_64 QAM_Outer_Full_Mid_CH

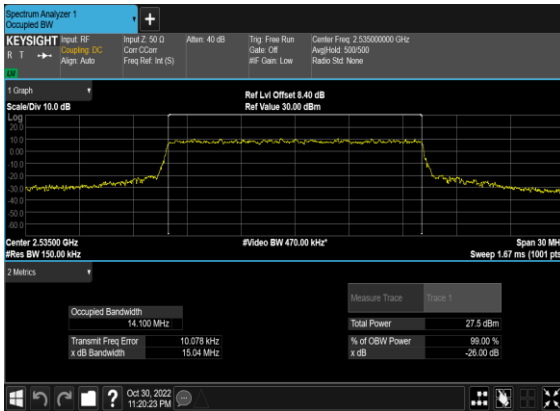

N7(15M)_CP-OFDM_256 QAM_Outer_Full_Mid_CH

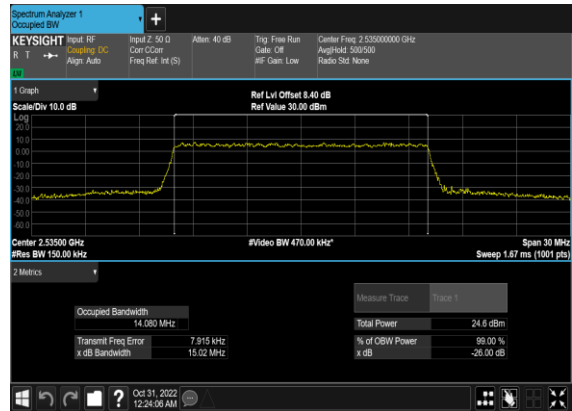

N7(20M)_DFT-s-OFDM_PI_2- BPSK_Outer_Full_Mid_CH

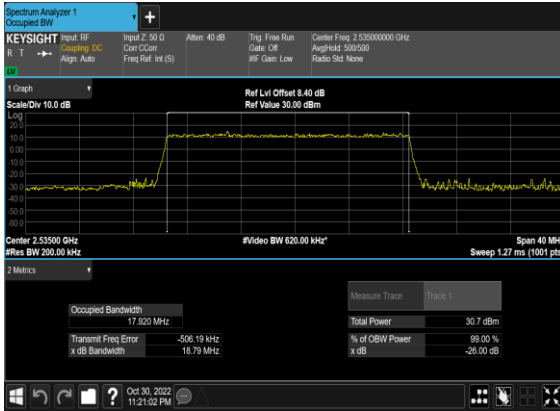

N7(20M)_DFT-s- OFDM_QPSK_Outer_Full_Mid_CH

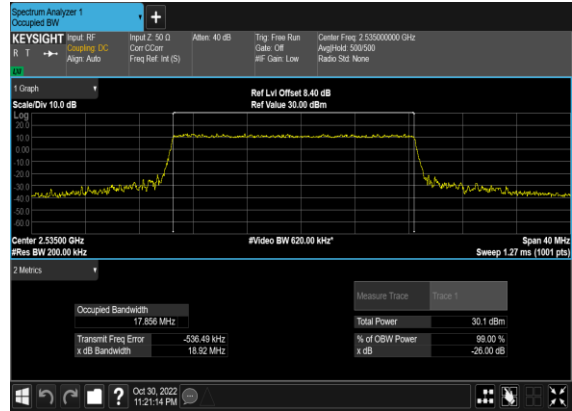

N7(20M)_CP- OFDM_QPSK_Outer_Full_Mid_CH

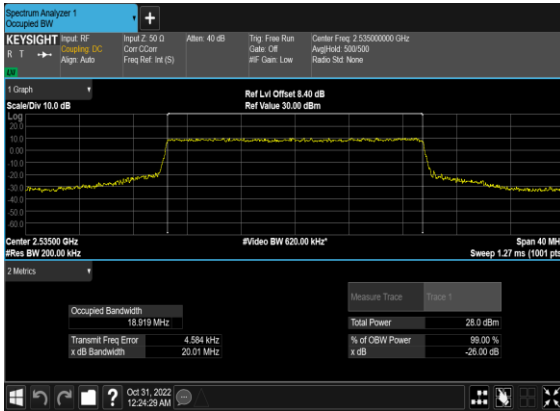

N7(20M)_CP-OFDM_16 QAM_Outer_Full_Mid_CH



N7(20M)_CP-OFDM_64 QAM_Outer_Full_Mid_CH

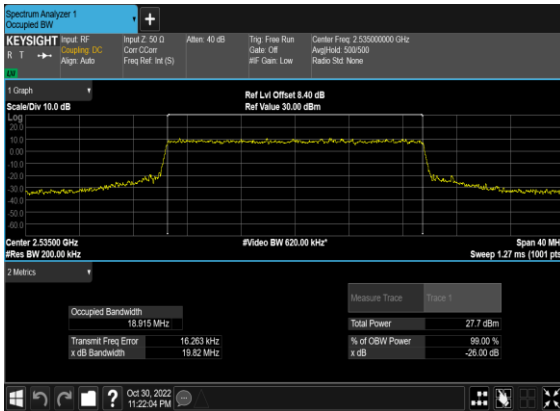

N7(20M)_CP-OFDM_256 QAM_Outer_Full_Mid_CH

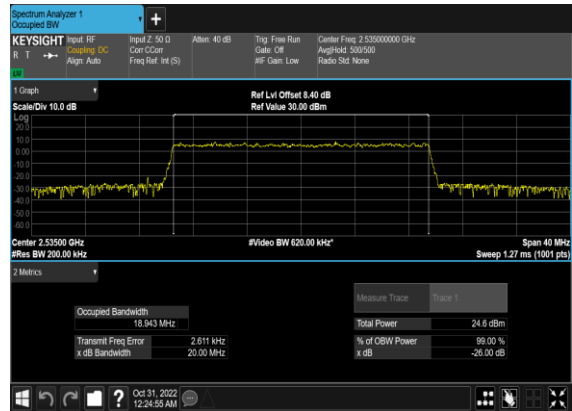

N7(25M)_DFT-s-OFDM_PI_2- BPSK_Outer_Full_Mid_CH

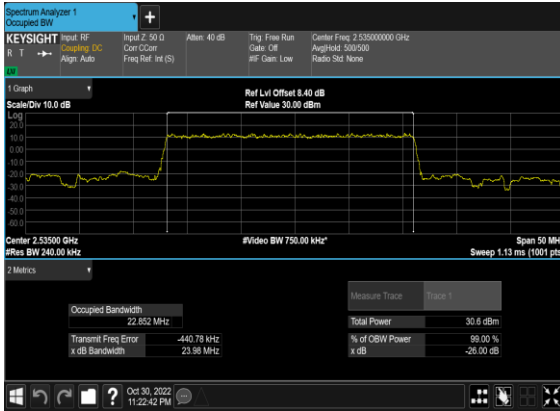

N7(25M)_DFT-s- OFDM_QPSK_Outer_Full_Mid_CH

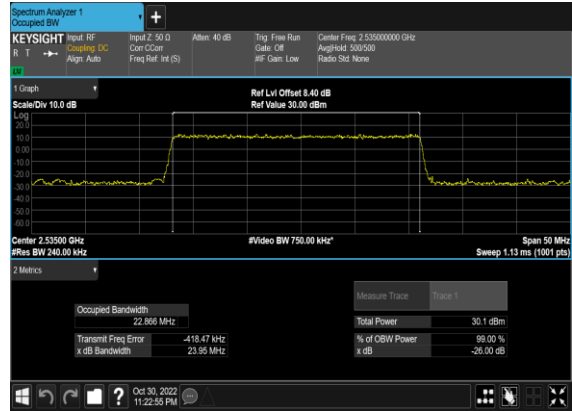

N7(25M)_CP- OFDM_QPSK_Outer_Full_Mid_CH

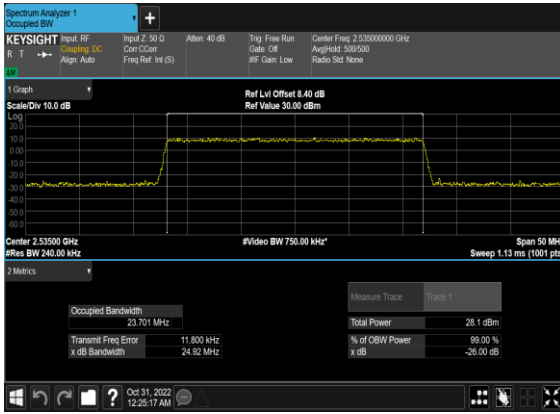

N7(25M)_CP-OFDM_16 QAM_Outer_Full_Mid_CH

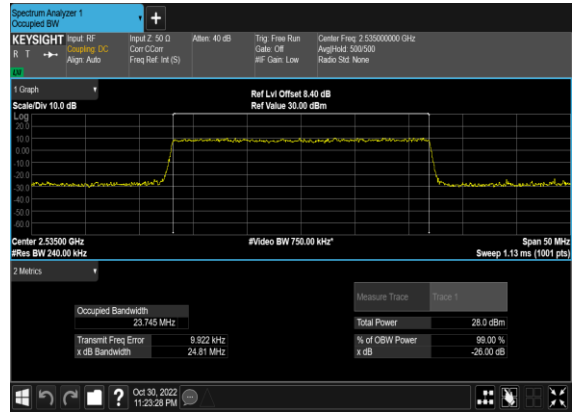

N7(25M)_CP-OFDM_64 QAM_Outer_Full_Mid_CH



N7(25M)_CP-OFDM_256 QAM_Outer_Full_Mid_CH

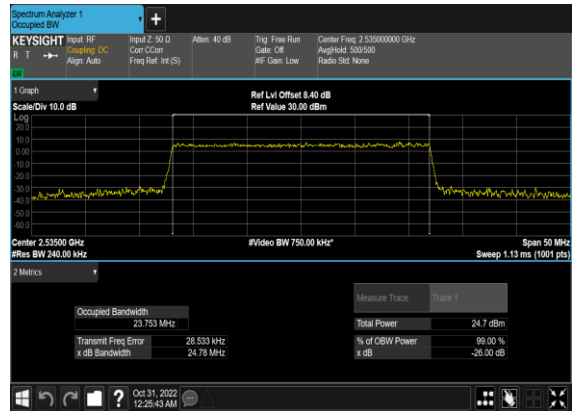

N7(30M)_DFT-s-OFDM_PI_2- BPSK_Outer_Full_Mid_CH

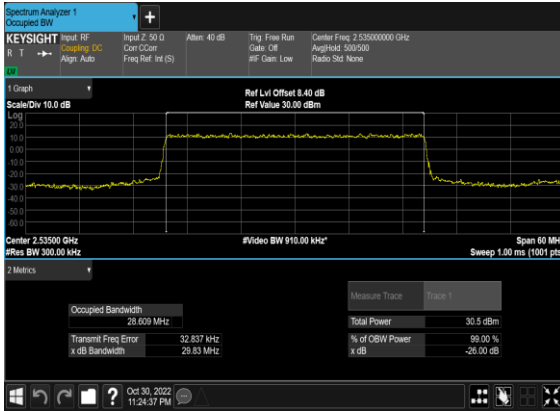

N7(30M)_DFT-s- OFDM_QPSK_Outer_Full_Mid_CH

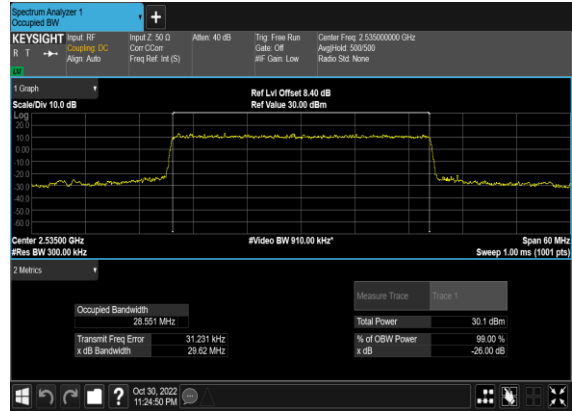

N7(30M)_CP- OFDM_QPSK_Outer_Full_Mid_CH



N7(30M)_CP-OFDM_16 QAM_Outer_Full_Mid_CH



N7(30M)_CP-OFDM_64 QAM_Outer_Full_Mid_CH



N7(30M)_CP-OFDM_256 QAM_Outer_Full_Mid_CH

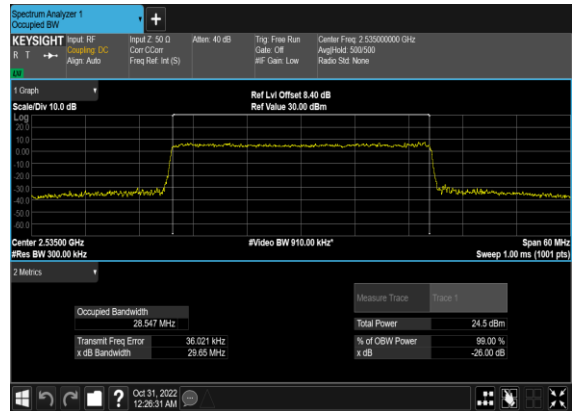

N7(40M)_DFT-s-OFDM_PI_2- BPSK_Outer_Full_Mid_CH

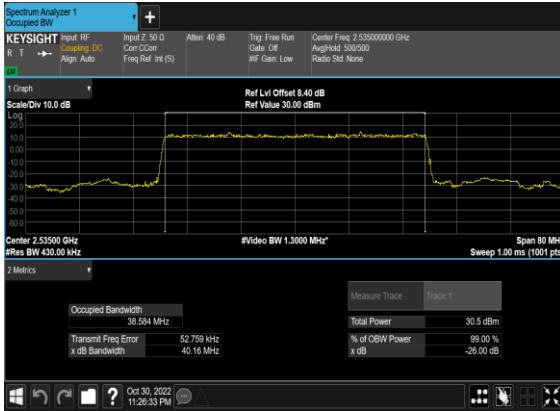

N7(40M)_DFT-s- OFDM_QPSK_Outer_Full_Mid_CH

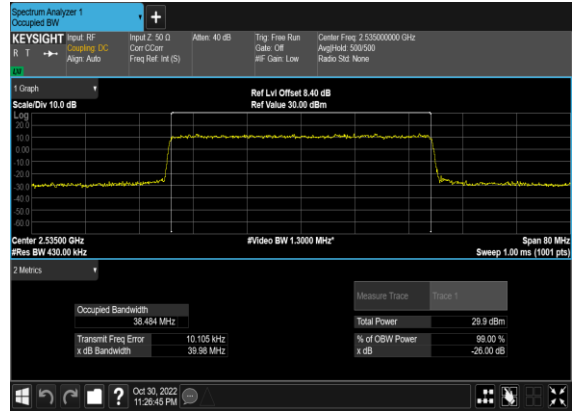

N7(40M)_CP- OFDM_QPSK_Outer_Full_Mid_CH

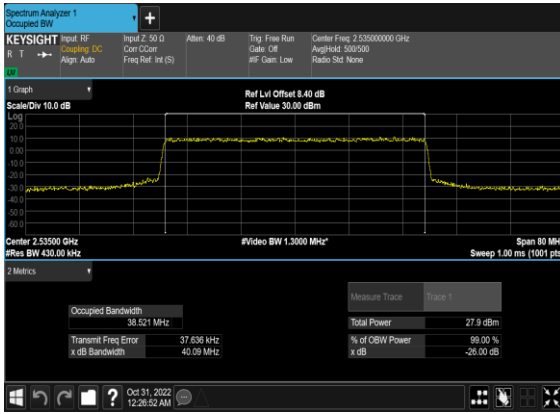

N7(40M)_CP-OFDM_16 QAM_Outer_Full_Mid_CH

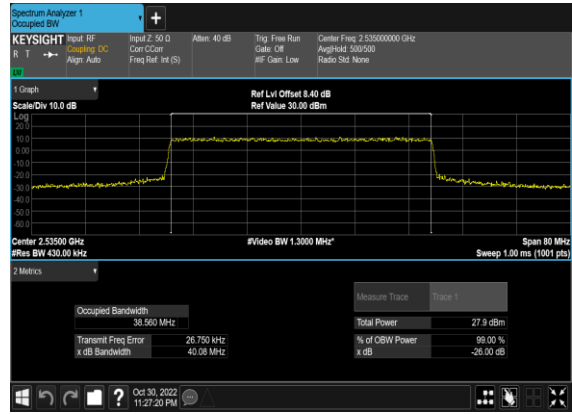

N7(40M)_CP-OFDM_64 QAM_Outer_Full_Mid_CH

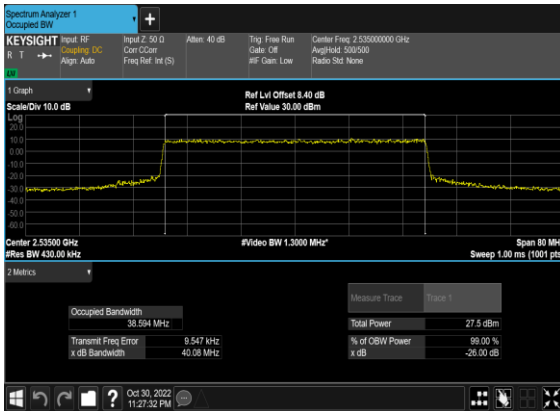

N7(40M)_CP-OFDM_256 QAM_Outer_Full_Mid_CH

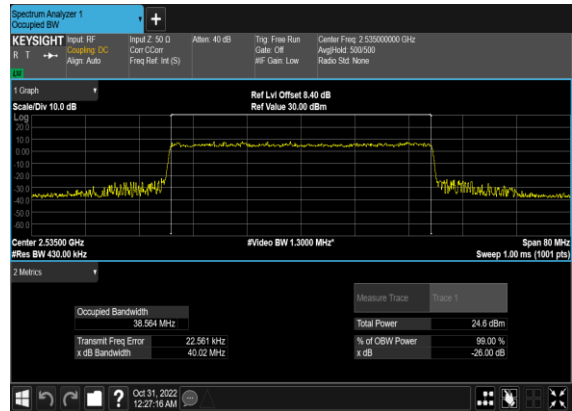

Conducted Spurious Emissions

NR Band	SCS (kHz)	Bandwidth (MHz)	Arfcn	Freq (MHz)	Modulation	RB	Result	Verdict
7	15	5	500500	2502.5	DFT-s-OFDM BPSK	1@0	see graph	---
7	15	5	500500	2502.5	DFT-s-OFDM BPSK	1@0	see graph	PASS
7	15	5	500500	2502.5	DFT-s-OFDM BPSK	1@0	see graph	PASS
7	15	5	500500	2502.5	DFT-s-OFDM QPSK	1@0	see graph	---
7	15	5	500500	2502.5	DFT-s-OFDM QPSK	1@0	see graph	PASS
7	15	5	500500	2502.5	DFT-s-OFDM QPSK	1@0	see graph	PASS
7	15	5	507000	2535.0	DFT-s-OFDM BPSK	1@0	see graph	---
7	15	5	507000	2535.0	DFT-s-OFDM BPSK	1@0	see graph	PASS
7	15	5	507000	2535.0	DFT-s-OFDM BPSK	1@0	see graph	PASS
7	15	5	507000	2535.0	DFT-s-OFDM QPSK	1@0	see graph	---
7	15	5	507000	2535.0	DFT-s-OFDM QPSK	1@0	see graph	PASS
7	15	5	507000	2535.0	DFT-s-OFDM QPSK	1@0	see graph	PASS
7	15	5	513500	2567.5	DFT-s-OFDM BPSK	1@0	see graph	---
7	15	5	513500	2567.5	DFT-s-OFDM BPSK	1@0	see graph	PASS
7	15	5	513500	2567.5	DFT-s-OFDM BPSK	1@0	see graph	PASS
7	15	5	513500	2567.5	DFT-s-OFDM QPSK	1@0	see graph	---
7	15	5	513500	2567.5	DFT-s-OFDM QPSK	1@0	see graph	PASS
7	15	5	513500	2567.5	DFT-s-OFDM QPSK	1@0	see graph	PASS
7	15	20	502000	2510.0	DFT-s-OFDM BPSK	1@0	see graph	---
7	15	20	502000	2510.0	DFT-s-OFDM BPSK	1@0	see graph	PASS
7	15	20	502000	2510.0	DFT-s-OFDM BPSK	1@0	see graph	PASS
7	15	20	502000	2510.0	DFT-s-OFDM QPSK	1@0	see graph	---

7	15	20	502000	2510.0	DFT-s-OFDM QPSK	1@0	see graph	PASS
7	15	20	502000	2510.0	DFT-s-OFDM QPSK	1@0	see graph	PASS
7	15	20	507000	2535.0	DFT-s-OFDM BPSK	1@0	see graph	---
7	15	20	507000	2535.0	DFT-s-OFDM BPSK	1@0	see graph	PASS
7	15	20	507000	2535.0	DFT-s-OFDM BPSK	1@0	see graph	PASS
7	15	20	507000	2535.0	DFT-s-OFDM QPSK	1@0	see graph	---
7	15	20	507000	2535.0	DFT-s-OFDM QPSK	1@0	see graph	PASS
7	15	20	507000	2535.0	DFT-s-OFDM QPSK	1@0	see graph	PASS
7	15	20	512000	2560.0	DFT-s-OFDM BPSK	1@0	see graph	---
7	15	20	512000	2560.0	DFT-s-OFDM BPSK	1@0	see graph	PASS
7	15	20	512000	2560.0	DFT-s-OFDM BPSK	1@0	see graph	PASS
7	15	20	512000	2560.0	DFT-s-OFDM QPSK	1@0	see graph	---
7	15	20	512000	2560.0	DFT-s-OFDM QPSK	1@0	see graph	PASS
7	15	20	512000	2560.0	DFT-s-OFDM QPSK	1@0	see graph	PASS
7	15	40	504000	2520.0	DFT-s-OFDM BPSK	1@0	see graph	---
7	15	40	504000	2520.0	DFT-s-OFDM BPSK	1@0	see graph	PASS
7	15	40	504000	2520.0	DFT-s-OFDM BPSK	1@0	see graph	PASS
7	15	40	504000	2520.0	DFT-s-OFDM QPSK	1@0	see graph	---
7	15	40	504000	2520.0	DFT-s-OFDM QPSK	1@0	see graph	PASS
7	15	40	504000	2520.0	DFT-s-OFDM QPSK	1@0	see graph	PASS
7	15	40	507000	2535.0	DFT-s-OFDM BPSK	1@0	see graph	---
7	15	40	507000	2535.0	DFT-s-OFDM BPSK	1@0	see graph	PASS
7	15	40	507000	2535.0	DFT-s-OFDM BPSK	1@0	see graph	PASS
7	15	40	507000	2535.0	DFT-s-OFDM QPSK	1@0	see graph	---

7	15	40	507000	2535.0	DFT-s-OFDM QPSK	1@0	see graph	PASS
7	15	40	507000	2535.0	DFT-s-OFDM QPSK	1@0	see graph	PASS
7	15	40	510000	2550.0	DFT-s-OFDM BPSK	1@0	see graph	---
7	15	40	510000	2550.0	DFT-s-OFDM BPSK	1@0	see graph	PASS
7	15	40	510000	2550.0	DFT-s-OFDM BPSK	1@0	see graph	PASS
7	15	40	510000	2550.0	DFT-s-OFDM QPSK	1@0	see graph	---
7	15	40	510000	2550.0	DFT-s-OFDM QPSK	1@0	see graph	PASS
7	15	40	510000	2550.0	DFT-s-OFDM QPSK	1@0	see graph	PASS

N7(5M)_DFT-s-OFDM_BPSK_Edge_1RB_Left_Low_CH

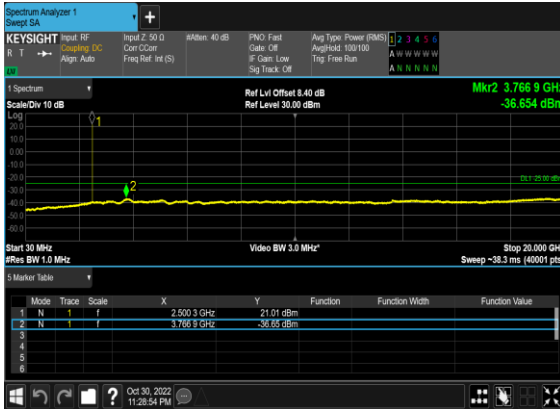

N7(5M)_DFT-s-OFDM_BPSK_Edge_1RB_Left_Low_CH

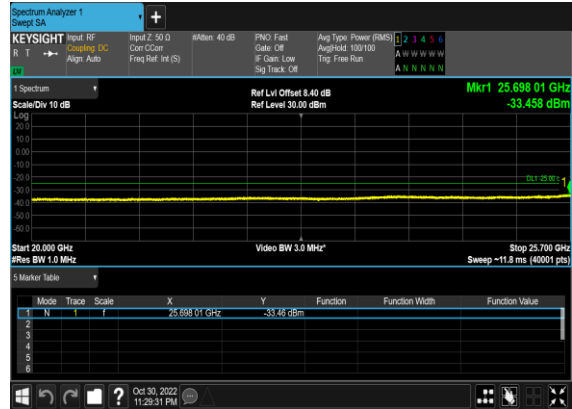

N7(5M)_DFT-s-OFDM_QPSK_Edge_1RB_Left_Low_CH

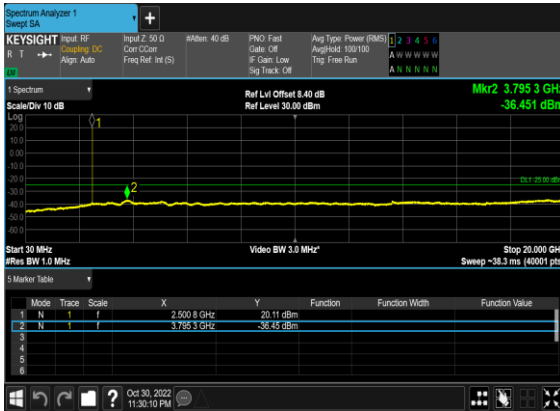

N7(5M)_DFT-s-OFDM_QPSK_Edge_1RB_Left_Low_CH

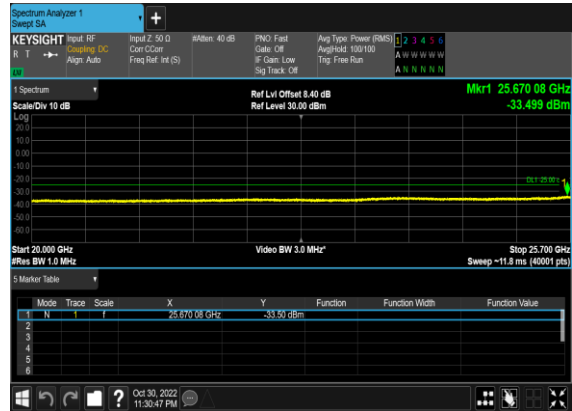

N7(5M)_DFT-s-OFDM_BPSK_Edge_1RB_Left_Mid_CH

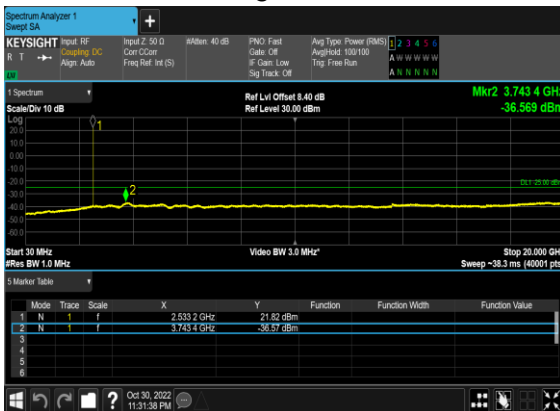

N7(5M)_DFT-s-OFDM_BPSK_Edge_1RB_Left_Mid_CH

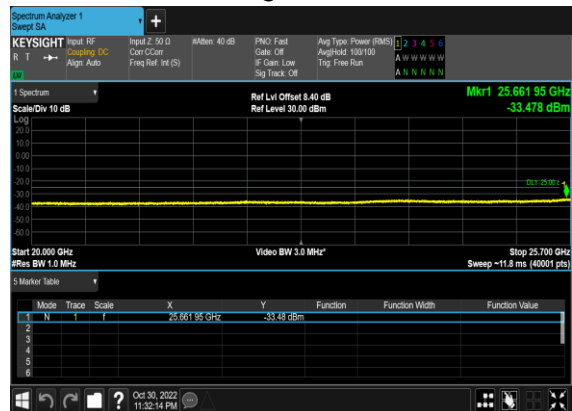

N7(5M)_DFT-s-OFDM_QPSK_Edge_1RB_Left_Mid_CH

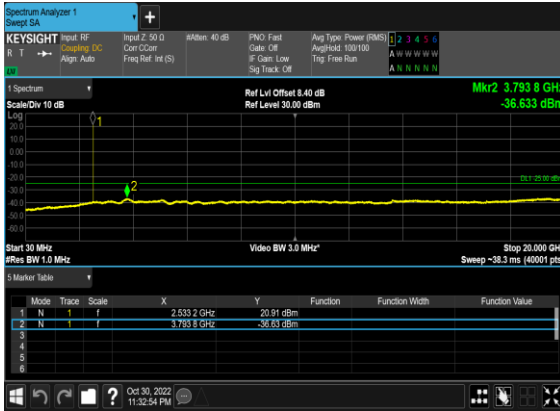

N7(5M)_DFT-s-OFDM_QPSK_Edge_1RB_Left_Mid_CH

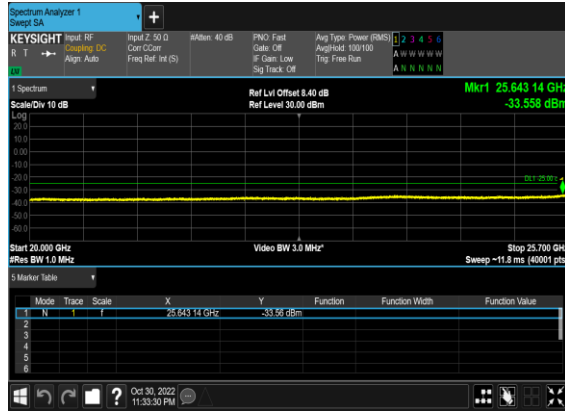

N7(5M)_DFT-s-OFDM_BPSK_Edge_1RB_Left_High_CH

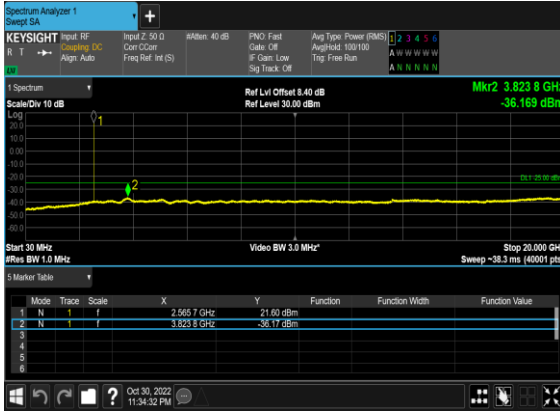

N7(5M)_DFT-s-OFDM_BPSK_Edge_1RB_Left_High_CH

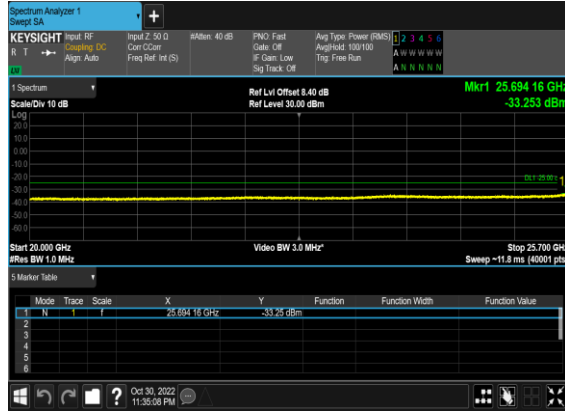

N7(5M)_DFT-s-OFDM_QPSK_Edge_1RB_Left_High_CH

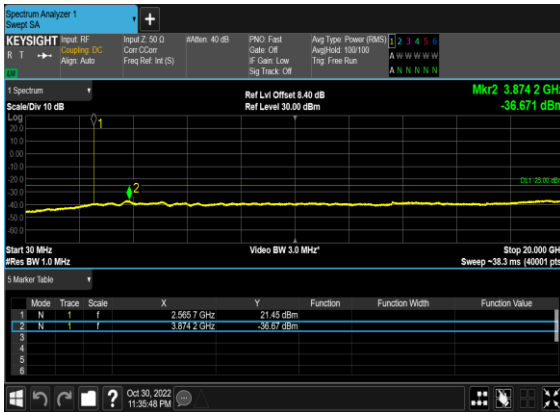

N7(5M)_DFT-s-OFDM_QPSK_Edge_1RB_Left_High_CH

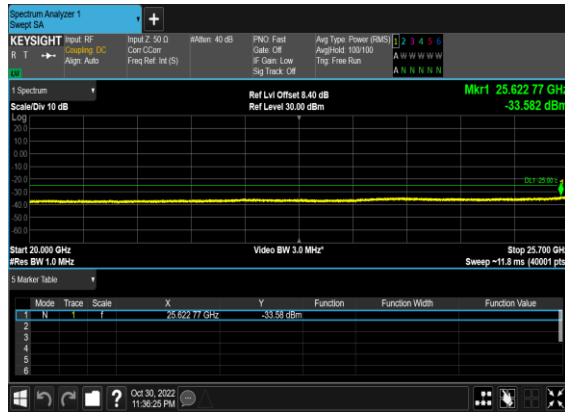

N7(20M)_DFT-s-OFDM_BPSK_Edge_1RB_Left_Low_CH

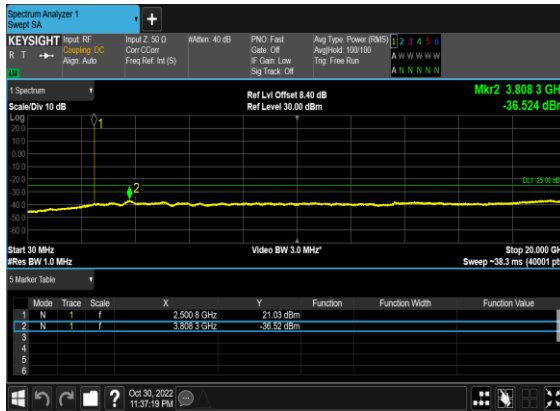

N7(20M)_DFT-s-OFDM_BPSK_Edge_1RB_Left_Low_CH

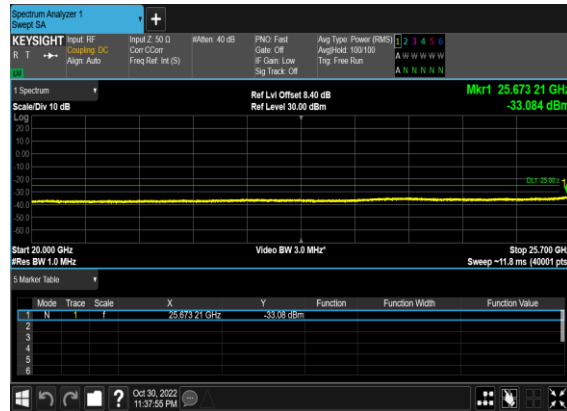

N7(20M)_DFT-s-OFDM_QPSK_Edge_1RB_Left_Low_CH

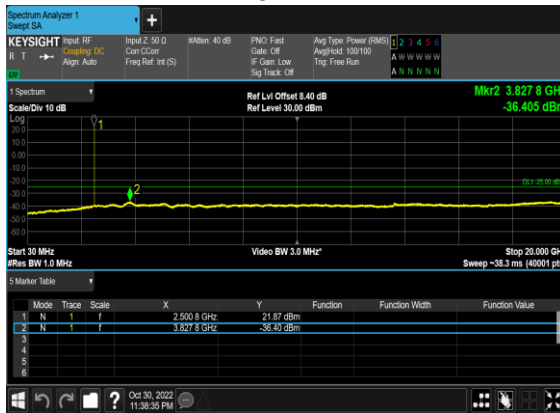

N7(20M)_DFT-s-OFDM_QPSK_Edge_1RB_Left_Low_CH

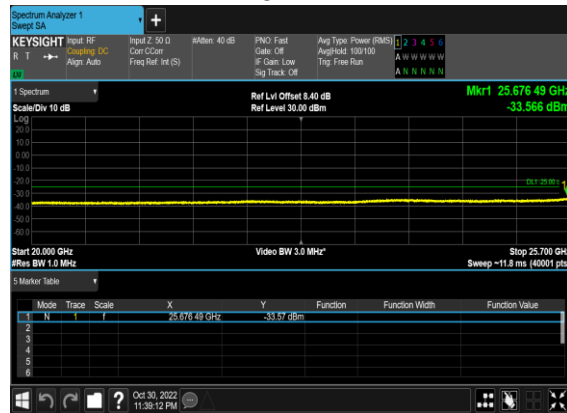

N7(20M)_DFT-s-OFDM_BPSK_Edge_1RB_Left_Mid_CH

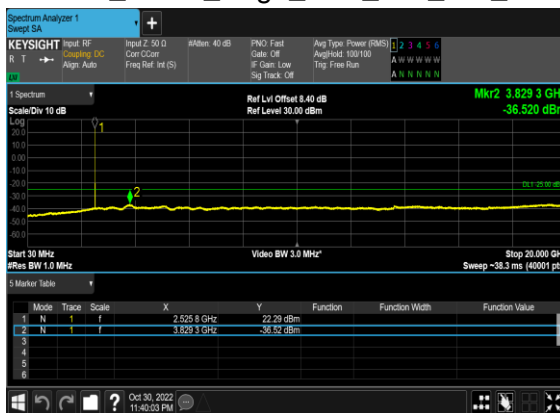

N7(20M)_DFT-s-OFDM_BPSK_Edge_1RB_Left_Mid_CH

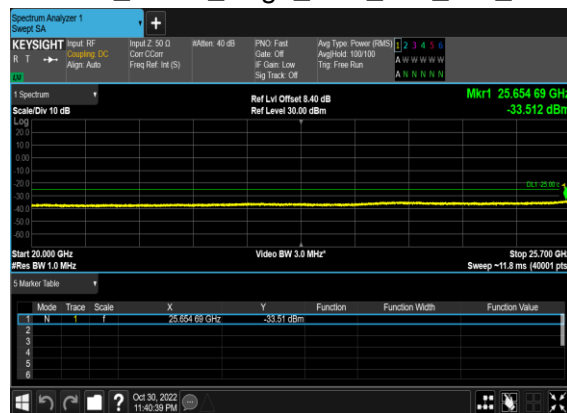

N7(20M)_DFT-s-OFDM_QPSK_Edge_1RB_Left_Mid_CH

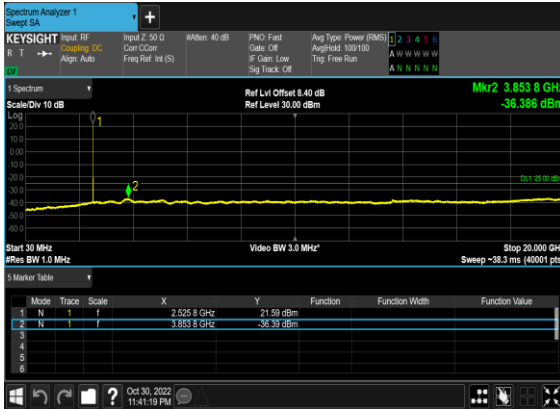

N7(20M)_DFT-s-OFDM_QPSK_Edge_1RB_Left_Mid_CH



N7(20M)_DFT-s-OFDM_BPSK_Edge_1RB_Left_High_CH

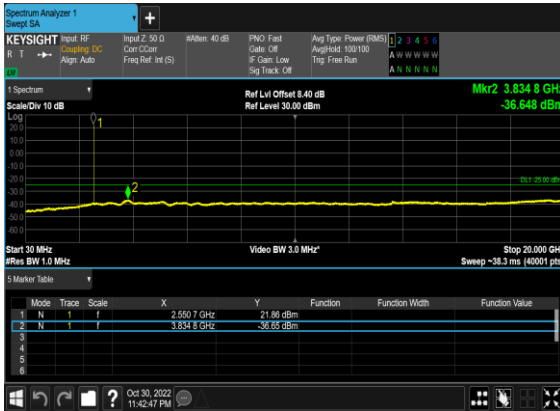

N7(20M)_DFT-s-OFDM_BPSK_Edge_1RB_Left_High_CH

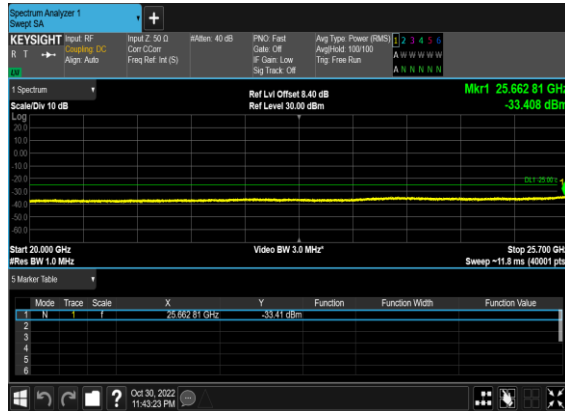

N7(20M)_DFT-s-OFDM_QPSK_Edge_1RB_Left_High_CH

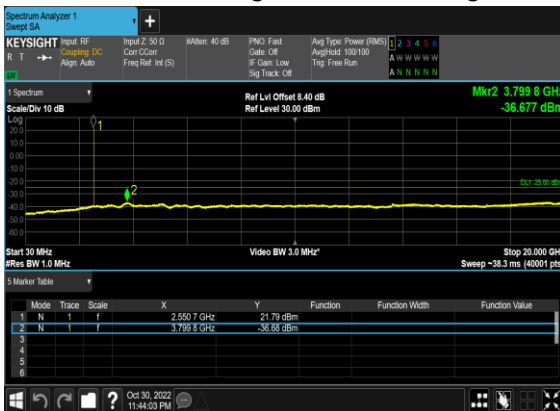

N7(20M)_DFT-s-OFDM_QPSK_Edge_1RB_Left_High_CH

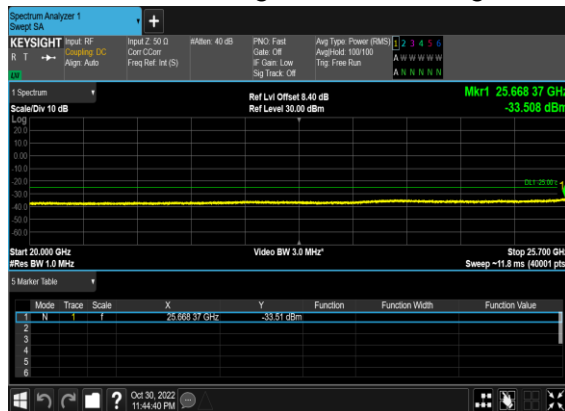

N7(40M)_DFT-s-OFDM_BPSK_Edge_1RB_Left_Low_CH

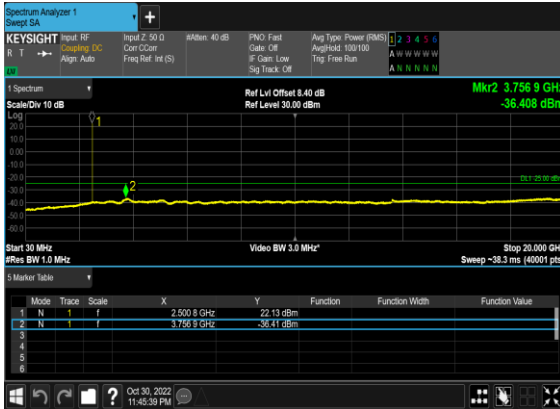

N7(40M)_DFT-s-OFDM_BPSK_Edge_1RB_Left_Low_CH

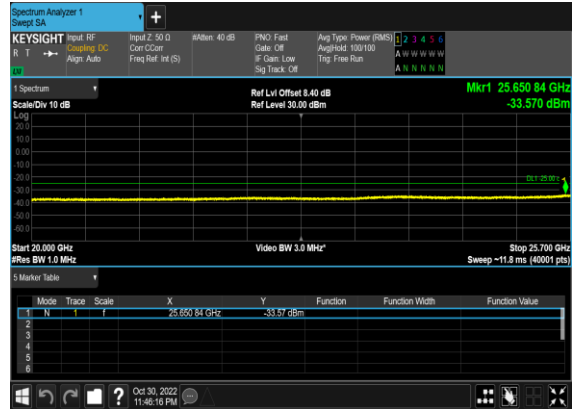

N7(40M)_DFT-s-OFDM_QPSK_Edge_1RB_Left_Low_CH



N7(40M)_DFT-s-OFDM_QPSK_Edge_1RB_Left_Low_CH

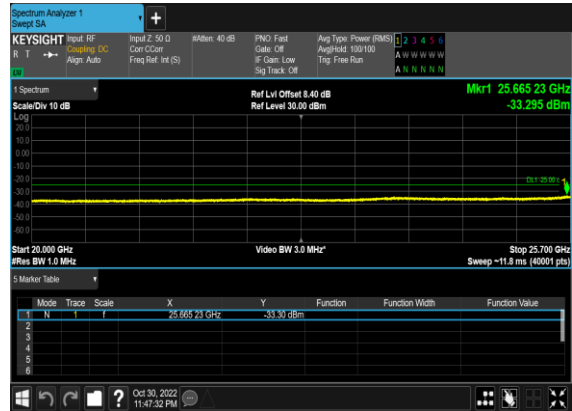

N7(40M)_DFT-s-OFDM_BPSK_Edge_1RB_Left_Mid_CH

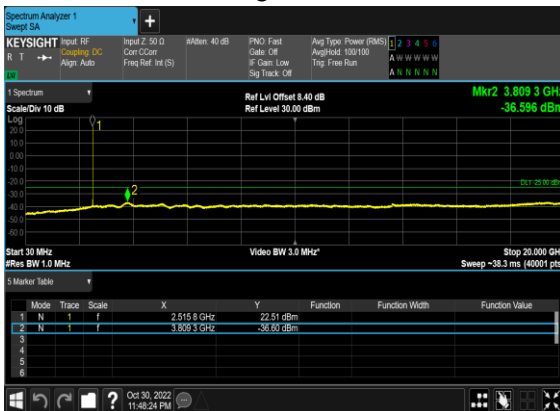

N7(40M)_DFT-s-OFDM_BPSK_Edge_1RB_Left_Mid_CH

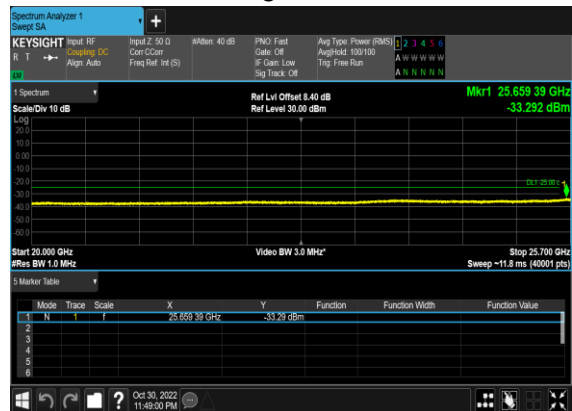

N7(40M)_DFT-s-OFDM_QPSK_Edge_1RB_Left_Mid_CH

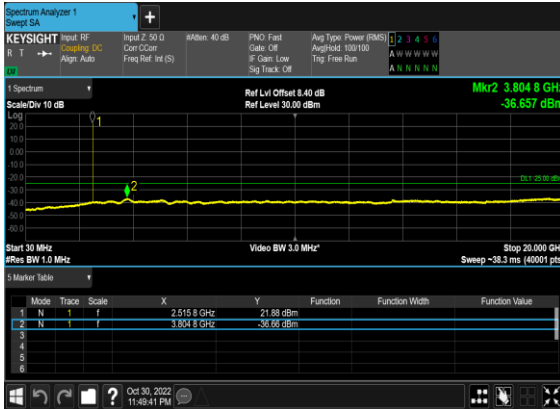

N7(40M)_DFT-s-OFDM_QPSK_Edge_1RB_Left_Mid_CH

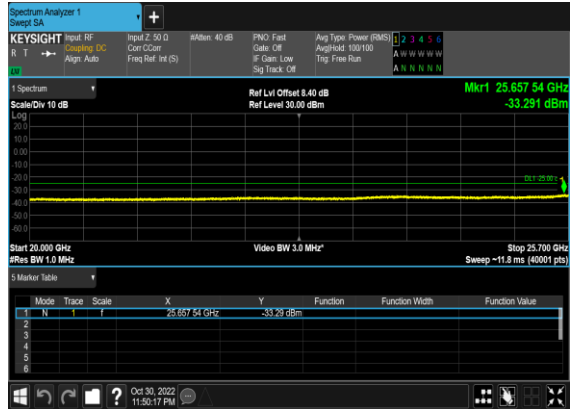

N7(40M)_DFT-s-OFDM_BPSK_Edge_1RB_Left_High_CH

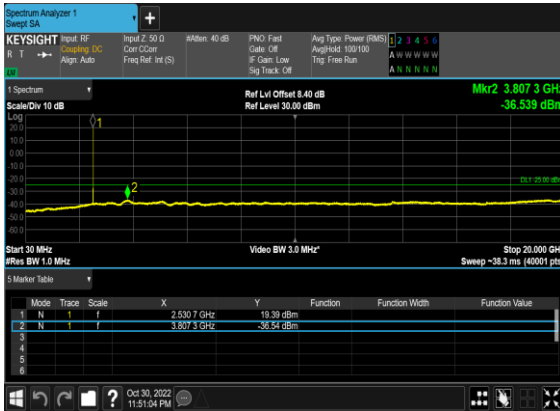

N7(40M)_DFT-s-OFDM_BPSK_Edge_1RB_Left_High_CH

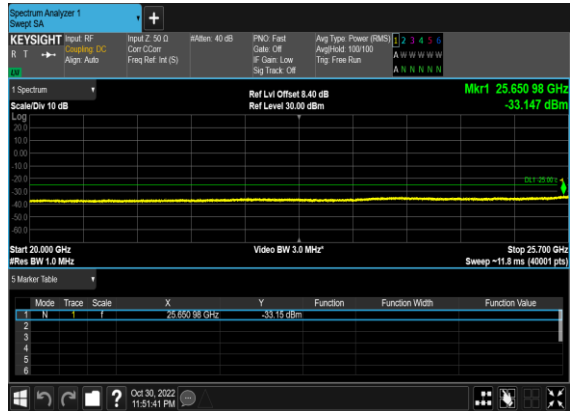

N7(40M)_DFT-s-OFDM_QPSK_Edge_1RB_Left_High_CH

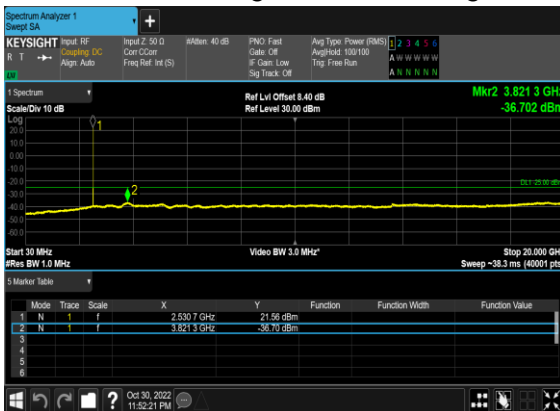

N7(40M)_DFT-s-OFDM_QPSK_Edge_1RB_Left_High_CH

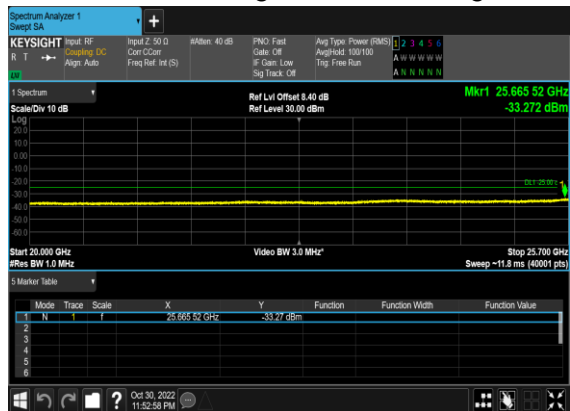

Conducted Band Edge

NR Band	SCS (kHz)	Bandwidth (MHz)	Arfcn	Freq (MHz)	Modulation	RB	Result	Verdict
7	15	5	500500	2502.5	DFT-s-OFDM BPSK	1@0	see graph	PASS
7	15	5	500500	2502.5	DFT-s-OFDM QPSK	1@0	see graph	PASS
7	15	5	500500	2502.5	DFT-s-OFDM BPSK	25@0	see graph	PASS
7	15	5	500500	2502.5	DFT-s-OFDM QPSK	25@0	see graph	PASS
7	15	5	513500	2567.5	DFT-s-OFDM BPSK	1@24	see graph	PASS
7	15	5	513500	2567.5	DFT-s-OFDM QPSK	1@24	see graph	PASS
7	15	5	513500	2567.5	DFT-s-OFDM BPSK	25@0	see graph	PASS
7	15	5	513500	2567.5	DFT-s-OFDM QPSK	25@0	see graph	PASS
7	15	20	502000	2510.0	DFT-s-OFDM BPSK	1@0	see graph	PASS
7	15	20	502000	2510.0	DFT-s-OFDM QPSK	1@0	see graph	PASS
7	15	20	502000	2510.0	DFT-s-OFDM BPSK	100@0	see graph	PASS
7	15	20	502000	2510.0	DFT-s-OFDM QPSK	100@0	see graph	PASS
7	15	20	512000	2560.0	DFT-s-OFDM BPSK	1@105	see graph	PASS
7	15	20	512000	2560.0	DFT-s-OFDM QPSK	1@105	see graph	PASS
7	15	20	512000	2560.0	DFT-s-OFDM BPSK	100@0	see graph	PASS
7	15	20	512000	2560.0	DFT-s-OFDM QPSK	100@0	see graph	PASS
7	15	40	504000	2520.0	DFT-s-OFDM BPSK	1@0	see graph	PASS
7	15	40	504000	2520.0	DFT-s-OFDM QPSK	1@0	see graph	PASS
7	15	40	504000	2520.0	DFT-s-OFDM BPSK	216@0	see graph	PASS
7	15	40	504000	2520.0	DFT-s-OFDM QPSK	216@0	see graph	PASS
7	15	40	510000	2550.0	DFT-s-OFDM BPSK	1@215	see graph	PASS
7	15	40	510000	2550.0	DFT-s-OFDM QPSK	1@215	see graph	PASS

7	15	40	510000	2550.0	DFT-s-OFDM BPSK	216@0	see graph	PASS
7	15	40	510000	2550.0	DFT-s-OFDM QPSK	216@0	see graph	PASS