



FCC RF Test Report

APPLICANT : Motorola Mobility LLC
EQUIPMENT : Mobile Cellular Phone
BRAND NAME : Motorola
MODEL NAME : XT2301-1
FCC ID : IHDT56AH1
STANDARD : 47 CFR Part 2, and 90(S)
CLASSIFICATION : PCS Licensed Transmitter Held to Ear (PCE)
TEST DATE(S) : Oct. 31, 2022 ~ Nov 22, 2022

We, Sporton International Inc. (ShenZhen), would like to declare that the tested sample has been evaluated in accordance with the procedures given in ANSI C63.26-2015 and shown compliance with the applicable technical standards.

The test results in this report apply exclusively to the tested model / sample. Without written approval of Sporton International Inc. (ShenZhen), the test report shall not be reproduced except in full.

Jason Jia



Approved by: Jason Jia

Sporton International Inc. (ShenZhen)

1/F, 2/F, Bldg 5, Shiling Industrial Zone, Xinwei Village, Xili, Nanshan, Shenzhen, 518055

People's Republic of China



TABLE OF CONTENTS

REVISION HISTORY..... 3

SUMMARY OF TEST RESULT 4

1 GENERAL DESCRIPTION 5

1.1 Applicant..... 5

1.2 Manufacturer 5

1.3 Feature of Equipment Under Test..... 5

1.4 Product Specification of Equipment Under Test 5

1.5 Modification of EUT 5

1.6 Maximum Conducted Power and Emission Designator 6

1.7 Testing Site..... 6

1.8 Test Software 6

1.9 Applied Standards 7

1.10 Specification of Accessory 7

2 TEST CONFIGURATION OF EQUIPMENT UNDER TEST 8

2.1 Test Mode..... 8

2.2 Connection Diagram of Test System 9

2.3 Support Unit used in test configuration and system..... 9

2.4 Measurement Results Explanation Example 9

2.5 Frequency List of Low/Middle/High Channels..... 10

3 TEST RESULT..... 11

3.1 Conducted Output Power Measurement..... 11

3.2 99% Occupied Bandwidth and 26dB Bandwidth Measurement..... 12

3.3 Emissions Mask Measurement 13

3.4 Emissions Mask – Out Of Band Emissions Measurement..... 15

3.5 Field Strength of Spurious Radiation Measurement 16

3.6 Frequency Stability Measurement..... 19

4 LIST OF MEASURING EQUIPMENT 21

5 UNCERTAINTY OF EVALUATION..... 22

APPENDIX A. TEST RESULTS OF CONDUCTED TEST

APPENDIX B. TEST RESULTS OF RADIATED TEST

APPENDIX C. TEST SETUP PHOTOGRAPHS



REVISION HISTORY

REPORT NO.	VERSION	DESCRIPTION	ISSUED DATE
FG292622M	Rev. 01	Initial issue of report	Dec. 12, 2022



SUMMARY OF TEST RESULT

Report Section	FCC Rule	Description	Limit	Result	Remark
3.1	§2.1046	Conducted Output Power	—	Report only	-
3.2	§2.1049 §90.209	Occupied Bandwidth and 26dB Bandwidth	—	Report only	-
3.3	§2.1051 §90.691	Emission masks – In-band emissions	$< 50+10\log_{10}(P[\text{Watts}])$	PASS	-
3.4	§2.1051 §90.691	Emission masks – Out of band emissions	$< 43+10\log_{10}(P[\text{Watts}])$	PASS	-
3.5	§2.1053 §90.691	Field Strength of Spurious Radiation	$< 43+10\log_{10}(P[\text{Watts}])$	PASS	Under limit 26.11 dB at 2445.540 MHz
3.6	§2.1055 §90.213	Frequency Stability for Temperature & Voltage	$< 2.5 \text{ ppm}$	PASS	-

Declaration of Conformity:

The test results with all measurement uncertainty excluded are presented in accordance with the regulation limits or requirements declared by manufacturers.

Comments and Explanations:

The declared of product specification for EUT presented in the report are provided by the manufacturer, and the manufacturer takes all the responsibilities for the accuracy of product specification.



1 General Description

1.1 Applicant

Motorola Mobility LLC
222 W, Merchandise Mart Plaza, Chicago IL 60654 USA

1.2 Manufacturer

Motorola Mobility LLC
222 W, Merchandise Mart Plaza, Chicago IL 60654 USA

1.3 Feature of Equipment Under Test

Product Feature	
Equipment	Mobile Cellular Phone
Brand Name	Motorola
Model Name	XT2301-1
FCC ID	IHDT56AH1
IMEI Code	Radiation: 350007550014055/350007550014063 Conducted: 350007550015938/350007550016357
HW Version	DVT2
SW Version	TTR33.124
EUT Stage	Identical Prototype

Remark: The above EUT's information was declared by manufacturer. Please refer to the specifications or user's manual for more detailed description.

1.4 Product Specification of Equipment Under Test

Product Specification subjective to this standard	
Tx Frequency	814 ~ 824 MHz
Rx Frequency	859 ~ 869 MHz
SCS / Bandwidth	15kHz : 5MHz / 10MHz / 15MHz / 20MHz
Maximum Output Power to Antenna	23.99 dBm
Antenna Gain/Type	Ant. 0: -4.50 dBi / IFA Antenna Ant. 1: -5.76 dBi / IFA Antenna
Type of Modulation	CP-OFDM: QPSK / 16QAM / 64QAM / 256QAM DFT-s-OFDM: PI/2 BPSK / QPSK / 16QAM / 64QAM / 256QAM

Remark: Only the maximum power of Antenna 0 is shown in the report.

1.5 Modification of EUT

No modifications are made to the EUT during all test items.



1.6 Maximum Conducted Power and Emission Designator

5G NR n26		PI/2 BPSK / QPSK		16QAM / 64QAM / 256QAM	
BW (MHz)	Frequency Range (MHz)	Maximum Conducted power(W)	Emission Designator (99%OBW)	Maximum Conducted power(W)	Emission Designator (99%OBW)
5	816.5 ~ 821.5	0.2472	4M49G7D	0.1986	4M48W7D
10	819	0.2443	9M27G7D	0.1932	9M29W7D
15	821.5	0.2483	14M1G7D	0.1972	14M1W7D
20	824	0.2506	18M9G7D	0.2018	18M9W7D

1.7 Testing Site

Sporton International Inc. (Shenzhen) is accredited to ISO/IEC 17025:2017 by American Association for Laboratory Accreditation with Certificate Number 5145.01.

Test Firm	Sporton International Inc. (Shenzhen)		
Test Site Location	1/F, 2/F, Bldg 5, Shiling Industrial Zone, Xinwei Village, Xili, Nanshan, Shenzhen, 518055 People's Republic of China TEL: +86-755-86379589 FAX: +86-755-86379595		
Test Site No.	Sporton Site No.	FCC Designation No.	FCC Test Firm Registration No.
	TH01-SZ	CN1256	421272

Test Firm	Sporton International Inc. (Shenzhen)		
Test Site Location	101, 1st Floor, Block B, Building 1, No. 2, Tengfeng 4th Road, Fenghuang Community, Fuyong Street, Baoan District, Shenzhen City Guangdong Province China 518103 TEL: +86-755-33202398		
Test Site No.	Sporton Site No.	FCC Designation No.	FCC Test Firm Registration No.
	03CH03-SZ	CN1256	421272

1.8 Test Software

Item	Site	Manufacturer	Name	Version
1.	03CH03-SZ	AUDIX	E3	6.2009-8-24



1.9 Applied Standards

According to the specifications of the manufacturer, the EUT must comply with the requirements of the following standards:

- 47 CFR Part 2, 90(S)
- ANSI C63.26-2015
- FCC KDB 971168 D01 Power Meas. License Digital Systems v03r01
- FCC KDB 971168 D02 Misc Rev Approv License Devices v02r01

Remark:

1. All test items were verified and recorded according to the standards and without any deviation during the test.
2. This EUT has also been tested and complied with the requirements of FCC Part 15, Subpart B, recorded in a separate test report.

1.10 Specification of Accessory

Specification of Accessory				
AC Adapter 1(US)	Brand Name	Motorola (Chenyang)	Model Name	MC-681N
AC Adapter 2(US)	Brand Name	Motorola (Acbel)	Model Name	MC-681N
Battery 1	Brand Name	Motorola(SCUD)	Model Name	PC51
Earphone 1	Brand Name	Motorola (Lyand)	Model Name	MI181C(SH38D62338)
USB Cable 1	Brand Name	Motorola(Saibao)	Model Name	SC18D24968
C to HDMI HDMI/USBC Cable 1	Brand Name	Motorola(Linxee)	Model Name	SC18D02146
C to HDMI HDMI/USBC Cable 2	Brand Name	Motorola(Linxee)	Model Name	SC18D38847



2 Test Configuration of Equipment Under Test

2.1 Test Mode

During all testing, EUT is in link mode with base station emulator at maximum power level. The spurious emission measurements were carried out in semi-anechoic chamber with 3-meter test range, and EUT is rotated on three test planes to find out the worst emission (Z plane).

Frequency range investigated for radiated emission is 30 MHz to 9000 MHz.

Test Items	Band	Bandwidth (MHz)				Modulation					RB #			Test Channel		
		5	10	15	20	PI/2 BPSK	QPSK	16QAM	64QAM	256QAM	1	Half	Full	L	M	H
Max. Output Power	n26	v	v	v	v	v	v	v	v	v	v		v	v	v	v
26dB and 99% Bandwidth	n26	v	v			v	v	v	v	v			v		v	
				v	v	v	v	v	v	v			v			v
Emission masks In-band emissions	n26	v				v	v				v		v	v	v	v
			v			v	v				v		v		v	
					v	v	v				v		v			v
Emission masks – Out of band emissions	n26	v				v	v				v		v	v		v
			v			v	v				v		v		v	
					v	v	v				v		v			v
Frequency Stability	n26		v				v						v		v	
Radiated Spurious Emission	n26	Worst Case												v		
Note	<ol style="list-style-type: none"> The mark "v" means that this configuration is chosen for testing The mark "-" means that this bandwidth is not supported. 5G n26 transmit frequency for part22 rule is 824MHz-849MHz, for part90 rule is 814MHz-824MHz. ERP over 15MHz bandwidth complies the ERP limit line of part22 rule, therefore ERP of the partial frequency spectrum which falls within part 22 also complies. Frequency Stability : Normal Voltage = 3.89V ; Low Voltage =3.40V ; High Voltage =4.48V; 															

2.2 Connection Diagram of Test System

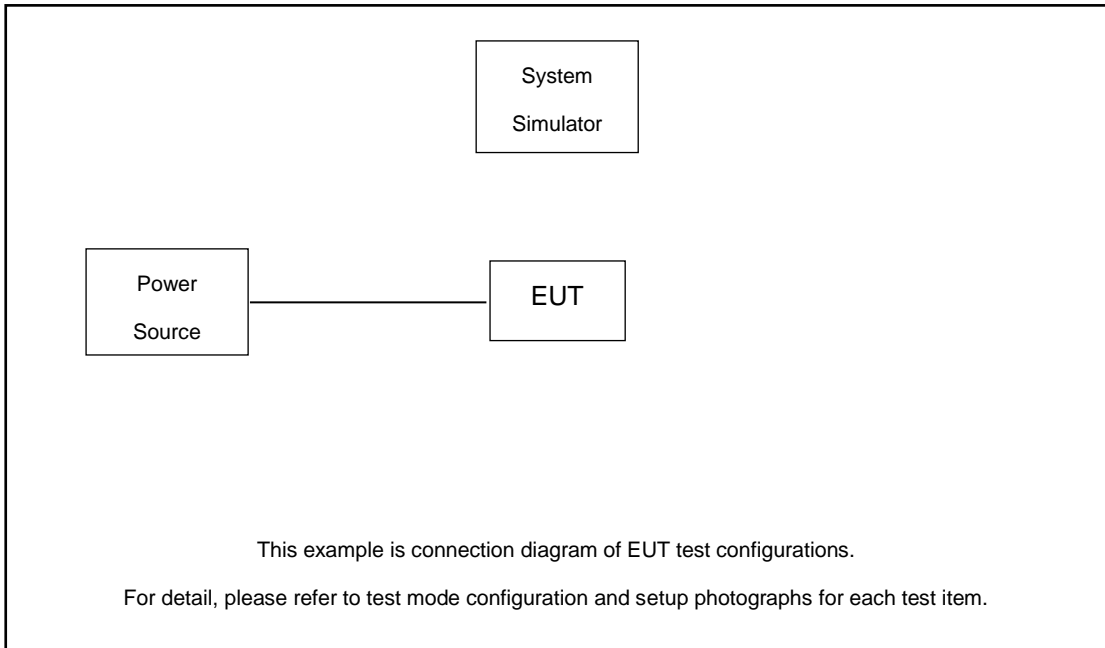

2.3 Support Unit used in test configuration and system

Item	Equipment	Trade Name	Model No.	FCC ID	Data Cable	Power Cord
1.	Power Supply	GWINSTEK	PSS-2002	N/A	N/A	Unshielded, 1.8 m
2.	LTE Base Station	Anritsu	MT8821C	N/A	N/A	Unshielded, 1.8 m
3.	NR Base Station	Anritsu	MT8000A	N/A	N/A	Unshielded, 1.8 m

2.4 Measurement Results Explanation Example

For all conducted test items:

The offset level is set in the spectrum analyzer to compensate the RF cable loss between RF conducted output port and spectrum analyzer. With the offset compensation, the spectrum analyzer reading level will be exactly the RF output level.

The spectrum analyzer offset is derived from RF cable loss.

Offset = RF cable loss.

The following shows an offset computation example with RF cable loss 7.6 dB.

Example :

$$\begin{aligned} \text{Offset(dB)} &= \text{RF cable loss(dB)}. \\ &= 7.6 \text{ (dB)} \end{aligned}$$



2.5 Frequency List of Low/Middle/High Channels

5G NR n26 Channel and Frequency List				
BW [MHz]	Channel/Frequency(MHz)	Lowest	Middle	Highest
20	Channel	173800	-	-
	Frequency	824	-	-
15	Channel	173300	-	-
	Frequency	821.5	-	-
10	Channel	-	172800	-
	Frequency	-	819	-
5	Channel	172300	172800	173300
	Frequency	816.5	819	821.5

3 Test Result

3.1 Conducted Output Power Measurement

3.1.1 Description of the Conducted Output Power Measurement

A system simulator was used to establish communication with the EUT. Its parameters were set to enforce EUT transmitting at the maximum power. The measured power in the radio frequency on the transmitter output terminals shall be reported.

3.1.2 Measuring Instruments

The measuring equipment is listed in the section 4 of this test report.

3.1.3 Test Procedures

1. The transmitter output port was connected to the system simulator.
2. Set EUT at maximum power through the system simulator.
3. Select lowest, middle, and highest channels for each band and different modulation.
4. Measure and record the power level from the system simulator.

3.1.4 Test Setup



3.1.5 Test Result of Conducted Output Power

Please refer to Appendix A.

3.2 99% Occupied Bandwidth and 26dB Bandwidth Measurement

3.2.1 Description of (Occupied) Bandwidth Limitations Measurement

The 99% occupied bandwidth is the width of a frequency band such that, below the lower and above the upper frequency limits, the mean powers emitted are each equal to a specified percentage 0.5% of the total mean transmitted power.

The emission bandwidth is defined as the width of the signal between two points, located at the 2 sides of the carrier frequency, outside of which all emissions are attenuated at least 26 dB below the transmitter power.

3.2.2 Measuring Instruments

The measuring equipment is listed in the section 4 of this test report.

3.2.3 Test Procedures

1. The EUT was connected to spectrum analyzer and system simulator via a power divider.
2. The 26dB and 99% occupied bandwidth (BW) of the middle channel for the highest RF power with full RB sizes were measured.

3.2.4 Test Setup



3.2.5 Test Result of 99% Occupied Bandwidth and 26dB Bandwidth

Please refer to Appendix A.



3.3 Emissions Mask Measurement

3.3.1 Description of Emissions Mask Measurement

Equipment used in this licensed to EA or non-EA systems shall comply with the emission mask provisions of FCC Part 90.691.(a):

(a) Out-of-band emission requirement shall apply only to the “outer” channels included in an EA license and to spectrum adjacent to interior channels used by incumbent licensees. The emission limits are as follows:

(1) For any frequency removed from the EA licensee's frequency block by up to and including 37.5 kHz, the power of any emission shall be attenuated below the transmitter power (P) in watts by at least $116 \text{ Log}_{10}(f/6.1)$ decibels or $50 + 10 \text{ Log}_{10}(P)$ decibels or 80 decibels, whichever is the lesser attenuation, where f is the frequency removed from the center of the outer channel in the block in kilohertz and where f is greater than 12.5 kHz.

(2) For any frequency removed from the EA licensee's frequency block greater than 37.5 kHz, the power of any emission shall be attenuated below the transmitter power (P) in watts by at least $43 + 10 \text{ Log}_{10}(P)$ decibels or 80 decibels, whichever is the lesser attenuation, where f is the frequency removed from the center of the outer channel in the block in kilohertz and where f is greater than 37.5 kHz.

3.3.2 Measuring Instruments

The measuring equipment is listed in the section 4 of this test report.

3.3.3 Test Procedures

1. The EUT was connected to spectrum analyzer and base station via power divider.
2. The emissions mask of low and high channels for the highest RF powers were measured.
3. The measured RBW and the VBW set 3 times of RBW are then set in spectrum analyzer, and the RBW correction factor $10 \text{ log} (1\% \text{ of OBW/measured RBW})(\text{dB})$ was compensated, if required.
4. The test results were shown below plots with a correction offset factor including cable loss, insertion loss of power divider.

3.3.4 Test Setup

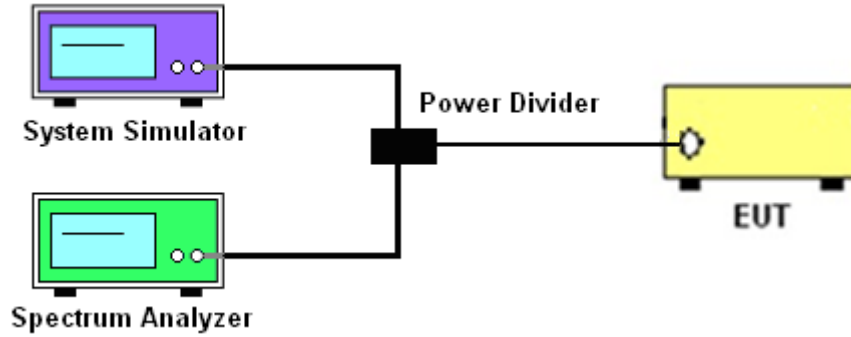

3.3.5 Test Result (Plots) of Conducted Emissions Mask

Please refer to Appendix A.

3.4 Emissions Mask – Out Of Band Emissions Measurement

3.4.1 Description of Conducted Emissions Out of band emissions measurement

The power of any emission FCC Part 90.691 (a)(2) on any frequency removed from the assigned frequency by out of the authorized bandwidth at least $43 + 10 \log (P)$ dB. It is measured by means of a calibrated spectrum analyzer and scanned from 30 MHz up to a frequency including its 10th harmonic.

3.4.2 Measuring Instruments

The measuring equipment is listed in the section 4 of this test report.

3.4.3 Test Procedures

1. The EUT was connected to spectrum analyzer and system simulator via a power divider.
2. The RF output of EUT was connected to the spectrum analyzer by RF cable and attenuator. The path loss was compensated to the results for each measurement.
3. The middle channel for the highest RF power within the transmitting frequency was measured.
4. The conducted spurious emission for the whole frequency range was taken.
5. Make the measurement with the spectrum analyzer's RBW = 1MHz, VBW = 3MHz, taking the record of maximum spurious emission.
6. The RF fundamental frequency should be excluded against the limit line in the operating frequency band.
7. The limit line is derived from $43 + 10\log(P)$ dB below the transmitter power P(Watts)

3.4.4 Test Setup

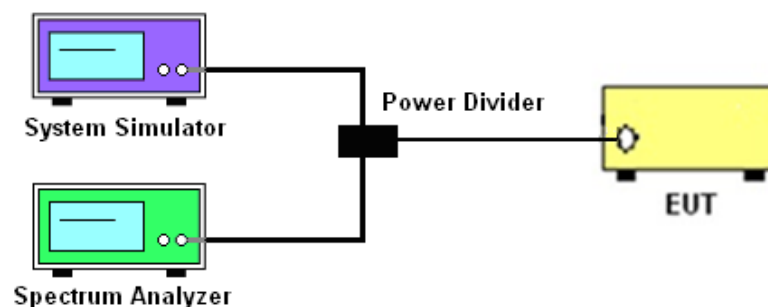

3.4.5 Test Result (Plots) of Conducted Emission

Please refer to Appendix A.



3.5 Field Strength of Spurious Radiation Measurement

3.5.1 Description of Field Strength of Spurious Radiated Measurement

The radiated spurious emission was measured by substitution method according to ANSI/TIA-603-E. The power of any emission FCC Part 90.691 on any frequency removed from the assigned frequency by more than 250 percent of the authorized bandwidth at least $43 + 10 \log (P)$ dB. The spectrum is scanned from 30 MHz up to a frequency including its 10th harmonic.

The power of any emission outside of the authorized operating frequency ranges must be attenuated below the transmitter power (P) by a factor of at least $43 + 10 \log_{10}(P[\text{Watts}])$ dB. The spectrum is scanned from 30 MHz up to a frequency including its 10th harmonic.

3.5.2 Measuring Instruments

The measuring equipment is listed in the section 4 of this test report.

3.5.3 Test Procedures

1. The EUT was placed on a turntable with 0.8 meter for frequency below 1GHz and 1.5 meter for frequency above 1GHz respectively above ground.
2. The EUT was set 3 meters from the receiving antenna, which was mounted on the antenna tower.
3. The table was rotated 360 degrees to determine the position of the highest spurious emission.
4. The height of the receiving antenna is varied between one meter and four meters to search the maximum spurious emission for both horizontal and vertical polarizations.
5. Make the measurement with the spectrum analyzer's RBW = 1MHz, VBW = 3MHz, Sweep = 500ms, Taking the record of maximum spurious emission.
6. A horn antenna was substituted in place of the EUT and was driven by a signal generator.
7. Tune the output power of signal generator to the same emission level with EUT maximum spurious emission.
8. Taking the record of output power at antenna port.
9. Repeat step 7 to step 8 for another polarization.
10. $\text{EIRP (dBm)} = \text{S.G. Power} - \text{Tx Cable Loss} + \text{Tx Antenna Gain}$
11. $\text{ERP (dBm)} = \text{EIRP} - 2.15$
12. The RF fundamental frequency should be excluded against the limit line in the operating frequency band.
13. The limit line is derived from $43 + 10 \log(P)$ dB below the transmitter power P(Watts)

3.5.4 Test Setup

For radiated test from 30MHz



For radiated test from 30MHz to 1GHz

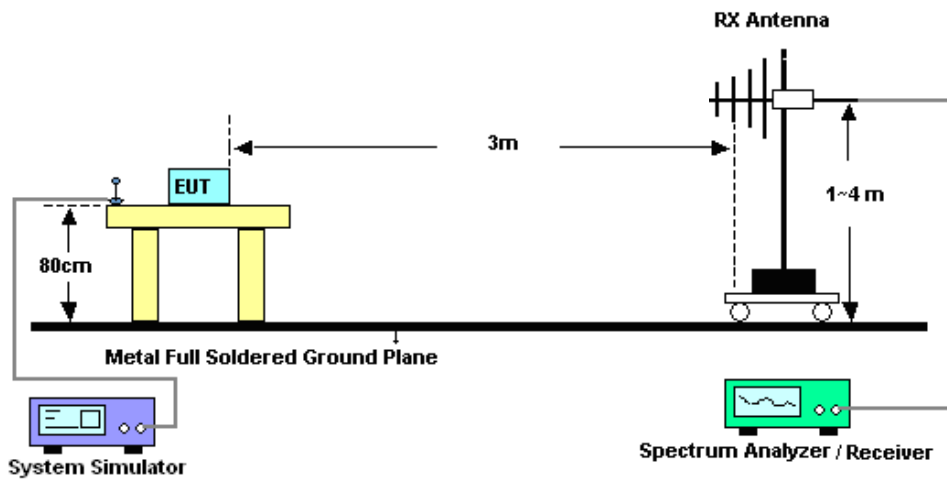

For radiated test above 1GHz

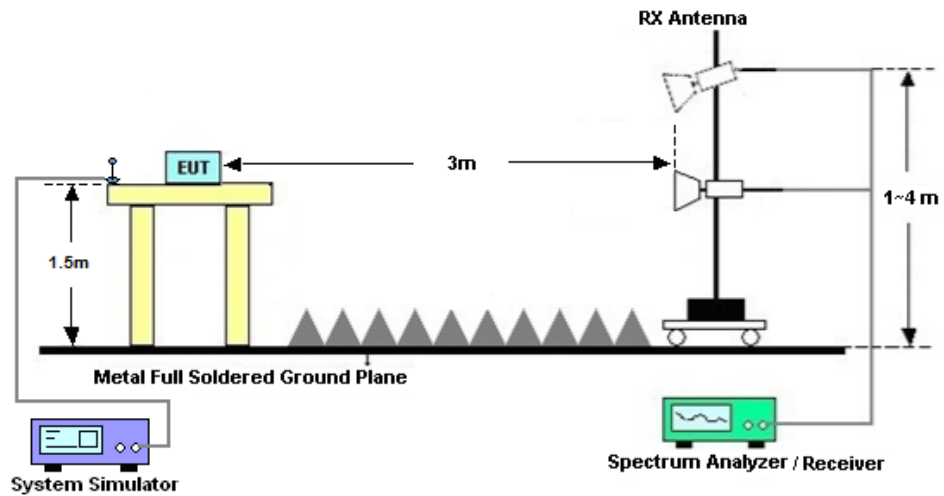

3.5.5 Test Result of Field Strength of Spurious Radiated

The low frequency, which started from 9 kHz to 30MHz, was pre-scanned and the result which was 20dB lower than the limit line was not reported.

Please refer to Appendix B.



3.6 Frequency Stability Measurement

3.6.1 Description of Frequency Stability Measurement

The frequency stability shall be measured by variation of ambient temperature and variation of primary supply voltage to ensure that the fundamental emission stays within the authorized frequency block. The frequency stability of the transmitter shall be maintained within $\pm 0.00025\%$ ($\pm 2.5\text{ppm}$) of the center frequency according to FCC Part 90.213.

3.6.2 Measuring Instruments

The measuring equipment is listed in the section 4 of this test report.

3.6.3 Test Procedures for Temperature Variation

1. The EUT was set up in the thermal chamber and connected with the base station.
2. With power OFF, the temperature was decreased to -30°C and the EUT was stabilized for three hours. Power was applied and the maximum change in frequency was recorded within one minute.
3. With power OFF, the temperature was raised in 10°C step up to 50°C . The EUT was stabilized at each step for at least half an hour. Power was applied and the maximum frequency change was recorded within one minute.

3.6.4 Test Procedures for Voltage Variation

1. The EUT was placed in a temperature chamber at $20\pm 5^{\circ}\text{C}$ and connected with the system simulator.
2. The power supply voltage to the EUT was varied from 85% to 115% of the nominal value for other than hand carried battery equipment.
3. For hand carried, battery powered equipment, reduce the primary ac or dc supply voltage to the battery operating end point, which shall be specified by the manufacturer.
4. The variation in frequency was measured for the worst case.

3.6.5 Test Setup



3.6.6 Test Result of Temperature Variation

Please refer to Appendix A.



4 List of Measuring Equipment

Instrument	Manufacturer	Model No.	Serial No.	Characteristics	Calibration Date	Test Date	Due Date	Remark
Spectrum Analyzer	R&S	FSV40	101078	10Hz~40GHz	Apr. 07, 2022	Oct. 31, 2022~ Nov. 22, 2022	Apr. 08, 2023	Conducted (TH01-SZ)
DC Power Supply	TTI	PL330P	290070	Max 32V , 3A	Oct. 17, 2022	Oct. 31, 2022~ Nov. 22, 2022	Oct. 16, 2023	Conducted (TH01-SZ)
Power Divider	TOJOIN	PS-2SM-04 265	60.06.020.007 7	0.4GHz~26.5GHz	Dec. 25, 2021	Oct. 31, 2022~ Nov. 22, 2022	Dec. 24, 2022	Conducted (TH01-SZ)
Thermal Chamber	Ten Billion Hongzhangroup	LP-150U	H2014081803	-40~+150°C	Jul. 07, 2022	Oct. 31, 2022~ Nov. 22, 2022	Jul. 06, 2023	Conducted (TH01-SZ)
EMI Test Receiver&SA	KEYSIGHT	N9038A	MY54450083	20Hz~8.4GHz	Apr. 06, 2022	Nov. 15, 2022	Apr. 05, 2023	Radiation (03CH03-SZ)
Loop Antenna	R&S	HFH2-Z2	100354	9kHz~30MHz	Jun. 28, 2022	Nov. 15, 2022	Jun. 27, 2024	Radiation (03CH03-SZ)
EXA Spectrum Analyzer	KEYSIGHT	N9010A	MY55150246	10Hz~44GHz;	Apr. 06, 2022	Nov. 15, 2022	Apr. 05, 2023	Radiation (03CH03-SZ)
Bilog Antenna	TeseQ	CBL6112D	35408	30MHz-2GHz	Aug. 09, 2021	Nov. 15, 2022	Aug. 09, 2023	Radiation (03CH03-SZ)
Double Ridge Horn Antenna	SCHWARZBECK	BBHA9120D	9120D-1355	1GHz~18GHz	Apr. 08, 2022	Nov. 15, 2022	Apr. 07, 2023	Radiation (03CH03-SZ)
Amplifier	Burgeon	BPA-530	102211	0.01Hz ~3000MHz	Oct. 19, 2022	Nov. 15, 2022	Oct. 18, 2023	Radiation (03CH03-SZ)
HF Amplifier	MITEQ	TTA1840-35 -HG	1871923	18GHz~40GHz	Jul. 06, 2022	Nov. 15, 2022	Jul.05, 2023	Radiation (03CH03-SZ)
SHF-EHF Horn	com-power	AH-840	101071	18Ghz-40GHz	Apr. 10, 2022	Nov. 15, 2022	Apr. 09, 2023	Radiation (03CH03-SZ)
Amplifier	Agilent Technologies	83017A	MY39501302	500MHz~26.5GHz	Dec. 27, 2021	Nov. 15, 2022	Dec. 26, 2022	Radiation (03CH03-SZ)
AC Power Source	Chroma	61601	616010002729	N/A	Nov. 10, 2022	Nov. 15, 2022	Nov. 09, 2023	Radiation (03CH03-SZ)
Turn Table	EM	EM1000	N/A	0~360 degree	NCR	Nov. 15, 2022	NCR	Radiation (03CH03-SZ)
Antenna Mast	EM	EM1000	N/A	1 m~4 m	NCR	Nov. 15, 2022	NCR	Radiation (03CH03-SZ)

NCR: No Calibration Required



5 Uncertainty of Evaluation

The measurement uncertainties shown below were calculated in accordance with the requirements of ANSI 63.26-2015. All the measurement uncertainty value were shown with a coverage K=2 to indicate 95% level of confidence. The measurement data show herein meets or exceeds the CISPR measurement uncertainty values specified in CISPR 16-4-2 and can be compared directly to specified limit to determine compliance.

Uncertainty of Conducted Measurement

Test Item	Uncertainty
Conducted Power	±1.34 dB
Conducted Emissions	±1.34 dB
Occupied Channel Bandwidth	±0.13 %

Uncertainty of Radiated Emission Measurement (30 MHz ~ 1000 MHz)

Measuring Uncertainty for a Level of Confidence of 95% (U = 2Uc(y))	3.0 dB
---	--------

Uncertainty of Radiated Emission Measurement (1 GHz ~ 18 GHz)

Measuring Uncertainty for a Level of Confidence of 95% (U = 2Uc(y))	3.6 dB
---	--------

Uncertainty of Radiated Emission Measurement (18 GHz ~ 40 GHz)

Measuring Uncertainty for a Level of Confidence of 95% (U = 2Uc(y))	3.8 dB
---	--------

----- THE END -----



Appendix A. Test Results of Conducted Test

Test Engineer :	Jung Guo	Temperature :	21~23°C
		Relative Humidity :	45~51%

Conducted Output Power (Average power)

NR Band	SCS (kHz)	Bandwidth (MHz)	Arfcn	Freq (MHz)	Modulation	RB	Conducted Power(dBm)
26	15	5	163300	816.5	DFT-s-OFDM QPSK	1@1	23.9
26	15	5	163300	816.5	DFT-s-OFDM 16 QAM	1@1	22.92
26	15	5	163800	819.0	DFT-s-OFDM QPSK	1@1	23.91
26	15	5	163800	819.0	DFT-s-OFDM 16 QAM	1@1	22.98
26	15	5	164300	821.5	DFT-s-OFDM QPSK	1@1	23.93
26	15	5	164300	821.5	DFT-s-OFDM 16 QAM	1@1	22.98
26	15	10	163800	819.0	DFT-s-OFDM QPSK	1@1	23.88
26	15	10	163800	819.0	DFT-s-OFDM 16 QAM	1@1	22.86
26	15	15	164300	821.5	DFT-s-OFDM QPSK	1@1	23.95
26	15	15	164300	821.5	DFT-s-OFDM 16 QAM	1@1	22.95
26	15	20	164800	824.0	DFT-s-OFDM PI/2 BPSK	50@25	23.95
26	15	20	164800	824.0	DFT-s-OFDM PI/2 BPSK	1@1	23.84
26	15	20	164800	824.0	DFT-s-OFDM PI/2 BPSK	1@104	23.88
26	15	20	164800	824.0	DFT-s-OFDM QPSK	50@25	23.99
26	15	20	164800	824.0	DFT-s-OFDM QPSK	1@1	23.95
26	15	20	164800	824.0	DFT-s-OFDM QPSK	1@104	23.85
26	15	20	164800	824.0	DFT-s-OFDM 16 QAM	50@25	22.99
26	15	20	164800	824.0	DFT-s-OFDM 16 QAM	1@1	22.92
26	15	20	164800	824.0	DFT-s-OFDM 16 QAM	1@104	23.05
26	15	20	164800	824.0	DFT-s-OFDM 64 QAM	50@25	21.59
26	15	20	164800	824.0	DFT-s-OFDM 64 QAM	1@1	21.47



26	15	20	164800	824.0	DFT-s-OFDM 64 QAM	1@104	21.65
26	15	20	164800	824.0	DFT-s-OFDM 256 QAM	50@25	21.58
26	15	20	164800	824.0	DFT-s-OFDM 256 QAM	1@1	19.03
26	15	20	164800	824.0	DFT-s-OFDM 256 QAM	1@104	19.22
26	15	20	164800	824.0	CP-OFDM QPSK	53@26	22.63
26	15	20	164800	824.0	CP-OFDM QPSK	1@1	22.38
26	15	20	164800	824.0	CP-OFDM QPSK	1@104	22.21



Frequency Stability

NR Band	SCS (kHz)	Bandwidth (MHz)	Arfcn	Freq (MHz)	Modulation	RB	Deviation (ppm)	Verdict	Environment
26	15	10	163800	819.0	DFT-s-OFDM QPSK	50@0	0.0022	PASS	NV
26	15	10	163800	819.0	DFT-s-OFDM QPSK	50@0	0.0054	PASS	LV
26	15	10	163800	819.0	DFT-s-OFDM QPSK	50@0	0.0069	PASS	HV
26	15	10	163800	819.0	DFT-s-OFDM QPSK	50@0	0.0057	PASS	-30°C
26	15	10	163800	819.0	DFT-s-OFDM QPSK	50@0	0.0026	PASS	-20°C
26	15	10	163800	819.0	DFT-s-OFDM QPSK	50@0	0.0038	PASS	-10°C
26	15	10	163800	819.0	DFT-s-OFDM QPSK	50@0	0.0045	PASS	0°C
26	15	10	163800	819.0	DFT-s-OFDM QPSK	50@0	0.0037	PASS	10°C
26	15	10	163800	819.0	DFT-s-OFDM QPSK	50@0	0.0022	PASS	20°C
26	15	10	163800	819.0	DFT-s-OFDM QPSK	50@0	0.0042	PASS	30°C
26	15	10	163800	819.0	DFT-s-OFDM QPSK	50@0	0.0030	PASS	40°C
26	15	10	163800	819.0	DFT-s-OFDM QPSK	50@0	0.0029	PASS	50°C



Peak to Average Ratio

NR	SCS	Bandwidth	Arfcn	Freq	Modulation	RB	Result	Limit	Verdict
Band	(kHz)	(MHz)		(MHz)			(dB)	(dB)	
26	15	10	163800	819.0	DFT-s-OFDM PI/2 BPSK	50@0	4.29	13	PASS
26	15	10	163800	819.0	DFT-s-OFDM PI/2 BPSK	1@0	3.82	13	PASS
26	15	10	163800	819.0	DFT-s-OFDM QPSK	50@0	4.79	13	PASS
26	15	10	163800	819.0	DFT-s-OFDM QPSK	1@0	4.32	13	PASS

N26(10M)_DFT-s-OFDM_PI_2-BPSK_Outer_Full_Mid_CH



N26(10M)_DFT-s-OFDM_PI_2-BPSK_Edge_1RB_Left_Mid_CH



N26(10M)_DFT-s-OFDM_QPSK_Outer_Full_Mid_CH

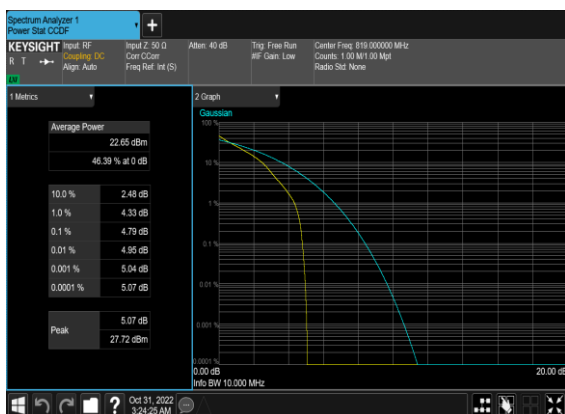

N26(10M)_DFT-s-OFDM_QPSK_Edge_1RB_Left_Mid_CH

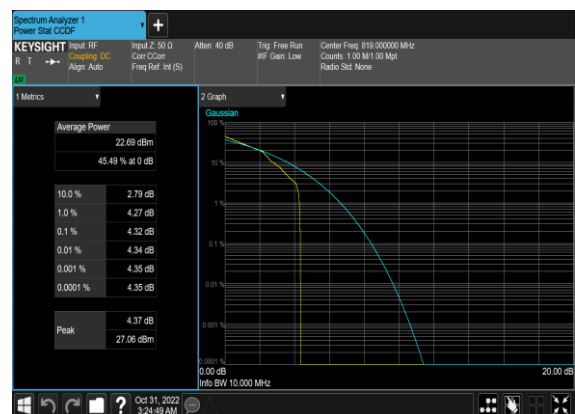



Occupied Bandwidth

NR Band	SCS (kHz)	Bandwidth (MHz)	Arfcn	Freq (MHz)	Modulation	RB	OBW (MHz)	26dB OBW (MHz)
26	15	5	163800	819.0	DFT-s-OFDM PI/2 BPSK	25@0	4.4871	5.082
26	15	5	163800	819.0	DFT-s-OFDM QPSK	25@0	4.4737	5.061
26	15	5	163800	819.0	CP-OFDM QPSK	25@0	4.4808	5.085
26	15	5	163800	819.0	CP-OFDM 16 QAM	25@0	4.4841	5.227
26	15	5	163800	819.0	CP-OFDM 64 QAM	25@0	4.4618	5.05
26	15	5	163800	819.0	CP-OFDM 256 QAM	25@0	4.479	5.037
26	15	10	163800	819.0	DFT-s-OFDM PI/2 BPSK	50@0	8.8934	9.59
26	15	10	163800	819.0	DFT-s-OFDM QPSK	50@0	8.9087	9.649
26	15	10	163800	819.0	CP-OFDM QPSK	52@0	9.2708	10.13
26	15	10	163800	819.0	CP-OFDM 16 QAM	52@0	9.2918	9.978
26	15	10	163800	819.0	CP-OFDM 64 QAM	52@0	9.2621	9.858
26	15	10	163800	819.0	CP-OFDM 256 QAM	52@0	9.2728	9.959
26	15	15	164300	821.5	DFT-s-OFDM PI/2 BPSK	75@0	13.378	14.27
26	15	15	164300	821.5	DFT-s-OFDM QPSK	75@0	13.389	14.33
26	15	15	164300	821.5	CP-OFDM QPSK	79@0	14.077	14.91
26	15	15	164300	821.5	CP-OFDM 16 QAM	79@0	14.084	14.92
26	15	15	164300	821.5	CP-OFDM 64 QAM	79@0	14.091	14.86
26	15	15	164300	821.5	CP-OFDM 256 QAM	79@0	14.065	14.91
26	15	20	164800	824.0	DFT-s-OFDM PI/2 BPSK	100@0	17.849	18.82
26	15	20	164800	824.0	DFT-s-OFDM QPSK	100@0	17.811	18.86
26	15	20	164800	824.0	CP-OFDM QPSK	106@0	18.853	20.0
26	15	20	164800	824.0	CP-OFDM 16 QAM	106@0	18.858	19.83
26	15	20	164800	824.0	CP-OFDM 64 QAM	106@0	18.842	19.7
26	15	20	164800	824.0	CP-OFDM 256 QAM	106@0	18.891	19.86



N26(5M)_DFT-s-OFDM_PI_2-BPSK_Outer_Full_Mid_

CH

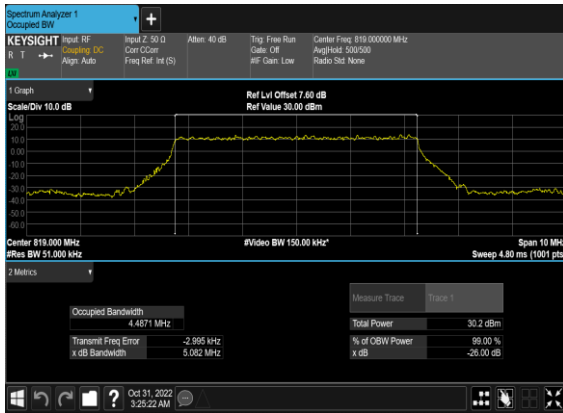

N26(5M)_DFT-s-OFDM_QPSK_Outer_Full_Mid_C

H

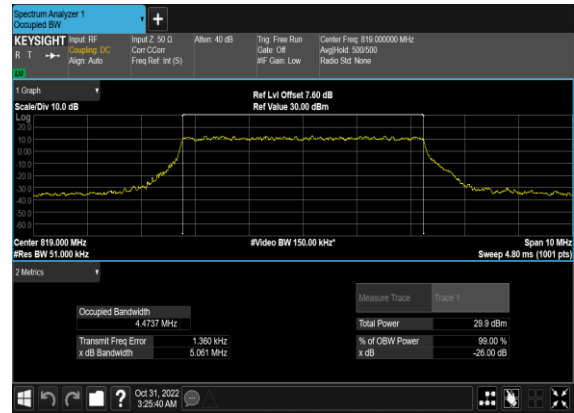

N26(5M)_CP-OFDM_QPSK_Outer_Full_Mid_CH



N26(5M)_CP-OFDM_16

QAM_Outer_Full_Mid_CH

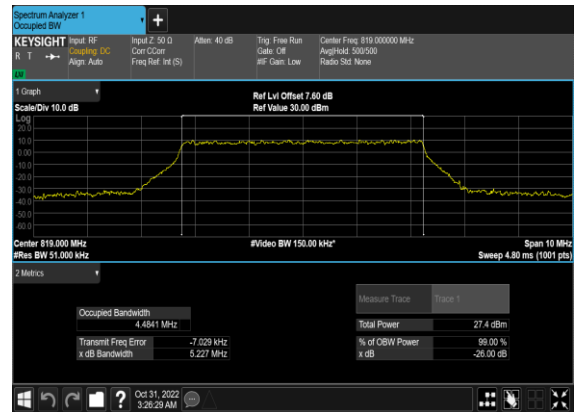

N26(5M)_CP-OFDM_64 QAM_Outer_Full_Mid_CH

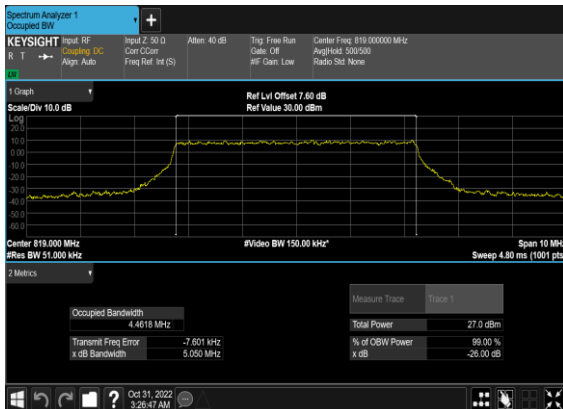

N26(5M)_CP-OFDM_256

QAM_Outer_Full_Mid_CH

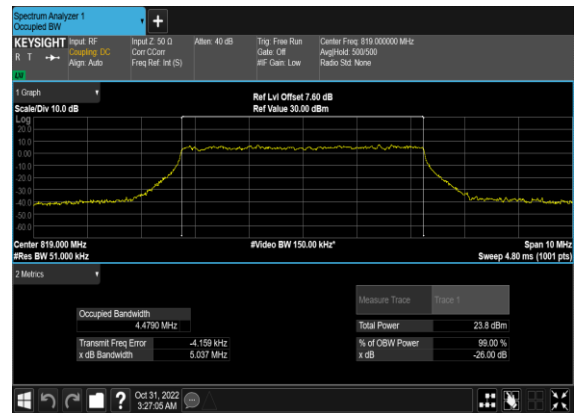



N26(10M)_DFT-s-OFDM_PI_2-BPSK_Outer_Full_Mid_CH

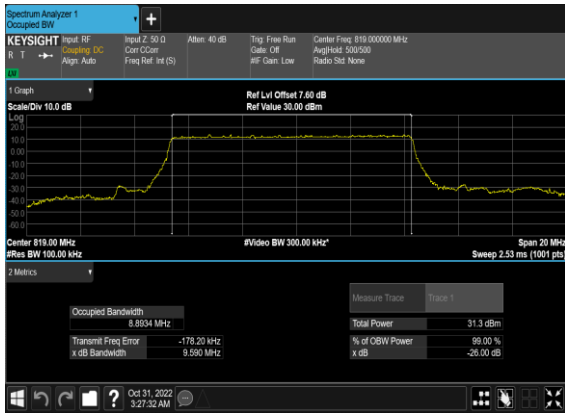

N26(10M)_DFT-s-OFDM_QPSK_Outer_Full_Mid_CH

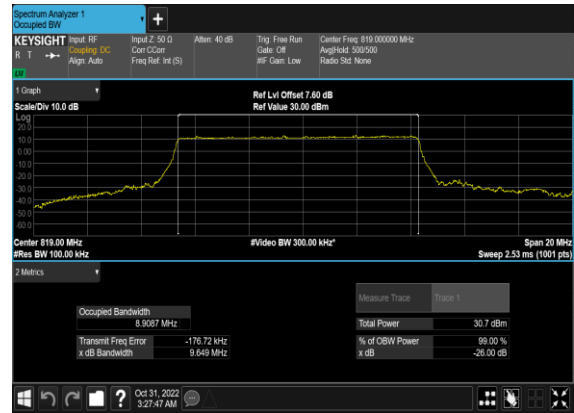

N26(10M)_CP-OFDM_QPSK_Outer_Full_Mid_CH



N26(10M)_CP-OFDM_16 QAM_Outer_Full_Mid_CH

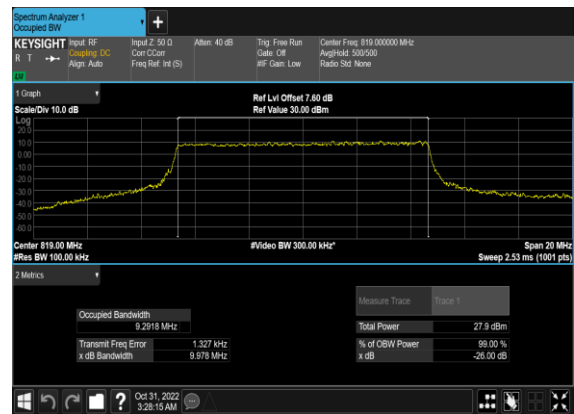

N26(10M)_CP-OFDM_64 QAM_Outer_Full_Mid_CH

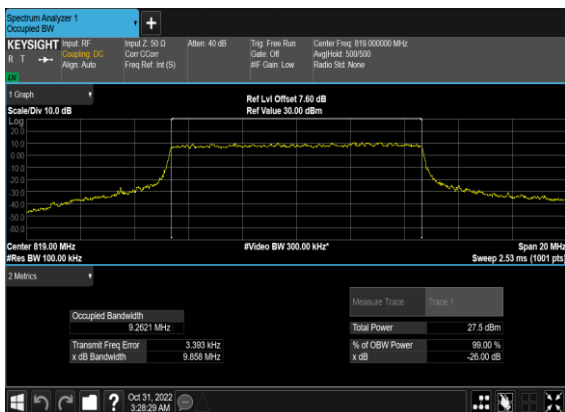

N26(10M)_CP-OFDM_256 QAM_Outer_Full_Mid_CH

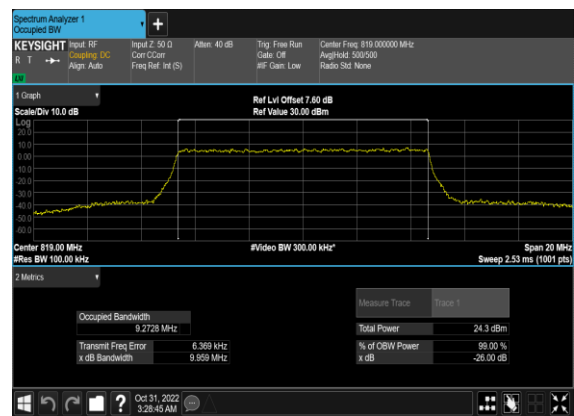



N26(15M)_DFT-s-OFDM_PI_2-BPSK_Outer_Full_Mid_CH

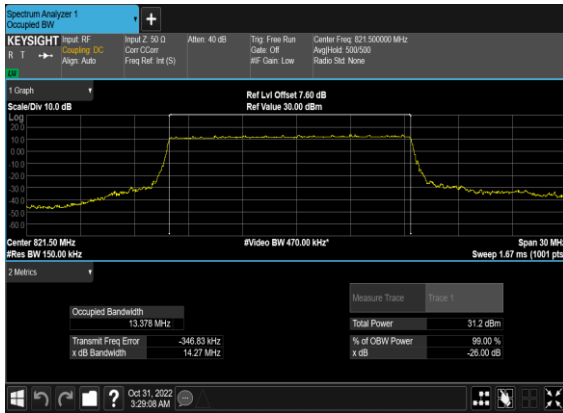

N26(15M)_DFT-s-OFDM_QPSK_Outer_Full_Mid_CH

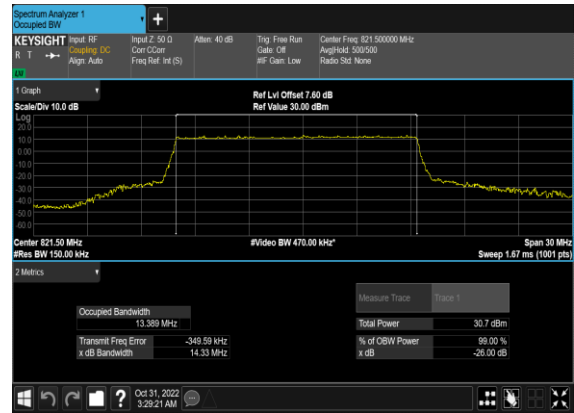

N26(15M)_CP-OFDM_QPSK_Outer_Full_Mid_CH



N26(15M)_CP-OFDM_16 QAM_Outer_Full_Mid_CH

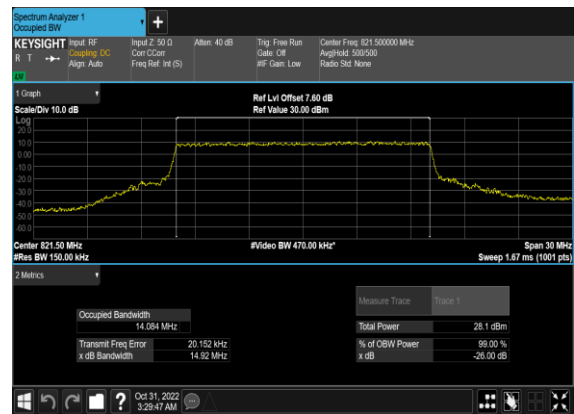

N26(15M)_CP-OFDM_64 QAM_Outer_Full_Mid_CH

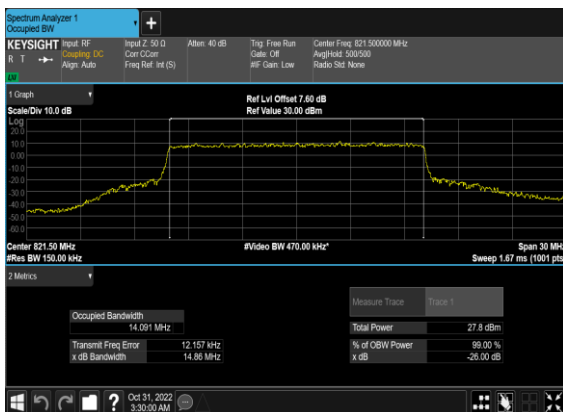

N26(15M)_CP-OFDM_256 QAM_Outer_Full_Mid_CH

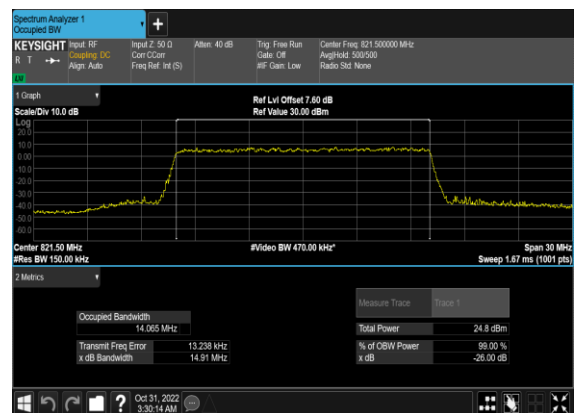



N26(20M)_DFT-s-OFDM_PI_2-BPSK_Outer_Full_Mid_CH

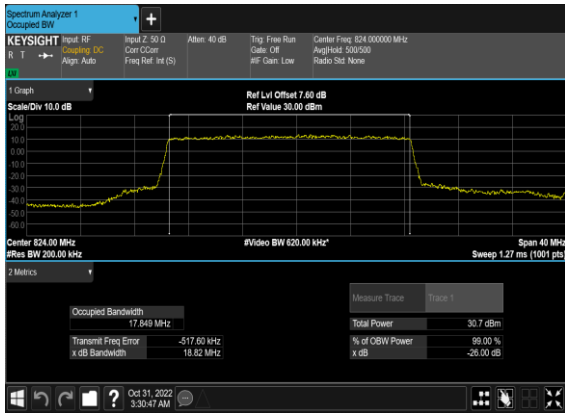

N26(20M)_DFT-s-OFDM_QPSK_Outer_Full_Mid_CH

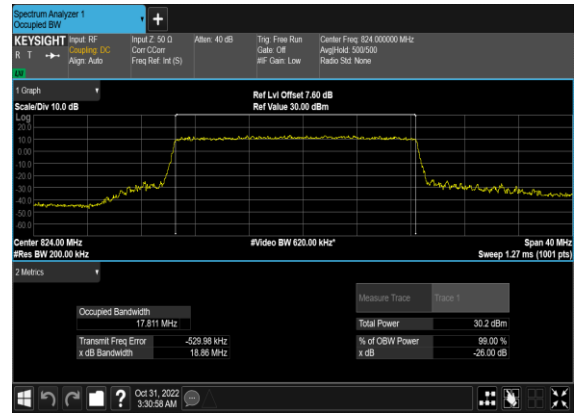

N26(20M)_CP-OFDM_QPSK_Outer_Full_Mid_CH



N26(20M)_CP-OFDM_16 QAM_Outer_Full_Mid_CH

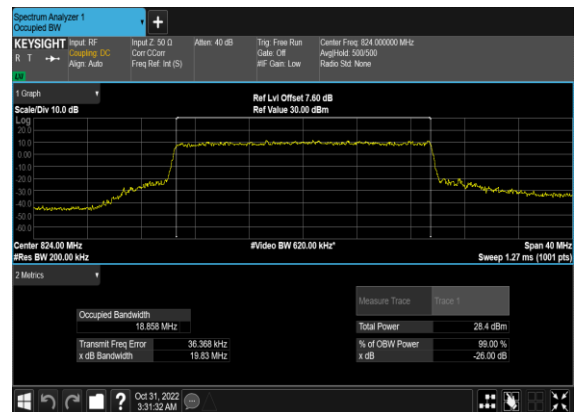

N26(20M)_CP-OFDM_64 QAM_Outer_Full_Mid_CH

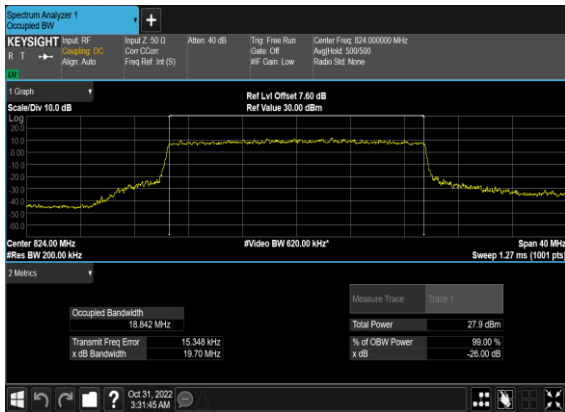

N26(20M)_CP-OFDM_256 QAM_Outer_Full_Mid_CH

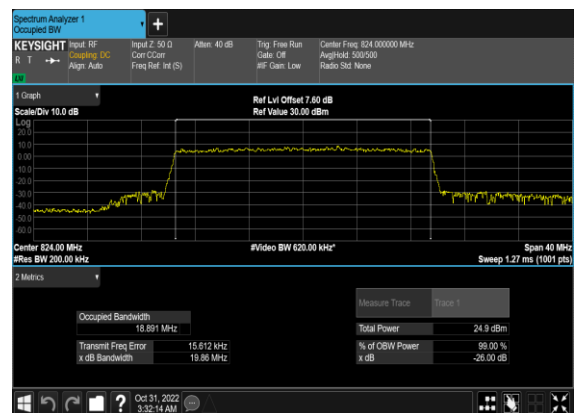



Conducted Spurious Emissions

NR Band	SCS (kHz)	Bandwidth (MHz)	Arfcn	Freq (MHz)	Modulation	RB	Result	Verdict
26	15	5	163300	816.5	DFT-s-OFDM BPSK	1@0	see graph	---
26	15	5	163300	816.5	DFT-s-OFDM BPSK	1@0	see graph	PASS
26	15	5	163300	816.5	DFT-s-OFDM QPSK	1@0	see graph	---
26	15	5	163300	816.5	DFT-s-OFDM QPSK	1@0	see graph	PASS
26	15	5	163800	819.0	DFT-s-OFDM BPSK	1@0	see graph	---
26	15	5	163800	819.0	DFT-s-OFDM BPSK	1@0	see graph	PASS
26	15	5	163800	819.0	DFT-s-OFDM QPSK	1@0	see graph	---
26	15	5	163800	819.0	DFT-s-OFDM QPSK	1@0	see graph	PASS
26	15	5	164300	821.5	DFT-s-OFDM BPSK	1@0	see graph	---
26	15	5	164300	821.5	DFT-s-OFDM BPSK	1@0	see graph	PASS
26	15	5	164300	821.5	DFT-s-OFDM QPSK	1@0	see graph	---
26	15	5	164300	821.5	DFT-s-OFDM QPSK	1@0	see graph	PASS
26	15	10	163800	819.0	DFT-s-OFDM BPSK	1@0	see graph	---
26	15	10	163800	819.0	DFT-s-OFDM BPSK	1@0	see graph	PASS
26	15	10	163800	819.0	DFT-s-OFDM QPSK	1@0	see graph	---
26	15	10	163800	819.0	DFT-s-OFDM QPSK	1@0	see graph	PASS
26	15	20	164800	824.0	DFT-s-OFDM BPSK	1@0	see graph	---
26	15	20	164800	824.0	DFT-s-OFDM BPSK	1@0	see graph	PASS
26	15	20	164800	824.0	DFT-s-OFDM QPSK	1@0	see graph	---
26	15	20	164800	824.0	DFT-s-OFDM QPSK	1@0	see graph	PASS



N26(5M)_DFT-s-OFDM_BPSK_Edge_1RB_Left_Lo

w_CH

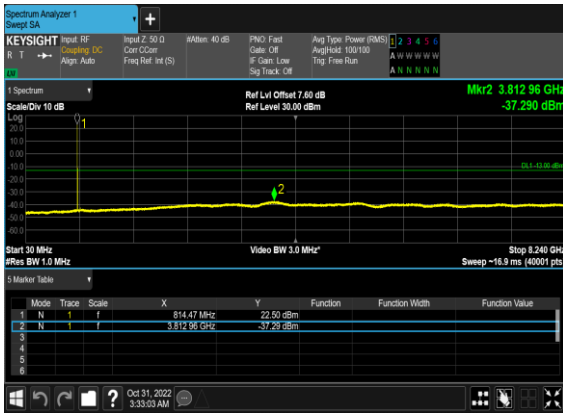

N26(5M)_DFT-s-OFDM_QPSK_Edge_1RB_Left_Lo

w_CH

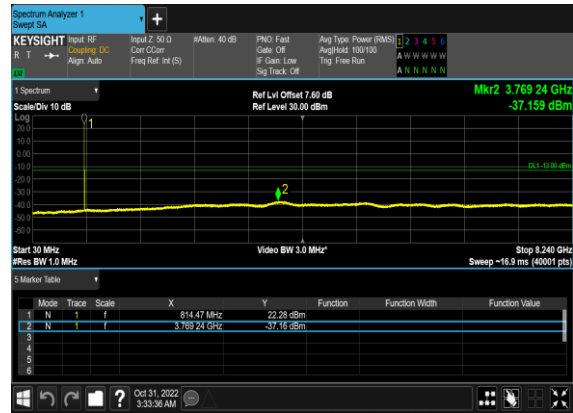

N26(5M)_DFT-s-OFDM_BPSK_Edge_1RB_Left_Mid

_CH

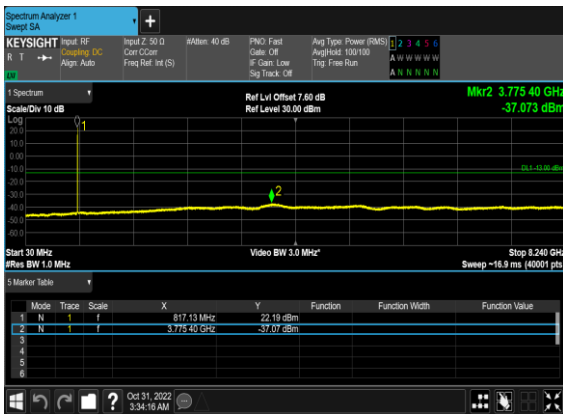

N26(5M)_DFT-s-OFDM_QPSK_Edge_1RB_Left_Mid

_CH

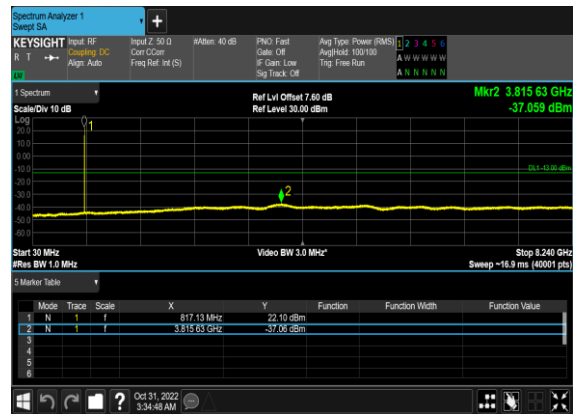

N26(5M)_DFT-s-OFDM_BPSK_Edge_1RB_Left_Hig

h_CH

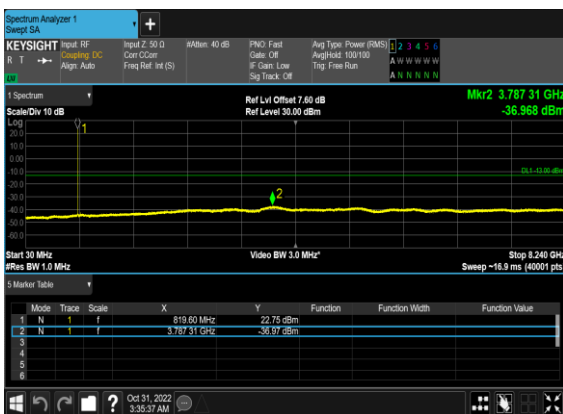

N26(5M)_DFT-s-OFDM_QPSK_Edge_1RB_Left_Hig

h_CH

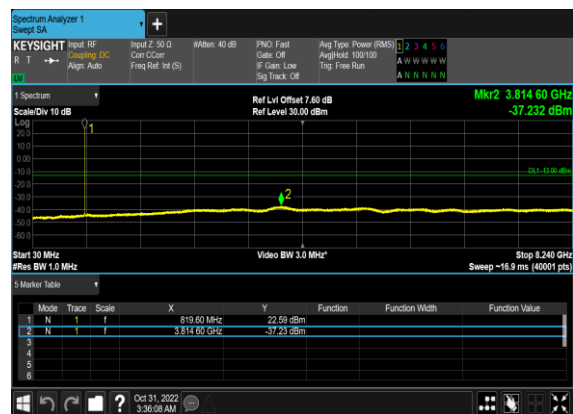



N26(10M)_DFT-s-OFDM_BPSK_Edge_1RB_Left_Mi

d_CH

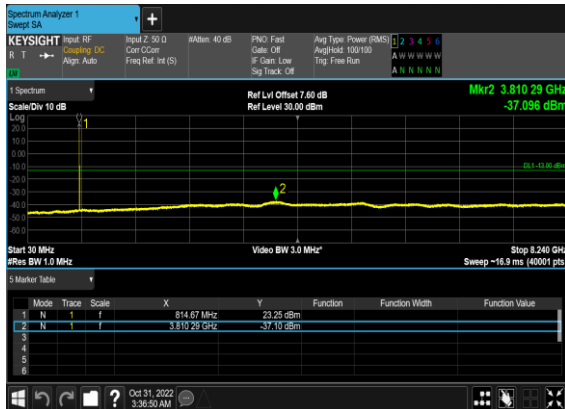

N26(10M)_DFT-s-OFDM_QPSK_Edge_1RB_Left_Mi

d_CH

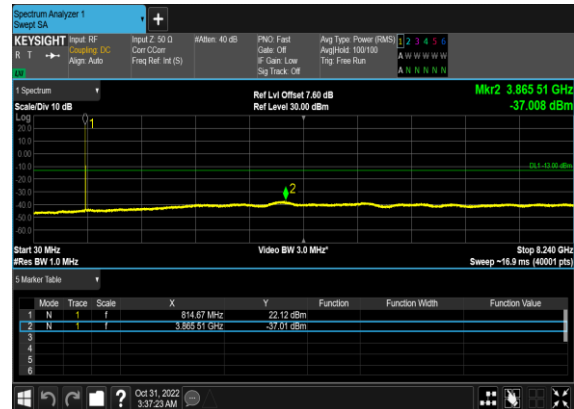

N26(20M)_DFT-s-OFDM_BPSK_Edge_1RB_Left_Mi

d_CH

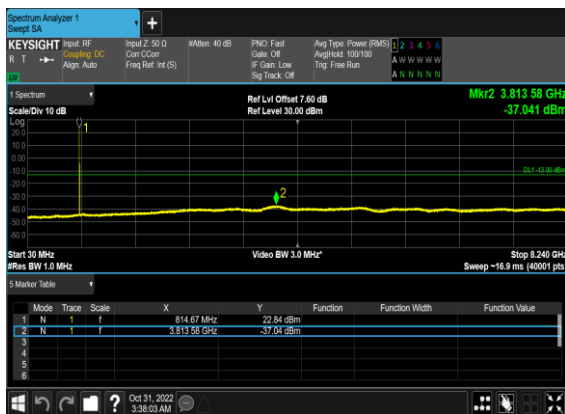

N26(20M)_DFT-s-OFDM_QPSK_Edge_1RB_Left_Mi

d_CH

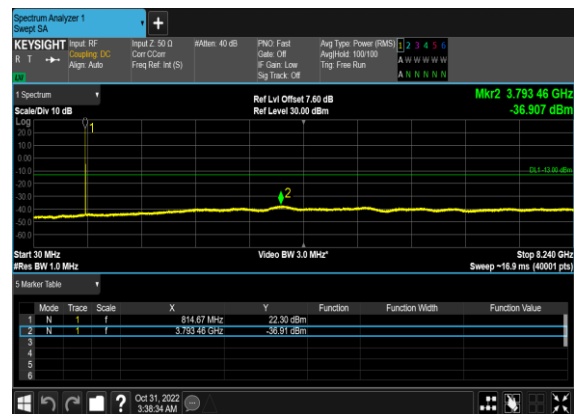



Conducted Band Edge

NR Band	SCS (kHz)	Bandwidth (MHz)	Arfcn	Freq (MHz)	Modulation	RB	Result	Verdict
26	15	5	163300	816.5	DFT-s-OFDM BPSK	1@0	see graph	PASS
26	15	5	163300	816.5	DFT-s-OFDM QPSK	1@0	see graph	PASS
26	15	5	163300	816.5	DFT-s-OFDM BPSK	25@0	see graph	PASS
26	15	5	163300	816.5	DFT-s-OFDM QPSK	25@0	see graph	PASS
26	15	5	164300	821.5	DFT-s-OFDM BPSK	1@24	see graph	PASS
26	15	5	164300	821.5	DFT-s-OFDM QPSK	1@24	see graph	PASS
26	15	5	164300	821.5	DFT-s-OFDM BPSK	25@0	see graph	PASS
26	15	5	164300	821.5	DFT-s-OFDM QPSK	25@0	see graph	PASS
26	15	10	163800	819.0	DFT-s-OFDM BPSK	1@0	see graph	PASS
26	15	10	163800	819.0	DFT-s-OFDM QPSK	1@0	see graph	PASS
26	15	10	163800	819.0	DFT-s-OFDM BPSK	1@51	see graph	PASS
26	15	10	163800	819.0	DFT-s-OFDM QPSK	1@51	see graph	PASS
26	15	10	163800	819.0	DFT-s-OFDM BPSK	50@0	see graph	PASS
26	15	10	163800	819.0	DFT-s-OFDM QPSK	50@0	see graph	PASS
26	15	20	164800	824.0	DFT-s-OFDM BPSK	1@0	see graph	PASS
26	15	20	164800	824.0	DFT-s-OFDM QPSK	1@0	see graph	PASS
26	15	20	164800	824.0	DFT-s-OFDM BPSK	100@0	see graph	PASS
26	15	20	164800	824.0	DFT-s-OFDM QPSK	100@0	see graph	PASS



N26(5M)_DFT-s-OFDM_BPSK_Edge_1RB_Left_Lo

w_CH

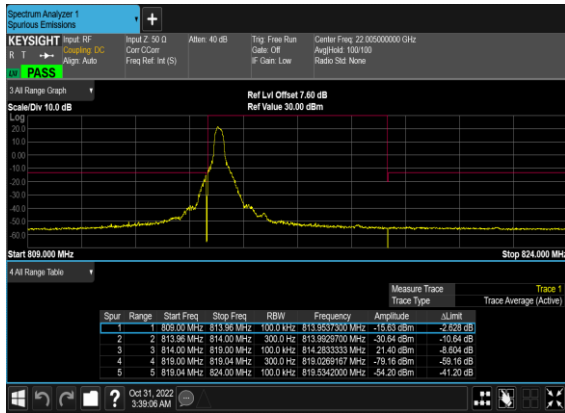

N26(5M)_DFT-s-OFDM_QPSK_Edge_1RB_Left_Lo

w_CH

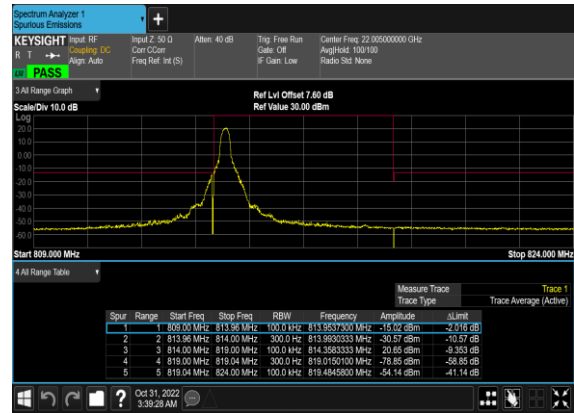

N26(5M)_DFT-s-OFDM_BPSK_Outer_Full_Low_CH

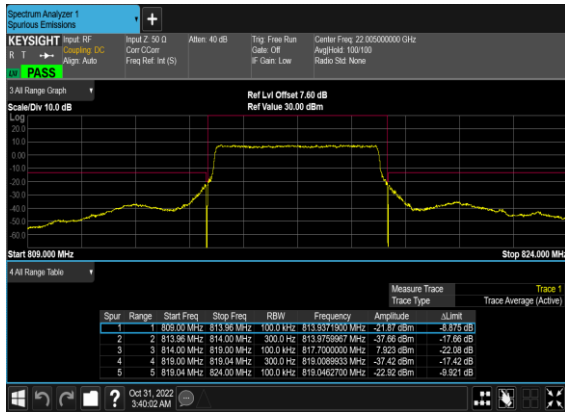

N26(5M)_DFT-s-OFDM_QPSK_Outer_Full_Low_CH

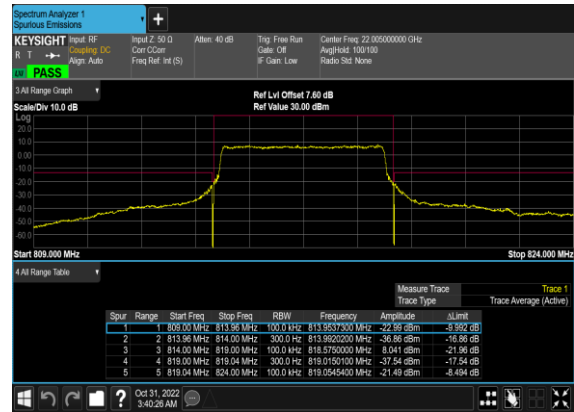

N26(5M)_DFT-s-OFDM_BPSK_Edge_1RB_Right_Hi

gh_CH

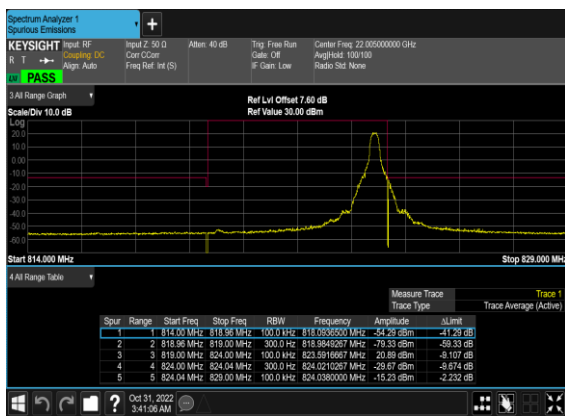

N26(5M)_DFT-s-OFDM_QPSK_Edge_1RB_Right_Hi

gh_CH

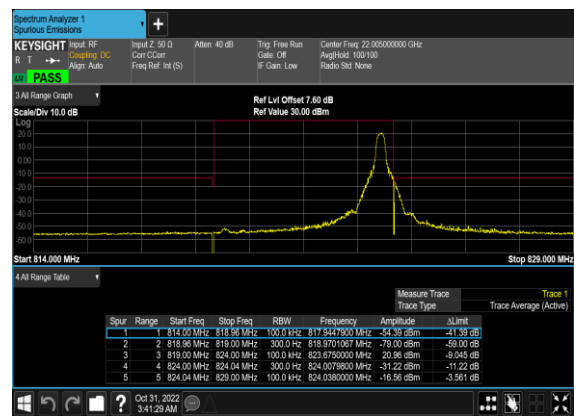



N26(5M)_DFT-s-OFDM_BPSK_Outer_Full_High_C

H

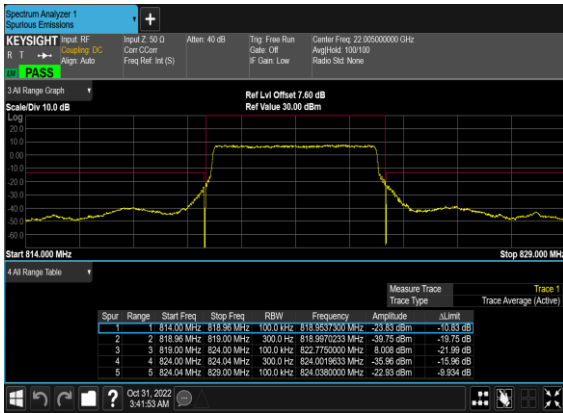

N26(5M)_DFT-s-OFDM_QPSK_Outer_Full_High_C

H

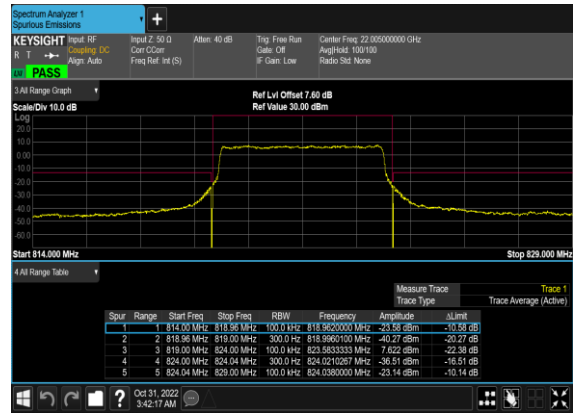

N26(10M)_DFT-s-OFDM_BPSK_Edge_1RB_Left_Mi

d_CH

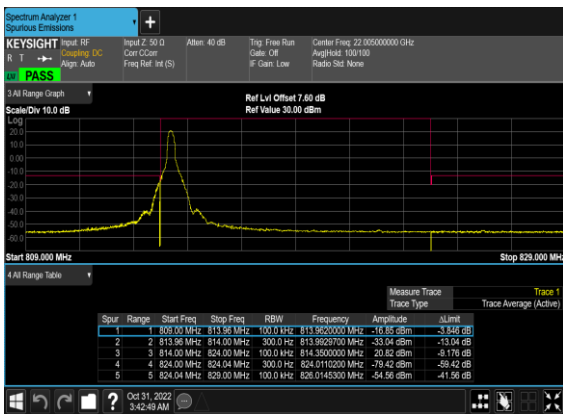

N26(10M)_DFT-s-OFDM_QPSK_Edge_1RB_Left_Mi

d_CH

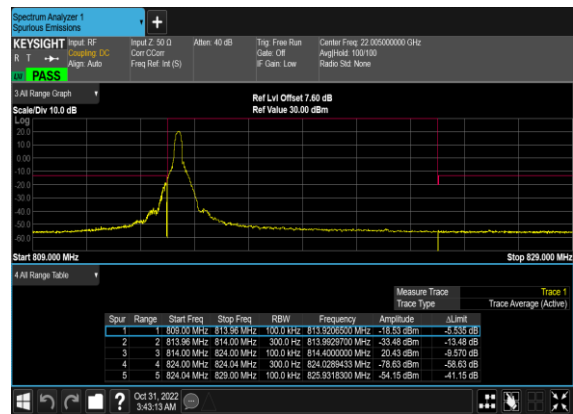

N26(10M)_DFT-s-OFDM_BPSK_Edge_1RB_Right

Mid_CH

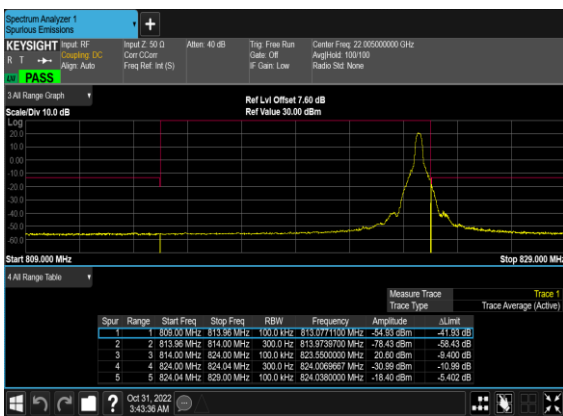

N26(10M)_DFT-s-OFDM_QPSK_Edge_1RB_Right

Mid_CH

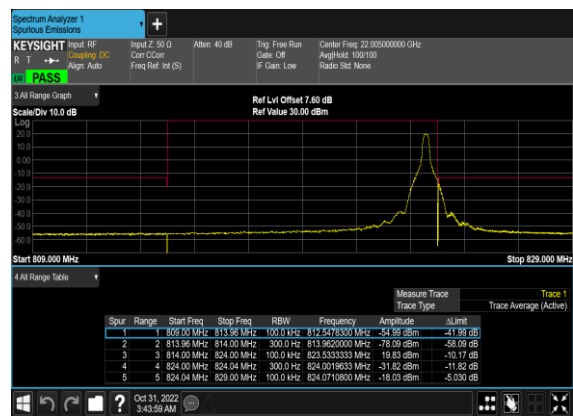



N26(10M)_DFT-s-OFDM_BPSK_Outer_Full_Mid_C

H

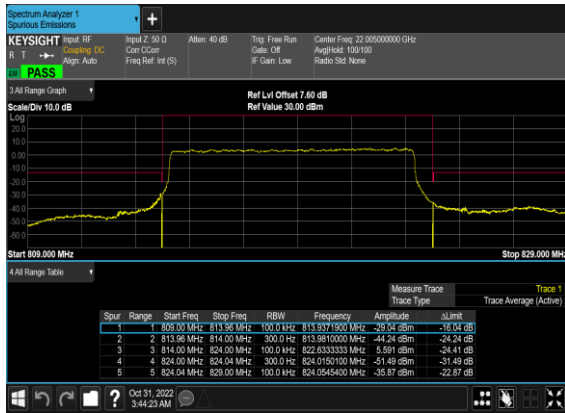

N26(10M)_DFT-s-OFDM_QPSK_Outer_Full_Mid_C

H

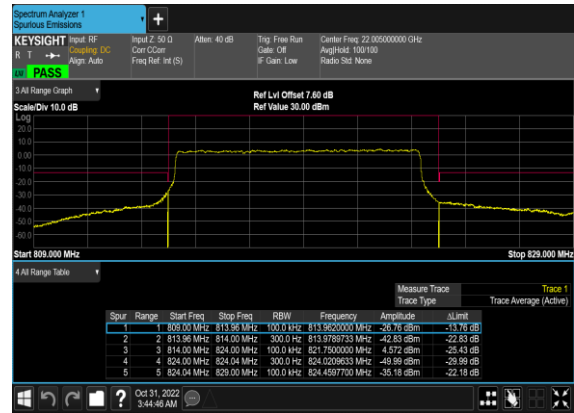

N26(20M)_DFT-s-OFDM_BPSK_Edge_1RB_Left_L

ow_CH

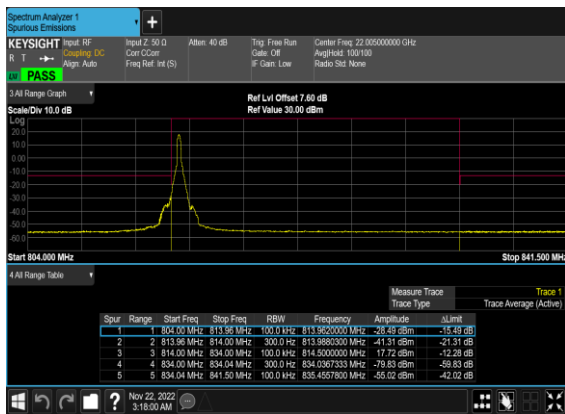

N26(20M)_DFT-s-OFDM_QPSK_Edge_1RB_Left_L

ow_CH

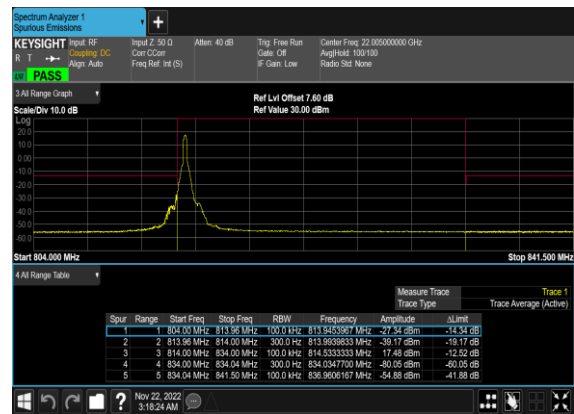

N26(20M)_DFT-s-OFDM_BPSK_Outer_Full_Low_C

H

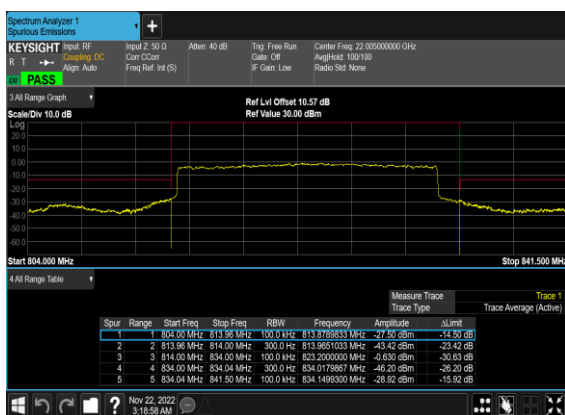

N26(20M)_DFT-s-OFDM_QPSK_Outer_Full_Low_C

H

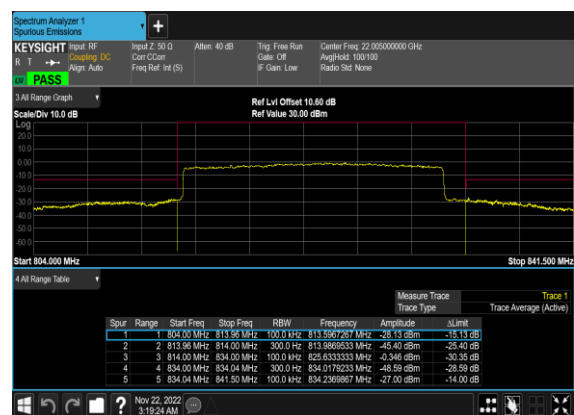



Appendix B. Test Results of Radiated Test

Radiated Spurious Emission

Test Engineer :	LiangHuaCong	Temperature :	22~25°C
		Relative Humidity :	48~52%

N26 SA / NR 20MHz / QPSK / ANT0									
Channel	Frequency (MHz)	EIRP (dBm)	Limit (dBm)	Over Limit (dB)	SPA Reading (dBm)	S.G. Power (dBm)	TX Cable loss (dB)	TX Antenna Gain (dBi)	Polarization (H/V)
Middle	1630.36	-55.77	-13	-42.77	-61.91	-59.02	4.00	9.40	H
	2445.54	-39.51	-13	-26.51	-49.82	-43.08	4.88	10.60	H
	3260.72	-64.32	-13	-51.32	-76.83	-69.25	5.52	12.60	H
	1630.36	-57.20	-13	-44.20	-63.37	-60.45	4.00	9.40	V
	2445.54	-39.11	-13	-26.11	-49.80	-42.68	4.88	10.60	V
	3260.72	-63.74	-13	-50.74	-76.77	-68.67	5.52	12.60	V

Remark: Spurious emissions within 30-1000MHz were found more than 20dB below limit line.