



FCC RF Test Report

APPLICANT : Motorola Mobility LLC
EQUIPMENT : Mobile Cellular Phone
BRAND NAME : Motorola
MODEL NAME : XT2301-1
FCC ID : IHDT56AH1
STANDARD : 47 CFR Part 2, 96
CLASSIFICATION : Citizens Band End User Devices (CBE)
EQUIPMENT TYPE : End User Equipment
TEST DATE(S) : Nov. 08, 2022 ~ Nov. 30, 2022

We, Sporton International Inc. (ShenZhen), would like to declare that the tested sample has been evaluated in accordance with the procedures given in ANSI C63.26 and shown compliance with the applicable technical standards.

The test results in this report apply exclusively to the tested model / sample. Without written approval of Sporton International Inc. (ShenZhen), the test report shall not be reproduced except in full.

Jason Jia



Approved by: Jason Jia

Sporton International Inc. (ShenZhen)

1/F, 2/F, Bldg 5, Shiling Industrial Zone, Xinwei Village, Xili, Nanshan, Shenzhen, 518055

People's Republic of China



Table of Contents

History of this test report..... 3

Summary of Test Result..... 4

1 General Description 5

 1.1 Applicant..... 5

 1.2 Manufacturer 5

 1.3 Feature of Equipment Under Test..... 5

 1.4 Maximum EIRP Power and Emission Designator 6

 1.5 Testing Site..... 7

 1.6 Test Software 7

 1.7 Applied Standards 8

 1.8 Specification of Accessory 8

2 Test Configuration of Equipment Under Test 9

 2.1 Test Mode..... 9

 2.2 Connection Diagram of Test System 10

 2.3 Support Unit used in test configuration 11

 2.4 Measurement Results Explanation Example 11

 2.5 Frequency List of Low/Middle/High Channels..... 11

3 Conducted Test Items 13

 3.1 Measuring Instruments..... 13

 3.2 Conducted Output Power 14

 3.3 Peak-to-Average Ratio 15

 3.4 EIRP and PSD..... 16

 3.5 Occupied Bandwidth 17

 3.6 Conducted Band Edge 18

 3.7 Conducted Spurious Emission 19

 3.8 Frequency Stability..... 20

4 Radiated Test Items 21

 4.1 Measuring Instruments..... 21

 4.2 Test Setup 21

 4.3 Test Result of Radiated Test..... 22

 4.4 Radiated Spurious Emission 23

5 List of Measuring Equipment..... 24

6 Uncertainty of Evaluation 25

Appendix A. Test Results of Conducted Test

Appendix B. Test Results of Radiated Test

Appendix C. Test Setup Photographs



Summary of Test Result

Report Clause	Ref Std. Clause	Test Items	Result (PASS/FAIL)	Remark
3.2	§2.1046	Conducted Output Power	Reporting only	-
3.3	§96.41	Peak-to-Average Ratio	Pass	Not applicable for End User Devices
3.4	§96.41	Maximum E.I.R.P	Pass	-
		Maximum Power Spectral Density	Pass	Not applicable for End User Devices
3.5	§2.1049 §96.41	Occupied Bandwidth	Reporting only	-
3.6	§2.1051 §96.41	Conducted Band Edge Measurement Adjacent Channel Leakage Ratio	Pass	-
3.7	§2.1051 §96.41	Conducted Spurious Emission	Pass	
3.8	§2.1055	Frequency Stability for Temperature & Voltage	Pass	-
4.4	§2.1051 §96.41	Radiated Spurious Emission	Pass	Under limit 3.52 dB at 10872.000 MHz

Declaration of Conformity:
The test results with all measurement uncertainty excluded are presented in accordance with the regulation limits or requirements declared by manufacturers.
Comments and Explanations:
The declared of product specification for EUT presented in the report are provided by the manufacturer, and the manufacturer takes all the responsibilities for the accuracy of product specification.



1 General Description

1.1 Applicant

Motorola Mobility LLC
222 W,Merchandise Mart Plaza, Chicago IL 60654 USA

1.2 Manufacturer

Motorola Mobility LLC
222 W,Merchandise Mart Plaza, Chicago IL 60654 USA

1.3 Feature of Equipment Under Test

Product Feature	
Equipment	Mobile Cellular Phone
Brand Name	Motorola
Model Name	XT2301-1
FCC ID	IHDT56AH1
Tx Frequency	LTE Band 48: 3550 MHz ~ 3700 MHz
Rx Frequency	LTE Band 48: 3550 MHz ~ 3700 MHz
Bandwidth	5MHz / 10MHz / 15MHz / 20MHz
Maximum Output Power to Antenna	LTE Band 48: Ant.3: 21.52dBm Ant.8: 19.55dBm LTE Band 48C: Ant.3: 21.50dBm Ant.8: 19.53 dBm
Antenna Gain	Ant.3: -1.80 dBi Ant.8:-2.00 dBi
Type of Modulation	QPSK / 16QAM / 64QAM / 256QAM
IMEI Code	Conducted: 350007550023676/350007550023684 Radiation: 350007550014055/350007550014063
HW Version	DVT2
SW Version	TTR33.124
EUT Stage	Identical Prototype

Remark:

1. The above EUT's information was declared by manufacturer. Please refer to the specifications or user's manual for more detailed description.
2. The maximum EIRP is calculated from max output power and antenna gain, only the maximum EIRP of antenna 3 is shown in the report.



1.4 Maximum EIRP Power and Emission Designator

LTE Band 48		QPSK		16QAM/64QAM/256QAM	
BW (MHz)	Frequency Range (MHz)	Maximum EIRP(W)	Emission Designator (99%OBW)	Maximum EIRP(W)	Emission Designator (99%OBW)
5	3552.5~3697.5	0.0938	4M53G7D	0.0778	4M52W7D
10	3555~3695	0.0927	9M07G7D	0.0766	9M09W7D
15	3557.5~3692.5	0.0933	13M5G7D	0.0771	13M5W7D
20	3560~3690	0.0938	17M9G7D	0.0783	17M9W7D

LTE Band 48 CA		QPSK		16QAM/64QAM/256QAM	
BW (MHz) Frequency (MHz)		Maximum EIRP(W)	Emission Designator (99%OBW)	Maximum EIRP(W)	Emission Designator (99%OBW)
5MHz+20MHz (3553.5 ~ 3690 MHz)		0.0929	23M5G7D	0.0927	23M3W7D
10MHz+20MHz (3555.5 ~ 3690 MHz)		0.0891	28M2G7D	0.0925	28M1W7D
15MHz+20MHz (3557.8 ~ 3690 MHz)		0.0920	33M1G7D	0.0918	32M9W7D
20MHz+5MHz (3560 ~ 3696.7 MHz)		0.0904	23M4G7D	0.0918	23M3W7D
20MHz+10MHz (3560 ~ 3694.5 MHz)		0.0931	28M1G7D	0.0927	28M2W7D
20MHz+15MHz (3560 ~ 3692.2 MHz)		0.0914	33M0G7D	0.0931	33M1W7D
20MHz+20MHz (3560 ~ 3690 MHz)		0.0933	38M0G7D	0.0927	37M8W7D



1.5 Testing Site

Sporton International Inc. (ShenZhen) is accredited to ISO/IEC 17025:2017 by American Association for Laboratory Accreditation with Certificate Number 5145.01.

Test Firm	Sporton International Inc. (ShenZhen)		
Test Site Location	1/F, 2/F, Bldg 5, Shiling Industrial Zone, Xinwei Village, Xili, Nanshan, Shenzhen, 518055 People's Republic of China TEL: +86-755-86379589 FAX: +86-755-86379595		
Test Site No.	Sporton Site No.	FCC Designation No.	FCC Test Firm Registration No.
	TH01-SZ	CN1256	421272

Test Firm	Sporton International Inc. (ShenZhen)		
Test Site Location	101, 1st Floor, Block B, Building 1, No. 2, Tengfeng 4th Road, Fenghuang Community, Fuyong Street, Baoan District, Shenzhen City Guangdong Province China 518103 TEL: +86-755-33202398		
Test Site No.	Sporton Site No.	FCC Designation No.	FCC Test Firm Registration No.
	03CH03-SZ	CN1256	421272

1.6 Test Software

Item	Site	Manufacturer	Name	Version
1.	03CH03-SZ	AUDIX	E3	6.2009-8-24



1.7 Applied Standards

According to the specifications of the manufacturer, the EUT must comply with the requirements of the following standards:

- ♦ ANSI C63.26-2015
- ♦ 47 CFR Part 2, 96
- ♦ FCC KDB 971168 D01 Power Meas. License Digital Systems v03r01
- ♦ FCC KDB 940660 D01 Part 96 CBRS v03
- ♦ FCC KDB 412172 D01 Determining ERP and EIRP v01r01

Remark:

1. All test items were verified and recorded according to the standards and without any deviation during the test.
2. This EUT has also been tested and complied with the requirements of FCC Part 15, Subpart B, recorded in a separate test report.

1.8 Specification of Accessory

Specification of Accessory				
AC Adapter 1(US)	Brand Name	Motorola (Chenyang)	Model Name	MC-681N
AC Adapter 2(US)	Brand Name	Motorola (Acbel)	Model Name	MC-681N
Battery 1	Brand Name	Motorola(SCUD)	Model Name	PC51
Earphone 1	Brand Name	Motorola (Lyand)	Model Name	MI181C(SH38D62338)
USB Cable 1	Brand Name	Motorola(Saibao)	Model Name	SC18D24968
C to HDMI HDMI/USBC Cable 1	Brand Name	Motorola(Linxee)	Model Name	SC18D02146
C to HDMI HDMI/USBC Cable 2	Brand Name	Motorola(Linxee)	Model Name	SC18D38847



2 Test Configuration of Equipment Under Test

2.1 Test Mode

Antenna port conducted and radiated test items listed below are performed according to KDB 971168 D01 Power Meas. License Digital Systems v03r01 with maximum output power.

For radiated measurement, pre-scanned in three orthogonal panels, X, Y, Z. The worst cases (X plane) were recorded in this report.

Test Items	Band	Bandwidth (MHz)						Modulation				RB #			Test Channel		
		1.4	3	5	10	15	20	QPSK	16QAM	64QAM	256QAM	1	Half	Full	L	M	H
Max. Output Power	48	-	-	v	v	v	v	v	v	v	v	v	v	v	v	v	v
26dB and 99% Bandwidth	48	-	-	v	v	v	v	v	v	v				v	v	v	v
Conducted Band Edge	48	-	-	v	v	v	v	v	v	v			v	v	v	v	v
Peak-to-Average Ratio	48	-	-				v	v	v	v			v	v	v	v	v
Conducted Spurious Emission	48	-	-	v	v	v	v	v	v	v			v	v	v	v	v
E.I.R.P	48	-	-	v	v	v	v	v	v	v	v	v	v	v	v	v	v
Frequency Stability	48	-	-		v			v					v			v	
Radiated Spurious Emission	48	Worst Case												v	v	v	
Remark	<ol style="list-style-type: none"> The mark "v" means that this configuration is chosen for testing The mark "-" means that this bandwidth is not supported. The device is investigated from 30MHz to 10 times of fundamental signal for radiated spurious emission test under different RB size/offset and modulations in exploratory test. Subsequently, only the worst case emissions are reported. All the radiated test cases were performed with Adapter. 																

Test Items	Band	Bandwidth (MHz)								Modulation				RB #			Test Channel			
		20+20	20+15	15+20	20+10	10+20	10+10	20+5	5+20	QPSK	16QAM	64QAM	256 QAM	1	Half	Full	L	M	H	
Max. Output Power	48C	v	v	v	v	v	-	v	v	v	v	v	v	v		v	v	v	v	
26dB and 99% Bandwidth	48C	v	v	v	v	v	-	v	v	v	v	v				v	v	v	v	
Conducted Band Edge	48C	v	v	v	v	v	-	v	v	v	v	v		v		v	v	v	v	
Conducted Spurious Emission	48C	v	v	v	v	v	-	v	v	v	v	v		v		v	v	v	v	
Adjacent Channel Leakage Ratio	48C	v	v	v	v	v	-	v	v	v	v	v		v		v	v	v	v	
E.I.R.P	48C	v	v	v	v	v	-	v	v	v	v	v	v	v		v	v	v	v	
Radiated Spurious Emission	48C	Worst Case																	v	
Note	<ol style="list-style-type: none"> The mark "v" means that this configuration is chosen for testing The mark "-" means that this bandwidth is not supported. The device is investigated from 30MHz to 10 times of fundamental signal for radiated spurious emission test under different RB size/offset and modulations in exploratory test. Subsequently, only the worst case emissions are reported. All test items are based on engineering evaluation. All the radiated test cases were performed with Adapter. 																			

2.2 Connection Diagram of Test System

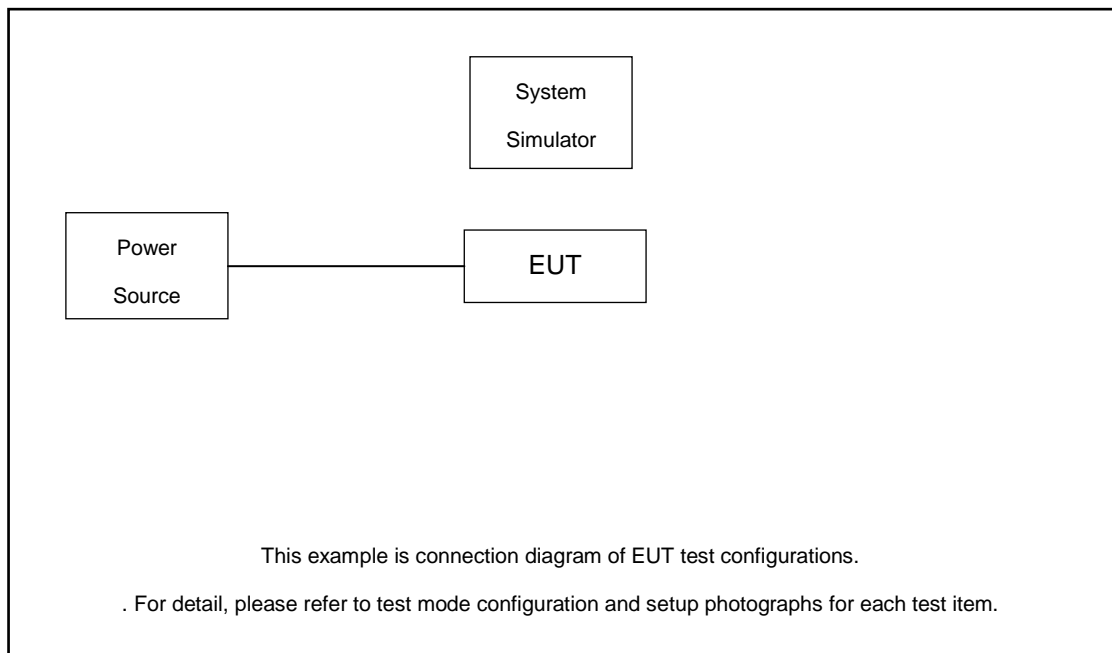

2.3 Support Unit used in test configuration

Item	Equipment	Trade Name	Model No.	FCC ID	Data Cable	Power Cord
1.	Power Supply	GWINSTEK	PSS-2002	N/A	N/A	Unshielded, 1.8 m
2.	LTE Base Station	Anritsu	MT8821C	N/A	N/A	Unshielded, 1.8 m
3.	Fixture	INTEL	NGFF Card Carrier	N/A	N/A	N/A

2.4 Measurement Results Explanation Example

For all conducted test items:

The offset level is set in the spectrum analyzer to compensate the RF cable loss and attenuator factor between EUT conducted output port and spectrum analyzer. With the offset compensation, the spectrum analyzer reading level is exactly the EUT RF output level.

The spectrum analyzer offset is derived from RF cable loss and attenuator factor.

Offset = RF cable loss + attenuator factor.

Following shows an offset computation example with cable loss 5.5 dB and 10dB attenuator.

Example :

$$\begin{aligned} \text{Offset(dB)} &= \text{RF cable loss(dB)} + \text{attenuator factor(dB)} \\ &= 5.5 + 10 = 15.5(\text{dB}) \end{aligned}$$

2.5 Frequency List of Low/Middle/High Channels

LTE Band 48 Channel and Frequency List				
BW [MHz]	Channel/Frequency(MHz)	Lowest	Middle	Highest
20	Channel	55340	55990	56640
	Frequency	3560.0	3625.0	3690.0
15	Channel	55315	55990	56665
	Frequency	3557.5	3625.0	3692.5
10	Channel	55290	55990	56690
	Frequency	3555.0	3625.0	3695.0
5	Channel	55265	55990	56715
	Frequency	3552.5	3625.0	3697.5



LTE Band 48C_CA Channel and Frequency List					
BW [MHz]	Channel/Frequency(MHz)		Lowest	Middle	Highest
5 + 20	PCC	Channel	55273	55898	56523
		Frequency	3553.3	3615.8	3678.3
	SCC	Channel	55390	56015	56640
		Frequency	3565	3627.5	3690
20 + 5	PCC	Channel	55340	55965	56590
		Frequency	3560	3622.5	3685
	SCC	Channel	55457	56082	56707
		Frequency	3571.7	3634.2	3696.7
10 + 20	PCC	Channel	55295	55896	56496
		Frequency	3555.5	3615.6	3675.6
	SCC	Channel	55439	56040	56640
		Frequency	3569.9	3630	3690
20 + 10	PCC	Channel	55340	55941	56541
		Frequency	3560	3620.1	3680.1
	SCC	Channel	55484	56085	56685
		Frequency	3574.4	3634.5	3694.5
15 + 20	PCC	Channel	55318	55893	56469
		Frequency	3557.8	3615.3	3672.9
	SCC	Channel	55489	56064	56640
		Frequency	3574.9	3632.4	3690
20 + 15	PCC	Channel	55340	55916	56491
		Frequency	3560	3617.6	3675.1
	SCC	Channel	55511	56087	56662
		Frequency	3577.1	3634.7	3692.2
20 + 20	PCC	Channel	55340	55891	56442
		Frequency	3560	3615.1	3670.2
	SCC	Channel	55538	56089	56640
		Frequency	3579.8	3634.9	3690

3 Conducted Test Items

3.1 Measuring Instruments

See list of measuring instruments of this test report.

3.1.1 Test Setup

3.1.2 Conducted Output Power



3.1.3 PSD, Peak-to-Average Ratio, Occupied Bandwidth, Conducted Band-Edge and Conducted Spurious Emission

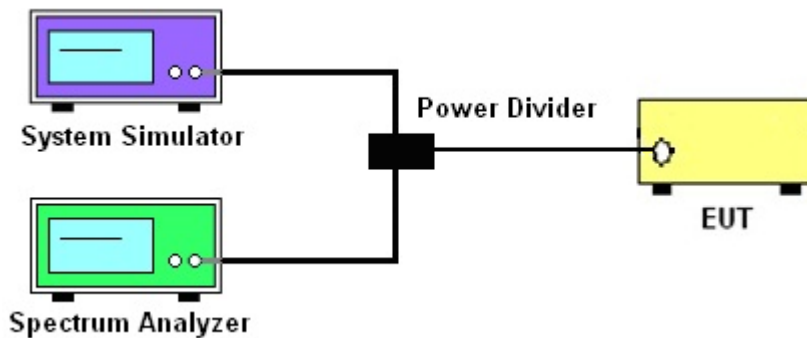

3.1.4 Frequency Stability

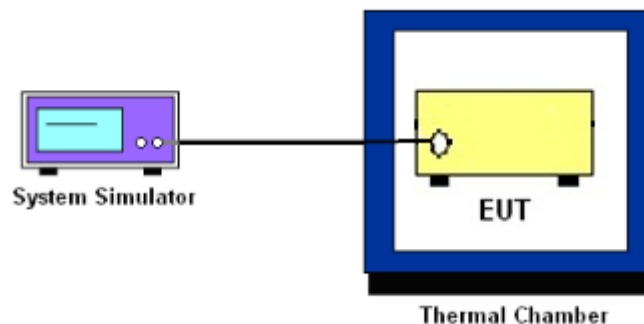

3.1.5 Test Result of Conducted Test

Please refer to Appendix A.



3.2 Conducted Output Power

3.2.1 Description of the Conducted Output Power Measurement

A system simulator was used to establish communication with the EUT. Its parameters were set to force the EUT transmitting at maximum output power. The measured power in the radio frequency on the transmitter output terminals shall be reported.

3.2.2 Test Procedures

1. The transmitter output port was connected to the system simulator.
2. Set EUT at maximum power through the system simulator.
3. Select lowest, middle, and highest channels for each band and different modulation.
4. Measure and record the power level from the system simulator.



3.3 Peak-to-Average Ratio

3.3.1 Description of the PAR Measurement

Power Complementary Cumulative Distribution Function (CCDF) curves provide a means for characterizing the power peaks of a digitally modulated signal on a statistical basis. A CCDF curve depicts the probability of the peak signal amplitude exceeding the average power level. Most contemporary measurement instrumentation include the capability to produce CCDF curves for an input signal provided that the instrument's resolution bandwidth can be set wide enough to accommodate the entire input signal bandwidth. In measuring transmissions in this band using an average power technique, the peak-to-average ratio (PAR) of the transmission may not exceed 13 dB.

3.3.2 Test Procedures

The testing follows ANSI C63.26-2015 Section 5.2.6

1. The EUT was connected to spectrum and system simulator via a power divider.
2. Set the CCDF (Complementary Cumulative Distribution Function) option in spectrum analyzer.
3. The highest RF powers were measured and recorded the maximum PAPR level associated with a probability of 0.1 %.
4. Record the deviation as Peak to Average Ratio

3.4 EIRP and PSD

3.4.1 Description of the EIRP and PSD Measurement

EIRP and PSD limits for CBRS equipment as below table:

Device		Maximum EIRP (dBm/10 MHz)	Maximum PSD (dBm/MHz)
Applied	End User Device	23	n/a
	Category A CBSD	30	20
	Category B CBSD	47	37

Remark: The worst case EIRP shown in this section is found with LTE operating only using 1RB. As such, the EIRP/10MHz and full channel EIRP values will be identical since 1RB is fully contained within all available channel bandwidths for LTE Band 48 (i.e. 5, 10, 15, 20MHz)

3.4.2 Test Procedures for EIRP

1. Establishing a communications link with the call box (Base station) to measure the Maximum conducted power, the parameters were set to force the EUT transmitting at maximum output power level. Use the average power measurement function to measure total channel power of each channel bandwidth (per ANSI C63.26-2015 Section 5.2.1)
2. Determining ERP and/or EIRP from conducted RF output power measurements (Per ANSI C63.26-2015 Section 5.2.5.5)
$$\text{EIRP} = P_T + G_T - L_C, \text{ ERP} = \text{EIRP} - 2.15, \text{ where}$$
$$P_T = \text{transmitter output power in dBm}$$
$$G_T = \text{gain of the transmitting antenna in dBi}$$
$$L_C = \text{signal attenuation in the connecting cable between the transmitter and antenna in dB}$$



3.5 Occupied Bandwidth

3.5.1 Description of Occupied Bandwidth Measurement

The occupied bandwidth is the width of a frequency band such that, below the lower and above the upper frequency limits, the mean powers emitted are each equal to a specified percentage 0.5% of the total mean transmitted power.

The 26 dB emission bandwidth is defined as the frequency range between two points, one above and one below the carrier frequency, at which the spectral density of the emission is attenuated 26 dB below the maximum in-band spectral density of the modulated signal. Spectral density (power per unit bandwidth) is to be measured with a detector of resolution bandwidth equal to approximately 1.0% of the emission bandwidth.

3.5.2 Test Procedures

The testing follows ANSI C63.26-2015 Section 5.4.3 (26dB) and Section 5.4.4 (99OB)

1. The EUT was connected to spectrum analyzer and system simulator via a power divider.
2. The spectrum analyzer center frequency is set to the nominal EUT channel center frequency. The span range for the spectrum analyzer shall be between two and five times the anticipated OBW.
3. The nominal resolution bandwidth (RBW) shall be in the range of 1 to 5 % of the anticipated OBW, and the VBW shall be at least 3 times the RBW.
4. Set the detection mode to peak, and the trace mode to max hold.
5. Determine the reference value: Set the EUT to transmit a modulated signal. Allow the trace to stabilize. Set the spectrum analyzer marker to the highest level of the displayed trace.
(this is the reference value)
6. Determine the “-26 dB down amplitude” as equal to (Reference Value – X).
7. Place two markers, one at the lowest and the other at the highest frequency of the envelope of the spectral display such that each marker is at or slightly below the “-X dB down amplitude” determined in step 6. If a marker is below this “-X dB down amplitude” value it shall be placed as close as possible to this value. The OBW is the positive frequency difference between the two markers.
8. Use the 99 % power bandwidth function of the spectrum analyzer and report the measured bandwidth.

3.6 Conducted Band Edge

3.6.1 Description of Conducted Band Edge Measurement

Part 96.41 (e) (1) (i)

For CBSD the emission limits outside the fundamental are as follows:

Within 0 MHz to 10 MHz above and below the assigned channel ≤ -13 dBm/MHz

Greater than 10 MHz above and below the assigned channel ≤ -25 dBm/MHz

Part 96.41 (e) (1) (ii)

For End User Devices the emission limits outside the fundamental are as follows:

Within 0 MHz to B MHz above and below the assigned channel ≤ -13 dBm/MHz

Greater than B MHz above and below the assigned channel ≤ -25 dBm/MHz

where B is the bandwidth in megahertz of the assigned channel or multiple contiguous channels of the End User Device.

Notwithstanding the emission limits in this paragraph, the Adjacent Channel Leakage Ratio for End User Devices shall be at least 30 dB.

Part 96.41 (e) (2)

For CBSDs and End User Devices, the conducted power of emissions below 3540 MHz or above 3710 MHz shall not exceed -25 dBm/MHz, and the conducted power of emissions below 3530 MHz or above 3720 MHz shall not exceed -40 dBm/MHz

3.6.2 Test Procedures

The testing follows FCC KDB 971168 D01 v03r01 Section 6.1.

1. The EUT was connected to spectrum analyzer and system simulator via a power divider.
2. The band edges of low and high channels for the highest RF powers were measured.
3. Set RBW $\geq 1\%$ EBW in the 1MHz band immediately outside and adjacent to the band edge.
4. Beyond the 1 MHz band from the band edge, RBW=1MHz was used
5. Offset has included the duty factor for LTE Band 48. Duty factor $=10 \log (1/x)$, where x is the measured duty cycle.
6. Set spectrum analyzer with RMS detector.
7. The RF fundamental frequency should be excluded against the limit line in the operating frequency band.



3.7 Conducted Spurious Emission

3.7.1 Description of Conducted Spurious Emission Measurement

96.41 (e)(2)

The conducted power of any emissions below 3530 MHz or above 3720 MHz shall not exceed -40dBm/MHz.

3.7.2 Test Procedures

The testing follows FCC KDB 971168 D01 v03r01 Section 6.1.

1. The EUT was connected to spectrum analyzer and system simulator via a power divider.
2. The RF output of EUT was connected to the spectrum analyzer by RF cable and attenuator. The path loss was compensated to the results for each measurement.
3. The middle channel for the highest RF power within the transmitting frequency was measured.
4. The conducted spurious emission for the whole frequency range was taken.
5. Make the measurement with the spectrum analyzer's RBW = 1MHz, VBW = 3MHz.
6. Set spectrum analyzer with RMS detector.
7. Taking the record of maximum spurious emission.
8. The RF fundamental frequency should be excluded against the limit line in the operating frequency band.
9. The limit line is -40dBm/MHz.



3.8 Frequency Stability

3.8.1 Description of Frequency Stability Measurement

The frequency stability shall be measured by variation of ambient temperature and variation of primary supply voltage to ensure that the fundamental emission stays within the authorized frequency block. The frequency stability of the transmitter shall be maintained within $\pm 0.00025\%$ ($\pm 2.5\text{ppm}$) of the center frequency

3.8.2 Test Procedures for Temperature Variation

The testing follows FCC KDB 971168 D01 v03r01 Section 9.0.

1. The EUT was set up in the thermal chamber and connected with the system simulator.
2. With power OFF, the temperature was decreased to -30°C and the EUT was stabilized before testing. Power was applied and the maximum change in frequency was recorded within one minute.
3. With power OFF, the temperature was raised in 10°C step up to 50°C . The EUT was stabilized at each step for at least half an hour. Power was applied and the maximum frequency change was recorded within one minute.

3.8.3 Test Procedures for Voltage Variation

The testing follows FCC KDB 971168 D01 v03r01 Section 9.0.

1. The EUT was placed in a temperature chamber at $25\pm 5^{\circ}\text{C}$ and connected with the system simulator.
2. The power supply voltage to the EUT was varied from 85% to 115% of the nominal value measured at the input to the EUT.
3. The variation in frequency was measured for the worst case.

4 Radiated Test Items

4.1 Measuring Instruments

See list of measuring instruments of this test report.

4.2 Test Setup

4.2.1 For radiated test below 30MHz

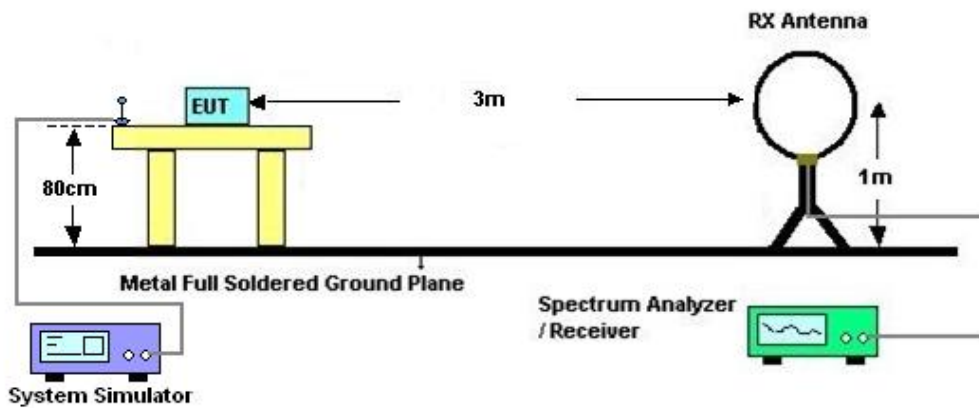

4.2.2 For radiated test from 30MHz to 1GHz

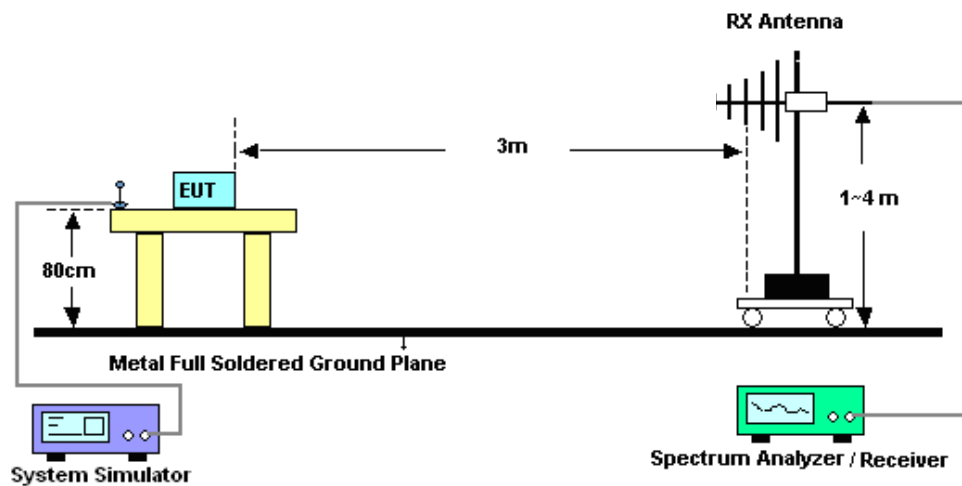

4.2.3 For radiated test above 1GHz

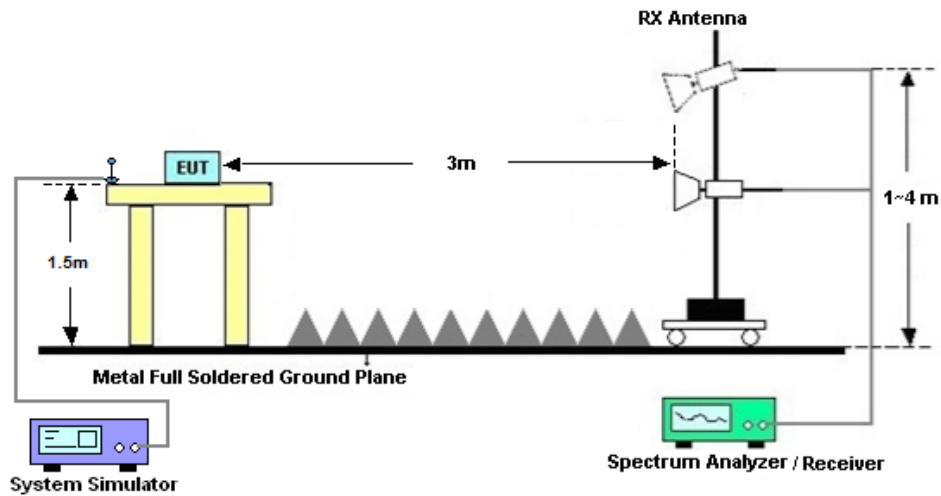

4.3 Test Result of Radiated Test

The low frequency, which started from 9 kHz to 30MHz, was pre-scanned and the result which was 20dB lower than the limit line was not reported.

Please refer to Appendix B.



4.4 Radiated Spurious Emission

4.4.1 Description of Radiated Spurious Emission Measurement

The radiated spurious emission was measured by substitution method according to ANSI C63.26-2015. The power of any emission outside of the authorized operating frequency ranges must be attenuated below the transmitter power (P) by a factor of at least -40dBm / MHz. The spectrum is scanned from 30 MHz up to a frequency including its 10th harmonic.

4.4.2 Test Procedures

1. The EUT was placed on a turntable with 0.8 meter height for frequency below 1GHz and 1.5 meter height for frequency above 1GHz respectively above ground.
2. The EUT was set 3 meters from the receiving antenna mounted on the antenna tower.
3. The table was rotated 360 degrees to determine the position of the highest spurious emission.
4. The height of the receiving antenna is varied between 1m to 4m to search the maximum spurious emission for both horizontal and vertical polarizations.
5. During the measurement, the system simulator parameters were set to force the EUT transmitting at maximum output power.
6. Make the measurement with the spectrum analyzer's RBW = 1MHz, VBW = 3MHz, taking the record of maximum spurious emission.
7. A horn antenna was substituted in place of the EUT and was driven by a signal generator. Tune the output power of signal generator to the same emission level with EUT maximum spurious emission.
$$\text{EIRP (dBm)} = \text{S.G. Power} - \text{Tx Cable Loss} + \text{Tx Antenna Gain}$$
$$\text{ERP (dBm)} = \text{EIRP} - 2.15$$
8. The RF fundamental frequency should be excluded against the limit line in the operating frequency band.
The limit line is -40dBm/MHz



5 List of Measuring Equipment

Instrument	Manufacturer	Model No.	Serial No.	Characteristics	Calibration Date	Test Date	Due Date	Remark
Spectrum Analyzer	R&S	FSV40	101078	10Hz~40GHz	Apr. 07, 2022	Nov. 08, 2022~ Nov. 30, 2022	Apr. 08, 2023	Conducted (TH01-SZ)
DC Power Supply	TTI	PL330P	290070	Max 32V , 3A	Oct. 17, 2022	Nov. 08, 2022~ Nov. 30, 2022	Oct. 16, 2023	Conducted (TH01-SZ)
Power Divider	TOJOIN	PS-2SM-04 265	60.06.020.007 7	0.4GHz~26.5GHz	Dec. 25, 2021	Nov. 08, 2022~ Nov. 30, 2022	Dec. 24, 2022	Conducted (TH01-SZ)
Thermal Chamber	Ten Billion Hongzhangroup	LP-150U	H2014081803	-40~+150°C	Jul. 07, 2022	Nov. 08, 2022~ Nov. 30, 2022	Jul. 06, 2023	Conducted (TH01-SZ)
EMI Test Receiver&SA	KEYSIGHT	N9038A	MY54450083	20Hz~8.4GHz	Apr. 06, 2022	Nov. 28, 2022	Apr. 05, 2023	Radiation (03CH03-SZ)
Loop Antenna	R&S	HFH2-Z2	100354	9kHz~30MHz	Jun. 28, 2022	Nov. 28, 2022	Jun. 27, 2024	Radiation (03CH03-SZ)
EXA Spectrum Analyzer	KEYSIGHT	N9010A	MY55150246	10Hz~44GHz;	Apr. 06, 2022	Nov. 28, 2022	Apr. 05, 2023	Radiation (03CH03-SZ)
Bilog Antenna	TeseQ	CBL6112D	35408	30MHz-2GHz	Aug. 09, 2021	Nov. 28, 2022	Aug. 09, 2023	Radiation (03CH03-SZ)
Double Ridge Horn Antenna	SCHWARZBECK	BBHA9120D	9120D-1355	1GHz~18GHz	Apr. 08, 2022	Nov. 28, 2022	Apr. 07, 2023	Radiation (03CH03-SZ)
Amplifier	Burgeon	BPA-530	102211	0.01Hz ~3000MHz	Oct. 19, 2022	Nov. 28, 2022	Oct. 18, 2023	Radiation (03CH03-SZ)
HF Amplifier	MITEQ	TTA1840-35 -HG	1871923	18GHz~40GHz	Jul. 06, 2022	Nov. 28, 2022	Jul.05, 2023	Radiation (03CH03-SZ)
SHF-EHF Horn	com-power	AH-840	101071	18Ghz-40GHz	Apr. 10, 2022	Nov. 28, 2022	Apr. 09, 2023	Radiation (03CH03-SZ)
Amplifier	Agilent Technologies	83017A	MY39501302	500MHz~26.5GHz	Dec. 27, 2021	Nov. 28, 2022	Dec. 26, 2022	Radiation (03CH03-SZ)
AC Power Source	Chroma	61601	616010002729	N/A	Nov. 10, 2022	Nov. 28, 2022	Nov. 09, 2023	Radiation (03CH03-SZ)
Turn Table	EM	EM1000	N/A	0~360 degree	NCR	Nov. 28, 2022	NCR	Radiation (03CH03-SZ)
Antenna Mast	EM	EM1000	N/A	1 m~4 m	NCR	Nov. 28, 2022	NCR	Radiation (03CH03-SZ)

NCR: No Calibration Required



6 Uncertainty of Evaluation

The measurement uncertainties shown below were calculated in accordance with the requirements of ANSI 63.26-2015. All the measurement uncertainty value were shown with a coverage K=2 to indicate 95% level of confidence. The measurement data show herein meets or exceeds the CISPR measurement uncertainty values specified in CISPR 16-4-2 and can be compared directly to specified limit to determine compliance.

Uncertainty of Conducted Measurement

Test Item	Uncertainty
Conducted Power	±1.34 dB
Conducted Emissions	±1.34 dB
Occupied Channel Bandwidth	±1.2 %

Uncertainty of Radiated Emission Measurement (30 MHz ~ 1000 MHz)

Measuring Uncertainty for a Level of Confidence of 95% (U = 2Uc(y))	3.0 dB
---	--------

Uncertainty of Radiated Emission Measurement (1 GHz ~ 18 GHz)

Measuring Uncertainty for a Level of Confidence of 95% (U = 2Uc(y))	3.6 dB
---	--------

Uncertainty of Radiated Emission Measurement (18 GHz ~ 40 GHz)

Measuring Uncertainty for a Level of Confidence of 95% (U = 2Uc(y))	3.8 dB
---	--------

----- THE END -----



Appendix A. Test Results of Conducted Test

Test Engineer :	Sam Zheng	Temperature :	24~26°C
		Relative Humidity :	50~53%

Conducted Output Power(Average power)

LTE Band 48

BW [MHz]	Modulation	RB Size	RB Offset	Power Low Ch. / Freq.	Power Middle Ch. / Freq.	Power High Ch. / Freq.
Channel				55340	55990	56640
Frequency (MHz)				3560	3625	3690
20	QPSK	1	0	21.22	21.50	21.40
20	QPSK	1	49	21.52	21.51	21.48
20	QPSK	1	99	21.34	21.49	21.43
20	QPSK	50	0	19.61	19.64	19.62
20	QPSK	50	24	19.69	19.67	19.66
20	QPSK	50	50	19.66	19.62	19.61
20	QPSK	100	0	19.68	19.62	19.63
20	16QAM	1	0	20.39	20.68	20.62
20	16QAM	1	49	20.61	20.57	20.54
20	16QAM	1	99	20.74	20.46	20.67
20	16QAM	50	0	18.45	18.76	18.79
20	16QAM	50	24	18.62	18.75	18.80
20	16QAM	50	50	18.63	18.68	18.73
20	16QAM	100	0	18.62	18.66	18.78
20	64QAM	1	0	19.50	19.70	19.61
20	64QAM	1	49	19.62	19.66	19.69
20	64QAM	1	99	19.64	19.53	19.74
20	64QAM	50	0	17.52	17.68	17.80
20	64QAM	50	24	17.56	17.64	17.82
20	64QAM	50	50	17.60	17.68	17.72
20	64QAM	100	0	17.58	17.65	17.78
20	256QAM	1	0	20.19	20.19	20.43
20	256QAM	1	49	20.23	20.28	20.40
20	256QAM	1	99	20.30	20.36	20.25
20	256QAM	50	0	20.17	20.35	20.34
20	256QAM	50	24	20.31	20.46	20.47
20	256QAM	50	50	20.30	20.49	20.36
20	256QAM	100	0	20.08	20.43	20.45
Channel				55315	55990	56665
Frequency (MHz)				3557.5	3625	3692.5



15	QPSK	1	0	21.05	21.37	21.34
15	QPSK	1	37	21.50	21.40	21.33
15	QPSK	1	74	21.17	21.40	21.24
15	QPSK	36	0	19.66	19.38	19.64
15	QPSK	36	20	19.60	19.69	19.46
15	QPSK	36	39	19.63	19.41	19.64
15	QPSK	75	0	19.51	19.39	19.58
15	16QAM	1	0	20.45	20.43	20.37
15	16QAM	1	37	20.39	20.39	20.58
15	16QAM	1	74	20.67	20.41	20.40
15	16QAM	36	0	18.43	18.50	18.85
15	16QAM	36	20	18.42	18.51	18.54
15	16QAM	36	39	18.71	18.53	18.45
15	16QAM	75	0	18.65	18.49	18.70
15	64QAM	1	0	19.57	19.65	19.60
15	64QAM	1	37	19.52	19.60	19.74
15	64QAM	1	74	19.56	19.29	19.47
15	64QAM	36	0	17.45	17.64	17.68
15	64QAM	36	20	17.40	17.65	17.80
15	64QAM	36	39	17.66	17.43	17.65
15	64QAM	75	0	17.49	17.45	17.64
15	256QAM	1	0	19.93	20.12	20.36
15	256QAM	1	37	20.09	20.07	20.48
15	256QAM	1	74	20.17	20.32	20.10
15	256QAM	36	0	20.25	20.21	20.31
15	256QAM	36	20	20.32	20.44	20.23
15	256QAM	36	39	20.32	20.47	20.15
15	256QAM	75	0	20.01	20.25	20.38
Channel				55290	55990	56690
Frequency (MHz)				3555	3625	3695
10	QPSK	1	0	21.19	21.22	21.20
10	QPSK	1	25	21.37	21.47	21.43
10	QPSK	1	49	21.33	21.41	21.30
10	QPSK	25	0	19.35	19.38	19.51
10	QPSK	25	12	19.46	19.68	19.38
10	QPSK	25	25	19.66	19.67	19.37
10	QPSK	50	0	19.56	19.62	19.60
10	16QAM	1	0	20.37	20.49	20.58
10	16QAM	1	25	20.61	20.30	20.55
10	16QAM	1	49	20.64	20.24	20.56
10	16QAM	25	0	18.21	18.61	18.51
10	16QAM	25	12	18.53	18.59	18.76
10	16QAM	25	25	18.51	18.72	18.49
10	16QAM	50	0	18.37	18.43	18.58



10	64QAM	1	0	19.49	19.64	19.52
10	64QAM	1	25	19.36	19.40	19.73
10	64QAM	1	49	19.37	19.26	19.63
10	64QAM	25	0	17.31	17.47	17.69
10	64QAM	25	12	17.64	17.36	17.87
10	64QAM	25	25	17.35	17.75	17.60
10	64QAM	50	0	17.46	17.39	17.54
10	256QAM	1	0	20.03	19.97	20.30
10	256QAM	1	25	20.23	20.11	20.27
10	256QAM	1	49	20.08	20.23	20.05
10	256QAM	25	0	20.09	20.26	20.14
10	256QAM	25	12	20.25	20.39	20.33
10	256QAM	25	25	20.28	20.53	20.08
10	256QAM	50	0	20.14	20.16	20.43
Channel				55265	55990	56715
Frequency (MHz)				3552.5	3625	3697.5
5	QPSK	1	0	21.02	21.34	21.42
5	QPSK	1	12	21.37	21.48	21.44
5	QPSK	1	24	21.35	21.52	21.36
5	QPSK	12	0	19.69	19.61	19.58
5	QPSK	12	7	19.61	19.68	19.40
5	QPSK	12	13	19.65	19.61	19.38
5	QPSK	25	0	19.57	19.43	19.59
5	16QAM	1	0	20.34	20.70	20.43
5	16QAM	1	12	20.66	20.47	20.38
5	16QAM	1	24	20.71	20.53	20.69
5	16QAM	12	0	18.48	18.78	18.64
5	16QAM	12	7	18.65	18.60	18.57
5	16QAM	12	13	18.37	18.55	18.56
5	16QAM	25	0	18.48	18.65	18.83
5	64QAM	1	0	19.44	19.65	19.58
5	64QAM	1	12	19.44	19.61	19.41
5	64QAM	1	24	19.55	19.53	19.53
5	64QAM	12	0	17.42	17.58	17.63
5	64QAM	12	7	17.31	17.62	17.73
5	64QAM	12	13	17.34	17.61	17.73
5	64QAM	25	0	17.30	17.59	17.82
5	256QAM	1	0	19.92	20.08	20.26
5	256QAM	1	12	19.95	20.06	20.27
5	256QAM	1	24	20.15	20.27	20.01
5	256QAM	12	0	19.91	20.08	20.25
5	256QAM	12	7	20.06	20.22	20.28
5	256QAM	12	13	20.21	20.30	20.27
5	256QAM	25	0	20.02	20.47	20.46



LTE Band 48C

Combination 20MHz+15MHz (100RB+75RB)							
PCC Channel	SCC Channel	Modulation	PCC		SCC		Measured Power (dBm)
			RB Size	RB offset	RB Size	RB offset	
55340	55511	QPSK	100	0	75	0	15.53
			1	0	1	74	8.71
			1	99	1	0	20.15
		16QAM	100	0	75	0	15.26
			1	0	1	74	8.73
			1	99	1	0	20.10
		64QAM	100	0	75	0	15.42
			1	0	1	74	8.18
			1	99	1	0	20.05
		256QAM	100	0	75	0	15.44
			1	0	1	74	8.68
			1	99	1	0	20.31
55916	56087	QPSK	100	0	75	0	20.68
			1	0	1	74	13.78
			1	99	1	0	21.41
		16QAM	100	0	75	0	20.80
			1	0	1	74	13.76
			1	99	1	0	21.49
		64QAM	100	0	75	0	20.77
			1	0	1	74	13.75
			1	99	1	0	21.36
		256QAM	100	0	75	0	20.39
			1	0	1	74	13.79
			1	99	1	0	20.78
56491	56662	QPSK	100	0	75	0	15.21
			1	0	1	74	8.50
			1	99	1	0	19.92
		16QAM	100	0	75	0	15.03
			1	0	1	74	8.62
			1	99	1	0	19.98
		64QAM	100	0	75	0	15.13
			1	0	1	74	7.99
			1	99	1	0	19.79
		256QAM	100	0	75	0	15.11
			1	0	1	74	8.39
			1	99	1	0	20.09
Combination 15MHz+20MHz (75RB+100RB)							
PCC Channel	SCC Channel	Modulation	PCC		SCC		Measured Power (dBm)
			RB Size	RB offset	RB Size	RB offset	



55318	55489	QPSK	75	0	100	0	15.10
			1	0	1	99	8.47
			1	74	1	0	19.90
		16QAM	75	0	100	0	15.05
			1	0	1	99	8.64
			1	74	1	0	19.93
		64QAM	75	0	100	0	15.14
			1	0	1	99	7.88
			1	74	1	0	19.91
256QAM	75	0	100	0	15.20		
	1	0	1	99	8.44		
	1	74	1	0	20.01		
55893	56064	QPSK	75	0	100	0	20.79
			1	0	1	99	13.68
			1	74	1	0	21.44
		16QAM	75	0	100	0	20.88
			1	0	1	99	13.52
			1	74	1	0	21.34
		64QAM	75	0	100	0	20.77
			1	0	1	99	13.53
			1	74	1	0	21.43
256QAM	75	0	100	0	20.35		
	1	0	1	99	13.76		
	1	74	1	0	20.77		
56469	56640	QPSK	75	0	100	0	15.18
			1	0	1	99	8.46
			1	74	1	0	19.87
		16QAM	75	0	100	0	14.96
			1	0	1	99	8.63
			1	74	1	0	20.03
		64QAM	75	0	100	0	15.16
			1	0	1	99	7.88
			1	74	1	0	19.94
256QAM	75	0	100	0	15.21		
	1	0	1	99	8.50		
	1	74	1	0	20.14		
Combination 20MHz+10MHz (100RB+50RB)							
PCC Channel	SCC Channel	Modulation	PCC		SCC		Measured Power (dBm)
			RB Size	RB offset	RB Size	RB offset	
55340	55484	QPSK	100	0	50	0	15.14
			1	0	1	49	8.42
			1	99	1	0	20.02
		16QAM	100	0	50	0	15.10
			1	0	1	49	8.61



		64QAM	1	99	1	0	19.92
			100	0	50	0	15.23
			1	0	1	49	7.89
		256QAM	1	99	1	0	19.78
			100	0	50	0	15.16
			1	0	1	49	8.49
55941	56085	QPSK	1	99	1	0	20.08
			100	0	50	0	20.74
			1	0	1	49	13.66
		16QAM	1	99	1	0	21.49
			100	0	50	0	20.79
			1	0	1	49	13.77
		64QAM	1	99	1	0	21.37
			100	0	50	0	20.65
			1	0	1	49	13.75
		256QAM	1	99	1	0	21.47
			100	0	50	0	20.12
			1	0	1	49	13.67
56541	56685	QPSK	1	99	1	0	20.71
			100	0	50	0	15.28
			1	0	1	49	8.56
		16QAM	1	99	1	0	19.89
			100	0	50	0	14.95
			1	0	1	49	8.53
		64QAM	1	99	1	0	19.84
			100	0	50	0	15.20
			1	0	1	49	7.89
		256QAM	1	99	1	0	19.84
			100	0	50	0	15.27
			1	0	1	49	8.47
Combination 10MHz+20MHz (50RB+100RB)							
PCC Channel	SCC Channel	Modulation	PCC		SCC		Measured Power (dBm)
			RB Size	RB offset	RB Size	RB offset	
55295	55439	QPSK	50	0	100	0	15.14
			1	0	1	99	8.61
			1	49	1	0	19.94
		16QAM	50	0	100	0	15.12
			1	0	1	99	8.60
			1	49	1	0	19.87
		64QAM	50	0	100	0	15.09
			1	0	1	99	8.04
			1	49	1	0	19.89
256QAM	50	0	100	0	15.24		



			1	0	1	99	8.43
			1	49	1	0	20.00
55896	56040	QPSK	50	0	100	0	20.84
			1	0	1	99	13.94
			1	49	1	0	21.30
		16QAM	50	0	100	0	20.84
			1	0	1	99	13.76
			1	49	1	0	21.31
		64QAM	50	0	100	0	20.87
			1	0	1	99	13.59
			1	49	1	0	21.46
		256QAM	50	0	100	0	20.11
			1	0	1	99	13.71
			1	49	1	0	20.51
56496	56640	QPSK	50	0	100	0	15.13
			1	0	1	99	8.55
			1	49	1	0	20.05
		16QAM	50	0	100	0	15.09
			1	0	1	99	8.59
			1	49	1	0	19.94
		64QAM	50	0	100	0	15.10
			1	0	1	99	7.94
			1	49	1	0	19.87
		256QAM	50	0	100	0	15.15
			1	0	1	99	8.54
			1	49	1	0	20.06
Combination 20MHz+5MHz (100RB+25RB)							
PCC Channel	SCC Channel	Modulation	PCC		SCC		Measured Power (dBm)
			RB Size	RB offset	RB Size	RB offset	
55340	55457	QPSK	100	0	25	0	15.07
			1	0	1	24	8.65
			1	99	1	0	19.93
		16QAM	100	0	25	0	14.90
			1	0	1	24	8.43
			1	99	1	0	19.80
		64QAM	100	0	25	0	15.04
			1	0	1	24	7.82
			1	99	1	0	19.72
		256QAM	100	0	25	0	15.21
			1	0	1	24	8.53
			1	99	1	0	19.91
55965	56082	QPSK	100	0	25	0	20.63
			1	0	1	24	13.86
			1	99	1	0	21.36



		16QAM	100	0	25	0	20.94
			1	0	1	24	13.57
			1	99	1	0	21.39
		64QAM	100	0	25	0	20.73
			1	0	1	24	13.74
			1	99	1	0	21.43
		256QAM	100	0	25	0	20.23
			1	0	1	24	13.52
			1	99	1	0	20.52
56590	56707	QPSK	100	0	25	0	15.19
			1	0	1	24	8.45
			1	99	1	0	20.11
		16QAM	100	0	25	0	15.04
			1	0	1	24	8.69
			1	99	1	0	20.00
		64QAM	100	0	25	0	15.04
			1	0	1	24	7.84
			1	99	1	0	19.89
		256QAM	100	0	25	0	15.25
			1	0	1	24	8.57
			1	99	1	0	19.91
Combination 5MHz+20MHz (25RB+100RB)							
PCC Channel	SCC Channel	Modulation	PCC		SCC		Measured Power (dBm)
			RB Size	RB offset	RB Size	RB offset	
55273	55390	QPSK	25	0	100	0	15.10
			1	0	1	99	8.57
			1	24	1	0	20.05
		16QAM	25	0	100	0	15.11
			1	0	1	99	8.46
			1	24	1	0	19.81
		64QAM	25	0	100	0	15.13
			1	0	1	99	7.92
			1	24	1	0	19.91
		256QAM	25	0	100	0	15.24
			1	0	1	99	8.30
			1	24	1	0	19.98
55898	56015	QPSK	25	0	100	0	20.69
			1	0	1	99	13.82
			1	24	1	0	21.48
		16QAM	25	0	100	0	20.84
			1	0	1	99	13.59
			1	24	1	0	21.47
		64QAM	25	0	100	0	20.80
			1	0	1	99	13.79
			1	0	1	99	13.79



		256QAM	1	24	1	0	21.42
			25	0	100	0	20.25
			1	0	1	99	13.73
			1	24	1	0	20.69
56523	56640	QPSK	25	0	100	0	15.14
			1	0	1	99	8.61
			1	24	1	0	19.83
		16QAM	25	0	100	0	15.02
			1	0	1	99	8.49
			1	24	1	0	19.86
		64QAM	25	0	100	0	15.12
			1	0	1	99	7.91
			1	24	1	0	19.84
		256QAM	25	0	100	0	15.17
			1	0	1	99	8.34
			1	24	1	0	20.06
Combination 20MHz+20MHz (100RB+100RB)							
PCC Channel	SCC Channel	Modulation	PCC		SCC		Measured Power (dBm)
			RB Size	RB offset	RB Size	RB offset	
55340	55538	QPSK	100	0	100	0	15.51
			1	0	1	99	8.62
			1	99	1	0	20.11
		16QAM	100	0	100	0	15.28
			1	0	1	99	8.76
			1	99	1	0	20.17
		64QAM	100	0	100	0	15.40
			1	0	1	99	8.21
			1	99	1	0	19.99
		256QAM	100	0	100	0	15.36
			1	0	1	99	8.66
			1	99	1	0	20.23
55891	56089	QPSK	100	0	100	0	20.82
			1	0	1	99	13.93
			1	99	1	0	21.50
		16QAM	100	0	100	0	20.94
			1	0	1	99	13.93
			1	99	1	0	21.39
		64QAM	100	0	100	0	20.85
			1	0	1	99	13.84
			1	99	1	0	21.47
		256QAM	100	0	100	0	20.49
			1	0	1	99	13.84
			1	99	1	0	20.85
56442	56640	QPSK	100	0	100	0	15.37



			1	0	1	99	8.53
			1	99	1	0	20.01
		16QAM	100	0	100	0	15.14
			1	0	1	99	8.78
			1	99	1	0	20.18
			100	0	100	0	15.31
		64QAM	1	0	1	99	8.08
			1	99	1	0	19.91
			100	0	100	0	15.18
			1	0	1	99	8.51
		256QAM	1	99	1	0	20.28



EIRP

The worst case EIRP shown in this section is found with LTE operating only using 1RB. As such, the EIRP/10MHz and full channel EIRP values will be identical since 1RB is fully contained within all available channel bandwidths for LTE Band 48 (i.e. 5, 10, 15, 20MHz)

LTE Band 48 (GT - LC = -1.80 dB) QPSK									
Bandwidth	5M			10M			15M		
Channel	(Low)	(Mid)	(High)	(Low)	(Mid)	(High)	(Low)	(Mid)	(High)
Conducted Power (dBm/10MHz)	21.35	21.52	21.36	21.37	21.47	21.43	21.50	21.40	21.33
Conducted Power (Watts/10MHz)	0.1365	0.1419	0.1368	0.1371	0.1403	0.1390	0.1413	0.1380	0.1358
EIRP (dBm/10MHz)	19.55	19.72	19.56	19.57	19.67	19.63	19.70	19.60	19.53
EIRP (Watts/10MHz)	0.0902	0.0938	0.0904	0.0906	0.0927	0.0918	0.0933	0.0912	0.0897

LTE Band 48 (GT - LC = -1.80 dB) QPSK			
Bandwidth	20M		
Channel	(Low)	(Mid)	(High)
Conducted Power (dBm/10MHz)	21.52	21.51	21.48
Conducted Power (Watts/10MHz)	0.1419	0.1416	0.1406
EIRP (dBm/10MHz)	19.72	19.71	19.68
EIRP (Watts/10MHz)	0.0938	0.0935	0.0929



LTE Band 48 (GT - LC = -1.80 dB) 16QAM									
Bandwidth	5M			10M			15M		
Channel	(Low)	(Mid)	(High)	(Low)	(Mid)	(High)	(Low)	(Mid)	(High)
Conducted Power (dBm/10MHz)	20.71	20.53	20.69	20.64	20.24	20.56	20.67	20.41	20.40
Conducted Power (Watts/10MHz)	0.1178	0.1130	0.1172	0.1159	0.1057	0.1138	0.1167	0.1099	0.1096
EIRP (dBm/10MHz)	18.91	18.73	18.89	18.84	18.44	18.76	18.87	18.61	18.60
EIRP (Watts/10MHz)	0.0778	0.0746	0.0774	0.0766	0.0698	0.0752	0.0771	0.0726	0.0724

LTE Band 48 (GT - LC = -1.80 dB) 16QAM			
Bandwidth	20M		
Channel	(Low)	(Mid)	(High)
Conducted Power (dBm/10MHz)	20.74	20.46	20.67
Conducted Power (Watts/10MHz)	0.1186	0.1112	0.1167
EIRP (dBm/10MHz)	18.94	18.66	18.87
EIRP (Watts/10MHz)	0.0783	0.0735	0.0771



LTE Band 48 (GT - LC = -1.80 dB) 64QAM									
Bandwidth	5M			10M			15M		
Channel	(Low)	(Mid)	(High)	(Low)	(Mid)	(High)	(Low)	(Mid)	(High)
Conducted Power (dBm/10MHz)	19.44	19.65	19.58	19.36	19.40	19.73	19.52	19.60	19.74
Conducted Power (Watts/10MHz)	0.0879	0.0923	0.0908	0.0863	0.0871	0.0940	0.0895	0.0912	0.0942
EIRP (dBm/10MHz)	17.64	17.85	17.78	17.56	17.60	17.93	17.72	17.80	17.94
EIRP (Watts/10MHz)	0.0581	0.0610	0.0600	0.0570	0.0575	0.0621	0.0592	0.0603	0.0622

LTE Band 48 (GT - LC = -1.80 dB) 64QAM			
Bandwidth	20M		
Channel	(Low)	(Mid)	(High)
Conducted Power (dBm/10MHz)	19.64	19.53	19.74
Conducted Power (Watts/10MHz)	0.0920	0.0897	0.0942
EIRP (dBm/10MHz)	17.84	17.73	17.94
EIRP (Watts/10MHz)	0.0608	0.0593	0.0622



LTE Band 48 (GT - LC = -1.80 dB) 256QAM									
Bandwidth	5M			10M			15M		
Channel	(Low)	(Mid)	(High)	(Low)	(Mid)	(High)	(Low)	(Mid)	(High)
Conducted Power (dBm/10MHz)	20.02	20.47	20.46	20.28	20.53	20.08	20.09	20.07	20.48
Conducted Power (Watts/10MHz)	0.1005	0.1114	0.1112	0.1067	0.1130	0.1019	0.1021	0.1016	0.1117
EIRP (dBm/10MHz)	18.22	18.67	18.66	18.48	18.73	18.28	18.29	18.27	18.68
EIRP (Watts/10MHz)	0.0664	0.0736	0.0735	0.0705	0.0746	0.0673	0.0675	0.0671	0.0738

LTE Band 48 (GT - LC = -1.80 dB) 256QAM			
Bandwidth	20M		
Channel	(Low)	(Mid)	(High)
Conducted Power (dBm/10MHz)	20.30	20.49	20.36
Conducted Power (Watts/10MHz)	0.1072	0.1119	0.1086
EIRP (dBm/10MHz)	18.50	18.69	18.56
EIRP (Watts/10MHz)	0.0708	0.0740	0.0718



LTE Band 48C (GT - LC = -1.80 dB) QPSK									
Bandwidth	20M+20M			20M+15M			15M+20M		
Channel	(Low)	(Mid)	(High)	(Low)	(Mid)	(High)	(Low)	(Mid)	(High)
Conducted Power (dBm/10MHz)	20.11	21.50	20.01	20.15	21.41	19.92	19.90	21.44	19.87
Conducted Power (Watts/10MHz)	0.1026	0.1413	0.1002	0.1035	0.1384	0.0982	0.0977	0.1393	0.0971
EIRP (dBm/10MHz)	18.31	19.70	18.21	18.35	19.61	18.12	18.10	19.64	18.07
EIRP (Watts/10MHz)	0.0678	0.0933	0.0662	0.0684	0.0914	0.0649	0.0646	0.0920	0.0641

LTE Band 48C (GT - LC = -1.80 dB) QPSK									
Bandwidth	20M+10M			10M+20M			20M+5M		
Channel	(Low)	(Mid)	(High)	(Low)	(Mid)	(High)	(Low)	(Mid)	(High)
Conducted Power (dBm/10MHz)	20.02	21.49	19.89	19.94	21.30	20.05	19.93	21.36	20.11
Conducted Power (Watts/10MHz)	0.1005	0.1409	0.0975	0.0986	0.1349	0.1012	0.0984	0.1368	0.1026
EIRP (dBm/10MHz)	18.22	19.69	18.09	18.14	19.50	18.25	18.13	19.56	18.31
EIRP (Watts/10MHz)	0.0664	0.0931	0.0644	0.0652	0.0891	0.0668	0.0650	0.0904	0.0678

LTE Band 48 (GT - LC = -1.80 dB) QPSK			
Bandwidth	5M+20M		
Channel	(Low)	(Mid)	(High)
Conducted Power (dBm/10MHz)	20.05	21.48	19.83
Conducted Power (Watts/10MHz)	0.1012	0.1406	0.0962
EIRP (dBm/10MHz)	18.25	19.68	18.03
EIRP (Watts/10MHz)	0.0668	0.0929	0.0635



LTE Band 48C (GT - LC = -1.80 dB) 16QAM									
Bandwidth	20M+20M			20M+15M			15M+20M		
Channel	(Low)	(Mid)	(High)	(Low)	(Mid)	(High)	(Low)	(Mid)	(High)
Conducted Power (dBm/10MHz)	20.17	21.39	20.18	20.10	21.49	19.98	19.93	21.34	20.03
Conducted Power (Watts/10MHz)	0.1040	0.1377	0.1042	0.1023	0.1409	0.0995	0.0984	0.1361	0.1007
EIRP (dBm/10MHz)	18.37	19.59	18.38	18.30	19.69	18.18	18.13	19.54	18.23
EIRP (Watts/10MHz)	0.0687	0.0910	0.0689	0.0676	0.0931	0.0658	0.0650	0.0899	0.0665

LTE Band 48C (GT - LC = -1.80 dB) 16QAM									
Bandwidth	20M+10M			10M+20M			20M+5M		
Channel	(Low)	(Mid)	(High)	(Low)	(Mid)	(High)	(Low)	(Mid)	(High)
Conducted Power (dBm/10MHz)	19.92	21.37	19.84	19.87	21.31	19.94	19.80	21.39	20.00
Conducted Power (Watts/10MHz)	0.0982	0.1371	0.0964	0.0971	0.1352	0.0986	0.0955	0.1377	0.1000
EIRP (dBm/10MHz)	18.12	19.57	18.04	18.07	19.51	18.14	18.00	19.59	18.20
EIRP (Watts/10MHz)	0.0649	0.0906	0.0637	0.0641	0.0893	0.0652	0.0631	0.0910	0.0661

LTE Band 48 (GT - LC = -1.80 dB) 16QAM			
Bandwidth	5M+20M		
Channel	(Low)	(Mid)	(High)
Conducted Power (dBm/10MHz)	19.81	21.47	19.86
Conducted Power (Watts/10MHz)	0.0957	0.1403	0.0968
EIRP (dBm/10MHz)	18.01	19.67	18.06
EIRP (Watts/10MHz)	0.0632	0.0927	0.0640



LTE Band 48C (GT - LC = -1.80 dB) 64QAM									
Bandwidth	20M+20M			20M+15M			15M+20M		
Channel	(Low)	(Mid)	(High)	(Low)	(Mid)	(High)	(Low)	(Mid)	(High)
Conducted Power (dBm/10MHz)	19.99	21.47	19.91	20.05	21.36	19.79	19.91	21.43	19.94
Conducted Power (Watts/10MHz)	0.0998	0.1403	0.0979	0.1012	0.1368	0.0953	0.0979	0.1390	0.0986
EIRP (dBm/10MHz)	18.19	19.67	18.11	18.25	19.56	17.99	18.11	19.63	18.14
EIRP (Watts/10MHz)	0.0659	0.0927	0.0647	0.0668	0.0904	0.0630	0.0647	0.0918	0.0652

LTE Band 48C (GT - LC = -1.80 dB) 64QAM									
Bandwidth	20M+10M			10M+20M			20M+5M		
Channel	(Low)	(Mid)	(High)	(Low)	(Mid)	(High)	(Low)	(Mid)	(High)
Conducted Power (dBm/10MHz)	19.78	21.47	19.84	19.89	21.46	19.87	19.72	21.43	19.89
Conducted Power (Watts/10MHz)	0.0951	0.1403	0.0964	0.0975	0.1400	0.0971	0.0938	0.1390	0.0975
EIRP (dBm/10MHz)	17.98	19.67	18.04	18.09	19.66	18.07	17.92	19.63	18.09
EIRP (Watts/10MHz)	0.0628	0.0927	0.0637	0.0644	0.0925	0.0641	0.0619	0.0918	0.0644

LTE Band 48 (GT - LC = -1.80 dB) 64QAM			
Bandwidth	5M+20M		
Channel	(Low)	(Mid)	(High)
Conducted Power (dBm/10MHz)	19.91	21.42	19.84
Conducted Power (Watts/10MHz)	0.0979	0.1387	0.0964
EIRP (dBm/10MHz)	18.11	19.62	18.04
EIRP (Watts/10MHz)	0.0647	0.0916	0.0637



LTE Band 48C (GT - LC = -1.80 dB) 256QAM									
Bandwidth	20M+20M			20M+15M			15M+20M		
Channel	(Low)	(Mid)	(High)	(Low)	(Mid)	(High)	(Low)	(Mid)	(High)
Conducted Power (dBm/10MHz)	20.23	20.85	20.28	20.31	20.78	20.09	20.01	20.77	20.14
Conducted Power (Watts/10MHz)	0.1054	0.1216	0.1067	0.1074	0.1197	0.1021	0.1002	0.1194	0.1033
EIRP (dBm/10MHz)	18.43	19.05	18.48	18.51	18.98	18.29	18.21	18.97	18.34
EIRP (Watts/10MHz)	0.0697	0.0804	0.0705	0.0710	0.0791	0.0675	0.0662	0.0789	0.0682

LTE Band 48C (GT - LC = -1.80 dB) 256QAM									
Bandwidth	20M+10M			10M+20M			20M+5M		
Channel	(Low)	(Mid)	(High)	(Low)	(Mid)	(High)	(Low)	(Mid)	(High)
Conducted Power (dBm/10MHz)	20.08	20.71	19.99	20.00	20.51	20.06	19.91	20.52	19.91
Conducted Power (Watts/10MHz)	0.1019	0.1178	0.0998	0.1000	0.1125	0.1014	0.0979	0.1127	0.0979
EIRP (dBm/10MHz)	18.28	18.91	18.19	18.20	18.71	18.26	18.11	18.72	18.11
EIRP (Watts/10MHz)	0.0673	0.0778	0.0659	0.0661	0.0743	0.0670	0.0647	0.0745	0.0647

LTE Band 48 (GT - LC = -1.80 dB) 256QAM			
Bandwidth	5M+20M		
Channel	(Low)	(Mid)	(High)
Conducted Power (dBm/10MHz)	19.98	20.69	20.06
Conducted Power (Watts/10MHz)	0.0995	0.1172	0.1014
EIRP (dBm/10MHz)	18.18	18.89	18.26
EIRP (Watts/10MHz)	0.0658	0.0774	0.0670



LTE Band 48

Peak-to-Average Ratio

Mode	LTE Band 48 / 20MHz				
Mod.	QPSK		16QAM		Limit: 13dB
RB Size	1RB	Full RB	1RB	Full RB	Result
Lowest CH	3.45	4.58	4.03	5.77	PASS
Middle CH	4.64	4.55	4.29	5.65	
Highest CH	3.74	4.49	4.49	5.65	
Mode	LTE Band 48 / 20MHz				
Mod.	64QAM				Limit: 13dB
RB Size	1RB	Full RB			Result
Lowest CH	4.46	5.77	-	-	PASS
Middle CH	4.29	5.71	-	-	
Highest CH	4.49	5.65	-	-	



LTE Band 48 / 20MHz / QPSK

Lowest Channel / 1RB

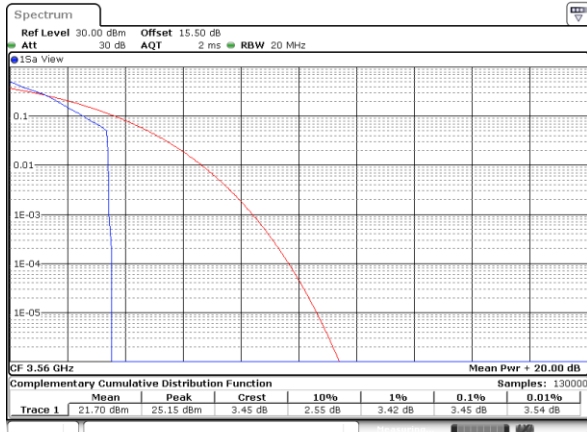

Date: 20,NOV,2022 02:50:38

Lowest Channel / Full RB

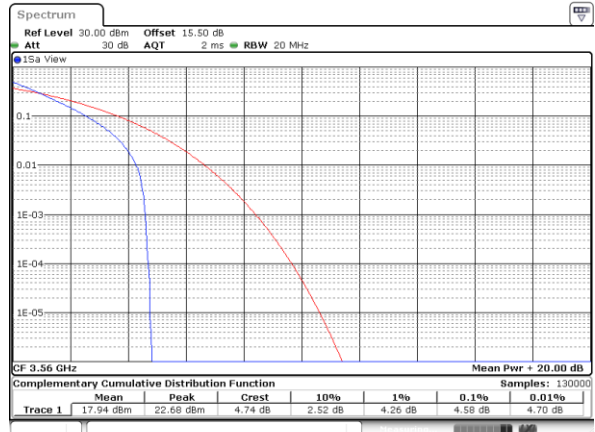

Date: 20,NOV,2022 02:54:44

Middle Channel / 1RB

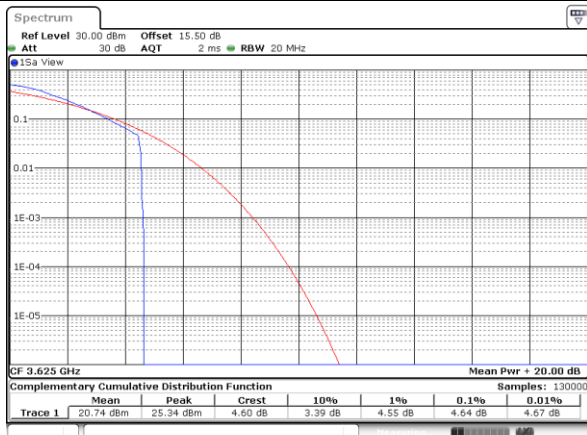

Date: 20,NOV,2022 03:03:06

Middle Channel / Full RB

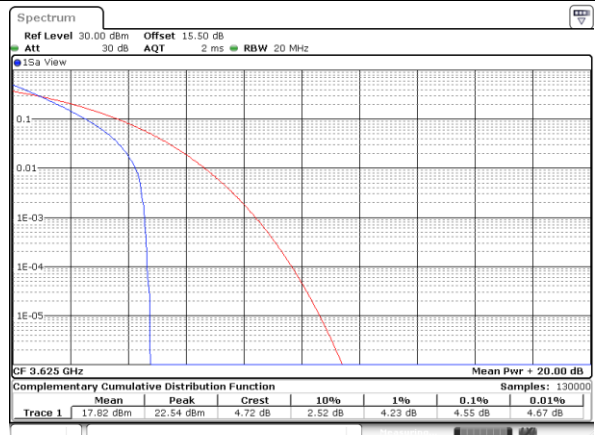

Date: 20,NOV,2022 02:55:27

Highest Channel / 1RB

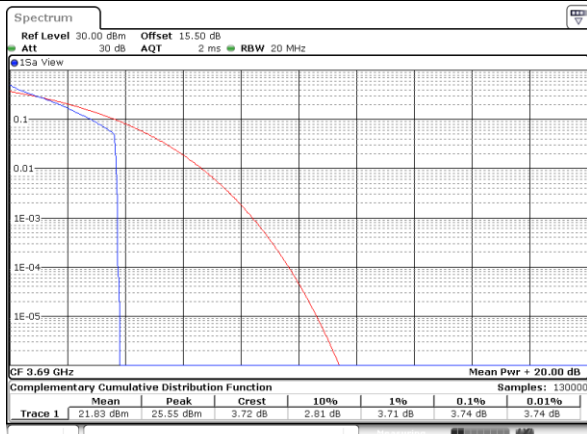

Date: 20,NOV,2022 03:05:20

Highest Channel / Full RB

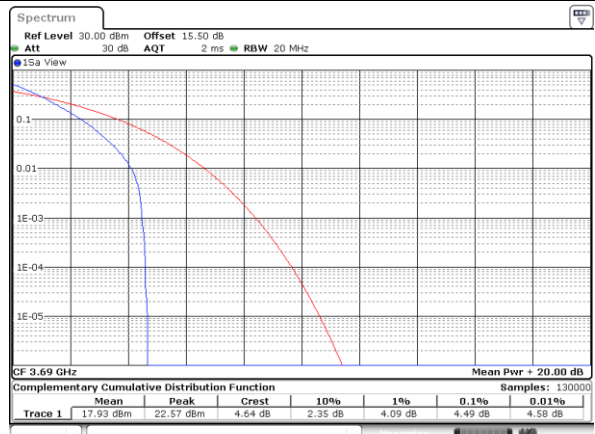

Date: 20,NOV,2022 03:11:03



LTE Band 48 / 20MHz / 16QAM

Lowest Channel / 1RB

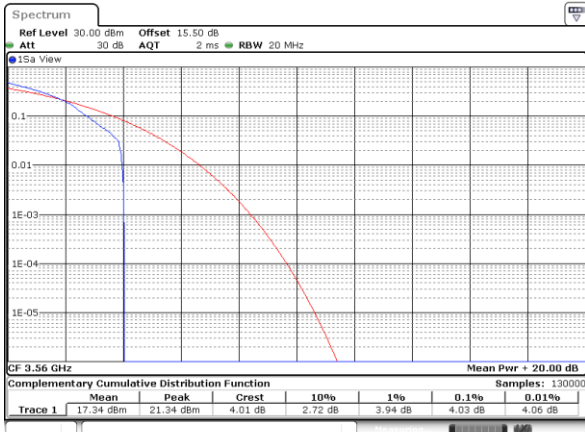

Date: 20,NOV,2022 02:51:43

Lowest Channel / Full RB

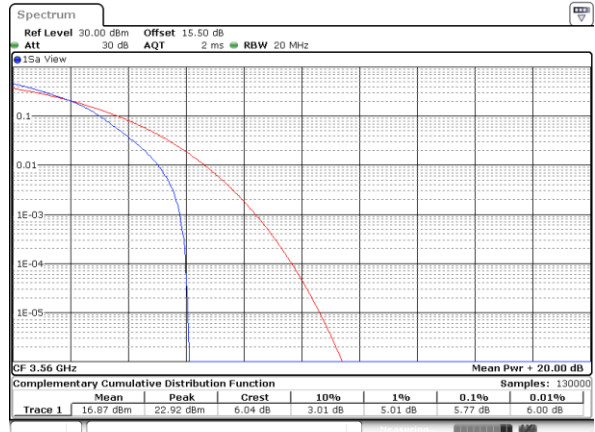

Date: 20,NOV,2022 02:54:00

Middle Channel / 1RB

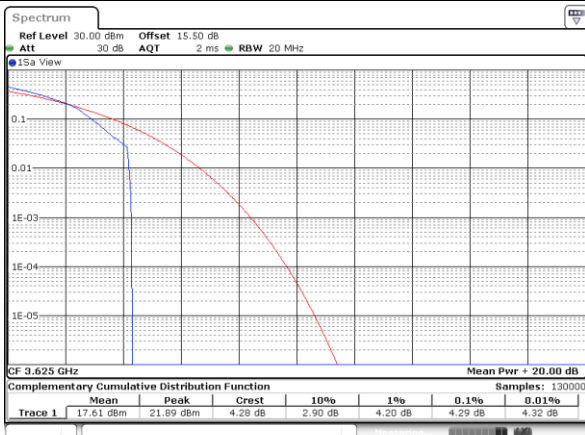

Date: 20,NOV,2022 03:01:36

Middle Channel / Full RB

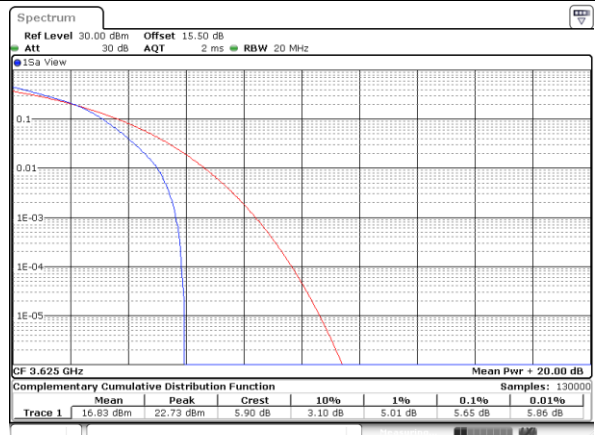

Date: 20,NOV,2022 02:57:55

Highest Channel / 1RB

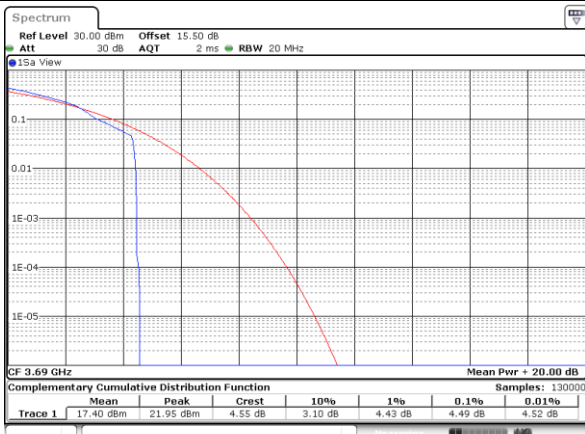

Date: 20,NOV,2022 03:06:30

Highest Channel / Full RB

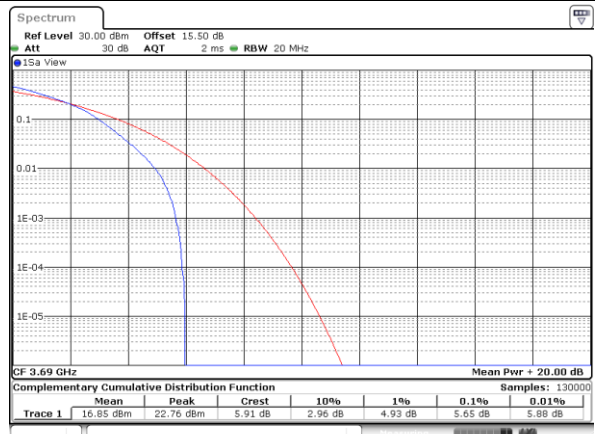

Date: 20,NOV,2022 03:10:05



LTE Band 48 / 20MHz / 64QAM

Lowest Channel / 1RB

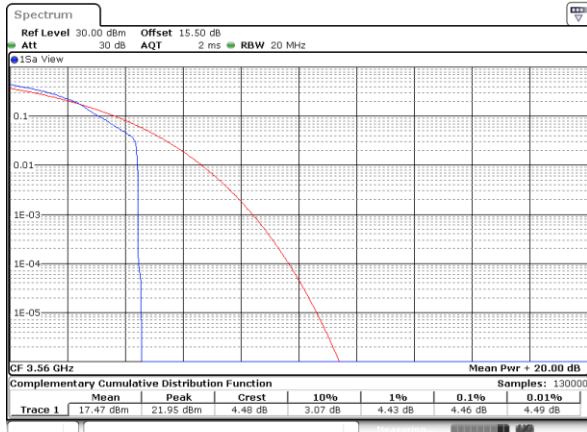

Date: 20,NOV,2022 02:52:36

Lowest Channel / Full RB

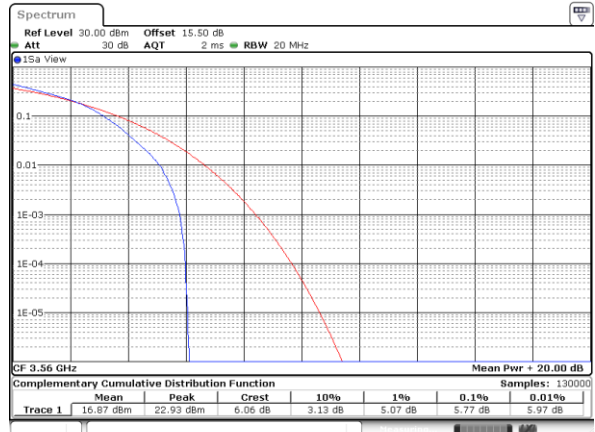

Date: 20,NOV,2022 02:53:20

Middle Channel / 1RB

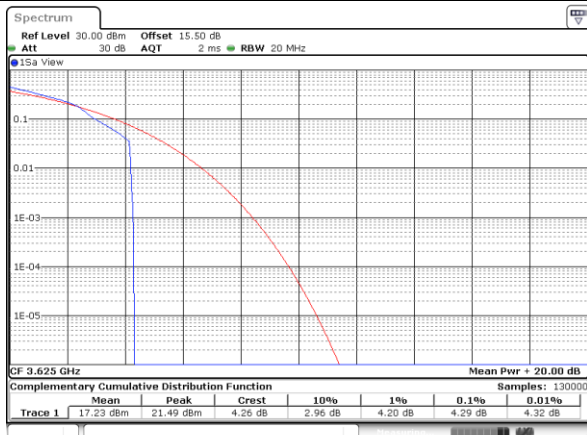

Date: 20,NOV,2022 03:02:30

Middle Channel / Full RB

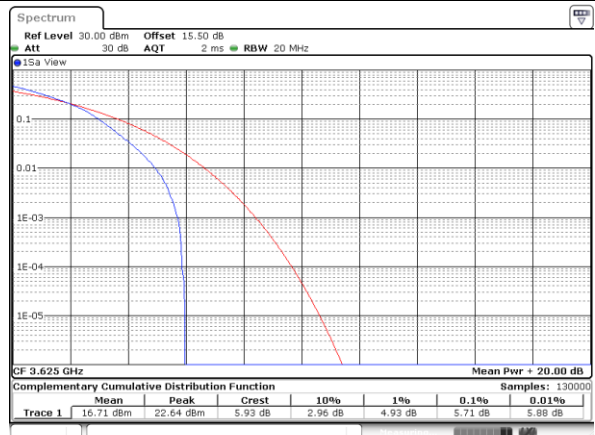

Date: 20,NOV,2022 02:58:43

Highest Channel / 1RB

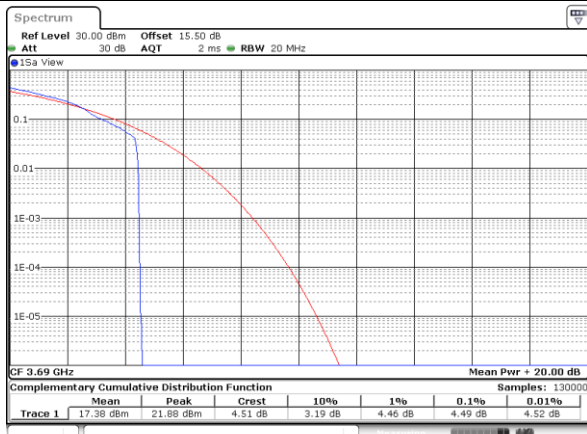

Date: 20,NOV,2022 03:07:42

Highest Channel / Full RB

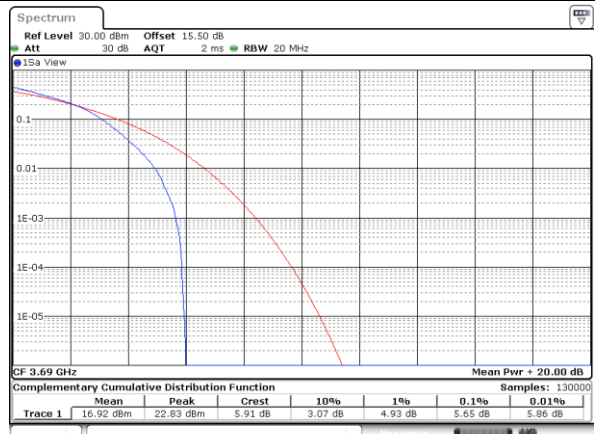

Date: 20,NOV,2022 03:09:17



ACLR

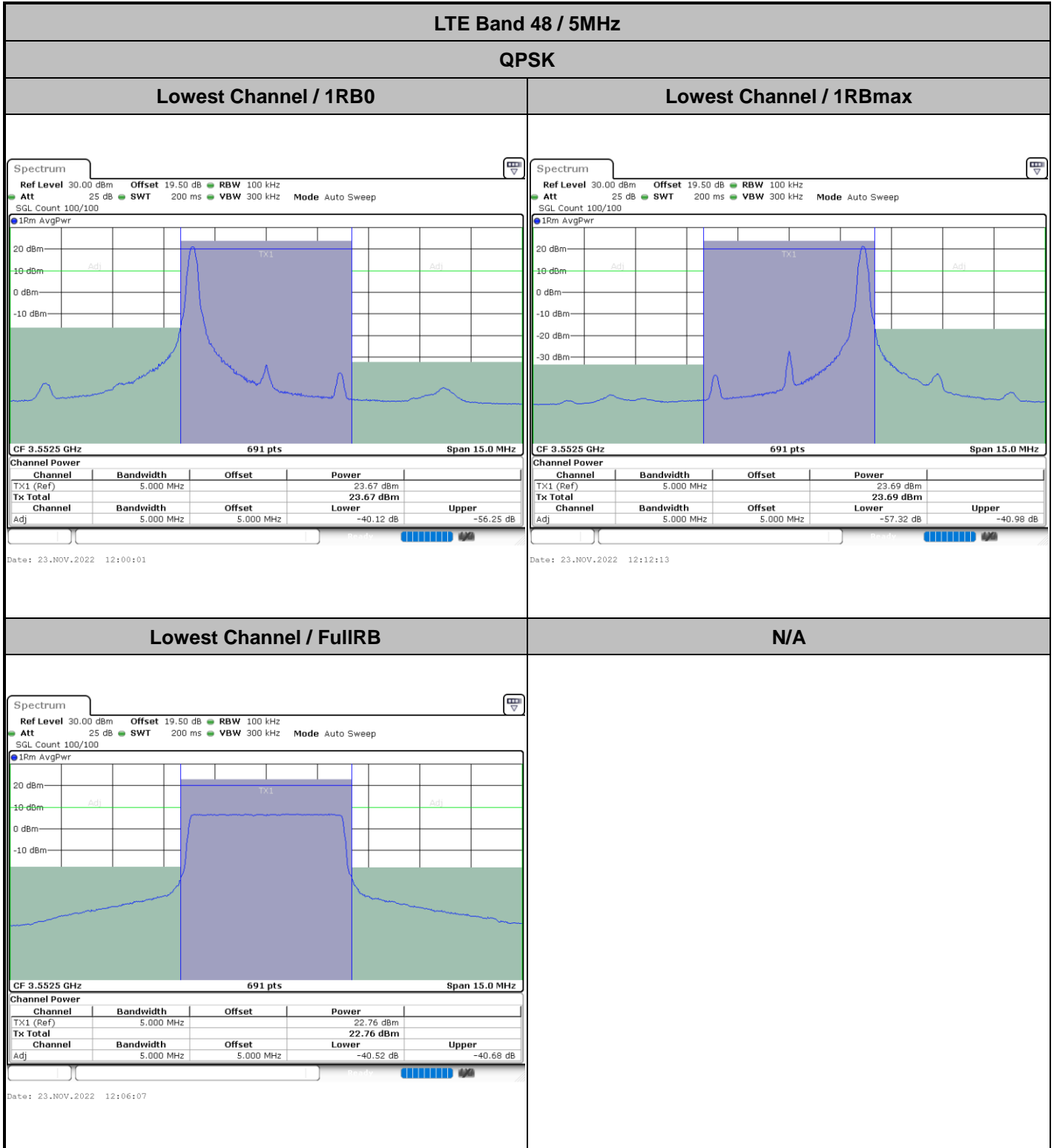



LTE Band 48 / 5MHz

QPSK

Middle Channel / 1RB0

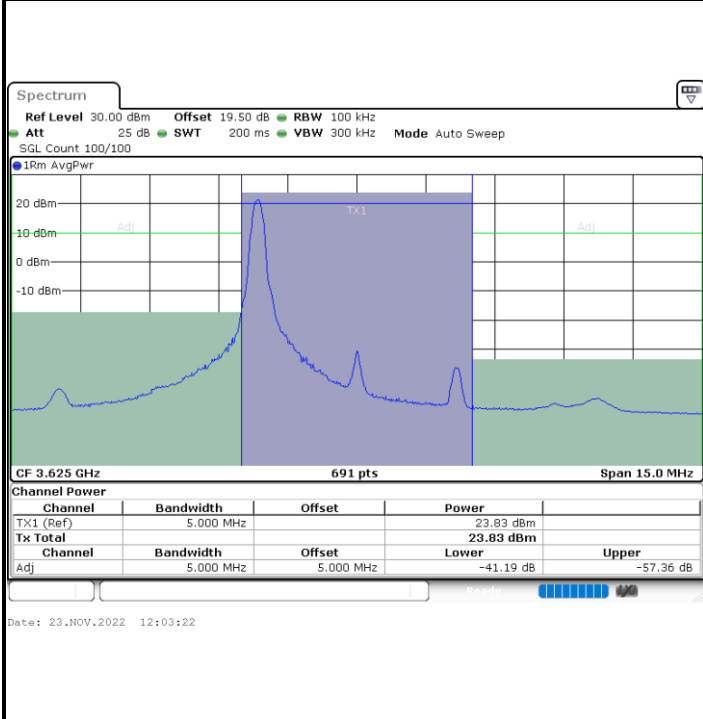

Middle Channel / 1RBmax

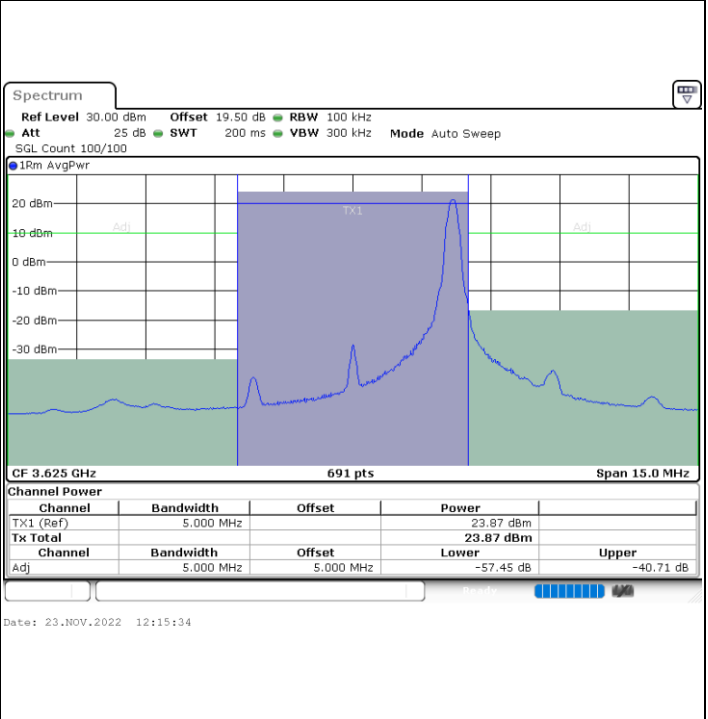

Middle Channel / FullRB

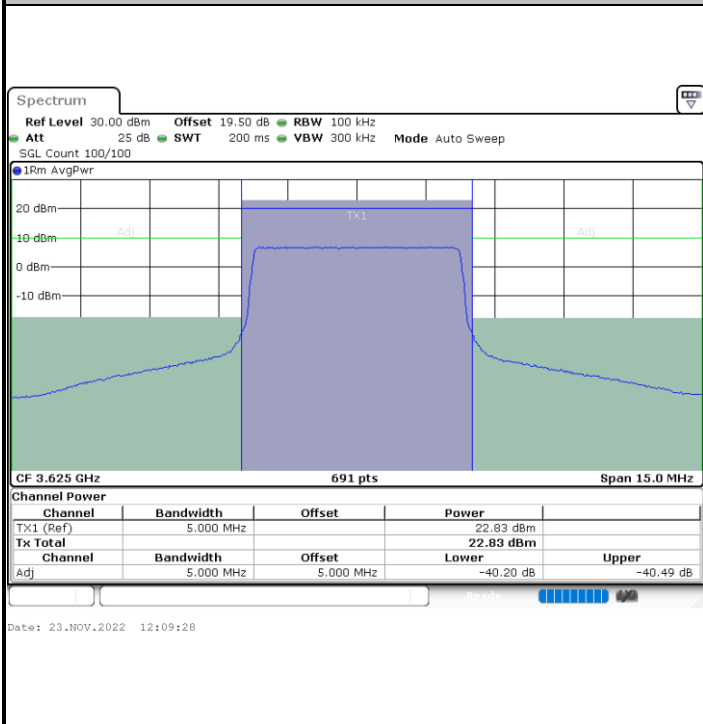

N/A



LTE Band 48 / 5MHz

QPSK

Highest Channel / 1RB0

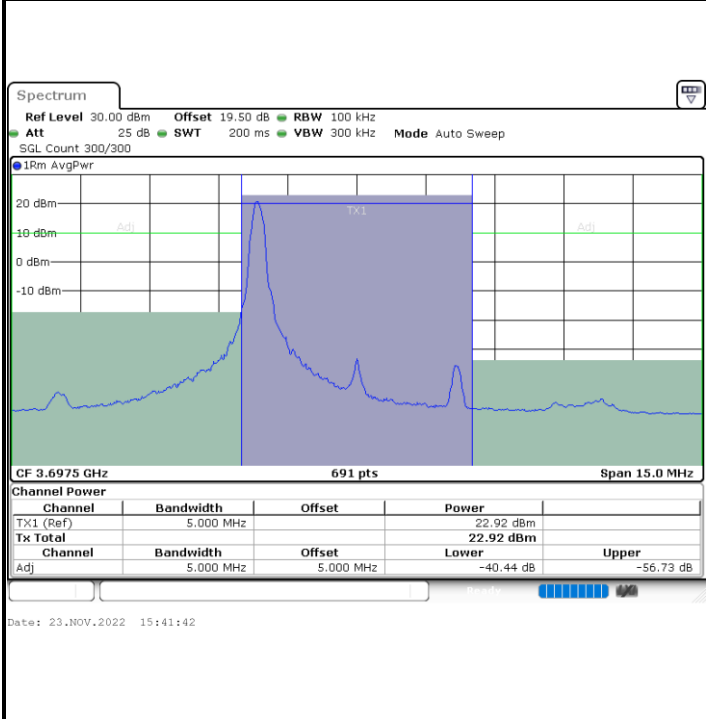

Highest Channel / FullIRB

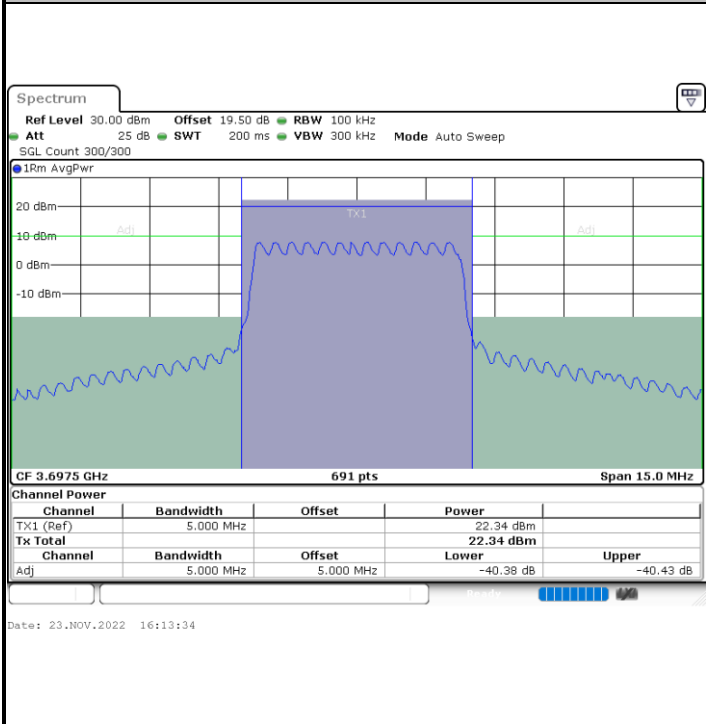

Highest Channel / 1RBmax

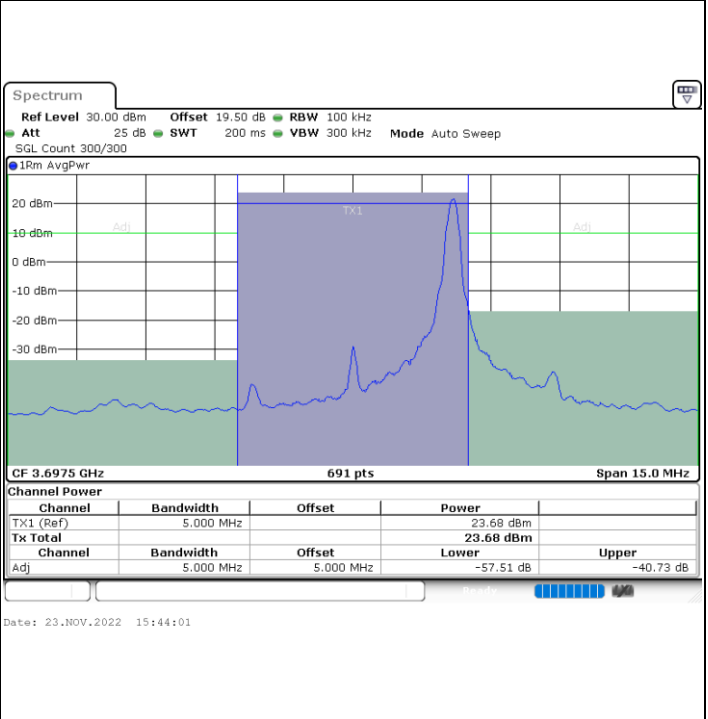

N/A



LTE Band 48 / 10MHz

QPSK

Lowest Channel / 1RB0

Lowest Channel / 1RBmax

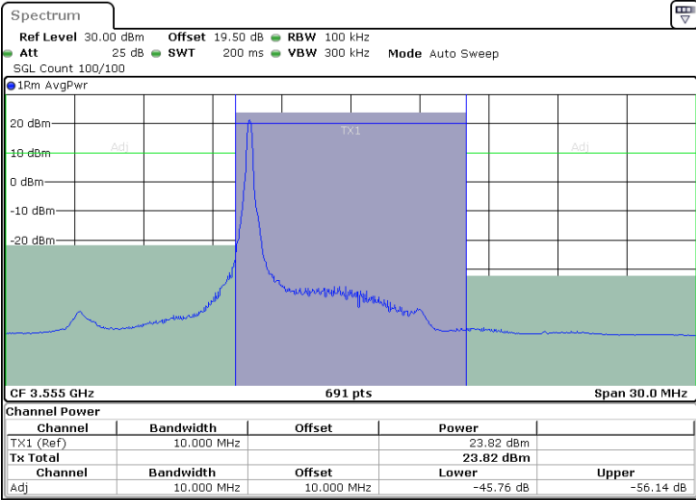

Date: 23.NOV.2022 13:05:34

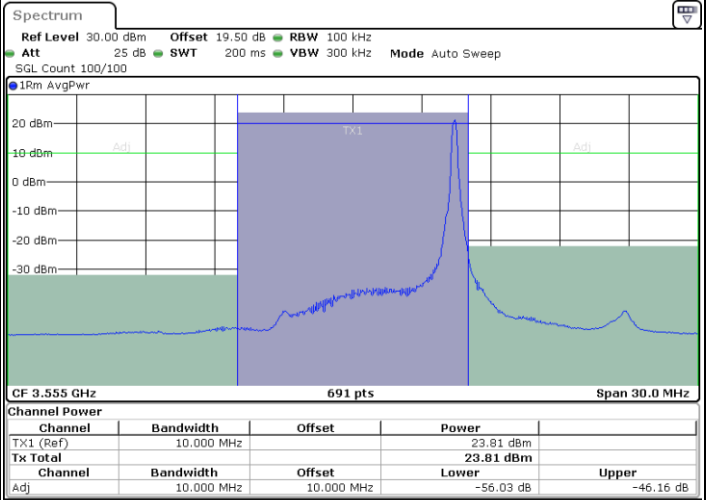

Date: 23.NOV.2022 13:17:47

Lowest Channel / FullIRB

N/A

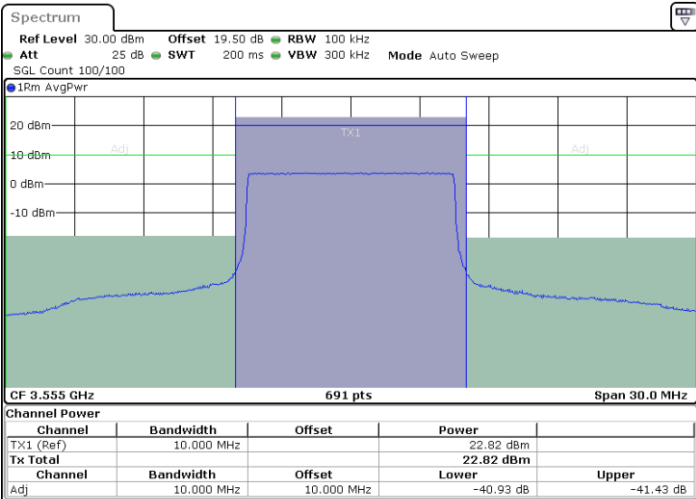

Date: 23.NOV.2022 13:11:41



LTE Band 48 / 10MHz

QPSK

MiddleChannel / 1RB0

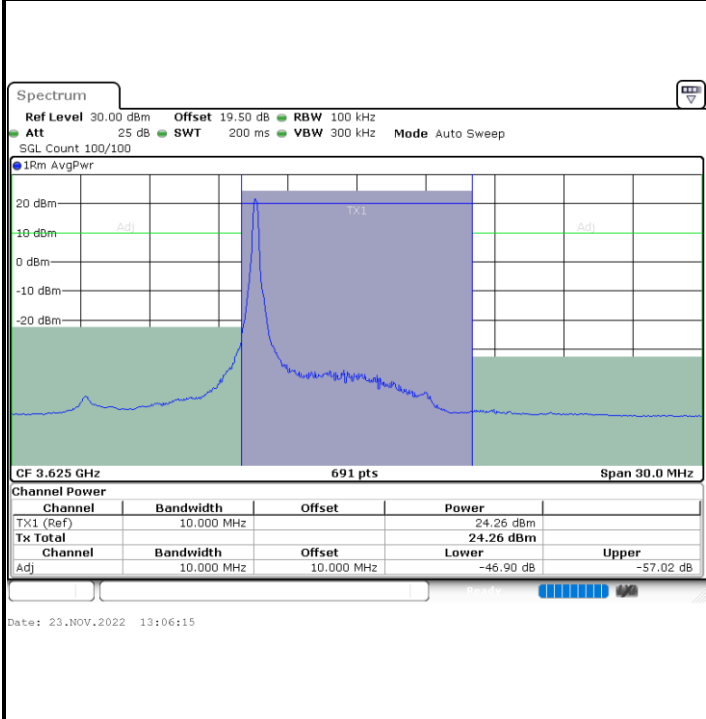

Middle Channel / 1RBmax

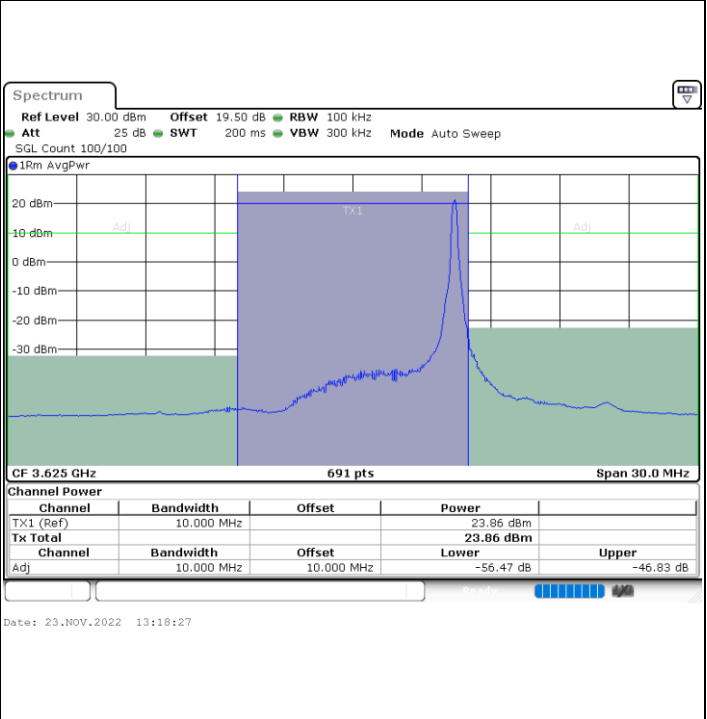

Middle Channel / FullIRB

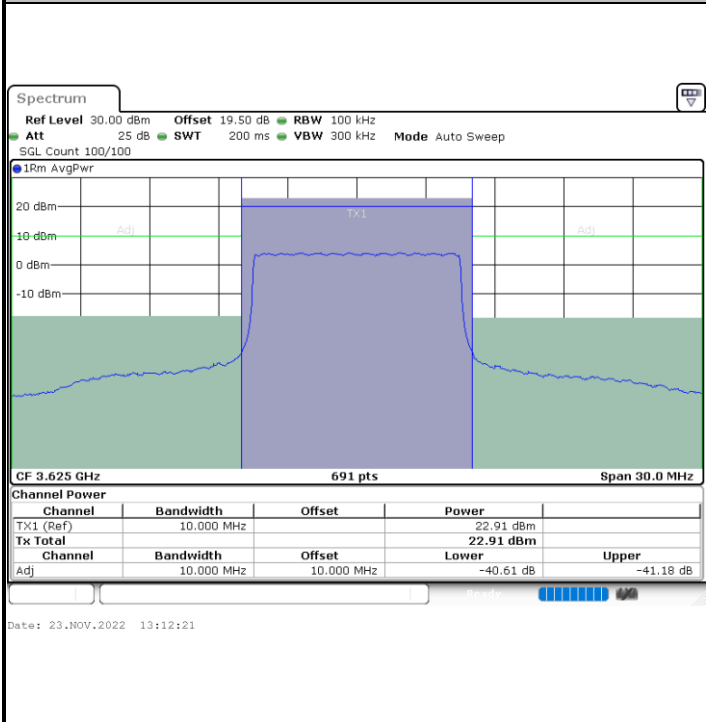

N/A



LTE Band 48 / 10MHz

QPSK

Highest Channel / 1RB0

Highest Channel / 1RBmax

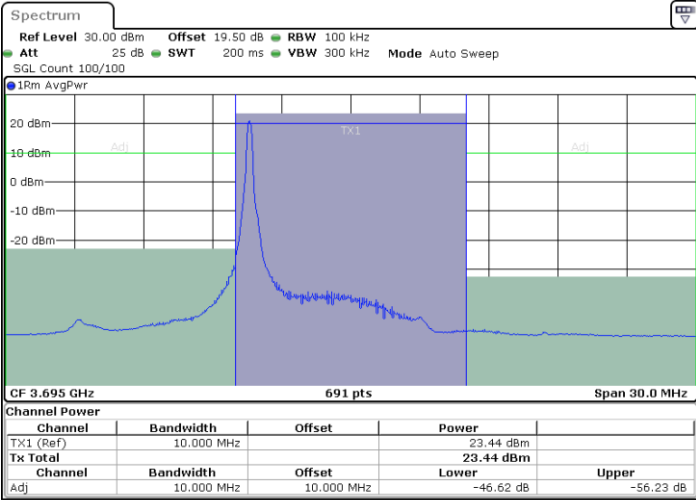

Date: 23.NOV.2022 13:09:38

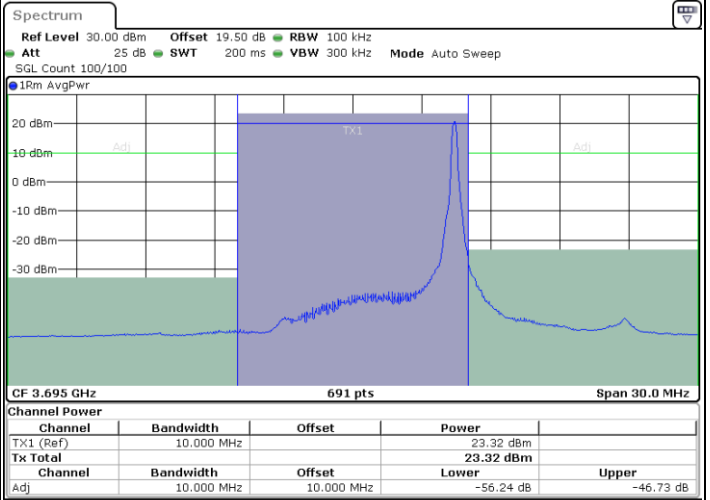

Date: 23.NOV.2022 13:21:52

Highest Channel / FullIRB

N/A

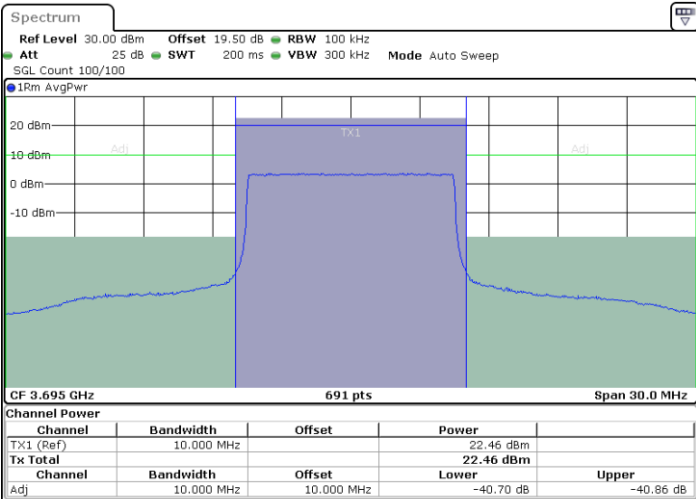

Date: 23.NOV.2022 13:15:44



LTE Band 48 / 15MHz

QPSK

Lowest Channel / 1RB0

Lowest Channel / 1RBmax

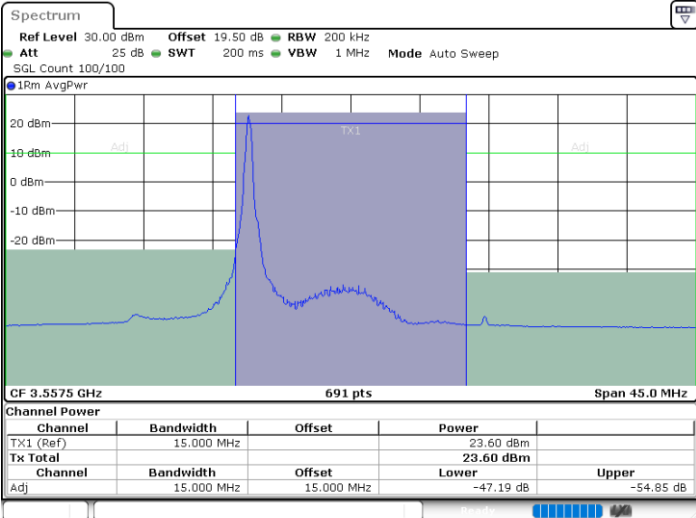

Date: 23.NOV.2022 13:22:33

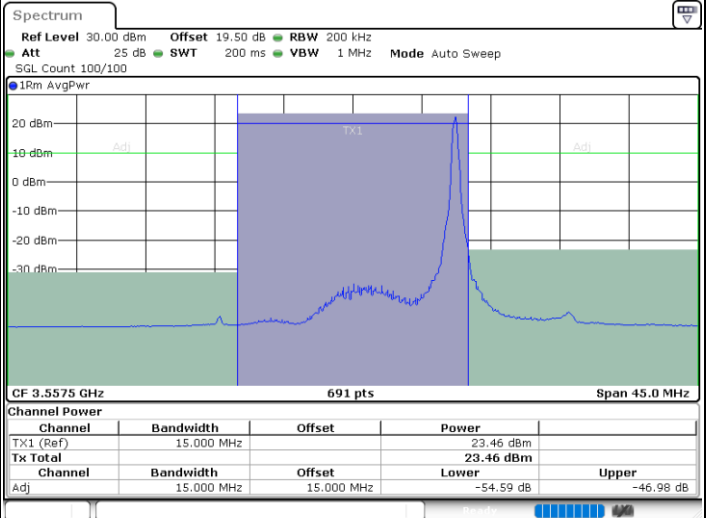

Date: 23.NOV.2022 13:34:48

Lowest Channel / FullIRB

N/A

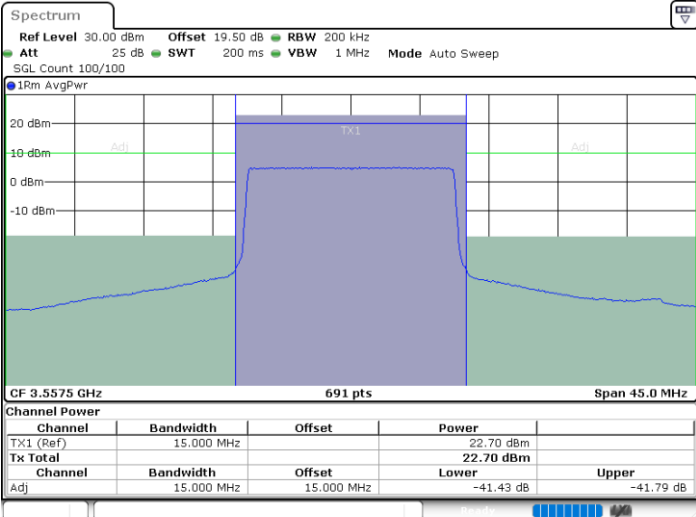

Date: 23.NOV.2022 13:28:40



LTE Band 48 / 15MHz

QPSK

Middle Channel / 1RB0

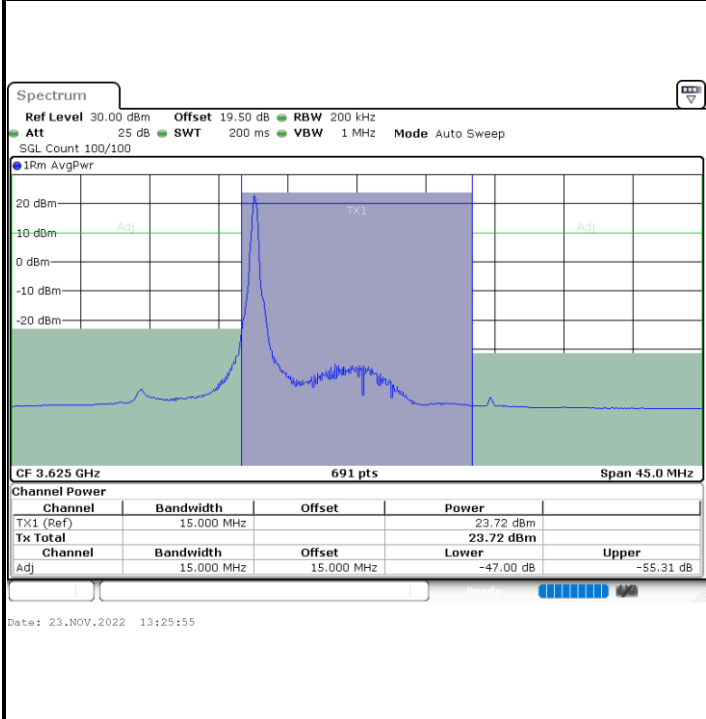

Middle Channel / 1RBmax

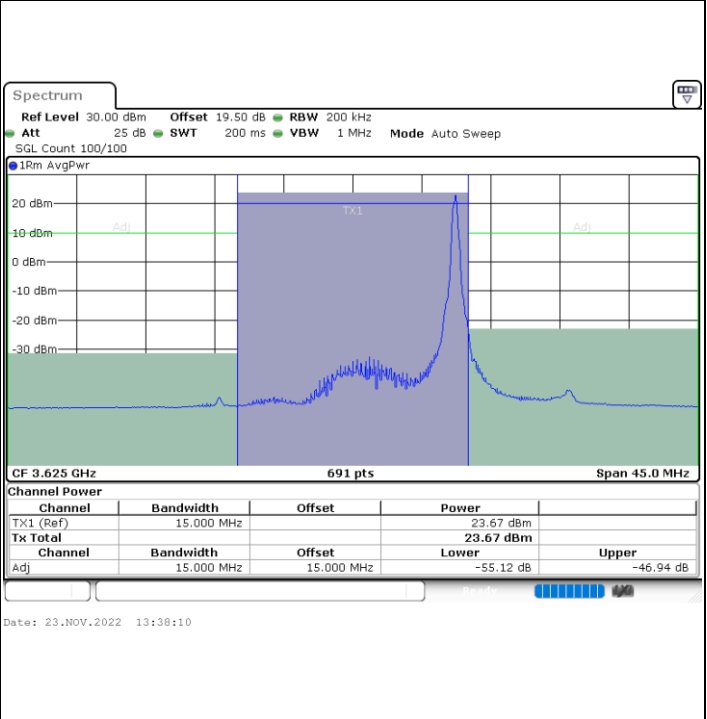

Middle Channel / FullRB

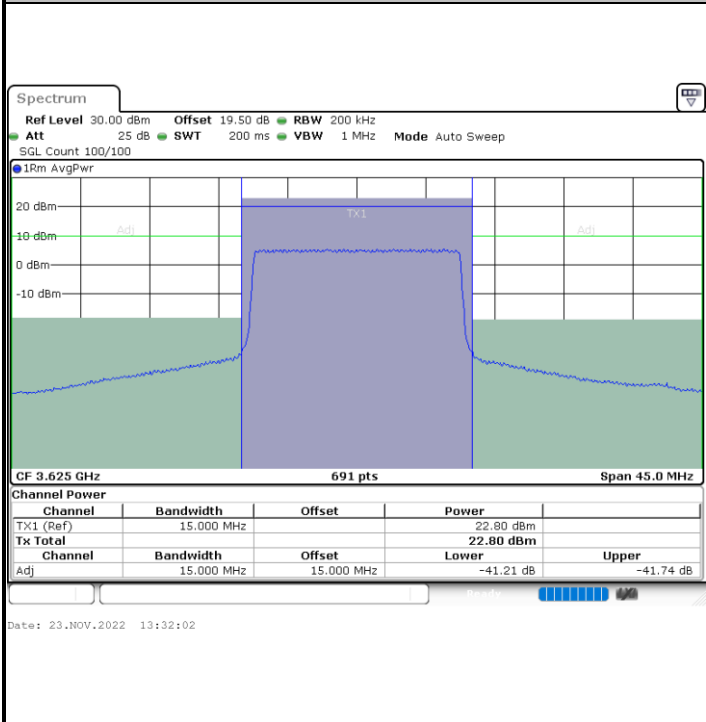

N/A



LTE Band 48 / 15MHz

QPSK

Highest Channel / 1RB0

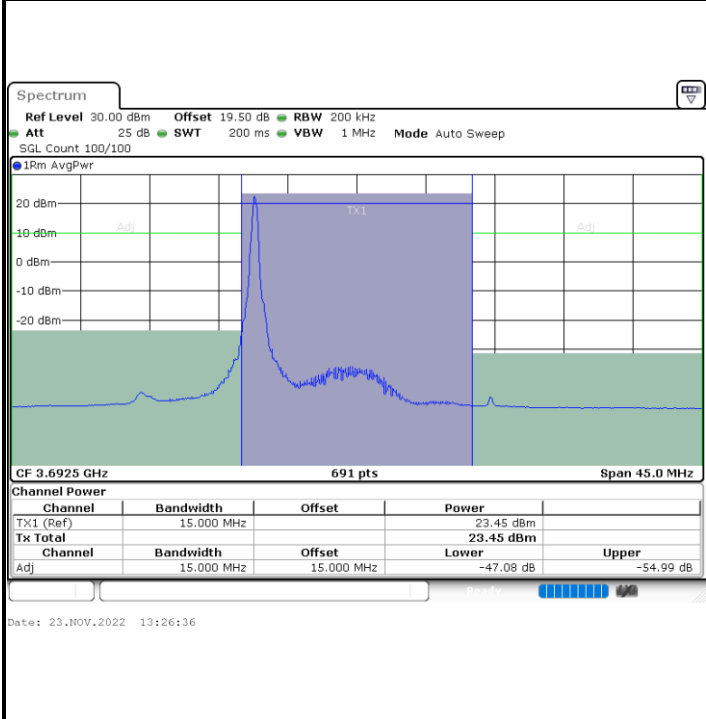

Highest Channel / 1RBmax

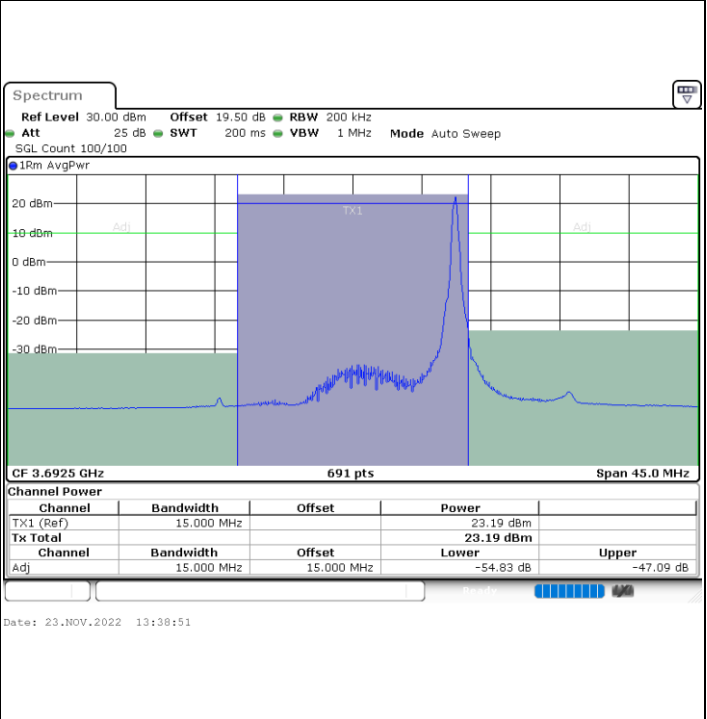

Highest Channel / FullIRB

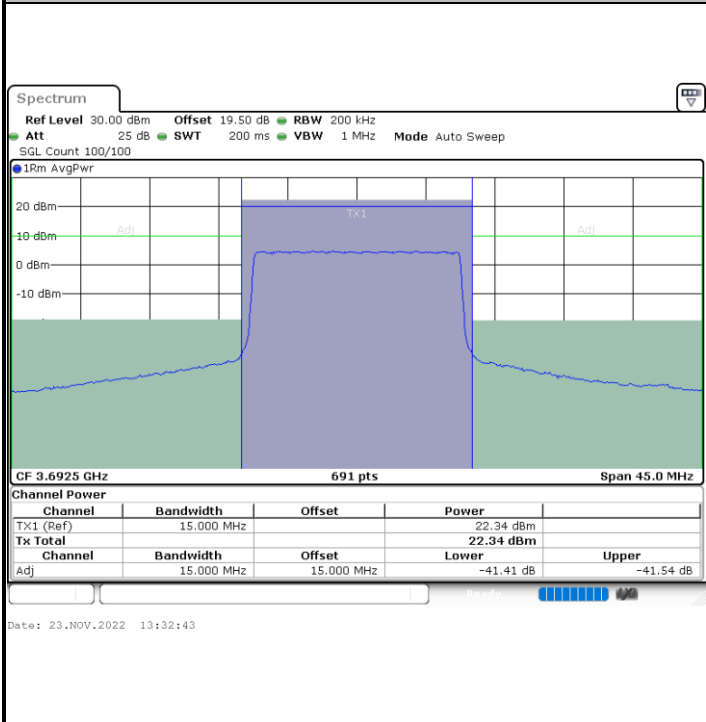

N/A



LTE Band 48 / 20MHz

QPSK

Lowest Channel / 1RB0

Lowest Channel / 1RBmax

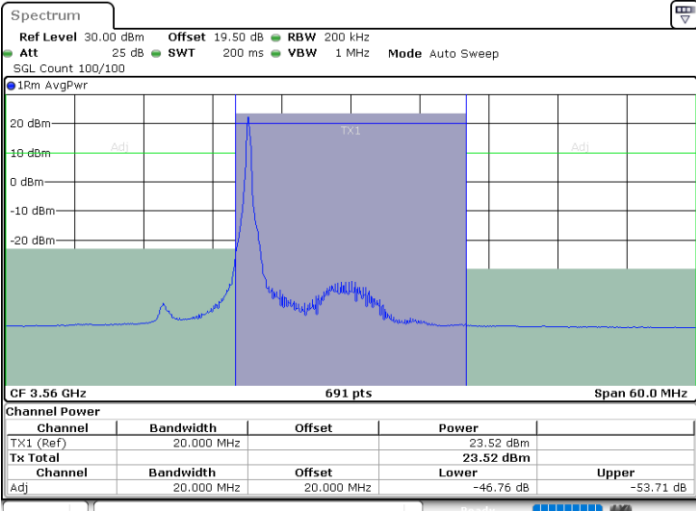

Date: 23.NOV.2022 13:48:12

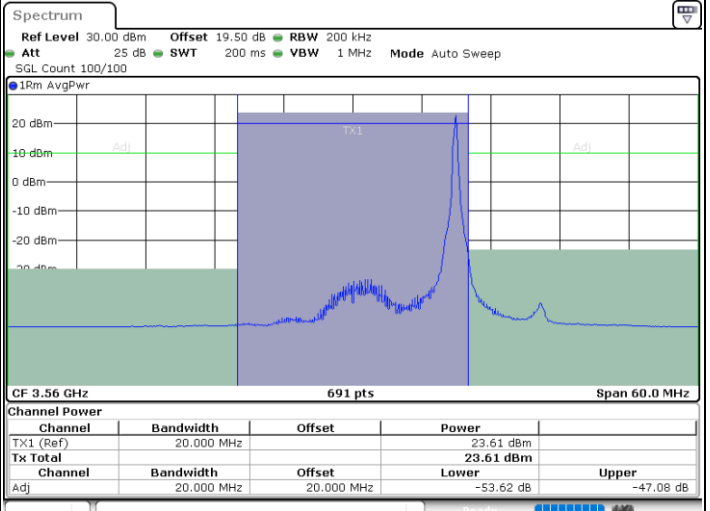

Date: 23.NOV.2022 13:54:09

Lowest Channel / FullIRB

N/A

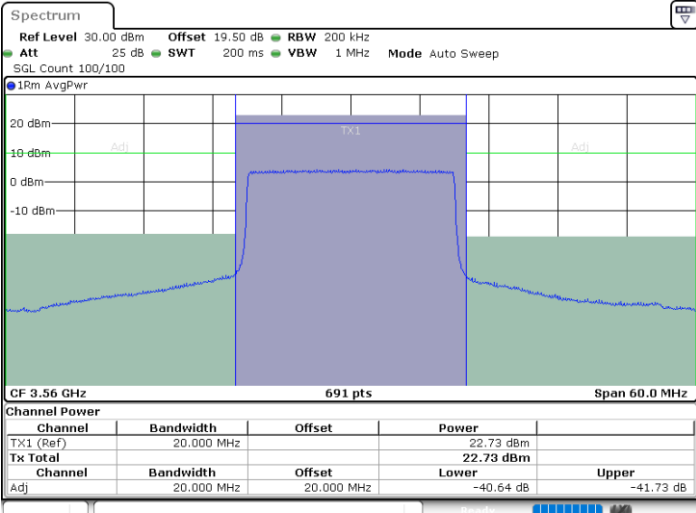

Date: 23.NOV.2022 13:42:15



LTE Band 48 / 20MHz

QPSK

Middle Channel / 1RB0

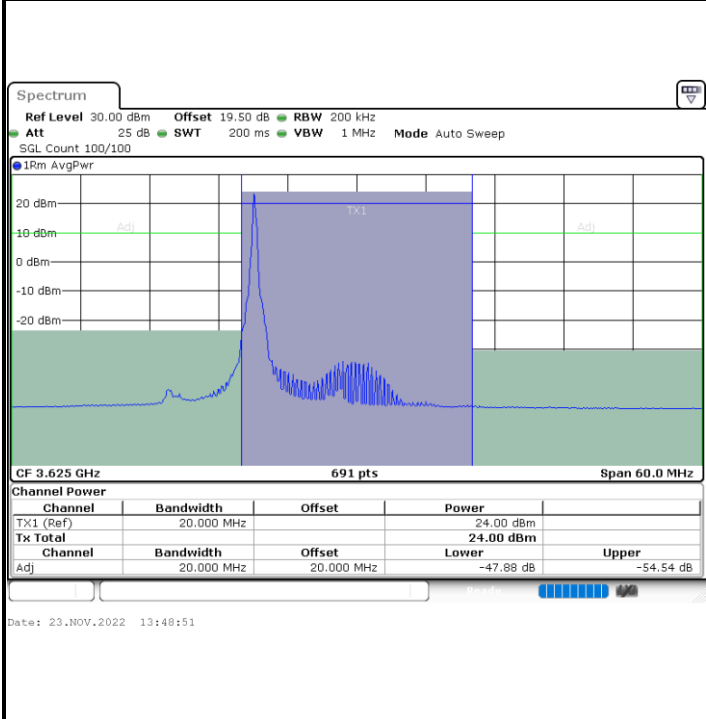

Middle Channel / 1RBmax

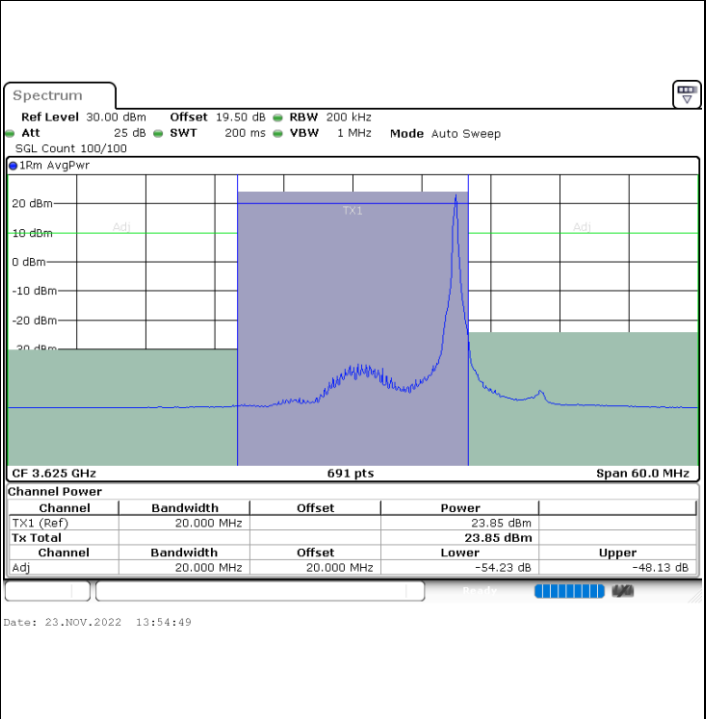

Middle Channel / FullRB

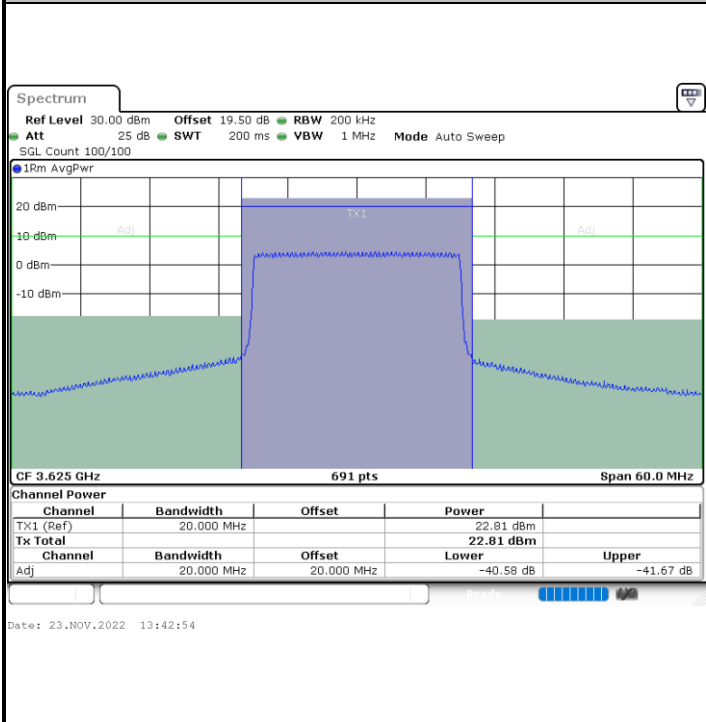

N/A



LTE Band 48 / 20MHz

QPSK

Highest Channel / 1RB0

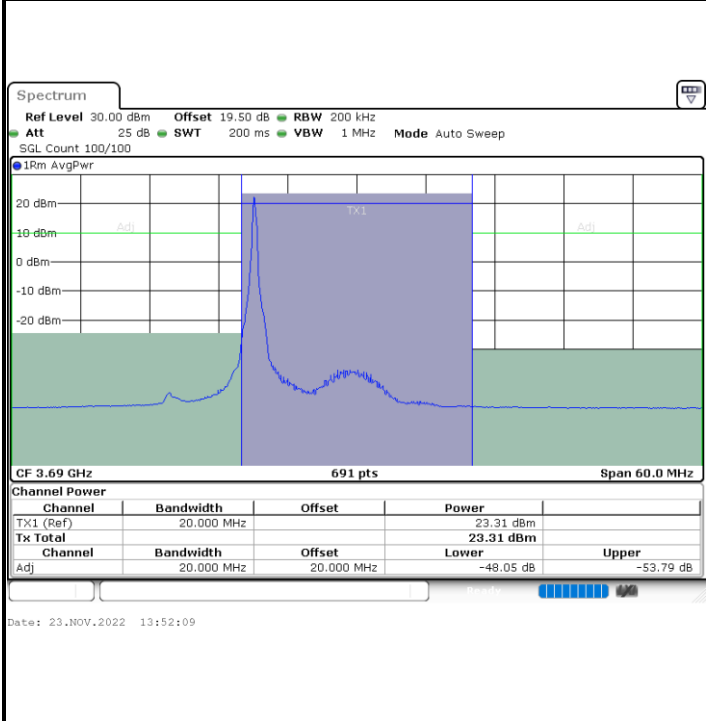

Highest Channel / 1RBmax

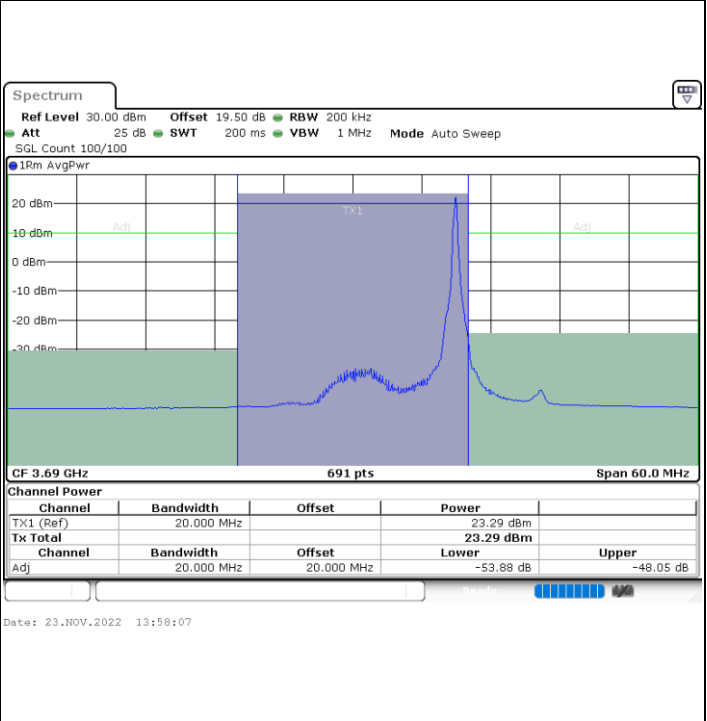

Highest Channel / FullIRB

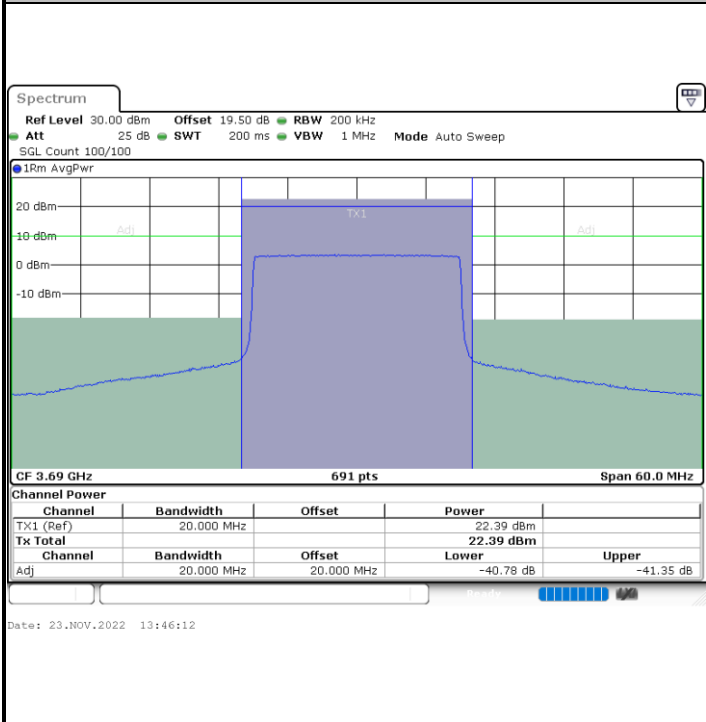

N/A



LTE Band 48 / 5MHz

16QAM

Lowest Channel / 1RB0

Lowest Channel / 1RBmax

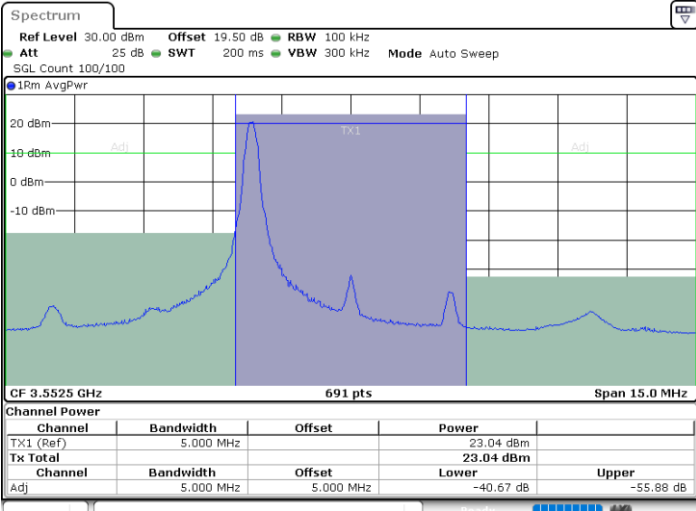

Date: 23.NOV.2022 12:00:42

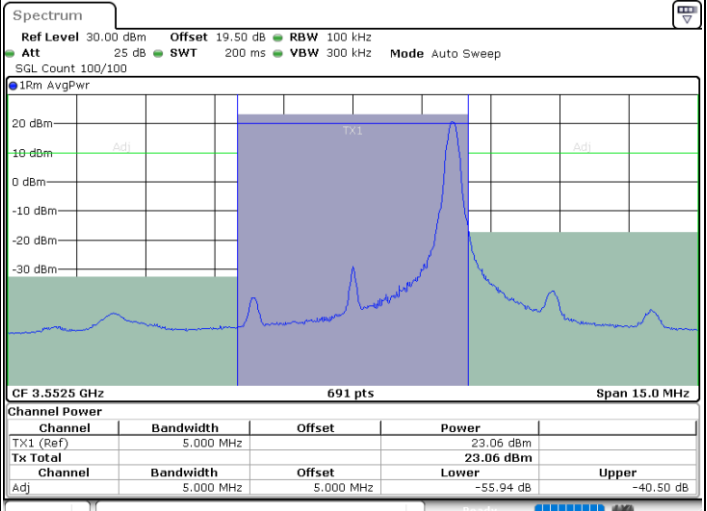

Date: 23.NOV.2022 12:12:54

Lowest Channel / FullIRB

N/A

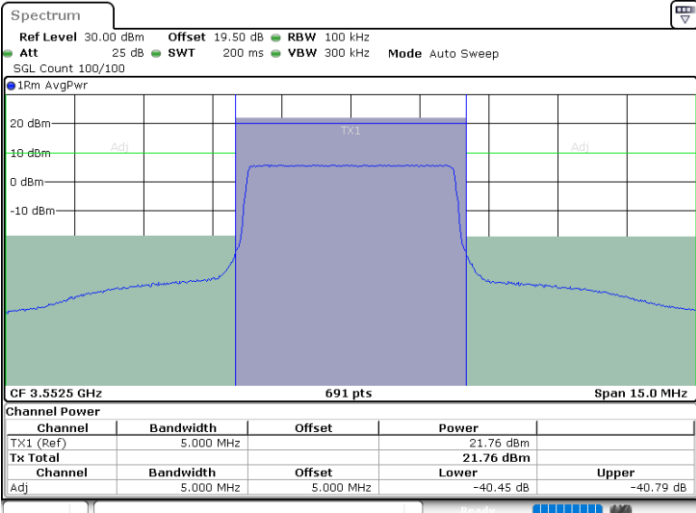

Date: 23.NOV.2022 12:06:47



LTE Band 48 / 5MHz

16QAM

Middle Channel / 1RB0

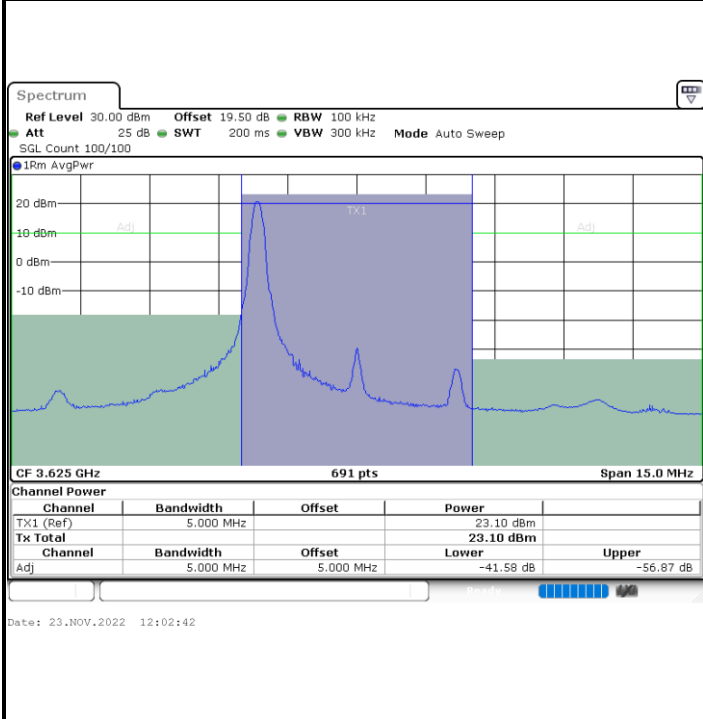

Middle Channel / 1RBmax

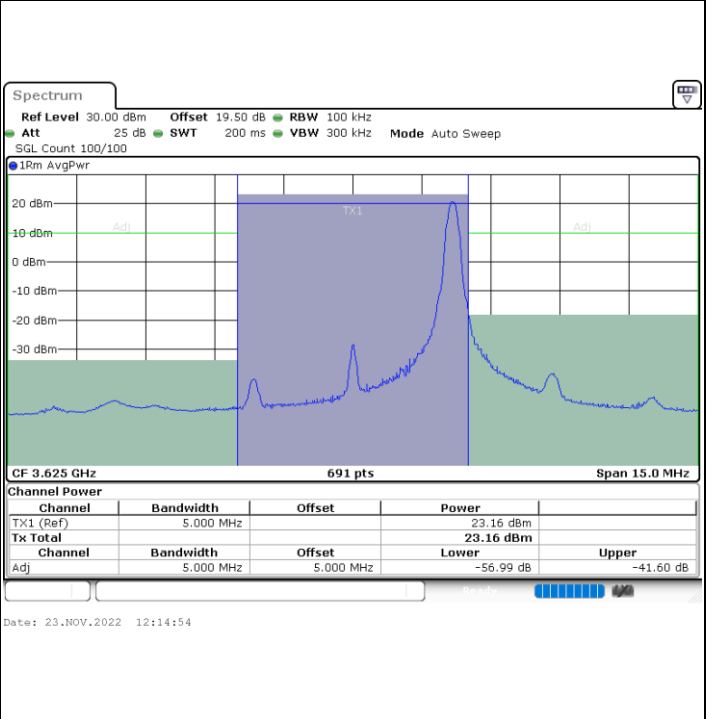

Middle Channel / FullRB

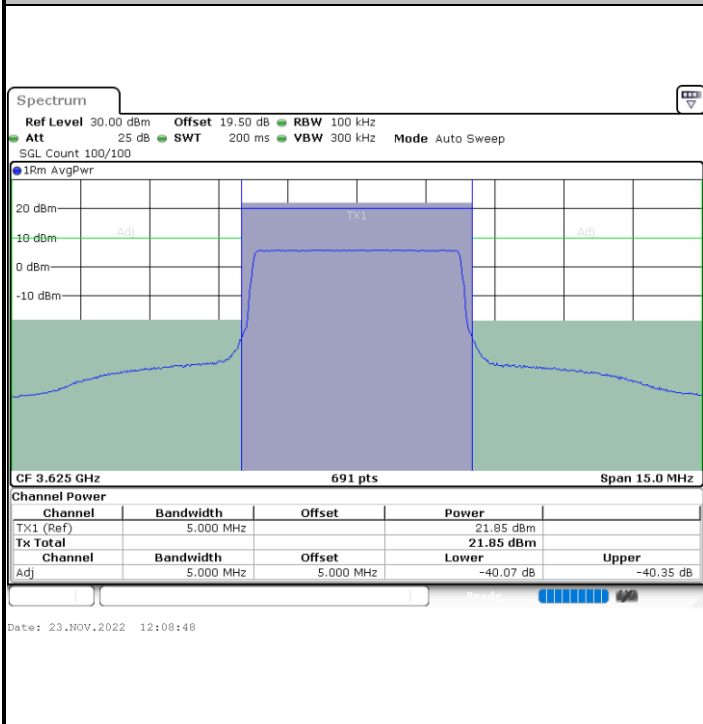

N/A



LTE Band 48 / 5MHz

16QAM

Highest Channel / 1RB0

Highest Channel / 1RBmax

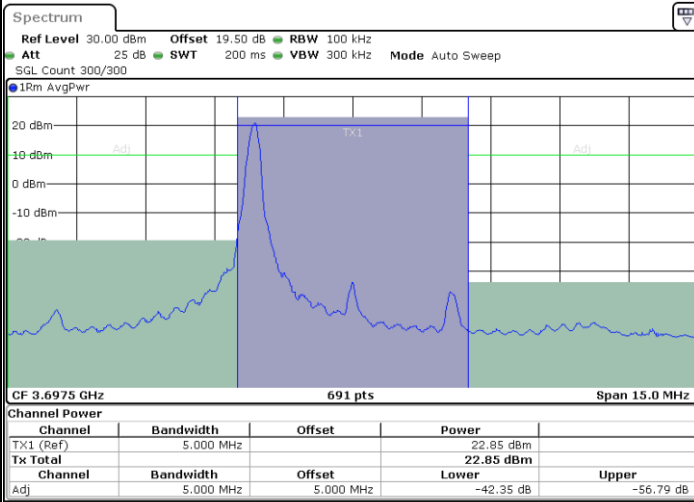

Date: 23.NOV.2022 15:35:28

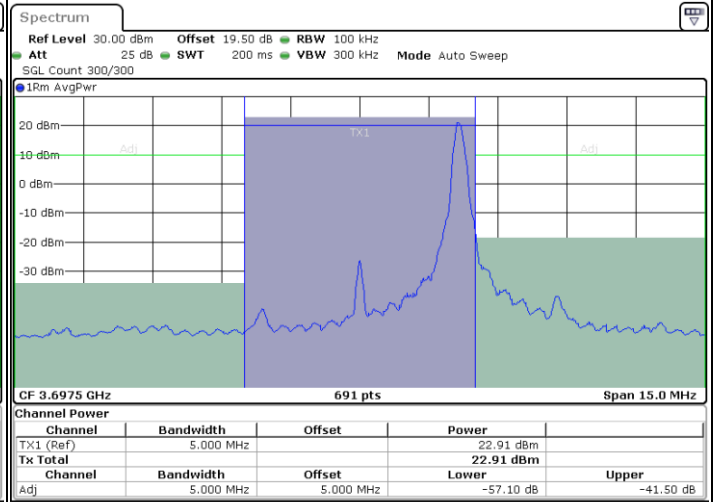

Date: 23.NOV.2022 15:49:50

Highest Channel / FullIRB

N/A

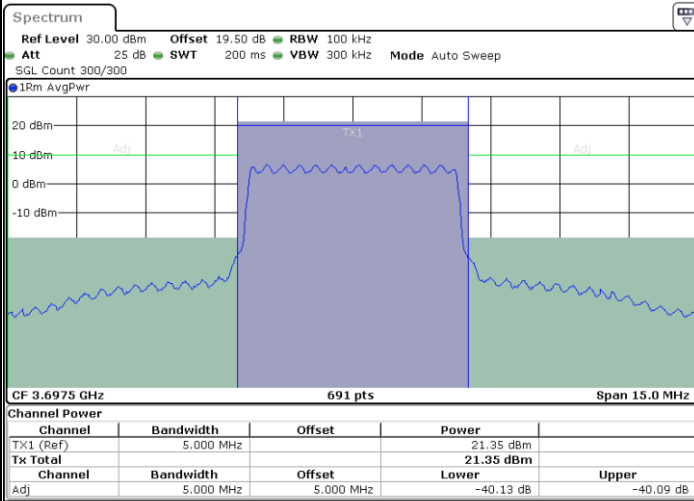

Date: 23.NOV.2022 16:01:19



LTE Band 48 / 10MHz

16QAM

Lowest Channel / 1RB0

Lowest Channel / 1RBmax

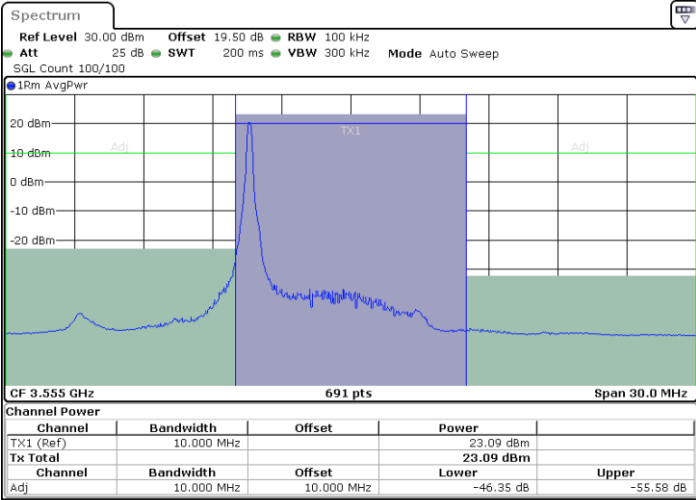

Date: 23.NOV.2022 13:04:54

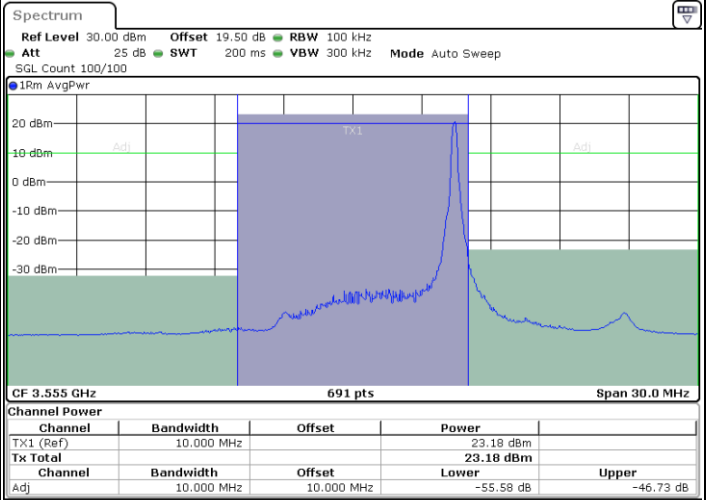

Date: 23.NOV.2022 13:17:06

Lowest Channel / FullIRB

N/A

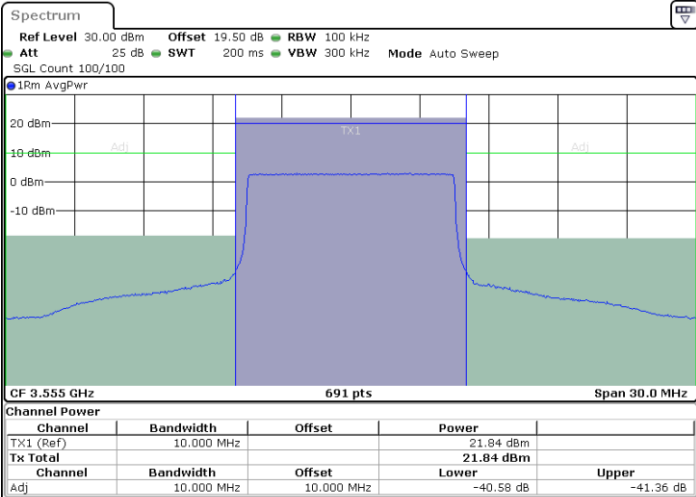

Date: 23.NOV.2022 13:11:00



LTE Band 48 / 10MHz

16QAM

MiddleChannel / 1RB0

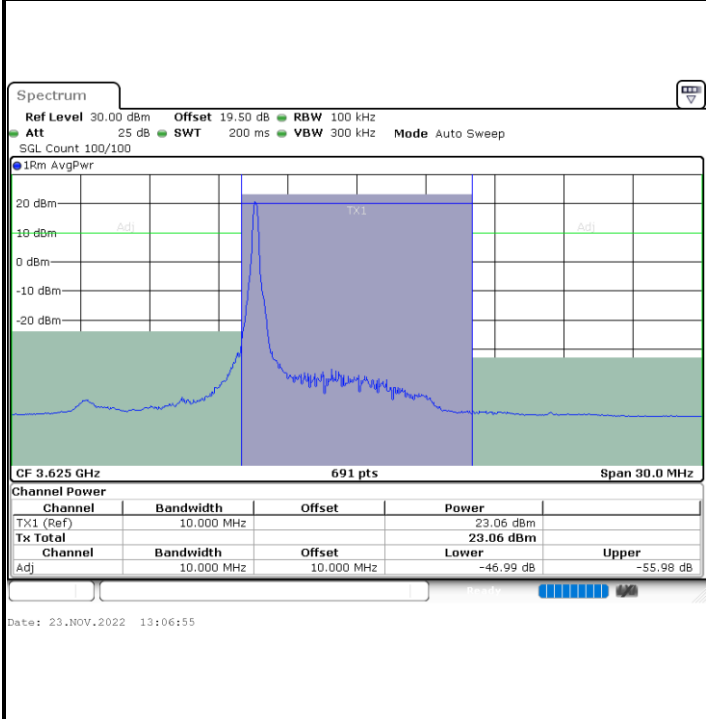

Middle Channel / 1RBmax

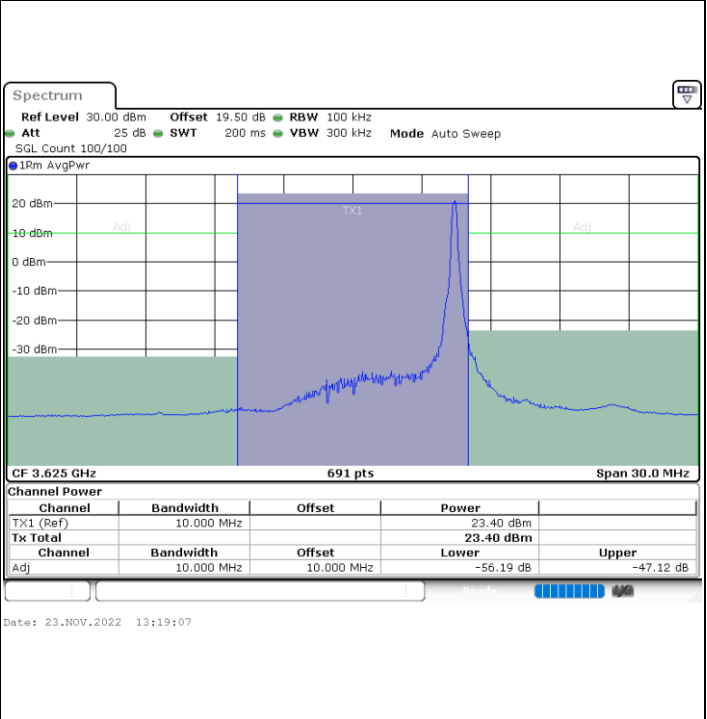

Middle Channel / FullIRB

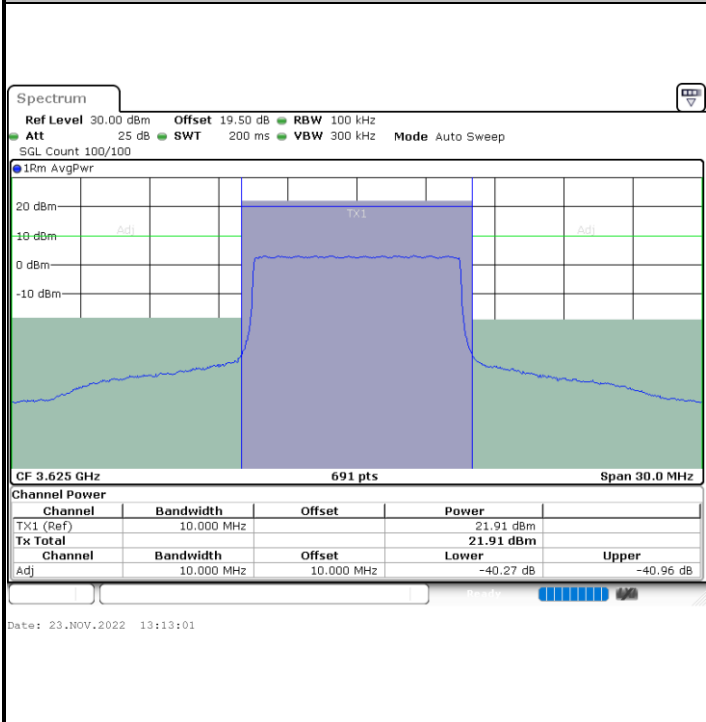

N/A



LTE Band 48 / 10MHz

16QAM

Highest Channel / 1RB0

Highest Channel / 1RBmax

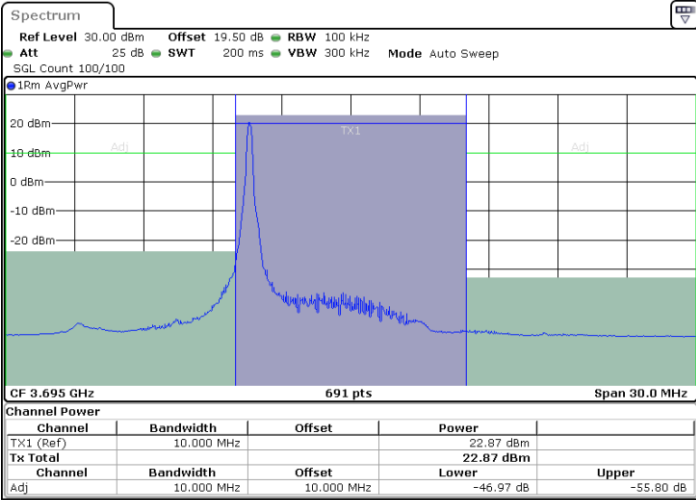

Date: 23.NOV.2022 13:08:57

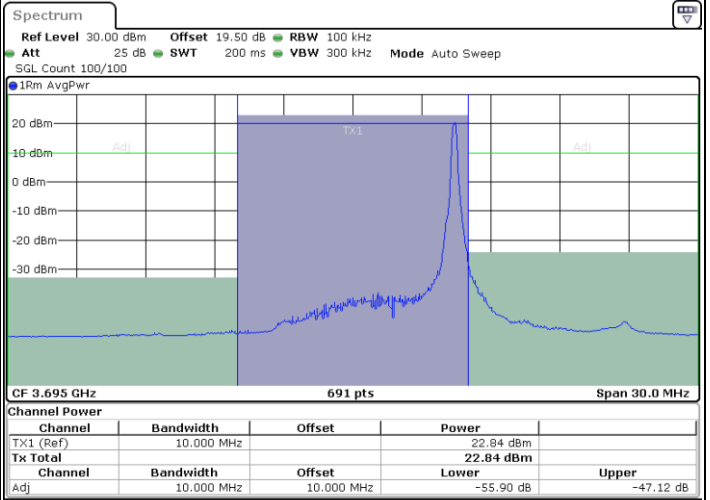

Date: 23.NOV.2022 13:21:10

Highest Channel / FullIRB

N/A

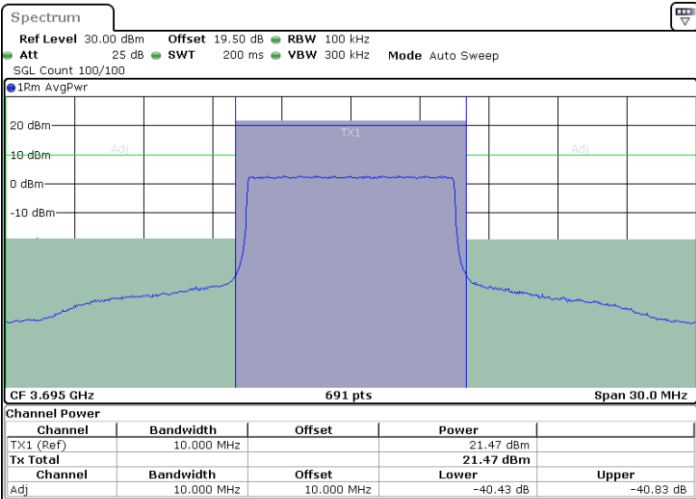

Date: 23.NOV.2022 13:15:03



LTE Band 48 / 15MHz

16QAM

Lowest Channel / 1RB0

Lowest Channel / 1RBmax

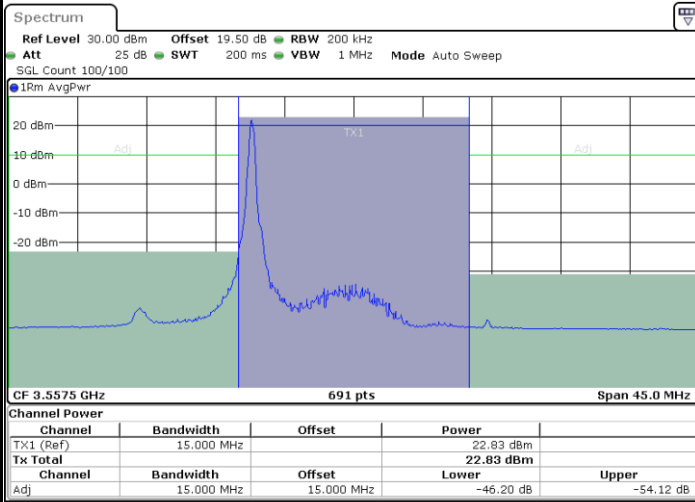

Date: 23.NOV.2022 13:23:14

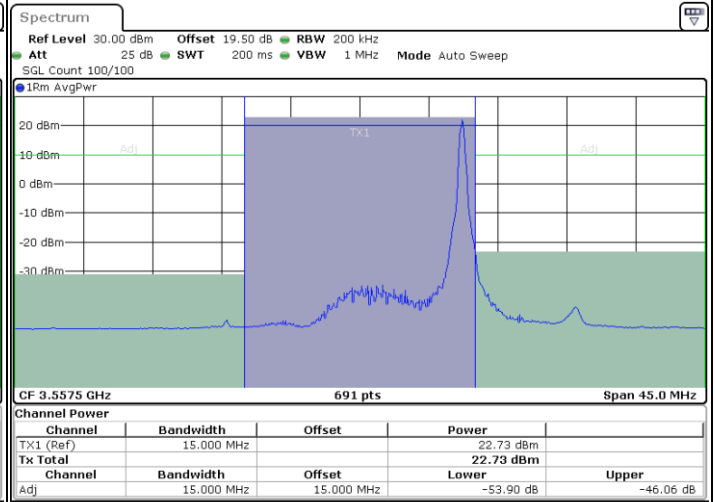

Date: 23.NOV.2022 13:35:29

Lowest Channel / FullIRB

N/A

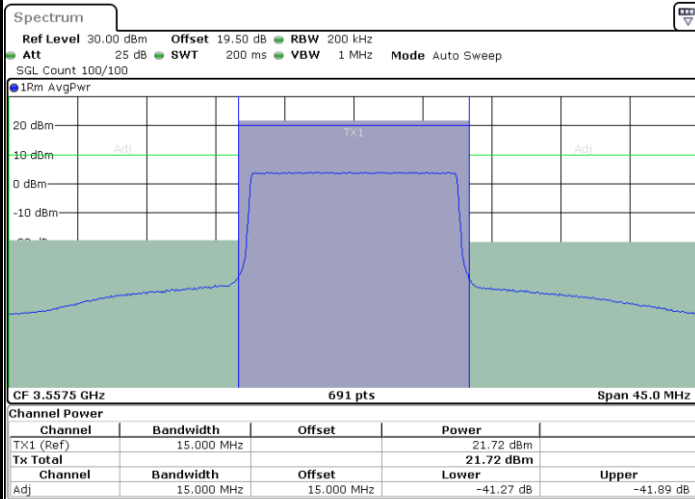

Date: 23.NOV.2022 13:29:21



LTE Band 48 / 15MHz

16QAM

Middle Channel / 1RB0

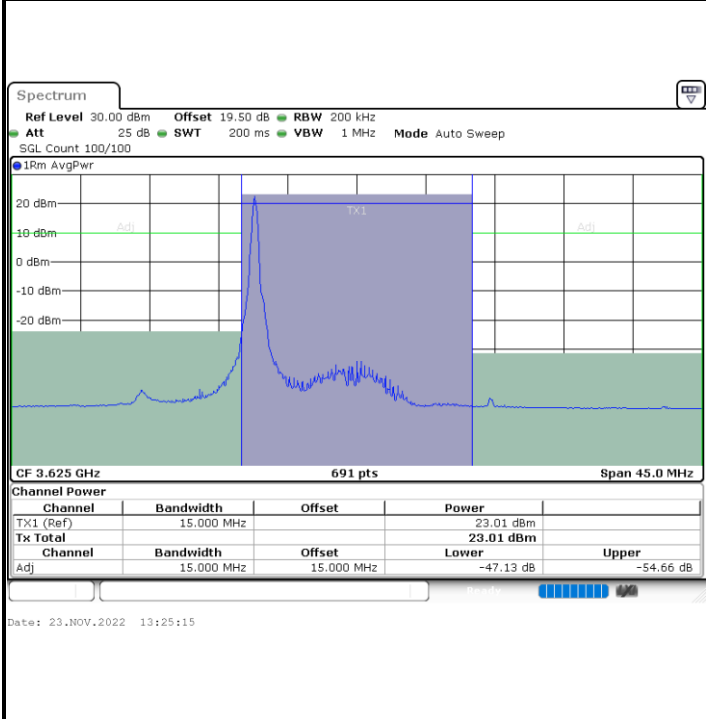

Middle Channel / 1RBmax

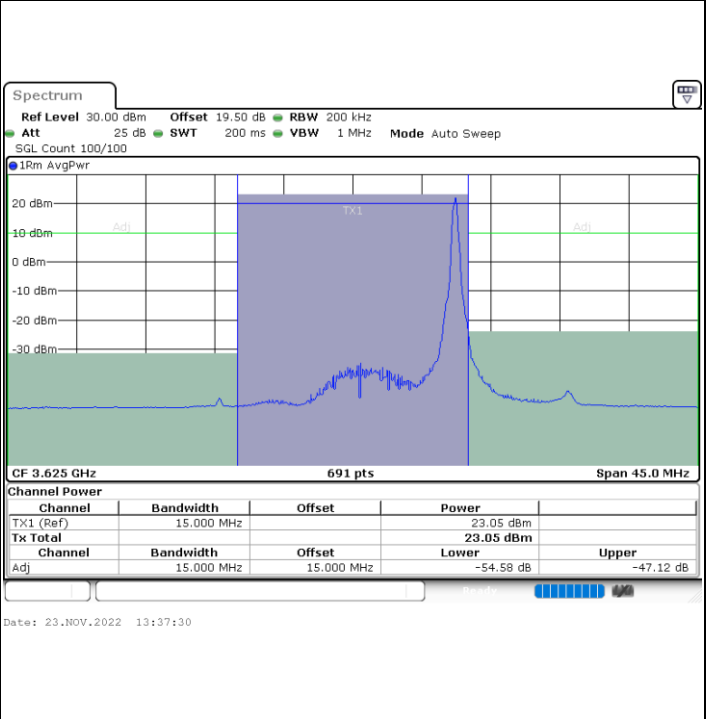

Middle Channel / FullRB

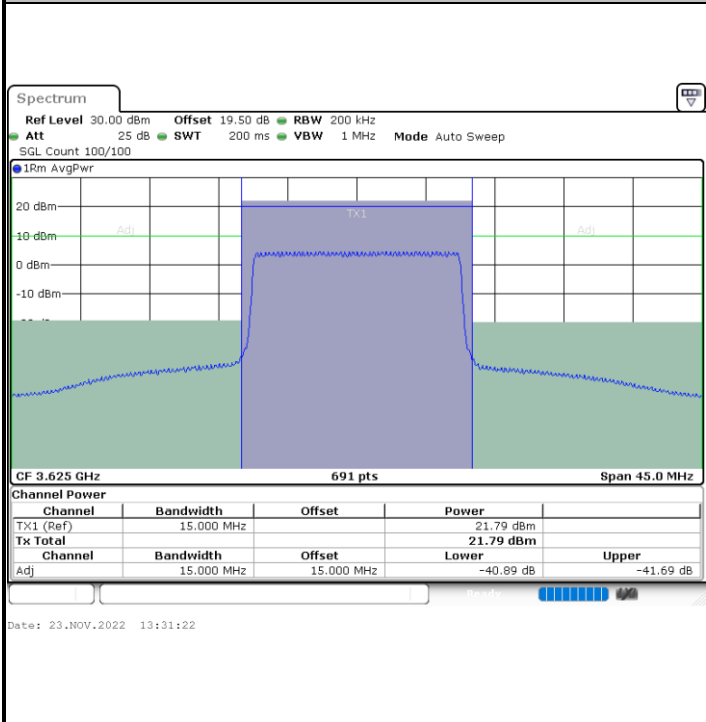

N/A

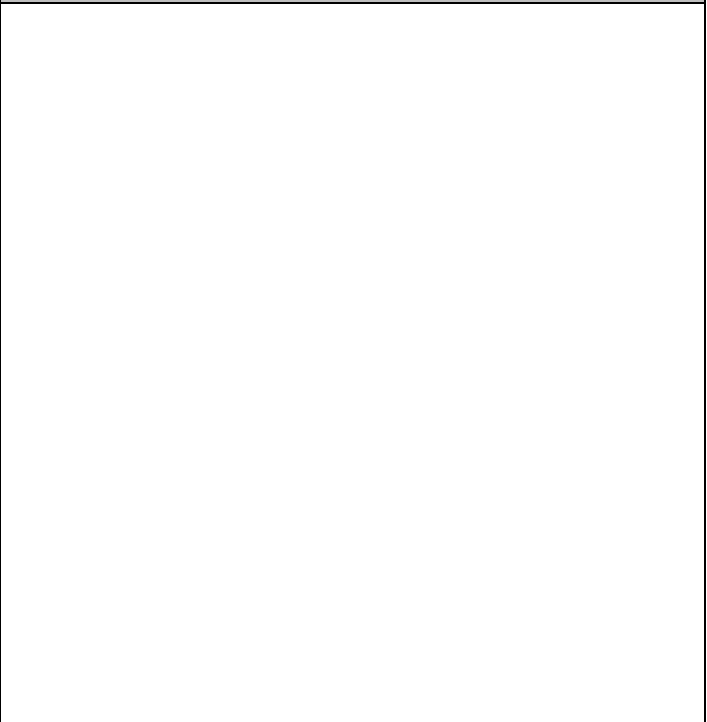



LTE Band 48 / 15MHz

16QAM

Highest Channel / 1RB0

Highest Channel / 1RBmax

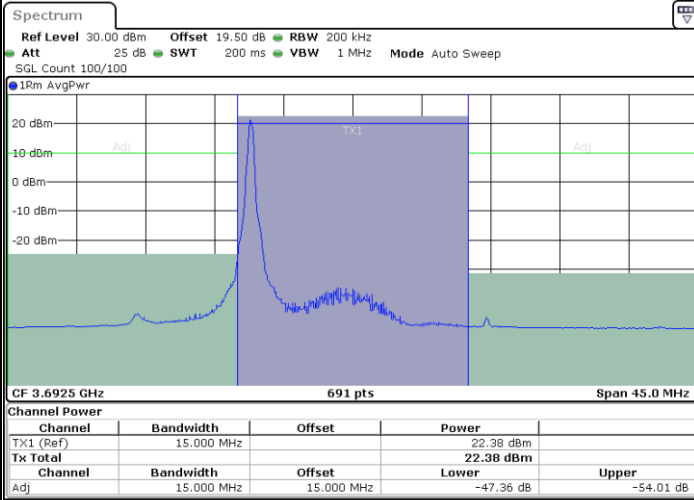

Date: 23.NOV.2022 13:27:17

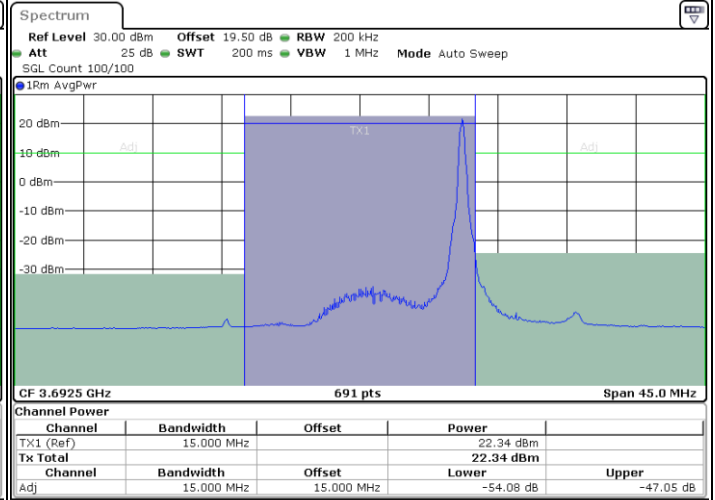

Date: 23.NOV.2022 13:39:32

Highest Channel / FullIRB

N/A

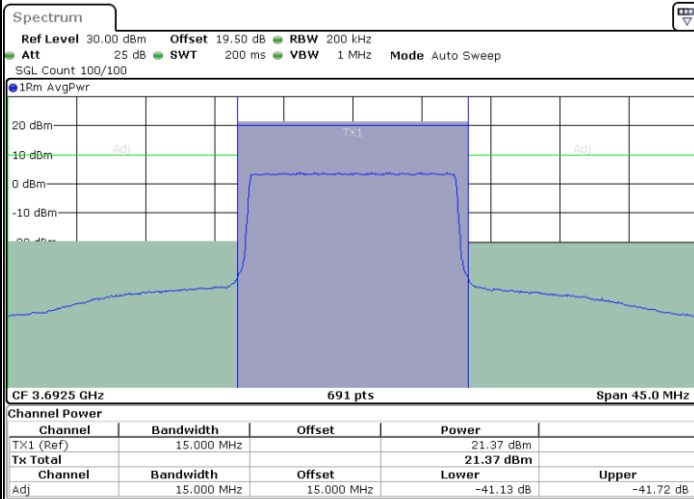

Date: 23.NOV.2022 13:33:25



LTE Band 48 / 20MHz

16QAM

Lowest Channel / 1RB0

Lowest Channel / 1RBmax

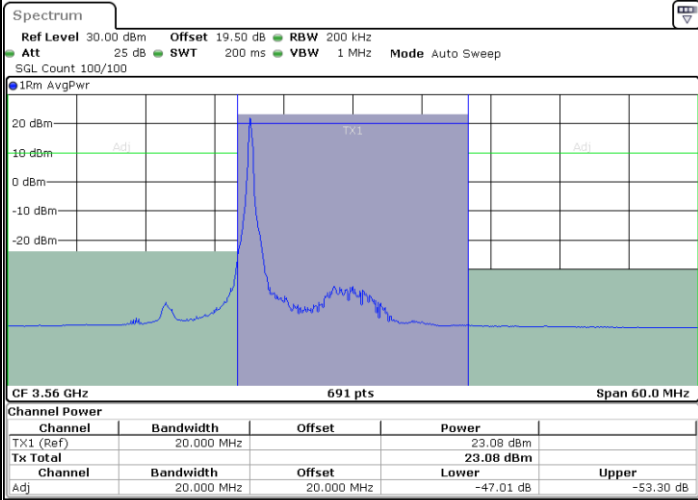

Date: 23.NOV.2022 13:47:32

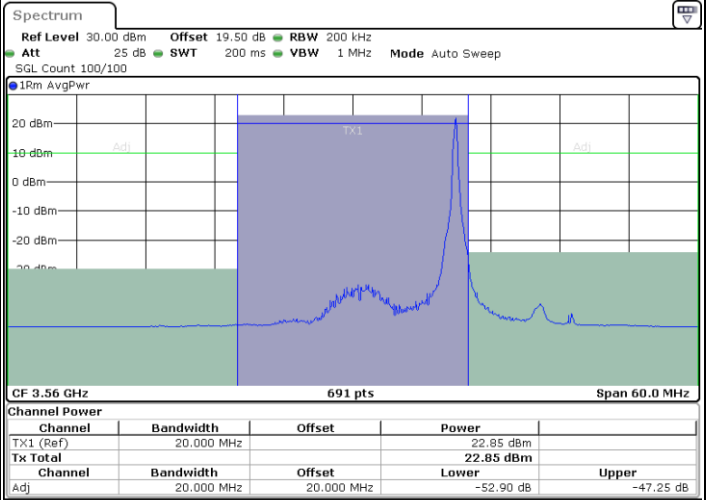

Date: 23.NOV.2022 13:53:29

Lowest Channel / FullIRB

N/A

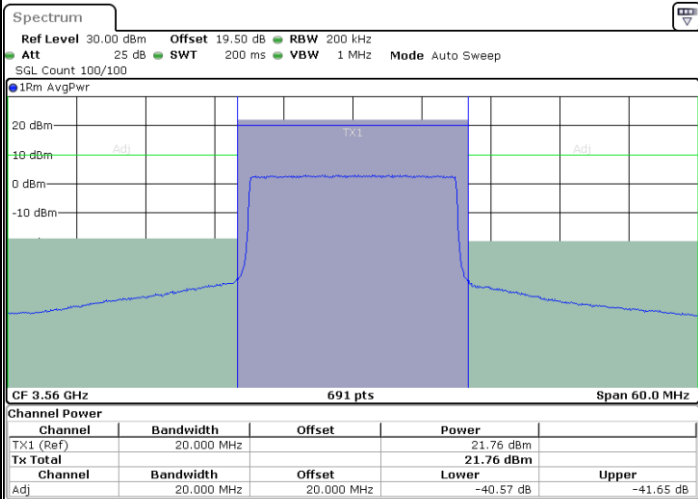

Date: 23.NOV.2022 13:41:35



LTE Band 48 / 20MHz

16QAM

Middle Channel / 1RB0

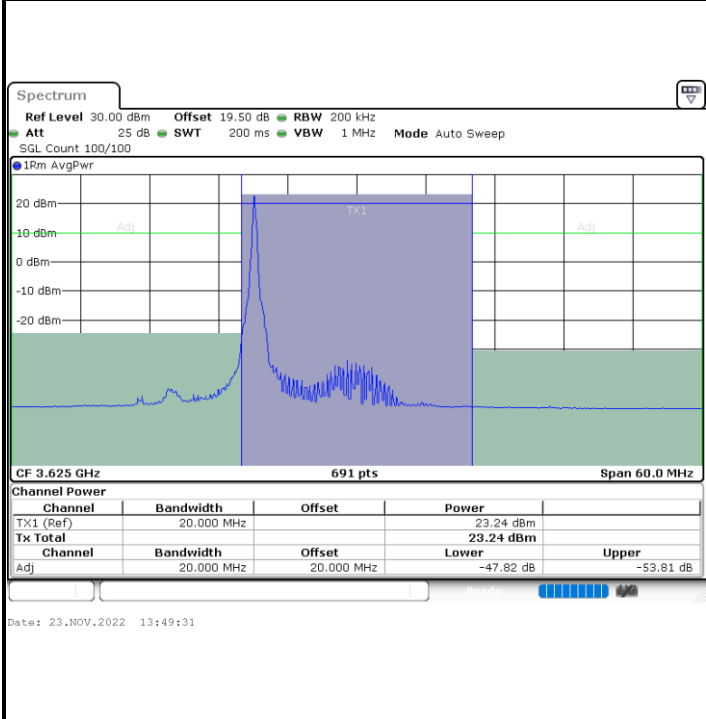

Middle Channel / 1RBmax

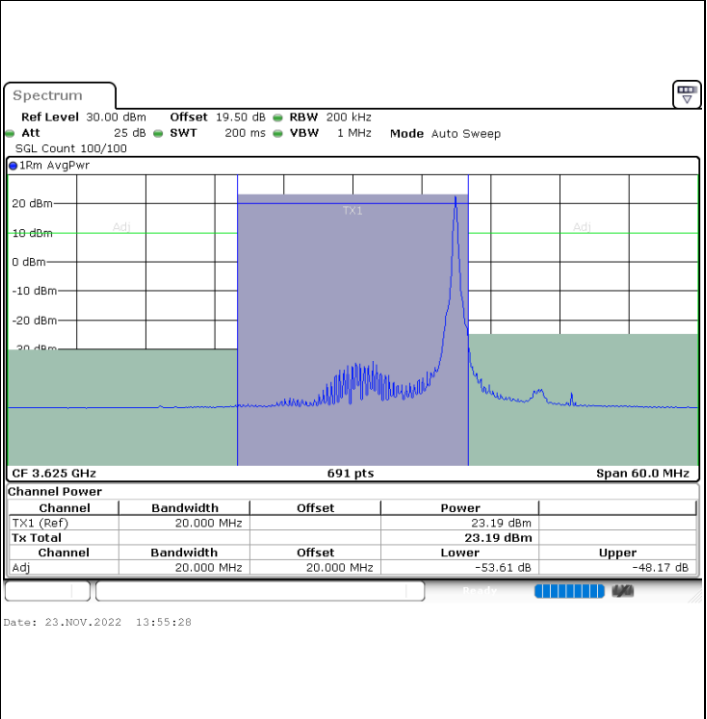

Middle Channel / FullRB

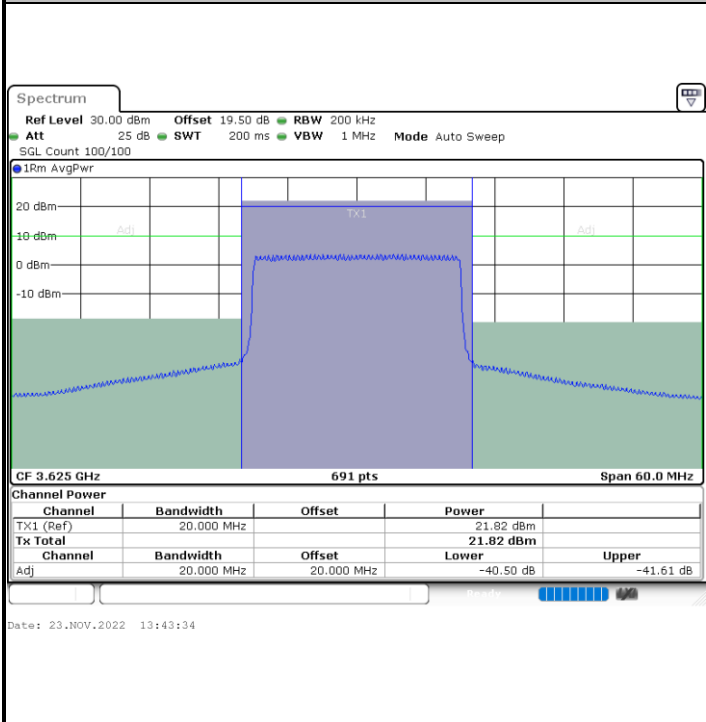

N/A

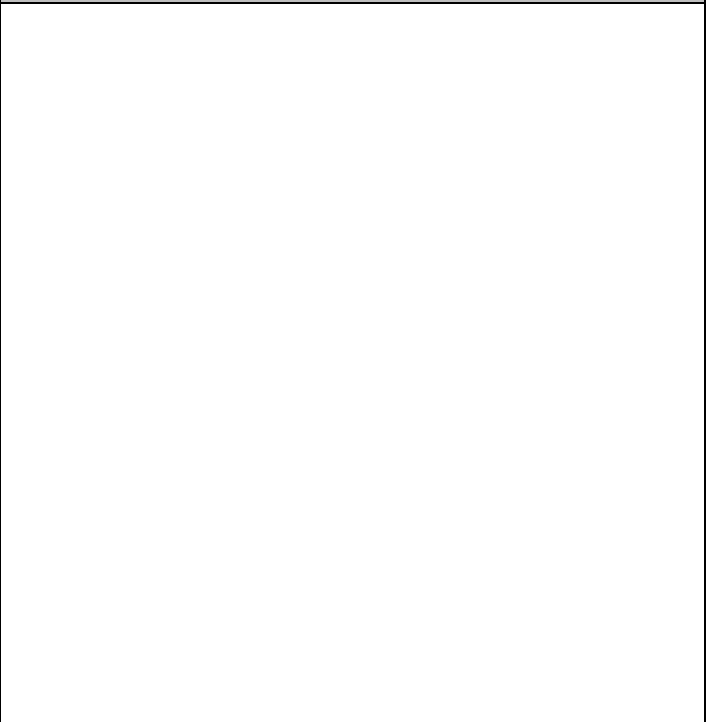



LTE Band 48 / 20MHz

16QAM

Highest Channel / 1RB0

Highest Channel / 1RBmax

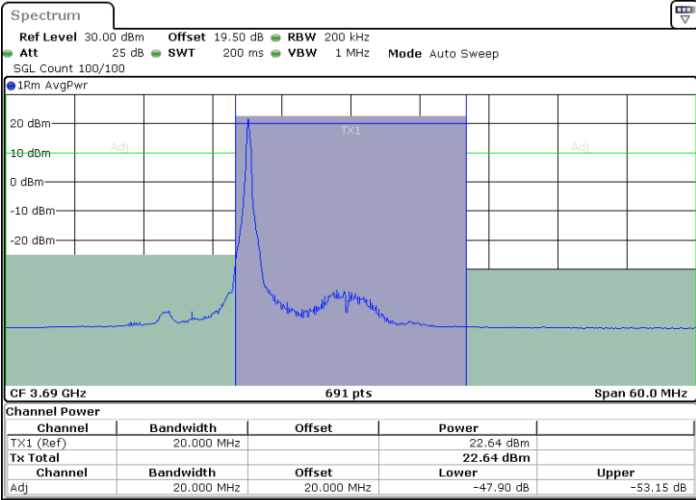

Date: 23.NOV.2022 13:51:29

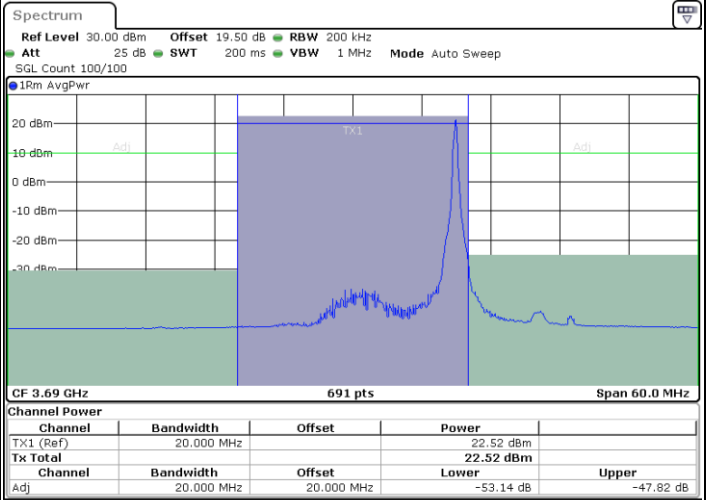

Date: 23.NOV.2022 13:57:27

Highest Channel / FullIRB

N/A

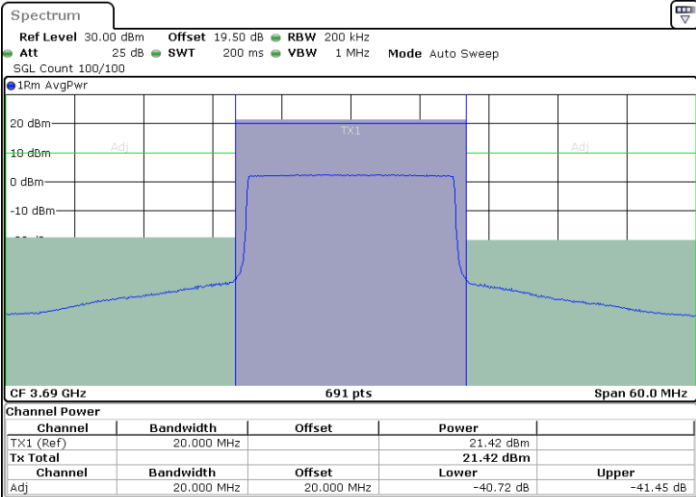

Date: 23.NOV.2022 13:45:32



LTE Band 48 / 5MHz

64QAM

Lowest Channel / 1RB0

Lowest Channel / 1RBmax

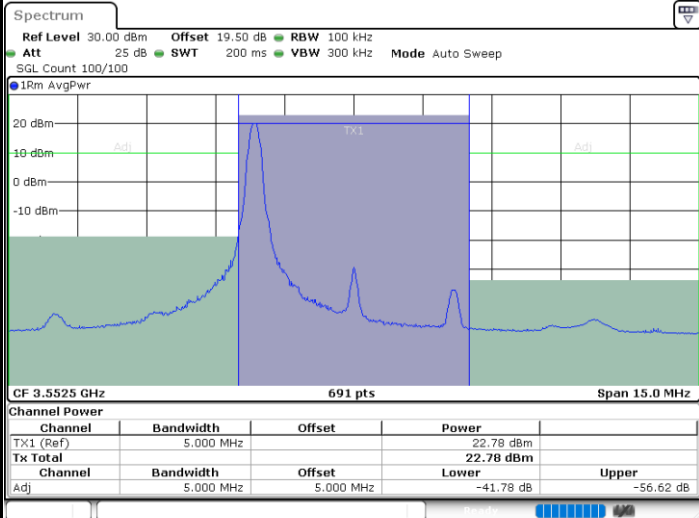

Date: 23.NOV.2022 12:01:22

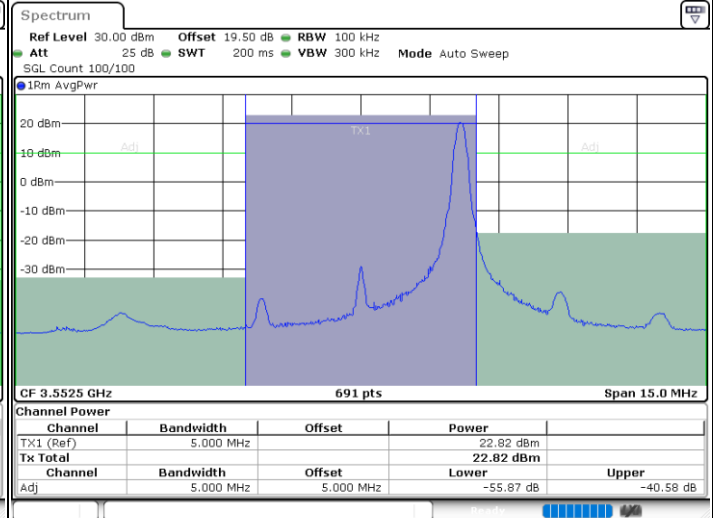

Date: 23.NOV.2022 12:13:34

Lowest Channel / FullIRB

N/A

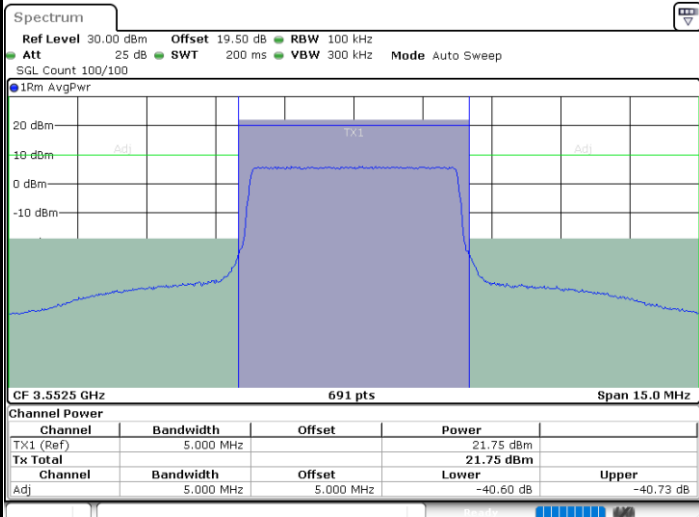

Date: 23.NOV.2022 12:07:28