



FCC RF Test Report

APPLICANT : Motorola Mobility LLC
EQUIPMENT : Mobile Phone
BRAND NAME : Motorola
MODEL NAME : XT2239-7
FCC ID : IHDT56AG6
STANDARD : 47 CFR Part 2, 27(M)
CLASSIFICATION : Licensed Non-Broadcast Transmitter Held to Ear(TNE)
TEST DATE(S) : Jun. 22, 2022 ~ Jun. 29, 2022

We, Sporton International Inc. (Kunshan), would like to declare that the tested sample has been evaluated in accordance with the procedures given in ANSI C63.26-2015 and shown compliance with the applicable technical standards.

The test results in this report apply exclusively to the tested model / sample. Without written approval of Sporton International Inc. (Kunshan), the test report shall not be reproduced except in full.

Jason Jia

Approved by: Jason Jia



Sporton International Inc. (Kunshan)

**No. 1098, Pengxi North Road, Kunshan Economic Development Zone Jiangsu Province 215300
People's Republic of China**



TABLE OF CONTENTS

REVISION HISTORY...3
SUMMARY OF TEST RESULT...4
1 GENERAL DESCRIPTION...5
1.1 Applicant...5
1.2 Manufacturer...5
1.3 Product Feature of Equipment Under Test...5
1.4 Product Specification of Equipment Under Test...5
1.5 Modification of EUT...5
1.6 Maximum EIRP and Emission Designator...6
1.7 Testing Location...6
1.8 Test Software...6
1.9 Applicable Standards...7
1.10 Specification of Accessory...8
2 TEST CONFIGURATION OF EQUIPMENT UNDER TEST...9
2.1 Test Mode...9
2.2 Connection Diagram of Test System...10
2.3 Support Unit used in test configuration and system...10
2.4 Measurement Results Explanation Example...10
2.5 Frequency List of Low/Middle/High Channels...11
3 CONDUCTED TEST ITEMS...12
3.1 Measuring Instruments...12
3.2 Test Setup...12
3.3 Test Result of Conducted Test...12
3.4 Conducted Output Power and EIRP...13
3.5 Peak-to-Average Ratio...14
3.6 Occupied Bandwidth...15
3.7 Conducted Band Edge...16
3.8 Conducted Spurious Emission...17
3.9 Frequency Stability...18
4 RADIATED TEST ITEMS...19
4.1 Measuring Instruments...19
4.2 Test Setup...19
4.3 Test Result of Radiated Test...20
4.4 Radiated Spurious Emission...21
5 LIST OF MEASURING EQUIPMENT...22
6 UNCERTAINTY OF EVALUATION...23
APPENDIX A. TEST RESULTS OF CONDUCTED TEST
APPENDIX B. TEST RESULTS OF RADIATED TEST
APPENDIX C. TEST SETUP PHOTOGRAPHS



SUMMARY OF TEST RESULT

Report Section	FCC Rule	Description	Limit	Result	Remark
3.4	§2.1046	Conducted Output Power	-	Report Only	-
	§27.50(h)(2)	Equivalent Isotropic Radiated Power (Band 41)	EIRP < 2Watt		-
3.5	N/A	Peak-to-Average Ratio	<13 dB	PASS	-
3.6	§2.1049	Occupied Bandwidth	-	Report Only	-
3.7	§27.53(m)(4)	Conducted Band Edge Measurement (Band 41)	§27.53(m)(4)	PASS	-
3.8	§2.1051 §27.53(m)(4)	Conducted Spurious Emission (Band 41)	< 55+10log ₁₀ (P[Watts])	PASS	-
3.9	§2.1055 §27.54	Frequency Stability Temperature & Voltage	Within Authorized Band	PASS	-
4.4	§2.1053 §27.53(m)(4)	Radiated Spurious Emission (Band 41)	< 55+10log ₁₀ (P[Watts])	PASS	Under limit 21.87 dB at 5168.00MHz

Declaration of Conformity:

The test results with all measurement uncertainty excluded are presented in accordance with the regulation limits or requirements declared by manufacturers.

Comments and Explanations:

The declared of product specification for EUT presented in the report are provided by the manufacturer, and the manufacturer takes all the responsibilities for the accuracy of product specification.



1 General Description

1.1 Applicant

Motorola Mobility LLC
222 W,Merchandise Mart Plaza, Chicago, IL 60654 USA

1.2 Manufacturer

Motorola Mobility LLC
222 W,Merchandise Mart Plaza, Chicago, IL 60654 USA

1.3 Product Feature of Equipment Under Test

Product Feature	
Equipment	Mobile Phone
Brand Name	Motorola
Model Name	XT2239-7
FCC ID	IHDT56AG6
IMEI Code	Conducted: 351474850005655 Radiation: 351474850009111/351474850049117
HW Version	DVT2
SW Version	SOV32.73
EUT Stage	Identical Prototype

1.4 Product Specification of Equipment Under Test

Standards-related Product Specification	
Tx Frequency	LTE Band 41 : 2535 MHz ~ 2655 MHz
Rx Frequency	LTE Band 41 : 2535 MHz ~ 2655 MHz
Bandwidth	LTE Band 41 : 5MHz / 10MHz / 15MHz / 20MHz
Maximum Output Power to Antenna	LTE Band 41 : 23.21 dBm
Antenna Type / Gain	Loop Antenna / LTE Band 41 : -0.37 dBi
Type of Modulation	QPSK / 16QAM / 64QAM

1.5 Modification of EUT

No modifications are made to the EUT during all test items.



1.6 Maximum EIRP and Emission Designator

LTE Band 41		QPSK		16QAM/64QAM	
BW (MHz)	Frequency Range (MHz)	Maximum EIRP(W)	Emission Designator (99%OBW)	Maximum EIRP(W)	Emission Designator (99%OBW)
20	2545.0 ~ 2645.0	0.1923	18M3G7D	0.1493	18M5W7D

Note: All modulations have been tested, only the maximum bandwidth and the worst test results of PSK & QAM are shown in the report.

1.7 Testing Location

Sporton International Inc. (Kunshan) is accredited to ISO/IEC 17025:2017 by American Association for Laboratory Accreditation with Certificate Number 5145.02.

Test Firm	Sporton International Inc. (Kunshan)		
Test Site Location	No. 1098, Pengxi North Road, Kunshan Economic Development Zone Jiangsu Province 215300 People's Republic of China TEL : +86-512-57900158 FAX : +86-512-57900958		
Test Site No.	Sporton Site No.	FCC Designation No.	FCC Test Firm Registration No.
	TH01-KS 03CH04-KS	CN1257	314309

1.8 Test Software

Item	Site	Manufacture	Name	Version
1.	03CH04-KS	AUDIX	E3	6.2009-8-24a



1.9 Applicable Standards

According to the specifications of the manufacturer, the EUT must comply with the requirements of the following standards:

- ♦ 47 CFR Part 2, 27(M)
- ♦ ANSI C63.26-2015
- ♦ FCC KDB 971168 D01 Power Meas License Digital Systems v03r01
- ♦ FCC KDB 412172 D01 Determining ERP and EIRP v01r01

Remark:

1. All test items were verified and recorded according to the standards and without any deviation during the test.
2. This EUT has also been tested and complied with the requirements of FCC Part 15, Subpart B, recorded in a separate test report.



1.10 Specification of Accessory

Specification of Accessory				
AC Adapter 1(US)	Brand Name	Motorola (Aohai)	Model Name	MC-101
AC Adapter 1(EU)	Brand Name	Motorola (Aohai)	Model Name	MC-102
AC Adapter 1(UK)	Brand Name	Motorola (Aohai)	Model Name	MC-103
AC Adapter 1(AU)	Brand Name	Motorola (Aohai)	Model Name	MC-105
AC Adapter 1(AR)	Brand Name	Motorola (Aohai)	Model Name	MC-106
AC Adapter 1(IN)	Brand Name	Motorola (Aohai)	Model Name	MC-104
AC Adapter 2(US)	Brand Name	Motorola (Chenyang)	Model Name	MC-101
AC Adapter 2(EU)	Brand Name	Motorola (Chenyang)	Model Name	MC-102
AC Adapter 2(UK)	Brand Name	Motorola (Chenyang)	Model Name	MC-103
AC Adapter 2(IN)	Brand Name	Motorola (Chenyang)	Model Name	MC-104
AC Adapter 2(AU)	Brand Name	Motorola (Chenyang)	Model Name	MC-105
AC Adapter 2(AR)	Brand Name	Motorola (Chenyang)	Model Name	MC-106
AC Adapter 2(PRC)	Brand Name	Motorola (Chenyang)	Model Name	MC-108
AC Adapter 3(US)	Brand Name	Motorola (Salcomp)	Model Name	MC-101
AC Adapter 3(EU)	Brand Name	Motorola (Salcomp)	Model Name	MC-102
AC Adapter 3(UK)	Brand Name	Motorola (Salcomp)	Model Name	MC-103
AC Adapter 3(AU)	Brand Name	Motorola (Salcomp)	Model Name	MC-105
AC Adapter 3(AR)	Brand Name	Motorola (Salcomp)	Model Name	MC-106
AC Adapter 3(PRC)	Brand Name	Motorola (Salcomp)	Model Name	MC-108
AC Adapter 3(Chile)	Brand Name	Motorola (Salcomp)	Model Name	MC-109
AC Adapter 4(EU)	Brand Name	Lenovo(Salcomp)	Model Name	MC-102
AC Adapter 5(UK)	Brand Name	Lenovo(Salcomp)	Model Name	MC-103
Battery 1	Brand Name	Motorola (ATL)	Model Name	NH40
Battery 2	Brand Name	Motorola (CosMX+SCUD)	Model Name	NH40
Earphone 1	Brand Name	Motorola(NEW LEADER)	Model Name	NLD-EM313A-23SF
Earphone 2	Brand Name	Motorola(Ju wei)	Model Name	JWEP1185-ZN01H
USB Cable 1	Brand Name	Motorola(Washin)	Model Name	HX-ZN-13
USB Cable 2	Brand Name	Motorola(Ju wei)	Model Name	JWUB1498-ZN01H



2 Test Configuration of Equipment Under Test

2.1 Test Mode

Antenna port conducted and radiated test items listed below are performed according to KDB 971168 D01 Power Meas License Digital Systems v03r01 with maximum output power.

Radiated measurements are performed by rotating the EUT in three different orthogonal test planes to find the maximum emission.

Test Items	Band	Bandwidth (MHz)						Modulation			RB #			Test Channel		
		1.4	3	5	10	15	20	QPSK	16QAM	64QAM	1	Half	Full	L	M	H
Max. Output Power	41	-	-	v	v	v	v	v	v	v	v	v	v	v	v	v
Peak-to-Average Ratio	41	-	-				v	v	v	v			v		v	
26dB and 99% Bandwidth	41	-	-				v	v	v				v		v	
Conducted Band Edge	41	-	-	v	v	v	v	v	v	v	v		v	v		v
Conducted Spurious Emission	41	-	-	v	v	v	v	v				v		v	v	v
Frequency Stability	41	-	-		v			v					v		v	
E.R.P / E.I.R.P	41	-	-	v	v	v	v	v	v	v	v	v	v	v	v	v
Radiated Spurious Emission	41	Worst Case												v		
Note	<ol style="list-style-type: none"> The mark "v" means that this configuration is chosen for testing The mark "-" means that this bandwidth is not supported. The device is investigated from 30MHz to 10 times of fundamental signal for radiated spurious emission test under different RB size/offset and modulations in exploratory test. Subsequently, only the worst case emissions are reported. 															

2.2 Connection Diagram of Test System

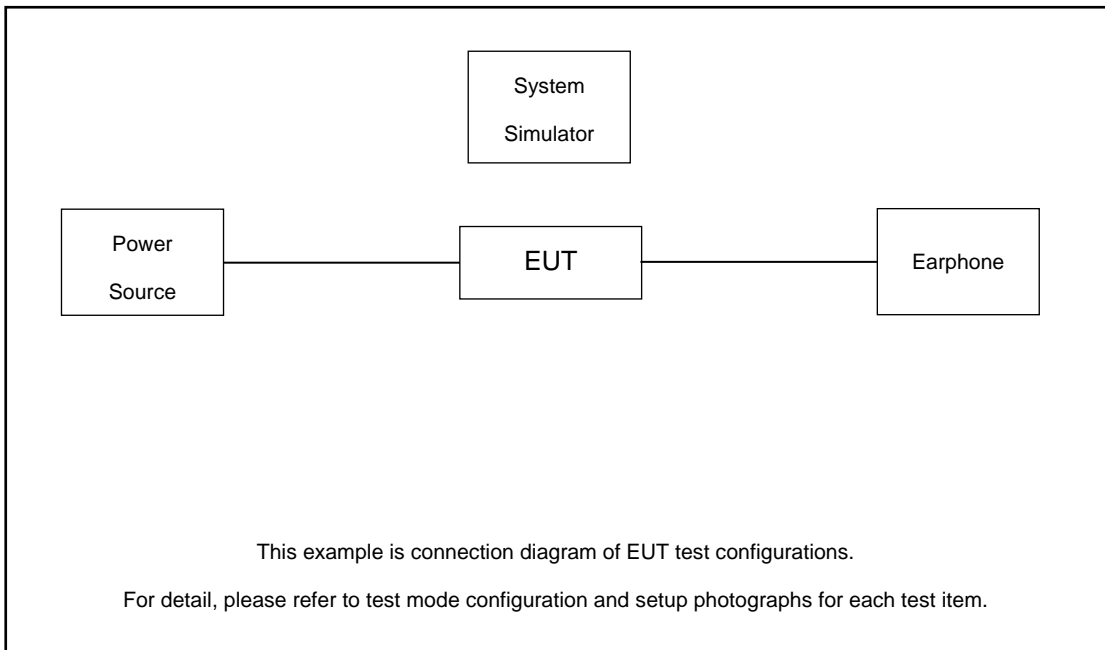

2.3 Support Unit used in test configuration and system

Item	Equipment	Trade Name	Model No.	FCC ID	Data Cable	Power Cord
1.	Power Supply	GWINSTEK	PSS-2002	N/A	N/A	Unshielded, 1.8 m
2.	LTE Base Station	Anritsu	MT8820C	N/A	N/A	Unshielded, 1.8 m

2.4 Measurement Results Explanation Example

For all conducted test items:

The offset level is set in the spectrum analyzer to compensate the RF cable loss between EUT conducted output port and spectrum analyzer. With the offset compensation, the spectrum analyzer reading level is exactly the EUT RF output level.

The spectrum analyzer offset is derived from RF cable loss.

Offset = RF cable loss.

Following shows an offset computation example with cable loss 6.0 dB.

Example :

$$\begin{aligned} \text{Offset(dB)} &= \text{RF cable loss(dB)} \\ &= 6.0 \text{ (dB)} \end{aligned}$$



2.5 Frequency List of Low/Middle/High Channels

LTE Band 41 Channel and Frequency List				
BW [MHz]	Channel/Frequency(MHz)	Lowest	Middle	Highest
20	Channel	40140	40640	41140
	Frequency	2545	2595	2645
15	Channel	40115	40640	41165
	Frequency	2542.5	2595	2647.5
10	Channel	40090	40640	41190
	Frequency	2540	2595	2650
5	Channel	40065	40640	41215
	Frequency	2537.5	2595	2652.5

3 Conducted Test Items

3.1 Measuring Instruments

See list of measuring instruments of this test report.

3.2 Test Setup

3.2.1 Conducted Output Power



3.2.2 Peak-to-Average Ratio, Occupied Bandwidth, Conducted Band-Edge and Conducted Spurious Emission

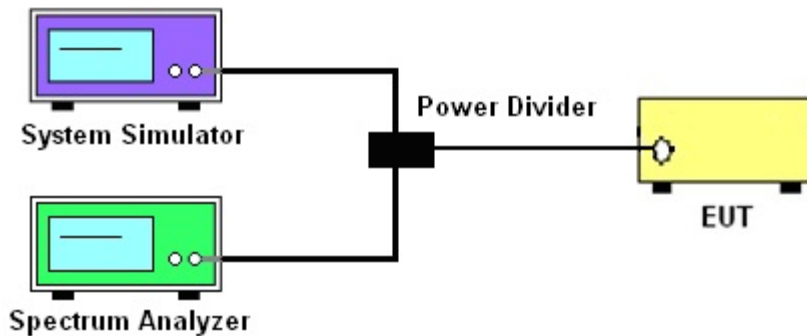

3.2.3 Frequency Stability

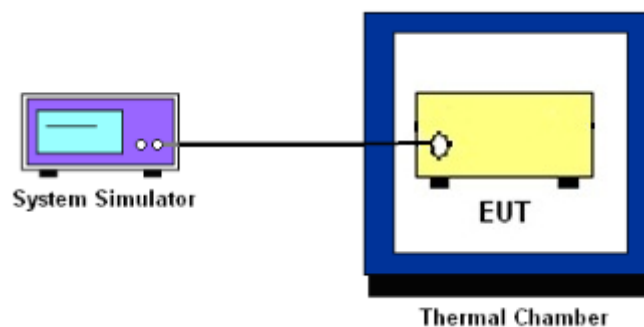

3.3 Test Result of Conducted Test

Please refer to Appendix A.



3.4 Conducted Output Power and EIRP

3.4.1 Description of the Conducted Output Power Measurement and EIRP Measurement

A system simulator was used to establish communication with the EUT. Its parameters were set to force the EUT transmitting at maximum output power. The measured power in the radio frequency on the transmitter output terminals shall be reported.

The EIRP of mobile transmitters must not exceed 2 Watts for LTE Band 41.

According to KDB 412172 D01 Power Approach,

$EIRP = P_T + G_T - L_C$, $ERP = EIRP - 2.15$, where

P_T = transmitter output power in dBm

G_T = gain of the transmitting antenna in dBi

L_C = signal attenuation in the connecting cable between the transmitter and antenna in dB

3.4.2 Test Procedures

1. The testing follows ANSI C63.26 Section 5.2
2. The transmitter output port was connected to the system simulator.
3. Set EUT at maximum power through the system simulator.
4. Select lowest, middle, and highest channels for each band and different modulation.
5. Measure and record the power level from the system simulator.



3.5 Peak-to-Average Ratio

3.5.1 Description of the PAR Measurement

Power Complementary Cumulative Distribution Function (CCDF) curves provide a means for characterizing the power peaks of a digitally modulated signal on a statistical basis. A CCDF curve depicts the probability of the peak signal amplitude exceeding the average power level. Most contemporary measurement instrumentation include the capability to produce CCDF curves for an input signal provided that the instrument's resolution bandwidth can be set wide enough to accommodate the entire input signal bandwidth. In measuring transmissions in this band using an average power technique, the peak-to-average ratio (PAR) of the transmission may not exceed 13 dB.

3.5.2 Test Procedures

1. The testing follows ANSI C63.26 Section 5.2.3.4 (CCDF).
2. The EUT was connected to spectrum and system simulator via a power divider.
3. Set the CCDF (Complementary Cumulative Distribution Function) option in spectrum analyzer.
4. The highest RF powers were measured and recorded the maximum PAPR level associated with a probability of 0.1 %.
5. Record the deviation as Peak to Average Ratio.



3.6 Occupied Bandwidth

3.6.1 Description of Occupied Bandwidth Measurement

The occupied bandwidth is the width of a frequency band such that, below the lower and above the upper frequency limits, the mean powers emitted are each equal to a specified percentage 0.5% of the total mean transmitted power.

The 26 dB emission bandwidth is defined as the frequency range between two points, one above and one below the carrier frequency, at which the spectral density of the emission is attenuated 26 dB below the maximum in-band spectral density of the modulated signal. Spectral density (power per unit bandwidth) is to be measured with a detector of resolution bandwidth equal to approximately 1.0% of the emission bandwidth.

3.6.2 Test Procedures

1. The testing follows ANSI C63.26 Section 5.4
2. The EUT was connected to spectrum analyzer and system simulator via a power divider.
3. The spectrum analyzer center frequency is set to the nominal EUT channel center frequency. The span range for the spectrum analyzer shall be between two and five times the anticipated OBW.
4. The nominal resolution bandwidth (RBW) shall be in the range of 1 to 5 % of the anticipated OBW, and the VBW shall be at least 3 times the RBW.
5. Set the detection mode to peak, and the trace mode to max hold.
6. Determine the reference value: Set the EUT to transmit a modulated signal. Allow the trace to stabilize. Set the spectrum analyzer marker to the highest level of the displayed trace.
(this is the reference value)
7. Determine the “-26 dB down amplitude” as equal to (Reference Value – X).
8. Place two markers, one at the lowest and the other at the highest frequency of the envelope of the spectral display such that each marker is at or slightly below the “-X dB down amplitude” determined in step 6. If a marker is below this “-X dB down amplitude” value it shall be placed as close as possible to this value. The OBW is the positive frequency difference between the two markers.
9. Use the 99 % power bandwidth function of the spectrum analyzer and report the measured bandwidth.



3.7 Conducted Band Edge

3.7.1 Description of Conducted Band Edge Measurement

27.53(m)(4)

For mobile digital stations, the attenuation factor shall be not less than $40 + 10 \log (P)$ dB on all frequencies between the channel edge and 5 megahertz from the channel edge, $43 + 10 \log (P)$ dB on all frequencies between 5 megahertz and X megahertz from the channel edge, and $55 + 10 \log (P)$ dB on all frequencies more than X megahertz from the channel edge, where X is the greater of 6 megahertz or the actual emission bandwidth as defined in paragraph (m)(6) of this section. In addition, the attenuation factor shall not be less that $43 + 10 \log (P)$ dB on all frequencies between 2490.5 MHz and 2496 MHz and $55 + 10 \log (P)$ dB at or below 2490.5 MHz. Mobile Satellite Service licensees operating on frequencies below 2495 MHz may also submit a documented interference complaint against BRS licensees operating on channel BRS Channel 1 on the same terms and conditions as adjacent channel BRS or EBS licensees.

3.7.2 Test Procedures

1. The testing follows ANSI C63.26 section 5.7
2. The EUT was connected to spectrum analyzer and system simulator via a power divider.
3. The band edges of low and high channels for the highest RF powers were measured.
4. Set RBW \geq 1% EBW in the 1MHz band immediately outside and adjacent to the band edge.
5. Beyond the 1 MHz band from the band edge, RBW=1MHz was used.
6. Set spectrum analyzer with RMS detector.
7. The RF fundamental frequency should be excluded against the limit line in the operating frequency band.
8. Checked that all the results comply with the emission limit line.

Example:

$$\begin{aligned} & \text{The limit line is derived from } 43 + 10\log(P)\text{dB below the transmitter power P(Watts)} \\ & = P(W) - [43 + 10\log(P)] \text{ (dB)} \\ & = [30 + 10\log(P)] \text{ (dBm)} - [43 + 10\log(P)] \text{ (dB)} = -13\text{dBm}. \end{aligned}$$

9. For LTE Band 41, the other 40 dB, and 55 dB have additionally applied same calculation above.
10. When using the integration method, the starting frequency of the integration shall be centered at one-half of the RBW away from the band edge.



3.8 Conducted Spurious Emission

3.8.1 Description of Conducted Spurious Emission Measurement

The power of any emission outside of the authorized operating frequency ranges must be lower than the transmitter power (P) by a factor of at least $43 + 10 \log (P)$ dB.

For Band 41:

The power of any emission outside of the authorized operating frequency ranges must be lower than the transmitter power (P) by a factor of at least $55 + 10 \log (P)$ dB.

It is measured by means of a calibrated spectrum analyzer and scanned from 30 MHz up to a frequency including its 10th harmonic.

3.8.2 Test Procedures

1. The testing follows ANSI C63.26 section 5.7
2. The EUT was connected to spectrum analyzer and system simulator via a power divider.
3. The RF output of EUT was connected to the spectrum analyzer by RF cable and attenuator. The path loss was compensated to the results for each measurement.
4. The middle channel for the highest RF power within the transmitting frequency was measured.
5. The conducted spurious emission for the whole frequency range was taken.
6. Make the measurement with the spectrum analyzer's RBW = 1MHz, VBW = 3MHz.
7. Set spectrum analyzer with RMS detector.
8. Taking the record of maximum spurious emission.
9. The RF fundamental frequency should be excluded against the limit line in the operating frequency band.
10. The limit line is derived from $43 + 10\log(P)$ dB below the transmitter power P(Watts)
 $= P(W) - [43 + 10\log(P)]$ (dB)
 $= [30 + 10\log(P)]$ (dBm) - $[43 + 10\log(P)]$ (dB)
 $= -13$ dBm.
11. For Band 41:
The limit line is derived from $55 + 10\log(P)$ dB below the transmitter power P(Watts)
 $= P(W) - [55 + 10\log(P)]$ (dB)
 $= [30 + 10\log(P)]$ (dBm) - $[55 + 10\log(P)]$ (dB)
 $= -25$ dBm.



3.9 Frequency Stability

3.9.1 Description of Frequency Stability Measurement

The frequency stability shall be measured by variation of ambient temperature and variation of primary supply voltage to ensure that the fundamental emission stays within the authorized frequency block. The frequency stability of the transmitter shall be maintained within $\pm 0.00025\%$ ($\pm 2.5\text{ppm}$) of the center frequency.

3.9.2 Test Procedures for Temperature Variation

1. The testing follows ANSI C63.26 section 5.6.4
2. The EUT was set up in the thermal chamber and connected with the system simulator.
3. With power OFF, the temperature was decreased to -30°C and the EUT was stabilized before testing. Power was applied and the maximum change in frequency was recorded within one minute.
4. With power OFF, the temperature was raised in 10°C step up to 50°C . The EUT was stabilized at each step for at least half an hour. Power was applied and the maximum frequency change was recorded within one minute.

3.9.3 Test Procedures for Voltage Variation

1. The testing follows ANSI C63.26 section 5.6.5
2. The EUT was placed in a temperature chamber at $20\pm 5^{\circ}\text{C}$ and connected with the system simulator.
3. The power supply voltage to the EUT was varied from 85% to 115% of the nominal value for other than hand carried battery equipment.
4. For hand carried, battery powered equipment, reduce the primary ac or dc supply voltage to the battery operating end point, which shall be specified by the manufacturer.
5. The variation in frequency was measured for the worst case.

4 Radiated Test Items

4.1 Measuring Instruments

See list of measuring instruments of this test report.

4.2 Test Setup

4.2.1 For radiated test below 30MHz

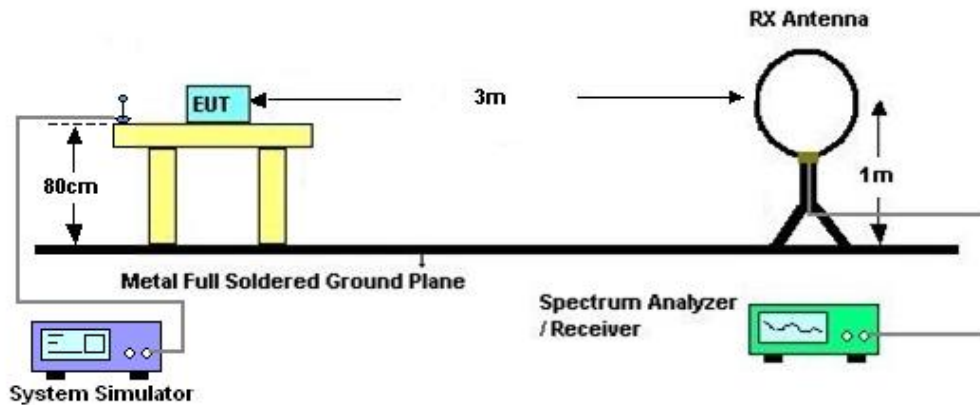

4.2.2 For radiated test from 30MHz to 1GHz

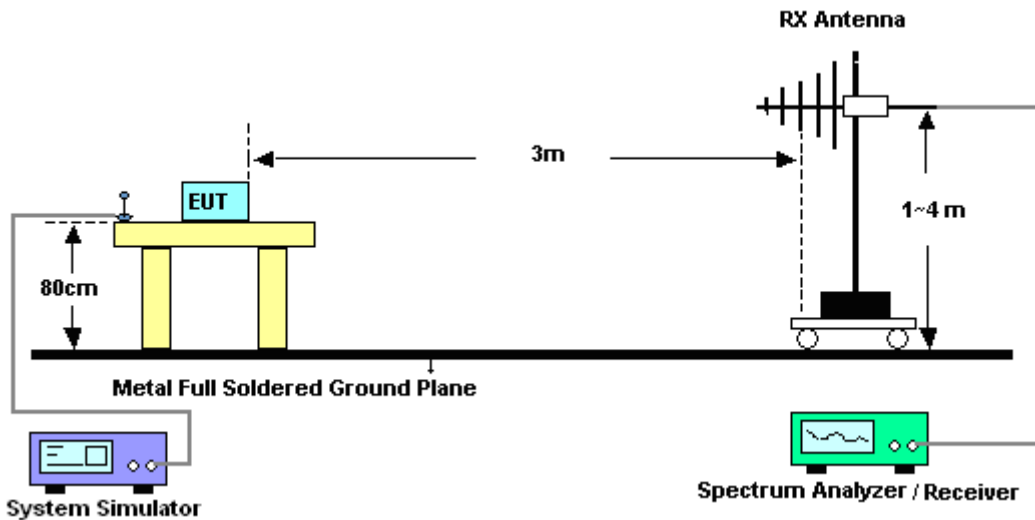

4.2.3 For radiated test above 1GHz

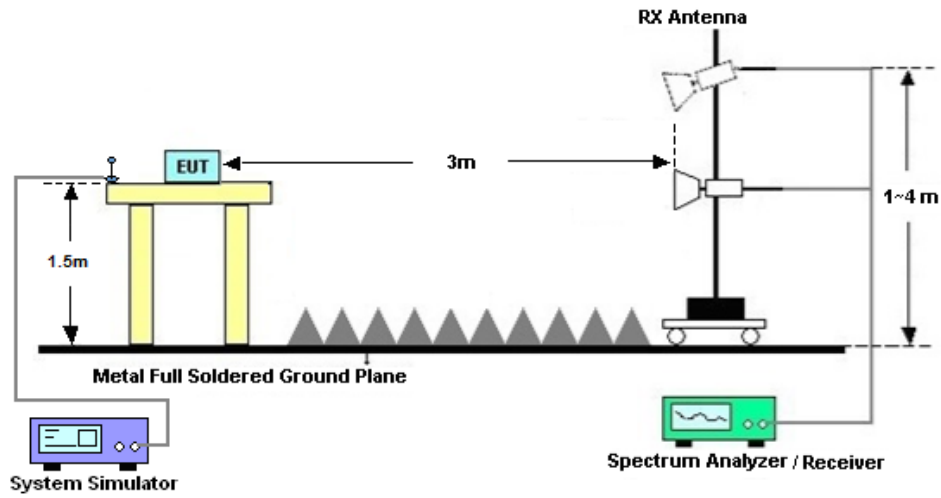

4.3 Test Result of Radiated Test

The low frequency, which started from 9 kHz to 30MHz, was pre-scanned and the result which was 20dB lower than the limit line was not reported.

Please refer to Appendix B.



4.4 Radiated Spurious Emission

4.4.1 Description of Radiated Spurious Emission

The radiated spurious emission was measured by substitution method according to ANSI C63.26. The power of any emission outside of the authorized operating frequency ranges must be attenuated below the transmitter power (P) by a factor of at least $43 + 10 \log (P)$ dB.

For Band 7

The power of any emission outside of the authorized operating frequency ranges must be attenuated below the transmitter power (P) by a factor of at least $55 + 10 \log (P)$ dB.

The spectrum is scanned from 30 MHz up to a frequency including its 10th harmonic.

4.4.2 Test Procedures

1. The testing follows ANSI C63.26 Section 5.5
2. The EUT was placed on a turntable with 0.8 meter height for frequency below 1GHz and 1.5 meter height for frequency above 1GHz respectively above ground.
3. The EUT was set 3 meters from the receiving antenna mounted on the antenna tower.
4. The table was rotated 360 degrees to determine the position of the highest spurious emission.
5. The height of the receiving antenna is varied between 1m to 4m to search the maximum spurious emission for both horizontal and vertical polarizations.
6. During the measurement, the system simulator parameters were set to force the EUT transmitting at maximum output power.
7. Make the measurement with the spectrum analyzer's RBW = 1MHz, VBW = 3MHz, taking the record of maximum spurious emission.
8. A horn antenna was substituted in place of the EUT and was driven by a signal generator.
9. Tune the output power of signal generator to the same emission level with EUT maximum spurious emission.
10. $EIRP (dBm) = S.G. Power - Tx Cable Loss + Tx Antenna Gain$
11. $ERP (dBm) = EIRP - 2.15$
12. The RF fundamental frequency should be excluded against the limit line in the operating frequency band.

The limit line is derived from $43 + 10\log(P)$ dB below the transmitter power P(Watts)
 $= P(W) - [43 + 10\log(P)] (dB)$
 $= [30 + 10\log(P)] (dBm) - [43 + 10\log(P)] (dB)$
 $= -13dBm.$

13. For Band 41:

The limit line is derived from $55 + 10\log(P)$ dB below the transmitter power P(Watts)



5 List of Measuring Equipment

Instrument	Manufacturer	Model No.	Serial No.	Characteristics	Calibration Date	Test Date	Due Date	Remark
Spectrum Analyzer	R&S	FSV40	101040	10Hz~40GHz	Oct. 14, 2021	Jun. 22, 2022~ Jun. 29, 2022	Oct. 13, 2022	Conducted (TH01-KS)
Power divider	STI	STI08-0055	-	0.5~40GHz	Aug. 26, 2021	Jun. 22, 2022~ Jun. 29, 2022	Aug. 25, 2022	Conducted (TH01-KS)
Temperature & humidity chamber	Hongzhan	LP-150U	H2014011440	-40~+150°C 20%~95%RH	Jul. 12, 2021	Jun. 22, 2022~ Jun. 29, 2022	Jul. 11, 2022	Conducted (TH01-KS)
EXA Spectrum Analyzer	Keysight	N9010B	MY57541079	10Hz~44G,MAX 30dB	Oct. 15, 2021	Jun. 29, 2022	Oct. 14, 2022	Radiation (03CH04-KS)
Loop Antenna	R&S	HFH2-Z2	100321	9kHz~30MHz	Oct. 30, 2021	Jun. 29, 2022	Oct. 29, 2022	Radiation (03CH04-KS)
Bilog Antenna	TeseQ	CBL6111D	49922	30MHz~1GHz	May 24, 2022	Jun. 29, 2022	May 23, 2023	Radiation (03CH04-KS)
Horn Antenna	Schwarzbeck	BBHA9120D	1284	1GHz~18GHz	Jan. 05, 2022	Jun. 29, 2022	Jan. 04, 2023	Radiation (03CH04-KS)
SHF-EHF Horn	Com-power	AH-840	101070	18GHz~40GHz	Jan. 05, 2022	Jun. 29, 2022	Jan. 04, 2023	Radiation (03CH04-KS)
Amplifier	SONOMA	310N	187289	9KHz-1GHz	Jan. 05, 2022	Jun. 29, 2022	Jan. 04, 2023	Radiation (03CH04-KS)
Amplifier	MITEQ	EM18G40G GA	060728	18~40GHz	Jan. 05, 2022	Jun. 29, 2022	Jan. 04, 2023	Radiation (03CH04-KS)
high gain Amplifier	EM	EM01G18G A	060839	1Ghz-18Ghz	Oct. 14, 2021	Jun. 29, 2022	Oct. 13, 2022	Radiation (03CH04-KS)
Amplifier	Keysight	83017A	MY57280106	500MHz~26.5GHz	Oct. 13, 2021	Jun. 29, 2022	Oct. 12, 2022	Radiation (03CH04-KS)
AC Power Source	Chroma	61601	F104090004	N/A	NCR	Jun. 29, 2022	NCR	Radiation (03CH04-KS)
Turn Table	ChamPro	EM 1000-T	060762-T	0~360 degree	NCR	Jun. 29, 2022	NCR	Radiation (03CH04-KS)
Antenna Mast	ChamPro	EM 1000-A	060762-A	1 m~4 m	NCR	Jun. 29, 2022	NCR	Radiation (03CH04-KS)

NCR: No Calibration Required



6 Uncertainty of Evaluation

The measurement uncertainties shown below were calculated in accordance with the requirements of ANSI 63.26-2015. All the measurement uncertainty value were shown with a coverage K=2 to indicate 95% level of confidence. The measurement data show herein meets or exceeds the CISPR measurement uncertainty values specified in CISPR 16-4-2 and can be compared directly to specified limit to determine compliance.

Uncertainty of Conducted Measurement

Test Item	Uncertainty
Conducted Power	0.56 dB
Conducted Emissions	0.92 dB
Occupied Channel Bandwidth	0.03 %
Conducted Power Spectral Density	0.54 dB
Conducted emission	0.92
Frequency tolerance	0.414ppm

Uncertainty of Radiated Emission Measurement (30 MHz ~ 1000 MHz)

Measuring Uncertainty for a Level of Confidence of 95% (U = 2Uc(y))	3.3dB
---	-------

Uncertainty of Radiated Emission Measurement (1 GHz ~ 18 GHz)

Measuring Uncertainty for a Level of Confidence of 95% (U = 2Uc(y))	2.8dB
---	-------

Uncertainty of Radiated Emission Measurement (18 GHz ~ 40 GHz)

Measuring Uncertainty for a Level of Confidence of 95% (U = 2Uc(y))	2.8dB
---	-------



Appendix A. Test Results of Conducted Test

Test Engineer :	Simle Wang	Temperature :	22~23°C
		Relative Humidity :	40~42%

Conducted Output Power(Average power) and EIRP

LTE Band 41:

BW [MHz]	Modulation	RB Size	RB Offset	Power Low Ch. / Freq.	Power Middle Low Ch. / Freq.	Power High Ch. / Freq.	EIRP(W)		
Channel				40140	40640	41140	EIRP(W)		
Frequency (MHz)				2545	2595	2645	L	M	H
20	QPSK	1	0	23.14	23.21	23.10	0.1892	0.1923	0.1875
20	QPSK	1	99	22.98	22.94	22.95	0.1824	0.1807	0.1811
20	QPSK	100	0	22.00	22.08	22.04	0.1455	0.1483	0.1469
20	16QAM	1	0	22.08	22.11	22.05	0.1483	0.1493	0.1472
20	64QAM	1	0	20.94	20.96	20.76	0.1140	0.1146	0.1094
Channel				40115	40640	41165	EIRP(W)		
Frequency (MHz)				2542.5	2595	2647.5	L	M	H
15	QPSK	1	0	23.01	23.07	23.08	0.1837	0.1862	0.1866
15	16QAM	1	0	21.97	21.90	21.88	0.1445	0.1422	0.1416
Channel				40090	40640	41190	EIRP(W)		
Frequency (MHz)				2540	2595	2650	L	M	H
10	QPSK	1	0	23.02	23.17	22.88	0.1841	0.1905	0.1782
10	16QAM	1	0	22.04	21.96	22.06	0.1469	0.1442	0.1476
Channel				40065	40640	41215	EIRP(W)		
Frequency (MHz)				2537.5	2595	2652.5	L	M	H
5	QPSK	1	0	22.98	23.20	22.99	0.1824	0.1919	0.1828
5	16QAM	1	0	21.76	22.02	21.94	0.1377	0.1462	0.1435



LTE Band 41

Peak-to-Average Ratio

Mode	LTE Band 41 / 20MHz			
Mod.	QPSK	16QAM	64QAM	Limit: 13dB
RB Size	Full RB	Full RB	Full RB	Result
Middle CH	5.86	6.41	7.13	PASS

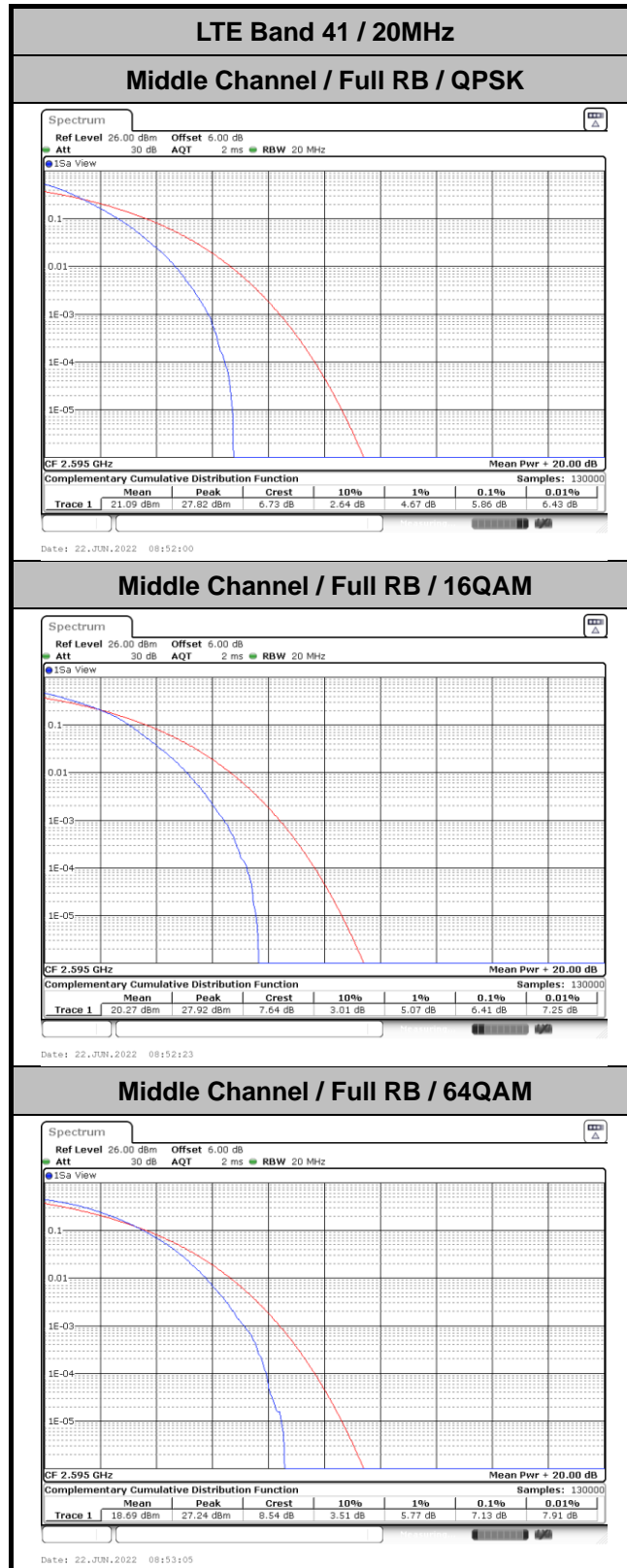



26dB Bandwidth

Mode	LTE Band 41 : 26dB BW(MHz)	
BW	20MHz	
Mod.	QPSK	16QAM
Middle CH	20.18	20.06

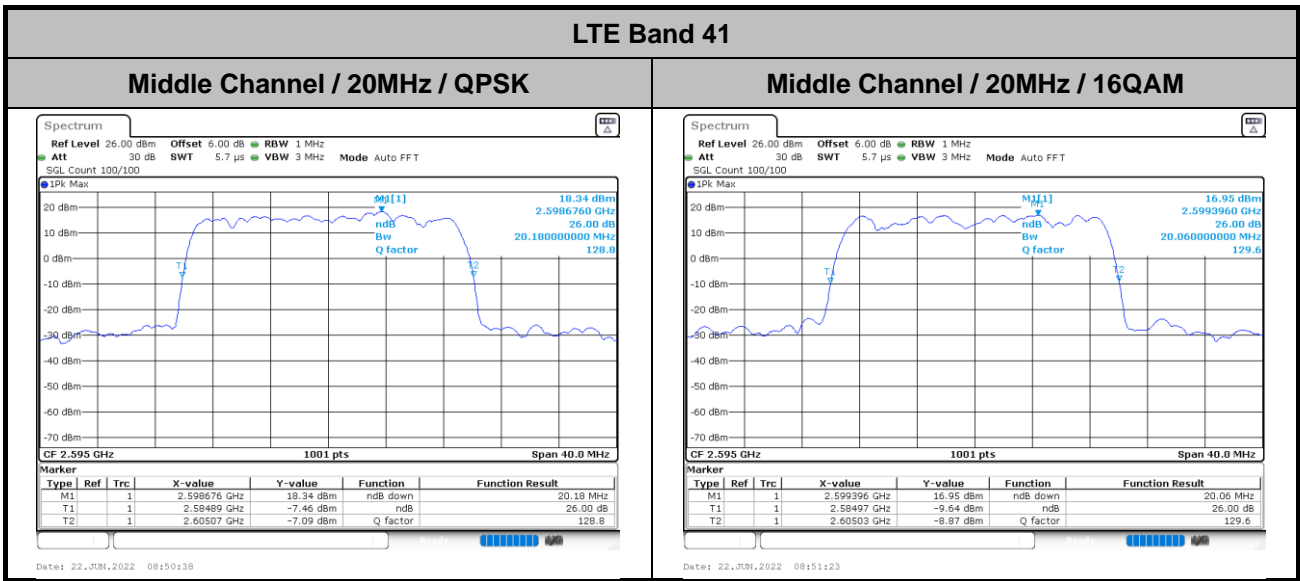



Occupied Bandwidth

Mode	LTE Band 41 : 99%OBW(MHz)	
BW	20MHz	
Mod.	QPSK	16QAM
Middle CH	18.30	18.50

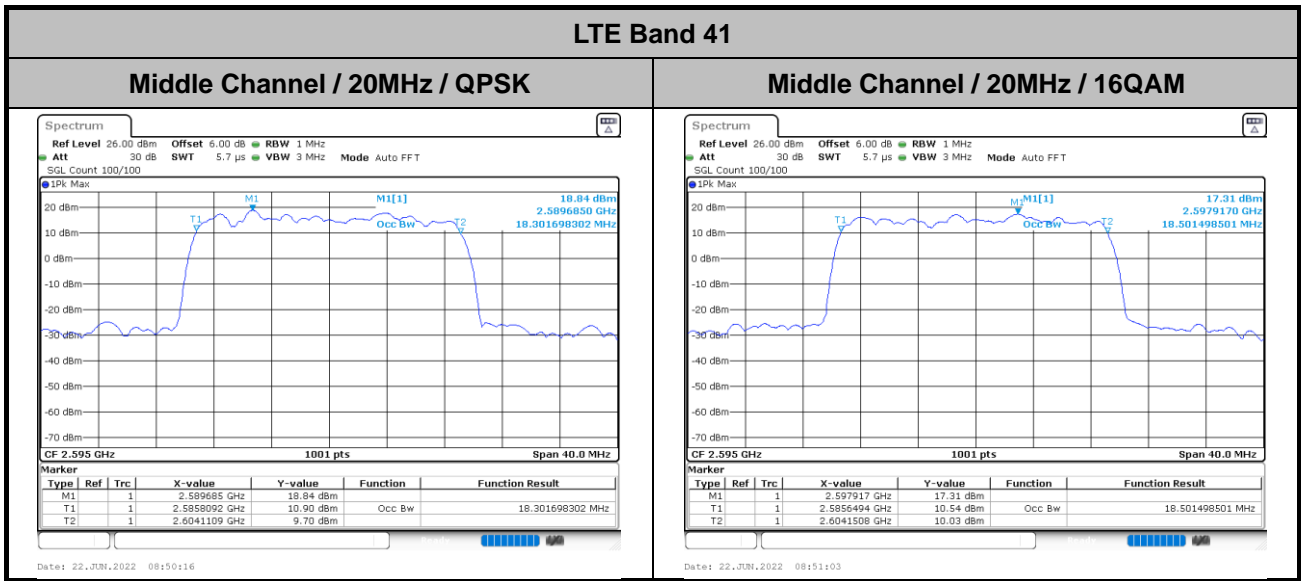



Conducted Band Edge

LTE Band 41 / 5MHz / QPSK

Lowest Band Edge / 1 RB

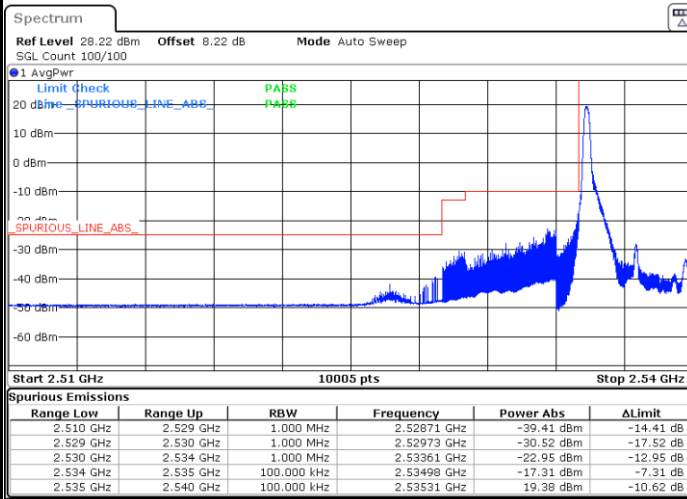

Date: 22 JUN 2022 07:44:07

Highest Band Edge / 1 RB

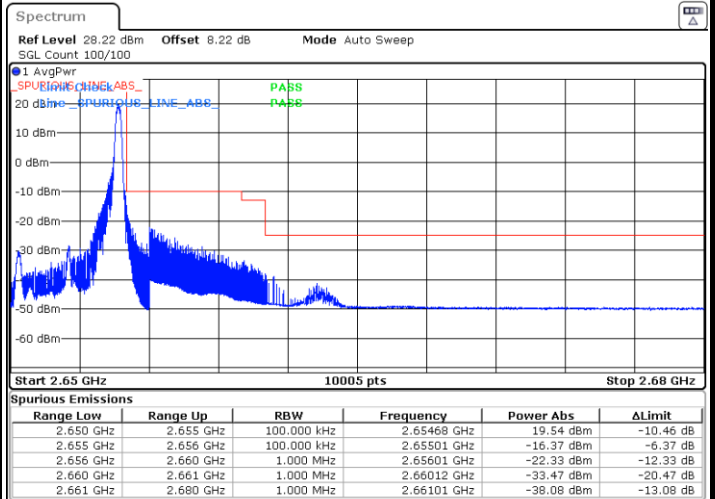

Date: 22 JUN 2022 07:53:32

Lowest Band Edge / Full RB

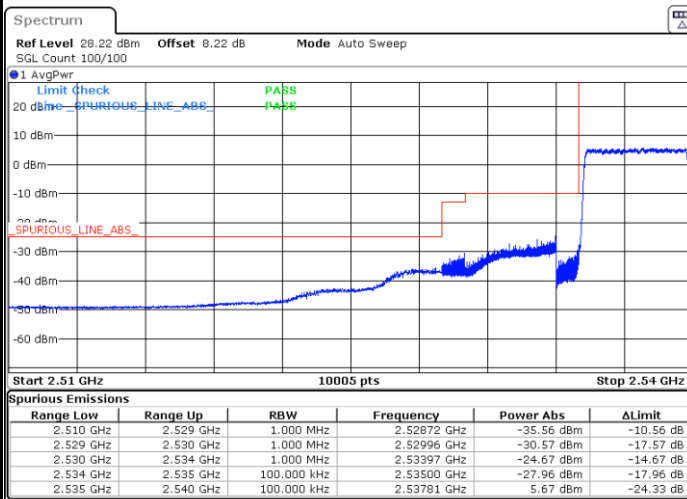

Date: 22 JUN 2022 07:49:24

Highest Band Edge / Full RB

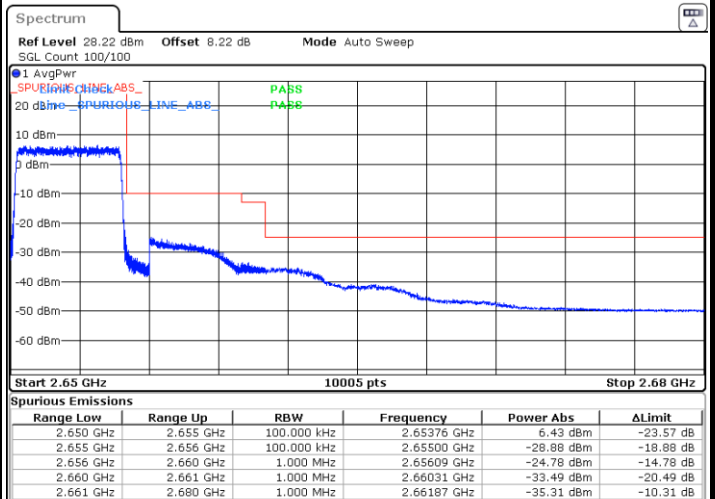

Date: 22 JUN 2022 07:50:04



LTE Band 41 / 5MHz / 16QAM

Lowest Band Edge / 1RB

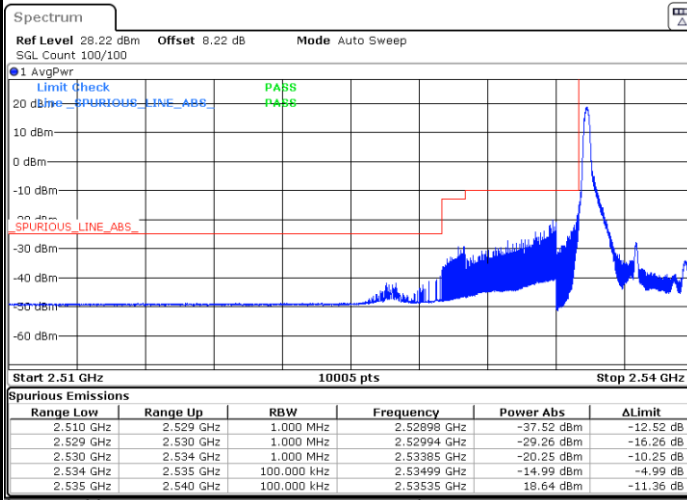

Date: 22 JUN 2022 07:45:34

Highest Band Edge / 1 RB

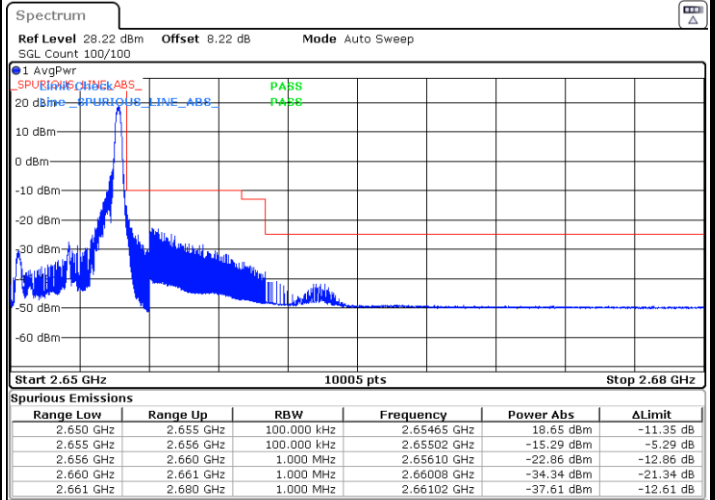

Date: 22 JUN 2022 07:52:57

Lowest Band Edge / Full RB

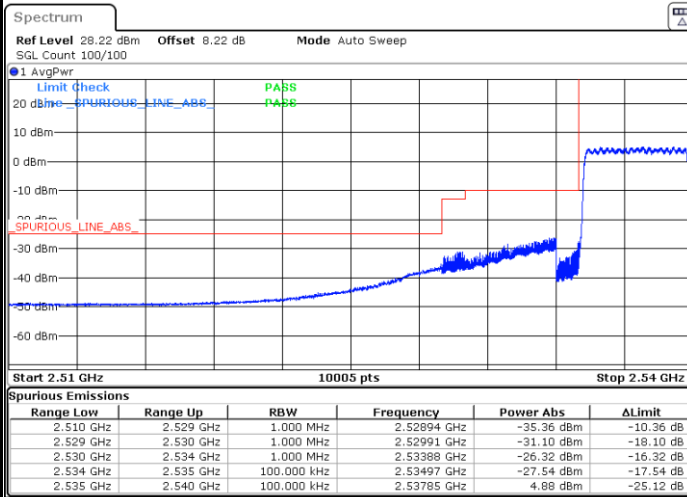

Date: 22 JUN 2022 07:48:29

Highest Band Edge / Full RB

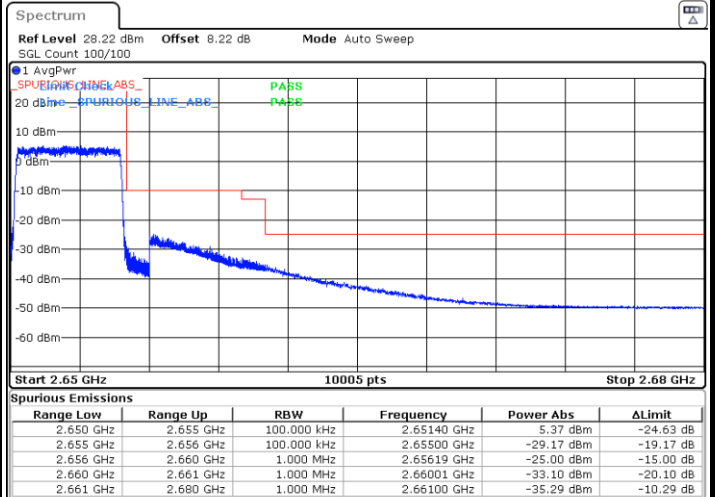

Date: 22 JUN 2022 07:50:41



LTE Band 41 / 5MHz / 64QAM

Lowest Band Edge / 1RB

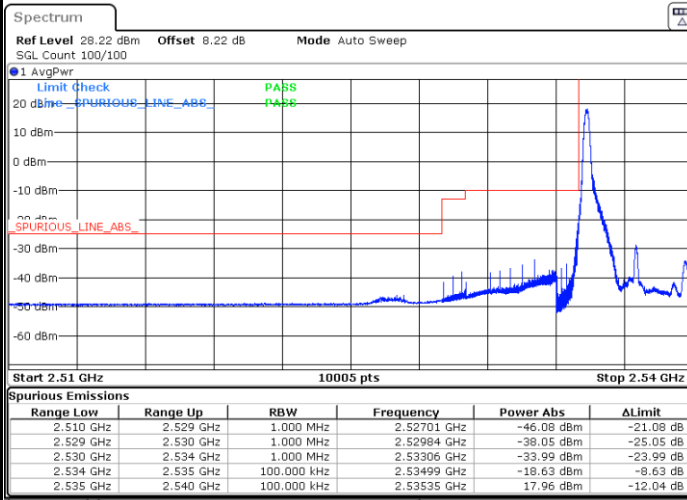

Date: 22 JUN.2022 07:46:19

Highest Band Edge / 1 RB

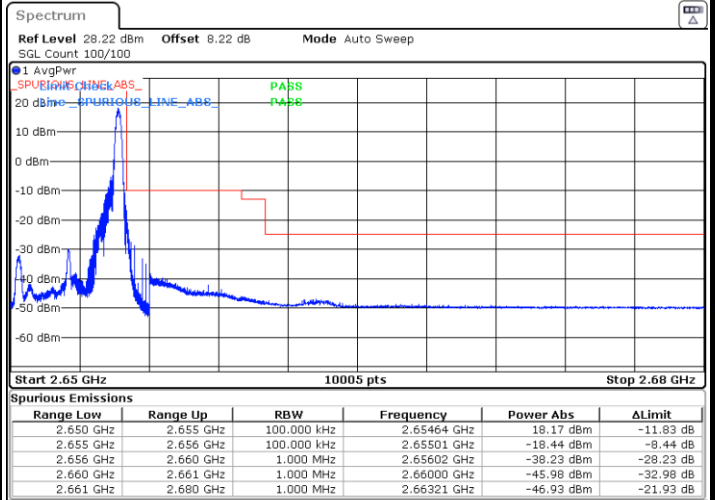

Date: 22 JUN.2022 07:52:21

Lowest Band Edge / Full RB

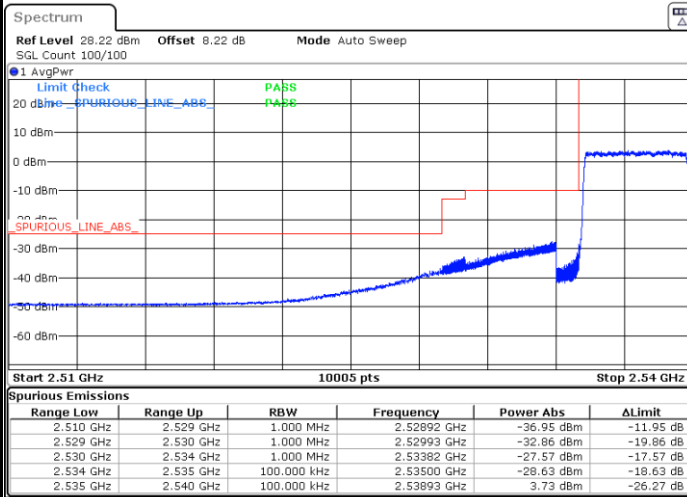

Date: 22 JUN.2022 07:47:40

Highest Band Edge / Full RB

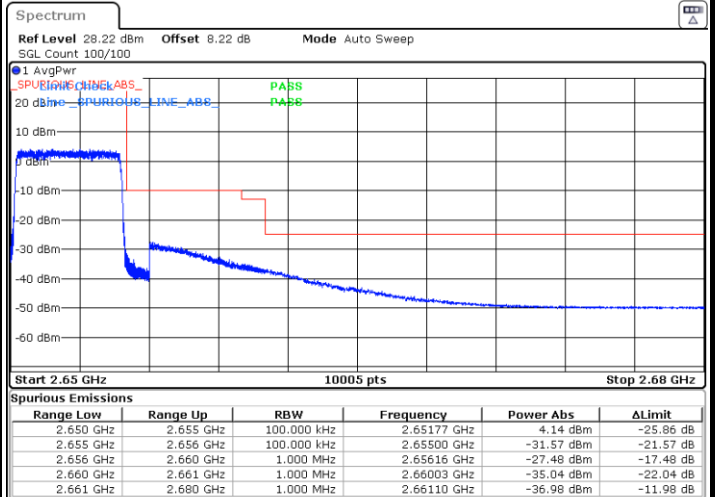

Date: 22 JUN.2022 07:51:19



LTE Band 41 / 10MHz / QPSK

Lowest Band Edge / 1 RB

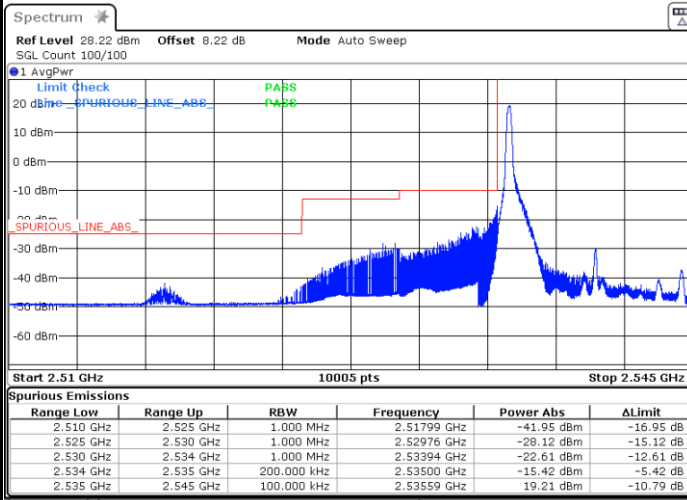

Date: 22 JUN.2022 07:56:14

Highest Band Edge / 1 RB

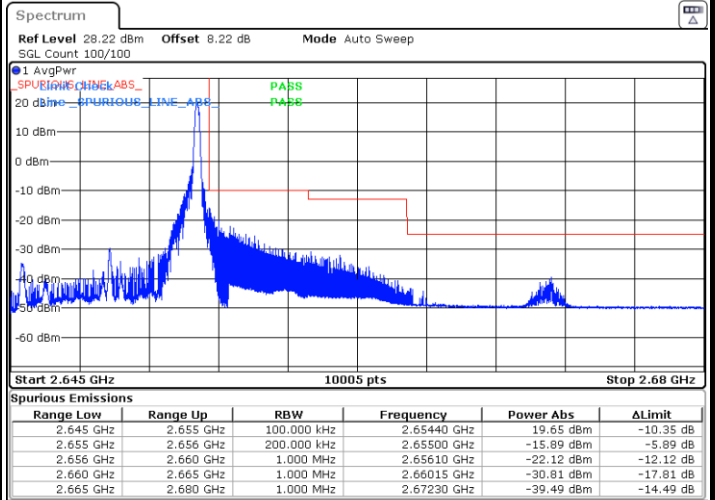

Date: 22 JUN.2022 08:05:34

Lowest Band Edge / Full RB

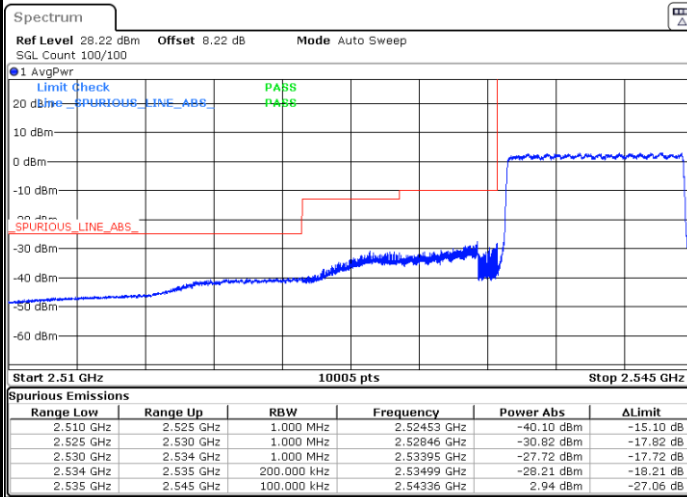

Date: 22 JUN.2022 08:01:03

Highest Band Edge / Full RB

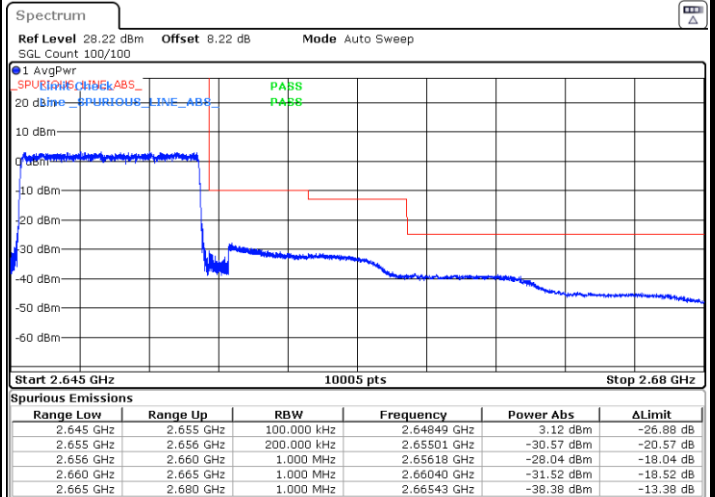

Date: 22 JUN.2022 08:01:48



LTE Band 41 / 10MHz / 16QAM

Lowest Band Edge / 1 RB

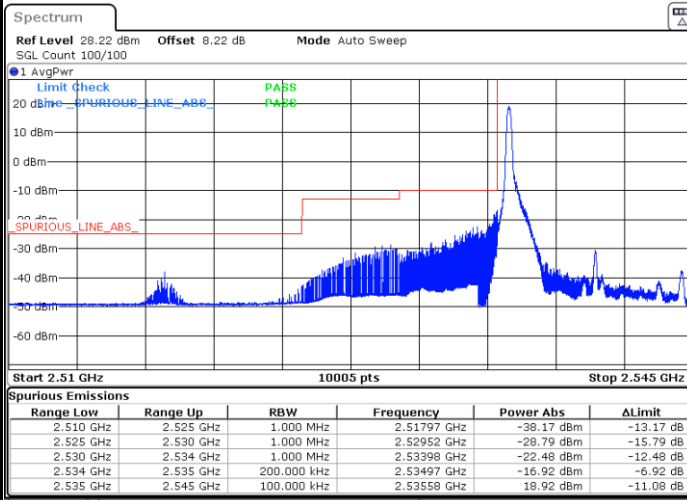

Date: 22 JUN.2022 07:57:27

Highest Band Edge / 1 RB

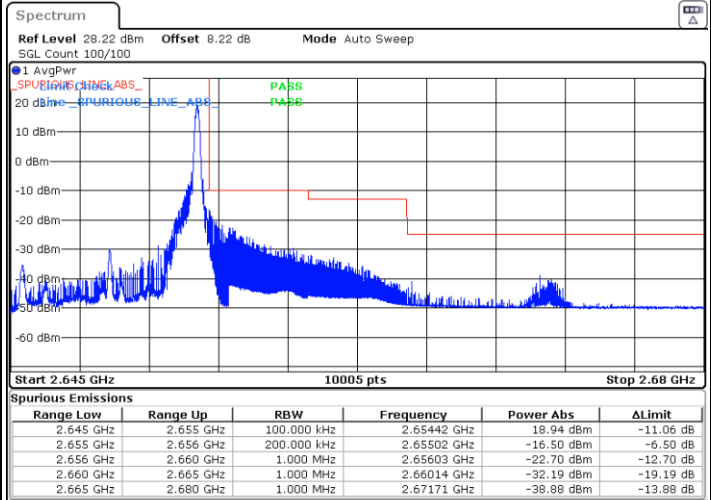

Date: 22 JUN.2022 08:04:29

Lowest Band Edge / Full RB

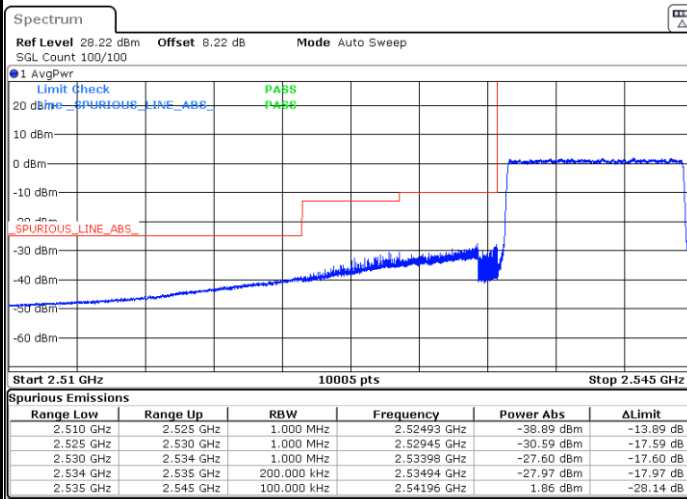

Date: 22 JUN.2022 08:00:19

Highest Band Edge / Full RB

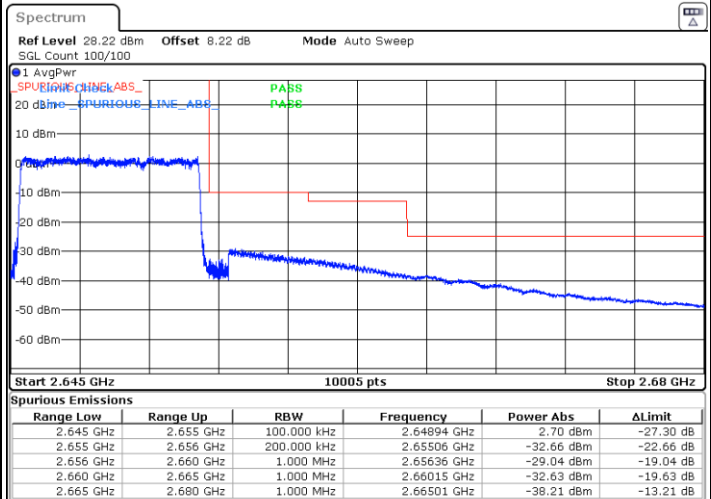

Date: 22 JUN.2022 08:02:39



LTE Band 41 / 10MHz / 64QAM

Lowest Band Edge / 1 RB

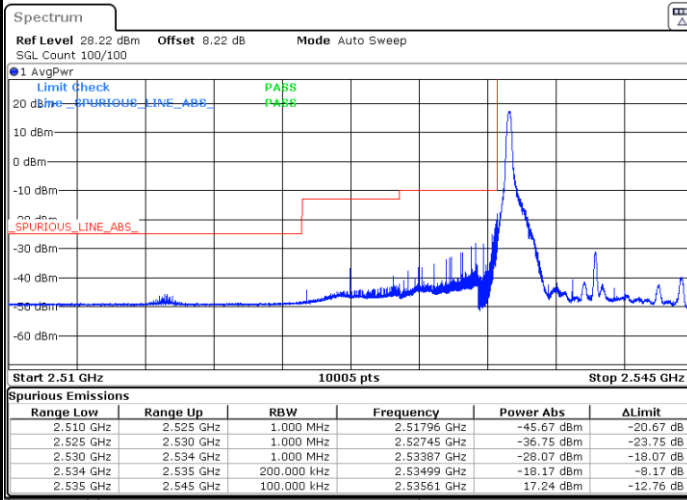

Date: 22 JUN.2022 07:58:24

Highest Band Edge / 1 RB

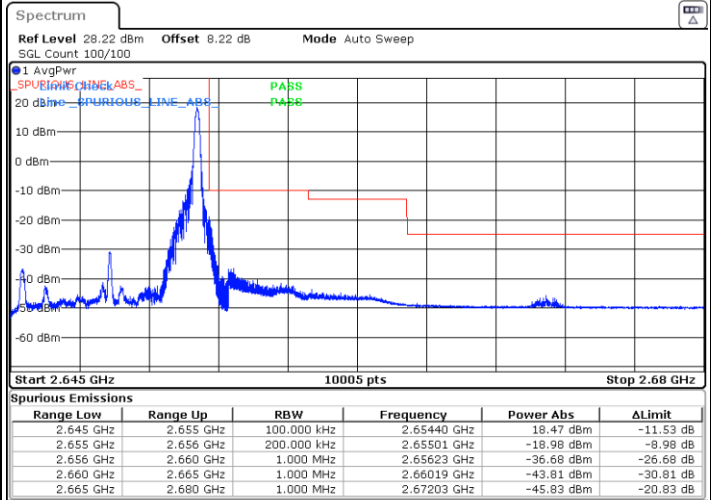

Date: 22 JUN.2022 08:03:53

Lowest Band Edge / Full RB

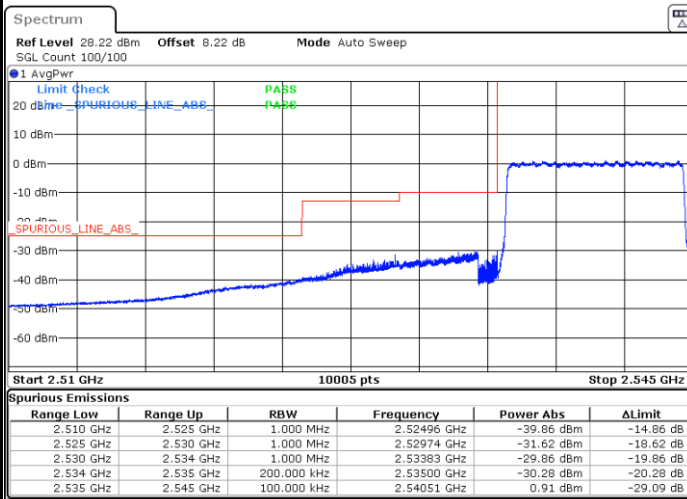

Date: 22 JUN.2022 07:59:13

Highest Band Edge / Full RB

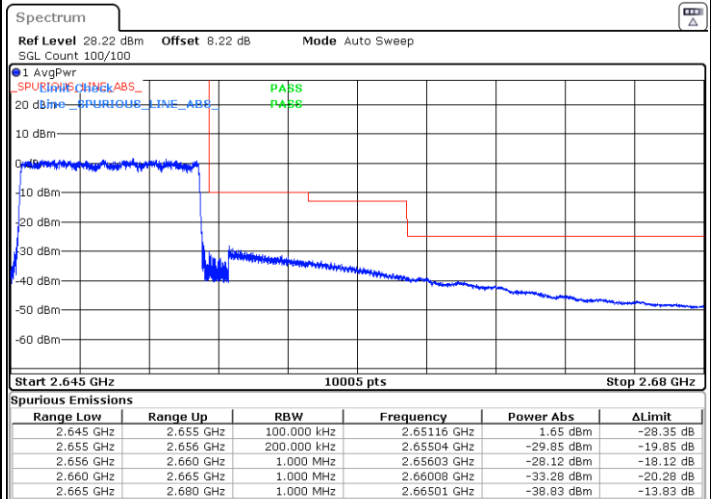

Date: 22 JUN.2022 08:03:15



LTE Band 41 / 15MHz / QPSK

Lowest Band Edge / 1 RB

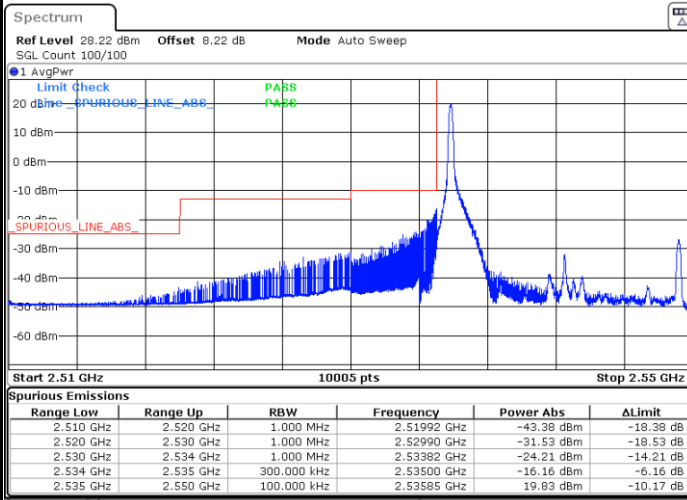

Date: 22 JUN 2022 08:06:28

Highest Band Edge / 1 RB

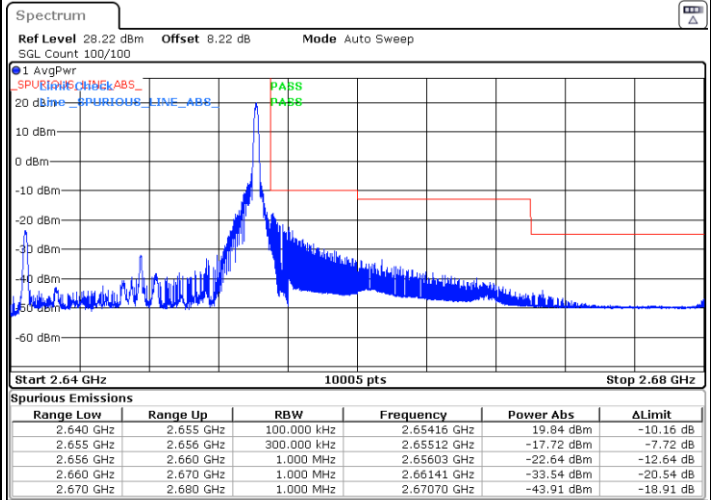

Date: 22 JUN 2022 08:14:56

Lowest Band Edge / Full RB

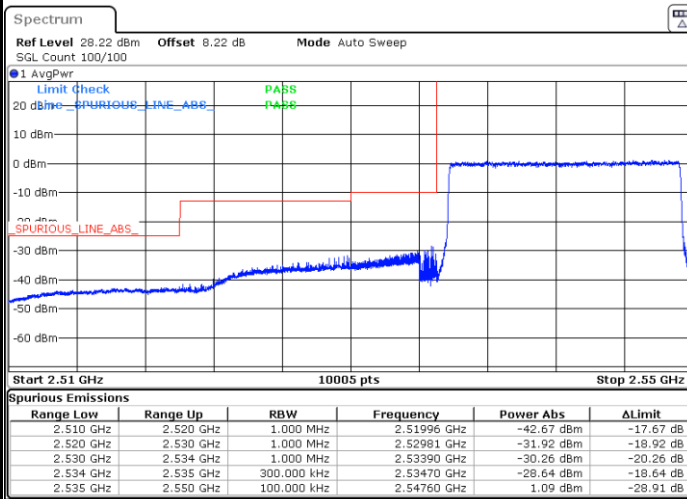

Date: 22 JUN 2022 08:10:41

Highest Band Edge / Full RB

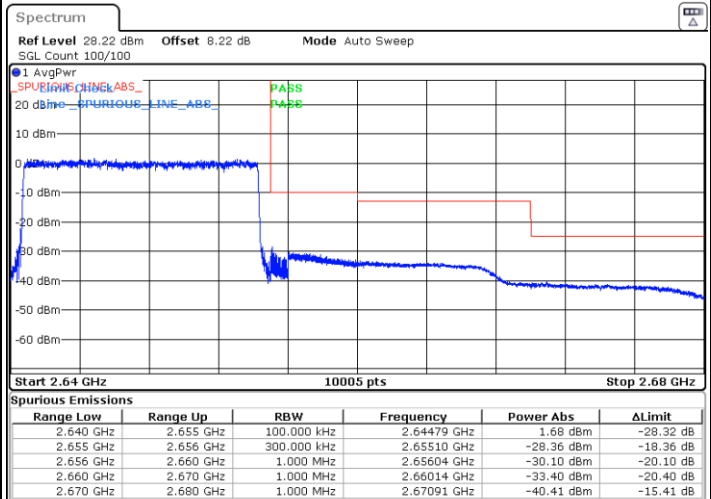

Date: 22 JUN 2022 08:11:27



LTE Band 41 / 15MHz / 16QAM

Lowest Band Edge / 1 RB

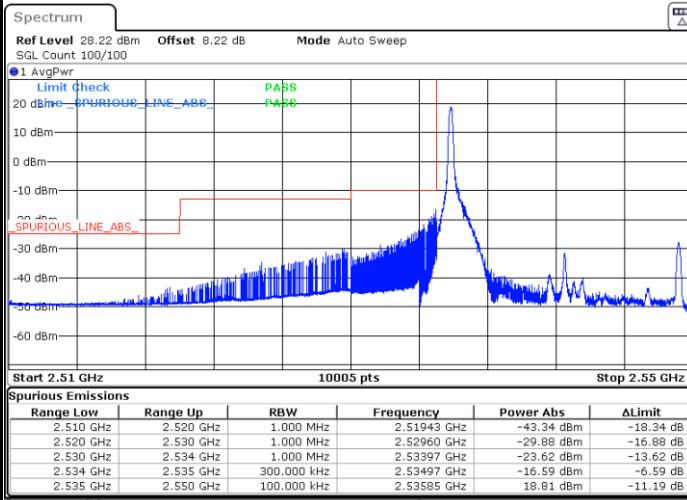

Date: 22 JUN 2022 08:07:13

Highest Band Edge / 1 RB

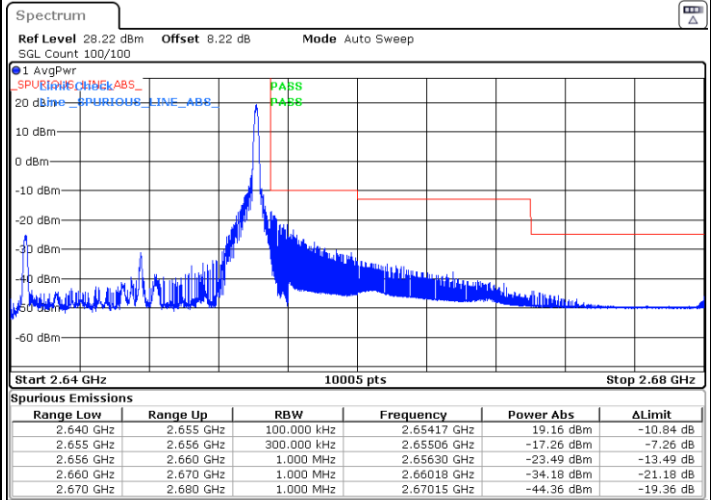

Date: 22 JUN 2022 08:14:22

Lowest Band Edge / Full RB

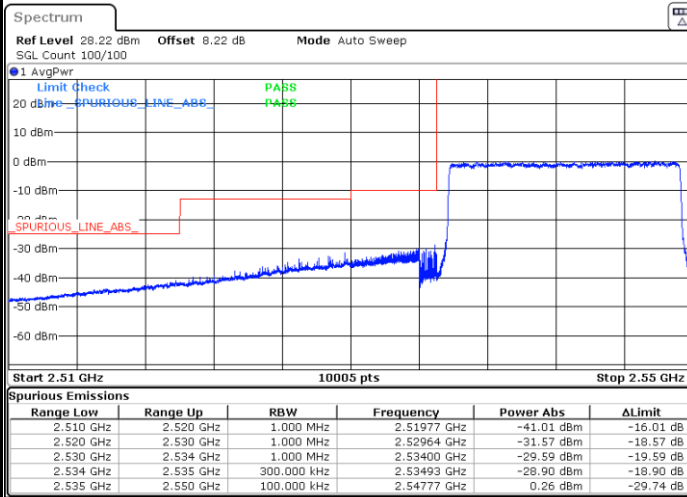

Date: 22 JUN 2022 08:10:01

Highest Band Edge / Full RB

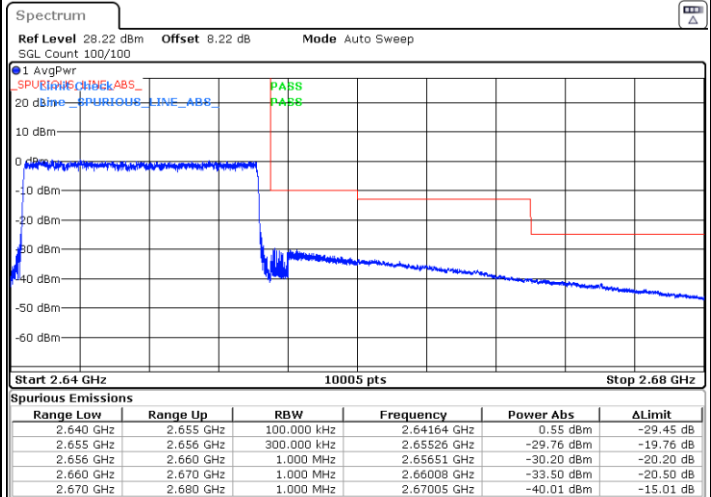

Date: 22 JUN 2022 08:12:05



LTE Band 41 / 15MHz / 64QAM

Lowest Band Edge / 1 RB

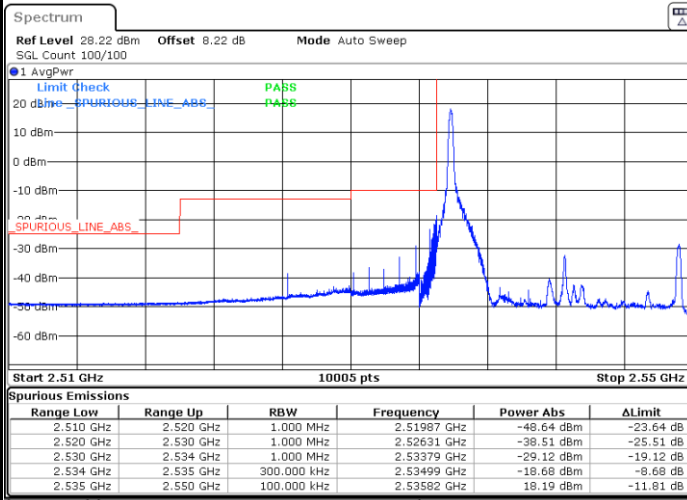

Date: 22 JUN 2022 08:08:16

Highest Band Edge / 1 RB

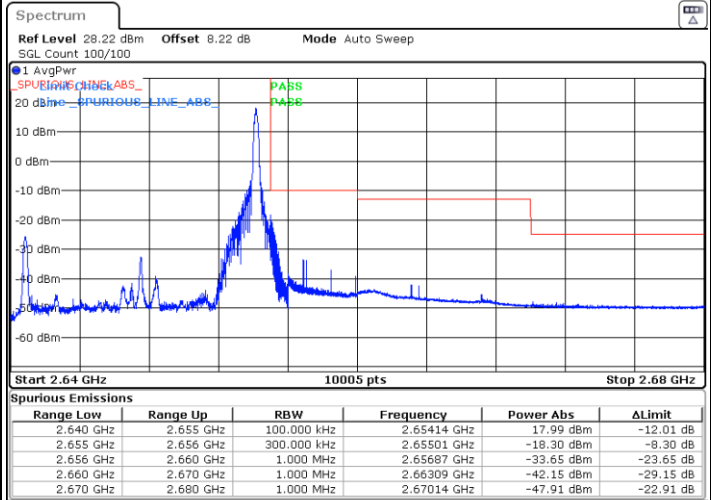

Date: 22 JUN 2022 08:13:43

Lowest Band Edge / Full RB

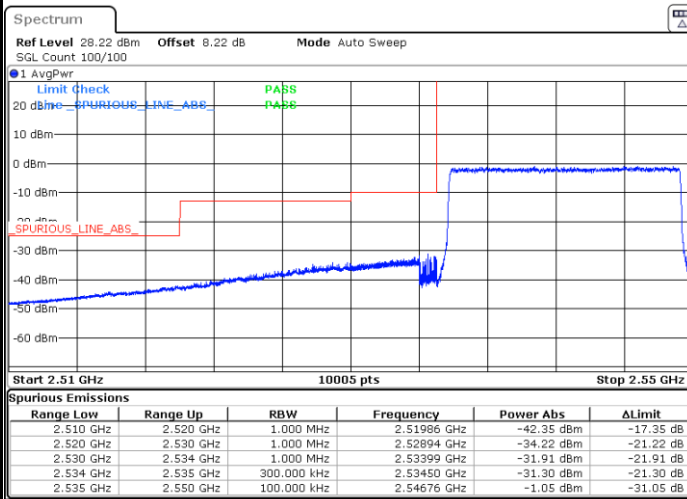

Date: 22 JUN 2022 08:09:15

Highest Band Edge / Full RB

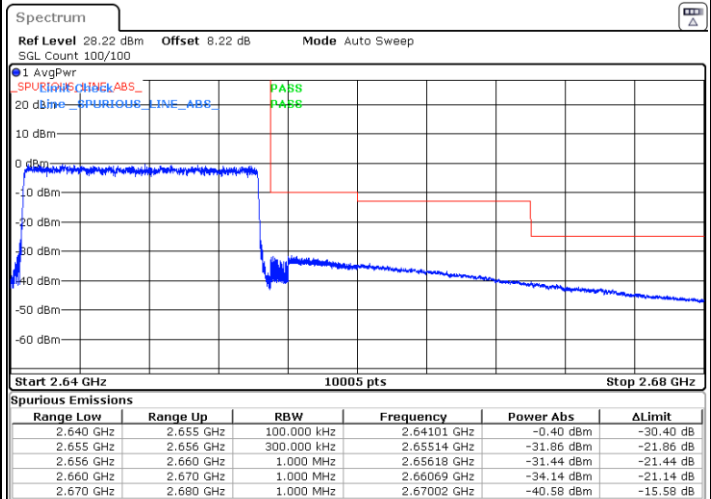

Date: 22 JUN 2022 08:13:01



LTE Band 41 / 20MHz / QPSK

Lowest Band Edge / 1 RB

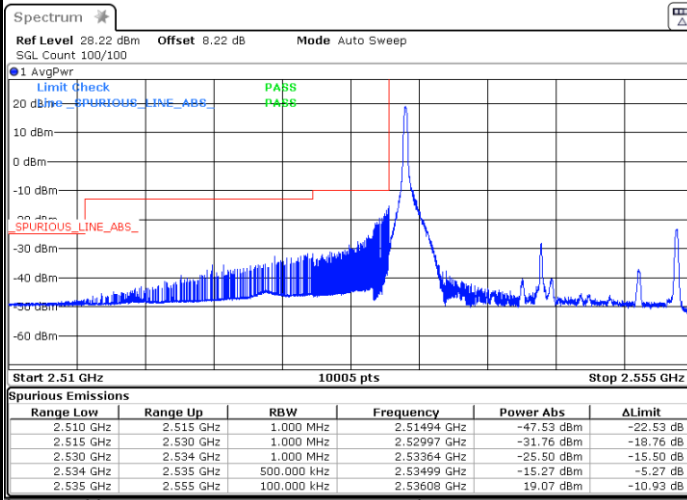

Date: 22 JUN 2022 08:16:41

Highest Band Edge / 1 RB

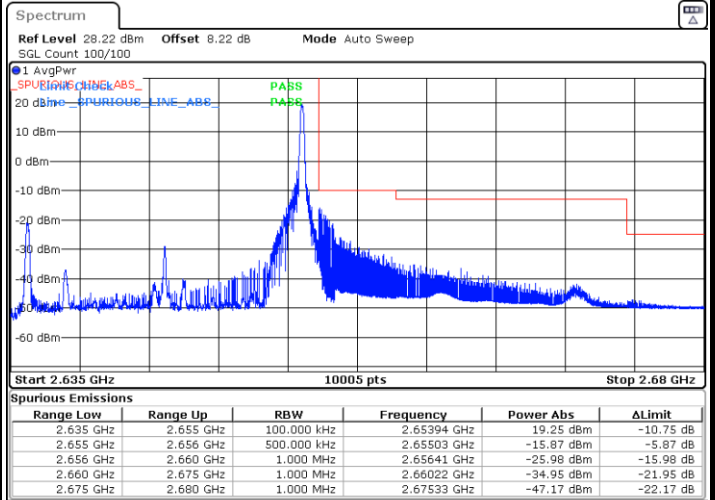

Date: 22 JUN 2022 08:22:19

Lowest Band Edge / Full RB

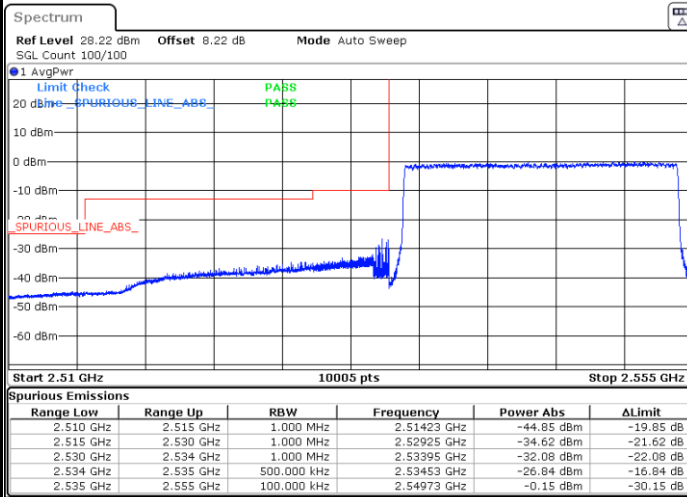

Date: 22 JUN 2022 08:21:05

Highest Band Edge / Full RB

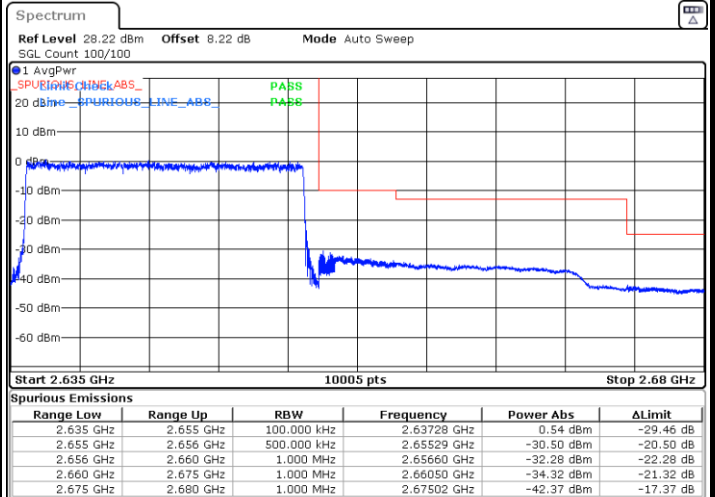

Date: 22 JUN 2022 08:25:49



LTE Band 41 / 20MHz / 16QAM

Lowest Band Edge / 1 RB

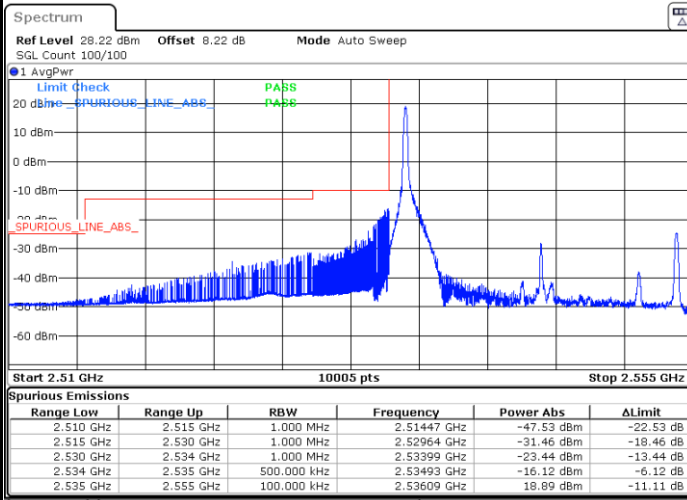

Date: 22 JUN.2022 09:17:41

Highest Band Edge / 1 RB

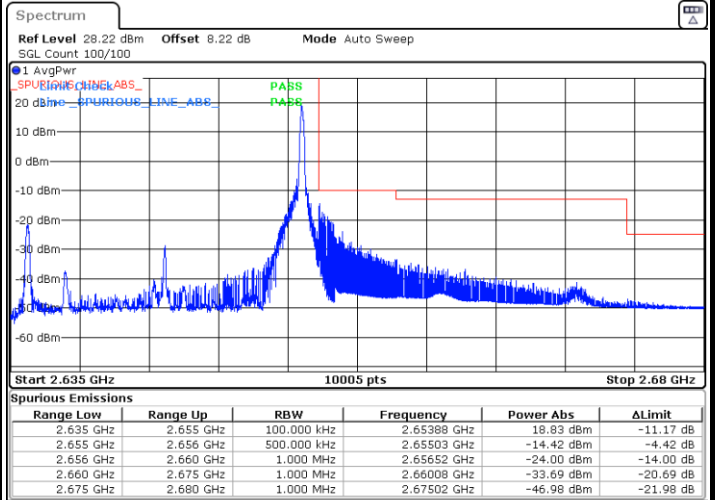

Date: 22 JUN.2022 09:22:58

Lowest Band Edge / Full RB

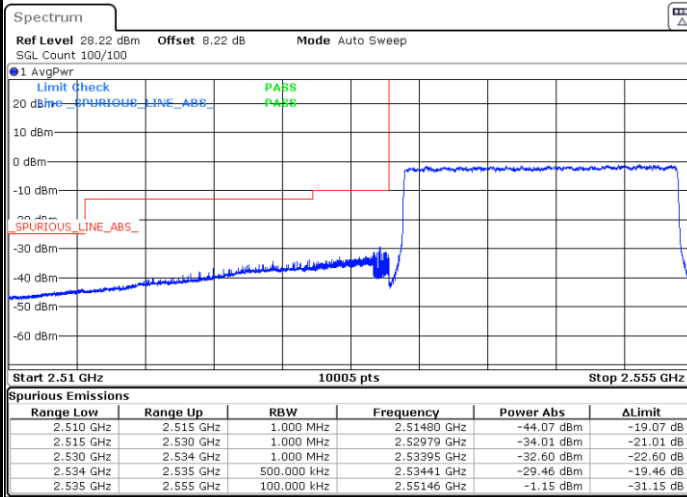

Date: 22 JUN.2022 08:20:19

Highest Band Edge / Full RB

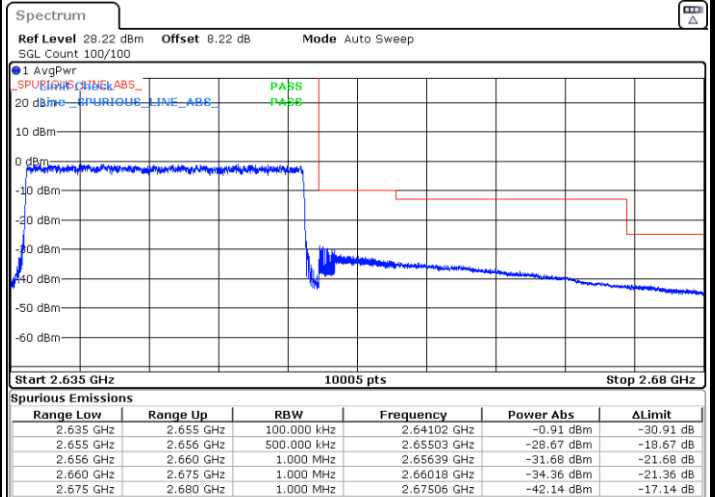

Date: 22 JUN.2022 08:25:10



LTE Band 41 / 20MHz / 64QAM

Lowest Band Edge / 1 RB

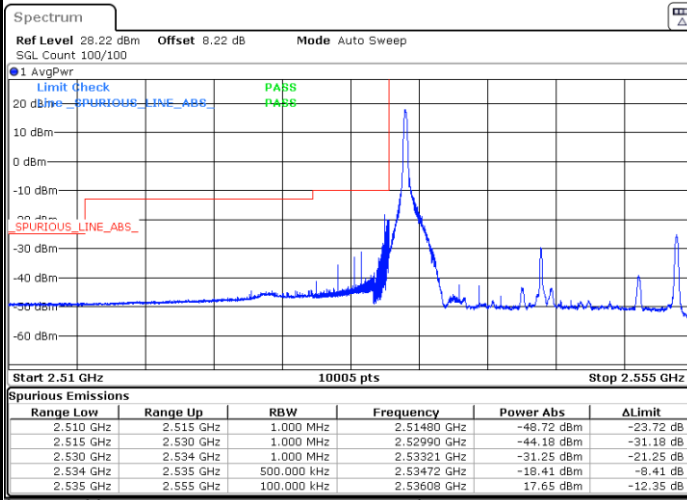

Date: 22 JUN.2022 08:18:48

Highest Band Edge / 1 RB

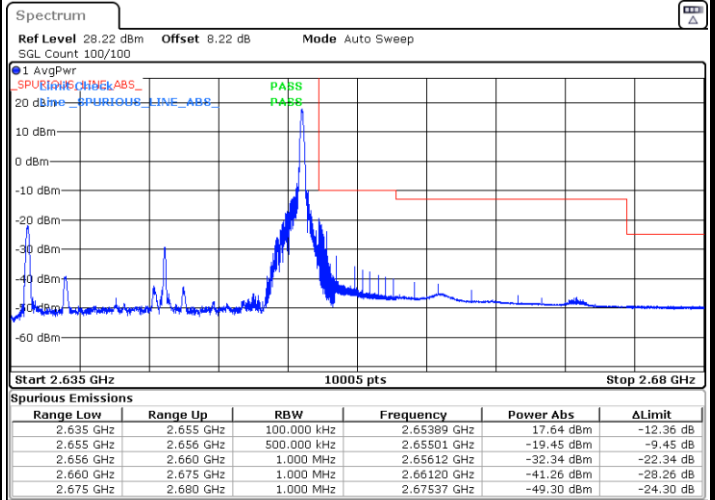

Date: 22 JUN.2022 08:23:33

Lowest Band Edge / Full RB

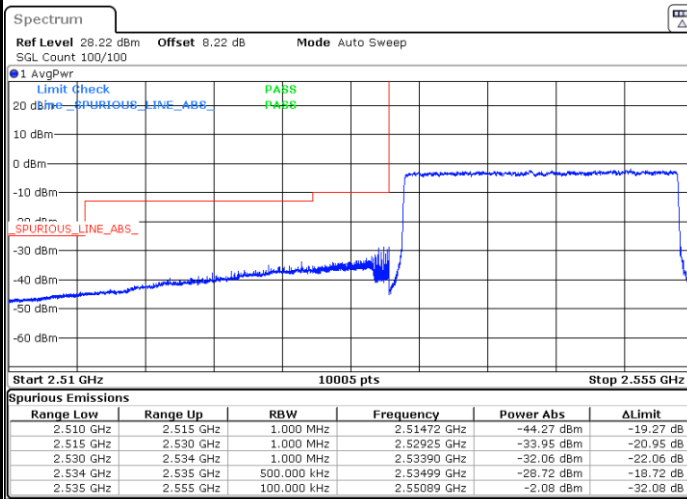

Date: 22 JUN.2022 08:19:36

Highest Band Edge / Full RB

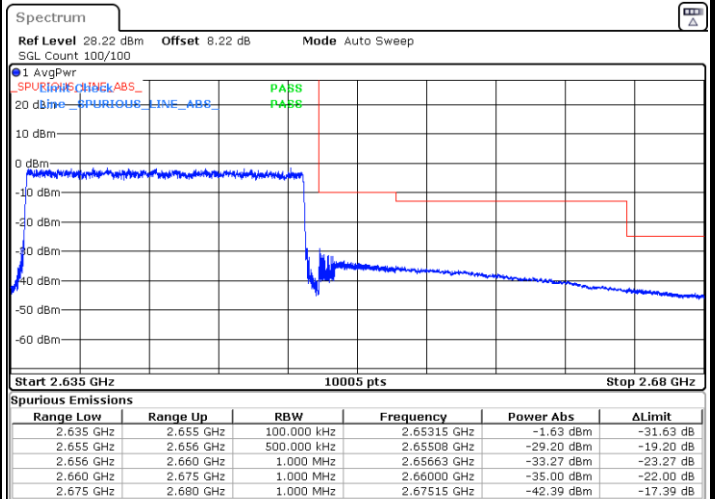

Date: 22 JUN.2022 08:24:10



Conducted Spurious Emission

LTE Band 41 / 5MHz

Lowest Channel / QPSK

Middle Channel / QPSK

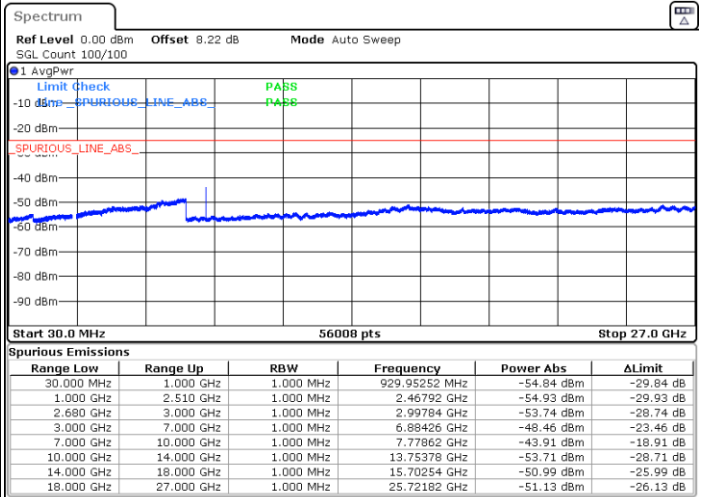
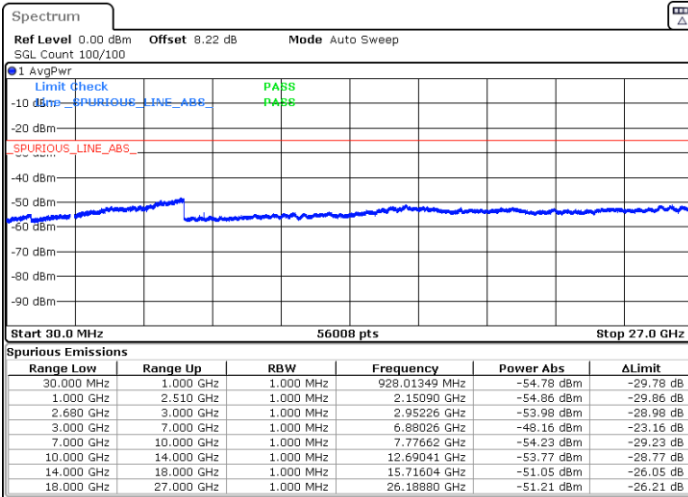

Date: 29.JUN.2022 04:08:17

Date: 29.JUN.2022 04:11:06

Highest Channel / QPSK

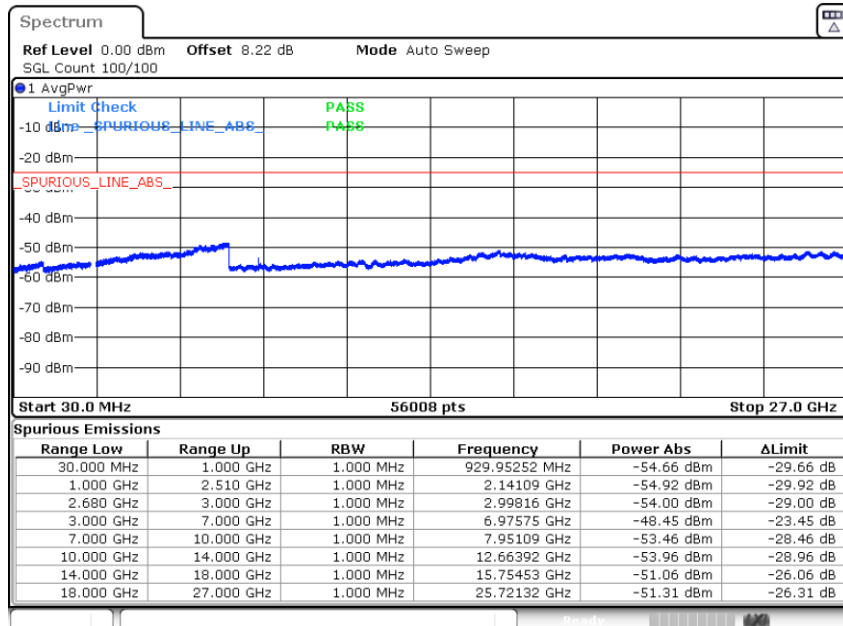

Date: 29.JUN.2022 04:14:02



LTE Band 41 / 10MHz

Lowest Channel / QPSK

Middle Channel / QPSK

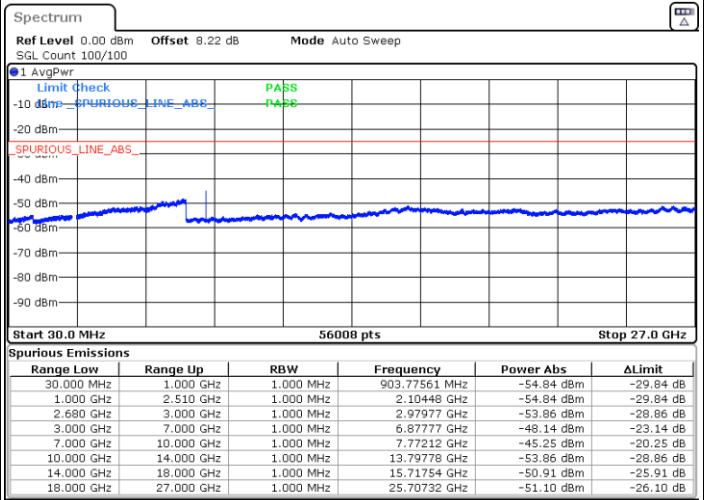
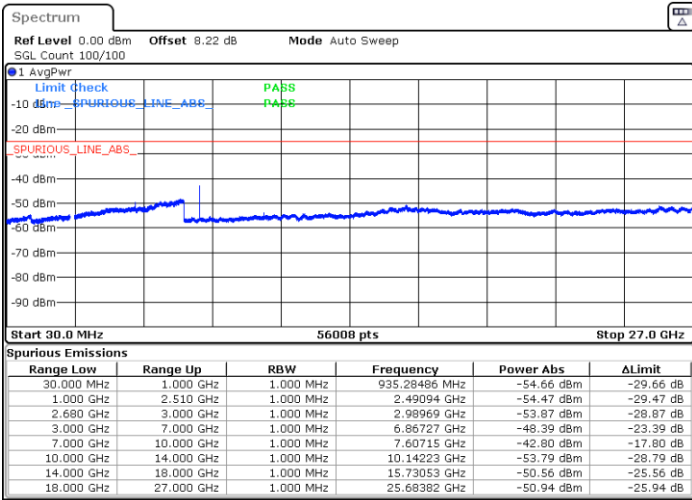

Date: 29.JUN.2022 04:17:02

Date: 29.JUN.2022 04:18:13

Highest Channel / QPSK

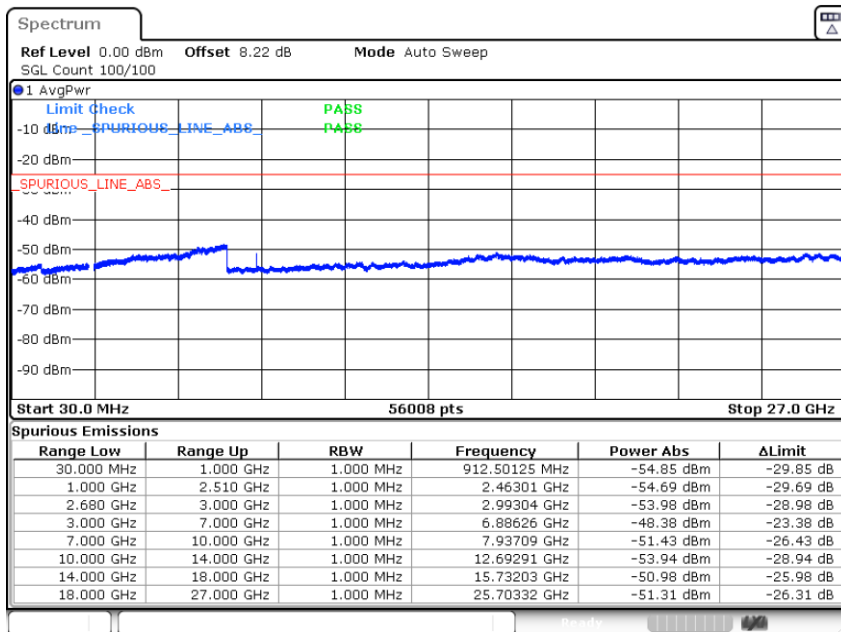

Date: 29.JUN.2022 04:22:00



LTE Band 41 / 15MHz

Lowest Channel / QPSK

Middle Channel / QPSK

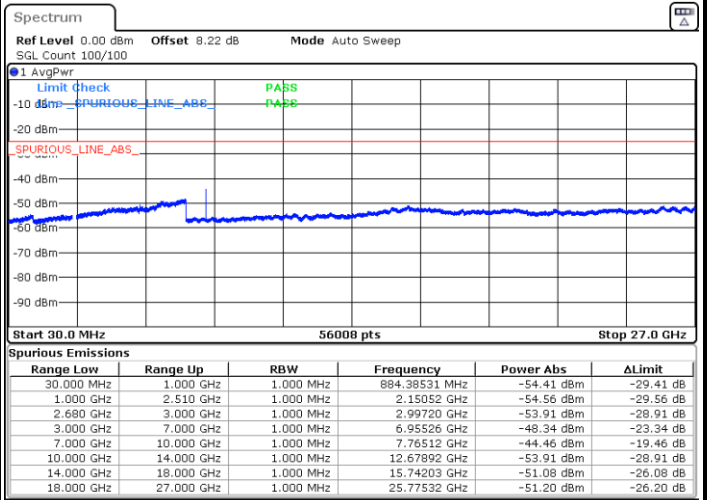
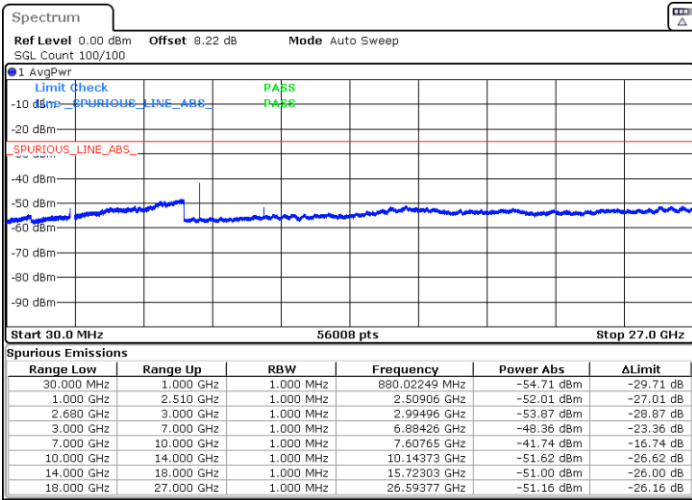

Date: 29.JUN.2022 04:23:23

Date: 29.JUN.2022 04:25:49

Highest Channel / QPSK

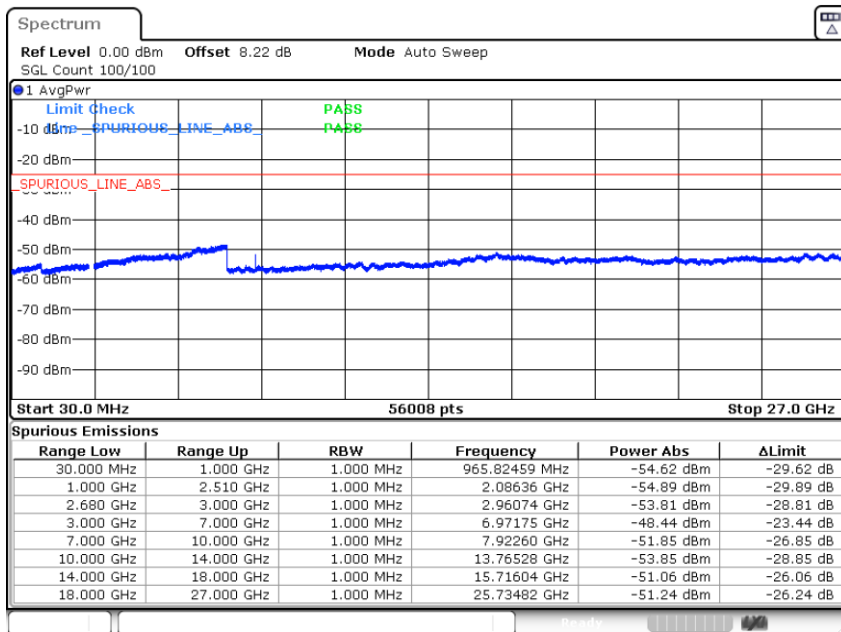

Date: 29.JUN.2022 04:27:09



LTE Band 41 / 20MHz

Lowest Channel / QPSK

Middle Channel / QPSK

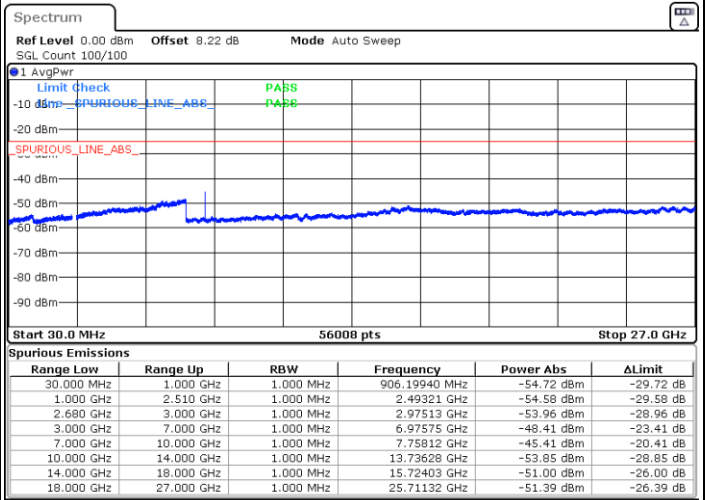
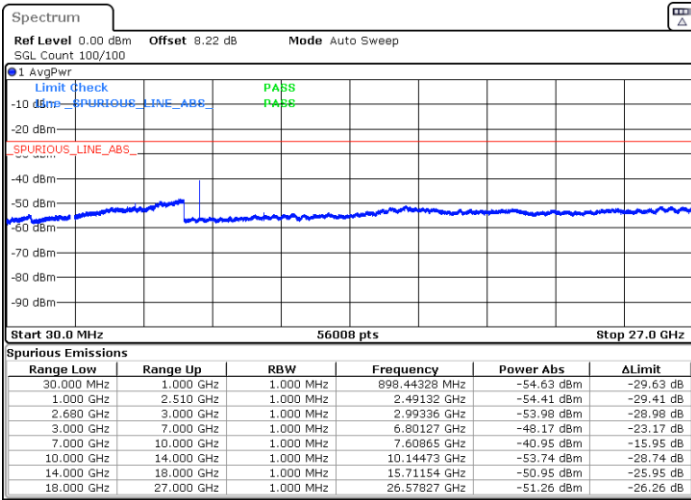

Date: 29. JUN. 2022 04:28:48

Date: 29. JUN. 2022 04:29:59

Highest Channel / QPSK

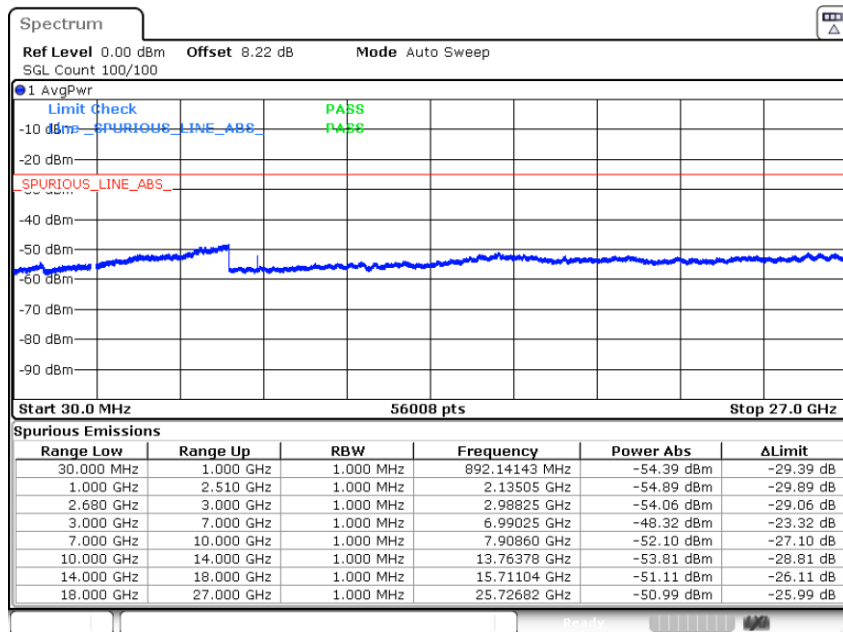

Date: 29. JUN. 2022 04:32:30



Frequency Stability

Test Conditions		LTE Band 41 (QPSK) / Middle Channel	Limit
Temperature (°C)	Voltage (Volt)	BW 10MHz	Note 2.
		Deviation (ppm)	Result
50	Normal Voltage	0.0034	PASS
40	Normal Voltage	0.0021	
30	Normal Voltage	0.0007	
20(Ref.)	Normal Voltage	0.0000	
10	Normal Voltage	0.0012	
0	Normal Voltage	0.0027	
-10	Normal Voltage	0.0016	
-20	Normal Voltage	0.0031	
-30	Normal Voltage	0.0042	
20	Maximum Voltage	0.0024	
20	Normal Voltage	0.0011	
20	Battery End Point	0.0036	

Note:

1. Normal Voltage =3.89 V. ; Battery End Point (BEP) =3.45 V. ; Maximum Voltage =4.48 V.
2. Note: The frequency fundamental emissions stay within the authorized frequency block.



Appendix B. Test Results of Radiated Test

Radiated Spurious Emission

Test Engineer :	Carry Xu	Temperature :	23~25°C
		Relative Humidity :	41~42%

LTE Band 41 / 20MHz / QPSK								
Channel	Frequency (MHz)	EIRP (dBm)	Limit (dBm)	Over Limit (dB)	S.G. Power (dBm)	TX Cable loss (dB)	TX Antenna Gain (dBi)	Polarization (H/V)
Middle	5168	-46.87	-25	-21.87	-57.08	3.03	13.24	H
	7752	-59.50	-25	-34.50	-68.95	3.56	13.01	H
	10340	-56.09	-25	-31.09	-65.61	3.92	13.44	H
	5168	-52.30	-25	-27.30	-62.51	3.03	13.24	V
	7752	-60.73	-25	-35.73	-70.18	3.56	13.01	V
	10340	-56.45	-25	-31.45	-65.97	3.92	13.44	V

Remark: Spurious emissions within 30-1000MHz were found more than 20dB below limit line.