



FCC RF Test Report

APPLICANT : Motorola Mobility LLC
EQUIPMENT : Mobile Cellular Phone
BRAND NAME : Motorola
MODEL NAME : XT2245-1
FCC ID : IHDT56AF9
STANDARD : 47 CFR Part 2, 22, 24, 27
CLASSIFICATION : PCS Licensed Transmitter Held to Ear (PCE)
TEST DATE(S) : Jun. 26, 2022 ~ Jul. 06, 2022

We, Sporton International Inc. (ShenZhen), would like to declare that the tested sample has been evaluated in accordance with the procedures given in ANSI C63.26-2015 and shown compliance with the applicable technical standards.

The test results in this report apply exclusively to the tested model / sample. Without written approval of Sporton International Inc. (ShenZhen), the test report shall not be reproduced except in full.

Jason Jia

Approved by: Jason Jia



Sporton International Inc. (Kunshan)

**No. 1098, Pengxi North Road, Kunshan Economic Development Zone Jiangsu Province 215300
People's Republic of China**



TABLE OF CONTENTS

REVISION HISTORY...3
SUMMARY OF TEST RESULT...4
1 GENERAL DESCRIPTION...5
1.1 Applicant...5
1.2 Manufacturer...5
1.3 Product Feature of Equipment Under Test...5
1.4 Product Specification of Equipment Under Test...6
1.5 Modification of EUT...6
1.6 Maximum ERP/EIRP Power and Emission Designator...7
1.7 Testing Location...9
1.8 Test Software...9
1.9 Applicable Standards...9
1.10 Specification of Accessory...10
2 TEST CONFIGURATION OF EQUIPMENT UNDER TEST...11
2.1 Test Mode...11
2.2 Connection Diagram of Test System...13
2.3 Support Unit used in test configuration and system...13
2.4 Measurement Results Explanation Example...13
2.5 Frequency List of Low/Middle/High Channels...14
3 CONDUCTED TEST ITEMS...17
3.1 Measuring Instruments...17
3.2 Test Setup...17
3.3 Test Result of Conducted Test...17
3.4 Conducted Output Power and ERP/EIRP...18
3.5 Peak-to-Average Ratio...19
3.6 Occupied Bandwidth...20
3.7 Conducted Band Edge...21
3.8 Conducted Spurious Emission...23
3.9 Frequency Stability...24
4 RADIATED TEST ITEMS...25
4.1 Measuring Instruments...25
4.2 Test Setup...25
4.3 Test Result of Radiated Test...26
4.4 Radiated Spurious Emission...27
5 LIST OF MEASURING EQUIPMENT...28
6 UNCERTAINTY OF EVALUATION...29
APPENDIX A. TEST RESULTS OF CONDUCTED TEST
APPENDIX B. TEST RESULTS OF RADIATED TEST
APPENDIX C. TEST SETUP PHOTOGRAPHS



REVISION HISTORY

REPORT NO.	VERSION	DESCRIPTION	ISSUED DATE
FG253001F	Rev. 01	Initial issue of report	Jul. 30, 2022



SUMMARY OF TEST RESULT

Report Section	FCC Rule	Description	Limit	Result	Remark
3.4	§2.1046	Conducted Output Power	Reporting Only	PASS	-
	§22.913(a)(5)	Effective Radiated Power (5G NR n5)	ERP < 7 Watt		
	§24.232(c) §27.50(h)(2)	Equivalent Isotropic Radiated Power (5G NR n2) (5G NR n7, n38)	EIRP < 2Watt		
	§27.50(d)(4)	Equivalent Isotropic Radiated Power (5G NR n66)	EIRP < 1Watt		
3.5	§24.232(d)	Peak-to-Average Ratio	<13 dB	PASS	-
3.6	§2.1049	Occupied Bandwidth	Reporting Only	PASS	-
3.7	§2.1051 §22.917(a) §24.238(a) §27.53(h)	Conducted Band Edge Measurement (5G NR n5) (5G NR n2) (5G NR n66)	< 43+10log ₁₀ (P[Watts])	PASS	-
	§27.53(m)(4)	Conducted Band Edge Measurement (5G NR n7, n38)	§27.53(m)(4)		
3.8	§2.1051 §22.917(a) §24.238(a) §27.53(h)	Conducted Spurious Emission (5G NR n5) (5G NR n2) (5G NR n66)	< 43+10log ₁₀ (P[Watts])	PASS	-
	§2.1051 §27.53(m)(4)	Conducted Spurious Emission (5G NR n7, n38)	< 55+10log ₁₀ (P[Watts])		
3.9	§2.1055 §22.355	Frequency Stability Temperature & Voltage	< 2.5 ppm for Part 22	PASS	-
	§24.235 §27.54		Within Authorized Band		
4.4	§2.1053 §22.917(a) §24.238(a) §27.53(h)	Radiated Spurious Emission (5G NR n5) (5G NR n2) (5G NR n66)	< 43+10log ₁₀ (P[Watts])	PASS	Under limit 18.53 dB at 7578.270 MHz
	§2.1053 §27.53(m)(4)	Radiated Spurious Emission (5G NR n7, n38)	< 55+10log ₁₀ (P[Watts])		

Declaration of Conformity:

The test results with all measurement uncertainty excluded are presented in accordance with the regulation limits or requirements declared by manufacturers.

Comments and Explanations:

The declared of product specification for EUT presented in the report are provided by the manufacturer, and the manufacturer takes all the responsibilities for the accuracy of product specification.



1 General Description

1.1 Applicant

Motorola Mobility LLC
222 W,Merchandise Mart Plaza, Chicago IL 60654 USA

1.2 Manufacturer

Motorola Mobility LLC
222 W,Merchandise Mart Plaza, Chicago IL 60654 USA

1.3 Product Feature of Equipment Under Test

Product Feature	
Equipment	Mobile Cellular Phone
Brand Name	Motorola
Model Name	XT2245-1
FCC ID	IHDT56AF9
IMEI Code	Conducted : 357398930012387 Radiation : 357398930011249
HW Version	DVT2
SW Version	S3SSM32.29
EUT Stage	Identical Prototype

Remark:

Only 5G NR bands are tested in this report, all the other RF bands are tested in the other reports separately.

1.4 Product Specification of Equipment Under Test

Standards-related Product Specification	
Tx Frequency	5G NR n2 : 1850 MHz ~ 1910 MHz 5G NR n5 : 824 MHz ~ 849 MHz 5G NR n7 : 2500 MHz ~ 2570 MHz 5G NR n38 : 2570 MHz ~ 2620 MHz 5G NR n66 : 1710 MHz ~ 1780 MHz
Rx Frequency	5G NR n2 : 1930 MHz ~ 1990 MHz 5G NR n5 : 869 MHz ~ 894 MHz 5G NR n7 : 2620 MHz ~ 2690 MHz 5G NR n38: 2570 MHz ~ 2620 MHz 5G NR n66 : 2110 MHz~ 2200 MHz
SCS	5G NR n2, n5, n7, n66:15kHz 5G NR n38:30kHz
Bandwidth	n2, n5: 5MHz / 10MHz / 15MHz / 20MHz n7: 5MHz / 10MHz / 15MHz / 20MHz / 25MHz / 30MHz / 40MHz n38: 20MHz / 30MHz / 40MHz n66: 5MHz / 10MHz / 15MHz / 20MHz / 30MHz / 40MHz
Antenna Gain	<Ant. 0> n2: -1.2 dBi n5: -4.1 dBi n7: -2.1 dBi n38: -2.5 dBi n66: -1.0 dBi <Ant. 1> n2: -4.1 dBi n7: -2.2 dBi n38: -2.2 dBi n66: -2.4 dBi
Type of Modulation	CP-OFDM: QPSK / 16QAM / 64QAM / 256QAM DFT-s-OFDM: PI/2 BPSK / QPSK / 16QAM / 64QAM / 256QAM

Note:

1. The maximum ERP/EIRP is calculated from max output power and antenna gain, only the maximum ERP/EIRP is shown in the report: 5G NR n2, n5, n7, n38, n66 for Ant.0.
2. 5G NR n7/n66 support SA & NSA mode, n2/n5 only support NSA mode, n38 only support SA mode. The whole testing has assessed by referring to the higher conducted power for conducted test items.
3. All the supported ENDC combinations are verified conducted power, only the ENDC combination with highest power are shown in the report.
4. The EN-DC mode combination could be referred to the product spec.

1.5 Modification of EUT

No modifications are made to the EUT during all test items.



1.6 Maximum ERP/EIRP Power and Emission Designator

5G NR n2 (EN DC_7A-n2A)		PI/2 BPSK / QPSK		16QAM / 64QAM / 256QAM	
BW (MHz)	Frequency Range (MHz)	Maximum EIRP(W)	Emission Designator (99%OBW)	Maximum EIRP(W)	Emission Designator (99%OBW)
5	1852.5 ~ 1907.5	0.1528	4M47G7D	0.1262	4M49W7D
10	1855.0 ~ 1905.0	0.1567	9M29G7D	0.1274	9M30W7D
15	1857.5 ~ 1902.5	0.1549	14M1G7D	0.1271	14M1W7D
20	1860.0 ~ 1900.0	0.1585	18M9G7D	0.1279	19M0W7D

5G NR n5 (EN DC_7A-n5A)		PI/2 BPSK / QPSK		16QAM / 64QAM / 256QAM	
BW (MHz)	Frequency Range (MHz)	Maximum ERP(W)	Emission Designator (99%OBW)	Maximum ERP(W)	Emission Designator (99%OBW)
5	826.5 ~ 846.5	0.0518	4M47G7D	0.0422	4M49W7D
10	829.0 ~ 844.0	0.0513	9M27G7D	0.0415	9M27W7D
15	831.5 ~ 841.5	0.0514	14M1G7D	0.0438	14M1W7D
20	834.0 ~ 839.0	0.0533	18M9G7D	0.0425	18M9W7D

5G NR n7 SA		PI/2 BPSK / QPSK		16QAM / 64QAM / 256QAM	
BW (MHz)	Frequency Range (MHz)	Maximum EIRP(W)	Emission Designator (99%OBW)	Maximum EIRP(W)	Emission Designator (99%OBW)
5	2502.5 ~ 2567.5	0.1449	4M48G7D	0.0897	4M49W7D
10	2505.0 ~ 2565.0	0.1439	9M28G7D	0.0883	9M29W7D
15	2507.5 ~ 2562.5	0.1390	14M1G7D	0.0869	14M1W7D
20	2510.0 ~ 2560.0	0.1396	18M9G7D	0.0871	18M9W7D
25	2512.5 ~ 2557.5	0.1422	23M7G7D	0.0891	23M8W7D
30	2515.0 ~ 2555.0	0.1416	28M6G7D	0.0883	28M6W7D
40	2520.0 ~ 2550.0	0.1472	38M6G7D	0.0927	38M6W7D



5G NR n38 SA		PI/2 BPSK / QPSK		16QAM / 64QAM / 256QAM	
BW (MHz)	Frequency Range (MHz)	Maximum EIRP(W)	Emission Designator (99%OBW)	Maximum EIRP(W)	Emission Designator (99%OBW)
20	2580 ~ 2610	0.0984	18M3G7D	0.0822	18M2W7D
30	2585 ~ 2605	0.1019	27M9G7D	0.0839	27M9W7D
40	2590 ~ 2600	0.1059	37M9G7D	0.0879	37M9W7D

5G NR n66 (EN DC_2A-n66A)		PI/2 BPSK / QPSK		16QAM / 64QAM / 256QAM	
BW (MHz)	Frequency Range (MHz)	Maximum EIRP(W)	Emission Designator (99%OBW)	Maximum EIRP(W)	Emission Designator (99%OBW)
5	1712.5 ~ 1777.5	0.1549	4M48G7D	0.1197	4M48W7D
10	1715.0 ~ 1775.0	0.1479	9M29G7D	0.1153	9M30W7D
15	1717.5 ~ 1772.5	0.1542	14M1G7D	0.1178	14M1W7D
20	1720.0 ~ 1770.0	0.1524	18M9G7D	0.1189	19M0W7D
30	1725.0 ~ 1765.0	0.1524	28M5G7D	0.1189	28M6W7D
40	1730.0 ~ 1760.0	0.1567	38M6G7D	0.1219	38M6W7D

Note: All modulations have been tested, and only the worst test results of PSK & QAM are shown in the report.



1.7 Testing Location

Sporton International Inc. (Shenzhen) is accredited to ISO/IEC 17025:2017 by American Association for Laboratory Accreditation with Certificate Number 5145.01.

Test Firm	Sporton International Inc. (Shenzhen)		
Test Site Location	1/F, 2/F, Bldg 5, Shiling Industrial Zone, Xinwei Village, Xili, Nanshan, Shenzhen, 518055 People’s Republic of China TEL: +86-755-86379589 FAX: +86-755-86379595		
Test Site No.	Sporton Site No.	FCC Designation No.	FCC Test Firm Registration No.
	TH01-SZ	CN1256	421272

Test Firm	Sporton International Inc. (Shenzhen)		
Test Site Location	101, 1st Floor, Block B, Building 1, No. 2, Tengfeng 4th Road, Fenghuang Community, Fuyong Street, Baoan District, Shenzhen City Guangdong Province China 518103 TEL: +86-755-33202398		
Test Site No.	Sporton Site No.	FCC Designation No.	FCC Test Firm Registration No.
	03CH02-SZ	CN1256	421272

1.8 Test Software

Item	Site	Manufacturer	Name	Version
1.	03CH02-SZ	AUDIX	E3	6.2009-8-24a

1.9 Applicable Standards

According to the specifications of the manufacturer, the EUT must comply with the requirements of the following standards:

- ♦ 47 CFR Part 2, 22, 24, 27
- ♦ ANSI C63.26-2015
- ♦ FCC KDB 971168 D01 Power Meas License Digital Systems v03r01
- ♦ FCC KDB 412172 D01 Determining ERP and EIRP v01r01

Remark:

All test items were verified and recorded according to the standards and without any deviation during the test.



1.10 Specification of Accessory

Specification of Accessory				
AC Adapter (US)	Brand Name	Motorola (Salcomp)	Model Name	MC-681L
AC Adapter (EU)	Brand Name	Motorola (Salcomp)	Model Name	MC-682L
AC Adapter (UK)	Brand Name	Motorola (Salcomp)	Model Name	MC-683L
AC Adapter (AU)	Brand Name	Motorola (Salcomp)	Model Name	MC-685L
AC Adapter (AR)	Brand Name	Motorola (Salcomp)	Model Name	MC-686L
AC Adapter (BR)	Brand Name	Motorola (Salcomp)	Model Name	MC-687L
AC Adapter (CHILE)	Brand Name	Motorola (Salcomp)	Model Name	MC-689L
Battery 1	Brand Name	Motorola(ATL)	Model Name	NP40
Battery 2	Brand Name	Motorola(SCUD)	Model Name	NP40
Earphone	Brand Name	Motorola (Lyand)	Model Name	MI181C
USB Cable	Brand Name	Motorola(Saibao)	Model Name	SC18D24968



2 Test Configuration of Equipment Under Test

2.1 Test Mode

Antenna port conducted and radiated test items are performed according to KDB 971168 D01 Power Meas License Digital Systems v03r01 with maximum output power.

For radiated measurement, pre-scanned in three orthogonal panels, X, Y, Z. The worst cases were recorded in this report.(X-Plane)

The device is investigated from 30MHz to 10 times of fundamental signal for radiated spurious emission test under different RB size/offset and modulations in exploratory test. Subsequently, only the worst case emissions are reported.

Orthogonal Planes of EUT	X Plane	Y Plane	Z Plane
			

Test Items	5G NR	Bandwidth (MHz)									Modulation					RB #		Test Channel		
		5	10/15	20	25	30	40	50	60-90	100	PI/2 BPSK	QPSK	16QAM	64QAM	256 QAM	1	Full	L	M	H
Max. Output Power	n2	v	v	v	-	-	-	-	-	-	v	v	v	v	v	v	v	v	v	v
	n5	v	v	v	-	-	-	-	-	-	v	v	v	v	v	v	v	v	v	v
	n7	v	v	v	v	v	v	-	-	-	v	v	v	v	v	v	v	v	v	v
	n38	-	-	v	-	v	v	-	-	-	v	v	v	v	v	v	v	v	v	v
	n66	v	v	v	-	v	v	-	-	-	v	v	v	v	v	v	v	v	v	v
Peak-to-Average Ratio	n2			v	-	-	-	-	-	-	v	v				v	v	v	v	v
	n5			v	-	-	-	-	-	-	v	v				v	v	v	v	v
	n7			v				-	-	-	v	v				v	v	v	v	v
	n38	-	-	v	-			-	-	-	v	v				v	v	v	v	v
	n66			v				-	-	-	v	v				v	v		v	
26dB and 99% Bandwidth	n2	v	v	v	-	-	-	-	-	-	v	v	v	v	v		v		v	
	n5	v	v	v	-	-	-	-	-	-	v	v	v	v	v		v		v	
	n7	v	v	v	v	v	v	-	-	-	v	v	v	v	v		v		v	
	n38	-	-	v	-	v	v	-	-	-	v	v	v	v	v		v		v	
	n66	v	v	v	-	v	v	-	-	-	v	v	v	v	v		v		v	



Test Items	5G NR	Bandwidth (MHz)									Modulation					RB #		Test Channel		
		5	10/15	20	25	30	40	50	60-90	100	PI/2 BPSK	QPSK	16QAM	64QAM	256 QAM	1	Full	L	M	H
Conducted Band Edge	n2	v	v	v	-	-	-	-	-	-	v	v				v	v	v		v
	n5	v	v	v	-	-	-	-	-	-	v	v				v	v	v		v
	n7	v		v			v	-	-	-	v	v				v	v	v		v
	n38	-	-	v	-	v	v	-	-	-	v	v				v	v	v		v
	n66	v		v			v	-	-	-	v	v				v	v	v		v
Conducted Spurious Emission	n2	v	v	v	-	-	-	-	-	-	v	v				v		v	v	v
	n5	v	v	v	-	-	-	-	-	-	v	v				v		v	v	v
	n7	v		v			v	-	-	-	v	v				v		v	v	v
	n38	-	-	v	-	v	v	-	-	-	v	v				v		v	v	v
	n66	v		v			v	-	-	-	v	v				v		v	v	v
Frequency Stability	n2			v	-	-	-	-	-	-		v					v		v	
	n5			v	-	-	-	-	-	-		v					v		v	
	n7			v				-	-	-		v					v		v	
	n38	-	-	v	-			-	-	-		v					v		v	
	n66			v				-	-	-		v					v		v	
E.R.P / E.I.R.P	n2	v	v	v	-	-	-	-	-	-	v	v	v	v	v	v	v	v	v	v
	n5	v	v	v	-	-	-	-	-	-	v	v	v	v	v	v	v	v	v	v
	n7	v	v	v	v	v	v	-	-	-	v	v	v	v	v	v	v	v	v	v
	n38	-	-	v	-	v	v	-	-	-	v	v	v	v	v	v	v	v	v	v
	n66	v	v	v	-	v	v	-	-	-	v	v	v	v	v	v	v	v	v	v
Radiated Spurious Emission	n2	Worst Case																v	v	v
	n5	Worst Case																v	v	v
	n7	Worst Case																v	v	v
	n38	Worst Case																v	v	v
	n66	Worst Case																v	v	v
Note	1. The mark "v" means that this configuration is chosen for testing 2. The mark "-" means that this bandwidth is not supported. 3. The device is investigated from 30MHz to 10 times of fundamental signal for radiated spurious emission test under different RB size/offset and modulations in exploratory test. Subsequently, only the worst case emissions are reported. 4. Normal Voltage: 3.89Vdc, Extreme Voltage: 3.5Vdc ~4.45Vdc																			

2.2 Connection Diagram of Test System

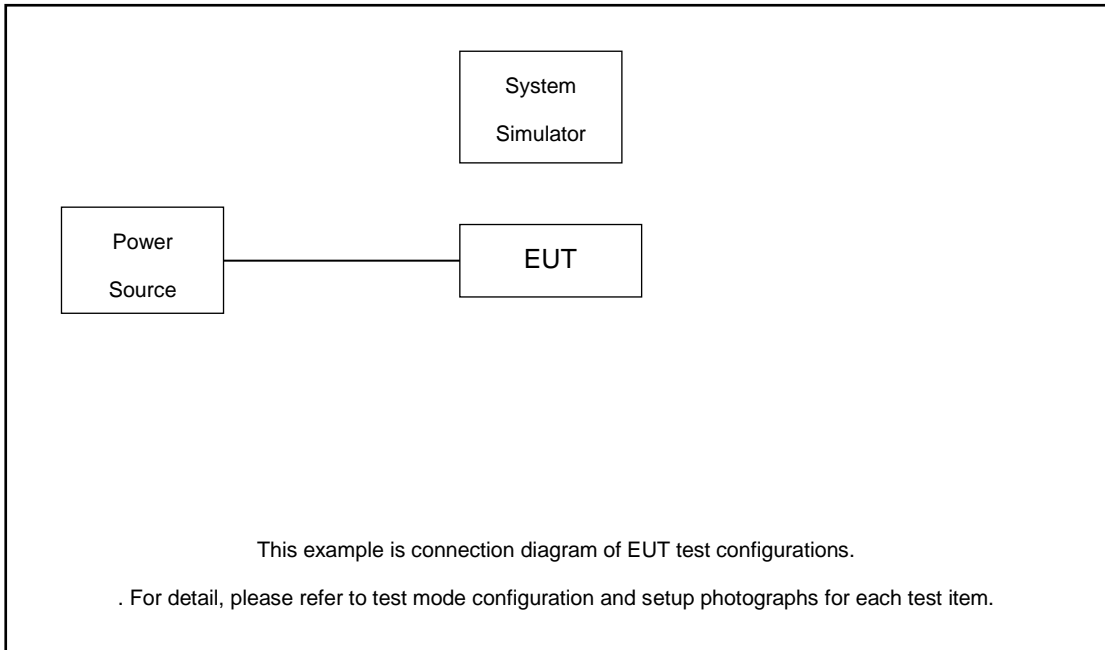

2.3 Support Unit used in test configuration and system

Item	Equipment	Trade Name	Model No.	FCC ID	Data Cable	Power Cord
1.	DC Power Supply	GW	GPS-3030D	N/A	N/A	Unshielded, 1.8 m
2.	LTE Base Station	Anritsu	MT8821C	N/A	N/A	Unshielded, 1.8 m
3.	NR Base Station	Anritsu	MT8000A	N/A	N/A	Unshielded, 1.8 m

2.4 Measurement Results Explanation Example

For all conducted test items:

The offset level is set in the spectrum analyzer to compensate the RF cable loss and attenuator factor between EUT conducted output port and spectrum analyzer. With the offset compensation, the spectrum analyzer reading level is exactly the EUT RF output level.

The spectrum analyzer offset is derived from RF cable loss and attenuator factor.

Offset = RF cable loss.

Following shows an offset computation example with cable loss 7.3 dB.

Example :

$$\begin{aligned} \text{Offset(dB)} &= \text{RF cable loss(dB)}. \\ &= 7.3 \text{ (dB)} \end{aligned}$$



2.5 Frequency List of Low/Middle/High Channels

5G NR n2 Channel and Frequency List				
BW [MHz]	Channel/Frequency(MHz)	Lowest	Middle	Highest
20	Channel	388000	392000	396000
	Frequency	1860	1880	1900
15	Channel	387500	392000	396500
	Frequency	1857.5	1880	1902.5
10	Channel	387000	392000	397000
	Frequency	1855	1880	1905
5	Channel	386500	392000	397500
	Frequency	1852.5	1880	1907.5

5G NR n5 Channel and Frequency List				
BW [MHz]	Channel/Frequency(MHz)	Lowest	Middle	Highest
20	Channel	175800	176300	176800
	Frequency	834	836.5	839
15	Channel	175300	176300	177300
	Frequency	831.5	836.5	841.5
10	Channel	174800	176300	177800
	Frequency	829	836.5	844
5	Channel	174300	176300	178300
	Frequency	826.5	836.5	846.5



5G NR n7 Channel and Frequency List				
BW [MHz]	Channel/Frequency(MHz)	Lowest	Middle	Highest
40	Channel	528000	531000	534000
	Frequency	2520	2535	2550
30	Channel	527000	531000	535000
	Frequency	2515	2535	2555
25	Channel	526500	531000	535500
	Frequency	2512.5	2535	2557.5
20	Channel	526000	531000	536000
	Frequency	2510	2535	2560
15	Channel	525500	531000	536500
	Frequency	2507.5	2535	2562.5
10	Channel	525000	531000	537000
	Frequency	2505	2535	2565
5	Channel	254500	531000	537500
	Frequency	2502.5	2535	2567.5

5G NR n38 Channel and Frequency List				
BW [MHz]	Channel/Frequency(MHz)	Lowest	Middle	Highest
40	Channel	518000	519000	520000
	Frequency	2590	2595	2600
30	Channel	517000	519000	521000
	Frequency	2585	2595	2605
20	Channel	516000	519000	522000
	Frequency	2580	2595	2610



5G NR n66 Channel and Frequency List				
BW [MHz]	Channel/Frequency(MHz)	Lowest	Middle	Highest
40	Channel	426000	429000	432000
	Frequency	1730	1745	1760
30	Channel	425000	429000	433000
	Frequency	1725	1745	1765
20	Channel	424000	429000	434000
	Frequency	1720	1745	1770
15	Channel	423500	429000	434500
	Frequency	1717.5	1745	1772.5
10	Channel	423000	429000	435000
	Frequency	1715	1745	1775
5	Channel	422500	429000	435500
	Frequency	1712.5	1745	1777.5

3 Conducted Test Items

3.1 Measuring Instruments

See list of measuring instruments of this test report.

3.2 Test Setup

3.2.1 Conducted Output Power

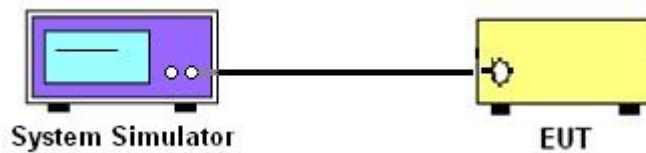

3.2.2 Peak-to-Average Ratio, Occupied Bandwidth ,Conducted Band-Edge and Conducted Spurious Emission

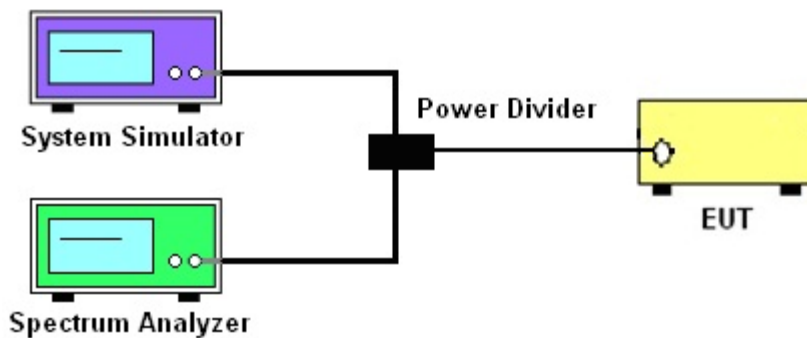

3.2.3 Frequency Stability

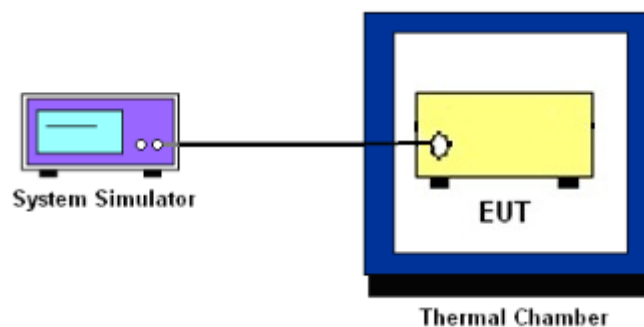

3.3 Test Result of Conducted Test

Please refer to Appendix A.



3.4 Conducted Output Power and ERP/EIRP

3.4.1 Description of the Conducted Output Power Measurement and ERP/EIRP Measurement

A system simulator was used to establish communication with the EUT. Its parameters were set to force the EUT transmitting at maximum output power. The measured power in the radio frequency on the transmitter output terminals shall be reported.

The ERP of mobile transmitters must not exceed 7 Watts for 5G NR n5.

The EIRP of mobile transmitters must not exceed 2 Watts for 5G NR n2 and n7, n38.

The EIRP of mobile transmitters must not exceed 1 Watts for 5G NR n66.

According to KDB 412172 D01 Power Approach,

$EIRP = P_T + G_T - L_C$, $ERP = EIRP - 2.15$, where

P_T = transmitter output power in dBm

G_T = gain of the transmitting antenna in dBi

L_C = signal attenuation in the connecting cable between the transmitter and antenna in dB

3.4.2 Test Procedures

1. The testing follows ANSI C63.26 Section 5.2
2. The transmitter output port was connected to the system simulator.
3. Set EUT at maximum power through the system simulator.
4. Select lowest, middle, and highest channels for each band and different modulation.
5. Measure and record the power level from the system simulator.



3.5 Peak-to-Average Ratio

3.5.1 Description of the PAR Measurement

Power Complementary Cumulative Distribution Function (CCDF) curves provide a means for characterizing the power peaks of a digitally modulated signal on a statistical basis. A CCDF curve depicts the probability of the peak signal amplitude exceeding the average power level. Most contemporary measurement instrumentation include the capability to produce CCDF curves for an input signal provided that the instrument's resolution bandwidth can be set wide enough to accommodate the entire input signal bandwidth. In measuring transmissions in this band using an average power technique, the peak-to-average ratio (PAR) of the transmission may not exceed 13 dB.

3.5.2 Test Procedures

1. The testing follows ANSI C63.26 Section 5.2.3.4 (CCDF).
2. The EUT was connected to spectrum and system simulator via a power divider.
3. Set the CCDF (Complementary Cumulative Distribution Function) option in spectrum analyzer.
4. The highest RF powers were measured and recorded the maximum PAPR level associated with a probability of 0.1 %.
5. Record the deviation as Peak to Average Ratio.



3.6 Occupied Bandwidth

3.6.1 Description of Occupied Bandwidth Measurement

The occupied bandwidth is the width of a frequency band such that, below the lower and above the upper frequency limits, the mean powers emitted are each equal to a specified percentage 0.5% of the total mean transmitted power.

The 26 dB emission bandwidth is defined as the frequency range between two points, one above and one below the carrier frequency, at which the spectral density of the emission is attenuated 26 dB below the maximum in-band spectral density of the modulated signal. Spectral density (power per unit bandwidth) is to be measured with a detector of resolution bandwidth equal to approximately 1.0% of the emission bandwidth.

3.6.2 Test Procedures

1. The testing follows ANSI C63.26 Section 5.4
2. The EUT was connected to spectrum analyzer and system simulator via a power divider.
3. The spectrum analyzer center frequency is set to the nominal EUT channel center frequency. The span range for the spectrum analyzer shall be between two and five times the anticipated OBW.
4. The nominal resolution bandwidth (RBW) shall be in the range of 1 to 5 % of the anticipated OBW, and the VBW shall be at least 3 times the RBW.
5. Set the detection mode to peak, and the trace mode to max hold.
6. Determine the reference value: Set the EUT to transmit a modulated signal. Allow the trace to stabilize. Set the spectrum analyzer marker to the highest level of the displayed trace.
(this is the reference value)
7. Determine the “-26 dB down amplitude” as equal to (Reference Value – X).
8. Place two markers, one at the lowest and the other at the highest frequency of the envelope of the spectral display such that each marker is at or slightly below the “-X dB down amplitude” determined in step 6. If a marker is below this “-X dB down amplitude” value it shall be placed as close as possible to this value. The OBW is the positive frequency difference between the two markers.
9. Use the 99 % power bandwidth function of the spectrum analyzer and report the measured bandwidth.



3.7 Conducted Band Edge

3.7.1 Description of Conducted Band Edge Measurement

22.917(a)

For operations in the 824 – 849 MHz band, the FCC limit is $43 + 10\log_{10}(P[\text{Watts}])$ dB below the transmitter power $P(\text{Watts})$ in a 100kHz bandwidth. However, in the 1MHz bands immediately outside and adjacent to the licensee's frequency block, a resolution bandwidth of at least one percent of the emission bandwidth of the fundamental emission of the transmitter may be employed.

24.238 (a)

For operations in the 1850-1910 and 1930-1990 MHz band, the FCC limit is $43 + 10\log_{10}(P[\text{Watts}])$ dB below the transmitter power $P(\text{Watts})$ in a 1MHz bandwidth. However, in the 1 MHz bands immediately outside and adjacent to the frequency block a resolution bandwidth of at least one percent of the emission bandwidth of the fundamental emission of the transmitter may be employed.

27.53 (h)

For operations in the 1710 – 1755 MHz and 1710 – 1780 MHz band, the FCC limit is $43 + 10\log_{10}(P[\text{Watts}])$ dB below the transmitter power $P(\text{Watts})$ in a 1 MHz bandwidth. However, in the 1MHz bands immediately outside and adjacent to the licensee's frequency block, a resolution bandwidth of at least one percent of the emission bandwidth of the fundamental emission of the transmitter may be employed.

27.53(m)(4)

For mobile digital stations, the attenuation factor shall be not less than $40 + 10 \log (P)$ dB on all frequencies between the channel edge and 5 megahertz from the channel edge, $43 + 10 \log (P)$ dB on all frequencies between 5 megahertz and X megahertz from the channel edge, and $55 + 10 \log (P)$ dB on all frequencies more than X megahertz from the channel edge, where X is the greater of 6 megahertz or the actual emission bandwidth as defined in paragraph (m)(6) of this section. In addition, the attenuation factor shall not be less that $43 + 10 \log (P)$ dB on all frequencies between 2490.5 MHz and 2496 MHz and $55 + 10 \log (P)$ dB at or below 2490.5 MHz. Mobile Satellite Service licensees operating on frequencies below 2495 MHz may also submit a documented interference complaint against BRS licensees operating on channel BRS Channel 1 on the same terms and conditions as adjacent channel BRS or EBS licensees.



3.7.2 Test Procedures

1. The testing follows ANSI C63.26 section 5.7
2. The EUT was connected to spectrum analyzer and system simulator via a power divider.
3. The band edges of low and high channels for the highest RF powers were measured.
4. Set RBW \geq 1%/2% EBW in the 1MHz band immediately outside and adjacent to the band edge.
5. Beyond the 1 MHz band from the band edge, RBW=1MHz was used.
6. Set spectrum analyzer with RMS detector.
7. The RF fundamental frequency should be excluded against the limit line in the operating frequency band.
8. Offset has included the duty factor for Band n38. Duty factor = $10 \log(1/x)$, where x is the measured duty cycle
9. Checked that all the results comply with the emission limit line.

Example:

The limit line is derived from $43 + 10\log(P)$ dB below the transmitter power P(Watts)
= $P(W) - [43 + 10\log(P)]$ (dB)
= $[30 + 10\log(P)]$ (dBm) - $[43 + 10\log(P)]$ (dB) = -13dBm.

10. For 5G NR n7/n38, the other 40 dB, and 55 dB have additionally applied same calculation above.
11. When using the integration method, the starting frequency of the integration shall be centered at one-half of the RBW away from the band edge.



3.8 Conducted Spurious Emission

3.8.1 Description of Conducted Spurious Emission Measurement

The power of any emission outside of the authorized operating frequency ranges must be lower than the transmitter power (P) by a factor of at least $43 + 10 \log (P)$ dB.

For 5G NR n7/n38:

The power of any emission outside of the authorized operating frequency ranges must be lower than the transmitter power (P) by a factor of at least $55 + 10 \log (P)$ dB.

It is measured by means of a calibrated spectrum analyzer and scanned from 30 MHz up to a frequency including its 10th harmonic.

3.8.2 Test Procedures

1. The testing follows ANSI C63.26 section 5.7
2. The EUT was connected to spectrum analyzer and system simulator via a power divider.
3. The RF output of EUT was connected to the spectrum analyzer by RF cable and attenuator. The path loss was compensated to the results for each measurement.
4. The middle channel for the highest RF power within the transmitting frequency was measured.
5. The conducted spurious emission for the whole frequency range was taken.
6. Make the measurement with the spectrum analyzer's RBW = 1MHz, VBW = 3MHz.
7. Set spectrum analyzer with RMS detector.
8. Offset has included the duty factor for Band n38. Duty factor = $10 \log (1/x)$, where x is the measured duty cycle
9. Taking the record of maximum spurious emission.
10. The RF fundamental frequency should be excluded against the limit line in the operating frequency band.
11. The limit line is derived from $43 + 10 \log(P)$ dB below the transmitter power P(Watts)
= $P(W) - [43 + 10 \log(P)]$ (dB)
= $[30 + 10 \log(P)]$ (dBm) - $[43 + 10 \log(P)]$ (dB)
= -13dBm.
12. For 5G NR n7/n38
The limit line is derived from $55 + 10 \log(P)$ dB below the transmitter power P(Watts)
= $P(W) - [55 + 10 \log(P)]$ (dB)
= $[30 + 10 \log(P)]$ (dBm) - $[55 + 10 \log(P)]$ (dB)
= -25dBm.



3.9 Frequency Stability

3.9.1 Description of Frequency Stability Measurement

The frequency stability shall be measured by variation of ambient temperature and variation of primary supply voltage to ensure that the fundamental emission stays within the authorized frequency block. The frequency stability of the transmitter shall be maintained within $\pm 0.00025\%$ ($\pm 2.5\text{ppm}$) of the center frequency.

3.9.2 Test Procedures for Temperature Variation

1. The testing follows ANSI C63.26 section 5.6.4
2. The EUT was set up in the thermal chamber and connected with the system simulator.
3. With power OFF, the temperature was decreased to -30°C and the EUT was stabilized before testing. Power was applied and the maximum change in frequency was recorded within one minute.
4. With power OFF, the temperature was raised in 10°C step up to 50°C . The EUT was stabilized at each step for at least half an hour. Power was applied and the maximum frequency change was recorded within one minute.

3.9.3 Test Procedures for Voltage Variation

1. The testing follows ANSI C63.26 section 5.6.5
2. The EUT was placed in a temperature chamber at $20\pm 5^{\circ}\text{C}$ and connected with the system simulator.
3. The power supply voltage to the EUT was varied from 85% to 115% of the nominal value for other than hand carried battery equipment.
4. For hand carried, battery powered equipment, reduce the primary ac or dc supply voltage to the battery operating end point, which shall be specified by the manufacturer.
5. The variation in frequency was measured for the worst case.

4 Radiated Test Items

4.1 Measuring Instruments

See list of measuring instruments of this test report.

4.2 Test Setup

4.2.1 For radiated test below 30MHz

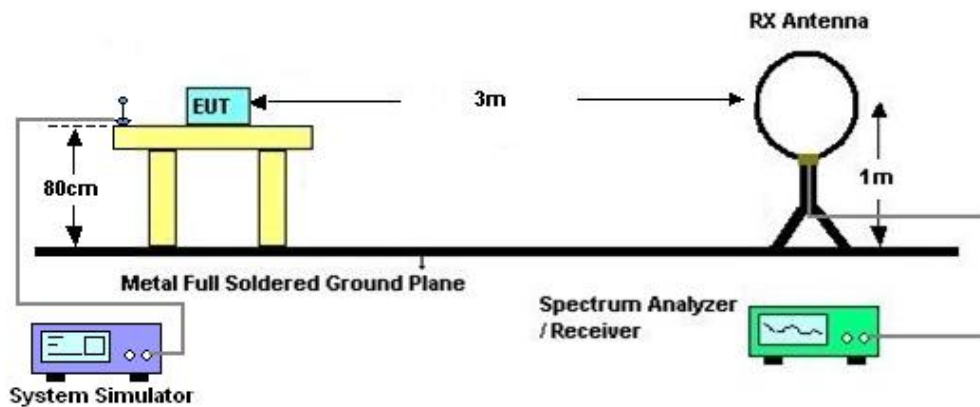

4.2.2 For radiated test from 30MHz to 1GHz

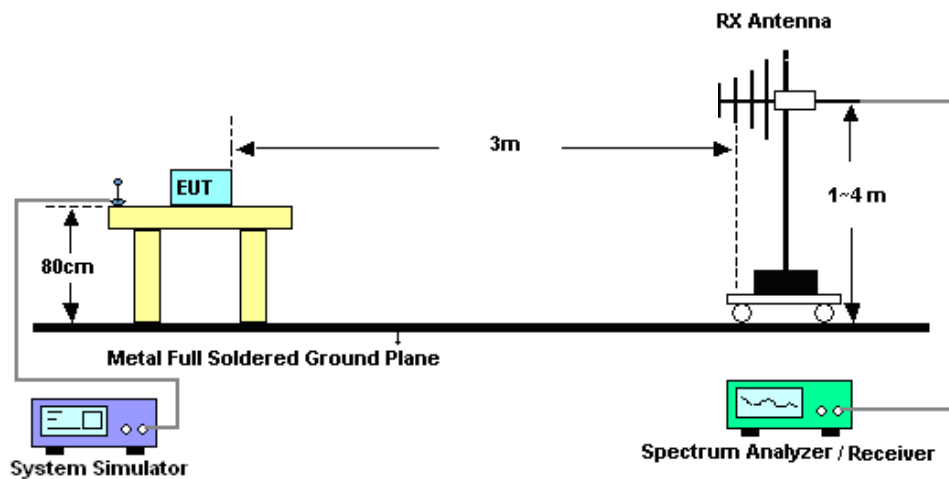

4.2.3 For radiated test above 1GHz

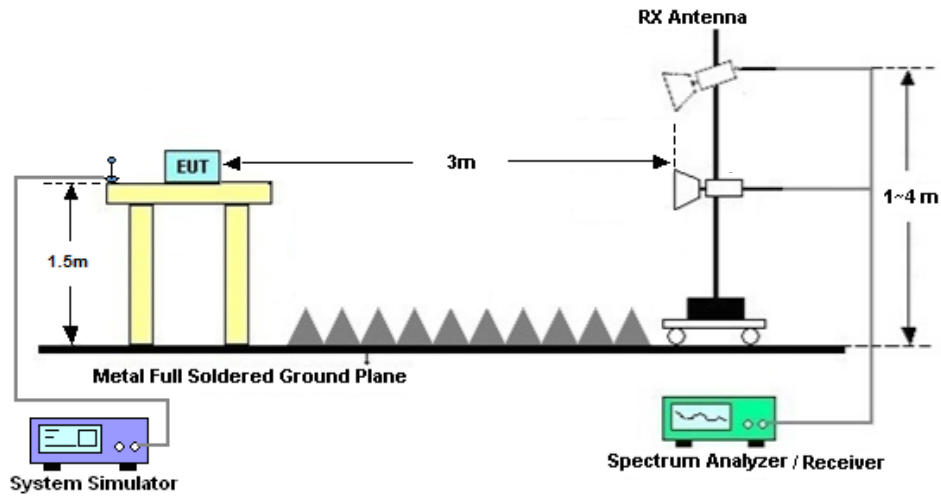

4.3 Test Result of Radiated Test

The low frequency, which started from 9 kHz to 30MHz, was pre-scanned and the result which was 20dB lower than the limit line was not reported.

Please refer to Appendix B.



4.4 Radiated Spurious Emission

4.4.1 Description of Radiated Spurious Emission

The radiated spurious emission was measured by substitution method according to ANSI C63.26. The power of any emission outside of the authorized operating frequency ranges must be attenuated below the transmitter power (P) by a factor of at least $43 + 10 \log (P)$ dB.

For 5G NR n7/n38

The power of any emission outside of the authorized operating frequency ranges must be attenuated below the transmitter power (P) by a factor of at least $55 + 10 \log (P)$ dB.

The spectrum is scanned from 30 MHz up to a frequency including its 10th harmonic.

4.4.2 Test Procedures

1. The testing follows ANSI C63.26 Section 5.5
2. The EUT was placed on a turntable with 0.8 meter height for frequency below 1GHz and 1.5 meter height for frequency above 1GHz respectively above ground.
3. The EUT was set 3 meters from the receiving antenna mounted on the antenna tower.
4. The table was rotated 360 degrees to determine the position of the highest spurious emission.
5. The height of the receiving antenna is varied between 1m to 4m to search the maximum spurious emission for both horizontal and vertical polarizations.
6. During the measurement, the system simulator parameters were set to force the EUT transmitting at maximum output power.
7. Make the measurement with the spectrum analyzer's RBW = 1MHz, VBW = 3MHz, taking the record of maximum spurious emission.
8. A horn antenna was substituted in place of the EUT and was driven by a signal generator.
9. Tune the output power of signal generator to the same emission level with EUT maximum spurious emission.
10. $EIRP (dBm) = S.G. Power - Tx Cable Loss + Tx Antenna Gain$
11. $ERP (dBm) = EIRP - 2.15$
12. The RF fundamental frequency should be excluded against the limit line in the operating frequency band.

The limit line is derived from $43 + 10\log(P)$ dB below the transmitter power P(Watts)
 $= P(W) - [43 + 10\log(P)] (dB)$
 $= [30 + 10\log(P)] (dBm) - [43 + 10\log(P)] (dB)$
 $= -13dBm.$

13. For 5G NR n7/n38:

The limit line is derived from $55 + 10\log(P)$ dB below the transmitter power P(Watts)The limit line is derived from $55 + 10\log(P)$ dB below the transmitter power P(Watts)



5 List of Measuring Equipment

Instrument	Manufacturer	Model No.	Serial No.	Characteristics	Calibration Date	Test Date	Due Date	Remark
EXA Signal Analyzer	KEYSIGHT	N9010B	MY60240803	10Hz~44GHz	Apr. 02, 2022	Jun. 26, 2022~ Jul. 06, 2022	Apr. 01, 2023	Conducted (TH01-SZ)
Power Divider	TOJOIN	PS-2SM-04 265	60.06.020.007 7	0.4GHz~26.5GHz	Dec. 25, 2021	Jun. 26, 2022~ Jul. 06, 2022	Dec. 24, 2022	Conducted (TH01-SZ)
Thermal Chamber	Ten Billion Hongzhangroup	LP-150U	H2014081803	-40~+150°C	Jul. 14, 2021	Jun. 26, 2022~ Jul. 06, 2022	Jul. 13, 2022	Conducted (TH01-SZ)
EXA Spectrum Analyzer	KEYSIGHT	N9010A	MY55150213	10Hz~44GHz	Jul. 14, 2021	Jul. 02, 2022	Jul. 13, 2022	Radiation (03CH02-SZ)
Loop Antenna	R&S	HFH2-Z2	100354	9kHz~30MHz	Jun. 21, 2022	Jul. 02, 2022	Jun. 20, 2023	Radiation (03CH02-SZ)
Bilog Antenna	TeseQ	CBL6112D	35407	30MHz-2GHz	Sep. 28, 2021	Jul. 02, 2022	Sep. 27, 2022	Radiation (03CH02-SZ)
Double Ridge Horn Antenna	ETS-Lindgren	3117	00119436	1GHz~18GHz	Jul. 18, 2021	Jul. 02, 2022	Jul. 17, 2022	Radiation (03CH02-SZ)
HF Amplifier	MITEQ	TTA1840-35 -HG	1871923	18GHz~40GHz	Jul. 13, 2021	Jul. 02, 2022	Jul. 12, 2022	Radiation (03CH02-SZ)
SHF-EHF Horn	com-power	AH-840	101071	18Ghz-40GHz	Apr. 11, 2022	Jul. 02, 2022	Apr. 10, 2023	Radiation (03CH02-SZ)
LF Amplifier	Burgeon	BPA-530	102211	0.01~3000Mhz	Oct. 22, 2021	Jul. 02, 2022	Oct. 21, 2022	Radiation (03CH02-SZ)
HF Amplifier	KEYSIGHT	83017A	MY53270105	0.5GHz~26.5Ghz	Oct. 22, 2021	Jul. 02, 2022	Oct. 21, 2022	Radiation (03CH02-SZ)
AC Power Source	Chroma	61601	616010002470	N/A	NCR	Jul. 02, 2022	NCR	Radiation (03CH02-SZ)
Turn Table	Chaintek	T-200	N/A	0~360 degree	NCR	Jul. 02, 2022	NCR	Radiation (03CH02-SZ)
Antenna Mast	Chaintek	MBS-400	N/A	1 m~4 m	NCR	Jul. 02, 2022	NCR	Radiation (03CH02-SZ)

NCR: No Calibration Required



6 Uncertainty of Evaluation

The measurement uncertainties shown below were calculated in accordance with the requirements of ANSI 63.26-2015. All the measurement uncertainty value were shown with a coverage K=2 to indicate 95% level of confidence. The measurement data show herein meets or exceeds the CISPR measurement uncertainty values specified in CISPR 16-4-2 and can be compared directly to specified limit to determine compliance.

Uncertainty of Conducted Measurement

Test Item	Uncertainty
Conducted Power	±1.34 dB
Conducted Emissions	±1.34 dB
Occupied Channel Bandwidth	±0.13 %

Uncertainty of Radiated Emission Measurement (30 MHz ~ 1000 MHz)

Measuring Uncertainty for a Level of Confidence of 95% (U = 2Uc(y))	2.47dB
---	--------

Uncertainty of Radiated Emission Measurement (1 GHz ~ 18 GHz)

Measuring Uncertainty for a Level of Confidence of 95% (U = 2Uc(y))	3.31dB
---	--------

Uncertainty of Radiated Emission Measurement (18 GHz ~ 40 GHz)

Measuring Uncertainty for a Level of Confidence of 95% (U = 2Uc(y))	3.72dB
---	--------

----- THE END -----



Appendix A. Test Results of Conducted Test

Test Engineer :	Jung Kuo	Temperature :	22~23°C
		Relative Humidity :	40~42%

FR1 N2(ANT0)

LTE Band: 7(ANT1), LTE BW: 10M, LTE ARFCN: Mid

Transmitter Conducted Output Power And EIRP, ($G_T - L_C$)= -1.2dBi

NR Band	SCS (kHz)	Bandwidth (MHz)	Arfcn	Freq (MHz)	Modulation	RB	Conducted Power (dBm)	EIRP (dBm)	EIRP (W)
2	15	5	386500	1852.5	DFT-s-OFDM QPSK	1@1	22.85	21.65	0.1462
2	15	5	386500	1852.5	DFT-s-OFDM 16 QAM	1@1	21.98	20.78	0.1197
2	15	5	392000	1880	DFT-s-OFDM QPSK	1@1	23.04	21.84	0.1528
2	15	5	392000	1880	DFT-s-OFDM 16 QAM	1@1	22.21	21.01	0.1262
2	15	5	397500	1907.5	DFT-s-OFDM QPSK	1@1	22.73	21.53	0.1422
2	15	5	397500	1907.5	DFT-s-OFDM 16 QAM	1@1	21.85	20.65	0.1161
2	15	10	387000	1855	DFT-s-OFDM QPSK	1@1	22.99	21.79	0.1510
2	15	10	387000	1855	DFT-s-OFDM 16 QAM	1@1	21.93	20.73	0.1183
2	15	10	392000	1880	DFT-s-OFDM QPSK	1@1	23.15	21.95	0.1567
2	15	10	392000	1880	DFT-s-OFDM 16 QAM	1@1	22.25	21.05	0.1274
2	15	10	397000	1905	DFT-s-OFDM QPSK	1@1	22.82	21.62	0.1452
2	15	10	397000	1905	DFT-s-OFDM 16 QAM	1@1	21.92	20.72	0.1180
2	15	15	387500	1857.5	DFT-s-OFDM QPSK	1@1	22.91	21.71	0.1483
2	15	15	387500	1857.5	DFT-s-OFDM 16 QAM	1@1	21.97	20.77	0.1194
2	15	15	392000	1880	DFT-s-OFDM QPSK	1@1	23.03	21.83	0.1524
2	15	15	392000	1880	DFT-s-OFDM 16 QAM	1@1	22.14	20.94	0.1242
2	15	15	396500	1902.5	DFT-s-OFDM QPSK	1@1	23.1	21.9	0.1549
2	15	15	396500	1902.5	DFT-s-OFDM 16 QAM	1@1	22.24	21.04	0.1271
2	15	20	388000	1860	DFT-s-OFDM PI/2 BPSK	50@25	22.76	21.56	0.1432
2	15	20	388000	1860	DFT-s-OFDM PI/2 BPSK	1@1	22.66	21.46	0.1400
2	15	20	388000	1860	DFT-s-OFDM PI/2 BPSK	1@104	22.84	21.64	0.1459
2	15	20	388000	1860	DFT-s-OFDM QPSK	50@25	22.8	21.6	0.1445
2	15	20	388000	1860	DFT-s-OFDM QPSK	1@1	22.88	21.68	0.1472
2	15	20	388000	1860	DFT-s-OFDM QPSK	1@104	22.99	21.79	0.1510
2	15	20	388000	1860	DFT-s-OFDM 16 QAM	50@25	21.78	20.58	0.1143
2	15	20	388000	1860	DFT-s-OFDM 16 QAM	1@1	21.93	20.73	0.1183
2	15	20	388000	1860	DFT-s-OFDM 16 QAM	1@104	22.08	20.88	0.1225
2	15	20	388000	1860	DFT-s-OFDM 64 QAM	50@25	20.27	19.07	0.0807
2	15	20	388000	1860	DFT-s-OFDM 64 QAM	1@1	20.3	19.1	0.0813

2	15	20	388000	1860	DFT-s-OFDM 64 QAM	1@104	20.43	19.23	0.0838
2	15	20	388000	1860	DFT-s-OFDM 256 QAM	50@25	18.15	16.95	0.0495
2	15	20	388000	1860	DFT-s-OFDM 256 QAM	1@1	17.92	16.72	0.0470
2	15	20	388000	1860	DFT-s-OFDM 256 QAM	1@104	18.02	16.82	0.0481
2	15	20	388000	1860	CP-OFDM QPSK	53@26	21.26	20.06	0.1014
2	15	20	388000	1860	CP-OFDM QPSK	1@1	21.34	20.14	0.1033
2	15	20	388000	1860	CP-OFDM QPSK	1@104	21.41	20.21	0.1050
2	15	20	392000	1880	DFT-s-OFDM PI/2 BPSK	50@25	23.04	21.84	0.1528
2	15	20	392000	1880	DFT-s-OFDM PI/2 BPSK	1@1	22.85	21.65	0.1462
2	15	20	392000	1880	DFT-s-OFDM PI/2 BPSK	1@104	22.87	21.67	0.1469
2	15	20	392000	1880	DFT-s-OFDM QPSK	50@25	23.01	21.81	0.1517
2	15	20	392000	1880	DFT-s-OFDM QPSK	1@1	22.98	21.78	0.1507
2	15	20	392000	1880	DFT-s-OFDM QPSK	1@104	23.06	21.86	0.1535
2	15	20	392000	1880	DFT-s-OFDM 16 QAM	50@25	21.99	20.79	0.1199
2	15	20	392000	1880	DFT-s-OFDM 16 QAM	1@1	22.01	20.81	0.1205
2	15	20	392000	1880	DFT-s-OFDM 16 QAM	1@104	22.08	20.88	0.1225
2	15	20	392000	1880	DFT-s-OFDM 64 QAM	50@25	20.52	19.32	0.0855
2	15	20	392000	1880	DFT-s-OFDM 64 QAM	1@1	20.45	19.25	0.0841
2	15	20	392000	1880	DFT-s-OFDM 64 QAM	1@104	20.42	19.22	0.0836
2	15	20	392000	1880	DFT-s-OFDM 256 QAM	50@25	18.38	17.18	0.0522
2	15	20	392000	1880	DFT-s-OFDM 256 QAM	1@1	18.05	16.85	0.0484
2	15	20	392000	1880	DFT-s-OFDM 256 QAM	1@104	17.99	16.79	0.0478
2	15	20	392000	1880	CP-OFDM QPSK	53@26	21.48	20.28	0.1067
2	15	20	392000	1880	CP-OFDM QPSK	1@1	21.44	20.24	0.1057
2	15	20	392000	1880	CP-OFDM QPSK	1@104	21.53	20.33	0.1079
2	15	20	396000	1900	DFT-s-OFDM PI/2 BPSK	50@25	23.08	21.88	0.1542
2	15	20	396000	1900	DFT-s-OFDM PI/2 BPSK	1@1	23.1	21.9	0.1549
2	15	20	396000	1900	DFT-s-OFDM PI/2 BPSK	1@104	23	21.8	0.1514
2	15	20	396000	1900	DFT-s-OFDM QPSK	50@25	23.06	21.86	0.1535
2	15	20	396000	1900	DFT-s-OFDM QPSK	1@1	23.2	22	0.1585
2	15	20	396000	1900	DFT-s-OFDM QPSK	1@104	23.06	21.86	0.1535
2	15	20	396000	1900	DFT-s-OFDM 16 QAM	50@25	22.04	20.84	0.1213
2	15	20	396000	1900	DFT-s-OFDM 16 QAM	1@1	22.27	21.07	0.1279
2	15	20	396000	1900	DFT-s-OFDM 16 QAM	1@104	22.13	20.93	0.1239
2	15	20	396000	1900	DFT-s-OFDM 64 QAM	50@25	20.57	19.37	0.0865
2	15	20	396000	1900	DFT-s-OFDM 64 QAM	1@1	20.67	19.47	0.0885

2	15	20	396000	1900	DFT-s-OFDM 64 QAM	1@104	20.54	19.34	0.0859
2	15	20	396000	1900	DFT-s-OFDM 256 QAM	50@25	18.46	17.26	0.0532
2	15	20	396000	1900	DFT-s-OFDM 256 QAM	1@1	18.27	17.07	0.0509
2	15	20	396000	1900	DFT-s-OFDM 256 QAM	1@104	18.09	16.89	0.0489
2	15	20	396000	1900	CP-OFDM QPSK	53@26	21.55	20.35	0.1084
2	15	20	396000	1900	CP-OFDM QPSK	1@1	21.77	20.57	0.1140
2	15	20	396000	1900	CP-OFDM QPSK	1@104	21.6	20.4	0.1096

Frequency Stability

NR Band	SCS (kHz)	Bandwidth (MHz)	Arfcn	Freq (MHz)	Modulation	RB	Deviation (ppm)	Verdict	Environment
2	15	20	392000	1880.0	DFT-s-OFDM QPSK	100@0	0.00153	PASS	NV
2	15	20	392000	1880.0	DFT-s-OFDM QPSK	100@0	0.00601	PASS	LV
2	15	20	392000	1880.0	DFT-s-OFDM QPSK	100@0	0.00666	PASS	HV
2	15	20	392000	1880.0	DFT-s-OFDM QPSK	100@0	0.00214	PASS	-30°C
2	15	20	392000	1880.0	DFT-s-OFDM QPSK	100@0	0.00539	PASS	-20°C
2	15	20	392000	1880.0	DFT-s-OFDM QPSK	100@0	0.00582	PASS	-10°C
2	15	20	392000	1880.0	DFT-s-OFDM QPSK	100@0	0.00489	PASS	0°C
2	15	20	392000	1880.0	DFT-s-OFDM QPSK	100@0	0.00391	PASS	10°C
2	15	20	392000	1880.0	DFT-s-OFDM QPSK	100@0	0.00529	PASS	20°C
2	15	20	392000	1880.0	DFT-s-OFDM QPSK	100@0	0.00641	PASS	30°C
2	15	20	392000	1880.0	DFT-s-OFDM QPSK	100@0	0.00366	PASS	40°C
2	15	20	392000	1880.0	DFT-s-OFDM QPSK	100@0	0.00374	PASS	50°C

Peak to Average Ratio

NR Band	SCS (kHz)	Bandwidth (MHz)	Arfcn	Freq (MHz)	Modulation	RB	Result (dB)	Limit (dB)	Verdict
2	15	20	388000	1860.0	DFT-s-OFDM PI/2 BPSK	100@0	3.97	13	PASS
2	15	20	388000	1860.0	DFT-s-OFDM PI/2 BPSK	1@0	3.26	13	PASS
2	15	20	388000	1860.0	DFT-s-OFDM QPSK	100@0	4.85	13	PASS
2	15	20	388000	1860.0	DFT-s-OFDM QPSK	1@0	3.53	13	PASS
2	15	20	392000	1880.0	DFT-s-OFDM PI/2 BPSK	100@0	3.69	13	PASS
2	15	20	392000	1880.0	DFT-s-OFDM PI/2 BPSK	1@0	3.18	13	PASS
2	15	20	392000	1880.0	DFT-s-OFDM QPSK	100@0	4.71	13	PASS
2	15	20	392000	1880.0	DFT-s-OFDM QPSK	1@0	3.52	13	PASS
2	15	20	396000	1900.0	DFT-s-OFDM PI/2 BPSK	100@0	3.85	13	PASS
2	15	20	396000	1900.0	DFT-s-OFDM PI/2 BPSK	1@0	3.31	13	PASS
2	15	20	396000	1900.0	DFT-s-OFDM QPSK	100@0	4.56	13	PASS
2	15	20	396000	1900.0	DFT-s-OFDM QPSK	1@0	3.56	13	PASS

B7_N2(20M)_DFT-s-OFDM_PI_2-BPSK_Outer_Full_Low_CH



B7_N2(20M)_DFT-s-OFDM_PI_2-BPSK_Edge_1RB_Left_Low_CH



B7_N2(20M)_DFT-s-OFDM_QPSK_Outer_Full_Low_CH



B7_N2(20M)_DFT-s-OFDM_QPSK_Edge_1RB_Left_Low_CH

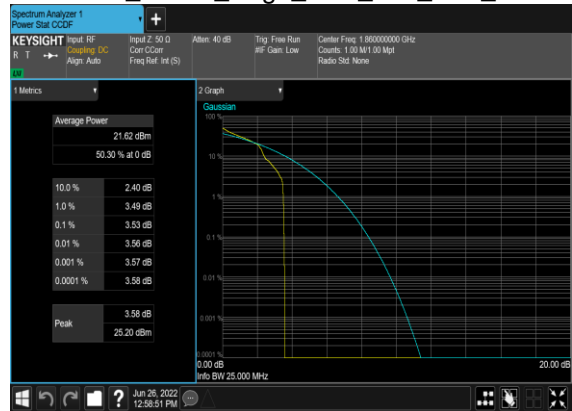

B7_N2(20M)_DFT-s-OFDM_PI_2-BPSK_Outer_Full_Mid_CH

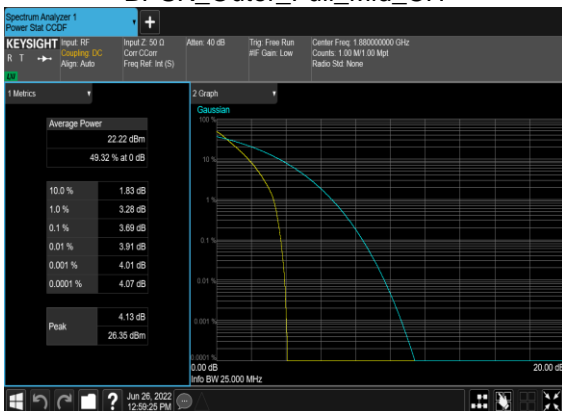

B7_N2(20M)_DFT-s-OFDM_PI_2-BPSK_Edge_1RB_Left_Mid_CH

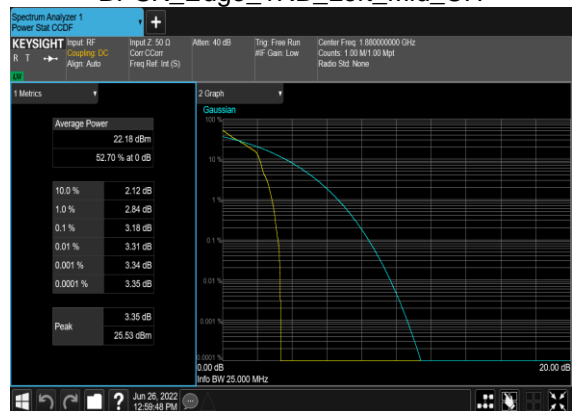

B7_N2(20M)_DFT-s-OFDM_QPSK_Outer_Full_Mid_CH



B7_N2(20M)_DFT-s-OFDM_QPSK_Edge_1RB_Left_Mid_CH

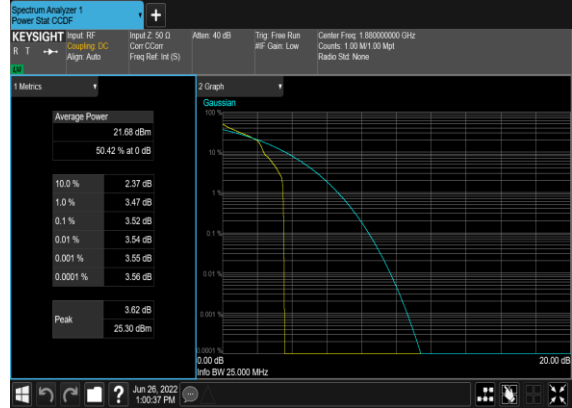

B7_N2(20M)_DFT-s-OFDM_PI_2-BPSK_Outer_Full_High_CH

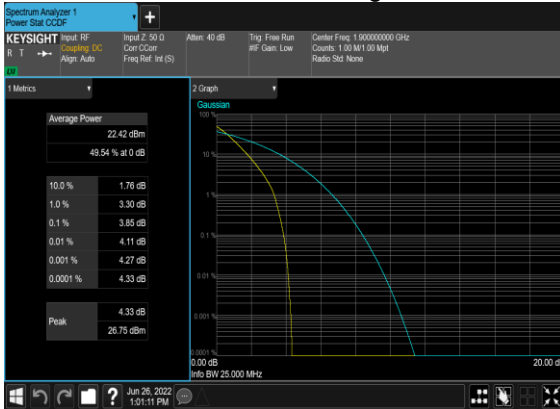

B7_N2(20M)_DFT-s-OFDM_PI_2-BPSK_Edge_1RB_Left_High_CH

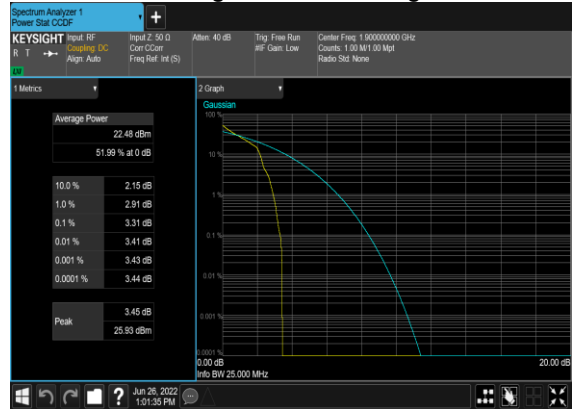

B7_N2(20M)_DFT-s-OFDM_QPSK_Outer_Full_High_CH

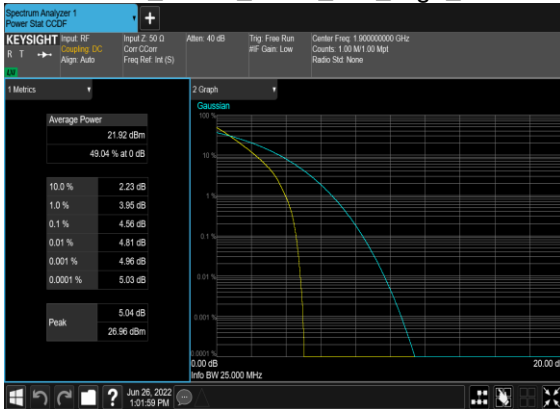

B7_N2(20M)_DFT-s-OFDM_QPSK_Edge_1RB_Left_High_CH



Occupied Bandwidth

NR Band	SCS (kHz)	Bandwidth (MHz)	Arfcn	Freq (MHz)	Modulation	RB	OBW (MHz)	26dB OBW (MHz)
2	15	5	392000	1880.0	DFT-s-OFDM PI/2 BPSK	25@0	4.4683	4.864
2	15	5	392000	1880.0	DFT-s-OFDM QPSK	25@0	4.4678	4.828
2	15	5	392000	1880.0	CP-OFDM QPSK	25@0	4.4706	4.904
2	15	5	392000	1880.0	CP-OFDM 16 QAM	25@0	4.4884	4.956
2	15	5	392000	1880.0	CP-OFDM 64 QAM	25@0	4.4813	4.978
2	15	5	392000	1880.0	CP-OFDM 256 QAM	25@0	4.4677	4.915
2	15	10	392000	1880.0	DFT-s-OFDM PI/2 BPSK	50@0	8.891	9.478
2	15	10	392000	1880.0	DFT-s-OFDM QPSK	50@0	8.9155	9.544
2	15	10	392000	1880.0	CP-OFDM QPSK	52@0	9.2936	9.902
2	15	10	392000	1880.0	CP-OFDM 16 QAM	52@0	9.2727	9.886
2	15	10	392000	1880.0	CP-OFDM 64 QAM	52@0	9.2762	9.889
2	15	10	392000	1880.0	CP-OFDM 256 QAM	52@0	9.2986	9.933
2	15	15	392000	1880.0	DFT-s-OFDM PI/2 BPSK	75@0	13.395	14.12
2	15	15	392000	1880.0	DFT-s-OFDM QPSK	75@0	13.379	14.04
2	15	15	392000	1880.0	CP-OFDM QPSK	79@0	14.1	14.8
2	15	15	392000	1880.0	CP-OFDM 16 QAM	79@0	14.113	14.92
2	15	15	392000	1880.0	CP-OFDM 64 QAM	79@0	14.117	14.78
2	15	15	392000	1880.0	CP-OFDM 256 QAM	79@0	14.075	14.82
2	15	20	392000	1880.0	DFT-s-OFDM PI/2 BPSK	100@0	17.871	18.68
2	15	20	392000	1880.0	DFT-s-OFDM QPSK	100@0	17.858	18.7
2	15	20	392000	1880.0	CP-OFDM QPSK	106@0	18.943	19.84
2	15	20	392000	1880.0	CP-OFDM 16 QAM	106@0	18.93	19.88
2	15	20	392000	1880.0	CP-OFDM 64 QAM	106@0	18.938	19.78
2	15	20	392000	1880.0	CP-OFDM 256 QAM	106@0	18.984	19.79

B7_N2(5M)_DFT-s-OFDM_PI_2-
BPSK_Outer_Full_Mid_CH

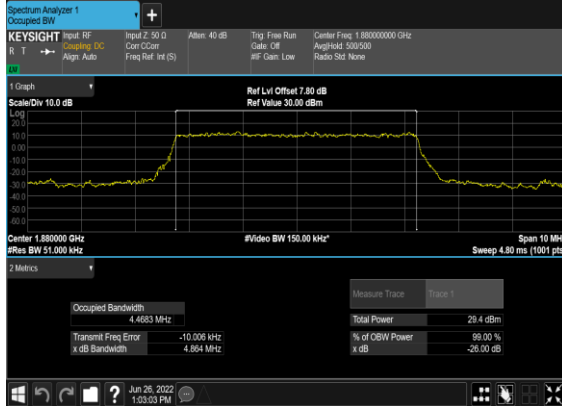

B7_N2(5M)_DFT-s-
OFDM_QPSK_Outer_Full_Mid_CH



B7_N2(5M)_CP-
OFDM_QPSK_Outer_Full_Mid_CH

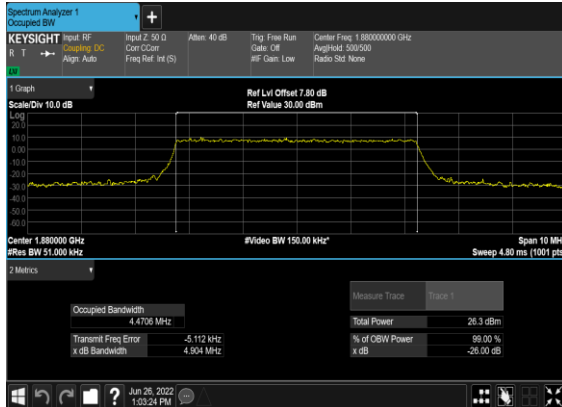

B7_N2(5M)_CP-OFDM_16
QAM_Outer_Full_Mid_CH

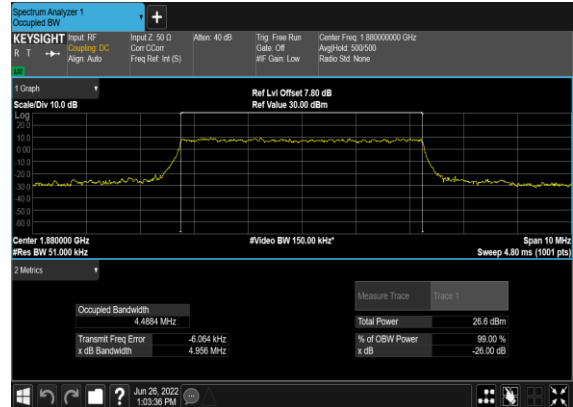

B7_N2(5M)_CP-OFDM_64
QAM_Outer_Full_Mid_CH

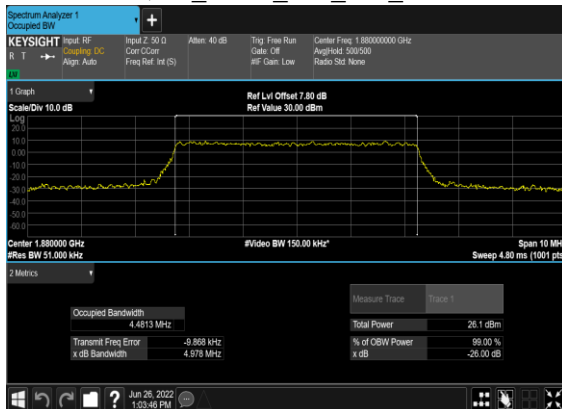

B7_N2(5M)_CP-OFDM_256
QAM_Outer_Full_Mid_CH

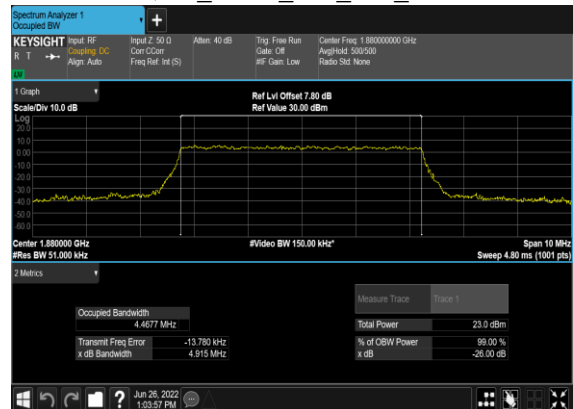

B7_N2(10M)_DFT-s-OFDM_PI_2-
BPSK_Outer_Full_Mid_CH



B7_N2(10M)_DFT-s-
OFDM_QPSK_Outer_Full_Mid_CH

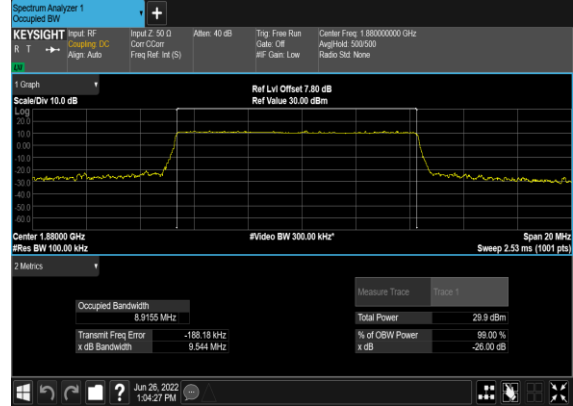

B7_N2(10M)_CP-
OFDM_QPSK_Outer_Full_Mid_CH



B7_N2(10M)_CP-OFDM_16
QAM_Outer_Full_Mid_CH

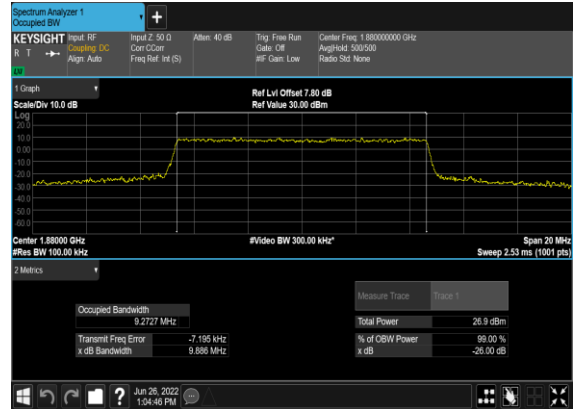

B7_N2(10M)_CP-OFDM_64
QAM_Outer_Full_Mid_CH

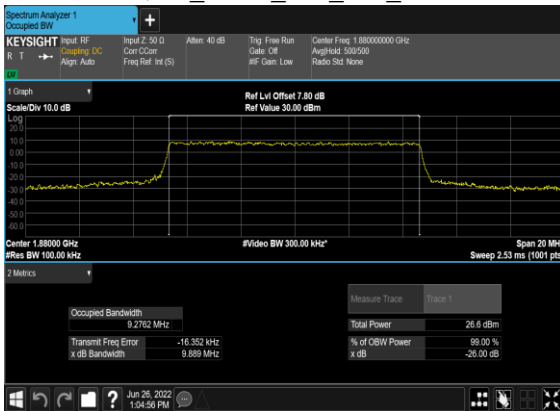

B7_N2(10M)_CP-OFDM_256
QAM_Outer_Full_Mid_CH

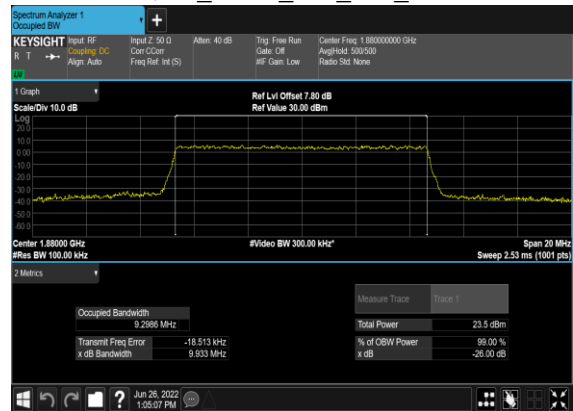

B7_N2(15M)_DFT-s-OFDM_PI_2-
BPSK_Outer_Full_Mid_CH

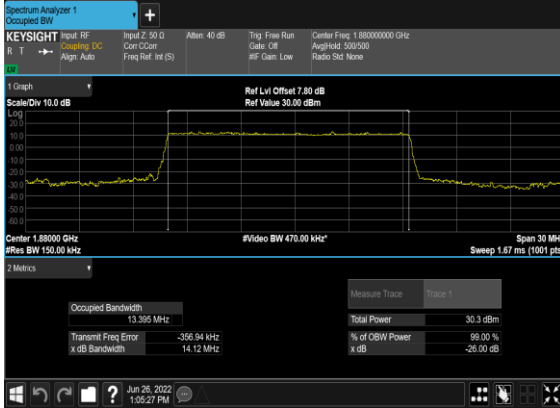

B7_N2(15M)_DFT-s-
OFDM_QPSK_Outer_Full_Mid_CH



B7_N2(15M)_CP-
OFDM_QPSK_Outer_Full_Mid_CH



B7_N2(15M)_CP-OFDM_16
QAM_Outer_Full_Mid_CH



B7_N2(15M)_CP-OFDM_64
QAM_Outer_Full_Mid_CH

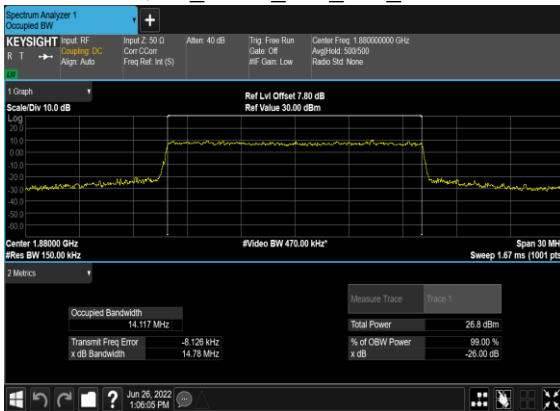

B7_N2(15M)_CP-OFDM_256
QAM_Outer_Full_Mid_CH

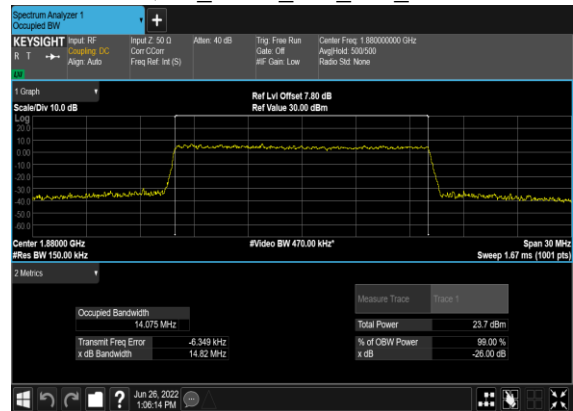

B7_N2(20M)_DFT-s-OFDM_PI_2-
BPSK_Outer_Full_Mid_CH

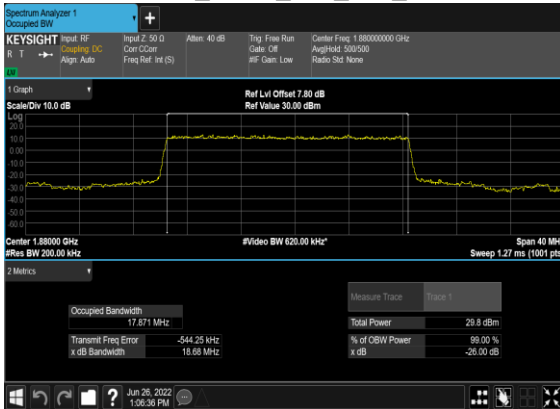

B7_N2(20M)_DFT-s-
OFDM_QPSK_Outer_Full_Mid_CH

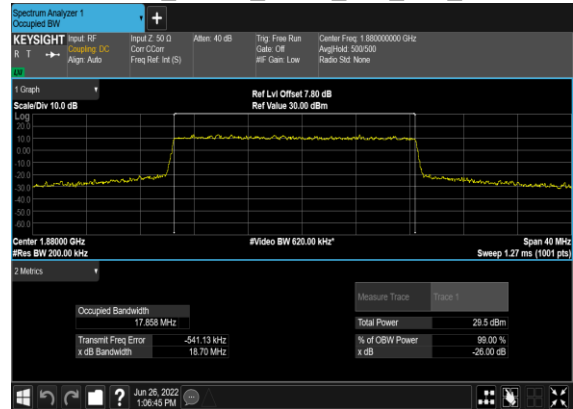

B7_N2(20M)_CP-
OFDM_QPSK_Outer_Full_Mid_CH

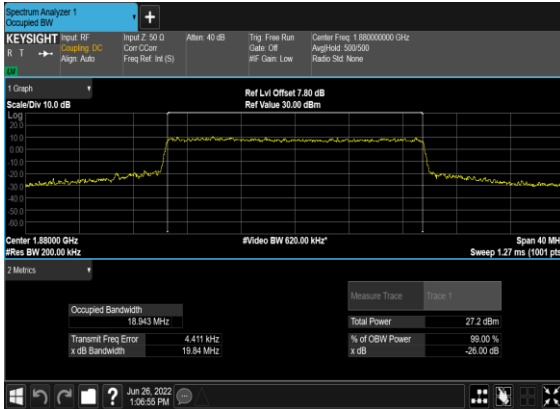

B7_N2(20M)_CP-OFDM_16
QAM_Outer_Full_Mid_CH



B7_N2(20M)_CP-OFDM_64
QAM_Outer_Full_Mid_CH

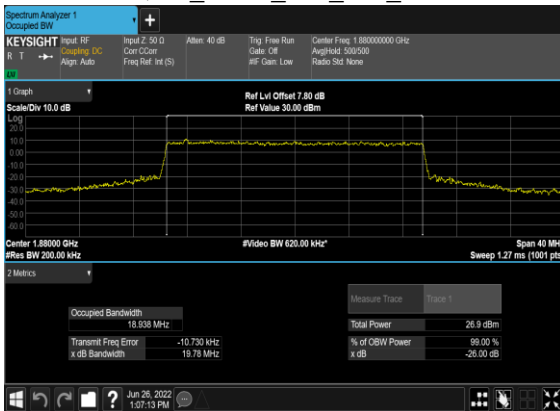

B7_N2(20M)_CP-OFDM_256
QAM_Outer_Full_Mid_CH

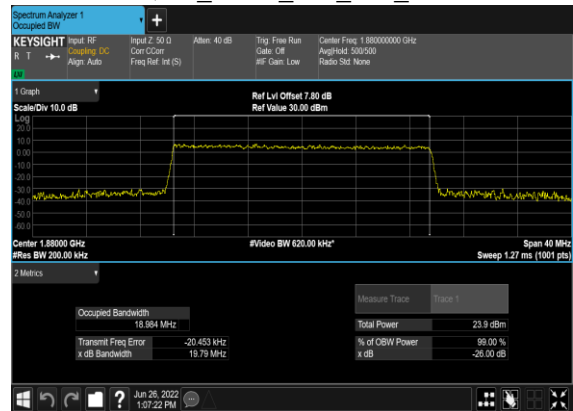

Conducted Spurious Emissions

NR Band	SCS (kHz)	Bandwidth (MHz)	Arfcn	Freq (MHz)	Modulation	RB	Result	Verdict
2	15	5	386500	1852.5	DFT-s-OFDM BPSK	1@0	see graph	---
2	15	5	386500	1852.5	DFT-s-OFDM BPSK	1@0	see graph	PASS
2	15	5	386500	1852.5	DFT-s-OFDM QPSK	1@0	see graph	---
2	15	5	386500	1852.5	DFT-s-OFDM QPSK	1@0	see graph	PASS
2	15	5	392000	1880.0	DFT-s-OFDM BPSK	1@0	see graph	---
2	15	5	392000	1880.0	DFT-s-OFDM BPSK	1@0	see graph	PASS
2	15	5	392000	1880.0	DFT-s-OFDM QPSK	1@0	see graph	---
2	15	5	392000	1880.0	DFT-s-OFDM QPSK	1@0	see graph	PASS
2	15	5	397500	1907.5	DFT-s-OFDM BPSK	1@0	see graph	---
2	15	5	397500	1907.5	DFT-s-OFDM BPSK	1@0	see graph	PASS
2	15	5	397500	1907.5	DFT-s-OFDM QPSK	1@0	see graph	---
2	15	5	397500	1907.5	DFT-s-OFDM QPSK	1@0	see graph	PASS
2	15	10	387000	1855.0	DFT-s-OFDM BPSK	1@0	see graph	---
2	15	10	387000	1855.0	DFT-s-OFDM BPSK	1@0	see graph	PASS
2	15	10	387000	1855.0	DFT-s-OFDM QPSK	1@0	see graph	---
2	15	10	387000	1855.0	DFT-s-OFDM QPSK	1@0	see graph	PASS
2	15	10	392000	1880.0	DFT-s-OFDM BPSK	1@0	see graph	---
2	15	10	392000	1880.0	DFT-s-OFDM BPSK	1@0	see graph	PASS
2	15	10	392000	1880.0	DFT-s-OFDM QPSK	1@0	see graph	---
2	15	10	392000	1880.0	DFT-s-OFDM QPSK	1@0	see graph	PASS
2	15	10	397000	1905.0	DFT-s-OFDM BPSK	1@0	see graph	---
2	15	10	397000	1905.0	DFT-s-OFDM BPSK	1@0	see graph	PASS

2	15	10	397000	1905.0	DFT-s-OFDM QPSK	1@0	see graph	---
2	15	10	397000	1905.0	DFT-s-OFDM QPSK	1@0	see graph	PASS
2	15	20	388000	1860.0	DFT-s-OFDM BPSK	1@0	see graph	---
2	15	20	388000	1860.0	DFT-s-OFDM BPSK	1@0	see graph	PASS
2	15	20	388000	1860.0	DFT-s-OFDM QPSK	1@0	see graph	---
2	15	20	388000	1860.0	DFT-s-OFDM QPSK	1@0	see graph	PASS
2	15	20	392000	1880.0	DFT-s-OFDM BPSK	1@0	see graph	---
2	15	20	392000	1880.0	DFT-s-OFDM BPSK	1@0	see graph	PASS
2	15	20	392000	1880.0	DFT-s-OFDM QPSK	1@0	see graph	---
2	15	20	392000	1880.0	DFT-s-OFDM QPSK	1@0	see graph	PASS
2	15	20	396000	1900.0	DFT-s-OFDM BPSK	1@0	see graph	---
2	15	20	396000	1900.0	DFT-s-OFDM BPSK	1@0	see graph	PASS
2	15	20	396000	1900.0	DFT-s-OFDM QPSK	1@0	see graph	---
2	15	20	396000	1900.0	DFT-s-OFDM QPSK	1@0	see graph	PASS

B7_N2(5M)_DFT-s-OFDM_BPSK_Edge_1RB_Left_Low_CH

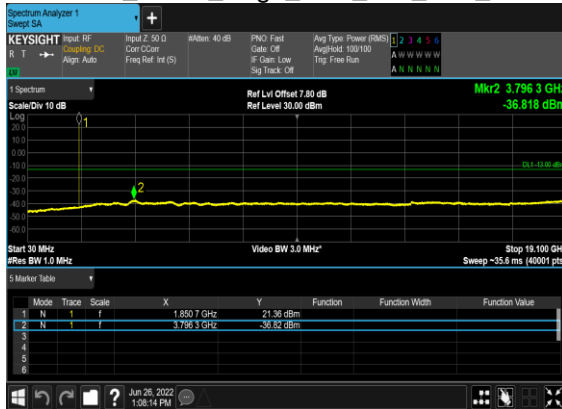

B7_N2(5M)_DFT-s-OFDM_QPSK_Edge_1RB_Left_Low_CH

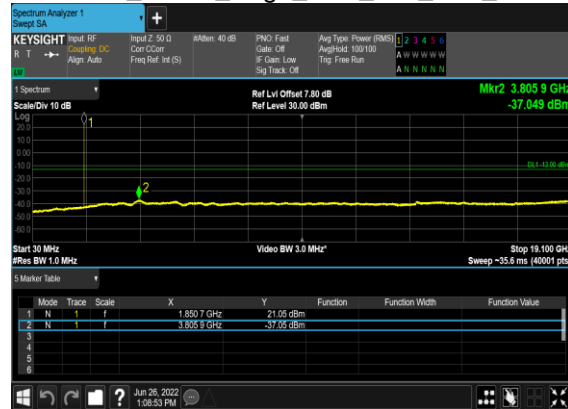

B7_N2(5M)_DFT-s-OFDM_BPSK_Edge_1RB_Left_Mid_CH

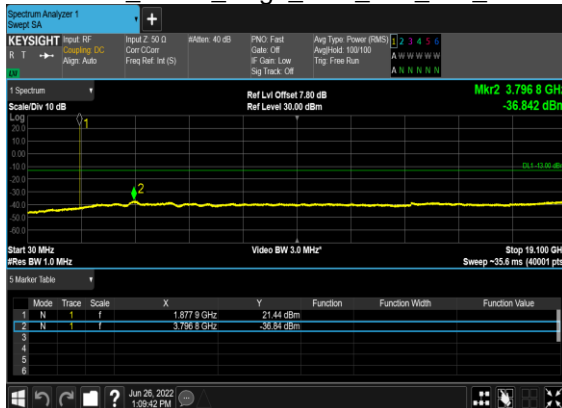

B7_N2(5M)_DFT-s-OFDM_QPSK_Edge_1RB_Left_Mid_CH

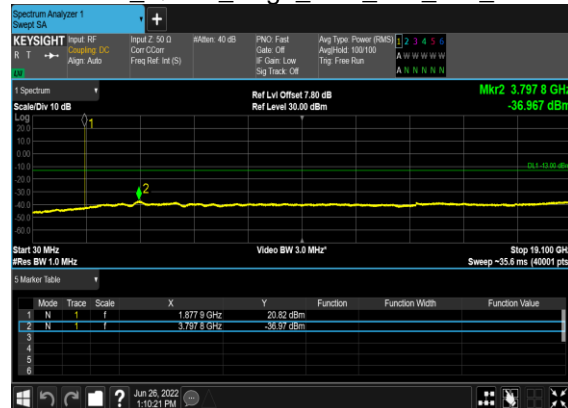

B7_N2(5M)_DFT-s-OFDM_BPSK_Edge_1RB_Left_High_CH

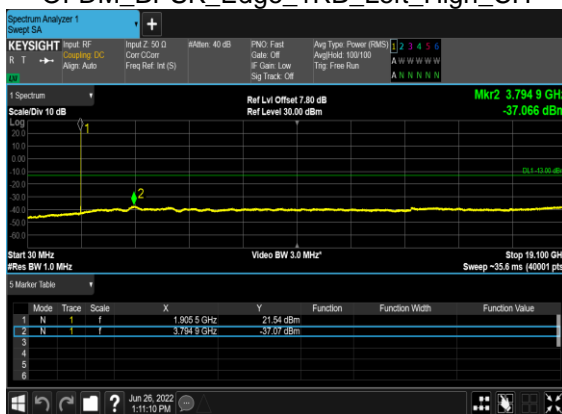

B7_N2(5M)_DFT-s-OFDM_QPSK_Edge_1RB_Left_High_CH

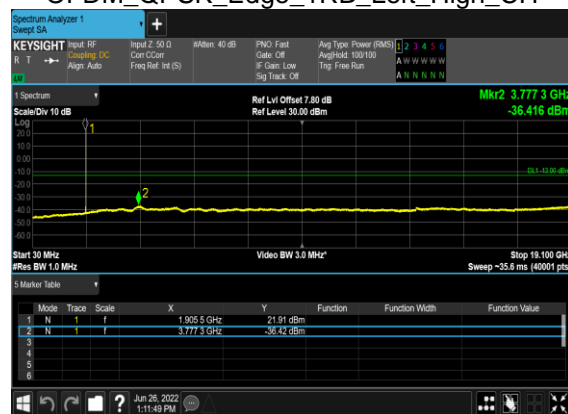

B7_N2(10M)_DFT-s-OFDM_BPSK_Edge_1RB_Left_Low_CH

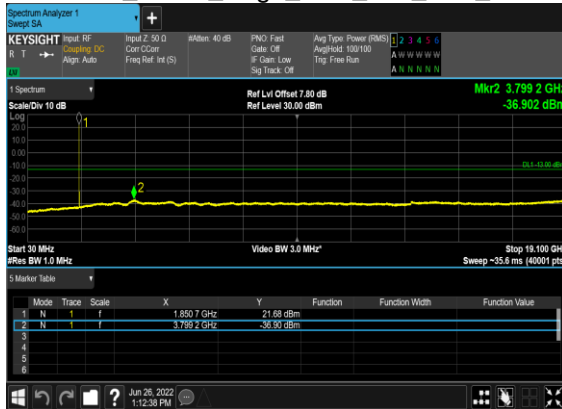

B7_N2(10M)_DFT-s-OFDM_QPSK_Edge_1RB_Left_Low_CH

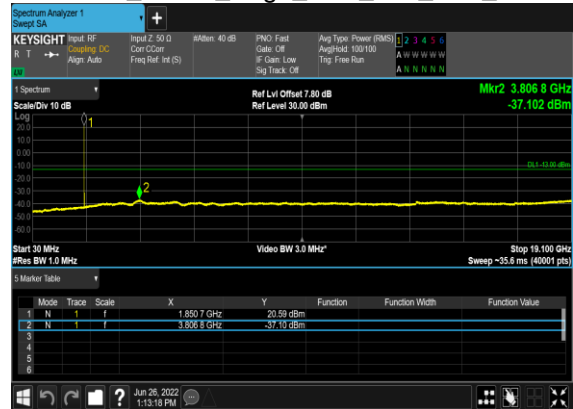

B7_N2(10M)_DFT-s-OFDM_BPSK_Edge_1RB_Left_Mid_CH

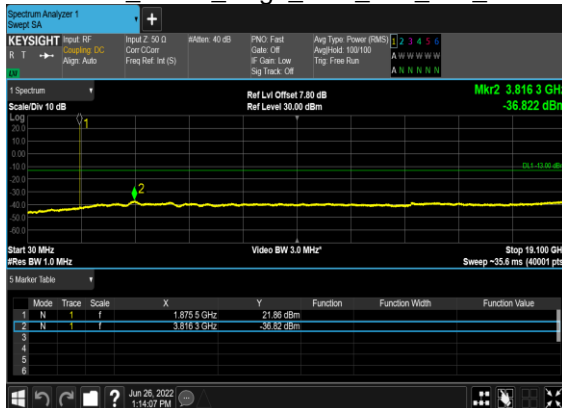

B7_N2(10M)_DFT-s-OFDM_QPSK_Edge_1RB_Left_Mid_CH

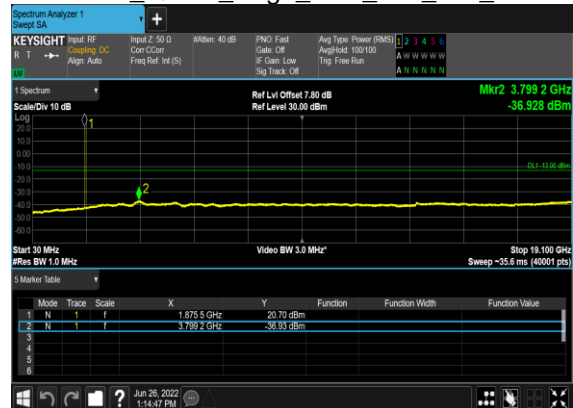

B7_N2(10M)_DFT-s-OFDM_BPSK_Edge_1RB_Left_High_CH

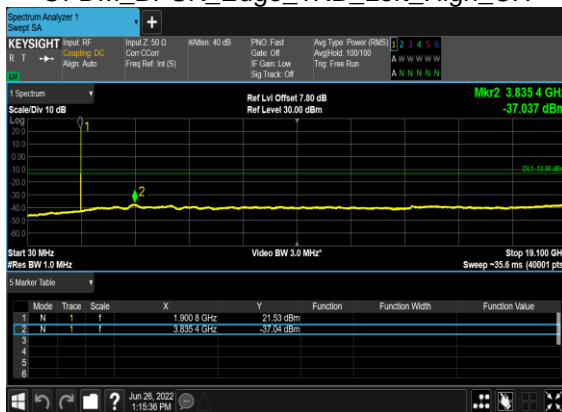

B7_N2(10M)_DFT-s-OFDM_QPSK_Edge_1RB_Left_High_CH

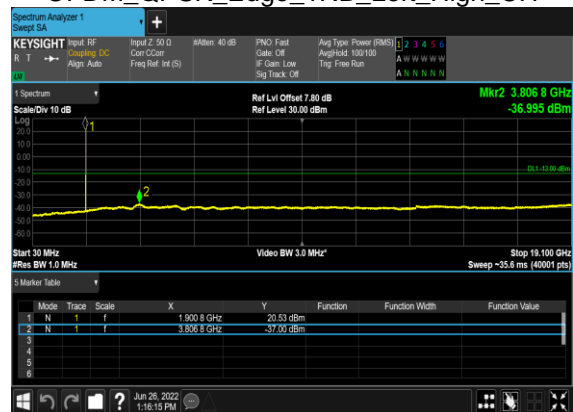

B7_N2(20M)_DFT-s-OFDM_BPSK_Edge_1RB_Left_Low_CH

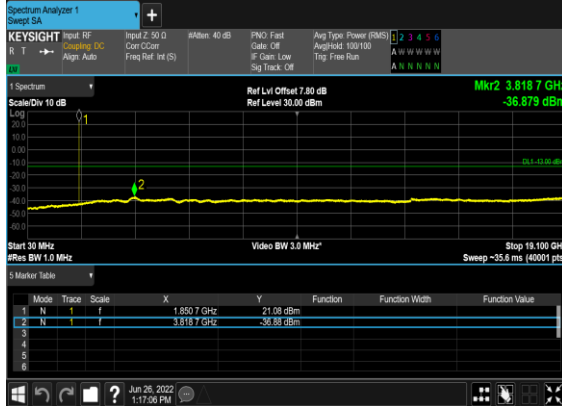

B7_N2(20M)_DFT-s-OFDM_QPSK_Edge_1RB_Left_Low_CH

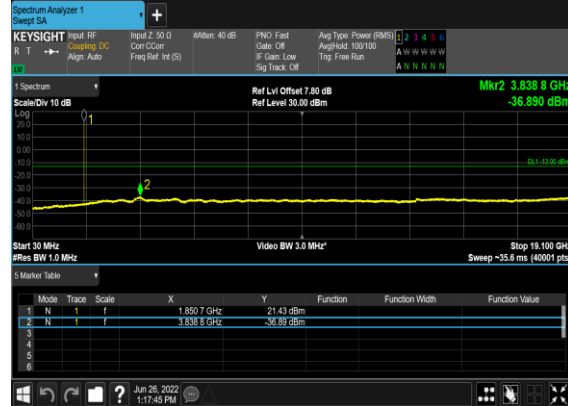

B7_N2(20M)_DFT-s-OFDM_BPSK_Edge_1RB_Left_Mid_CH

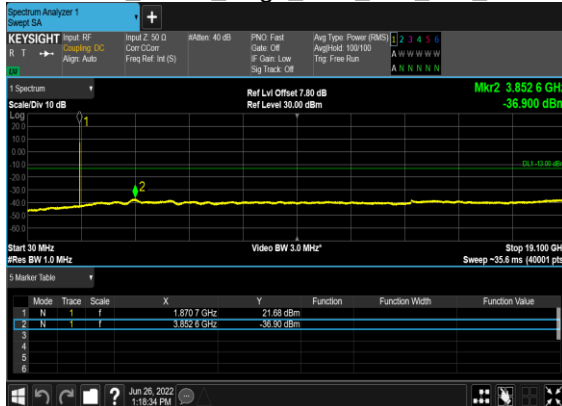

B7_N2(20M)_DFT-s-OFDM_QPSK_Edge_1RB_Left_Mid_CH

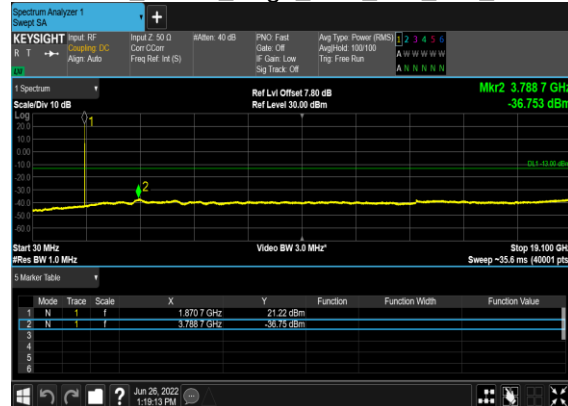

B7_N2(20M)_DFT-s-OFDM_BPSK_Edge_1RB_Left_High_CH

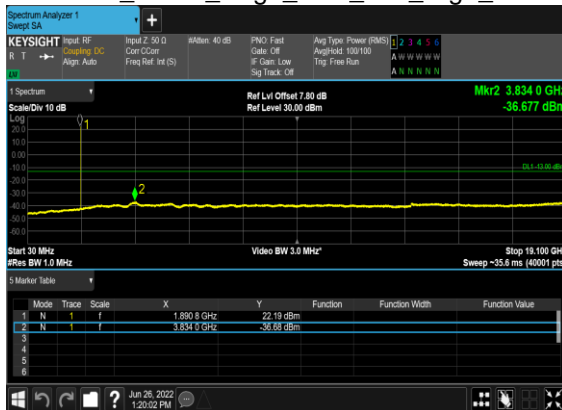

B7_N2(20M)_DFT-s-OFDM_QPSK_Edge_1RB_Left_High_CH

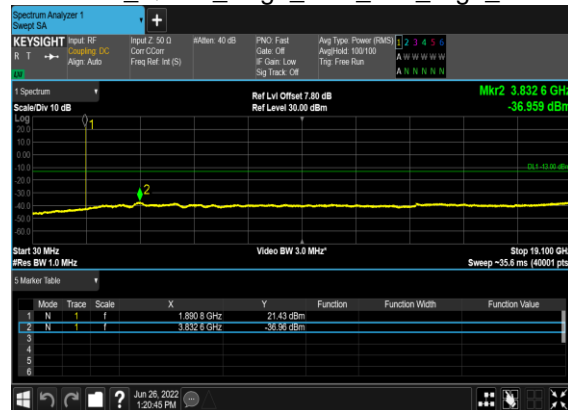

Conducted Band Edge

NR Band	SCS (kHz)	Bandwidth (MHz)	Arfcn	Freq (MHz)	Modulation	RB	Result	Verdict
2	15	5	386500	1852.5	DFT-s-OFDM BPSK	1@0	see graph	PASS
2	15	5	386500	1852.5	DFT-s-OFDM QPSK	1@0	see graph	PASS
2	15	5	386500	1852.5	DFT-s-OFDM BPSK	25@0	see graph	PASS
2	15	5	386500	1852.5	DFT-s-OFDM QPSK	25@0	see graph	PASS
2	15	5	397500	1907.5	DFT-s-OFDM BPSK	1@24	see graph	PASS
2	15	5	397500	1907.5	DFT-s-OFDM QPSK	1@24	see graph	PASS
2	15	5	397500	1907.5	DFT-s-OFDM BPSK	25@0	see graph	PASS
2	15	5	397500	1907.5	DFT-s-OFDM QPSK	25@0	see graph	PASS
2	15	10	387000	1855.0	DFT-s-OFDM BPSK	1@0	see graph	PASS
2	15	10	387000	1855.0	DFT-s-OFDM QPSK	1@0	see graph	PASS
2	15	10	387000	1855.0	DFT-s-OFDM BPSK	50@0	see graph	PASS
2	15	10	387000	1855.0	DFT-s-OFDM QPSK	50@0	see graph	PASS
2	15	10	397000	1905.0	DFT-s-OFDM BPSK	1@51	see graph	PASS
2	15	10	397000	1905.0	DFT-s-OFDM QPSK	1@51	see graph	PASS
2	15	10	397000	1905.0	DFT-s-OFDM BPSK	50@0	see graph	PASS
2	15	10	397000	1905.0	DFT-s-OFDM QPSK	50@0	see graph	PASS
2	15	20	388000	1860.0	DFT-s-OFDM BPSK	1@0	see graph	PASS
2	15	20	388000	1860.0	DFT-s-OFDM QPSK	1@0	see graph	PASS
2	15	20	388000	1860.0	DFT-s-OFDM BPSK	100@0	see graph	PASS
2	15	20	388000	1860.0	DFT-s-OFDM QPSK	100@0	see graph	PASS
2	15	20	396000	1900.0	DFT-s-OFDM BPSK	1@105	see graph	PASS
2	15	20	396000	1900.0	DFT-s-OFDM QPSK	1@105	see graph	PASS
2	15	20	396000	1900.0	DFT-s-OFDM BPSK	100@0	see graph	PASS
2	15	20	396000	1900.0	DFT-s-OFDM QPSK	100@0	see graph	PASS

B7_N2(5M)_DFT-s-OFDM_BPSK_Edge_1RB_Left_Low_CH

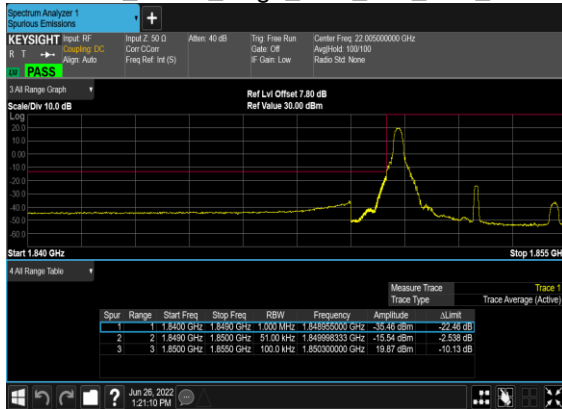

B7_N2(5M)_DFT-s-OFDM_QPSK_Edge_1RB_Left_Low_CH

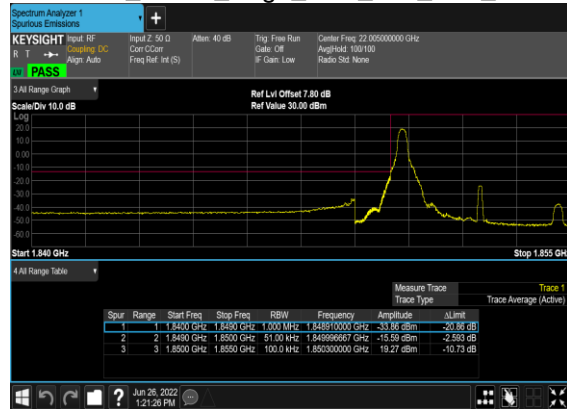

B7_N2(5M)_DFT-s-OFDM_BPSK_Outer_Full_Low_CH

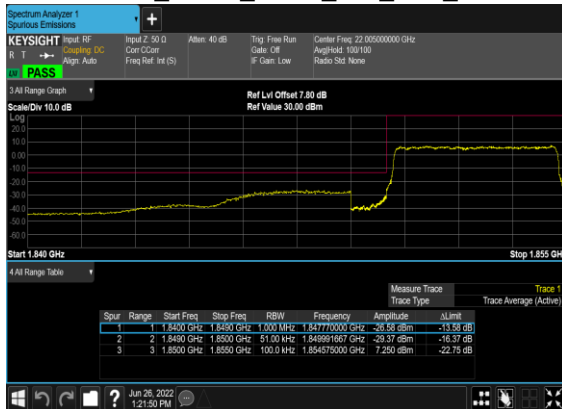

B7_N2(5M)_DFT-s-OFDM_QPSK_Outer_Full_Low_CH

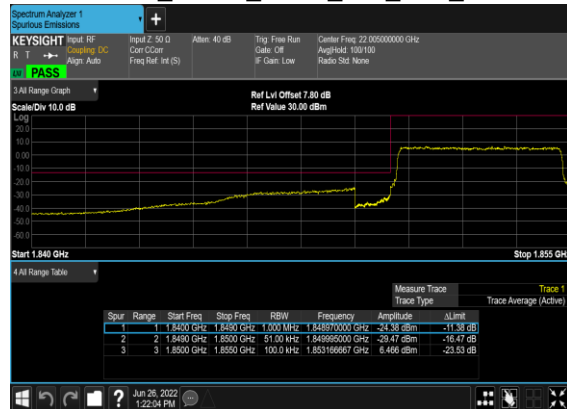

B7_N2(5M)_DFT-s-OFDM_BPSK_Edge_1RB_Right_High_CH

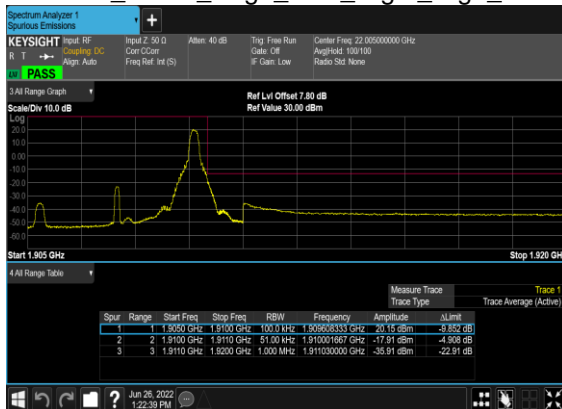

B7_N2(5M)_DFT-s-OFDM_QPSK_Edge_1RB_Right_High_CH

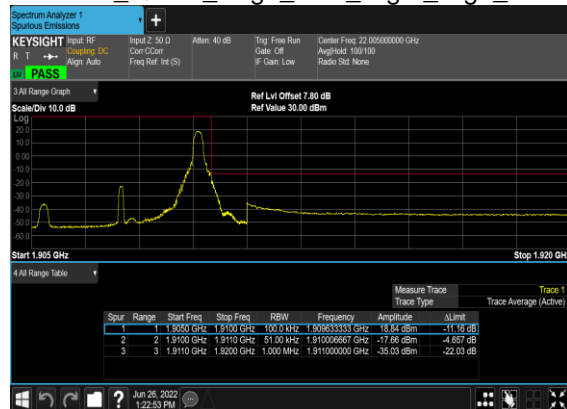

B7_N2(5M)_DFT-s-OFDM_BPSK_Outer_Full_High_CH

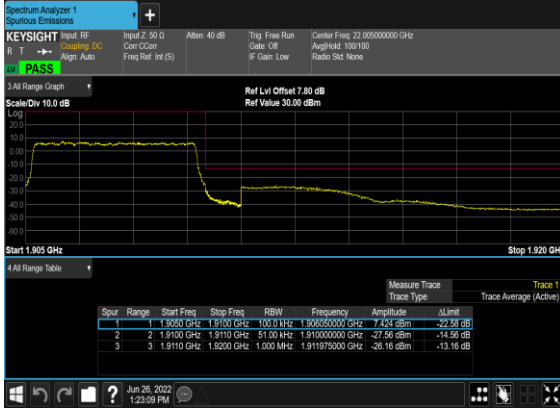

B7_N2(5M)_DFT-s-OFDM_QPSK_Outer_Full_High_CH

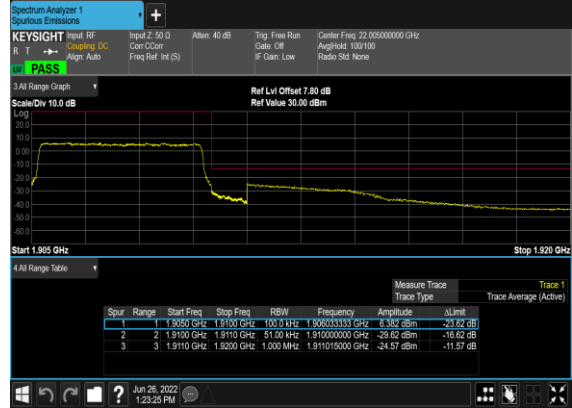

B7_N2(10M)_DFT-s-OFDM_BPSK_Edge_1RB_Left_Low_CH



B7_N2(10M)_DFT-s-OFDM_QPSK_Edge_1RB_Left_Low_CH

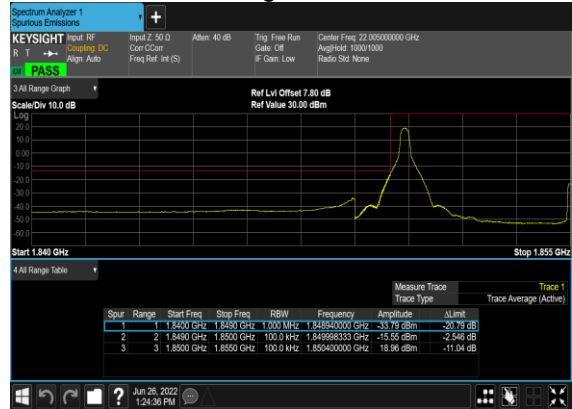

B7_N2(10M)_DFT-s-OFDM_BPSK_Outer_Full_Low_CH

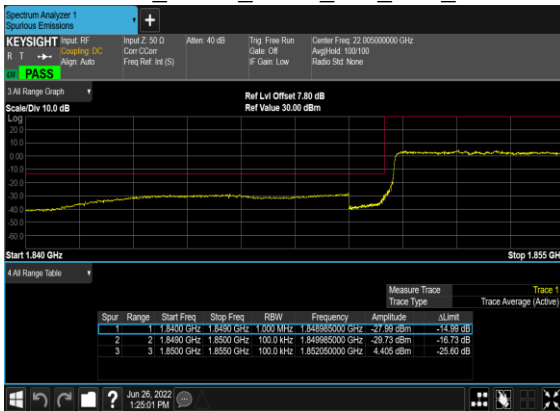

B7_N2(10M)_DFT-s-OFDM_QPSK_Outer_Full_Low_CH

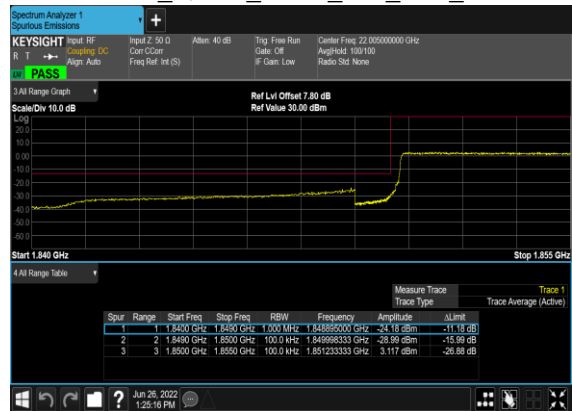

B7_N2(10M)_DFT-s-OFDM_BPSK_Edge_1RB_Right_High_CH

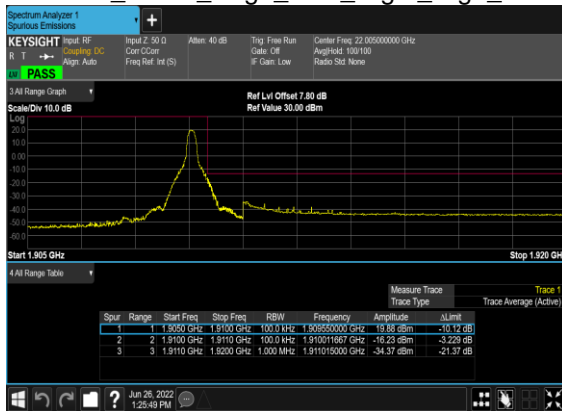

B7_N2(10M)_DFT-s-OFDM_QPSK_Edge_1RB_Right_High_CH

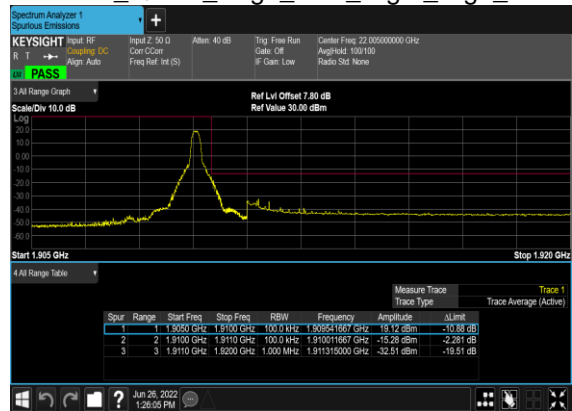

B7_N2(10M)_DFT-s-OFDM_BPSK_Outer_Full_High_CH

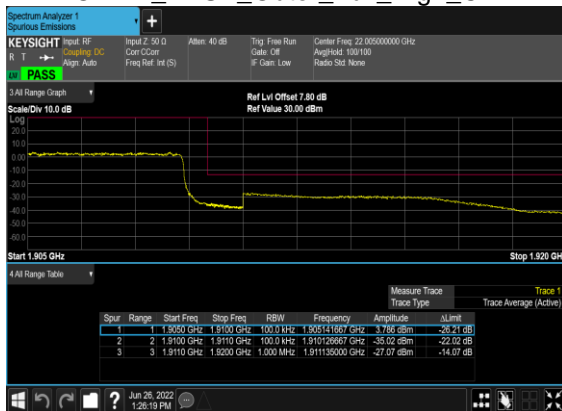

B7_N2(10M)_DFT-s-OFDM_QPSK_Outer_Full_High_CH



B7_N2(20M)_DFT-s-OFDM_BPSK_Edge_1RB_Left_Low_CH

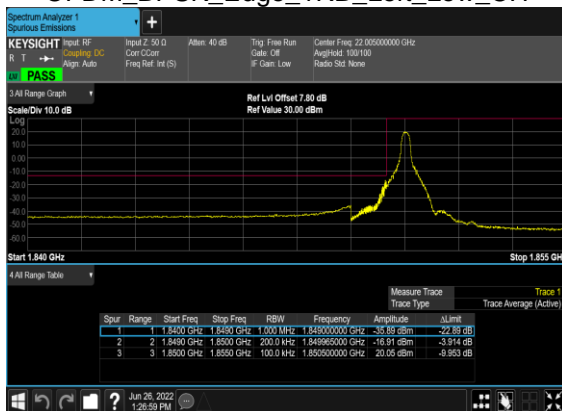

B7_N2(20M)_DFT-s-OFDM_QPSK_Edge_1RB_Left_Low_CH

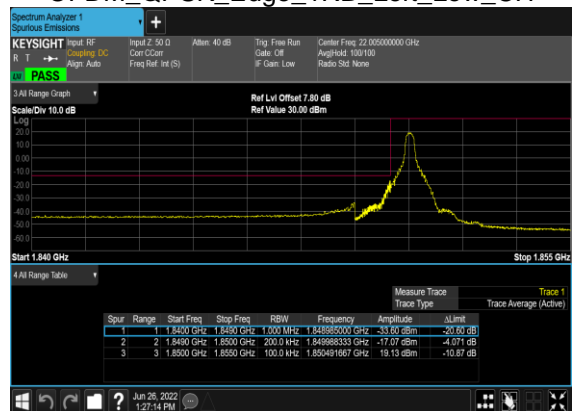

B7_N2(20M)_DFT-s-OFDM_BPSK_Outer_Full_Low_CH

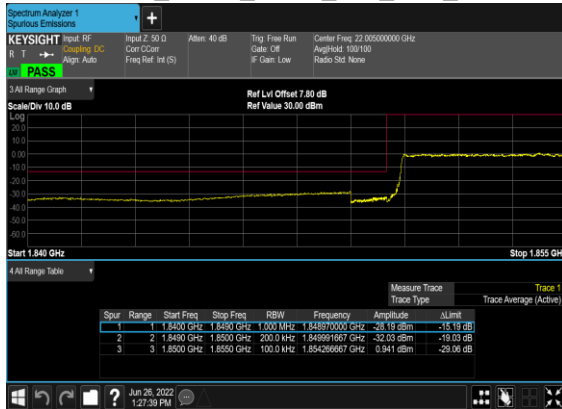

B7_N2(20M)_DFT-s-OFDM_QPSK_Outer_Full_Low_CH

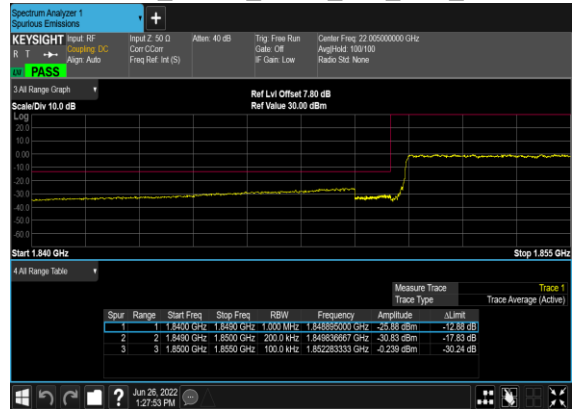

B7_N2(20M)_DFT-s-OFDM_BPSK_Edge_1RB_Right_High_CH

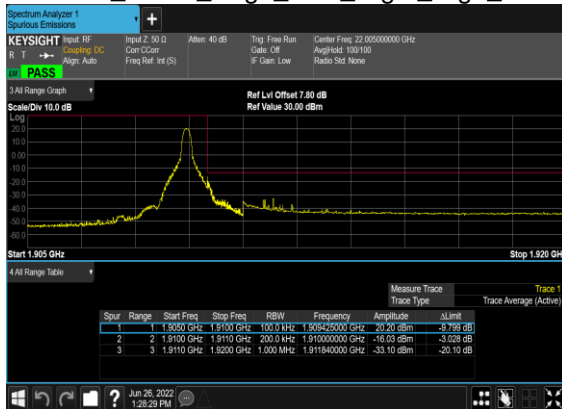

B7_N2(20M)_DFT-s-OFDM_QPSK_Edge_1RB_Right_High_CH

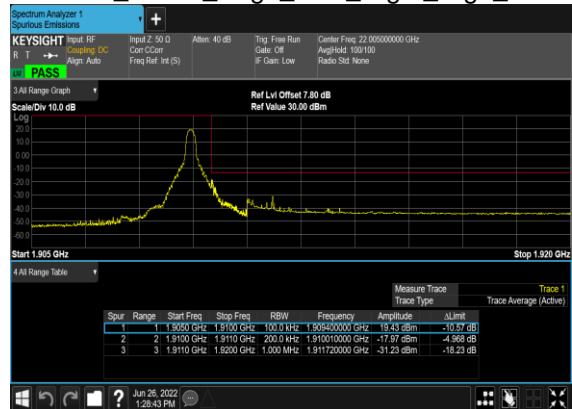

B7_N2(20M)_DFT-s-OFDM_BPSK_Outer_Full_High_CH

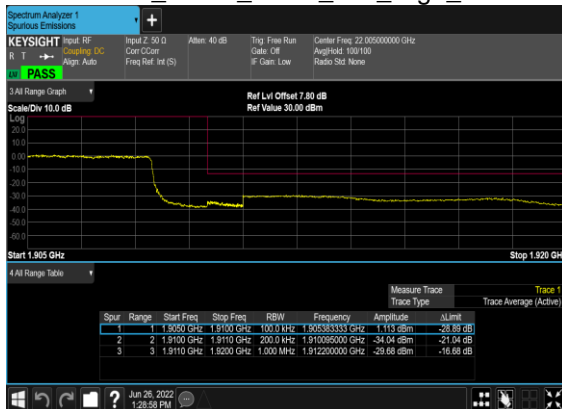

B7_N2(20M)_DFT-s-OFDM_QPSK_Outer_Full_High_CH

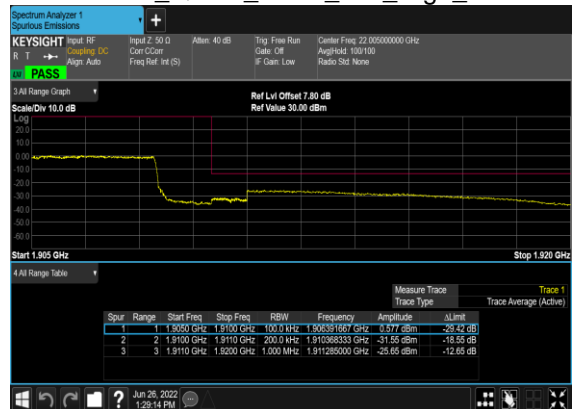

FR1 N5(ANT0)

LTE Band: 7, LTE BW: 10M, LTE ARFCN: Mid

Transmitter Conducted Output Power And ERP, (G_T - L_C)= -4.1dBi

NR Band	SCS (kHz)	Bandwidth (MHz)	Arfcn	Freq (MHz)	Modulation	RB	Conducted Power (dBm)	ERP(dBm)	ERP(W)
5	15	5	174300	826.5	DFT-s-OFDM QPSK	1@1	23.39	17.14	0.0518
5	15	5	174300	826.5	DFT-s-OFDM 16 QAM	1@1	22.5	16.25	0.0422
5	15	5	176300	836.5	DFT-s-OFDM QPSK	1@1	22.68	16.43	0.0440
5	15	5	176300	836.5	DFT-s-OFDM 16 QAM	1@1	21.88	15.63	0.0366
5	15	5	178300	846.5	DFT-s-OFDM QPSK	1@1	23.19	16.94	0.0494
5	15	5	178300	846.5	DFT-s-OFDM 16 QAM	1@1	22.49	16.24	0.0421
5	15	10	174800	829	DFT-s-OFDM QPSK	1@1	23.35	17.1	0.0513
5	15	10	174800	829	DFT-s-OFDM 16 QAM	1@1	22.43	16.18	0.0415
5	15	10	176300	836.5	DFT-s-OFDM QPSK	1@1	21.95	15.7	0.0372
5	15	10	176300	836.5	DFT-s-OFDM 16 QAM	1@1	21.2	14.95	0.0313
5	15	10	177800	844	DFT-s-OFDM QPSK	1@1	23.27	17.02	0.0504
5	15	10	177800	844	DFT-s-OFDM 16 QAM	1@1	22.36	16.11	0.0408
5	15	15	175300	831.5	DFT-s-OFDM QPSK	1@1	23.36	17.11	0.0514
5	15	15	175300	831.5	DFT-s-OFDM 16 QAM	1@1	22.66	16.41	0.0438
5	15	15	176300	836.5	DFT-s-OFDM QPSK	1@1	22.15	15.9	0.0389
5	15	15	176300	836.5	DFT-s-OFDM 16 QAM	1@1	21.36	15.11	0.0324
5	15	15	177300	841.5	DFT-s-OFDM QPSK	1@1	22.69	16.44	0.0441
5	15	15	177300	841.5	DFT-s-OFDM 16 QAM	1@1	21.85	15.6	0.0363
5	15	20	175800	834	DFT-s-OFDM PI/2 BPSK	50@25	23.08	16.83	0.0482
5	15	20	175800	834	DFT-s-OFDM PI/2 BPSK	1@1	23.24	16.99	0.0500
5	15	20	175800	834	DFT-s-OFDM PI/2 BPSK	1@104	22.89	16.64	0.0461
5	15	20	175800	834	DFT-s-OFDM QPSK	50@25	23.14	16.89	0.0489
5	15	20	175800	834	DFT-s-OFDM QPSK	1@1	23.52	17.27	0.0533
5	15	20	175800	834	DFT-s-OFDM QPSK	1@104	23.1	16.85	0.0484
5	15	20	175800	834	DFT-s-OFDM 16 QAM	50@25	22.18	15.93	0.0392
5	15	20	175800	834	DFT-s-OFDM 16 QAM	1@1	22.53	16.28	0.0425
5	15	20	175800	834	DFT-s-OFDM 16 QAM	1@104	22.08	15.83	0.0383
5	15	20	175800	834	DFT-s-OFDM 64 QAM	50@25	20.68	14.43	0.0277
5	15	20	175800	834	DFT-s-OFDM 64 QAM	1@1	20.93	14.68	0.0294

5	15	20	175800	834	DFT-s-OFDM 64 QAM	1@104	20.62	14.37	0.0274
5	15	20	175800	834	DFT-s-OFDM 256 QAM	50@25	18.63	12.38	0.0173
5	15	20	175800	834	DFT-s-OFDM 256 QAM	1@1	18.61	12.36	0.0172
5	15	20	175800	834	DFT-s-OFDM 256 QAM	1@104	18.19	11.94	0.0156
5	15	20	175800	834	CP-OFDM QPSK	53@26	21.64	15.39	0.0346
5	15	20	175800	834	CP-OFDM QPSK	1@1	21.93	15.68	0.0370
5	15	20	175800	834	CP-OFDM QPSK	1@104	21.51	15.26	0.0336
5	15	20	176300	836.5	DFT-s-OFDM PI/2 BPSK	50@25	23.13	16.88	0.0488
5	15	20	176300	836.5	DFT-s-OFDM PI/2 BPSK	1@1	23.3	17.05	0.0507
5	15	20	176300	836.5	DFT-s-OFDM PI/2 BPSK	1@104	22.9	16.65	0.0462
5	15	20	176300	836.5	DFT-s-OFDM QPSK	50@25	23.18	16.93	0.0493
5	15	20	176300	836.5	DFT-s-OFDM QPSK	1@1	23.51	17.26	0.0532
5	15	20	176300	836.5	DFT-s-OFDM QPSK	1@104	23.08	16.83	0.0482
5	15	20	176300	836.5	DFT-s-OFDM 16 QAM	50@25	22.17	15.92	0.0391
5	15	20	176300	836.5	DFT-s-OFDM 16 QAM	1@1	22.51	16.26	0.0423
5	15	20	176300	836.5	DFT-s-OFDM 16 QAM	1@104	22.08	15.83	0.0383
5	15	20	176300	836.5	DFT-s-OFDM 64 QAM	50@25	20.69	14.44	0.0278
5	15	20	176300	836.5	DFT-s-OFDM 64 QAM	1@1	20.97	14.72	0.0296
5	15	20	176300	836.5	DFT-s-OFDM 64 QAM	1@104	20.55	14.3	0.0269
5	15	20	176300	836.5	DFT-s-OFDM 256 QAM	50@25	18.6	12.35	0.0172
5	15	20	176300	836.5	DFT-s-OFDM 256 QAM	1@1	18.6	12.35	0.0172
5	15	20	176300	836.5	DFT-s-OFDM 256 QAM	1@104	18.18	11.93	0.0156
5	15	20	176300	836.5	CP-OFDM QPSK	53@26	21.66	15.41	0.0348
5	15	20	176300	836.5	CP-OFDM QPSK	1@1	21.98	15.73	0.0374
5	15	20	176300	836.5	CP-OFDM QPSK	1@104	21.51	15.26	0.0336
5	15	20	176800	839	DFT-s-OFDM PI/2 BPSK	50@25	23.13	16.88	0.0488
5	15	20	176800	839	DFT-s-OFDM PI/2 BPSK	1@1	23.26	17.01	0.0502
5	15	20	176800	839	DFT-s-OFDM PI/2 BPSK	1@104	22.85	16.6	0.0457
5	15	20	176800	839	DFT-s-OFDM QPSK	50@25	23.16	16.91	0.0491
5	15	20	176800	839	DFT-s-OFDM QPSK	1@1	23.49	17.24	0.0530
5	15	20	176800	839	DFT-s-OFDM QPSK	1@104	23.1	16.85	0.0484
5	15	20	176800	839	DFT-s-OFDM 16 QAM	50@25	22.14	15.89	0.0388
5	15	20	176800	839	DFT-s-OFDM 16 QAM	1@1	22.45	16.2	0.0417
5	15	20	176800	839	DFT-s-OFDM 16 QAM	1@104	22.06	15.81	0.0381
5	15	20	176800	839	DFT-s-OFDM 64 QAM	50@25	20.69	14.44	0.0278
5	15	20	176800	839	DFT-s-OFDM 64 QAM	1@1	20.96	14.71	0.0296

5	15	20	176800	839	DFT-s-OFDM 64 QAM	1@104	20.54	14.29	0.0269
5	15	20	176800	839	DFT-s-OFDM 256 QAM	50@25	18.57	12.32	0.0171
5	15	20	176800	839	DFT-s-OFDM 256 QAM	1@1	18.57	12.32	0.0171
5	15	20	176800	839	DFT-s-OFDM 256 QAM	1@104	18.13	11.88	0.0154
5	15	20	176800	839	CP-OFDM QPSK	53@26	21.64	15.39	0.0346
5	15	20	176800	839	CP-OFDM QPSK	1@1	21.94	15.69	0.0371
5	15	20	176800	839	CP-OFDM QPSK	1@104	21.45	15.2	0.0331

Frequency Stability

NR Band	SCS (kHz)	Bandwidth (MHz)	Arfcn	Freq (MHz)	Modulation	RB	Deviation (ppm)	Verdict	Environment
5	15	20	176300	836.5	DFT-s-OFDM QPSK	100@0	0.00215	PASS	NV
5	15	20	176300	836.5	DFT-s-OFDM QPSK	100@0	0.00601	PASS	LV
5	15	20	176300	836.5	DFT-s-OFDM QPSK	100@0	0.00575	PASS	HV
5	15	20	176300	836.5	DFT-s-OFDM QPSK	100@0	0.00155	PASS	-30°C
5	15	20	176300	836.5	DFT-s-OFDM QPSK	100@0	0.00324	PASS	-20°C
5	15	20	176300	836.5	DFT-s-OFDM QPSK	100@0	0.00336	PASS	-10°C
5	15	20	176300	836.5	DFT-s-OFDM QPSK	100@0	0.00416	PASS	0°C
5	15	20	176300	836.5	DFT-s-OFDM QPSK	100@0	0.00245	PASS	10°C
5	15	20	176300	836.5	DFT-s-OFDM QPSK	100@0	0.00759	PASS	20°C
5	15	20	176300	836.5	DFT-s-OFDM QPSK	100@0	0.00201	PASS	30°C
5	15	20	176300	836.5	DFT-s-OFDM QPSK	100@0	0.00312	PASS	40°C
5	15	20	176300	836.5	DFT-s-OFDM QPSK	100@0	0.00361	PASS	50°C

Peak to Average Ratio

NR Band	SCS (kHz)	Bandwidth (MHz)	Arfcn	Freq (MHz)	Modulation	RB	Result (dB)	Limit (dB)	Verdict
5	15	20	175800	834.0	DFT-s-OFDM PI/2 BPSK	100@0	3.59	13	PASS
5	15	20	175800	834.0	DFT-s-OFDM PI/2 BPSK	1@0	3.05	13	PASS
5	15	20	175800	834.0	DFT-s-OFDM QPSK	100@0	4.76	13	PASS
5	15	20	175800	834.0	DFT-s-OFDM QPSK	1@0	4.37	13	PASS
5	15	20	176300	836.5	DFT-s-OFDM PI/2 BPSK	100@0	3.68	13	PASS
5	15	20	176300	836.5	DFT-s-OFDM PI/2 BPSK	1@0	3.25	13	PASS
5	15	20	176300	836.5	DFT-s-OFDM QPSK	100@0	4.85	13	PASS
5	15	20	176300	836.5	DFT-s-OFDM QPSK	1@0	4.62	13	PASS
5	15	20	176800	839.0	DFT-s-OFDM PI/2 BPSK	100@0	3.8	13	PASS
5	15	20	176800	839.0	DFT-s-OFDM PI/2 BPSK	1@0	3.23	13	PASS
5	15	20	176800	839.0	DFT-s-OFDM QPSK	100@0	5.0	13	PASS
5	15	20	176800	839.0	DFT-s-OFDM QPSK	1@0	4.62	13	PASS

B7_N5(20M)_DFT-s-OFDM_PI_2-BPSK_Outer_Full_Low_CH

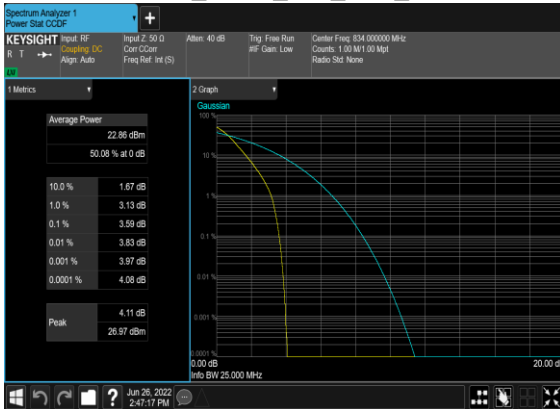

B7_N5(20M)_DFT-s-OFDM_PI_2-BPSK_Edge_1RB_Left_Low_CH



B7_N5(20M)_DFT-s-OFDM_QPSK_Outer_Full_Low_CH

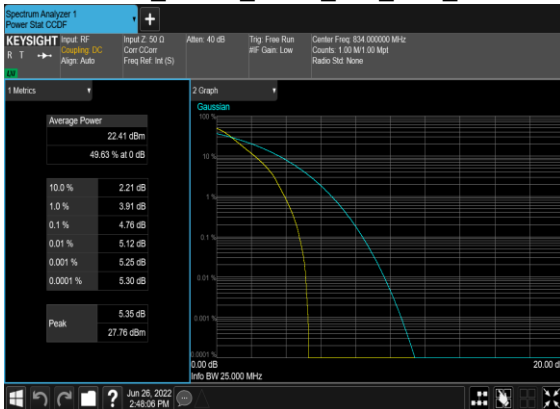

B7_N5(20M)_DFT-s-OFDM_QPSK_Edge_1RB_Left_Low_CH



B7_N5(20M)_DFT-s-OFDM_PI_2-BPSK_Outer_Full_Mid_CH

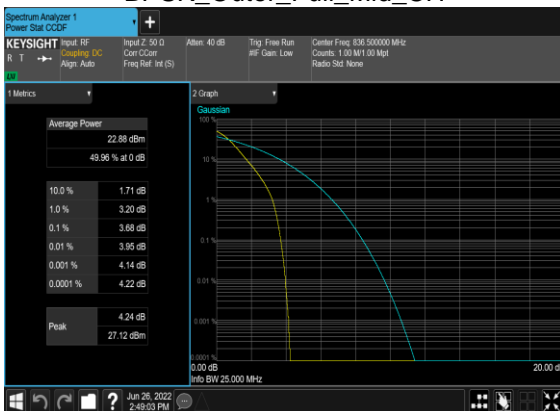

B7_N5(20M)_DFT-s-OFDM_PI_2-BPSK_Edge_1RB_Left_Mid_CH

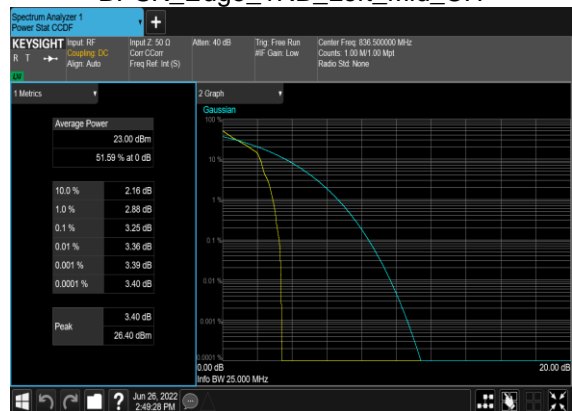

B7_N5(20M)_DFT-s-OFDM_QPSK_Outer_Full_Mid_CH

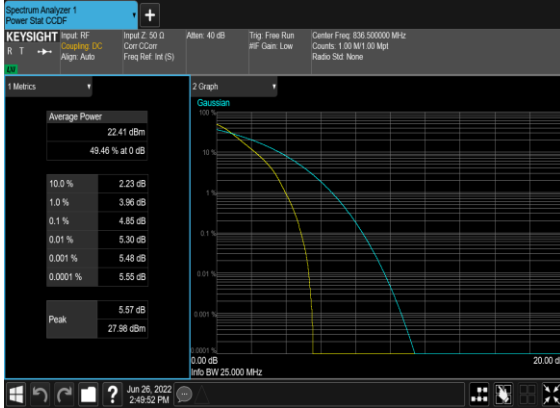

B7_N5(20M)_DFT-s-OFDM_QPSK_Edge_1RB_Left_Mid_CH



B7_N5(20M)_DFT-s-OFDM_PI_2-BPSK_Outer_Full_High_CH



B7_N5(20M)_DFT-s-OFDM_PI_2-BPSK_Edge_1RB_Left_High_CH



B7_N5(20M)_DFT-s-OFDM_QPSK_Outer_Full_High_CH



B7_N5(20M)_DFT-s-OFDM_QPSK_Edge_1RB_Left_High_CH



Occupied Bandwidth

NR Band	SCS (kHz)	Bandwidth (MHz)	Arfcn	Freq (MHz)	Modulation	RB	OBW (MHz)	26dB OBW (MHz)
5	15	5	176300	836.5	DFT-s-OFDM PI/2 BPSK	25@0	4.4625	4.876
5	15	5	176300	836.5	DFT-s-OFDM QPSK	25@0	4.4669	4.829
5	15	5	176300	836.5	CP-OFDM QPSK	25@0	4.467	4.894
5	15	5	176300	836.5	CP-OFDM 16 QAM	25@0	4.4891	4.962
5	15	5	176300	836.5	CP-OFDM 64 QAM	25@0	4.478	4.978
5	15	5	176300	836.5	CP-OFDM 256 QAM	25@0	4.464	4.909
5	15	10	176300	836.5	DFT-s-OFDM PI/2 BPSK	50@0	8.8758	9.502
5	15	10	176300	836.5	DFT-s-OFDM QPSK	50@0	8.8895	9.547
5	15	10	176300	836.5	CP-OFDM QPSK	52@0	9.2744	9.894
5	15	10	176300	836.5	CP-OFDM 16 QAM	52@0	9.2603	9.865
5	15	10	176300	836.5	CP-OFDM 64 QAM	52@0	9.2565	9.866
5	15	10	176300	836.5	CP-OFDM 256 QAM	52@0	9.273	9.941
5	15	15	176300	836.5	DFT-s-OFDM PI/2 BPSK	75@0	13.343	14.09
5	15	15	176300	836.5	DFT-s-OFDM QPSK	75@0	13.358	14.11
5	15	15	176300	836.5	CP-OFDM QPSK	79@0	14.067	14.83
5	15	15	176300	836.5	CP-OFDM 16 QAM	79@0	14.075	14.87
5	15	15	176300	836.5	CP-OFDM 64 QAM	79@0	14.087	14.84
5	15	15	176300	836.5	CP-OFDM 256 QAM	79@0	14.035	14.78
5	15	20	176300	836.5	DFT-s-OFDM PI/2 BPSK	100@0	17.815	18.7
5	15	20	176300	836.5	DFT-s-OFDM QPSK	100@0	17.804	18.7
5	15	20	176300	836.5	CP-OFDM QPSK	106@0	18.86	19.8
5	15	20	176300	836.5	CP-OFDM 16 QAM	106@0	18.871	19.75
5	15	20	176300	836.5	CP-OFDM 64 QAM	106@0	18.873	19.73
5	15	20	176300	836.5	CP-OFDM 256 QAM	106@0	18.907	19.68