



FCC RF Test Report

APPLICANT : Motorola Mobility LLC
EQUIPMENT : Mobile Cellular Phone
BRAND NAME : Motorola
MODEL NAME : XT2241-2
FCC ID : IHDT56AF6
STANDARD : FCC Part 15 Subpart E §15.407
CLASSIFICATION : (NII) Unlicensed National Information Infrastructure
TEST DATE(S) : Jun. 02, 2022 ~ Jul. 09, 2022

We, Sporton International Inc. (Kunshan), would like to declare that the tested sample has been evaluated in accordance with the test procedures and has been in compliance with the applicable technical standards.

The test results in this report apply exclusively to the tested model / sample. Without written approval of Sporton International Inc. (Kunshan), the test report shall not be reproduced except in full.

Jason Jia



Approved by: Jason Jia

Sporton International Inc. (Kunshan)

**No. 1098, Pengxi North Road, Kunshan Economic Development Zone Jiangsu Province 215300
People's Republic of China**



TABLE OF CONTENTS

REVISION HISTORY 3

SUMMARY OF TEST RESULT 4

1 GENERAL DESCRIPTION 5

 1.1 Applicant 5

 1.2 Manufacturer 5

 1.3 Product Feature of Equipment Under Test 5

 1.4 Product Specification of Equipment Under Test 6

 1.5 Modification of EUT 8

 1.6 Testing Location 8

 1.7 Test Software 9

 1.8 Applicable Standards 9

 1.9 Specification of Accessory 9

2 TEST CONFIGURATION OF EQUIPMENT UNDER TEST 10

 2.1 Carrier Frequency and Channel 10

 2.2 Test Mode 12

 2.3 Connection Diagram of Test System 15

 2.4 Support Unit used in test configuration and system 15

 2.5 EUT Operation Test Setup 16

 2.6 Measurement Results Explanation Example 16

3 TEST RESULT 17

 3.1 6dB and 26dB and 99% Occupied Bandwidth Measurement 17

 3.2 Maximum Conducted Output Power Measurement 19

 3.3 Power Spectral Density Measurement 21

 3.4 Unwanted Emissions Measurement 24

 3.5 AC Conducted Emission Measurement 29

 3.6 Antenna Requirements 31

4 LIST OF MEASURING EQUIPMENT 32

5 UNCERTAINTY OF EVALUATION 33

APPENDIX A. CONDUCTED TEST RESULTS

APPENDIX B. AC CONDUCTED EMISSION TEST RESULT

APPENDIX C. RADIATED SPURIOUS EMISSION

APPENDIX D. DUTY CYCLE PLOTS

APPENDIX E. SETUP PHOTOGRAPHS



REVISION HISTORY

REPORT NO.	VERSION	DESCRIPTION	ISSUED DATE
FR252601F	Rev. 01	Initial issue of report	Jul. 11, 2022



SUMMARY OF TEST RESULT

Report Section	FCC Rule	Description	Limit for U-NII-1 ~ U-NII-2C	Limit for U-NII-3	Result	Remark
3.1	2.1049 & 15.403(i)	6dB, 26dB & 99% Bandwidth	-	> 500kHz	Pass	-
3.2	15.407(a)	Maximum Conducted Output Power	≤ 24 dBm	≤ 30 dBm	Pass	-
3.3	15.407(a)	Power Spectral Density	≤ 11 dBm	≤ 30 dBm/500kHz	Pass	-
3.4	15.407(b)	Unwanted Emissions	15.407(b) & 15.209(a)	15.407(b)(4)(i) & 15.209(a)	Pass	Under limit 3.02 dB at 5150.000 MHz
3.5	15.207	AC Conducted Emission	15.207(a)	15.207(a)	Pass	Under limit 7.10 dB at 0.154 MHz
3.6	15.203 & 15.407(a)	Antenna Requirement	N/A	N/A	Pass	-

Declaration of Conformity:
The test results with all measurement uncertainty excluded are presented in accordance with the regulation limits or requirements declared by manufacturers.
Comments and Explanations:
The declared of product specification for EUT presented in the report are provided by the manufacturer, and the manufacturer takes all the responsibilities for the accuracy of product specification.



1 General Description

1.1 Applicant

Motorola Mobility LLC
222 W, Merchandise Mart Plaza, Chicago IL 60654 USA

1.2 Manufacturer

Motorola Mobility LLC
222 W, Merchandise Mart Plaza, Chicago IL 60654 USA

1.3 Product Feature of Equipment Under Test

Product Feature	
Equipment	Mobile Cellular Phone
Brand Name	Motorola
Model Name	XT2241-2
IMEI Code	Conducted: 355222700012736/355222700012744 Conduction: 355222700014153/355222700014161 Radiation: 355222700012637/355222700012645
FCC ID	IHDT56AF6
HW Version	DVT2
SW Version	SSQ32.54
EUT Stage	Identical Prototype

Remark: The above EUT's information was declared by manufacturer. Please refer to the specifications or user's manual for more detailed description.



1.4 Product Specification of Equipment Under Test

Standards-related Product Specification	
Tx/Rx Frequency Range	5180 MHz ~ 5240 MHz 5260 MHz ~ 5320 MHz 5500 MHz ~ 5720 MHz 5745 MHz ~ 5825 MHz
Maximum Output Power to Antenna	<p><MIMO Ant. 1+2></p> <p><5180 MHz ~ 5240 MHz> 802.11a : 20.61 dBm / 0.1151 W 802.11n HT20 : 20.87 dBm / 0.1222 W 802.11n HT40 : 20.85 dBm / 0.1216 W 802.11ac VHT20 : 20.93 dBm / 0.1239 W 802.11ac VHT40 : 20.94 dBm / 0.1242 W 802.11ac VHT80 : 18.57 dBm / 0.0719 W 802.11ac VHT160 : 17.08 dBm / 0.0511 W 802.11ax HE20 : 21.69 dBm / 0.1476 W 802.11ax HE40 : 21.62 dBm / 0.1452 W 802.11ax HE80 : 18.99 dBm / 0.0793 W 802.11ax HE160 : 17.50 dBm / 0.0562 W</p> <p><5260 MHz ~ 5320 MHz> 802.11a : 20.60 dBm / 0.1148 W 802.11n HT20 : 20.88 dBm / 0.1225 W 802.11n HT40 : 20.94 dBm / 0.1242 W 802.11ac VHT20 : 20.95 dBm / 0.1245 W 802.11ac VHT40 : 21.02 dBm / 0.1265 W 802.11ac VHT80 : 18.54 dBm / 0.0714 W 802.11ax HE20 : 21.72 dBm / 0.1486 W 802.11ax HE40 : 21.59 dBm / 0.1442 W 802.11ax HE80 : 18.99 dBm / 0.0793 W</p> <p><5500 MHz ~ 5720 MHz > 802.11a : 20.40 dBm / 0.1019 W 802.11n HT20 : 20.74 dBm / 0.1186 W 802.11n HT40 : 20.49 dBm / 0.1119 W 802.11ac VHT20 : 20.84 dBm / 0.1213 W 802.11ac VHT40 : 20.59 dBm / 0.1146 W 802.11ac VHT80 : 20.40 dBm / 0.1096 W 802.11ac VHT160 : 15.19 dBm / 0.0330 W 802.11ax HE20 : 21.70 dBm / 0.1479 W 802.11ax HE40 : 21.20 dBm / 0.1318 W 802.11ax HE80 : 21.28 dBm / 0.1343 W 802.11ax HE160 : 15.54 dBm / 0.0358 W</p> <p><5745 MHz ~ 5825 MHz> 802.11a : 20.77 dBm / 0.1194 W 802.11n HT20 : 20.47 dBm / 0.1114 W 802.11n HT40 : 20.54 dBm / 0.1132 W 802.11ac VHT20 : 20.59 dBm / 0.1146 W 802.11ac VHT40 : 20.62 dBm / 0.1153 W 802.11ac VHT80 : 20.47 dBm / 0.1114 W 802.11ax HE20 : 21.52 dBm / 0.1419 W 802.11ax HE40 : 21.28 dBm / 0.1343 W 802.11ax HE80 : 21.18 dBm / 0.1312 W</p>



<p>99% Occupied Bandwidth</p>	<p><Ant. 1> <5180 MHz ~ 5240 MHz> 802.11a : 16.863 MHz 802.11ax HE20 : 19.141 MHz 802.11ax HE40 : 38.122 MHz 802.11ax HE80 : 77.682 MHz 802.11ax HE160 : 157.28 MHz <5260 MHz ~ 5320 MHz> 802.11a : 16.863 MHz 802.11ax HE20 : 19.101 MHz 802.11ax HE40 : 38.042 MHz 802.11ax HE80 : 77.682 MHz <5500 MHz ~ 5720 MHz > 802.11a : 16.783 MHz 802.11ax HE20 : 19.101 MHz 802.11ax HE40 : 38.042 MHz 802.11ax HE80 : 77.682 MHz 802.11ax HE160 : 157.92 MHz <5745 MHz ~ 5825 MHz> 802.11a : 16.823 MHz 802.11ax HE20: 19.141 MHz 802.11ax HE40: 38.042 MHz 802.11ax HE80: 77.522 MHz <Ant. 2> <5180 MHz ~ 5240 MHz> 802.11a : 16.703 MHz 802.11ax HE20 : 19.141 MHz 802.11ax HE40 : 38.122 MHz 802.11ax HE80 : 77.682 MHz 802.11ax HE160 : 157.28 MHz <5260 MHz ~ 5320 MHz> 802.11a : 16.743 MHz 802.11ax HE20 : 19.141 MHz 802.11ax HE40 : 38.122 MHz 802.11ax HE80 : 77.842 MHz <5500 MHz ~ 5720 MHz > 802.11a : 16.703 MHz 802.11ax HE20 : 19.141 MHz 802.11ax HE40 : 38.122 MHz 802.11ax HE80 : 77.842 MHz 802.11ax HE160 : 157.28 MHz <5745 MHz ~ 5825 MHz> 802.11a : 16.703 MHz 802.11ax HE20: 19.101 MHz 802.11ax HE40: 38.122 MHz 802.11ax HE80: 77.682 MHz</p>
-------------------------------	--



Antenna Type / Gain	<p><5180 MHz ~ 5240 MHz> <Ant. 1> : IFA Antenna with gain -3.10 dBi <Ant. 2> : IFA Antenna with gain -3.20 dBi</p> <p><5260 MHz ~ 5320 MHz> <Ant. 1> : IFA Antenna with gain -3.30 dBi <Ant. 2> : IFA Antenna with gain -3.30 dBi</p> <p><5500 MHz ~ 5720 MHz> <Ant. 1> : IFA Antenna with gain -3.20 dBi <Ant. 2> : IFA Antenna with gain -3.20 dBi</p> <p><5745 MHz ~ 5825 MHz> <Ant. 1> : IFA Antenna with gain -3.30 dBi <Ant. 2> : IFA Antenna with gain -3.40 dBi</p>
Type of Modulation	802.11a/n : OFDM (BPSK / QPSK / 16QAM / 64QAM) 802.11ac/ax : OFDM (BPSK / QPSK / 16QAM / 64QAM / 256QAM / 1024QAM)

Note:

1. WLAN Ant. 1 / Ant. 2 corresponding to EUT Photo Ant. 2 / Ant. 6.
2. WLAN support CDD MIMO mode only.
3. For 802.11n/ac & 802.11ax mode, the whole testing have assessed only 802.11ax HE20/40 by referring to the higher output power.
4. 802.11ax support OFDMA full RU tone and partial RU tone

1.5 Modification of EUT

No modifications are made to the EUT during all test items.

1.6 Testing Location

Sporton International Inc. (Kunshan) is accredited to ISO/IEC 17025:2017 by American Association for Laboratory Accreditation with Certificate Number 5145.02.

Test Firm	Sporton International Inc. (Kunshan)		
Test Site Location	No. 1098, Pengxi North Road, Kunshan Economic Development Zone Jiangsu Province 215300 People's Republic of China TEL : +86-512-57900158 FAX : +86-512-57900958		
Test Site No.	Sporton Site No.	FCC Designation No.	FCC Test Firm Registration No.
	CO01-KS 03CH07-KS TH01-KS	CN1257	314309



1.7 Test Software

Item	Site	Manufacturer	Name	Version
1.	03CH07-KS	AUDIX	E3	6.2009-8-24a1
2.	CO01-KS	AUDIX	E3	6.2009-8-24

1.8 Applicable Standards

According to the specifications of the manufacturer, the EUT must comply with the requirements of the following standards:

- ♦ 47 CFR Part 15 Subpart E
- ♦ FCC KDB 789033 D02 General UNII Test Procedures New Rules v02r01.
- ♦ FCC KDB 662911 D01 Multiple Transmitter Output v02r01.
- ♦ ANSI C63.10-2013

Remark:

1. All test items were verified and recorded according to the standards and without any deviation during the test.
2. This EUT has also been tested and complied with the requirements of FCC Part 15, Subpart B, recorded in a separate test report.

1.9 Specification of Accessory

Specification of Accessory				
AC Adapter (US)	Brand Name	Motorola (AOHAI)	Model Name	MC-1251
AC Adapter (EU)	Brand Name	Motorola (AOHAI)	Model Name	MC-1252
AC Adapter (UK)	Brand Name	Motorola (AOHAI)	Model Name	MC-1253
AC Adapter (IN)	Brand Name	Motorola (AOHAI)	Model Name	MC-1254
AC Adapter (AU)	Brand Name	Motorola (AOHAI)	Model Name	MC-1255
AC Adapter (AR)	Brand Name	Motorola (AOHAI)	Model Name	MC-1256
AC Adapter (BR)	Brand Name	Motorola (AOHAI)	Model Name	MC-1257
AC Adapter (CHILE)	Brand Name	Motorola (AOHAI)	Model Name	MC-1259
Battery	Brand Name	Motorola(ATL)	Model Name	NF45
Earphone 1	Brand Name	Motorola (Lyand)	Model Name	MD211
Earphone 2	Brand Name	Motorola (LCHSE)	Model Name	MD211
USB Cable	Brand Name	Motorola(Saibao)	Model Name	SC18D58980
Wireless Charging dock	Marketing Name	Turbo Power 50W Wireless Charging Stand	Model Name	MW-02



2 Test Configuration of Equipment Under Test

- a. The EUT has been associated with peripherals and configuration operated in a manner tended to maximize its emission characteristics in a typical application. Frequency range investigated: conduction emission (150 kHz to 30 MHz), radiation emission (9 kHz to the 10th harmonic of the highest fundamental frequency or to 40 GHz, whichever is lower). For radiated measurement, pre-scanned in three orthogonal panels, X, Y, Z. The worst cases (X plane) were recorded in this report.
- b. AC power line Conducted Emission was tested under maximum output power.

2.1 Carrier Frequency and Channel

Frequency Band	Channel	Freq. (MHz)	Channel	Freq. (MHz)
5180-5240 MHz U-NII-1	36	5180	44	5220
	38*	5190	46*	5230
	40	5200	48	5240
	42 [#]	5210		
5260-5320 MHz U-NII-2A	52	5260	60	5300
	54*	5270	62*	5310
	56	5280	64	5320
	58 [#]	5290		
5500-5720MHz U-NII-2C	100	5500	112	5560
	102*	5510	116	5580
	104	5520	132	5660
	106 [#]	5530	134*	5670
	108	5540	136	5680
	110*	5550	140	5700
5745-5825 MHz U-NII-3	149	5745	157	5785
	151*	5755	159*	5795
	153	5765	161	5805
	155 [#]	5775	165	5825



Frequency Band	Channel	Freq. (MHz)	Channel	Freq. (MHz)
TDWR Channel	118*	5590	124	5620
	120	5600	126*	5630
	122 [#]	5610	128	5640

Frequency Band	Channel	Freq. (MHz)	Channel	Freq. (MHz)
Straddle Channel	138 [#]	5690	144	5720
	142*	5710		

Note:

1. The above Frequency and Channel in "*" were 802.11n HT40 and 802.11ac VHT40.
2. The above Frequency and Channel in "[#]" were 802.11ac VHT80.



2.2 Test Mode

Final test modes are considering the modulation and worse data rates as below table.

MIMO Mode

Modulation	Data Rate
802.11a	6 Mbps
802.11ax HE20	MCS0
802.11ax HE40	MCS0
802.11ax HE80	MCS0
802.11ax HE160	MCS0

Test Cases	
AC Conducted Emission	Mode 1 : GSM850 Idle+ Bluetooth Link+ WLAN Link(5G)+ USB Cable (Charging from Adapter)
Remark: For Radiated Test Cases, The tests were performance with standalone mode. Only the worst test data show in the report	

Simultaneous transmission
802.11a CH36(5180MHz)Tx + BLE-2M-CH39(2480MHz)Tx + LTE Band48 Link 802.11a CH36(5180MHz)Tx + 11ax40_CH09(2452MHz)Tx + LTE Band48 Link



Ch. #		U-NII-1	U-NII-2A	U-NII-2C	U-NII-3
		5180-5240 MHz	5260-5320 MHz	5500-5720MHz	5745-5825 MHz
		802.11a	802.11a	802.11a	802.11a
L	Low	36	52	100	149
M	Middle	44	60	116	157
H	High	48	64	140	165
Straddle		-	-	144	-

Ch. #		U-NII-1	U-NII-2A	U-NII-2C	U-NII-3
		5180-5240 MHz	5260-5320 MHz	5500-5720MHz	5745-5825 MHz
		802.11n HT20	802.11n HT20	802.11n HT20	802.11n HT20
L	Low	36	52	100	149
M	Middle	44	60	116	157
H	High	48	64	140	165
Straddle		-	-	144	-

Ch. #		U-NII-1	U-NII-2A	U-NII-2C	U-NII-3
		5180-5240 MHz	5260-5320 MHz	5500-5720MHz	5745-5825 MHz
		802.11n HT40	802.11n HT40	802.11n HT40	802.11n HT40
L	Low	38	54	102	151
M	Middle	-	-	110	-
H	High	46	62	134	159
Straddle		-	-	142	-

Ch. #		U-NII-1	U-NII-2A	U-NII-2C	U-NII-3
		5180-5240 MHz	5260-5320 MHz	5500-5720MHz	5745-5825 MHz
		802.11ac VHT80	802.11ac VHT80	802.11ac VHT80	802.11ac VHT80
L	Low	-	-	106	-
M	Middle	42	58	-	155
H	High	-	-	-	-
Straddle		-	-	138	-



Ch. #		U-NII-1	U-NII-2A	U-NII-2C	U-NII-3
		5180-5240 MHz	5260-5320 MHz	5500-5720MHz	5745-5825 MHz
		802.11ax HE20	802.11ax HE20	802.11ax HE20	802.11ax HE20
L	Low	36	52	100	149
M	Middle	44	60	116	157
H	High	48	64	140	165
Straddle		-	-	144	-

Ch. #		U-NII-1	U-NII-2A	U-NII-2C	U-NII-3
		5180-5240 MHz	5260-5320 MHz	5500-5720MHz	5745-5825 MHz
		802.11ax HE40	802.11ax HE40	802.11ax HE40	802.11ax HE40
L	Low	38	54	102	151
M	Middle	-	-	110	-
H	High	46	62	134	159
Straddle		-	-	142	-

Ch. #		U-NII-1	U-NII-2A	U-NII-2C	U-NII-3
		5180-5240 MHz	5260-5320 MHz	5500-5720MHz	5745-5825 MHz
		802.11ax HE80	802.11ax HE80	802.11ax HE80	802.11ax HE80
L	Low	-	-	106	-
M	Middle	42	58	-	155
H	High	-	-	-	-
Straddle		-	-	138	-

2.3 Connection Diagram of Test System

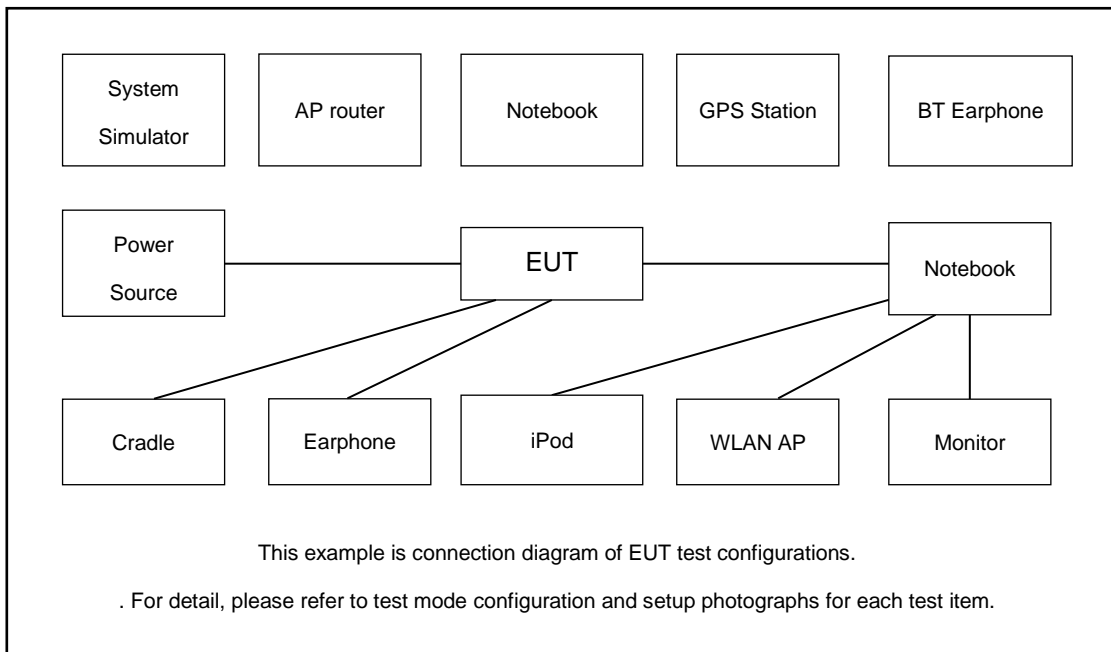

2.4 Support Unit used in test configuration and system

Item	Equipment	Trade Name	Model Name	FCC ID	Data Cable	Power Cord
1.	LTE Base Station	Anritus	MT8821C	N/A	N/A	Unshielded,1.8m
2.	WLAN AP	D-link	DIR-655	KA21R655B1	N/A	Unshielded,1.8m
3.	Notebook	Lenovo	G480	QDS-BRCM1050I	N/A	shielded cable DC O/P 1.8m , Unshielded AC I/P cable 1.8m
4.	Bluetooth Earphone	Lenovo	LBH308	N/A	N/A	N/A
5.	SD Card	Kingston	8GB	N/A	N/A	N/A



2.5 EUT Operation Test Setup

For WLAN RF test items, an engineering test program was provided and enabled to make EUT continuously transmit/receive.

For AC power line conducted emissions, the EUT was set to connect with the WLAN AP under large package sizes transmission.

2.6 Measurement Results Explanation Example

For all conducted test items:

The offset level is set in the spectrum analyzer to compensate the RF cable loss and attenuator factor between EUT conducted output port and spectrum analyzer. With the offset compensation, the spectrum analyzer reading level is exactly the EUT RF output level.

Example :

The spectrum analyzer offset is derived from RF cable loss and attenuator factor.

Offset = RF cable loss + attenuator factor.

Following shows an offset computation example with cable loss 7.20dB

$$\begin{aligned} \text{Offset}(dB) &= \text{RF cable loss}(dB) \\ &= 7.20 \end{aligned}$$



3 Test Result

3.1 6dB and 26dB and 99% Occupied Bandwidth Measurement

3.1.1 Description of 6dB and 26dB and 99% Occupied Bandwidth

The minimum 6 dB bandwidth shall be at least 500 kHz.

26dB and 99% Occupied bandwidth are reporting only.

3.1.2 Measuring Instruments

The measuring equipment is listed in the section 4 of this test report.

3.1.3 Test Procedures

- The testing follows FCC KDB 789033 D02 General UNII Test Procedures New Rules v02r01.

<input checked="" type="checkbox"/>	Section C) Bandwidth Measurement 1. Emission Bandwidth (EBW)
	<ol style="list-style-type: none"> Set RBW = approximately 1% of the emission bandwidth. Set the VBW > RBW. Detector = Peak. Trace mode = max hold Measure the maximum width of the emission that is 26 dB down from the peak of the emission. Compare this with the RBW setting of the analyzer. Readjust RBW and repeat measurement as needed until the RBW/EBW ratio is approximately 1%. For 99% Bandwidth Measurement, the spectrum analyzer's resolution bandwidth (RBW) is set 1MHz and set the Video bandwidth (VBW) $\geq 3 * RBW$. Measure and record the results in the test report.
<input checked="" type="checkbox"/>	Section C) Bandwidth Measurement 2. Minimum Emission Bandwidth for the band 5.725 - 5.85 GHz
	<ol style="list-style-type: none"> Set RBW = 100kHz. Set the VBW $\geq 3 * RBW$. Detector = Peak. Trace mode = max hold Measure the maximum width of the emission that is 6 dB down from the peak of the emission. Measure and record the results in the test report.

3.1.4 Test Setup

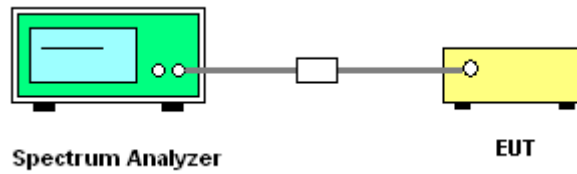

3.1.5 Test Result of 6dB Bandwidth

Please refer to Appendix A.



3.2 Maximum Conducted Output Power Measurement

3.2.1 Limit of Maximum Conducted Output Power

<FCC 14-30 CFR 15.407>

For mobile and portable client devices in the 5.15–5.25 GHz band, the maximum conducted output power over the frequency band of operation shall not exceed 250 mW.

For the 5.25–5.725 GHz bands, the maximum conducted output power over the frequency bands of operation shall not exceed the lesser of 250 mW or 11 dBm + 10 log B, where B is the 26 dB emission bandwidth in megahertz.

For Straddle Channel, According to KDB 789033 D02 General UNII Test Procedures New Rules v02r01, If the power and PSD of the devices are uniform and comply with the lower limits specified for the U-NII-2 bands, a single measurement over the entire emission bandwidth can be performed to show compliance.

If transmitting antennas of directional gain greater than 6 dBi are used, the peak output power shall be reduced by the amount in dB that the directional gain of the antenna exceeds 6 dBi.

Note that U-NII-2 band, devices with a maximum e.i.r.p. greater than 500 mW shall implement TPC in order to have the capability to operate at least 6 dB below the maximum permitted e.i.r.p. of 1 W.

3.2.2 Measuring Instruments

The measuring equipment is listed in the section 4 of this test report.

3.2.3 Test Procedures

The testing follows Method PM of FCC KDB 789033 D02 General UNII Test Procedures New Rules v02r01.

Method PM (Measurement using an RF average power meter):

1. Measurement is performed using a wideband RF power meter.
2. The EUT is configured to transmit continuously with a consistent duty cycle at its maximum power control level.
3. Measure the average power of the transmitter, and the average power is corrected with duty factor, $10 \log(1/x)$, where x is the duty cycle.
4. For MIMO mode, the measure-and-sum technique should be used for measuring the in-band transmit power of a device.

For Straddle Channel, According to KDB 789033 D02 General UNII Test Procedures New Rules v02r01, If the power and PSD of the devices are uniform and comply with the lower limits specified for the U-NII-2 bands, a single measurement over the entire emission bandwidth can be performed to show compliance.

3.2.4 Test Setup

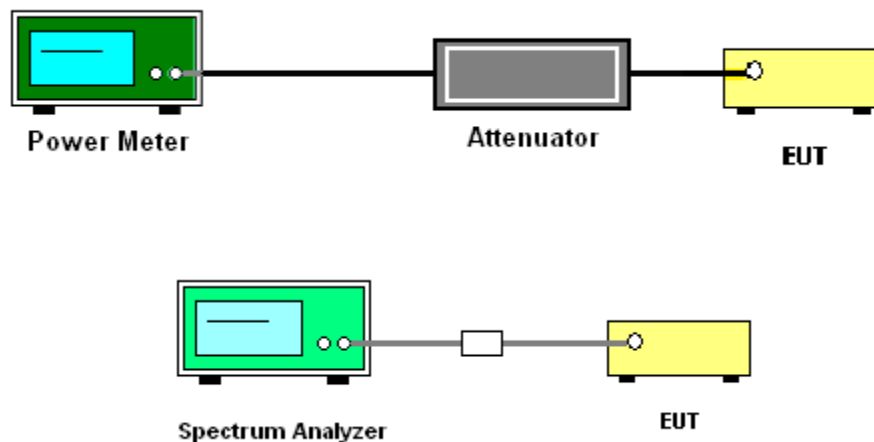

3.2.5 Test Result of Maximum Conducted Output Power

Please refer to Appendix A.



3.3 Power Spectral Density Measurement

3.3.1 Limit of Power Spectral Density

<FCC 14-30 CFR 15.407>

For mobile and portable client devices in the 5.15–5.25 GHz band, the maximum power spectral density shall not exceed 11dBm in any 1 megahertz band.

For the 5.25–5.725 GHz bands, the maximum power spectral density shall not exceed 11 dBm in any 1 megahertz band.

For Straddle Channel, According to KDB 789033 D02 General UNII Test Procedures New Rules v02r01, If the power and PSD of the devices are uniform and comply with the lower limits specified for the U-NII-2 bands, a single measurement over the entire emission bandwidth can be performed to show compliance.

If transmitting antennas of directional gain greater than 6 dBi are used, the peak output power shall be reduced by the amount in dB that the directional gain of the antenna exceeds 6 dBi.

3.3.2 Measuring Instruments

The measuring equipment is listed in the section 4 of this test report.



3.3.3 Test Procedures

The testing follows FCC KDB 789033 D02 General UNII Test Procedures New Rules v01r04.
Section F) Maximum power spectral density.

Method SA-2

(trace averaging across on and off times of the EUT transmissions, followed by duty cycle correction).

- Measure the duty cycle.
- Set span to encompass the entire emission bandwidth (EBW) of the signal.
- Set RBW = 1 MHz.
- Set VBW \geq 3 MHz.
- Number of points in sweep \geq 2 Span / RBW.
- Sweep time = auto.
- Detector = RMS
- Trace average at least 100 traces in power averaging mode.
- Add $10 \log(1/x)$, where x is the duty cycle, to the measured power in order to compute the average power during the actual transmission times. For example, add $10 \log(1/0.25) = 6$ dB if the duty cycle is 25 percent.

1. The RF output of EUT was connected to the spectrum analyzer by a low loss cable.
2. Each plot has already offset with cable loss, and attenuator loss. Measure the PPSD and record it.
3. For MIMO mode, calculation method follows FCC KDB 662911 D01 Multiple Transmitter Output v02r01.

Method (a): Measure and sum the spectra across the outputs.

The total final Power Spectral Density is the bin-by-bin summation to obtain the combined spectrum. For the device with 2 transmitter outputs. The spectrum measurements of the individual outputs are all performed with the same span and number of points, the spectrum value in the first spectral bin of output 1 is summed with that in the first spectral bin of output 2 to obtain the value for the first frequency bin of the summed spectrum.

Method (b): Measure and sum spectral maxima across the outputs.

The measurement on each individual output were performed with the same span and number on each individual output. The maximum value (peak) of each spectrum is determined. These maximum values are then summed mathematically in linear power units across the outputs.

Method (c): Measure and add $10 \log(N_{ANT})$ dB, where N_{ANT} is the number of outputs.

The measurement on each individual output were performed with the same span and number on each individual output. The quantity $10 \log(N_{ANT})$ dB is added to each spectrum value before comparing to the emission limit.

3.3.4 Test Setup

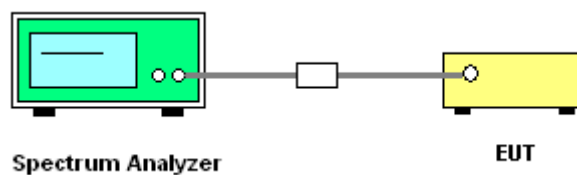

3.3.5 Test Result of Power Spectral Density

Please refer to Appendix A.



3.4 Unwanted Emissions Measurement

This section as specified in FCC Part 15.407(b) is to measure unwanted emissions through radiated measurement for band edge spurious emissions and out of band emissions measurement. The unwanted emissions shall comply with 15.407(b)(1) to (6), and restricted bands per FCC Part15.205.

3.4.1 Limit of Unwanted Emissions

- (1) For transmitters operating in the 5150-5250 MHz band: all emissions outside of the 5150-5350 MHz band shall not exceed an EIRP of -27dBm/MHz.

For transmitters operating in the 5250-5350 MHz band: all emissions outside of the 5150-5350 MHz band shall not exceed an EIRP of -27 dBm/MHz. Devices operating in the 5250-5350 MHz band that generate emissions in the 5150-5250 MHz band must meet all applicable technical requirements for operation in the 5150-5250 MHz band (including indoor use) or alternatively meet an out-of-band emission EIRP limit of -27 dBm/MHz in the 5150-5250 MHz band.

For transmitters operating in the 5470-5600 MHz and 5650-5725MHz band: all emissions outside of the 5470-5600 MHz and 5650-5725MHz band shall not exceed an EIRP of -27 dBm/MHz.

- (2) Unwanted spurious emissions fallen in restricted bands shall comply with the general field strength limits as below table,

Frequency (MHz)	Field Strength (microvolts/meter)	Measurement Distance (meters)
0.009 – 0.490	2400/F(kHz)	300
0.490 – 1.705	24000/F(kHz)	30
1.705 – 30.0	30	30
30 – 88	100	3
88 – 216	150	3
216 - 960	200	3
Above 960	500	3



(3) EIRP (dBm)	Field Strength at 3m (dBμV/m)
- 27	68.3

Note: The following formula is used to convert the EIRP to field strength.

$$EIRP = E_{Meas} + 20\log (d_{Meas}) - 104.7$$

where

EIRP is the equivalent isotropically radiated power, in dBm

E_{Meas} is the field strength of the emission at the measurement distance, in dBμV/m

d_{Meas} is the measurement distance, in m

(4) ANSI C63.10-2013 clause 12.7.3 note 97

As specified by regulatory requirements, emissions above 1000 MHz that are outside of the restricted bands are subject to a peak emission limit. However, an out-of-band emission that complies with both the average and peak general regulatory limits is not required to satisfy the peak emission limit.

3.4.2 Measuring Instruments

The measuring equipment is listed in the section 4 of this test report.



3.4.3 Test Procedures

1. The testing follows FCC KDB 789033 D02 General UNII Test Procedures New Rules v01r04. Section G) Unwanted emissions measurement.
 - (1) Procedure for Unwanted Emissions Measurements Below 1000MHz
 - RBW = 120 kHz
 - VBW = 300 kHz
 - Detector = Peak
 - Trace mode = max hold
 - (2) Procedure for Peak Unwanted Emissions Measurements Above 1000 MHz
 - RBW = 1 MHz
 - VBW \geq 3 MHz
 - Detector = Peak
 - Sweep time = auto
 - Trace mode = max hold
 - (3) Procedures for Average Unwanted Emissions Measurements Above 1000MHz
 - RBW = 1 MHz
 - VBW = 10 Hz, when duty cycle is no less than 98 percent.
 - VBW \geq 1/T, when duty cycle is less than 98 percent where T is the minimum transmission duration over which the transmitter is on and is transmitting at its maximum power control level for the tested mode of operation.
2. The EUT was placed on a turntable with 0.8 meter for frequency below 1GHz and 1.5 meter for frequency above 1GHz respectively above ground.
3. The EUT was set 3 meters from the interference receiving antenna which was mounted on the top of a variable height antenna tower.
4. The antenna is a broadband antenna and its height is adjusted between one meter and four meters above ground to find the maximum value of the field strength for both horizontal polarization and vertical polarization of the antenna.
5. For each suspected emission, the EUT was arranged to its worst case and then adjust the antenna tower (from 1 m to 4 m) and turntable (from 0 degree to 360 degrees) to find the maximum reading.
6. For testing below 1GHz, if the emission level of the EUT in peak mode was 3 dB lower than the limit specified, then peak values of EUT will be reported, otherwise, the emissions will be repeated one by one using the CISPR quasi-peak method and reported.
7. For testing above 1GHz, the emission level of the EUT in peak mode was 20dB lower than average limit (that means the emission level in average mode also complies with the limit in average mode), then peak values of EUT will be reported, otherwise, the emissions will be measured in average mode again and reported.

3.4.4 Test Setup

For radiated emissions below 30MHz

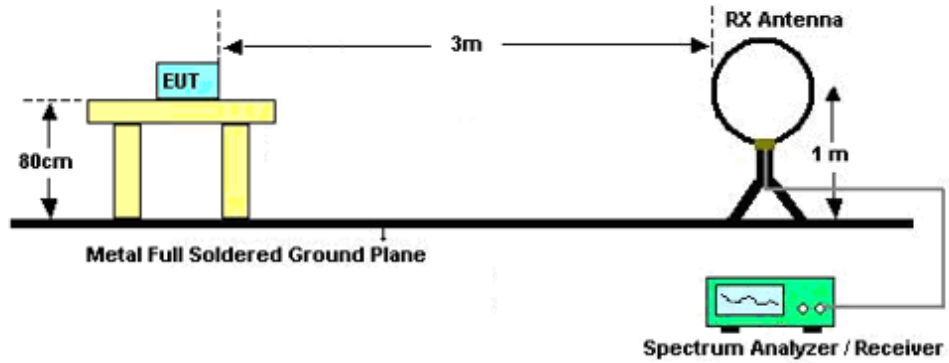

For radiated emissions from 30MHz to 1GHz

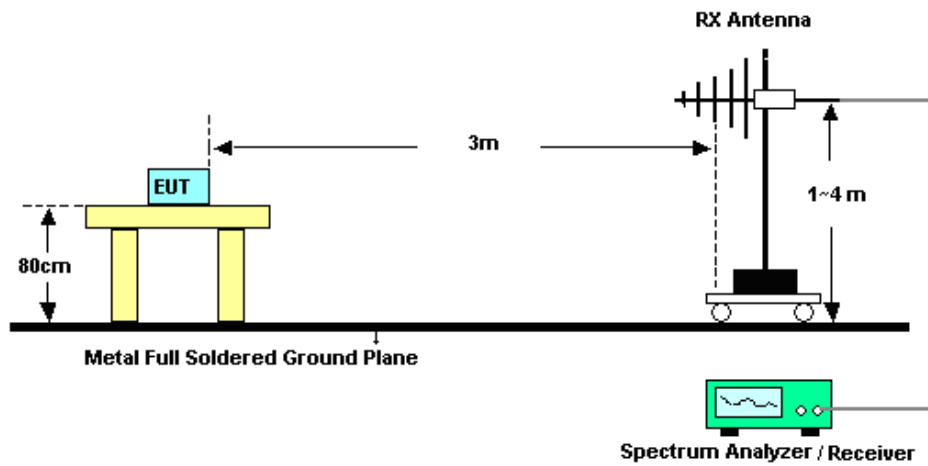

For radiated emissions above 1GHz

<CDD Mode>

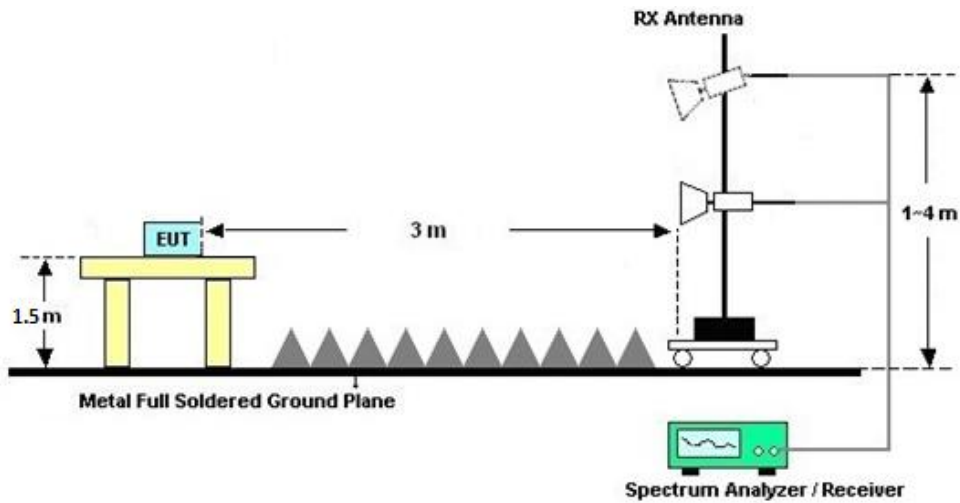

3.4.5 Test Results of Radiated Spurious Emissions (9 kHz ~ 30 MHz)

The low frequency, which started from 9 kHz to 30MHz, was pre-scanned and the result which was 20dB lower than the limit line was not reported.

There is a comparison data of both open-field test site and semi-Anechoic chamber, and the result came out very similar.

3.4.6 Test Result of Radiated Spurious at Band Edges

Please refer to Appendix C.

3.4.7 Duty Cycle

Please refer to Appendix D.

3.4.8 Test Result of Radiated Spurious Emissions (30MHz ~ 10th Harmonic)

Please refer to Appendix C.



3.5 AC Conducted Emission Measurement

3.5.1 Limit of AC Conducted Emission

For equipment that is designed to be connected to the public utility (AC) power line, the radio frequency voltage that is conducted back onto the AC power line on any frequency or frequencies within the band 150 kHz to 30 MHz shall not exceed the limits in the following table.

Frequency of emission (MHz)	Conducted limit (dBµV)	
	Quasi-peak	Average
0.15-0.5	66 to 56*	56 to 46*
0.5-5	56	46
5-30	60	50

*Decreases with the logarithm of the frequency.

3.5.2 Measuring Instruments

The measuring equipment is listed in the section 4 of this test report.

3.5.3 Test Procedures

1. The EUT was placed 0.4 meter from the conducting wall of the shielding room was kept at least 80 centimeters from any other grounded conducting surface.
2. Connect EUT to the power mains through a line impedance stabilization network (LISN).
3. All the support units are connecting to the other LISN.
4. The LISN provides 50 ohm coupling impedance for the measuring instrument.
5. The FCC states that a 50 ohm, 50 microhenry LISN should be used.
6. Both sides of AC line were checked for maximum conducted interference.
7. The frequency range from 150 kHz to 30 MHz was searched.
8. Set the test-receiver system to Peak Detect Function and specified bandwidth with Maximum Hold Mode.

3.5.4 Test Setup

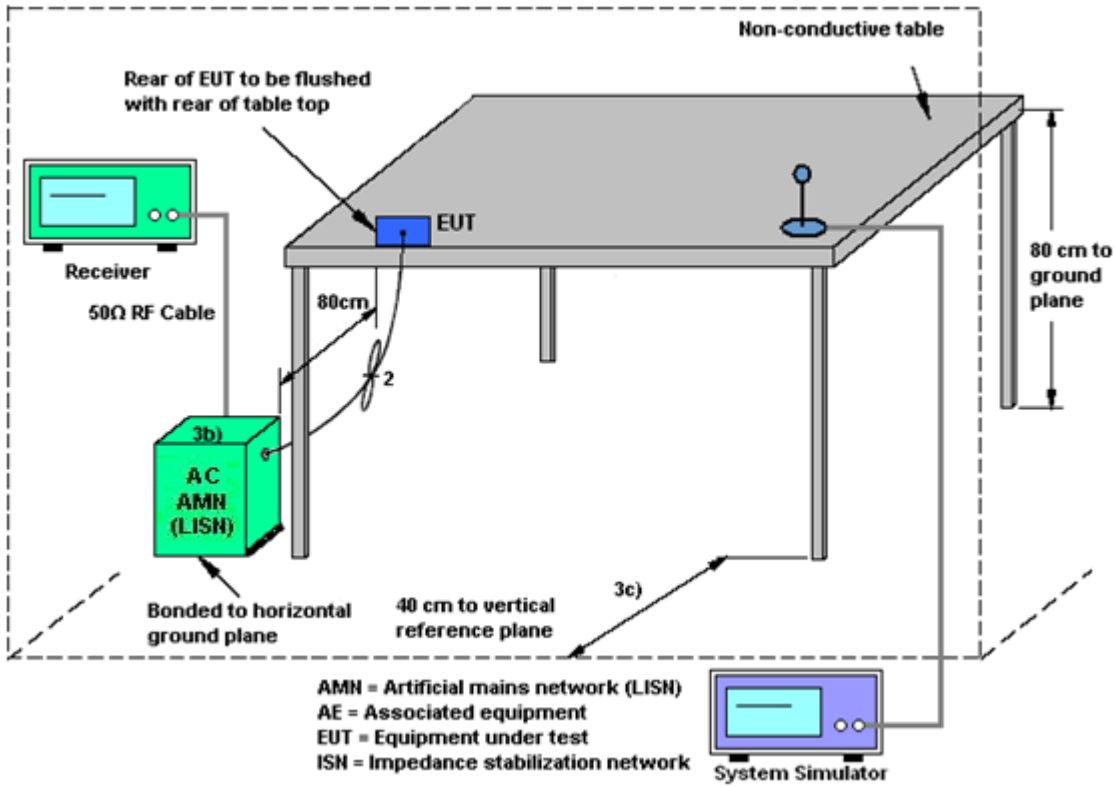

3.5.5 Test Result of AC Conducted Emission

Please refer to Appendix B.



3.6 Antenna Requirements

3.6.1 Standard Applicable

According to FCC 47 CFR Section 15.407(a)(1)(2) ,if transmitting antenna directional gain is greater than 6 dBi, both the peak transmit power and the peak power spectral density shall be reduced by the amount in dB that the directional gain of the antenna exceeds 6 dBi.

3.6.2 Antenna Anti-Replacement Construction

An embedded-in antenna design is used.

3.6.3 Antenna Gain

<CDD Modes >

FCC KDB 662911 D01 Multiple Transmitter Output v02r01

For CDD transmissions, directional gain is calculated as

Directional gain = GANT + Array Gain, where Array Gain is as follows.

For power spectral density (PSD) measurements on all devices,

Array Gain = 10 log(NANT/NSS=1) dB.

For power measurements on IEEE 802.11 devices,

Array Gain = 0 dB (i.e., no array gain) for NANT ≤ 4.

Directional gain may be calculated by using the formulas applicable to equal gain antennas with GANT set equal to the gain of the antenna having the highest gain;

The EUT supports CDD mode.

For power, the directional gain GANT is set equal to the antenna having the highest gain, i.e., F)2)f)i).

For PSD, the directional gain calculation is following F)2)f)ii) of KDB 662911 D01 v02r01.

The power and PSD limit should be modified if the directional gain of EUT is over 6 dBi,

The directional gain “DG” is calculated as following table.

<CDD Modes>						
	Ant. 1	Ant. 2	DG for Power	DG for PSD	Power Limit Reduction	PSD Limit Reduction
	(dBi)	(dBi)	(dBi)	(dBi)	(dB)	(dB)
Band I	-3.10	-3.20	-3.10	-0.14	0.00	0.00
Band II	-3.30	-3.30	-3.30	-0.29	0.00	0.00
Band III	-3.20	-3.20	-3.20	-0.19	0.00	0.00
Band IV	-3.30	-3.40	-3.30	-0.34	0.00	0.00

Power limit reduction = Composite gain – 6dBi, (min = 0)

PSD limit reduction = Composite gain + PSD Array gain – 6dBi, (min = 0)



4 List of Measuring Equipment

Instrument	Manufacturer	Model No.	Serial No.	Characteristics	Calibration Date	Test Date	Due Date	Remark
Spectrum Analyzer	R&S	FSV40	101040	10Hz~40GHz	Oct. 14, 2021	Jun. 11, 2022 ~Jul. 09, 2022	Oct. 13, 2022	Conducted (TH01-KS)
Pulse Power Senor	Anritsu	MA2411B	0917070	300MHz~40GHz	Jan. 05, 2022	Jun. 11, 2022 ~Jul. 09, 2022	Jan. 04, 2023	Conducted (TH01-KS)
Power Meter	Anritsu	ML2495A	1005002	50MHz Bandwidth	Jan. 05, 2022	Jun. 11, 2022 ~Jul. 09, 2022	Jan. 04, 2023	Conducted (TH01-KS)
EMI Test Receiver	R&S	ESR7	101403	9kHz~7GHz;Max 30dBm	Oct. 16, 2021	Jun. 02, 2022 ~Jul. 05, 2022	Oct. 15, 2022	Radiation (03CH07-KS)
EXA Spectrum Analyzer	Keysight	N9010A	MY55370528	10Hz~44GHz,MAX 30dB	Oct. 16, 2021	Jun. 02, 2022 ~Jul. 05, 2022	Oct. 15, 2022	Radiation (03CH07-KS)
Loop Antenna	R&S	HFH2-Z2	100321	9kHz~30MHz	Oct. 30, 2021	Jun. 02, 2022 ~Jul. 05, 2022	Oct. 29, 2022	Radiation (03CH07-KS)
Bilog Antenna	TeseQ	CBL6111D	44483	30MHz~1GHz	Dec. 22, 2021	Jun. 02, 2022 ~Jul. 05, 2022	Dec. 21, 2022	Radiation (03CH07-KS)
Double Ridge Horn Antenna	ETS-Lindgren	3117	00240132	1GHz~18GHz	Jul. 19, 2021	Jun. 02, 2022 ~Jul. 05, 2022	Jul. 18, 2022	Radiation (03CH07-KS)
high gain Amplifier	MITEQ	AMF-7D-0010 1800-30-10P	2025788	1Ghz-18Ghz	Jul. 30, 2021	Jun. 02, 2022 ~Jul. 05, 2022	Jul. 29, 2023	Radiation (03CH07-KS)
SHF-EHF Horn	Com-power	AH-840	101070	18GHz~40GHz	Jan. 05, 2022	Jun. 02, 2022 ~Jul. 05, 2022	Jan. 04, 2023	Radiation (03CH07-KS)
Amplifier	SONOMA	310N	413740	9KHz-1GHz	Jan. 05, 2022	Jun. 02, 2022 ~Jul. 05, 2022	Jan. 04, 2023	Radiation (03CH07-KS)
Amplifier	Keysight	83017A	MY53270316	500MHz~26.5GHz	Oct. 16, 2021	Jun. 02, 2022 ~Jul. 05, 2022	Oct. 15, 2022	Radiation (03CH07-KS)
Amplifier	MITEQ	EM18G40GG A	060728	18~40GHz	Jan. 05, 2022	Jun. 02, 2022 ~Jul. 05, 2022	Jan. 04, 2023	Radiation (03CH07-KS)
AC Power Source	Chroma	61601	616010002 473	N/A	NCR	Jun. 02, 2022 ~Jul. 05, 2022	NCR	Radiation (03CH07-KS)
Turn Table	MF	MF7802	N/A	0~360 degree	NCR	Jun. 02, 2022 ~Jul. 05, 2022	NCR	Radiation (03CH07-KS)
Antenna Mast	MF	MF7802	N/A	1 m~4 m	NCR	Jun. 02, 2022 ~Jul. 05, 2022	NCR	Radiation (03CH07-KS)
EMI Receiver	R&S	ESCI7	100768	9kHz~7GHz;	May. 24, 2022	Jun. 21, 2022 ~Jun. 22, 2022	May. 23, 2023	Conduction (CO01-KS)
AC LISN (for auxiliary equipment)	MessTec	AN3016	060103	9kHz~30MHz	Oct. 14, 2021	Jun. 21, 2022 ~Jun. 22, 2022	Oct. 13, 2022	Conduction (CO01-KS)
AC LISN	MessTec	AN3016	060105	9kHz~30MHz	May. 24, 2022	Jun. 21, 2022 ~Jun. 22, 2022	May. 23, 2023	Conduction (CO01-KS)
AC Power Source	Chroma	61602	ABP00000 0811	AC 0V~300V, 45Hz~1000Hz	Oct. 14, 2021	Jun. 21, 2022 ~Jun. 22, 2022	Oct. 13, 2022	Conduction (CO01-KS)

NCR: No Calibration Required



5 Uncertainty of Evaluation

The measurement uncertainties shown below were calculated in accordance with the requirements of ANSI 63.10-2013. All the measurement uncertainty value were shown with a coverage K=2 to indicate 95% level of confidence. The measurement data show herein meets or exceeds the CISPR measurement uncertainty values specified in CISPR 16-4-2 and can be compared directly to specified limit to determine compliance.

Uncertainty of Conducted Emission Measurement (150kHz ~ 30MHz)

Measuring Uncertainty for a Level of Confidence of 95% (U = 2Uc(y))	0.92dB
---	--------

Uncertainty of Radiated Emission Measurement (30 MHz ~ 1000 MHz)

Measuring Uncertainty for a Level of Confidence of 95% (U = 2Uc(y))	5.0dB
---	-------

Uncertainty of Radiated Emission Measurement (1000 MHz ~ 18000 MHz)

Measuring Uncertainty for a Level of Confidence of 95% (U = 2Uc(y))	5.0dB
---	-------

Uncertainty of Radiated Emission Measurement (18000 MHz ~ 40000 MHz)

Measuring Uncertainty for a Level of Confidence of 95% (U = 2Uc(y))	5.0dB
---	-------



Appendix A. Conducted Test Results

Appendix A. Test Result of Conducted Test Items

Test Engineer:	Gene Wang	Temperature:	21~25	°C
Test Date:	2022/7/1~2022/7/9	Relative Humidity:	51~54	%
Tool & Version				

TEST RESULTS DATA
Average Power Table

FCC U-NII-1 MIMO												
Mod.	Data Rate	NTX	CH.	Freq. (MHz)	Average Conducted Power with duty factor (dBm)			FCC Conducted Power Limit (dBm)		DG (dBi)		Pass/Fail
					Ant 1	Ant 2	SUM	Ant 1	Ant 2	Ant 1	Ant 2	
11a	6Mbps	2	36	5180	15.62	16.37	19.02	24.00		-3.10		Pass
11a	6Mbps	2	44	5220	17.25	17.76	20.53	24.00		-3.10		Pass
11a	6Mbps	2	48	5240	17.21	17.95	20.61	24.00		-3.10		Pass
HT20	MCS0	2	36	5180	15.72	17.16	19.51	24.00		-3.10		Pass
HT20	MCS0	2	44	5220	17.53	17.98	20.77	24.00		-3.10		Pass
HT20	MCS0	2	48	5240	17.48	18.21	20.87	24.00		-3.10		Pass
HT40	MCS0	2	38	5190	15.41	16.30	18.89	24.00		-3.10		Pass
HT40	MCS0	2	46	5230	17.68	17.99	20.85	24.00		-3.10		Pass
VHT20	MCS0	2	36	5180	15.79	17.22	19.57	24.00		-3.10		Pass
VHT20	MCS0	2	44	5220	17.61	18.09	20.87	24.00		-3.10		Pass
VHT20	MCS0	2	48	5240	17.54	18.27	20.93	24.00		-3.10		Pass
VHT40	MCS0	2	38	5190	15.47	16.38	18.96	24.00		-3.10		Pass
VHT40	MCS0	2	46	5230	17.77	18.08	20.94	24.00		-3.10		Pass
VHT80	MCS0	2	42	5210	15.05	16.02	18.57	24.00		-3.10		Pass
VHT160	MCS0	2	50	5250	13.49	14.58	17.08	24.00		-3.10		Pass

TEST RESULTS DATA
Average Power Table

FCC U-NII-2A MIMO													
Mod.	Data Rate	NTX	CH.	Freq. (MHz)	Average Conducted Power with duty factor (dBm)			FCC Conducted Power Limit (dBm)		DG (dBi)		EIRP Power Limit (dBm)	Pass/Fail
					Ant 1	Ant 2	SUM	Ant 1	Ant 2	Ant 1	Ant 2		
11a	6Mbps	2	52	5260	17.24	17.91	20.60	23.98		-3.30		26.99	Pass
11a	6Mbps	2	60	5300	17.15	17.93	20.57	23.98		-3.30		26.99	Pass
11a	6Mbps	2	64	5320	17.27	17.80	20.56	23.98		-3.30		26.99	Pass
HT20	MCS0	2	52	5260	17.44	18.14	20.81	23.98		-3.30		26.99	Pass
HT20	MCS0	2	60	5300	17.48	18.23	20.88	23.98		-3.30		26.99	Pass
HT20	MCS0	2	64	5320	16.91	17.53	20.24	23.98		-3.30		26.99	Pass
HT40	MCS0	2	54	5270	17.67	18.18	20.94	23.98		-3.30		26.99	Pass
HT40	MCS0	2	62	5310	16.28	16.03	19.17	23.98		-3.30		26.99	Pass
VHT20	MCS0	2	52	5260	17.51	18.22	20.89	23.98		-3.30		26.99	Pass
VHT20	MCS0	2	60	5300	17.54	18.31	20.95	23.98		-3.30		26.99	Pass
VHT20	MCS0	2	64	5320	16.98	17.67	20.35	23.98		-3.30		26.99	Pass
VHT40	MCS0	2	54	5270	17.75	18.26	21.02	23.98		-3.30		26.99	Pass
VHT40	MCS0	2	62	5310	16.32	16.05	19.20	23.98		-3.30		26.99	Pass
VHT80	MCS0	2	58	5290	15.29	15.76	18.54	23.98		-3.30		26.99	Pass

TEST RESULTS DATA
Average Power Table

FCC U-NII-2C MIMO													
Mod.	Data Rate	NTX	CH.	Freq. (MHz)	Average Conducted Power with duty factor (dBm)			FCC Conducted Power Limit (dBm)		DG (dBi)		EIRP Power Limit (dBm)	Pass/Fail
					Ant 1	Ant 2	SUM	Ant 1	Ant 2	Ant 1	Ant 2		
11a	6Mbps	2	100	5500	17.39	17.38	20.40	23.98		-3.20	26.99	Pass	
11a	6Mbps	2	116	5580	17.04	17.30	20.18	23.98		-3.20	26.99	Pass	
11a	6Mbps	2	140	5700	17.18	17.28	20.24	23.98		-3.20	26.99	Pass	
HT20	MCS0	2	100	5500	17.68	17.78	20.74	23.98		-3.20	26.99	Pass	
HT20	MCS0	2	116	5580	17.27	17.71	20.51	23.98		-3.20	26.99	Pass	
HT20	MCS0	2	140	5700	17.33	17.60	20.48	23.98		-3.20	26.99	Pass	
HT40	MCS0	2	102	5510	16.93	16.72	19.84	23.98		-3.20	26.99	Pass	
HT40	MCS0	2	110	5550	17.28	17.62	20.46	23.98		-3.20	26.99	Pass	
HT40	MCS0	2	134	5670	17.26	17.52	20.40	23.98		-3.20	26.99	Pass	
VHT20	MCS0	2	100	5500	17.77	17.88	20.84	23.98		-3.20	26.99	Pass	
VHT20	MCS0	2	116	5580	17.35	17.82	20.60	23.98		-3.20	26.99	Pass	
VHT20	MCS0	2	140	5700	17.45	17.68	20.58	23.98		-3.20	26.99	Pass	
VHT40	MCS0	2	102	5510	16.98	16.82	19.91	23.98		-3.20	26.99	Pass	
VHT40	MCS0	2	110	5550	17.36	17.71	20.55	23.98		-3.20	26.99	Pass	
VHT40	MCS0	2	134	5670	17.33	17.61	20.48	23.98		-3.20	26.99	Pass	
VHT80	MCS0	2	106	5530	13.53	14.88	17.27	23.98		-3.20	26.99	Pass	
VHT80	MCS0	2	122	5610	17.21	17.51	20.373	23.98		-3.20	26.99	Pass	
VHT160	MCS0	2	114	5570	11.68	12.62	15.19	23.98		-3.20	26.99	Pass	

FCC U-NII-2C straddle channel MIMO													
Mod.	Data Rate	NTX	CH.	Freq. (MHz)	Average Conducted Power with duty factor (dBm)			FCC Conducted Power Limit (dBm)		DG (dBi)		EIRP Power Limit (dBm)	Pass/Fail
					Ant 1	Ant 2	SUM	Ant 1	Ant 2	Ant 1	Ant 2		
11a	6Mbps	2	144	5720	17.22	17.09	20.17	23.98		-3.20	26.99	Pass	
HT20	MCS0	2	144	5720	17.41	17.46	20.45	23.98		-3.20	26.99	Pass	
HT40	MCS0	2	142	5710	17.48	17.48	20.49	23.98		-3.20	26.99	Pass	
VHT20	MCS0	2	144	5720	17.51	17.53	20.53	23.98		-3.20	26.99	Pass	
VHT40	MCS0	2	142	5710	17.57	17.59	20.59	23.98		-3.20	26.99	Pass	
VHT80	MCS0	2	138	5690	17.24	17.53	20.40	23.98		-3.20	26.99	Pass	

TEST RESULTS DATA
Average Power Table

FCC U-NII-1 MIMO													
Mod.	Data Rate	NTX	CH.	Freq. (MHz)	RU Config.	Average Conducted Power with duty factor (dBm)			FCC Conducted Power Limit (dBm)		DG (dBi)		Pass/Fail
						Ant 1	Ant 2	SUM	Ant 1	Ant 2	Ant 1	Ant 2	
HE20	MCS0	2	36	5180	Full	16.04	17.73	19.98	24.00		-3.10		Pass
HE20	MCS0	2	36	5180	26/0	7.35	8.18	10.80	24.00		-3.10		Pass
HE20	MCS0	2	36	5180	52/37	8.92	10.12	12.57	24.00		-3.10		Pass
HE20	MCS0	2	36	5180	106/53	12.48	13.81	16.21	24.00		-3.10		Pass
HE20	MCS0	2	44	5220	Full	18.02	18.88	21.48	24.00		-3.10		Pass
HE20	MCS0	2	44	5220	26/4	9.05	10.27	12.71	24.00		-3.10		Pass
HE20	MCS0	2	44	5220	52/38	10.50	11.63	14.11	24.00		-3.10		Pass
HE20	MCS0	2	44	5220	106/53	13.24	14.35	16.84	24.00		-3.10		Pass
HE20	MCS0	2	48	5240	Full	17.94	19.32	21.69	24.00		-3.10		Pass
HE20	MCS0	2	48	5240	26/8	7.61	9.26	11.52	24.00		-3.10		Pass
HE20	MCS0	2	48	5240	52/40	10.32	11.72	14.09	24.00		-3.10		Pass
HE20	MCS0	2	48	5240	106/54	13.23	14.33	16.83	24.00		-3.10		Pass
HE40	MCS0	2	38	5190	Full	15.93	16.86	19.43	24.00		-3.10		Pass
HE40	MCS0	2	38	5190	242/61	12.68	14.06	16.43	24.00		-3.10		Pass
HE40	MCS0	2	46	5230	Full	18.28	18.92	21.62	24.00		-3.10		Pass
HE40	MCS0	2	46	5230	242/62	14.43	15.01	17.74	24.00		-3.10		Pass
HE80	MCS0	2	42	5210	Full	15.58	16.34	18.99	24.00		-3.10		Pass
HE80	MCS0	2	42	5210	484/65	12.26	12.86	15.58	24.00		-3.10		Pass
HE160	MCS0	2	50	5250	Full	13.93	14.98	17.50	24.00		-3.10		Pass
HE160	MCS0	2	50	5250	996/67	10.57	11.35	13.98	24.00		-3.10		Pass
HE160	MCS0	2	50	5250	996/S67	10.64	11.46	14.08	24.00		-3.10		Pass

TEST RESULTS DATA
Average Power Table

FCC U-NII-2A MIMO														
Mod.	Data Rate	NTX	CH.	Freq. (MHz)	RU Config.	Average Conducted Power with duty factor (dBm)			FCC Conducted Power Limit (dBm)		DG (dBi)		EIRP Power Limit (dBm)	Pass/Fail
						Ant 1	Ant 2	SUM	Ant 1	Ant 2	Ant 1	Ant 2		
HE20	MCS0	2	52	5260	Full	18.03	19.29	21.72	23.98		-3.30	26.99	Pass	
HE20	MCS0	2	52	5260	26/0	7.51	8.48	11.03	23.98		-3.30	26.99	Pass	
HE20	MCS0	2	52	5260	52/37	10.65	11.54	14.13	23.98		-3.30	26.99	Pass	
HE20	MCS0	2	52	5260	106/53	14.02	14.72	17.39	23.98		-3.30	26.99	Pass	
HE20	MCS0	2	60	5300	Full	17.88	19.09	21.54	23.98		-3.30	26.99	Pass	
HE20	MCS0	2	60	5300	26/4	8.89	10.38	12.71	23.98		-3.30	26.99	Pass	
HE20	MCS0	2	60	5300	52/38	10.81	12.06	14.49	23.98		-3.30	26.99	Pass	
HE20	MCS0	2	60	5300	106/53	13.24	14.42	16.88	23.98		-3.30	26.99	Pass	
HE20	MCS0	2	64	5320	Full	17.51	18.82	21.22	23.98		-3.30	26.99	Pass	
HE20	MCS0	2	64	5320	26/8	7.49	8.88	11.25	23.98		-3.30	26.99	Pass	
HE20	MCS0	2	64	5320	52/40	10.21	11.49	13.91	23.98		-3.30	26.99	Pass	
HE20	MCS0	2	64	5320	106/54	13.09	14.53	16.88	23.98		-3.30	26.99	Pass	
HE40	MCS0	2	54	5270	Full	18.13	18.98	21.59	23.98		-3.30	26.99	Pass	
HE40	MCS0	2	54	5270	242/61	14.32	15.09	17.73	23.98		-3.30	26.99	Pass	
HE40	MCS0	2	62	5310	Full	16.61	16.56	19.60	23.98		-3.30	26.99	Pass	
HE40	MCS0	2	62	5310	242/62	11.77	13.17	15.54	23.98		-3.30	26.99	Pass	
HE80	MCS0	2	58	5290	Full	15.73	16.22	18.99	23.98		-3.30	26.99	Pass	
HE80	MCS0	2	58	5290	484/66	12.36	13.11	15.76	23.98		-3.30	26.99	Pass	

TEST RESULTS DATA
Average Power Table

FCC U-NII-2C MIMO														
Mod.	Data Rate	NTX	CH.	Freq. (MHz)	RU Config.	Average Conducted Power with duty factor (dBm)			FCC Conducted Power Limit (dBm)		DG (dBi)		EIRP Power Limit (dBm)	Pass/Fail
						Ant 1	Ant 2	SUM	Ant 1	Ant 2	Ant 1	Ant 2		
HE20	MCS0	2	100	5500	Full	18.32	19.03	21.70	23.98		-3.20	26.99	Pass	
HE20	MCS0	2	100	5500	26/0	7.70	8.62	11.19	23.98		-3.20	26.99	Pass	
HE20	MCS0	2	100	5500	52/37	10.66	11.35	14.03	23.98		-3.20	26.99	Pass	
HE20	MCS0	2	100	5500	106/53	13.60	14.46	17.06	23.98		-3.20	26.99	Pass	
HE20	MCS0	2	116	5580	Full	17.99	18.95	21.51	23.98		-3.20	26.99	Pass	
HE20	MCS0	2	116	5580	26/4	7.82	9.51	11.76	23.98		-3.20	26.99	Pass	
HE20	MCS0	2	116	5580	52/38	10.40	11.26	13.86	23.98		-3.20	26.99	Pass	
HE20	MCS0	2	116	5580	106/53	13.16	14.49	16.89	23.98		-3.20	26.99	Pass	
HE20	MCS0	2	140	5700	Full	17.91	18.62	21.29	23.98		-3.20	26.99	Pass	
HE20	MCS0	2	140	5700	26/8	7.46	8.32	10.92	23.98		-3.20	26.99	Pass	
HE20	MCS0	2	140	5700	52/40	10.45	11.03	13.76	23.98		-3.20	26.99	Pass	
HE20	MCS0	2	140	5700	106/54	13.09	14.02	16.59	23.98		-3.20	26.99	Pass	
HE40	MCS0	2	102	5510	Full	17.31	17.62	20.48	23.98		-3.20	26.99	Pass	
HE40	MCS0	2	102	5510	242/61	13.48	14.18	16.85	23.98		-3.20	26.99	Pass	
HE40	MCS0	2	110	5550	Full	17.87	18.48	21.20	23.98		-3.20	26.99	Pass	
HE40	MCS0	2	110	5550	242/61	14.71	15.62	18.20	23.98		-3.20	26.99	Pass	
HE40	MCS0	2	134	5670	Full	17.93	18.27	21.11	23.98		-3.20	26.99	Pass	
HE40	MCS0	2	134	5670	242/62	13.55	14.99	17.34	23.98		-3.20	26.99	Pass	
HE80	MCS0	2	106	5530	Full	13.92	15.24	17.64	23.98		-3.20	26.99	Pass	
HE80	MCS0	2	106	5530	484/65	10.90	11.80	14.38	23.98		-3.20	26.99	Pass	
HE80	MCS0	2	122	5610	Full	17.96	18.56	21.28	23.98		-3.20	26.99	Pass	
HE80	MCS0	2	122	5610	484/66	14.25	15.65	18.02	23.98		-3.20	26.99	Pass	
HE160	MCS0	2	114	5570	Full	12.03	12.98	15.54	23.98		-3.20	26.99	Pass	
HE160	MCS0	2	114	5570	996/67	9.13	10.34	12.78	23.98		-3.20	26.99	Pass	
HE160	MCS0	2	114	5570	996/S67	9.11	10.55	12.90	23.98		-3.20	26.99	Pass	

FCC U-NII-2C straddle channel MIMO														
Mod.	Data Rate	NTX	CH.	Freq. (MHz)	RU Config.	Average Conducted Power with duty factor (dBm)			FCC Conducted Power Limit (dBm)		DG (dBi)		EIRP Power Limit (dBm)	Pass/Fail
						Ant 1	Ant 2	SUM	Ant 1	Ant 2	Ant 1	Ant 2		
HE20	MCS0	2	144	5720	Full	17.84	18.74	21.32	23.98		-3.20	26.99	Pass	
HE20	MCS0	2	144	5720	26/8	7.49	8.31	10.93	23.98		-3.20	26.99	Pass	
HE20	MCS0	2	144	5720	52/40	10.41	10.97	13.71	23.98		-3.20	26.99	Pass	
HE20	MCS0	2	144	5720	106/54	13.02	14.04	16.57	23.98		-3.20	26.99	Pass	
HE40	MCS0	2	142	5710	Full	17.85	18.45	21.17	23.98		-3.20	26.99	Pass	
HE40	MCS0	2	142	5710	242/62	13.76	14.51	17.16	23.98		-3.20	26.99	Pass	
HE80	MCS0	2	138	5690	Full	17.74	18.53	21.16	23.98		-3.20	26.99	Pass	
HE80	MCS0	2	138	5690	484/66	12.26	12.97	15.64	23.98		-3.20	26.99	Pass	

TEST RESULTS DATA
Average Power Table

U-NII-3 MIMO												
Mod.	Data Rate	NTX	CH.	Freq. (MHz)	Average Conducted Power with duty factor (dBm)			FCC Conducted Power Limit (dBm)		DG (dBi)		Pass/Fail
					Ant 1	Ant 2	SUM	Ant 1	Ant 2	Ant 1	Ant 2	
11a	6Mbps	2	149	5745	17.44	17.63	20.55	30.00		-3.30		Pass
11a	6Mbps	2	157	5785	17.58	17.92	20.77	30.00		-3.30		Pass
11a	6Mbps	2	165	5825	17.40	18.01	20.73	30.00		-3.30		Pass
HT20	MCS0	2	149	5745	17.22	17.36	20.30	30.00		-3.30		Pass
HT20	MCS0	2	157	5785	17.25	17.66	20.47	30.00		-3.30		Pass
HT20	MCS0	2	165	5825	17.18	17.71	20.46	30.00		-3.30		Pass
HT40	MCS0	2	151	5755	17.29	17.76	20.54	30.00		-3.30		Pass
HT40	MCS0	2	159	5795	17.39	17.64	20.53	30.00		-3.30		Pass
VHT20	MCS0	2	149	5745	17.27	17.45	20.37	30.00		-3.30		Pass
VHT20	MCS0	2	157	5785	17.31	17.84	20.59	30.00		-3.30		Pass
VHT20	MCS0	2	165	5825	17.23	17.80	20.53	30.00		-3.30		Pass
VHT40	MCS0	2	151	5755	17.36	17.85	20.62	30.00		-3.30		Pass
VHT40	MCS0	2	159	5795	17.44	17.77	20.62	30.00		-3.30		Pass
VHT80	MCS0	2	155	5775	17.23	17.68	20.47	30.00		-3.30		Pass

TEST RESULTS DATA
Average Power Table

U-NII-3 MIMO													
Mod.	Data Rate	NTX	CH.	Freq. (MHz)	RU Config.	Average Conducted Power with duty factor (dBm)			FCC Conducted Power Limit (dBm)		DG (dBi)		Pass/Fail
						Ant 1	Ant 2	SUM	Ant 1	Ant 2	Ant 1	Ant 2	
HE20	MCS0	2	149	5745	Full	17.91	18.53	21.24	30.00		-3.30		Pass
HE20	MCS0	2	149	5745	26/0	7.46	8.76	11.17	30.00		-3.30		Pass
HE20	MCS0	2	149	5745	52/37	10.77	11.87	14.37	30.00		-3.30		Pass
HE20	MCS0	2	149	5745	106/53	13.60	14.51	17.09	30.00		-3.30		Pass
HE20	MCS0	2	157	5785	Full	17.94	18.89	21.45	30.00		-3.30		Pass
HE20	MCS0	2	157	5785	26/4	7.77	9.22	11.57	30.00		-3.30		Pass
HE20	MCS0	2	157	5785	52/38	10.72	11.63	14.21	30.00		-3.30		Pass
HE20	MCS0	2	157	5785	106/53	13.47	14.81	17.20	30.00		-3.30		Pass
HE20	MCS0	2	165	5825	Full	17.99	18.98	21.52	30.00		-3.30		Pass
HE20	MCS0	2	165	5825	26/8	7.86	8.87	11.40	30.00		-3.30		Pass
HE20	MCS0	2	165	5825	52/40	11.01	12.22	14.67	30.00		-3.30		Pass
HE20	MCS0	2	165	5825	106/54	13.40	14.64	17.07	30.00		-3.30		Pass
HE40	MCS0	2	151	5755	Full	17.84	18.53	21.21	30.00		-3.30		Pass
HE40	MCS0	2	151	5755	242/61	14.62	15.76	18.24	30.00		-3.30		Pass
HE40	MCS0	2	159	5795	Full	17.80	18.69	21.28	30.00		-3.30		Pass
HE40	MCS0	2	159	5795	242/62	14.43	15.25	17.87	30.00		-3.30		Pass
HE80	MCS0	2	155	5775	Full	17.86	18.45	21.18	30.00		-3.30		Pass
HE80	MCS0	2	155	5775	484/65	13.96	15.49	17.80	30.00		-3.30		Pass
HE80	MCS0	2	155	5775	484/66	14.21	15.15	17.72	30.00		-3.30		Pass



Ambient Condition: 25 °C, 45 %RH,	
Test Date: 2022.6.11~2022.7.9	Test Engineer: Geng Wang

Emission Bandwidth

Test Result

TestMode	Antenna	Frequency[MHz]	26db EBW [MHz]	FL[MHz]	FH[MHz]	Limit[MHz]	Verdict
11A-CDD	Ant1	5180	19.88	5170.16	5190.04	---	---
	Ant2	5180	20.40	5169.88	5190.28	---	---
	Ant1	5220	20.08	5209.68	5229.76	---	---
	Ant2	5220	20.60	5209.64	5230.24	---	---
	Ant1	5240	20.32	5229.76	5250.08	---	---
	Ant2	5240	20.84	5229.72	5250.56	---	---
	Ant1	5260	20.00	5249.68	5269.68	---	---
	Ant2	5260	20.96	5249.32	5270.28	---	---
	Ant1	5300	19.76	5289.84	5309.60	---	---
	Ant2	5300	20.56	5289.68	5310.24	---	---
	Ant1	5320	19.80	5309.68	5329.48	---	---
	Ant2	5320	20.36	5309.84	5330.20	---	---
	Ant1	5500	19.12	5490.36	5509.48	---	---
	Ant2	5500	20.32	5489.88	5510.20	---	---
	Ant1	5580	19.12	5570.32	5589.44	---	---
	Ant2	5580	20.48	5569.76	5590.24	---	---
	Ant1	5700	19.88	5689.84	5709.72	---	---
	Ant2	5700	20.56	5689.64	5710.20	---	---
	Ant1	5720	19.96	5709.68	5729.64	---	---
	Ant2	5720	20.32	5709.92	5730.24	---	---
	Ant1	5720_UNII-2C	15.32	5709.68	5725	---	---
	Ant2	5720_UNII-2C	15.08	5709.92	5725	---	---
	Ant1	5720_UNII-3	4.64	5725	5729.64	---	---
	Ant2	5720_UNII-3	5.24	5725	5730.24	---	---
	Ant1	5745	20.00	5734.72	5754.72	---	---
	Ant2	5745	19.84	5734.96	5754.80	---	---
	Ant1	5785	20.00	5774.72	5794.72	---	---
	Ant2	5785	19.84	5774.96	5794.80	---	---
	Ant1	5825	19.96	5814.68	5834.64	---	---
	Ant2	5825	20.60	5814.64	5835.24	---	---



11AX20MIMO	Ant1	5180	21.56	5169.40	5190.96	---	---	
	Ant2	5180	21.60	5169.16	5190.76	---	---	
	Ant1	5220	21.12	5209.28	5230.40	---	---	
	Ant2	5220	21.32	5209.32	5230.64	---	---	
	Ant1	5240	20.92	5229.52	5250.44	---	---	
	Ant2	5240	22.36	5228.64	5251.00	---	---	
	Ant1	5260	22.04	5248.88	5270.92	---	---	
	Ant2	5260	21.72	5249.04	5270.76	---	---	
	Ant1	5300	21.44	5289.28	5310.72	---	---	
	Ant2	5300	21.52	5289.08	5310.60	---	---	
	Ant1	5320	21.40	5309.28	5330.68	---	---	
	Ant2	5320	21.56	5309.12	5330.68	---	---	
	Ant1	5500	20.68	5489.68	5510.36	---	---	
	Ant2	5500	21.16	5489.56	5510.72	---	---	
	Ant1	5580	20.92	5569.56	5590.48	---	---	
	Ant2	5580	22.08	5568.76	5590.84	---	---	
	Ant1	5700	20.84	5689.60	5710.44	---	---	
	Ant2	5700	22.64	5689.32	5711.96	---	---	
	Ant1	5720	21.24	5709.36	5730.60	---	---	
	Ant2	5720	22.12	5708.88	5731.00	---	---	
	Ant1	5720_UNII-2C	15.64	5709.36	5725	---	---	
	Ant2	5720_UNII-2C	16.12	5708.88	5725	---	---	
	Ant1	5720_UNII-3	5.6	5725	5730.60	---	---	
	Ant2	5720_UNII-3	6	5725	5731.00	---	---	
	Ant1	5745	21.16	5734.52	5755.68	---	---	
	Ant2	5745	20.92	5734.56	5755.48	---	---	
	Ant1	5785	21.24	5774.56	5795.80	---	---	
	Ant2	5785	21.04	5774.56	5795.60	---	---	
	Ant1	5825	21.16	5814.36	5835.52	---	---	
	Ant2	5825	22.80	5812.80	5835.60	---	---	
	11AX40MIMO	Ant1	5190	40.88	5169.68	5210.56	---	---
		Ant2	5190	41.28	5169.60	5210.88	---	---
Ant1		5230	41.52	5209.04	5250.56	---	---	
Ant2		5230	41.36	5209.44	5250.80	---	---	
Ant1		5270	41.04	5249.52	5290.56	---	---	
Ant2		5270	41.84	5249.12	5290.96	---	---	
Ant1		5310	40.64	5289.68	5330.32	---	---	
Ant2		5310	41.52	5289.28	5330.80	---	---	
Ant1		5510	40.88	5489.52	5530.40	---	---	
Ant2		5510	41.12	5489.60	5530.72	---	---	
Ant1		5550	40.88	5529.60	5570.48	---	---	
Ant2		5550	40.96	5529.60	5570.56	---	---	
Ant1		5670	41.28	5649.28	5690.56	---	---	
Ant2		5670	40.88	5649.68	5690.56	---	---	



	Ant1	5710	41.12	5689.44	5730.56	---	---
	Ant2	5710	41.04	5689.60	5730.64	---	---
	Ant1	5710_UNII-2C	35.56	5689.44	5725	---	---
	Ant2	5710_UNII-2C	35.4	5689.60	5725	---	---
	Ant1	5710_UNII-3	5.56	5725	5730.56	---	---
	Ant2	5710_UNII-3	5.64	5725	5730.64	---	---
	Ant1	5755	40.80	5734.68	5775.48	---	---
	Ant2	5755	40.80	5734.60	5775.40	---	---
	Ant1	5795	41.36	5774.44	5815.80	---	---
	Ant2	5795	41.12	5774.52	5815.64	---	---
11AX80MIMO	Ant1	5210	83.36	5168.72	5252.08	---	---
	Ant2	5210	83.52	5168.56	5252.08	---	---
	Ant1	5290	82.88	5248.56	5331.44	---	---
	Ant2	5290	83.36	5248.56	5331.92	---	---
	Ant1	5530	82.88	5488.56	5571.44	---	---
	Ant2	5530	83.04	5488.56	5571.60	---	---
	Ant1	5610	82.40	5568.88	5651.28	---	---
	Ant2	5610	82.72	5568.88	5651.60	---	---
	Ant1	5690	82.56	5648.88	5731.44	---	---
	Ant2	5690	82.72	5648.72	5731.44	---	---
	Ant1	5690_UNII-2C	76.12	5648.88	5725	---	---
	Ant2	5690_UNII-2C	76.28	5648.72	5725	---	---
	Ant1	5690_UNII-3	6.44	5725	5731.44	---	---
	Ant2	5690_UNII-3	6.44	5725	5731.44	---	---
	Ant1	5775	83.20	5733.40	5816.60	---	---
	Ant2	5775	82.88	5733.40	5816.28	---	---
11AX160MIMO	Ant1	5250	166.08	5166.80	5332.88	---	---
	Ant2	5250	165.76	5167.44	5333.20	---	---
	Ant1	5570	166.72	5486.48	5653.20	---	---
	Ant2	5570	165.12	5487.76	5652.88	---	---



Test Graphs

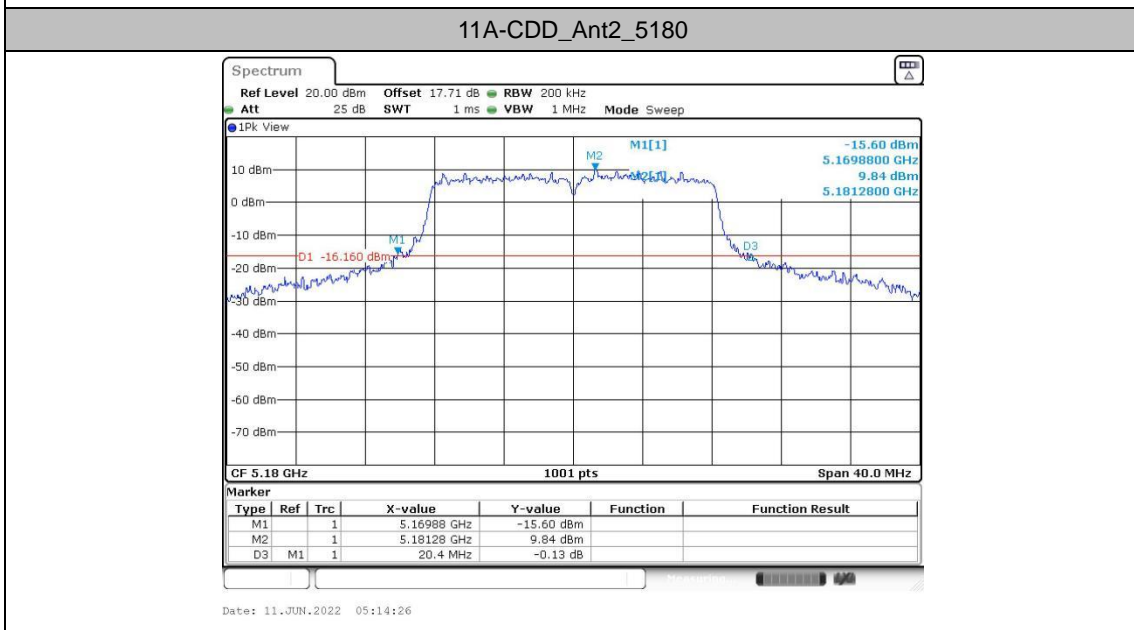
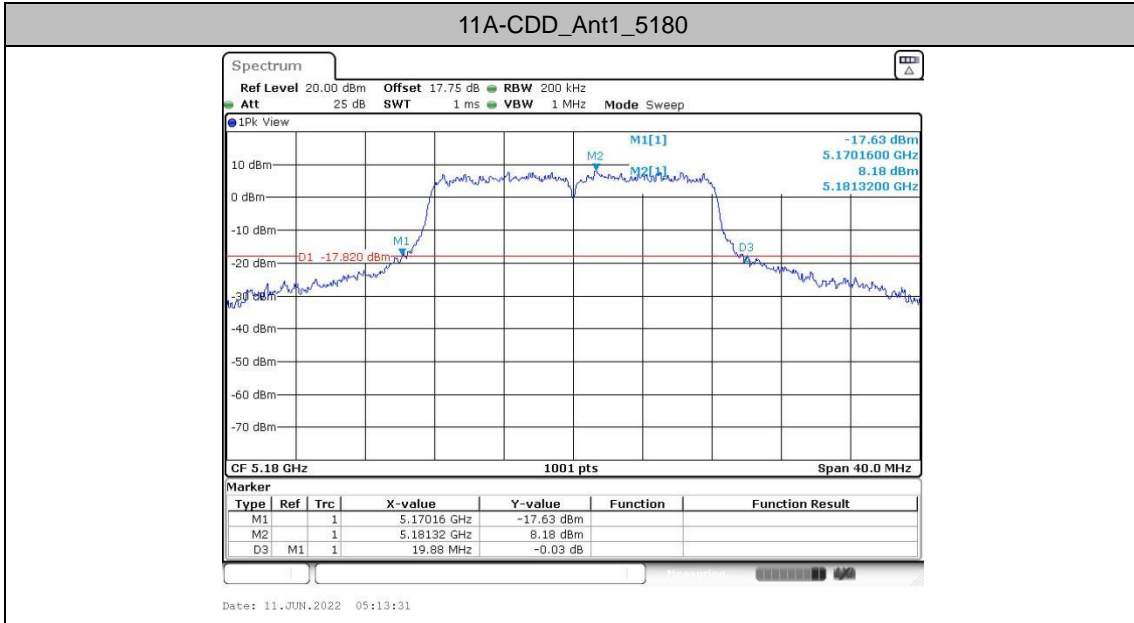



11A-CDD_Ant1_5220

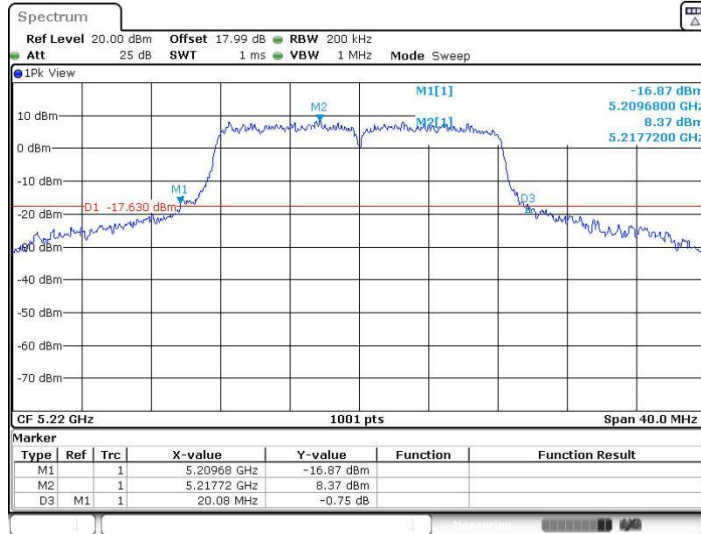

Date: 11.JUN.2022 05:19:40

11A-CDD_Ant2_5220

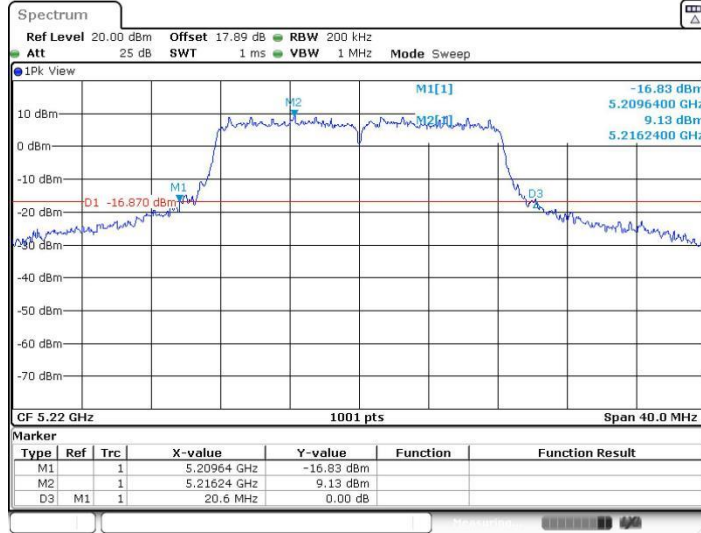

Date: 11.JUN.2022 05:20:35



11A-CDD_Ant1_5240

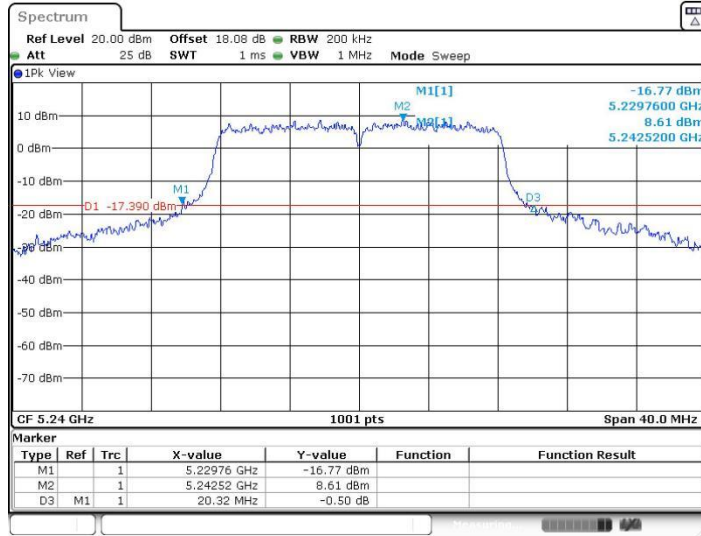

11A-CDD_Ant2_5240

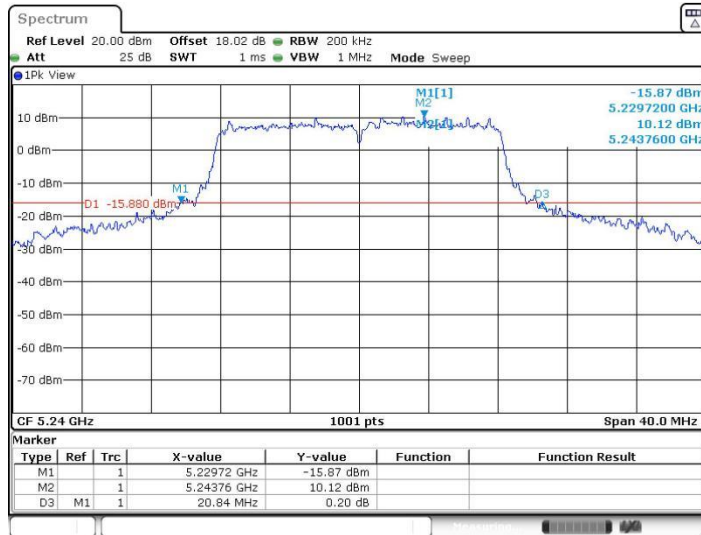



11A-CDD_Ant1_5260

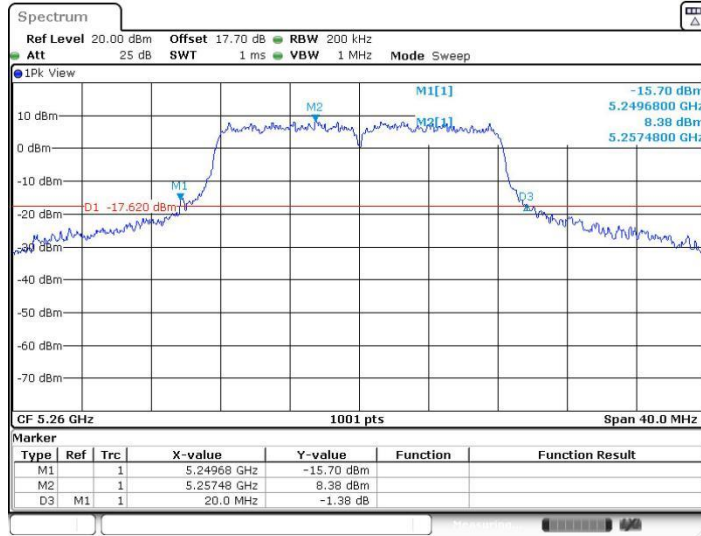

11A-CDD_Ant2_5260

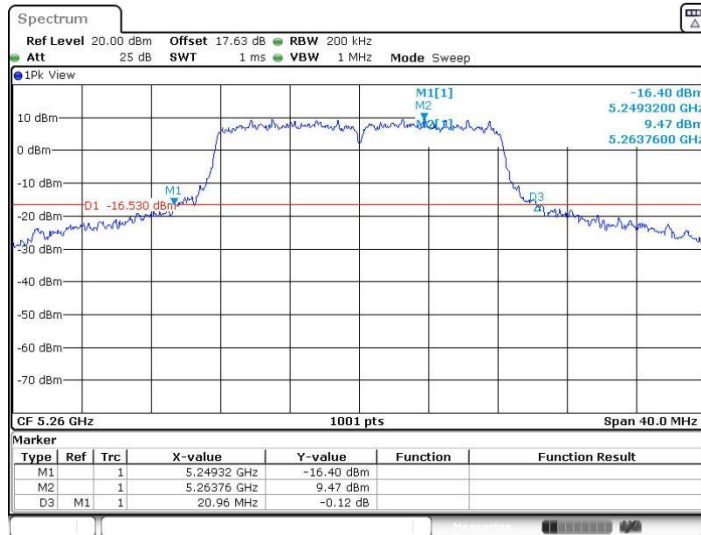



11A-CDD_Ant1_5300

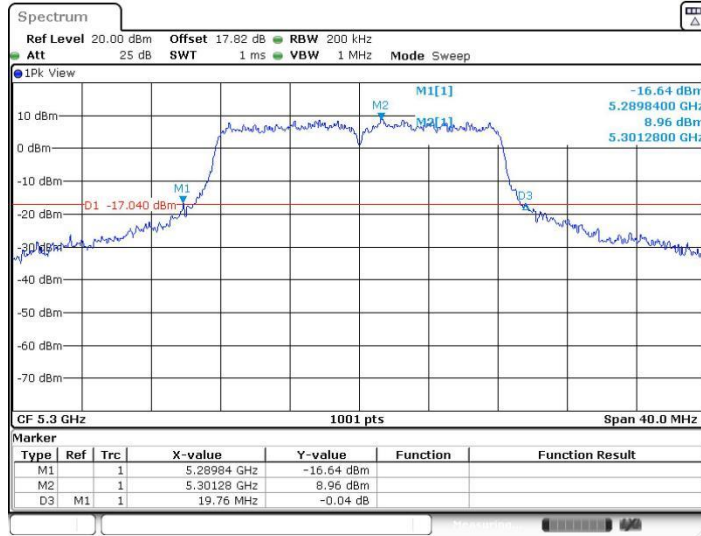

11A-CDD_Ant2_5300

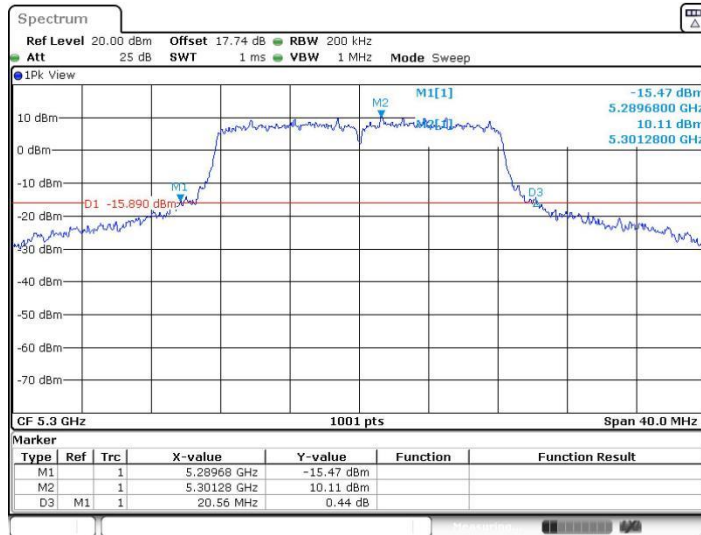



11A-CDD_Ant1_5320

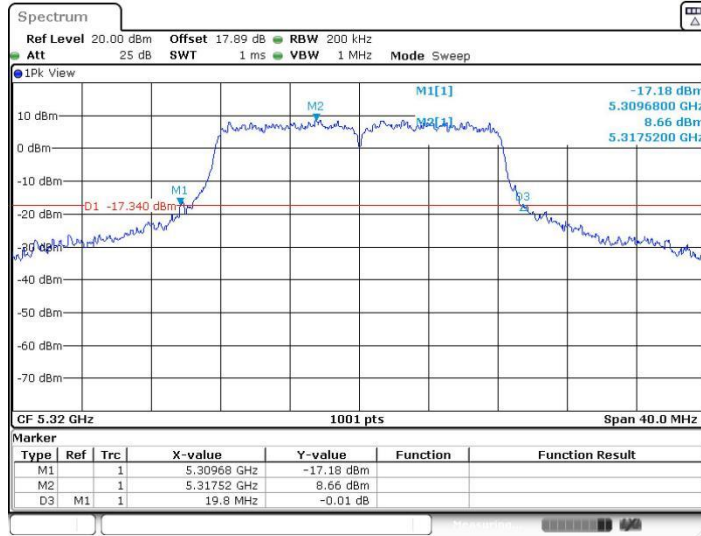

Date: 11.JUN.2022 05:29:38

11A-CDD_Ant2_5320

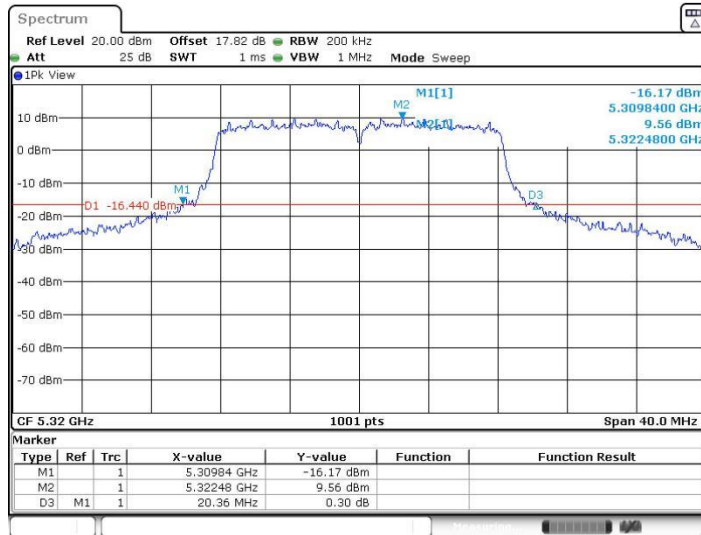

Date: 11.JUN.2022 05:30:38



11A-CDD_Ant1_5500

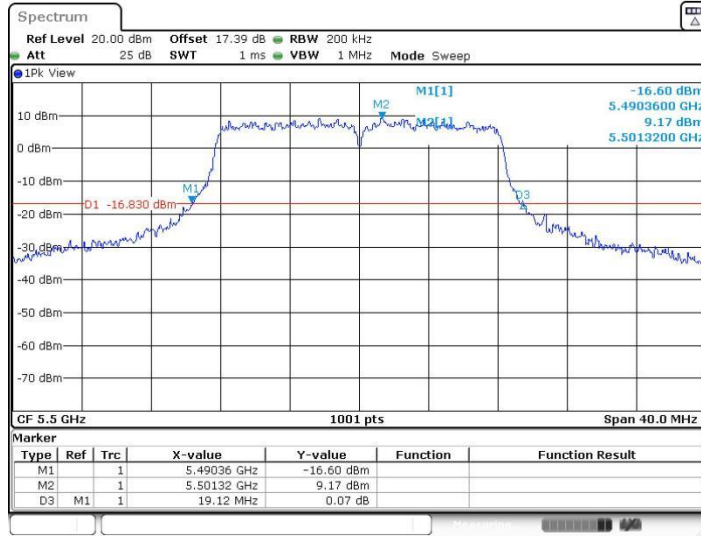

Date: 11.JUN.2022 05:31:56

11A-CDD_Ant2_5500

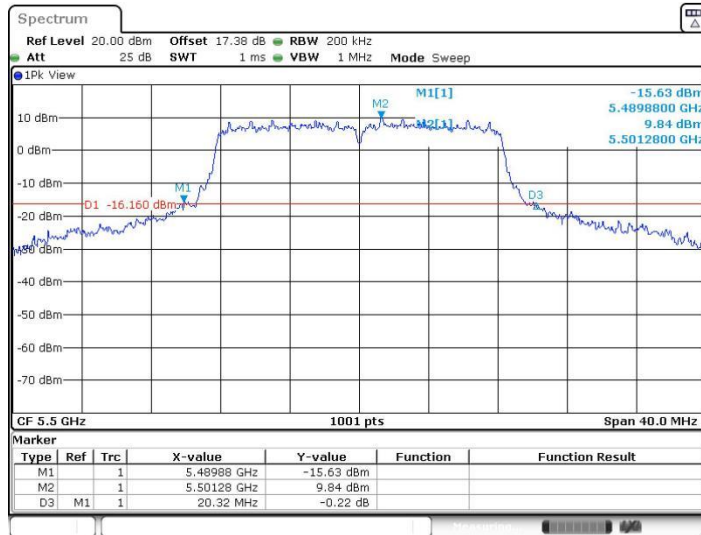

Date: 11.JUN.2022 05:32:51



11A-CDD_Ant1_5580

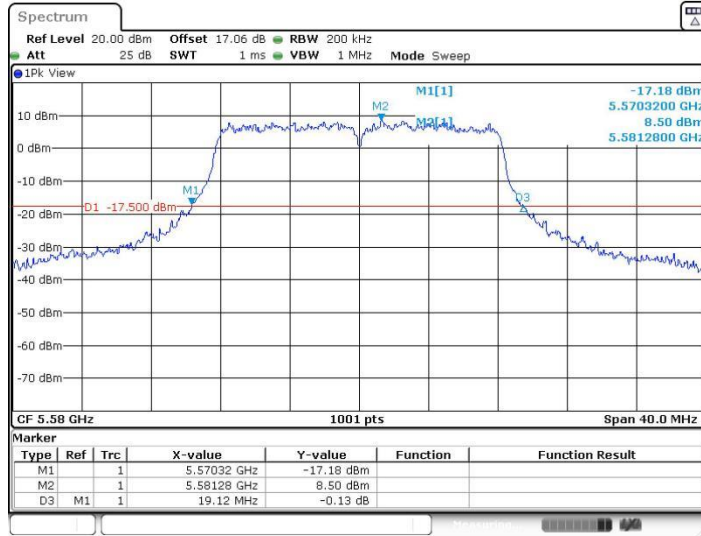

Date: 11.JUN.2022 05:35:43

11A-CDD_Ant2_5580

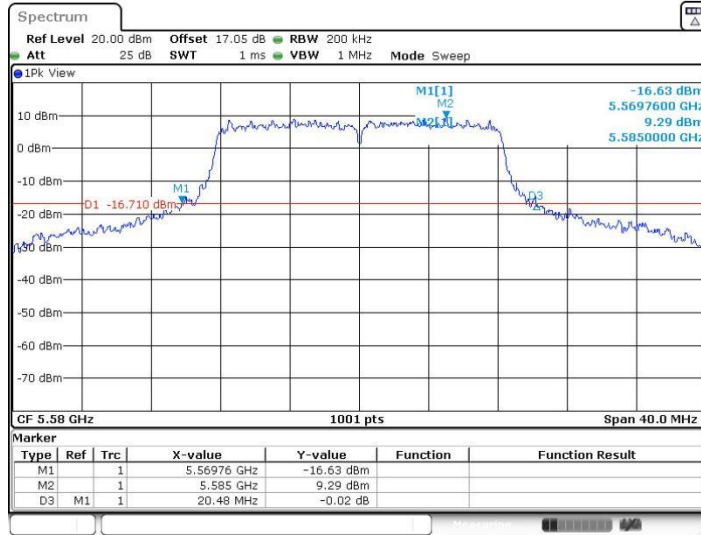

Date: 11.JUN.2022 05:36:41



11A-CDD_Ant1_5700

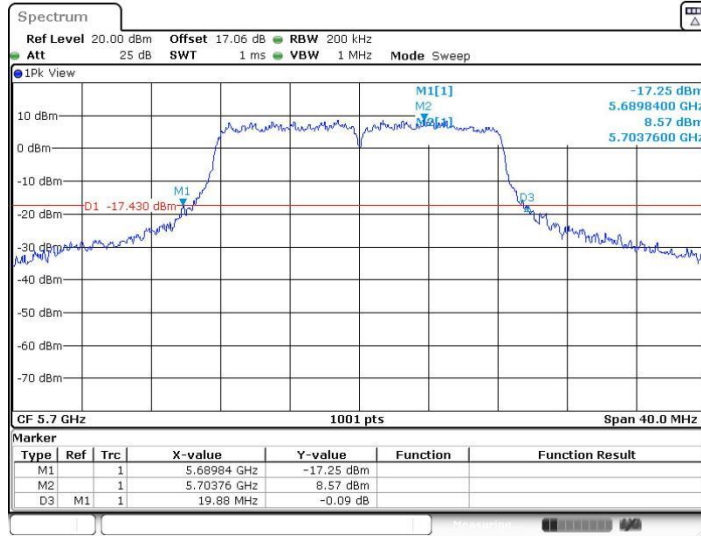

11A-CDD_Ant2_5700

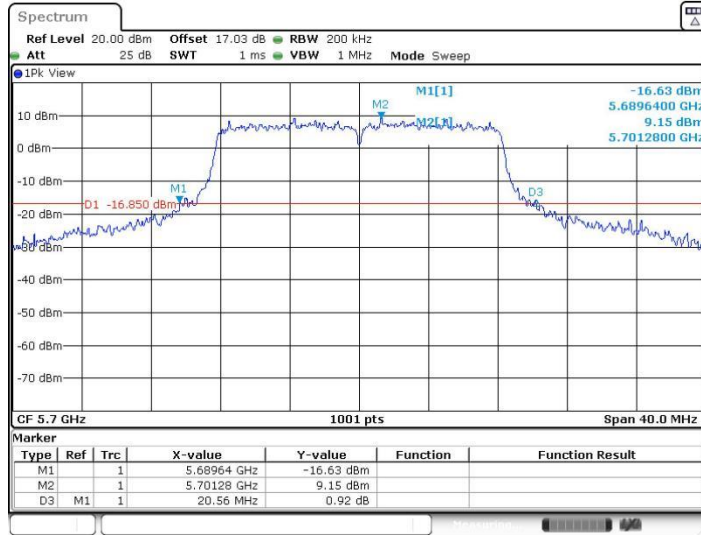



11A-CDD_Ant1_5720

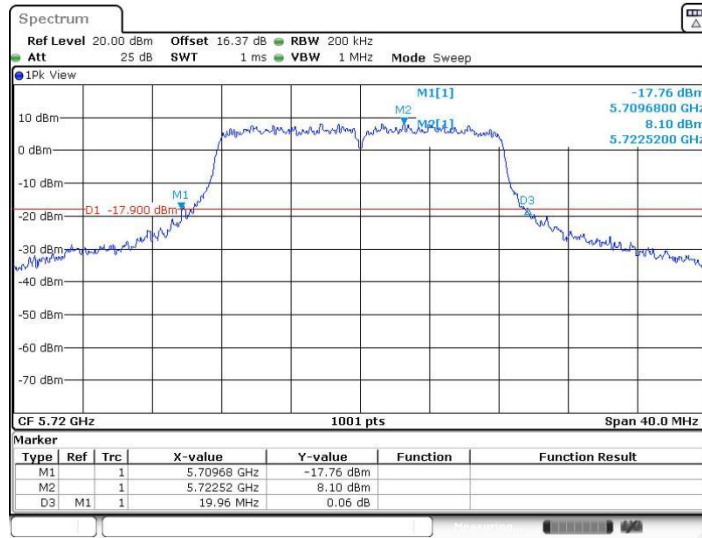

Date: 11.JUN.2022 08:16:18

11A-CDD_Ant2_5720

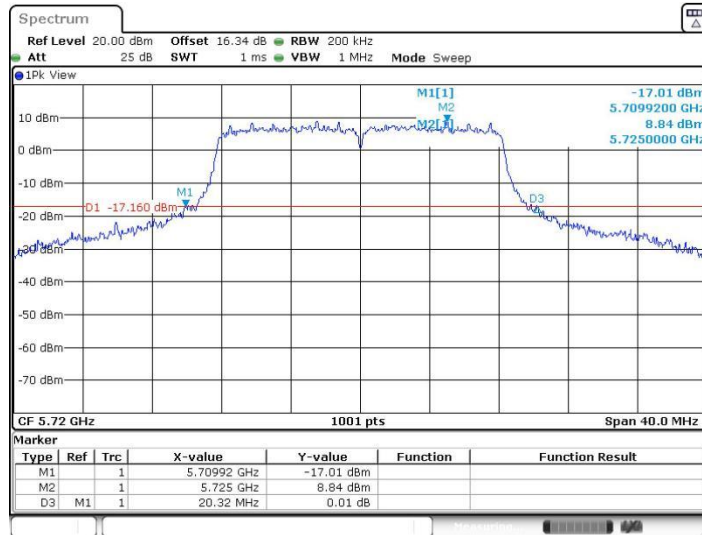

Date: 11.JUN.2022 08:17:27



11A-CDD_Ant1_5745

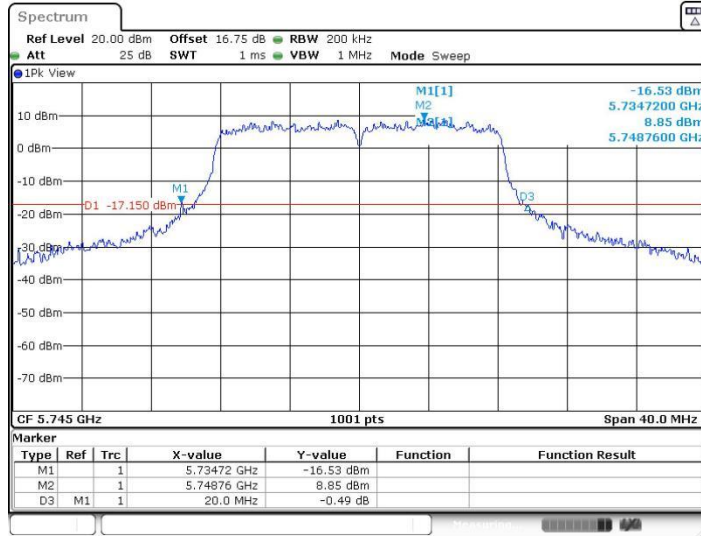

Date: 11.JUN.2022 05:40:03

11A-CDD_Ant2_5745

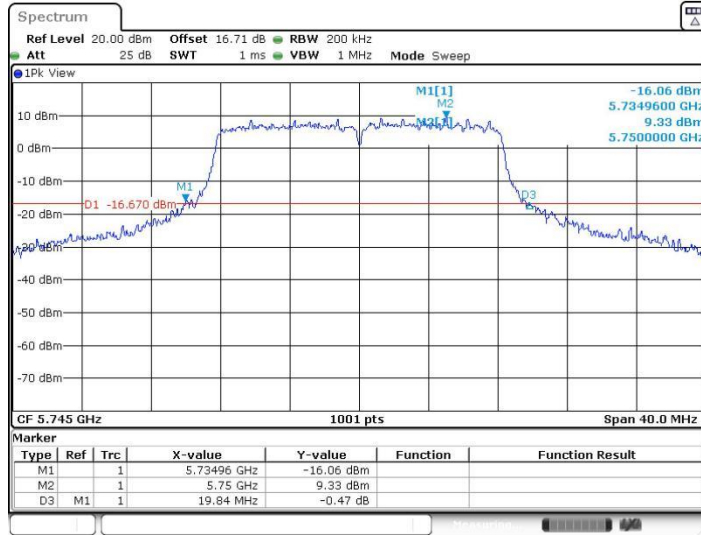

Date: 11.JUN.2022 05:41:02



11A-CDD_Ant1_5785

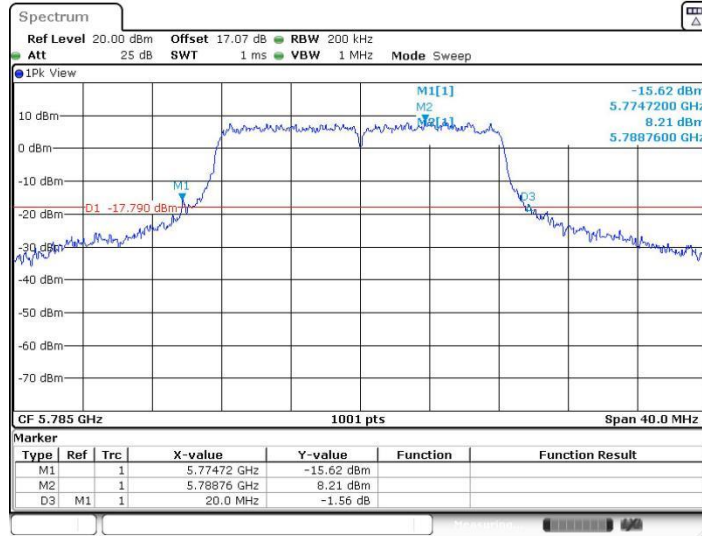

Date: 11.JUN.2022 05:43:22

11A-CDD_Ant2_5785

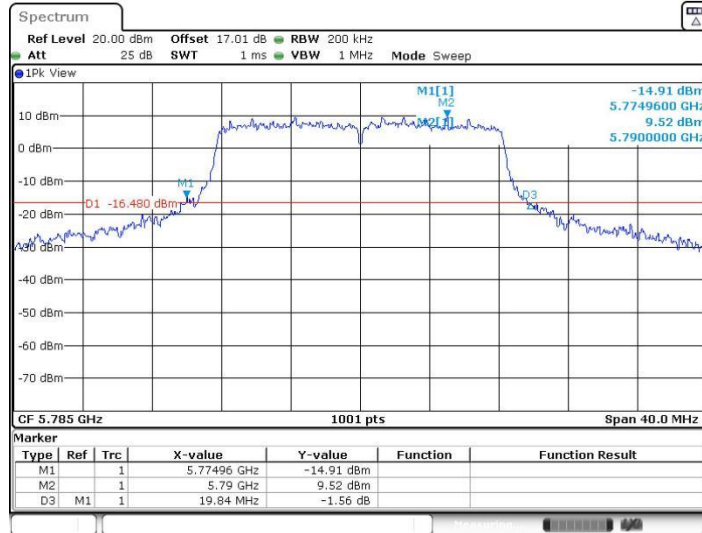

Date: 11.JUN.2022 05:44:21



11A-CDD_Ant1_5825

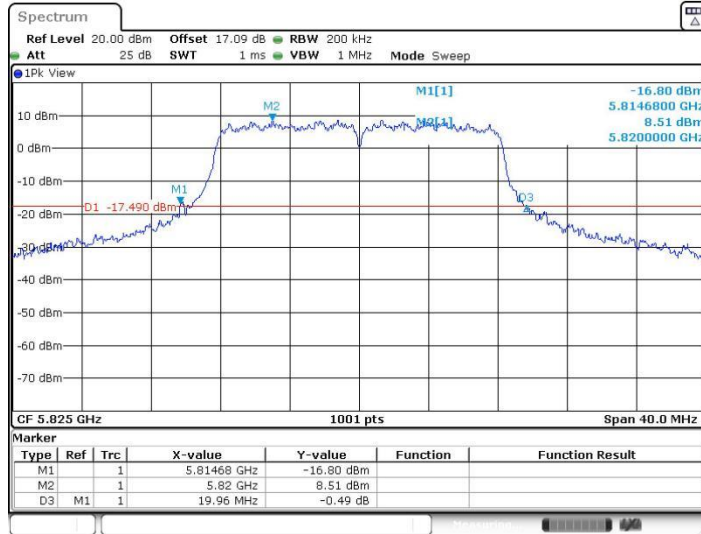

Date: 11.JUN.2022 05:45:41

11A-CDD_Ant2_5825

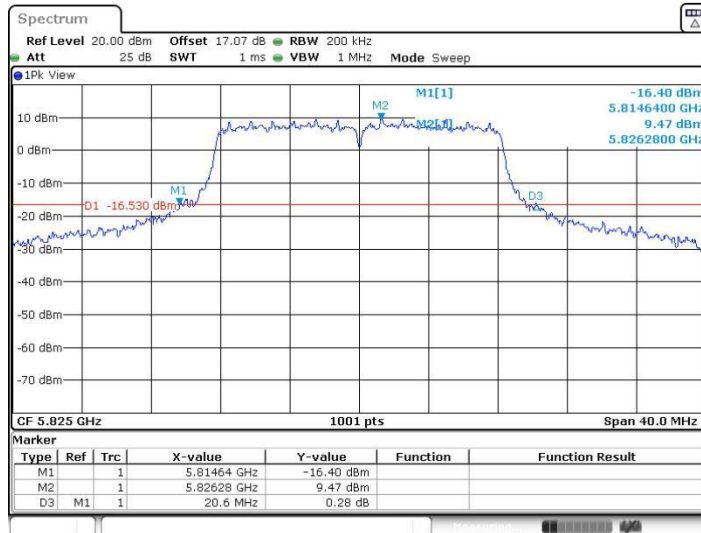

Date: 11.JUN.2022 05:46:40



11AX20MIMO_Ant1_5180

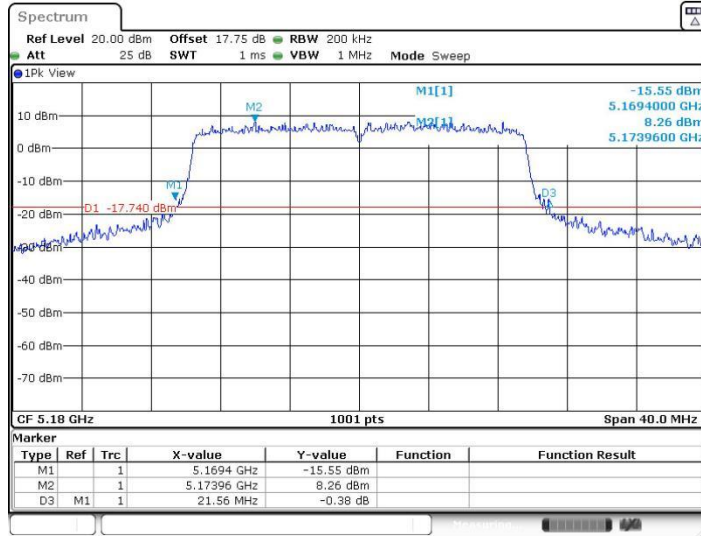

Date: 11.JUN.2022 05:50:25

11AX20MIMO_Ant2_5180

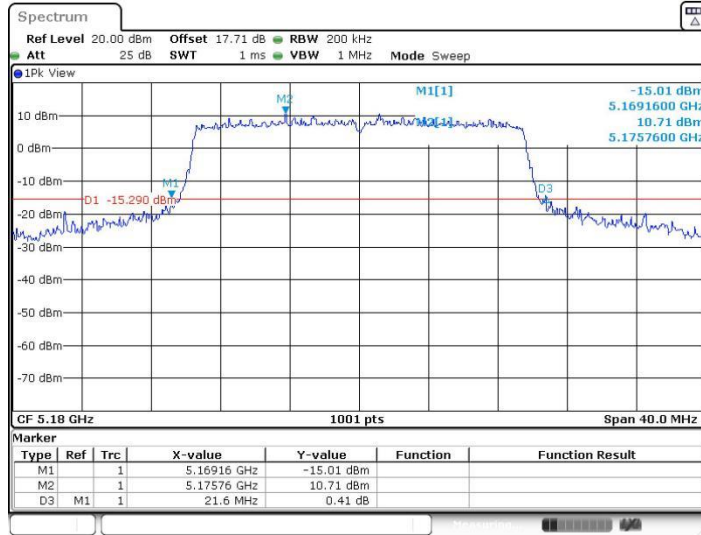

Date: 11.JUN.2022 05:51:30



11AX20MIMO_Ant1_5220

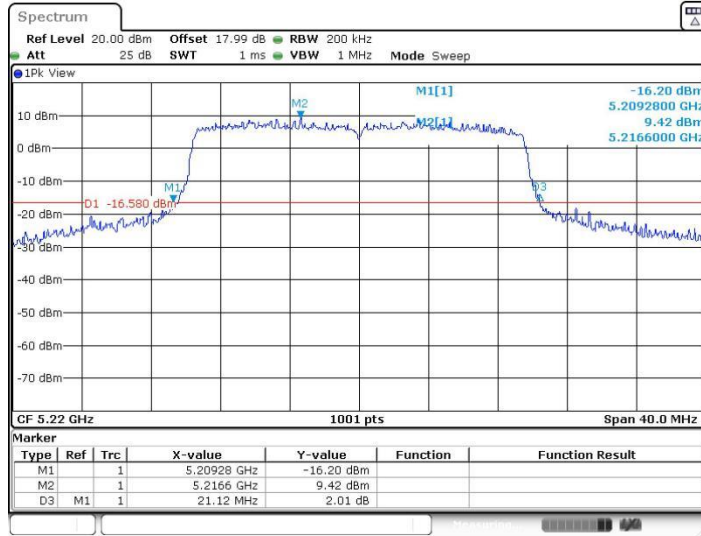

11AX20MIMO_Ant2_5220

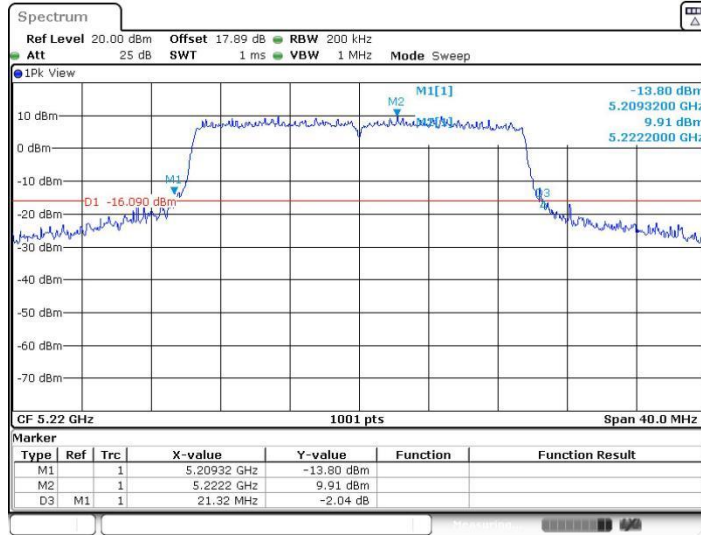



11AX20MIMO_Ant1_5240

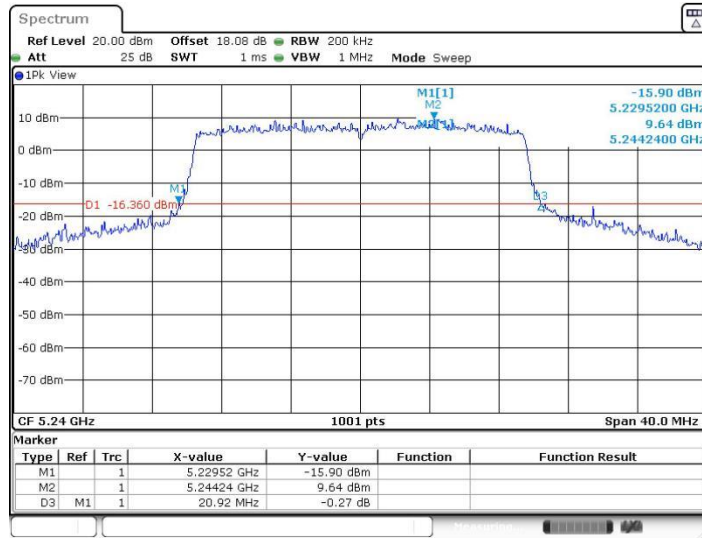

Date: 11.JUN.2022 06:30:17

11AX20MIMO_Ant2_5240

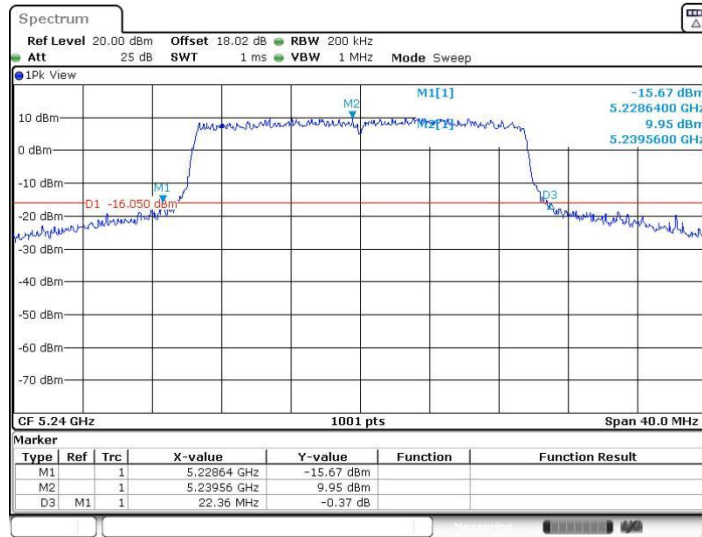

Date: 11.JUN.2022 06:31:22



11AX20MIMO_Ant1_5260

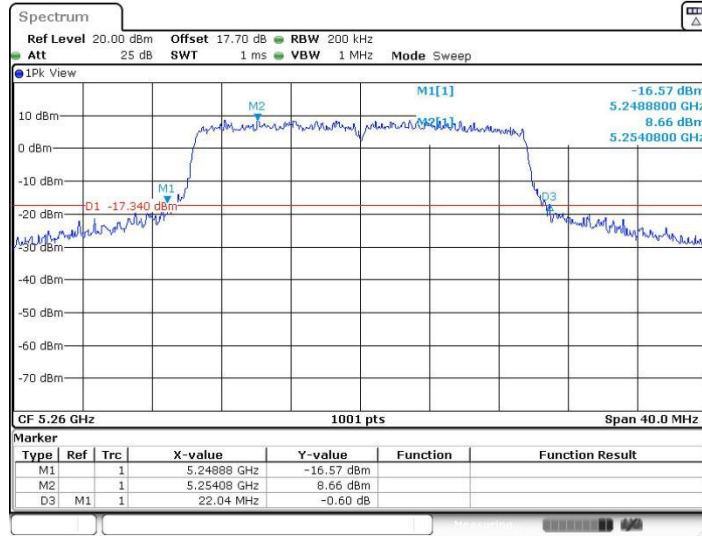

Date: 11.JUN.2022 06:32:34

11AX20MIMO_Ant2_5260

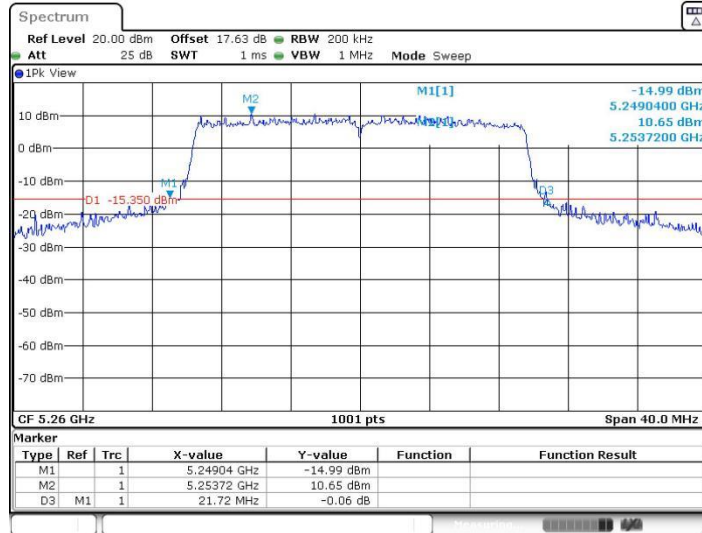

Date: 11.JUN.2022 06:33:36



11AX20MIMO_Ant1_5300

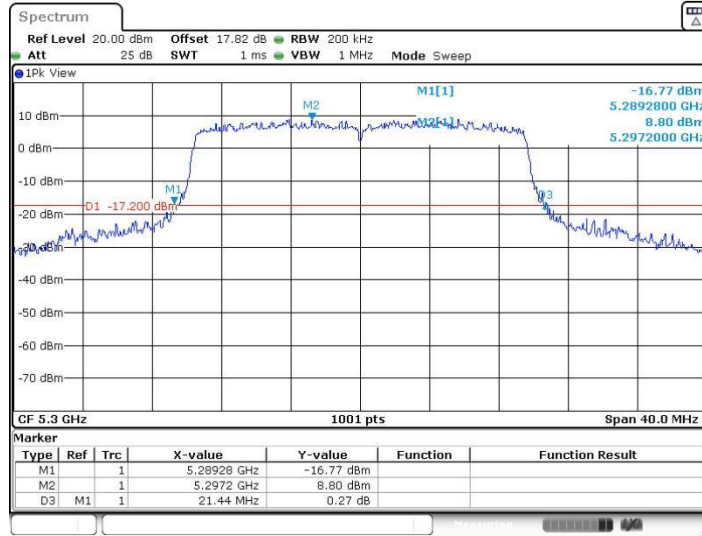

Date: 11.JUN.2022 06:39:39

11AX20MIMO_Ant2_5300

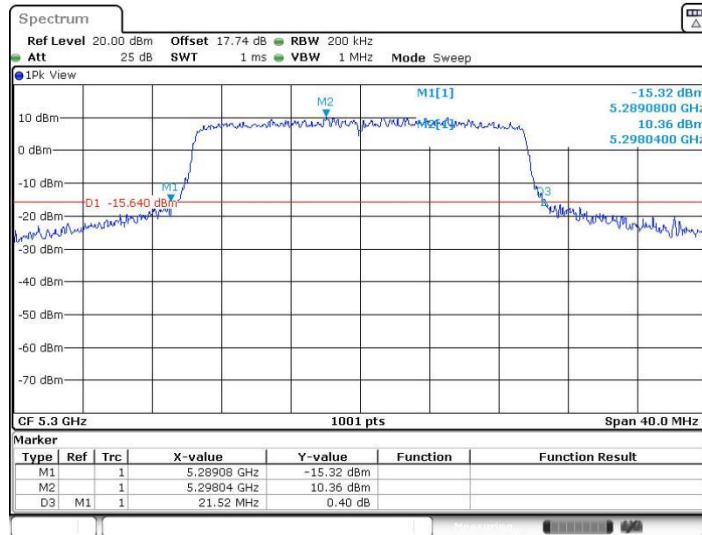

Date: 11.JUN.2022 06:40:39

