

# Antenna Test Report

**APPLICANT** : **Motorola Mobility LLC**

**EQUIPMENT** : **Mobile Cellular Phone**

**BRAND NAME** : **Motorola**

**MODEL NAME** : **XT2241-2**

**Table of Contents**

1. Peak Gain
2. Gain Plots

- **TX Antenna Peak Gain**

**WWAN 2/3/4G: IFA antenna**

Test / Position	Free Space				
bands	TX Antenna Peak Gain				
	Ant 0	Ant 1	Ant 2		Ant 3
GSM 850	-4.9	-5.7			
E-GSM 900	-5.2	-4.8			
DCS 1800	-2.3	-2.6			
GSM 1900	-3.6	-1.6			
W FDD I	-4.4	-2			
W FDD II	-3.6	-1.6			
W FDD IV	-2.3	-2.6			
W FDD V	-4.9	-5.7			
W FDD VIII	-5.2	-4.8			
BC0	-4.9	-5.7			
LTE B1	-4.4	-2			
LTE B2	-3.6	-1.6			
LTE B3	-2.3	-2.6			
LTE B4	-2.3	-2.6			
LTE B5	-4.9	-5.7			
LTE B7	-3.8	-2.4			
LTE B8	-5.2	-4.8			
LTE B12	-5	-6.9			
LTE B13	-4.8	-7			
LTE B17	-5	-6.9			
LTE B18	-4.9	-5.7			
LTE B19	-4.8	-5.7			
LTE B20	-4.8	-5.7			

LTE B25		-3.6	-1.6			
LTE B26		-4.8	-5.7			
LTE B28		-4.9	-6.3			
LTE B32		-4.2	-3.7			
LTE B34		-5.2	-1.6			
LTE B38		-3.6	-2.1			
LTE B39		-4.1	-1.6			
LTE B40		-2.3	-2.6			
LTE B41		-3.6	-2.1			
LTE B42				-4.1		
LTE B43				-4.1		
LTE B48				-4.1		
LTE B66		-2.3	-2.6			

**FR1 SUB6 : IFA antenna**

Test / Position	Free Space						
bands	Frequency	TX Antenna Peak Gain					
		Ant 0	Ant 1	Ant 2	Ant 3	Ant 5	Ant 7
n1		-4.4	-2				
n2		-3.6	-1.6				
n3		-2.3	-2.6				
n5		-4.9	-5.7				
n7		-3.8	-2.4				
n8		-5.2	-4.8				
n20		-4.8	-5.7				
n28		-4.9	-6.3				
n66		-2.3	-2.6				
n38		-3.6	-2.1				
n40		-2.3	-2.6				
n41		-3.6	-2.1				
n77				-4.1	-4.5	-4.3	-4.4
n78				-4.1	-4.5	-4.3	-4.4

**WLAN 2.4&5G&6e: IFA antenna**

Test / Position	Free Space				
bands	Frequency	TX Antenna Peak Gain			
		Ant 2	Ant 4	Ant 5	Ant 6
BT	2402-2480MHz		-3.3		-3.7
WiFi 2.4G	2410-2477MHz		-3.3		-3.7
WiFi 5G B1	5150~5250M Hz	-3.1			-3.2
WiFi 5G B2	5250~5350M Hz	-3.3			-3.3
WiFi 5G B3	5470~5725M Hz	-3.2			-3.2
WiFi 5G B4	5725~5850M Hz	-3.3			-3.4
WiFi 6E UNII-5	5925~6425M Hz	-6.5			-5.9
WiFi 6E UNII-6	6425~6525M Hz	-6.4			-6.1
WiFi 6E UNII-7	6525~6875M Hz	-6.4			-6.1
WiFi 6E UNII-8	6875~7125M Hz	-6.3			-6.4

## 1. Gain Plots

ANT0

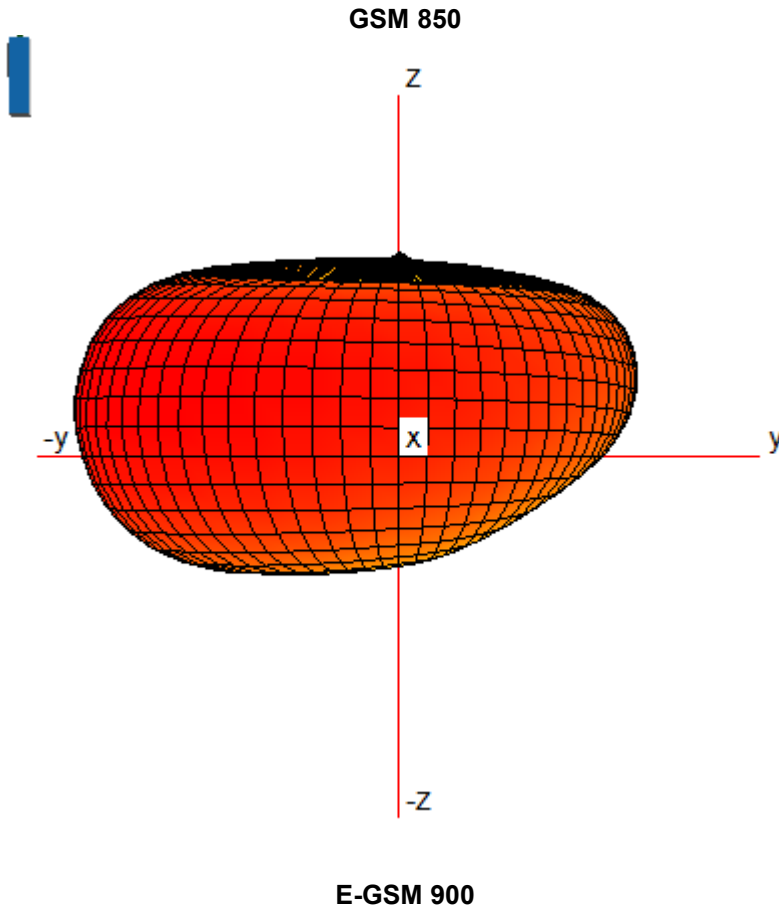

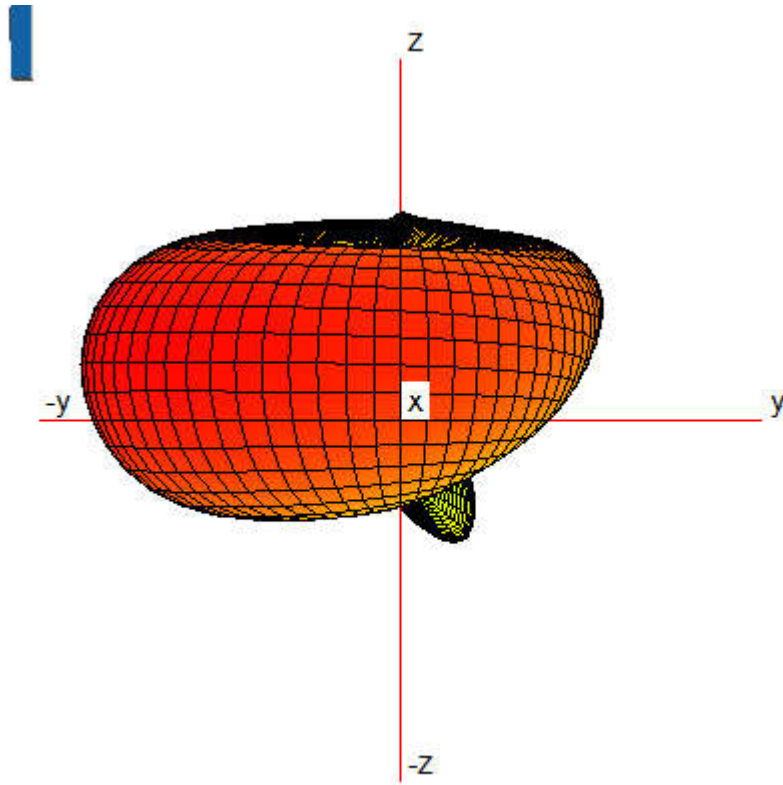

**DCS 1800**

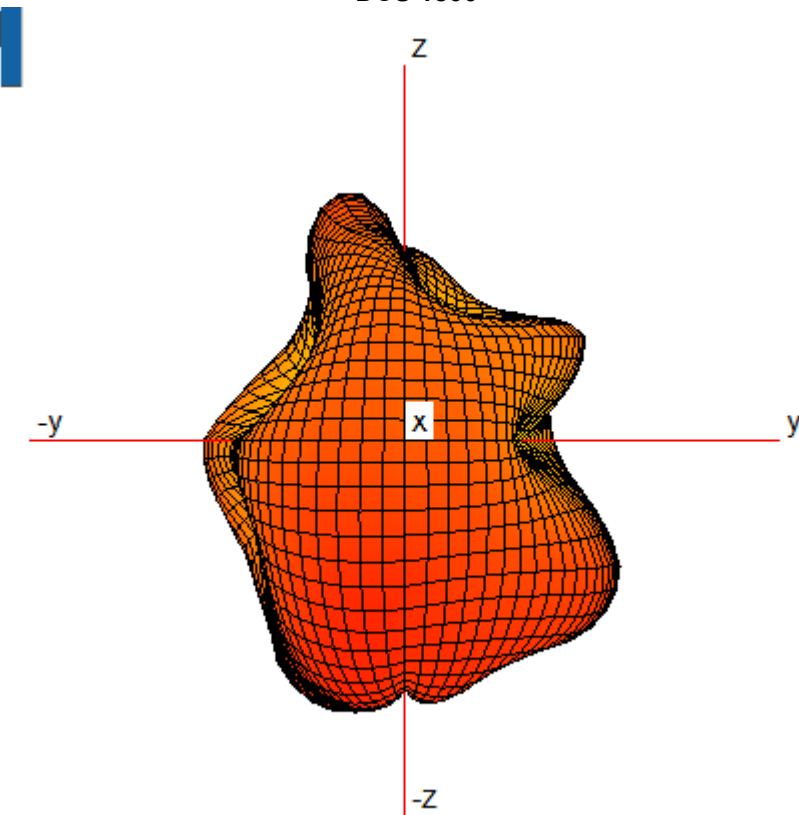

**GSM 1900**

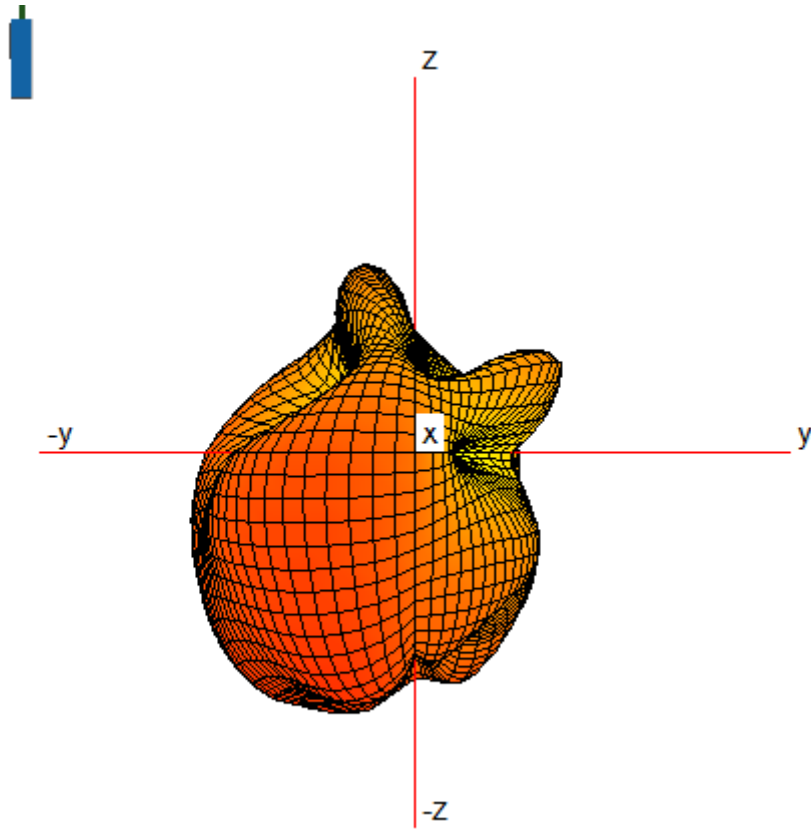

W FDD I

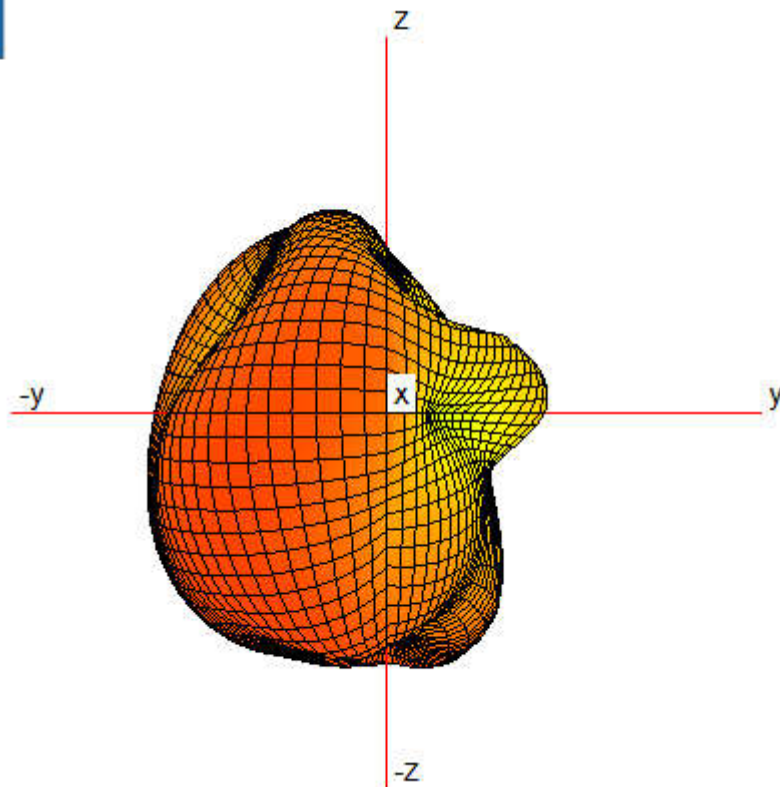

W FDD II

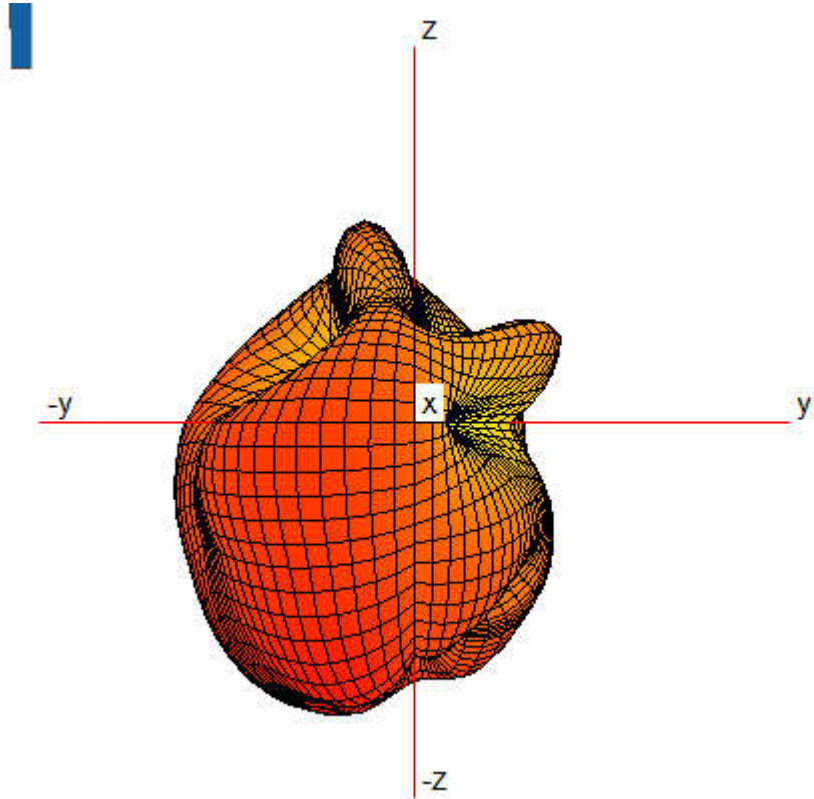

W FDD IV

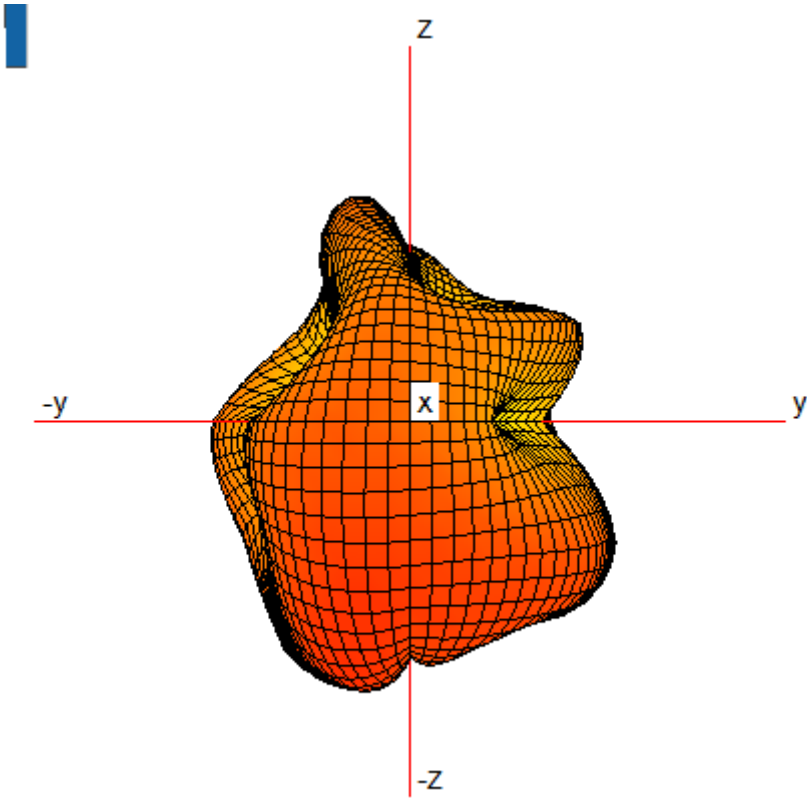

W FDD V



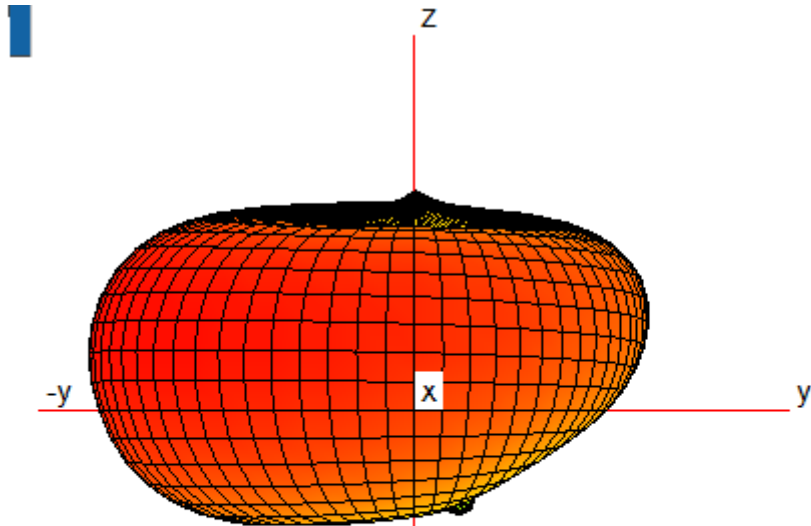

W FDD VIII

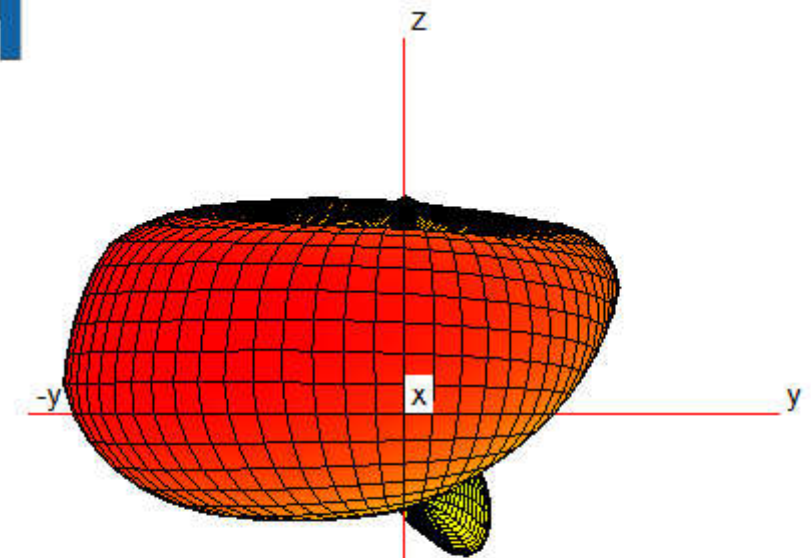

LTE B1

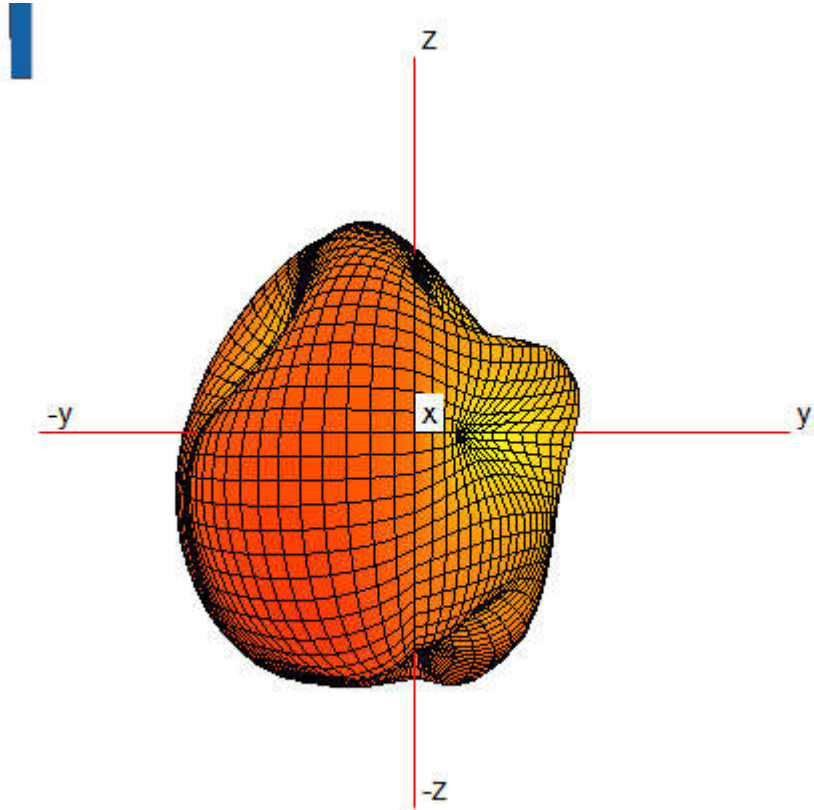

LTE B2

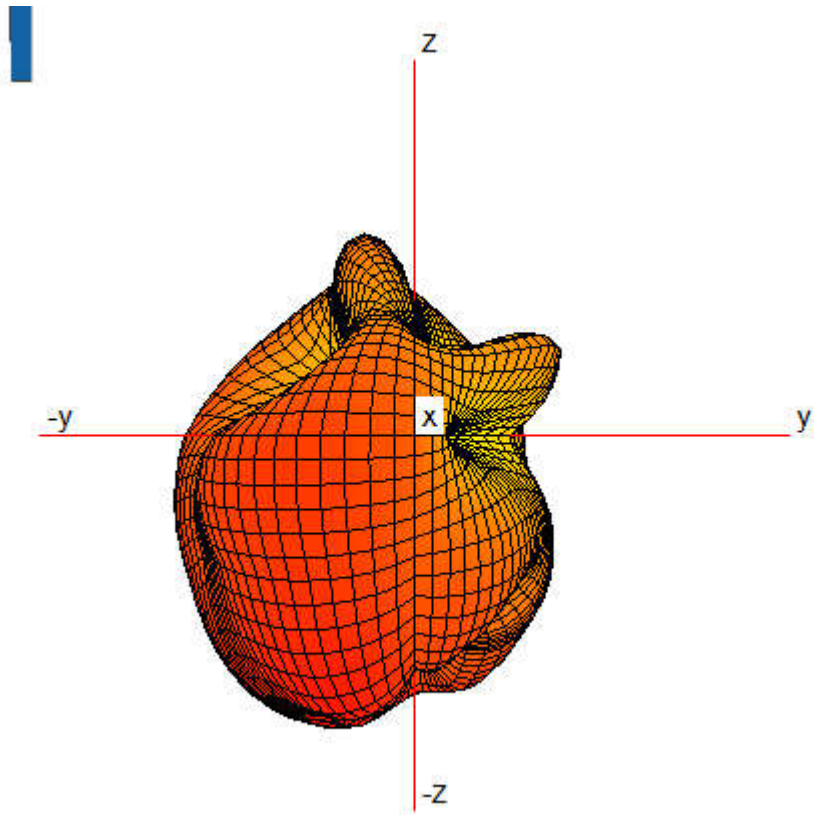

LTE B3

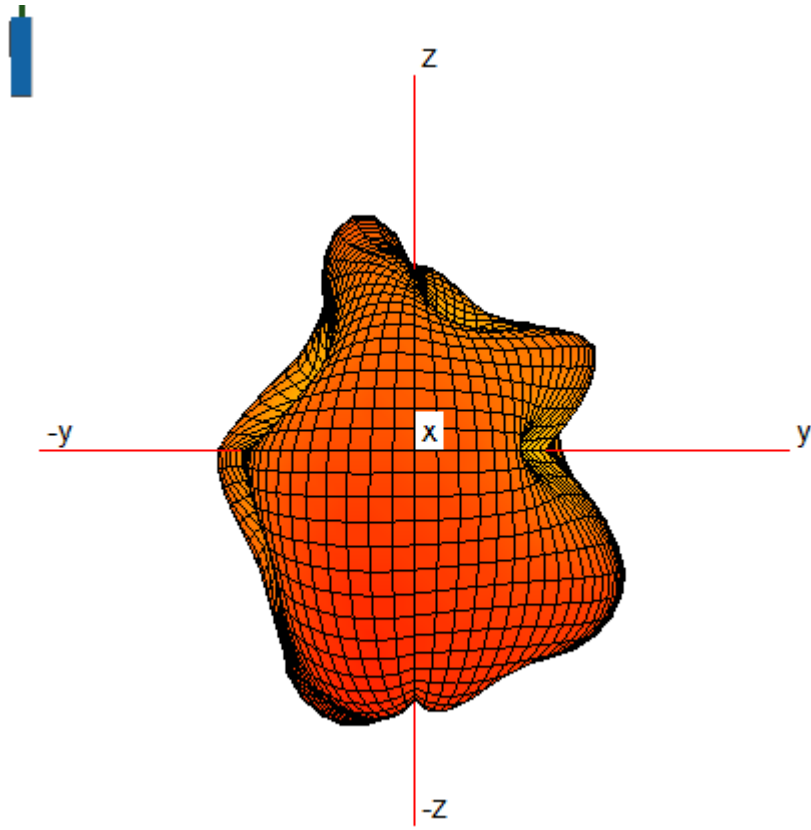

LTE B4

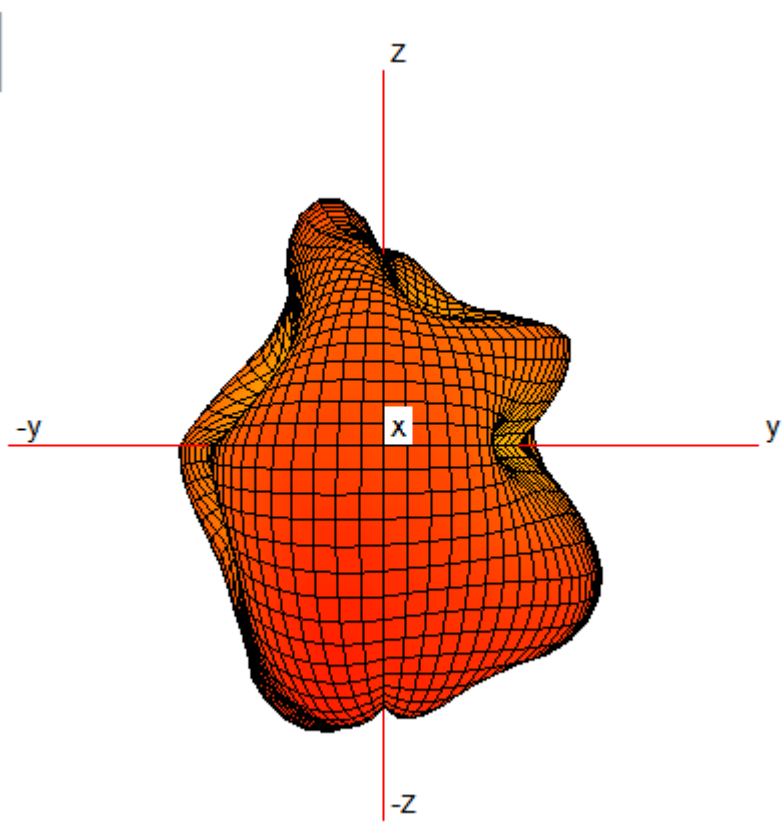

LTE B5

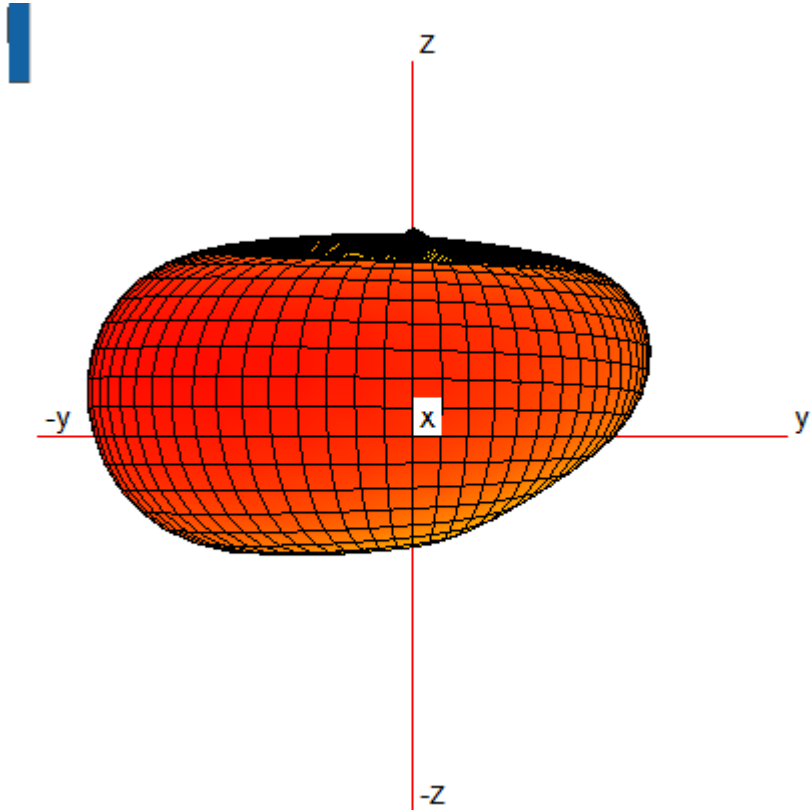

LTE B7

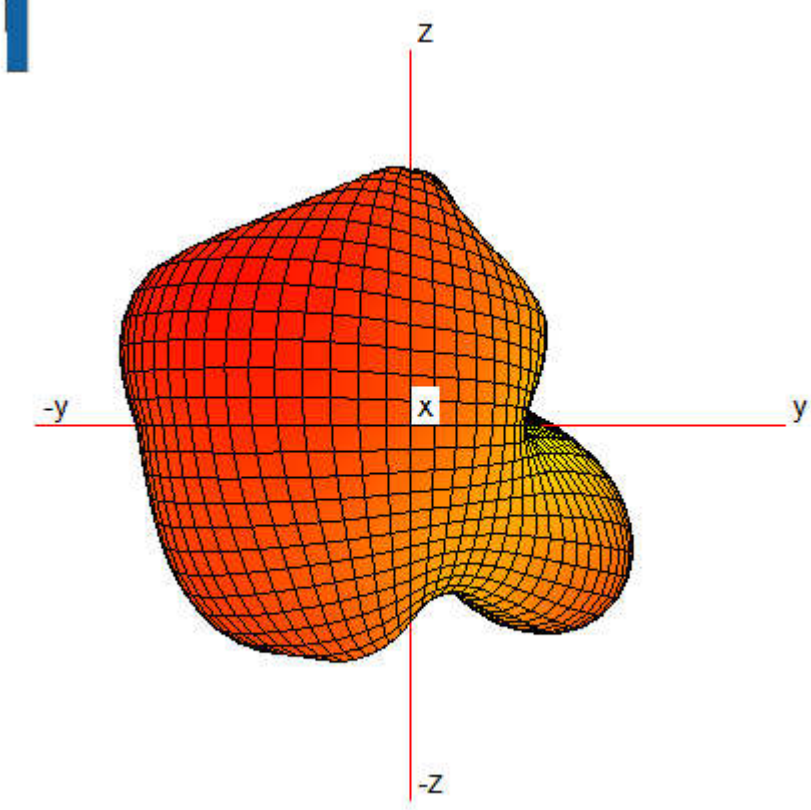

LTE B8

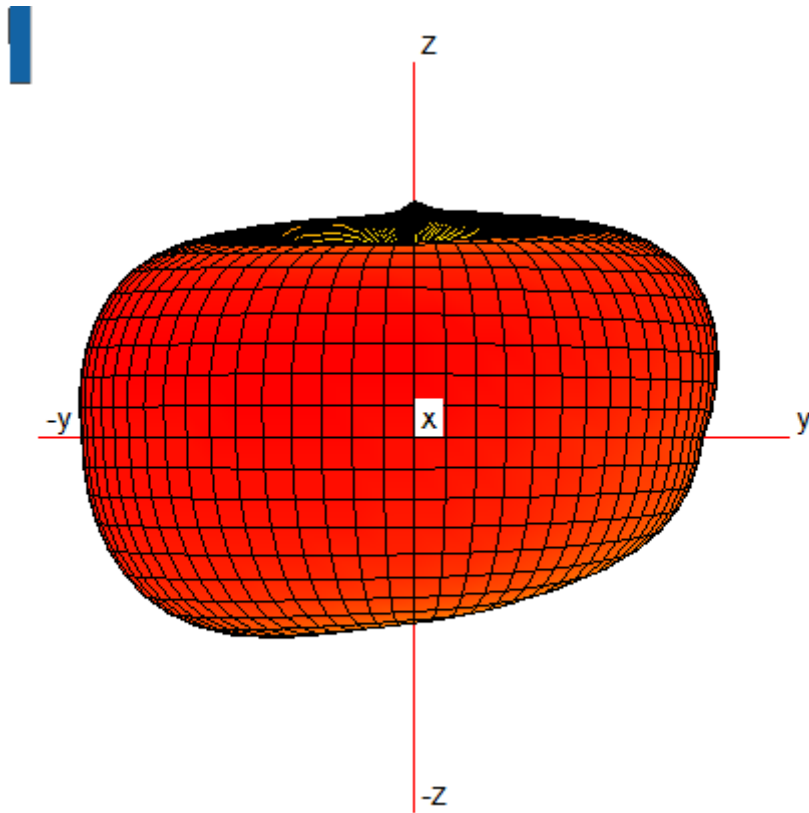
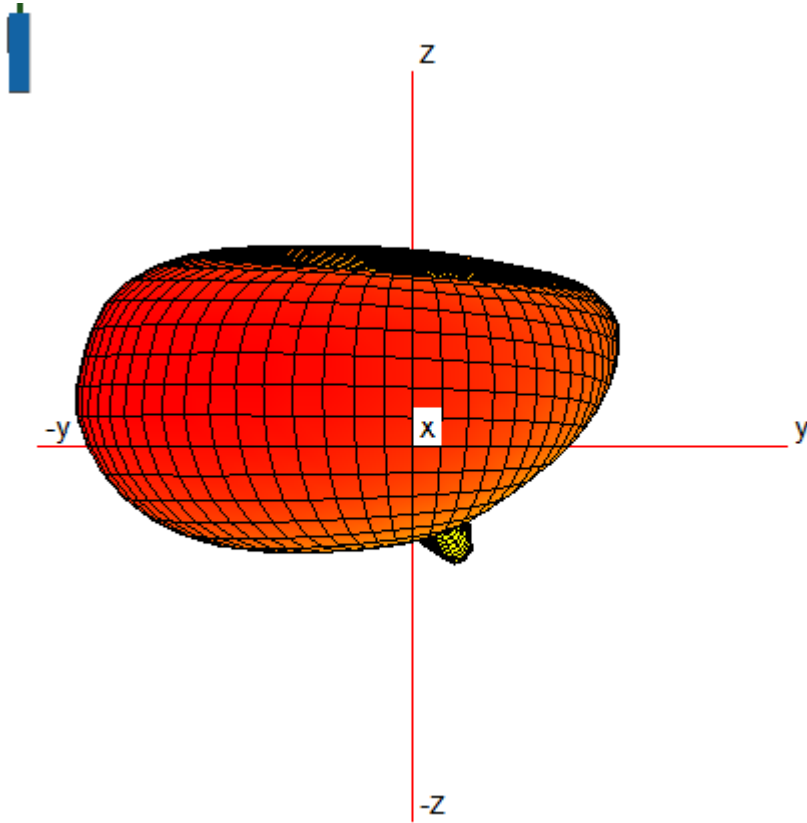

LTE B1

LTE B13

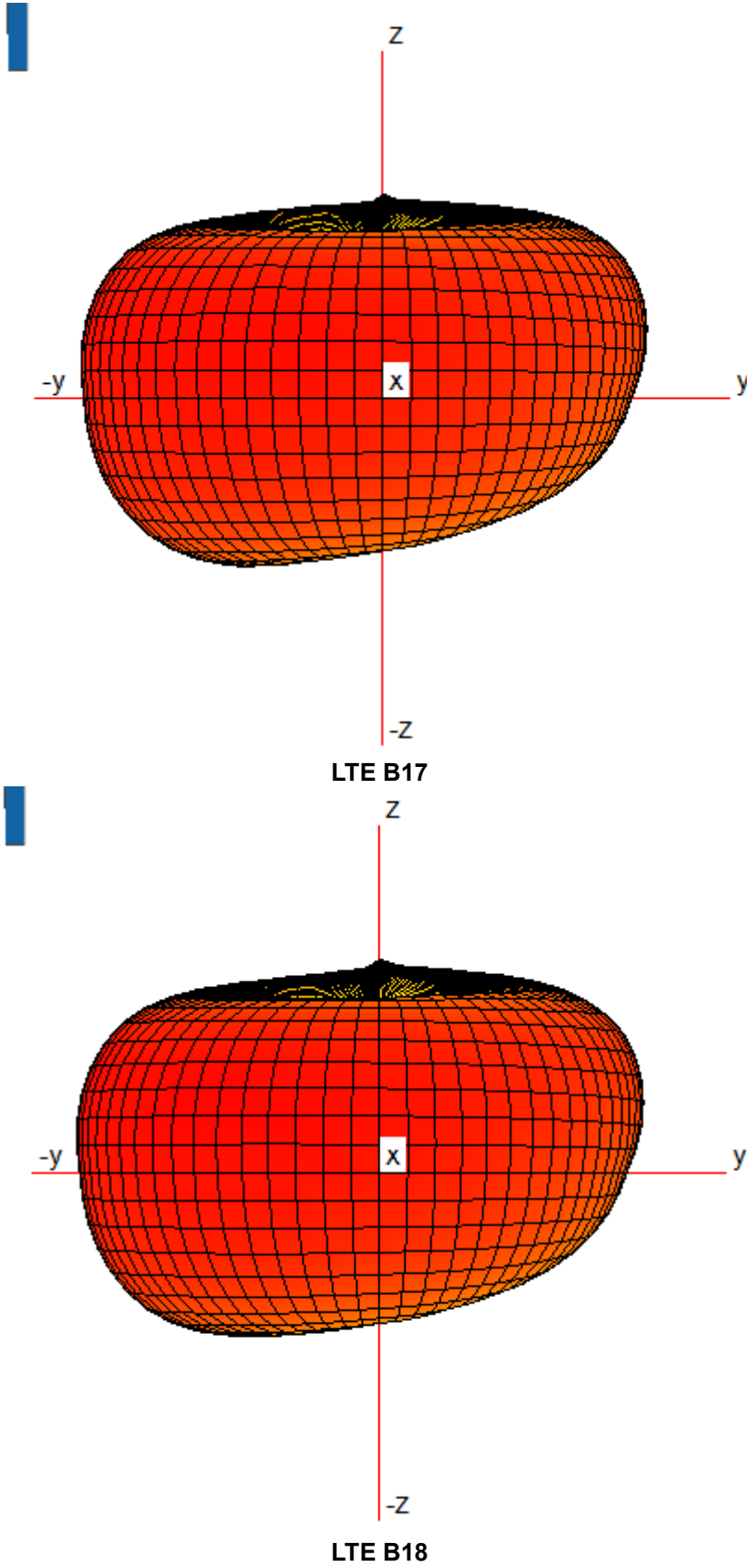

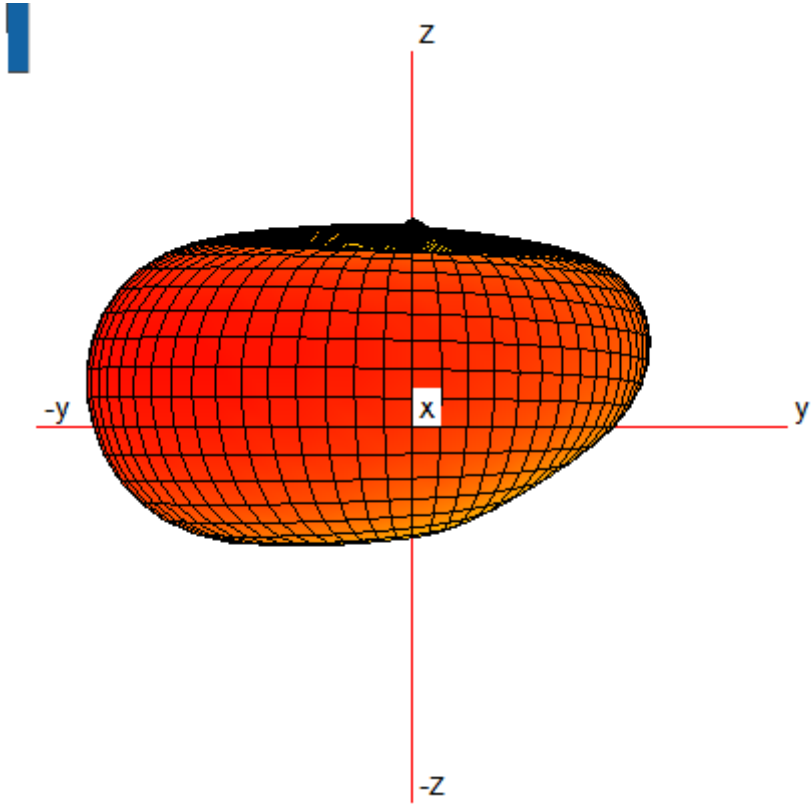

LTE B19

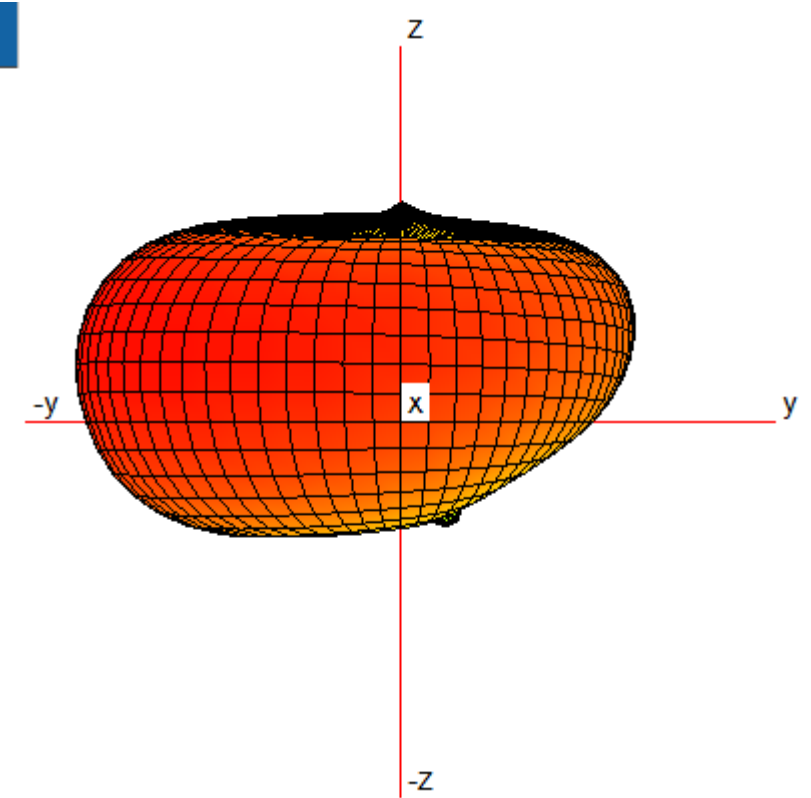

LTE B20

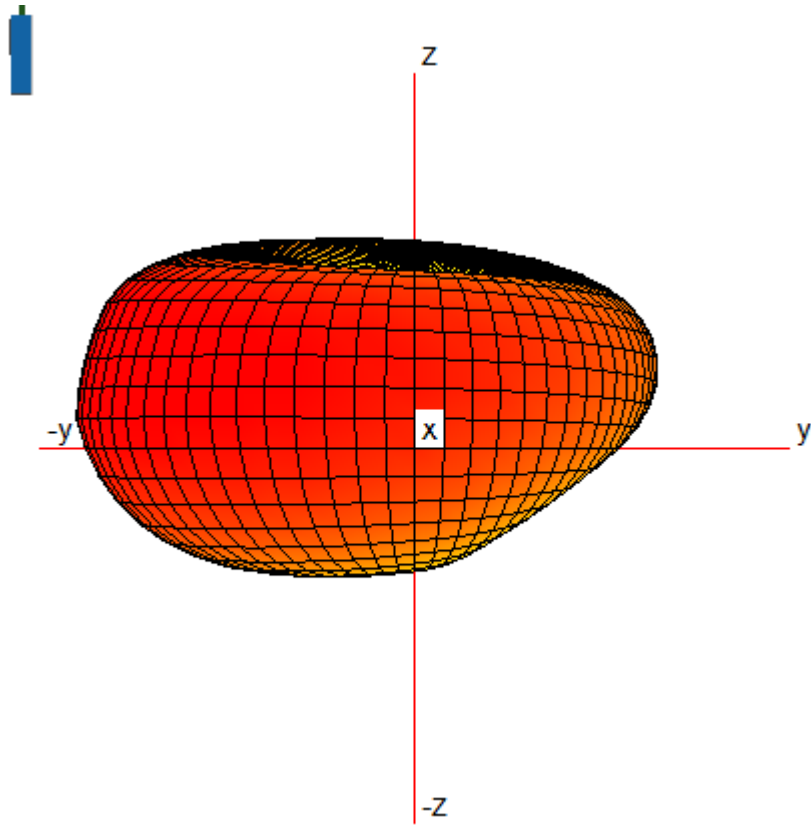

LTE B25

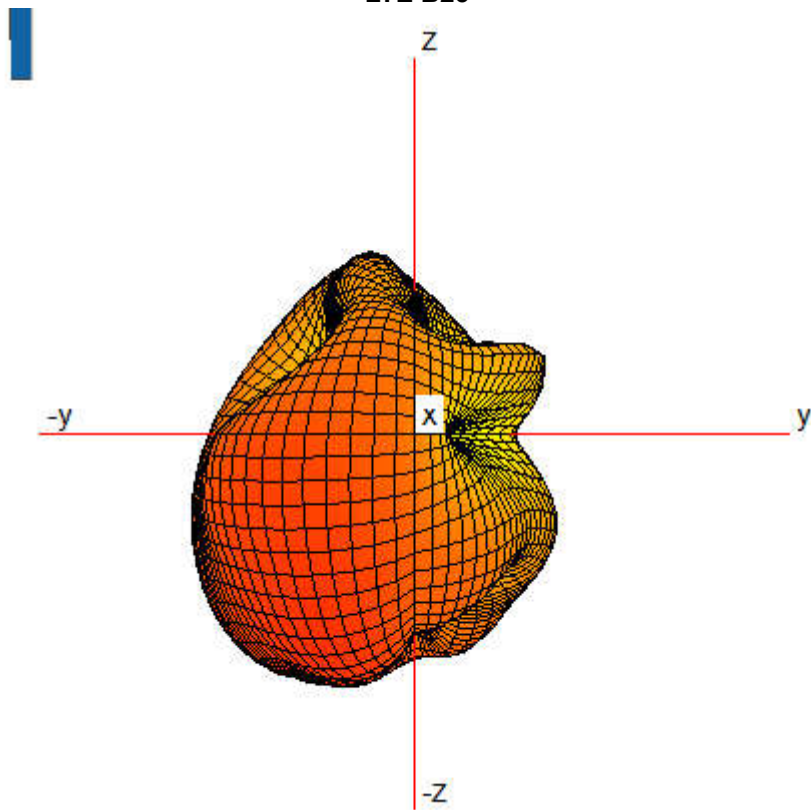

LTE B26



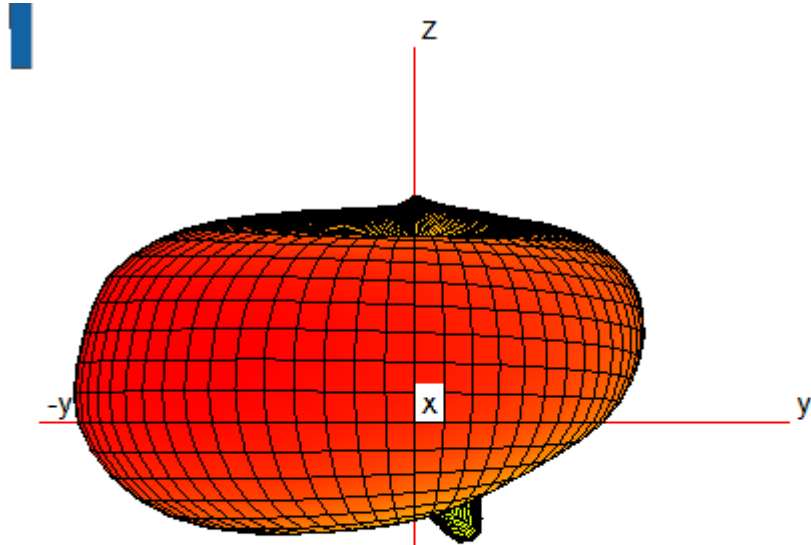

LTE B28

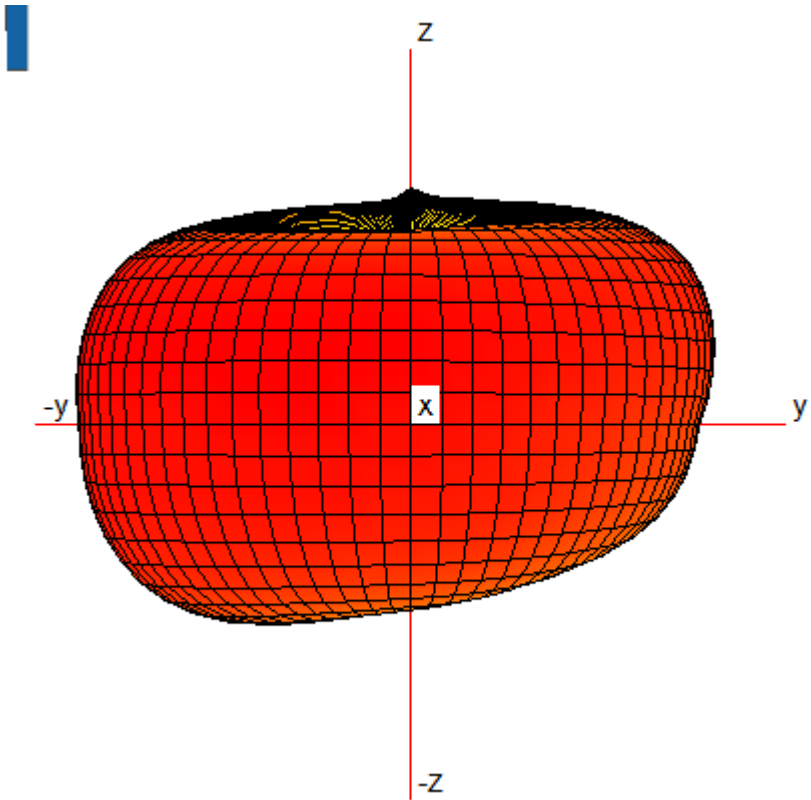

LTE B34

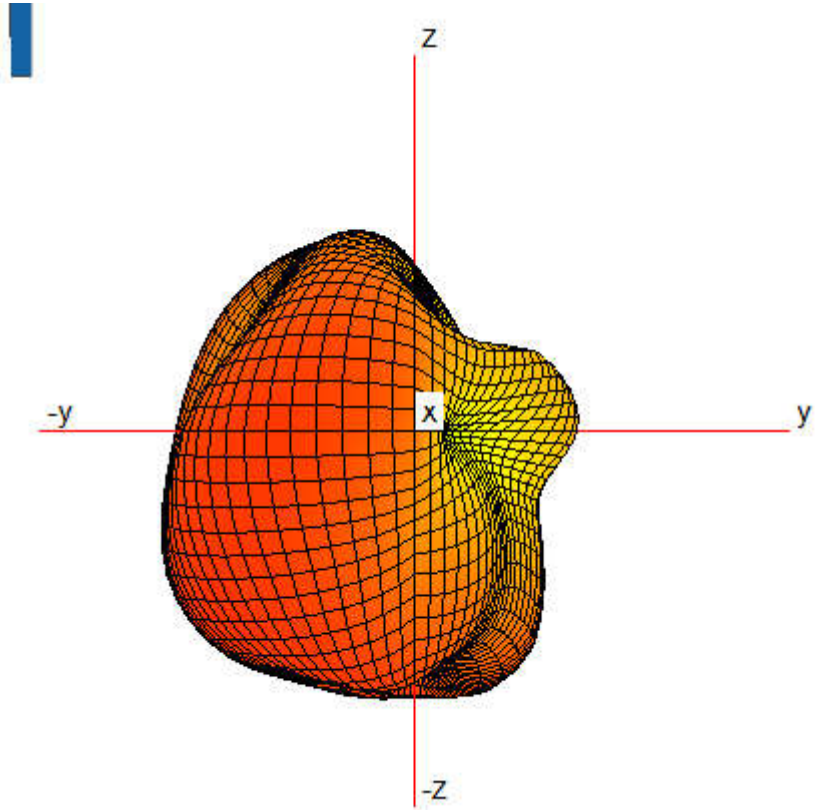

LTE B38

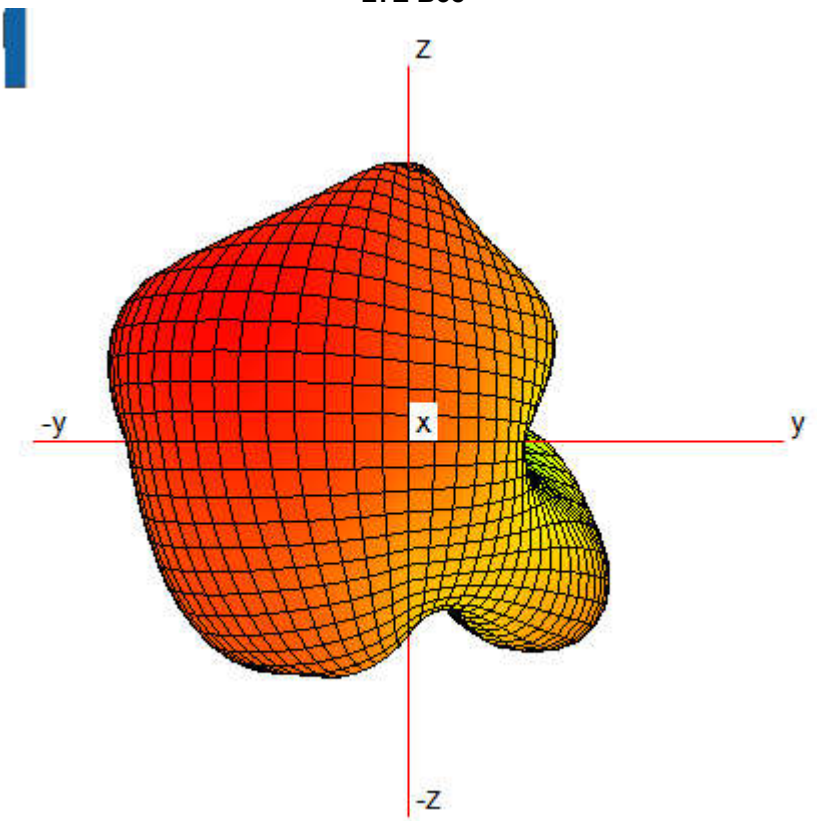

LTE B39

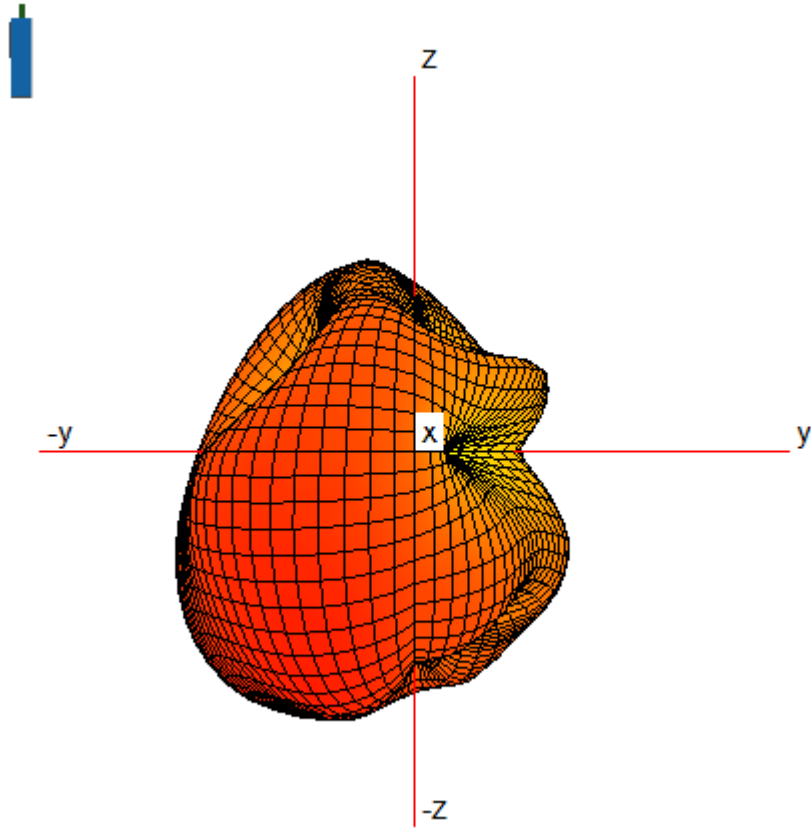

LTE B40

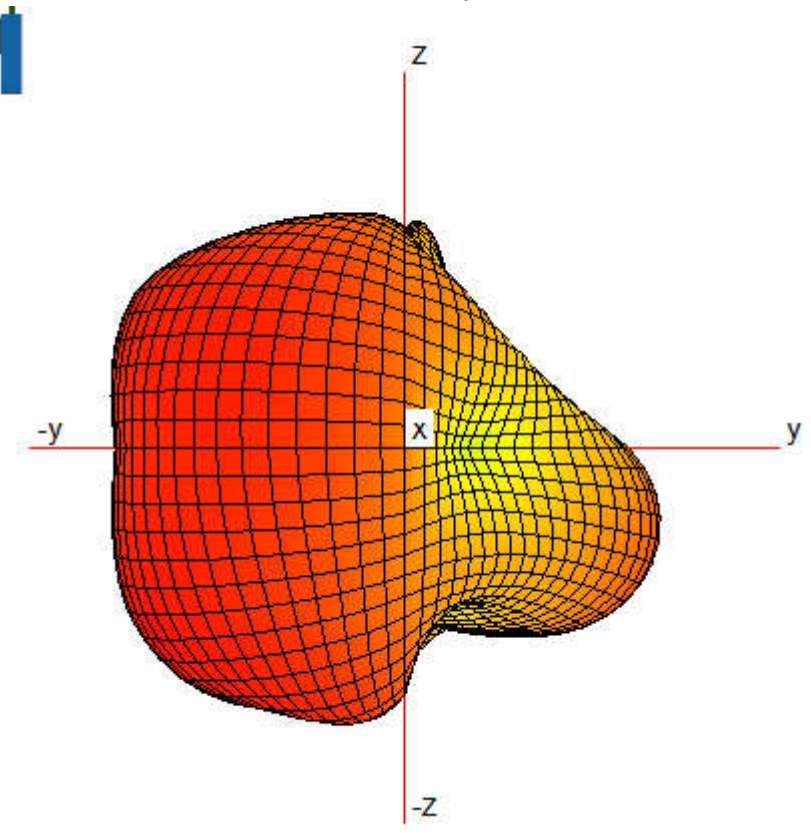

LTE B41

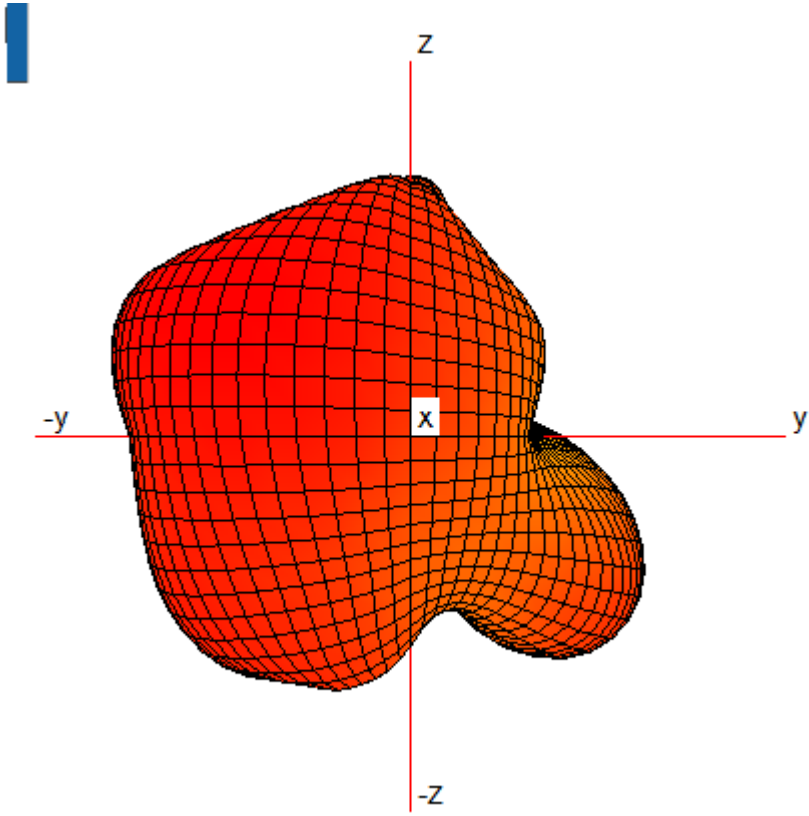

LTE B66

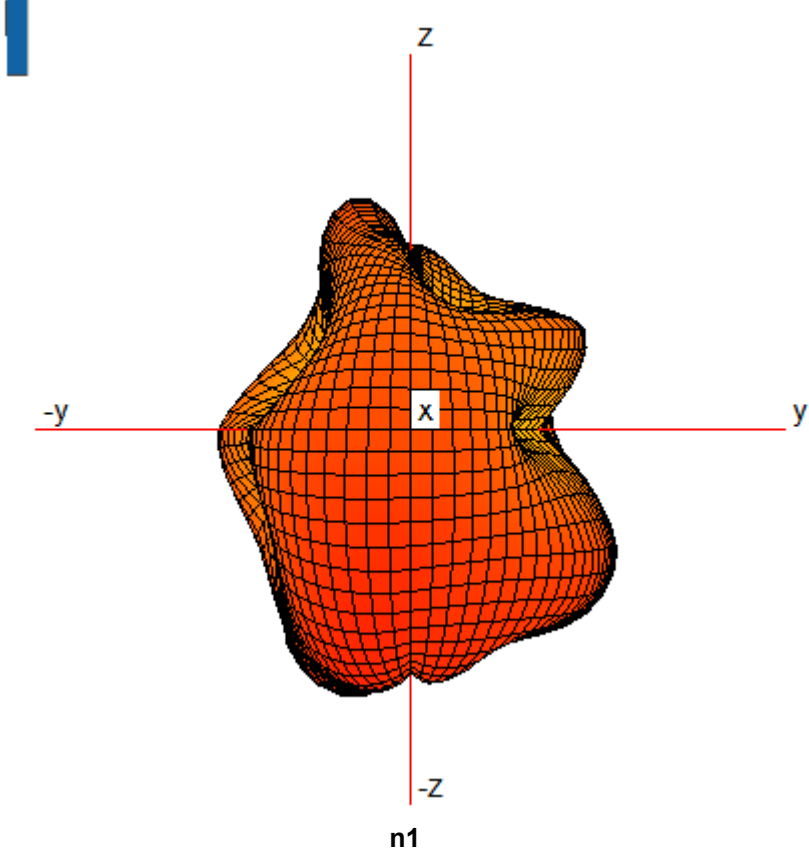

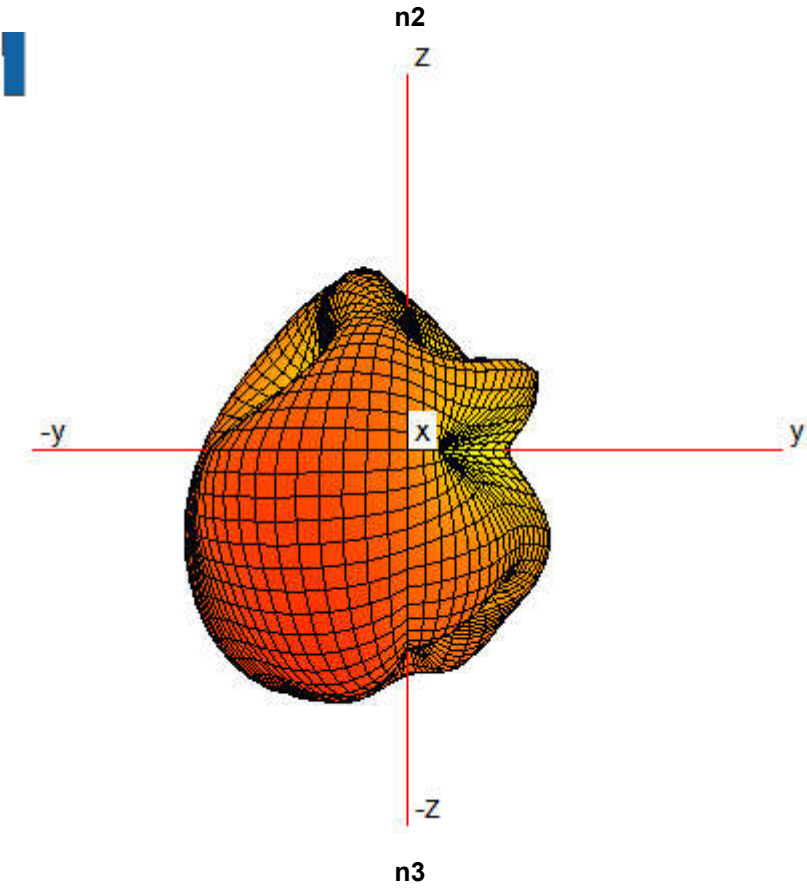
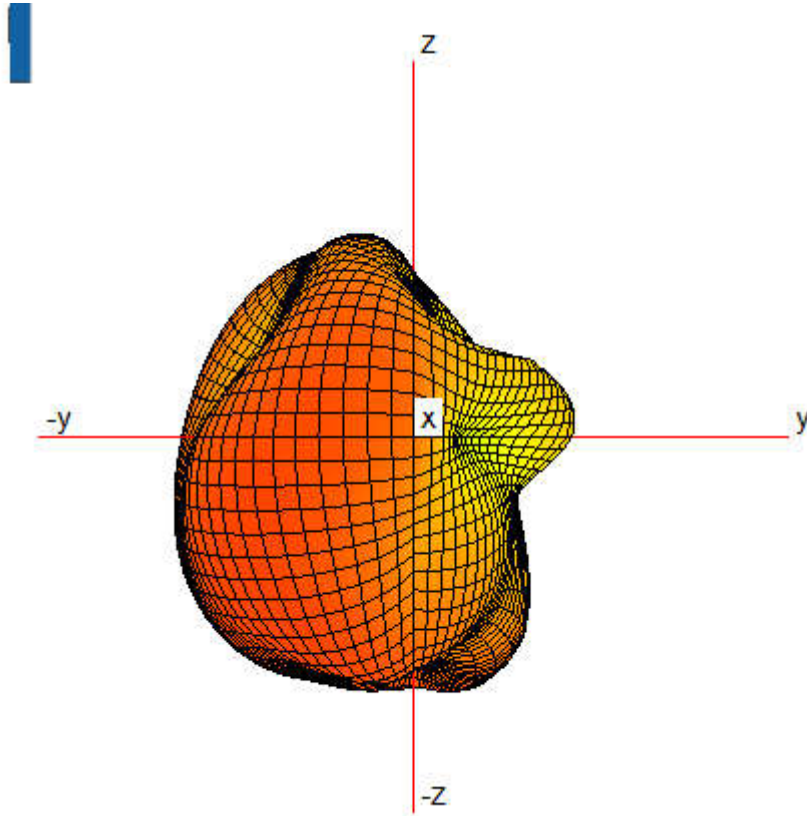

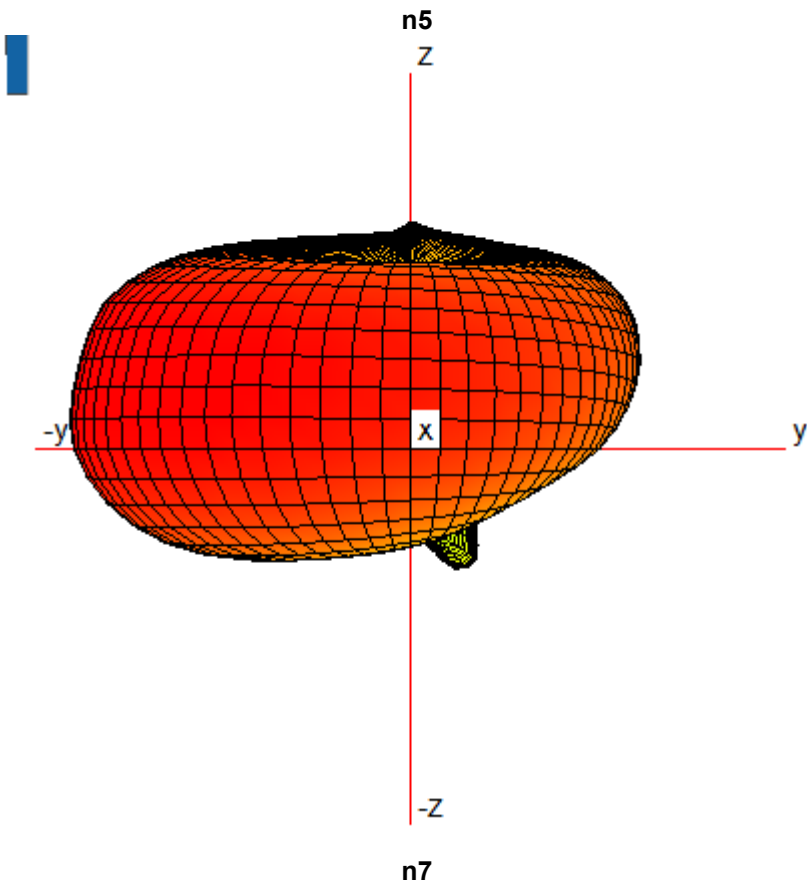
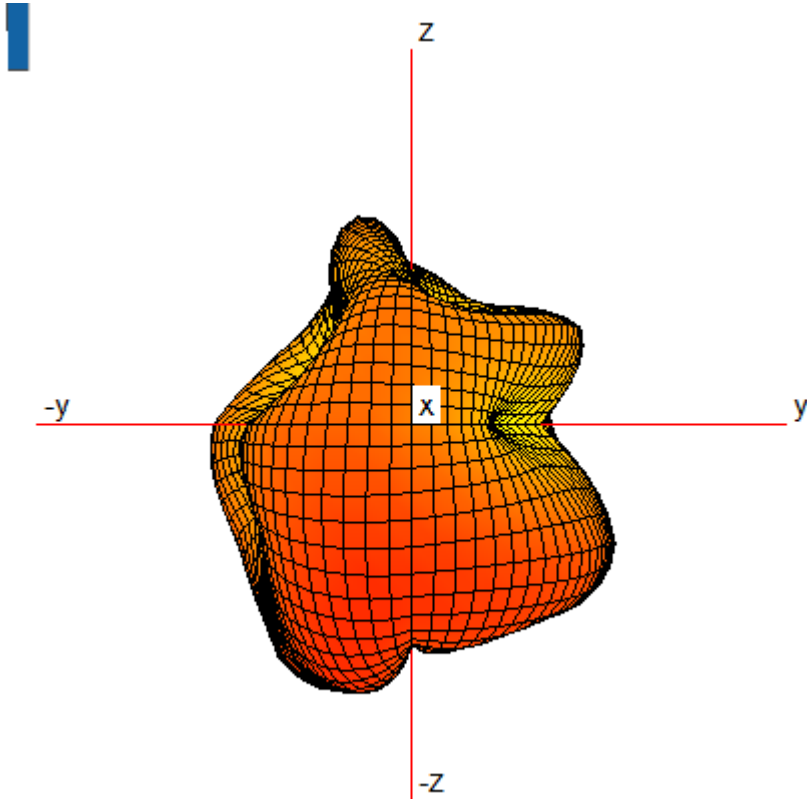

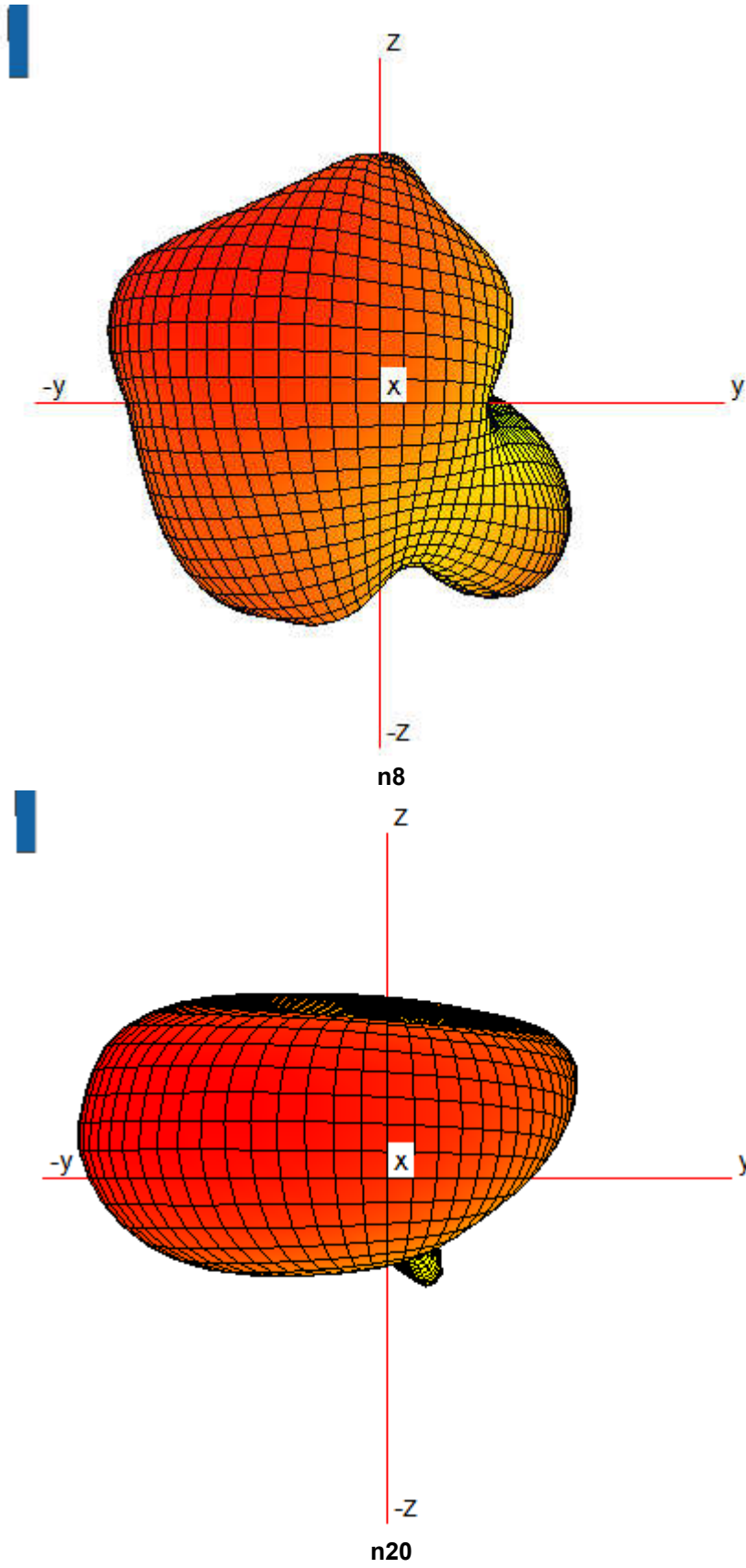

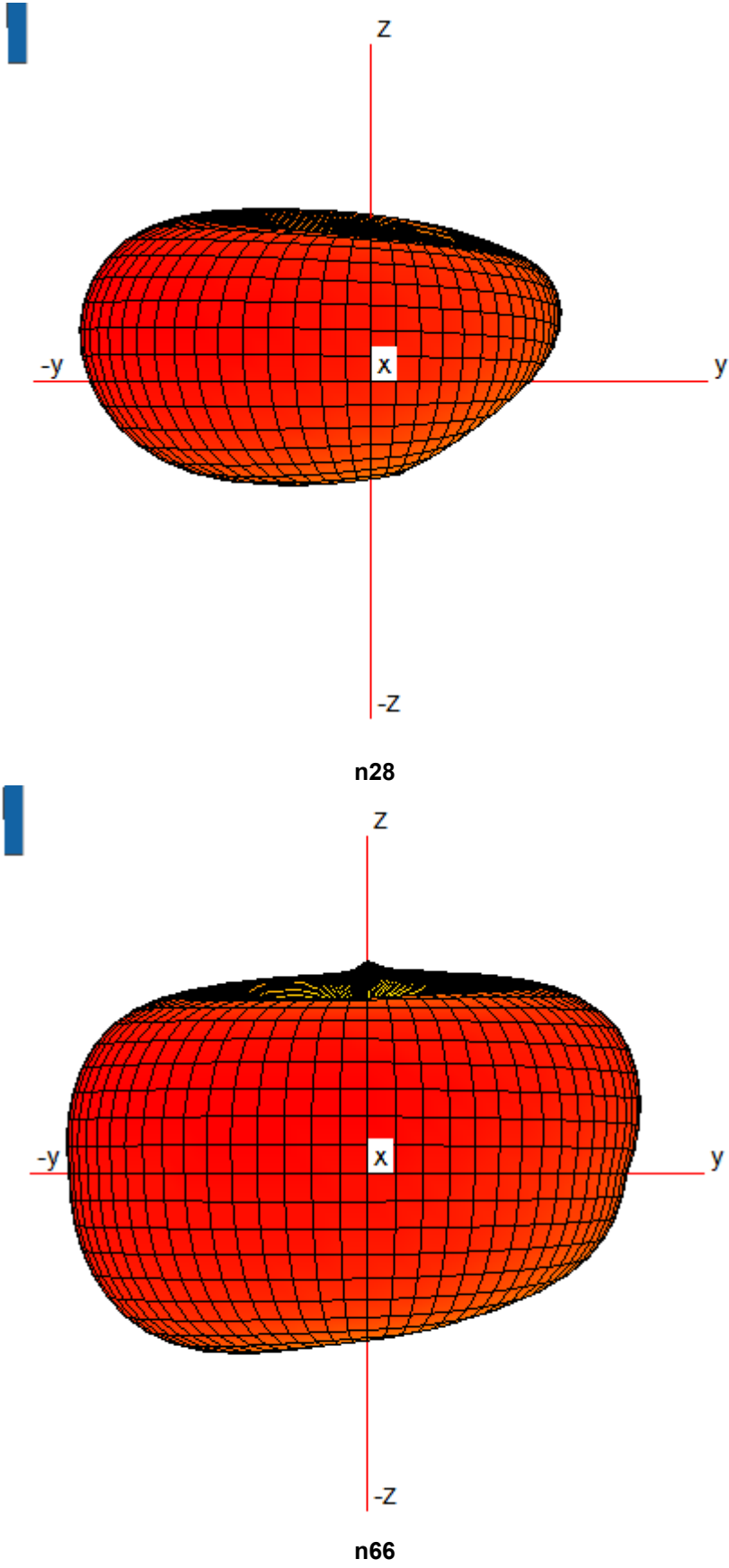



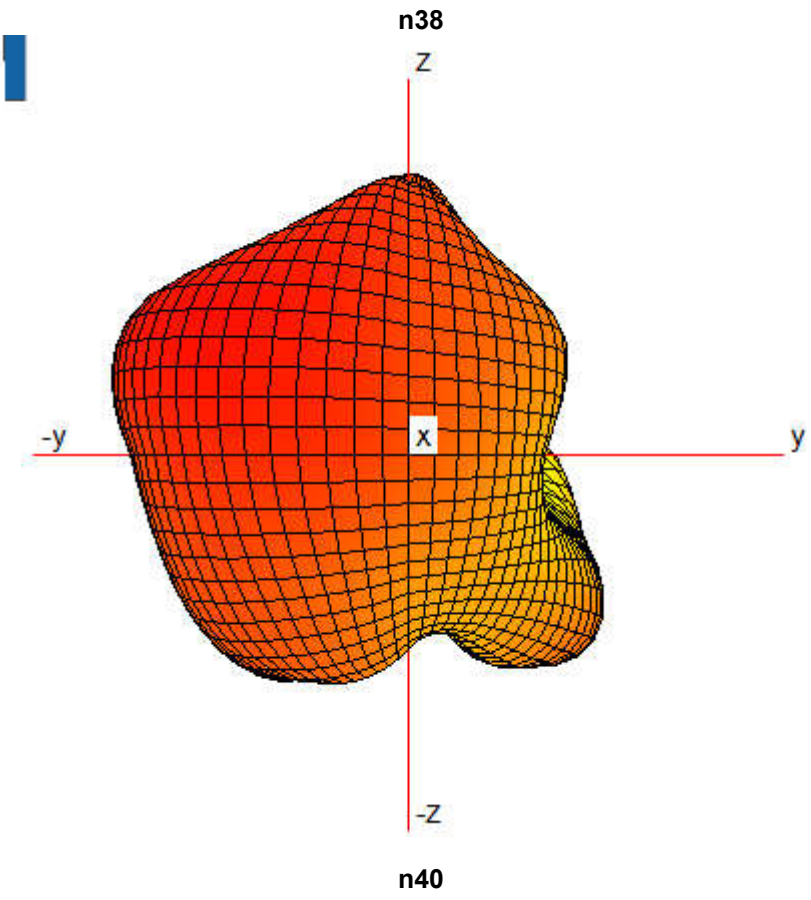
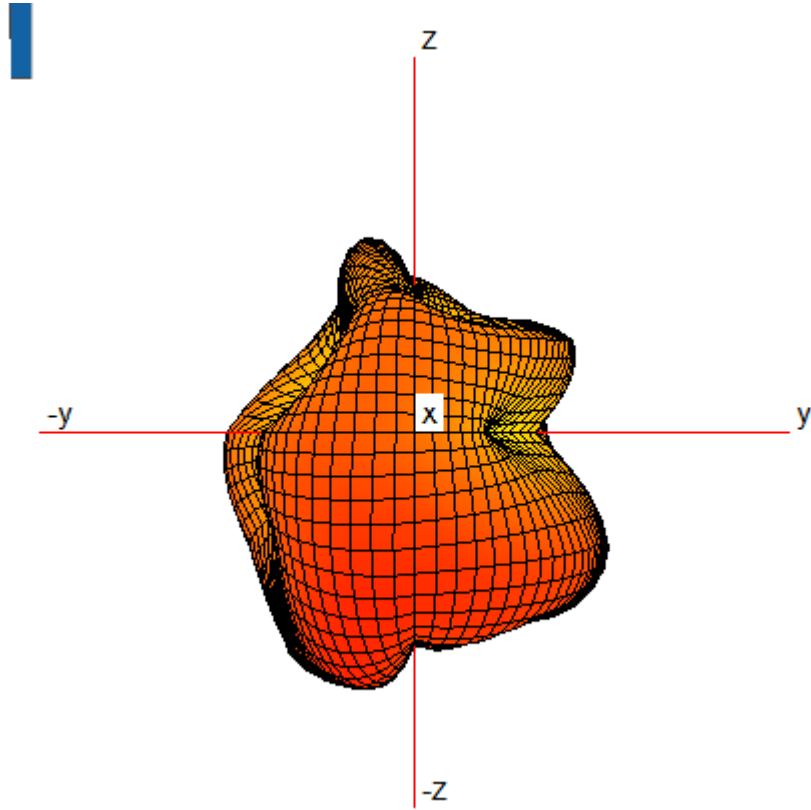

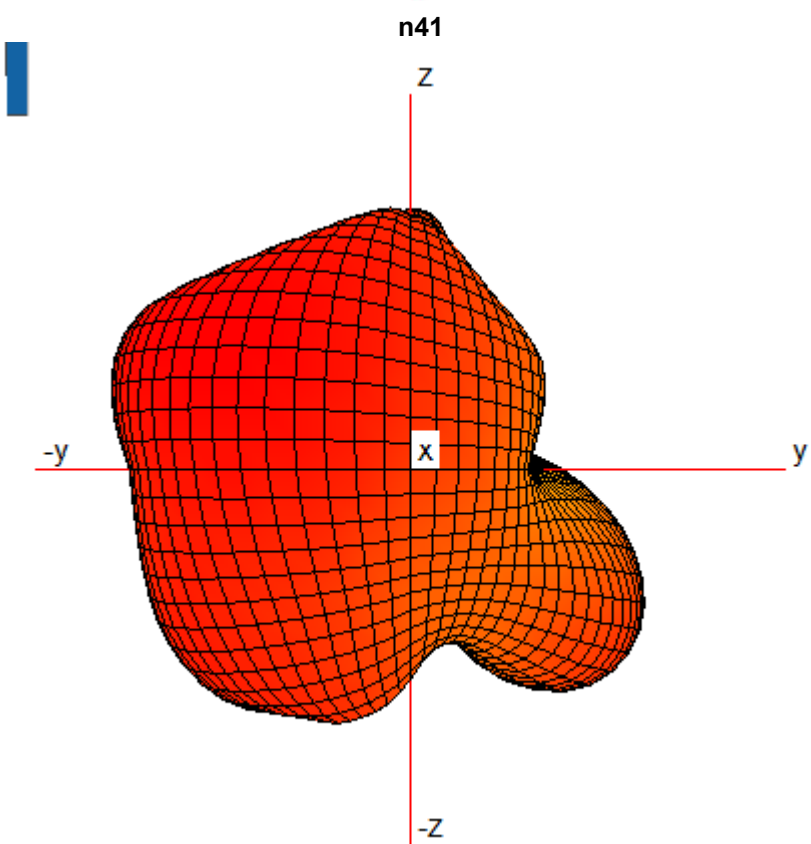
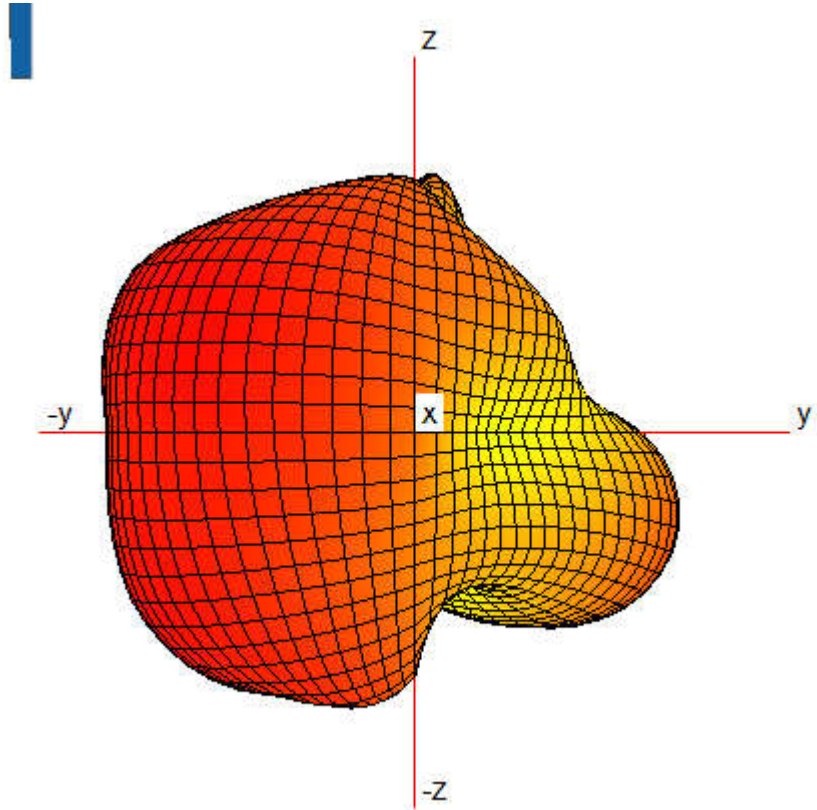

ANT1

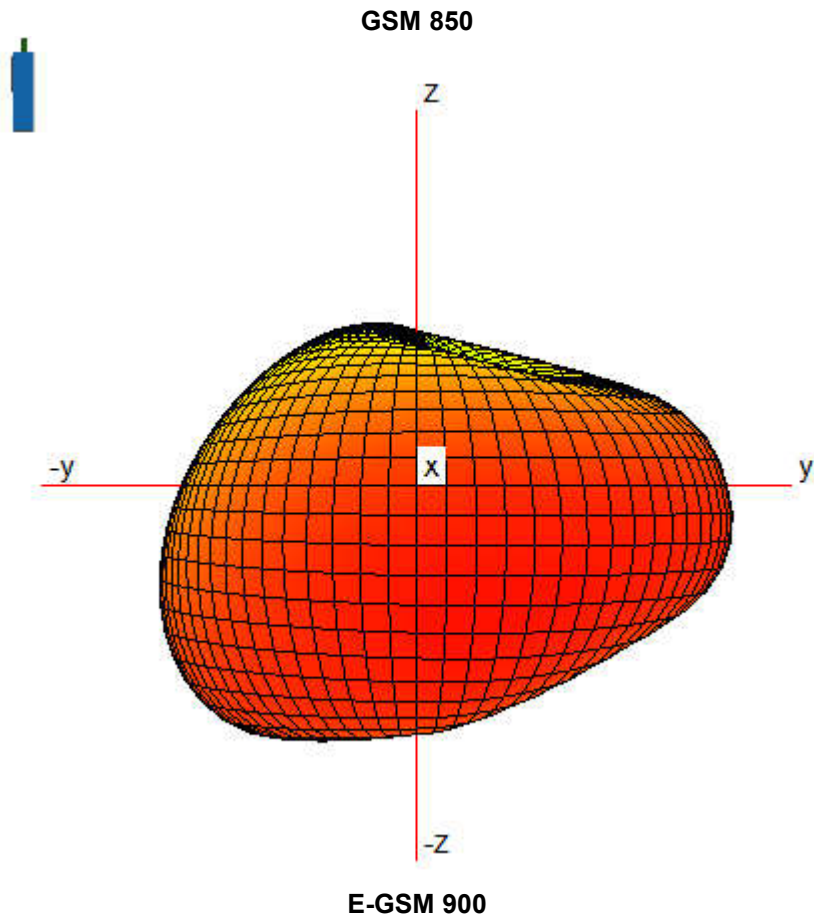

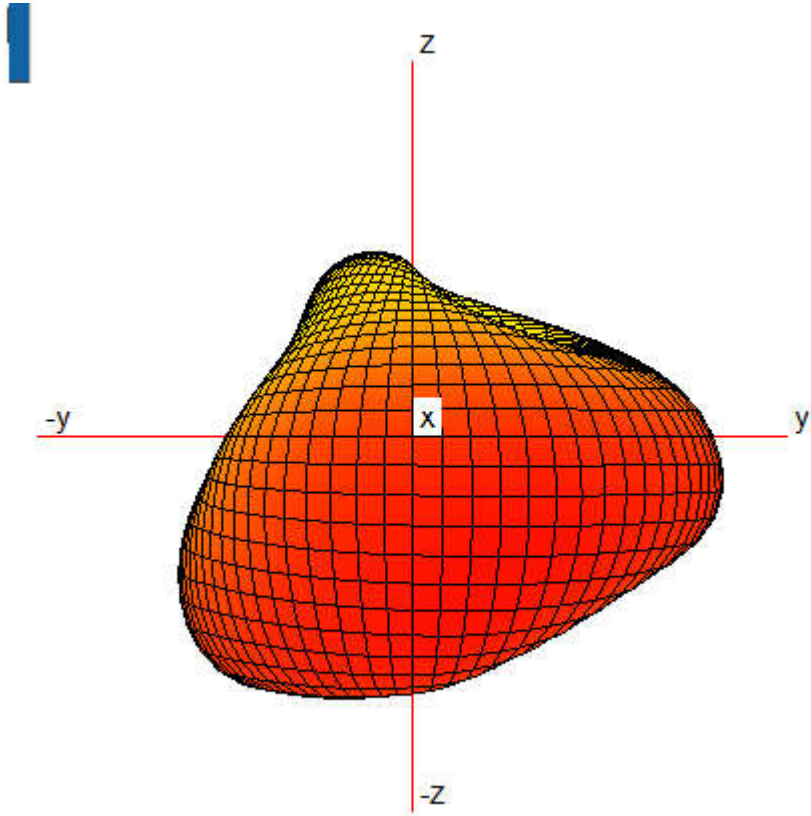

DCS 1800

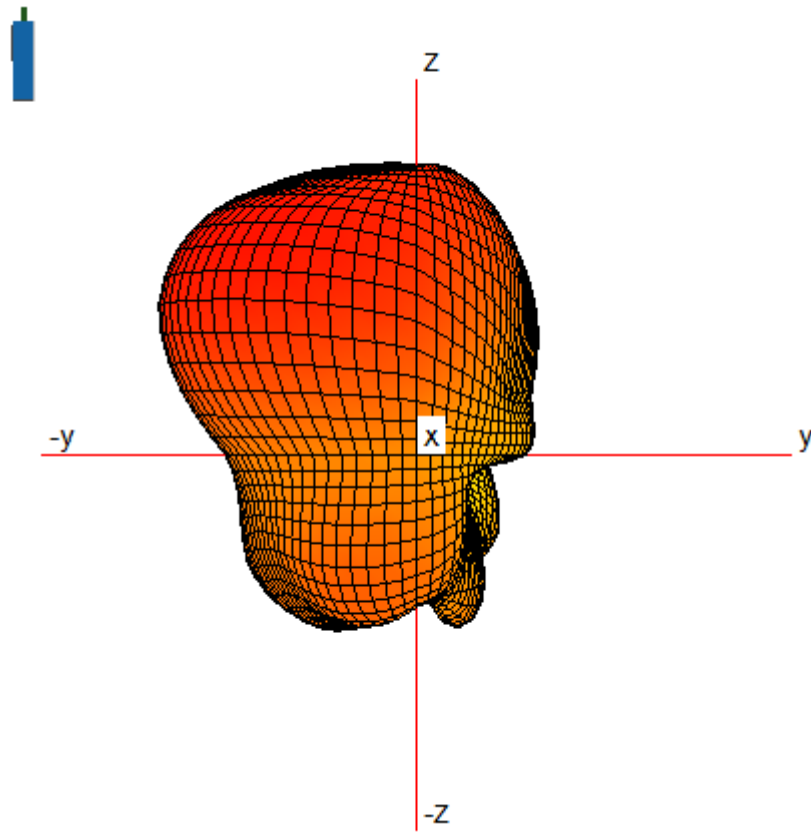

GSM 1900

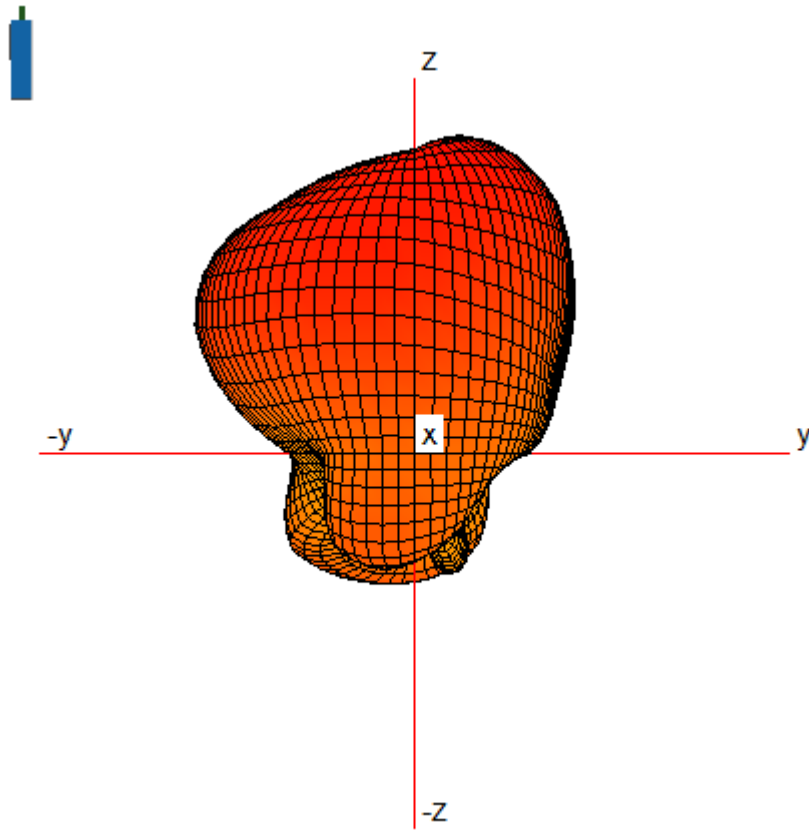

W FDD I

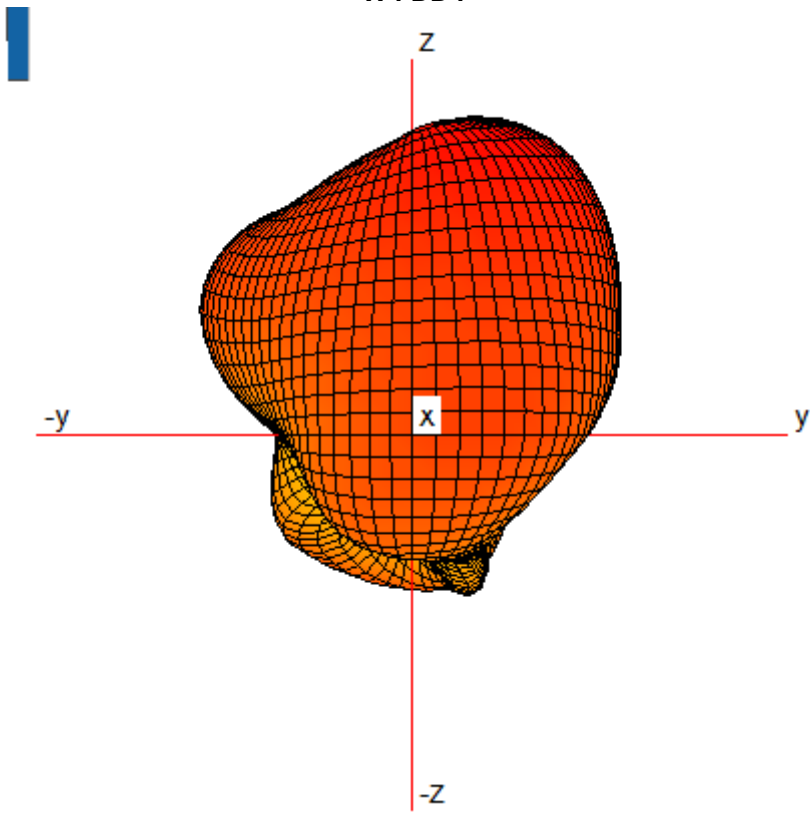

W FDD II

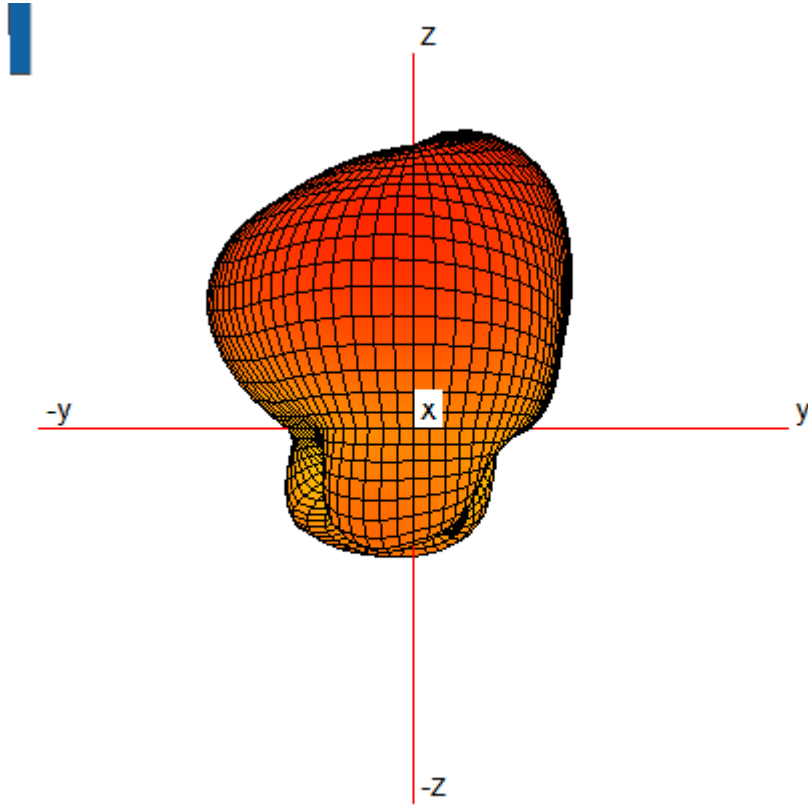

W FDD IV

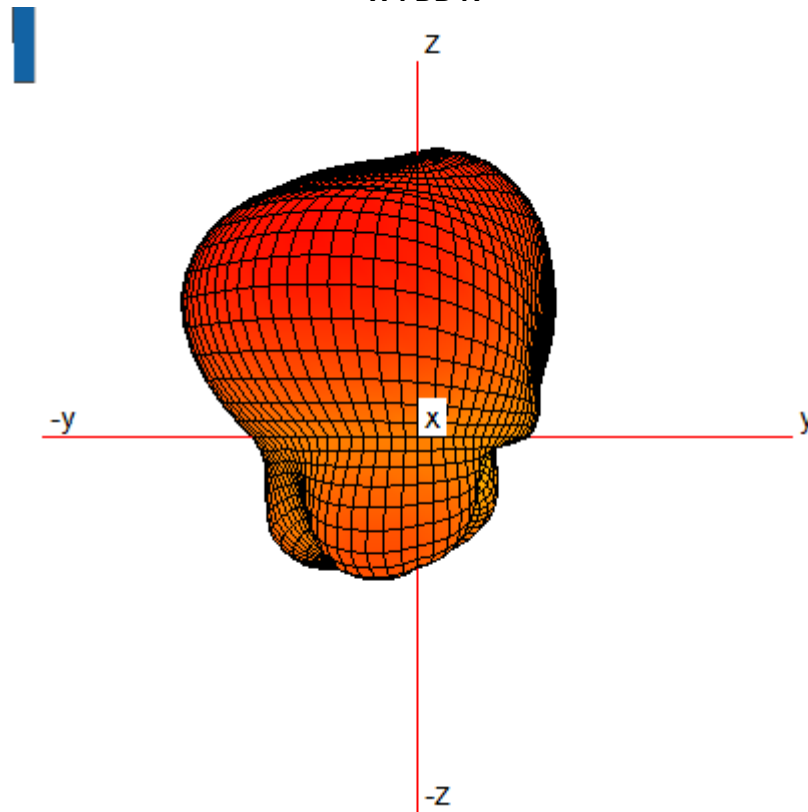

W FDD V

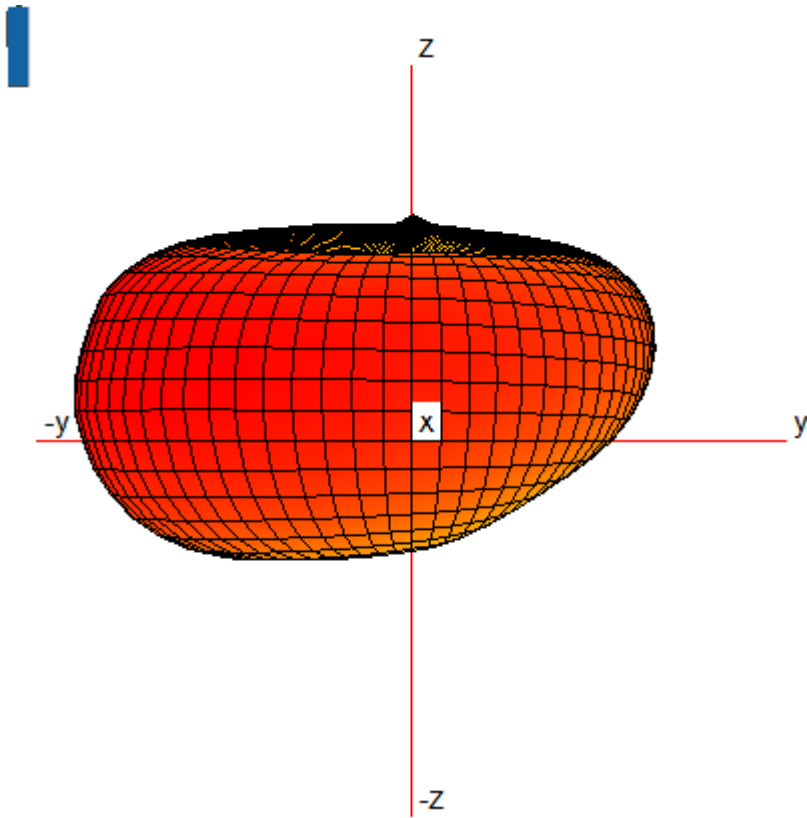

W FDD VIII

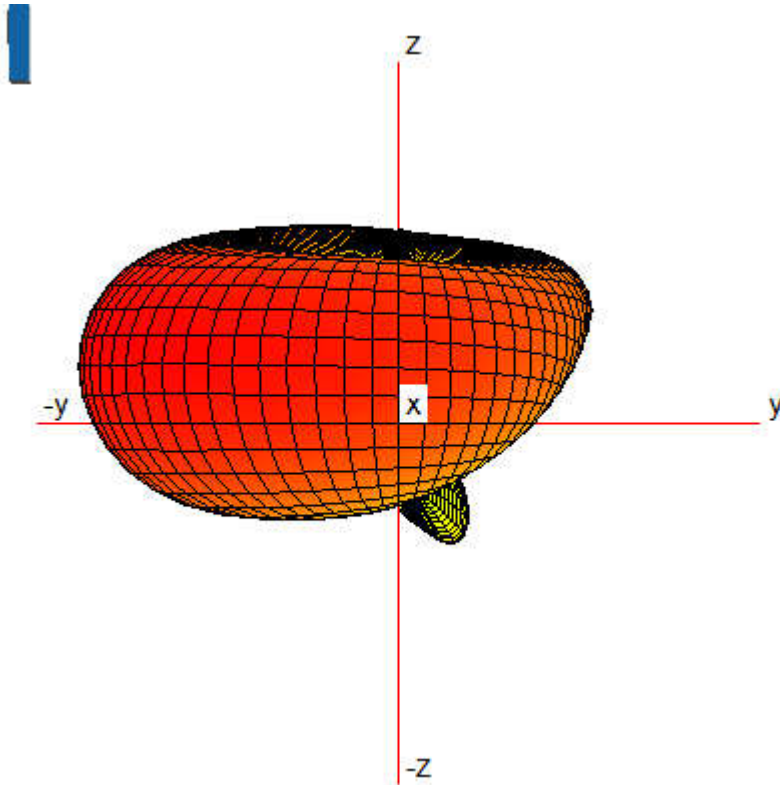

LTE B1

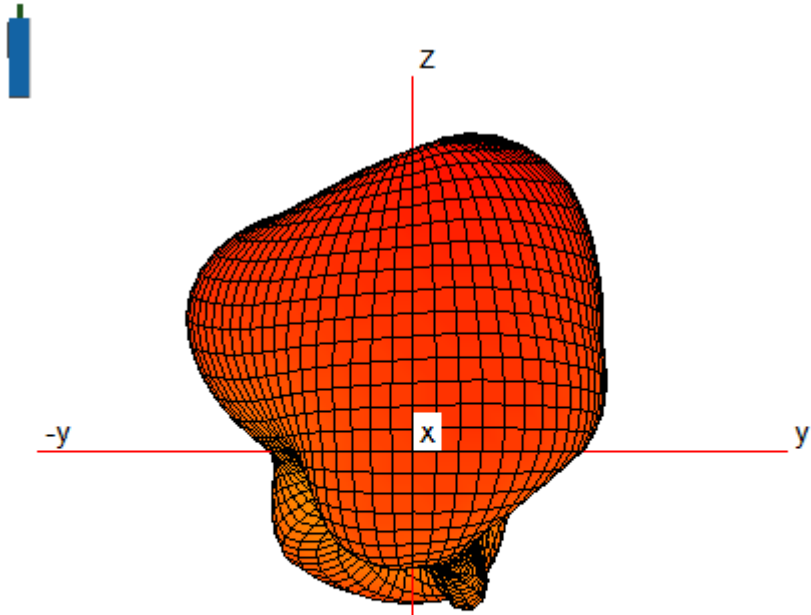

LTE B2

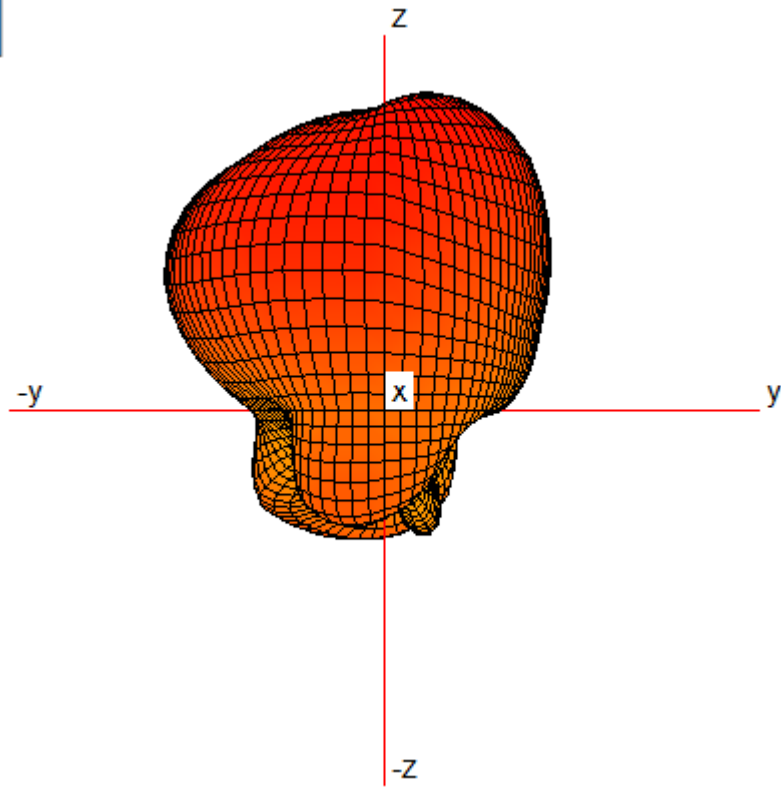

LTE B3



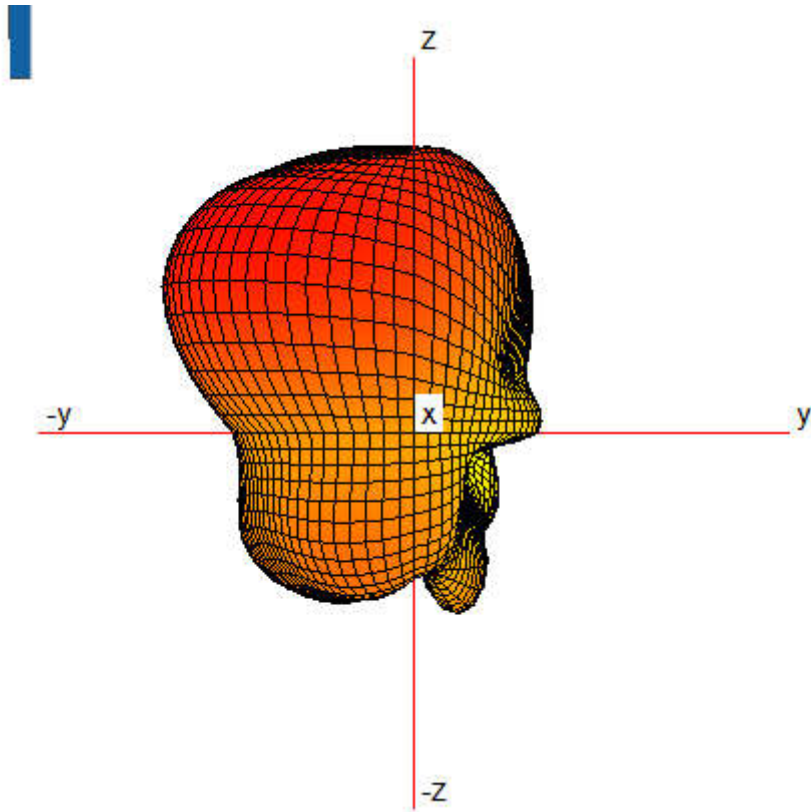

LTE B4

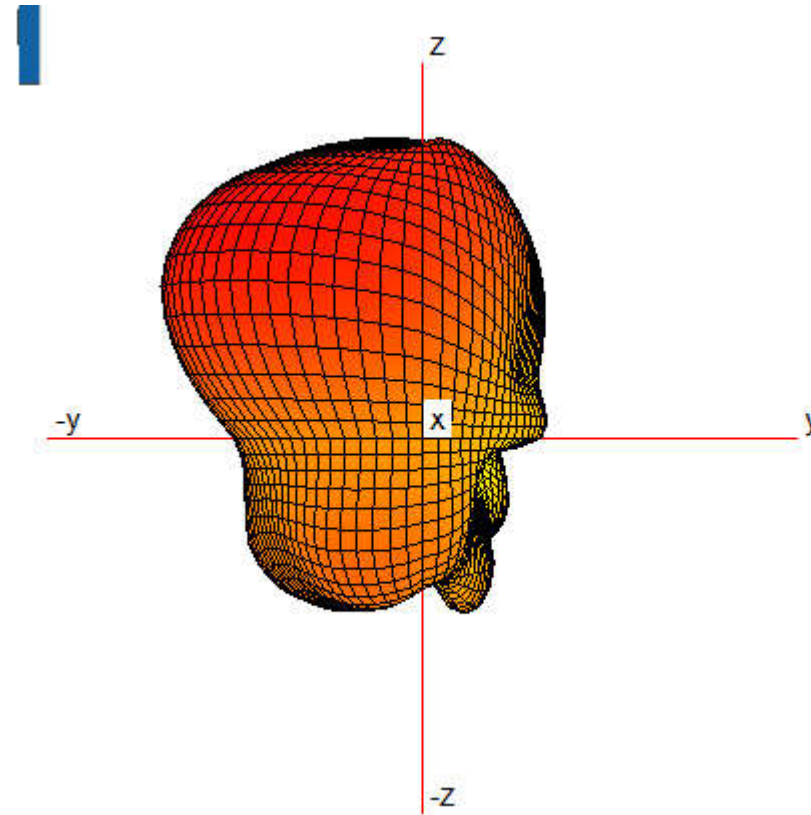

LTE B5

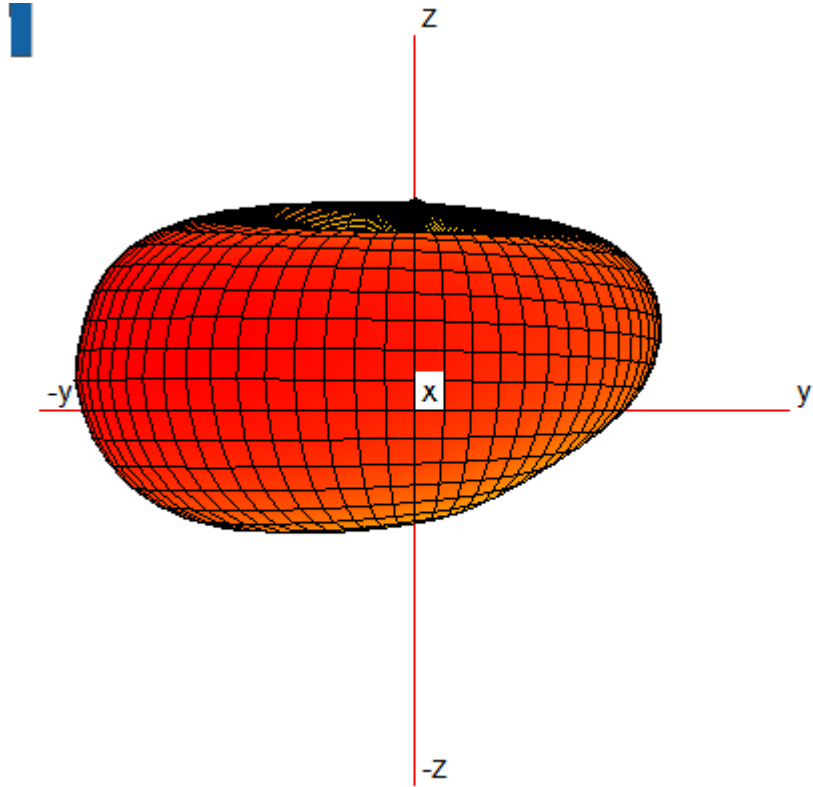

LTE B7

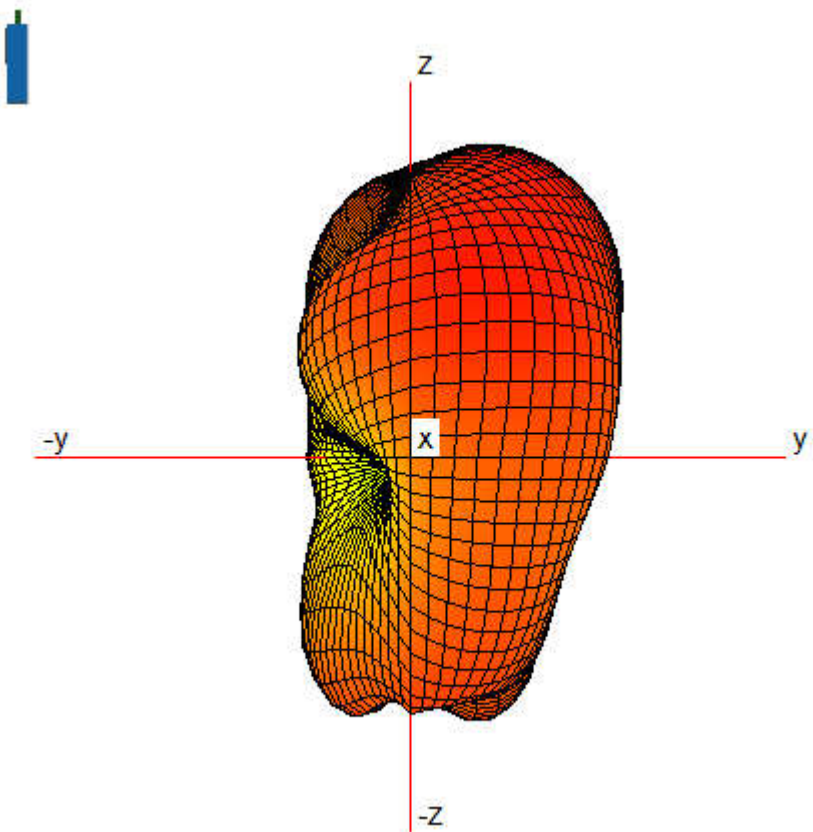

LTE B8

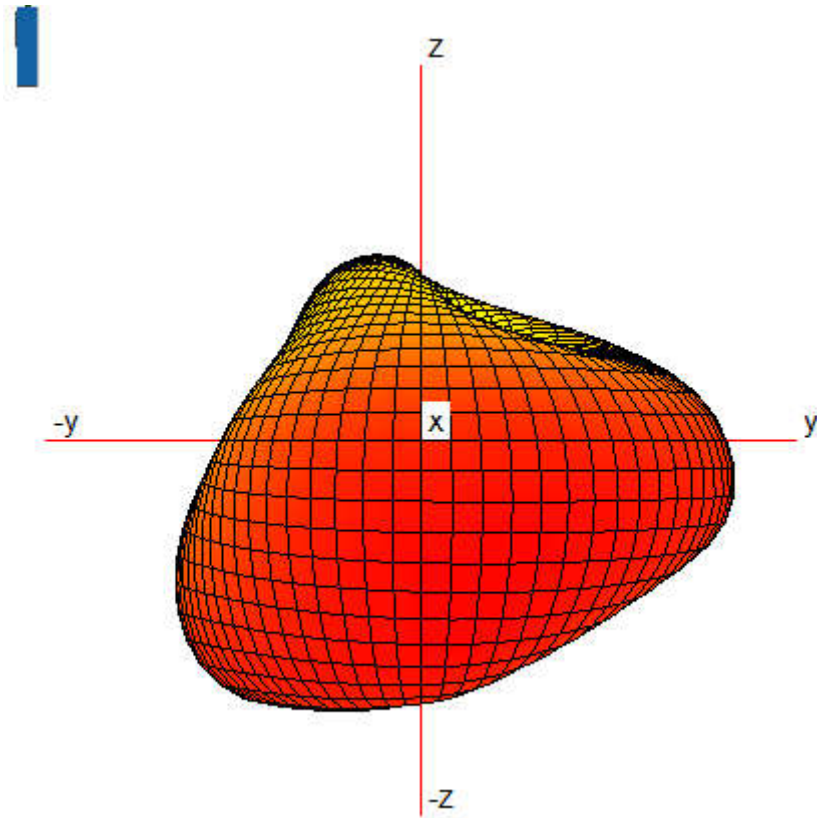

LTE B12

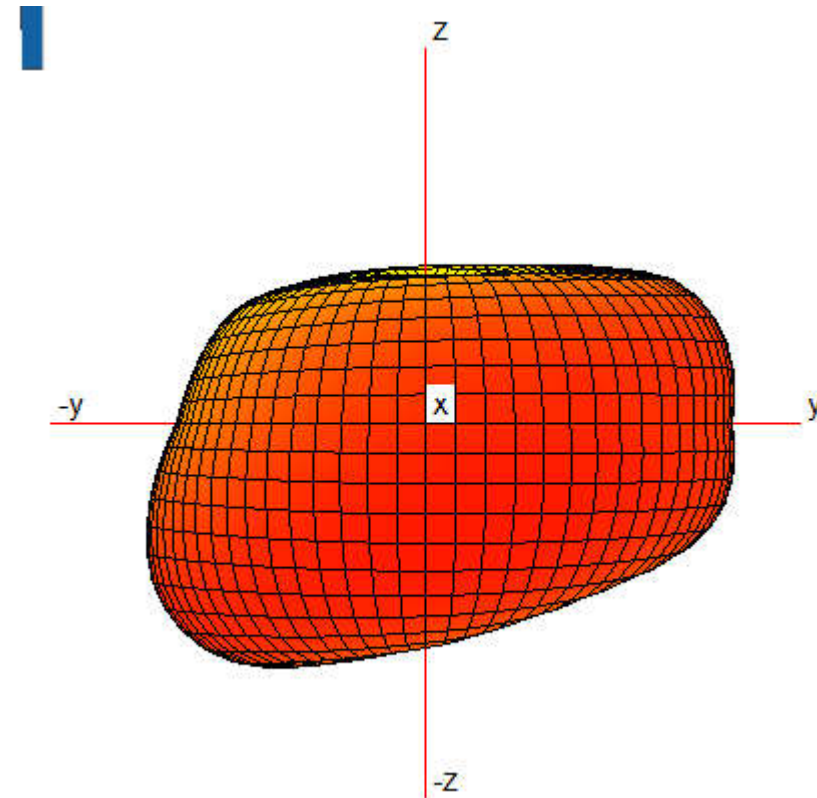

LTE B13

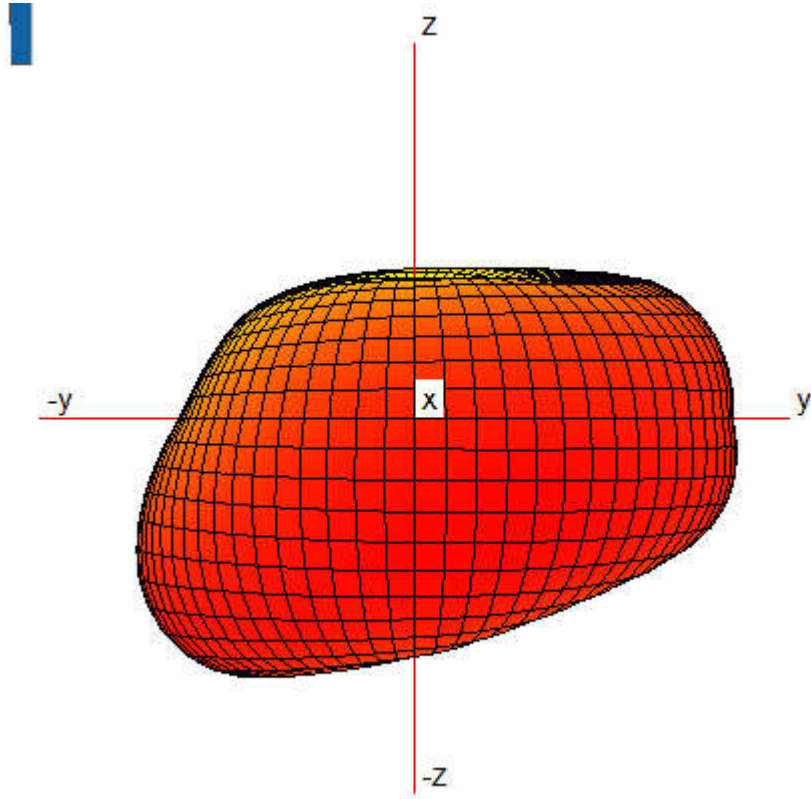

LTE B17  
z

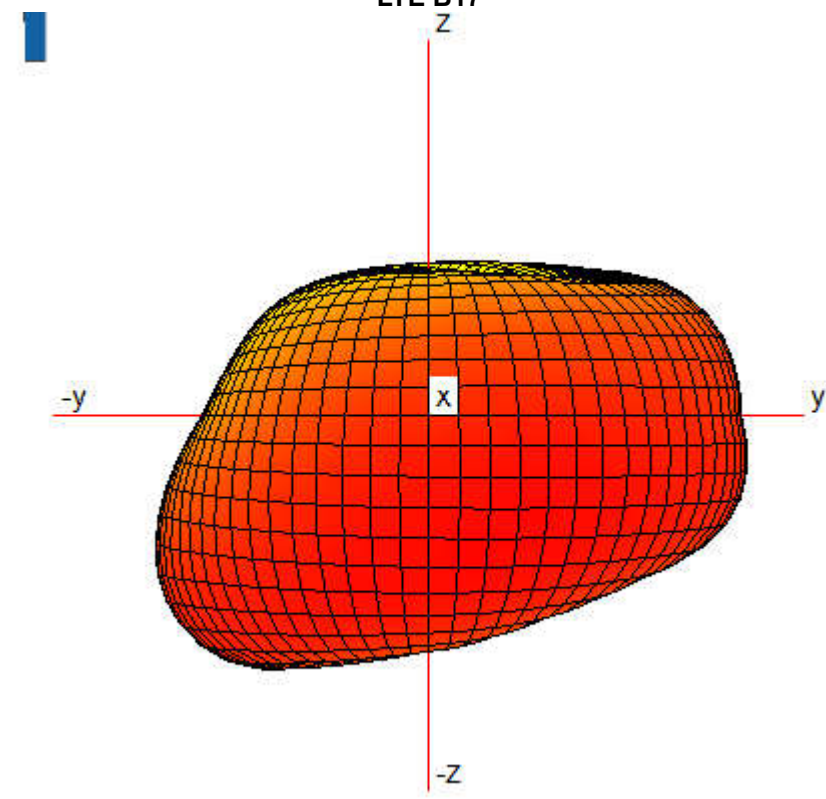

LTE B18

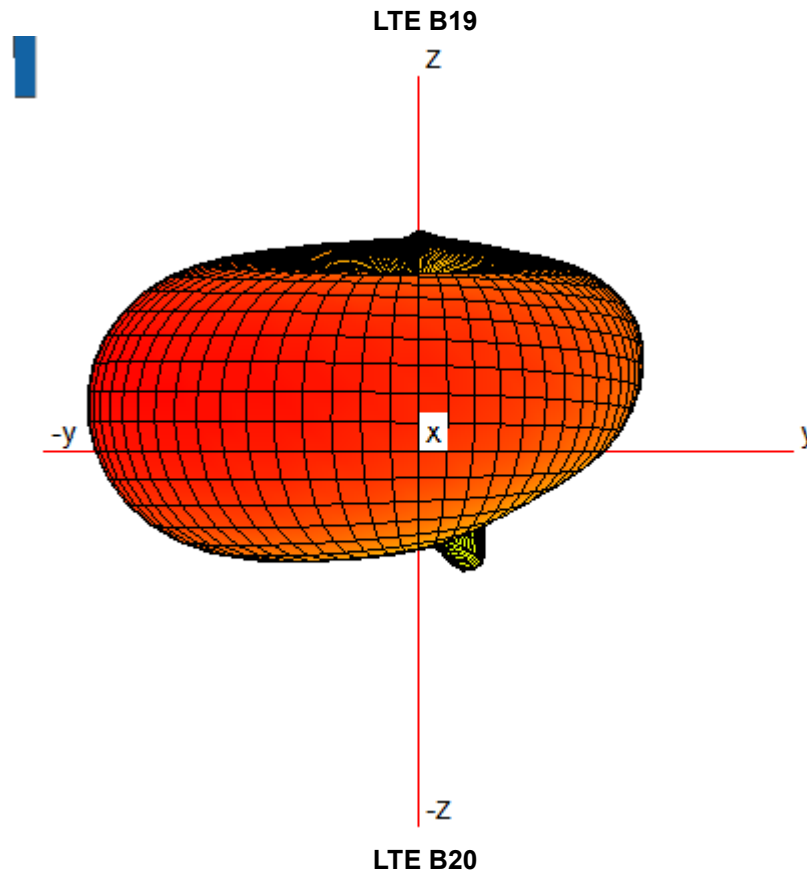
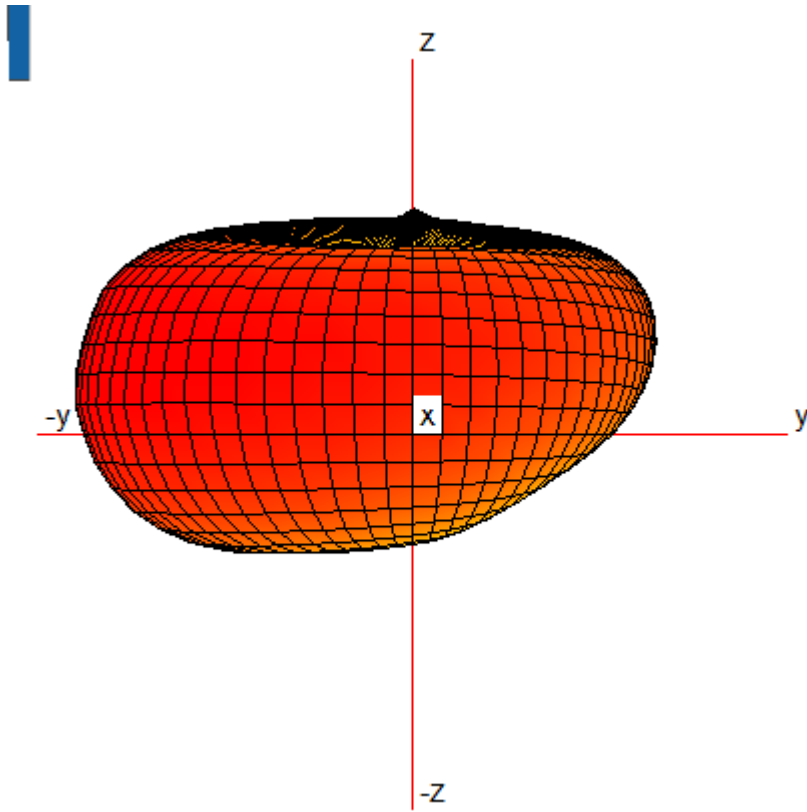

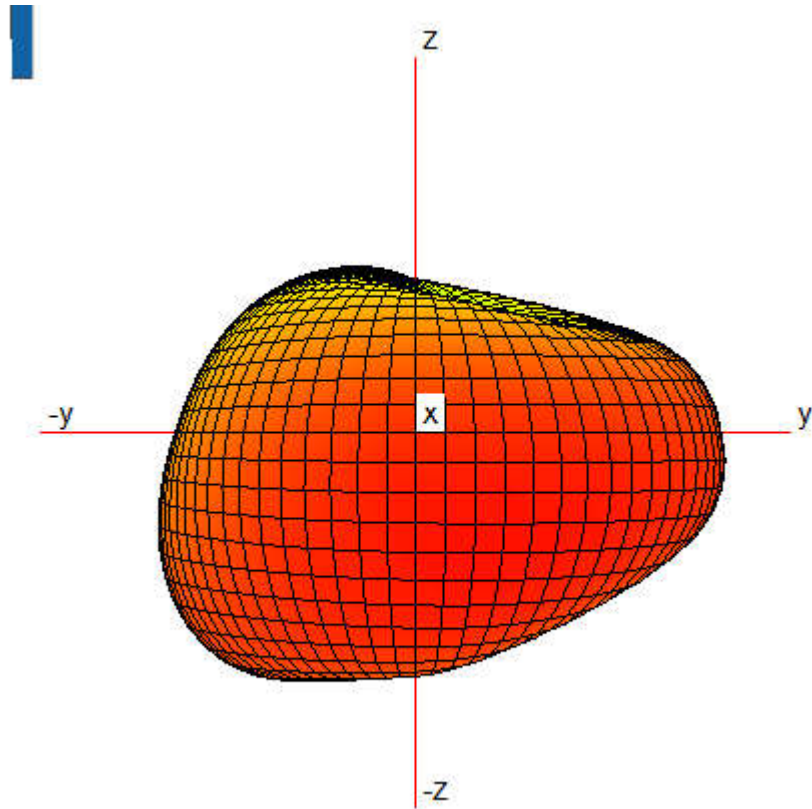

LTE B25

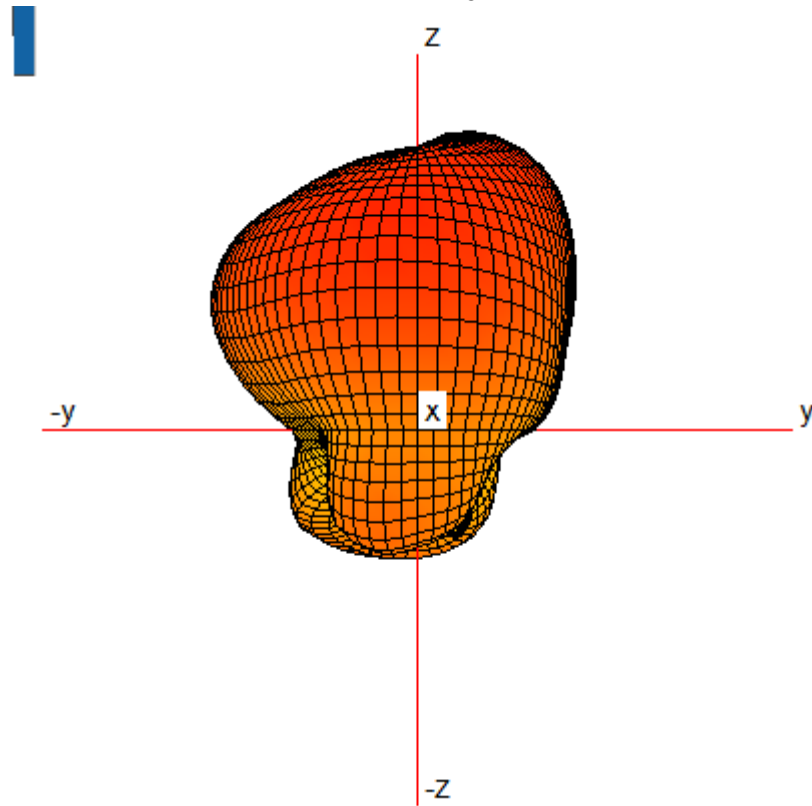

LTE B26

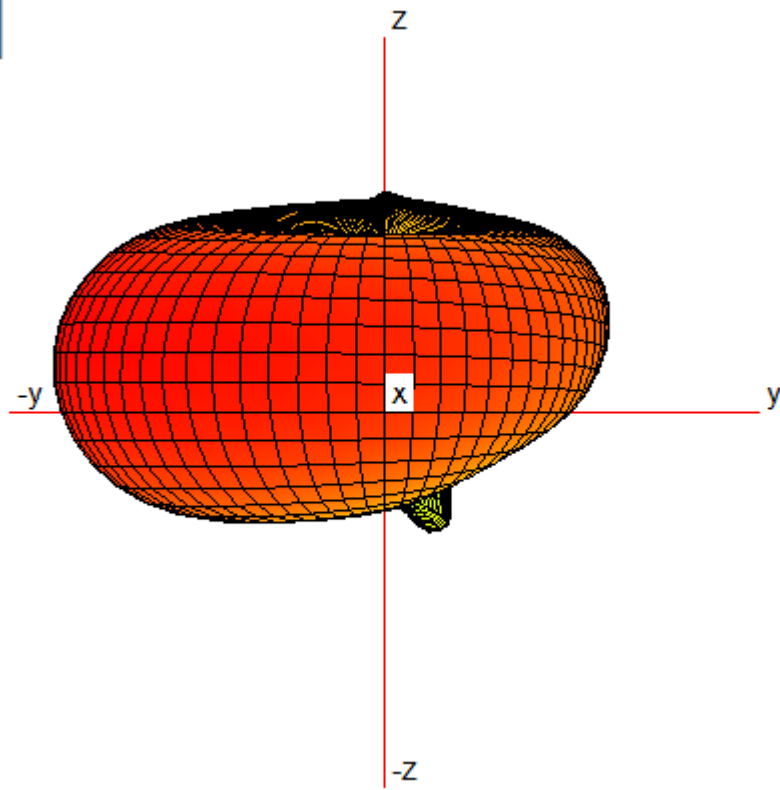

LTE B28

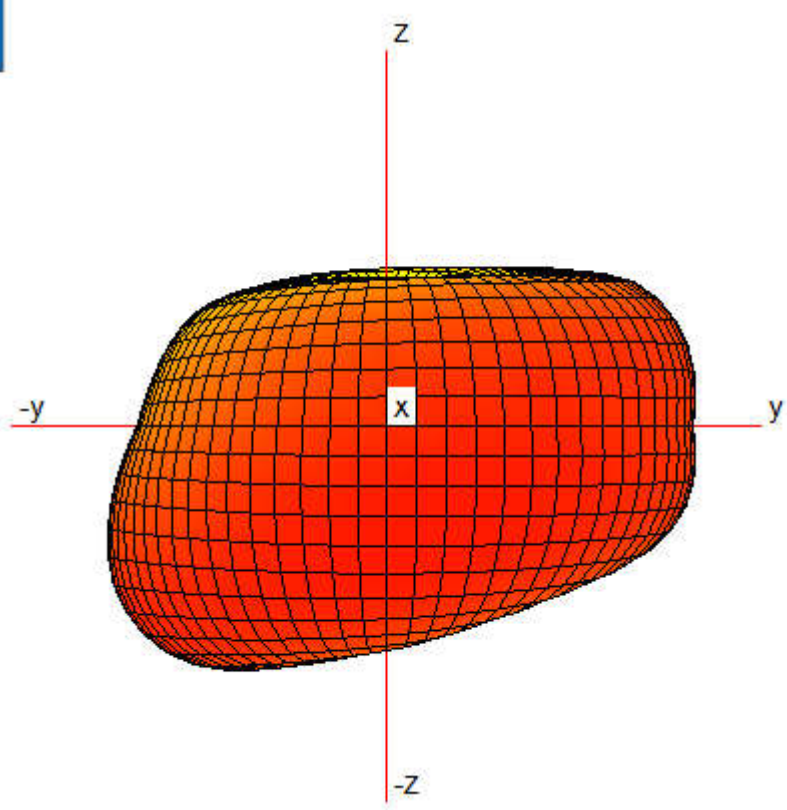

LTE B34

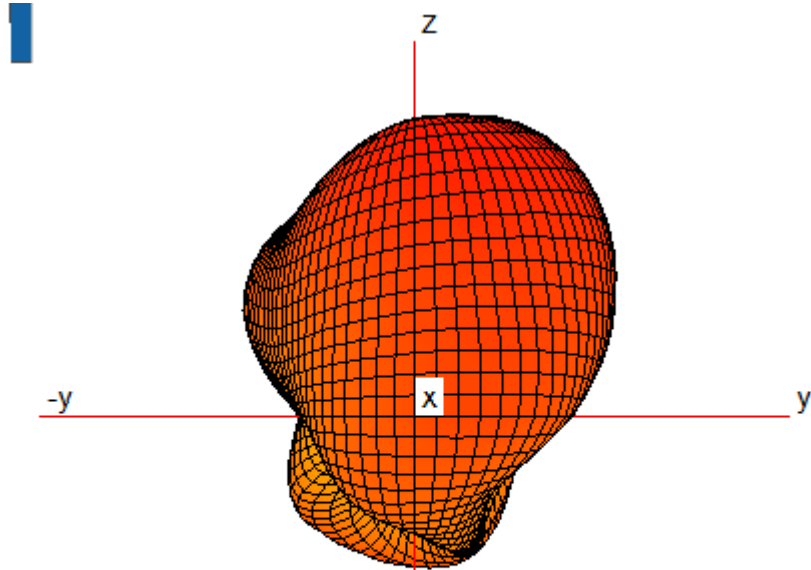

LTE B38

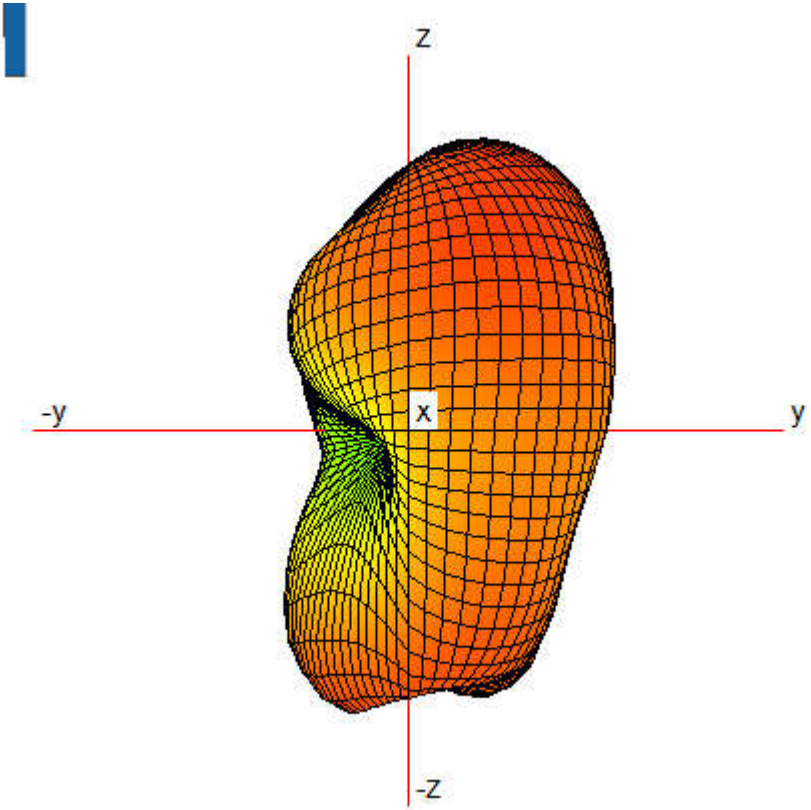

LTE B39



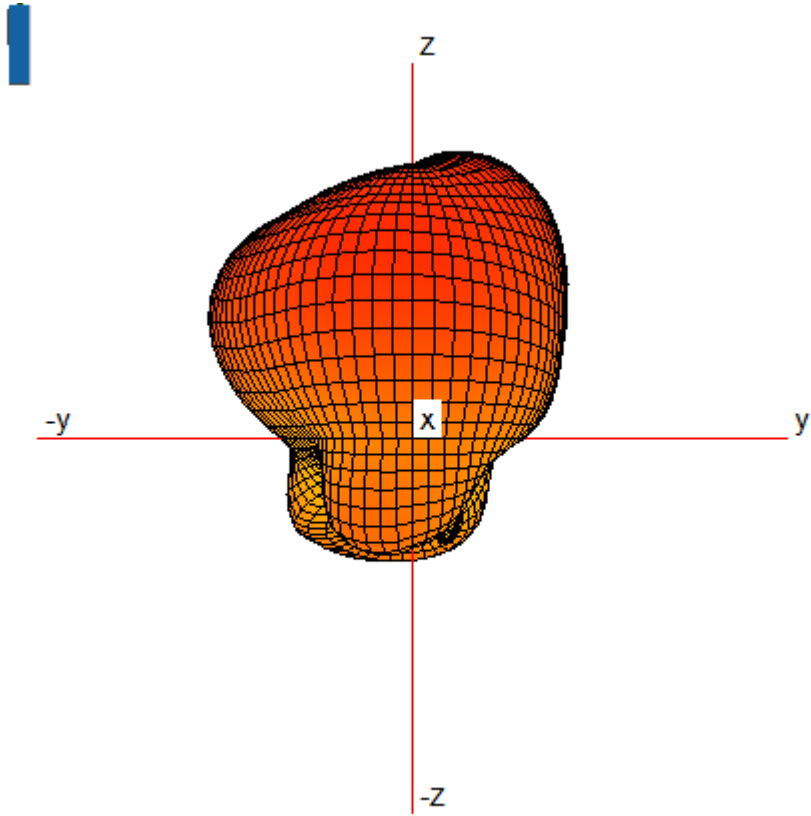

LTE B40

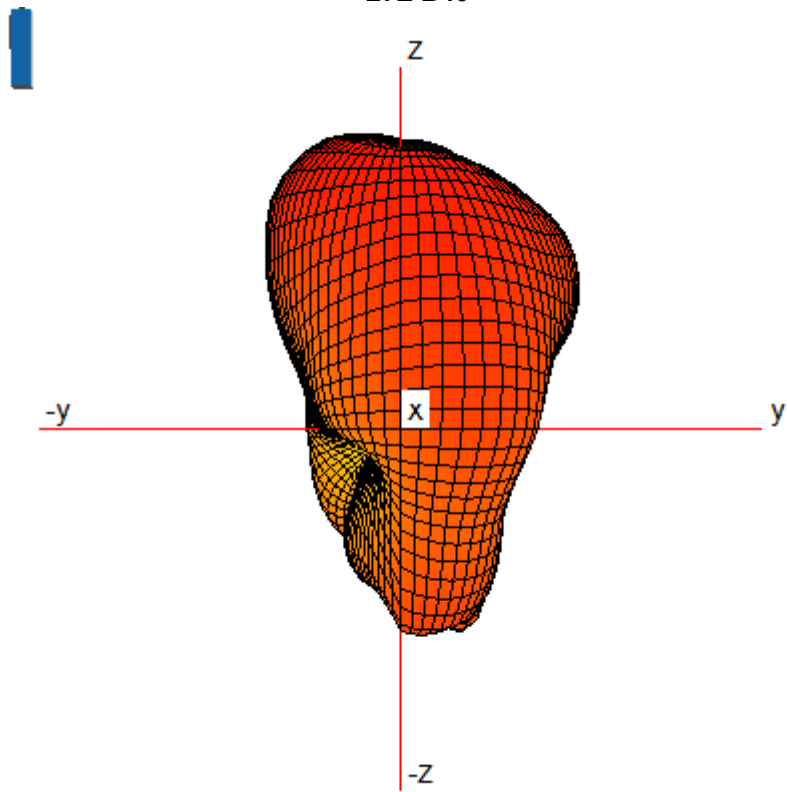

LTE B41

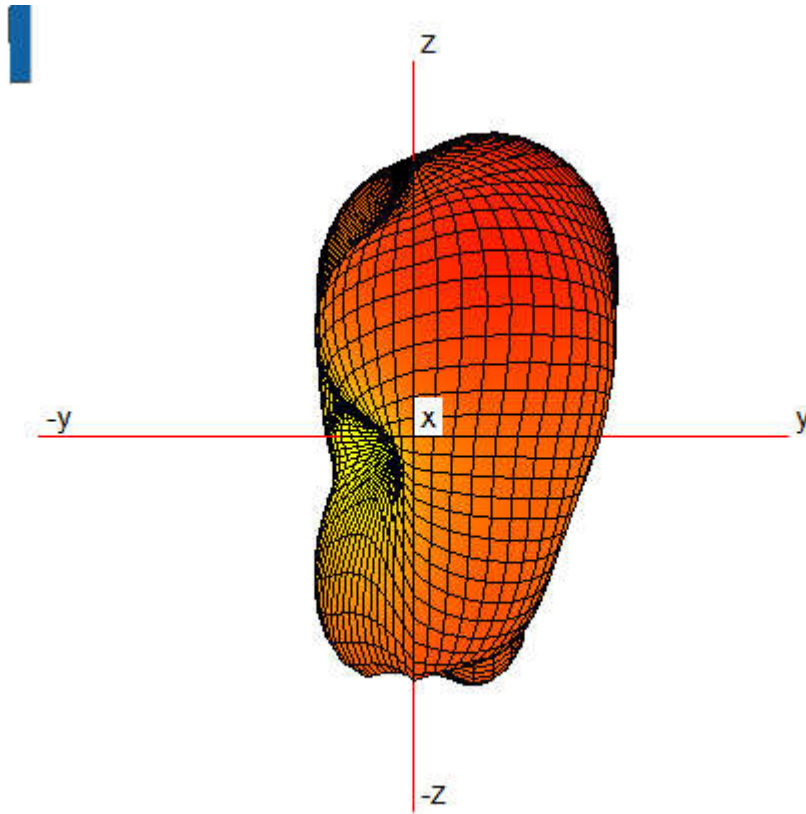

---

**LTE B42**

**LTE B43**

**LTE B48**

**LTE B66**

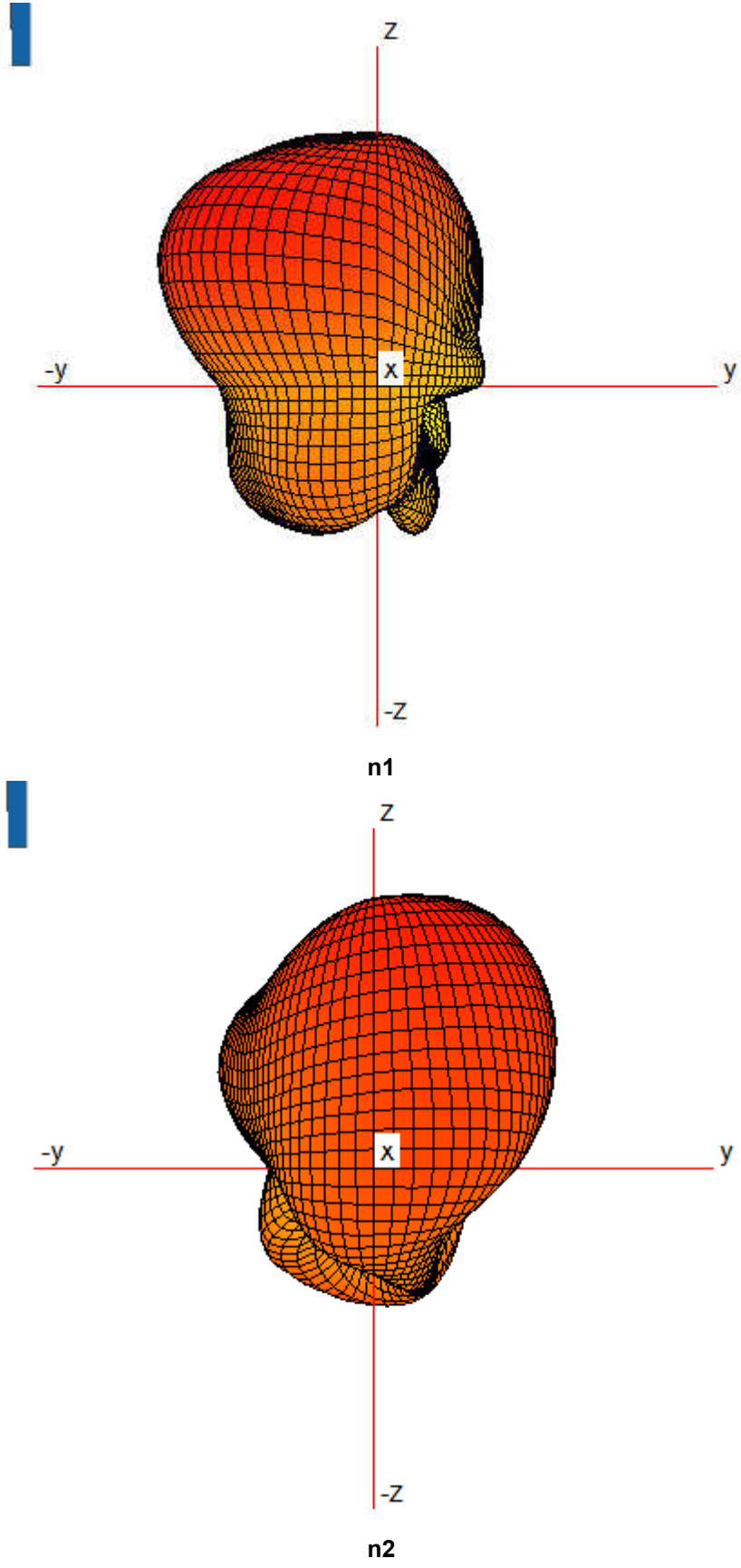

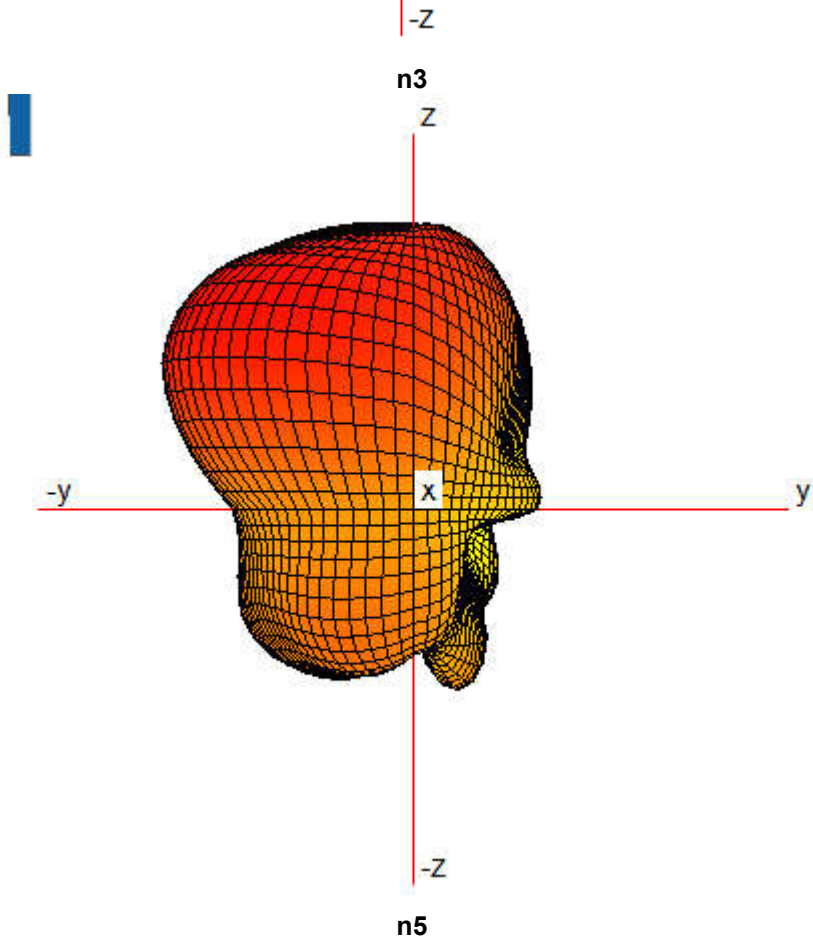
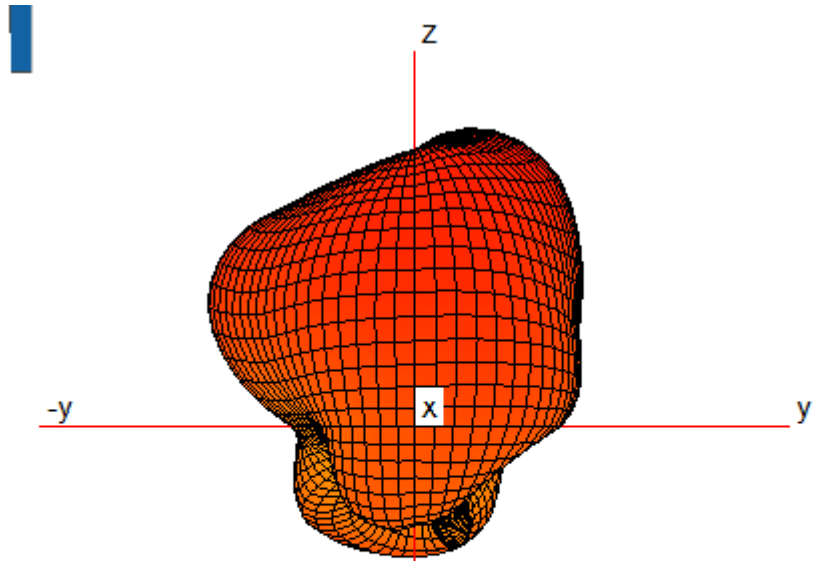

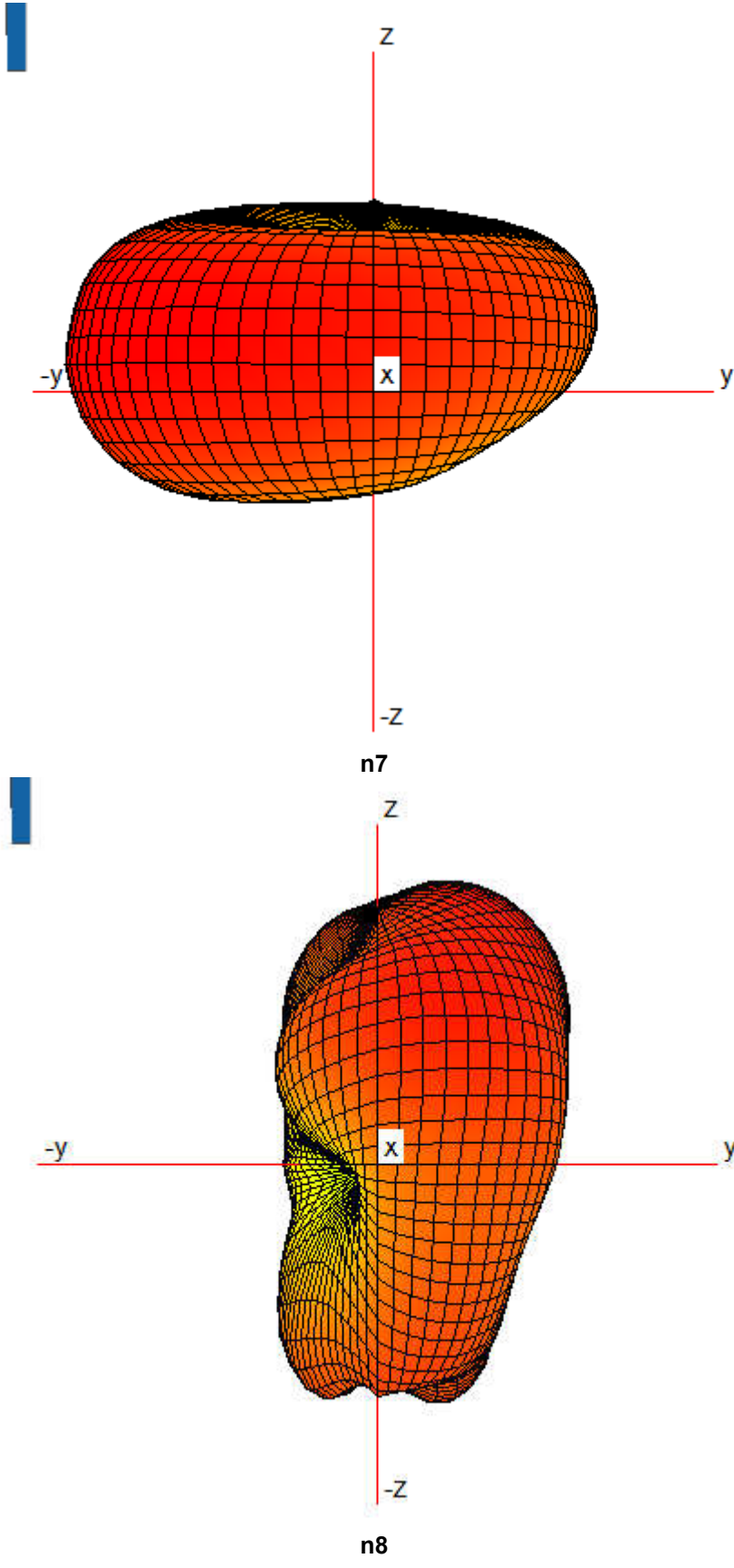

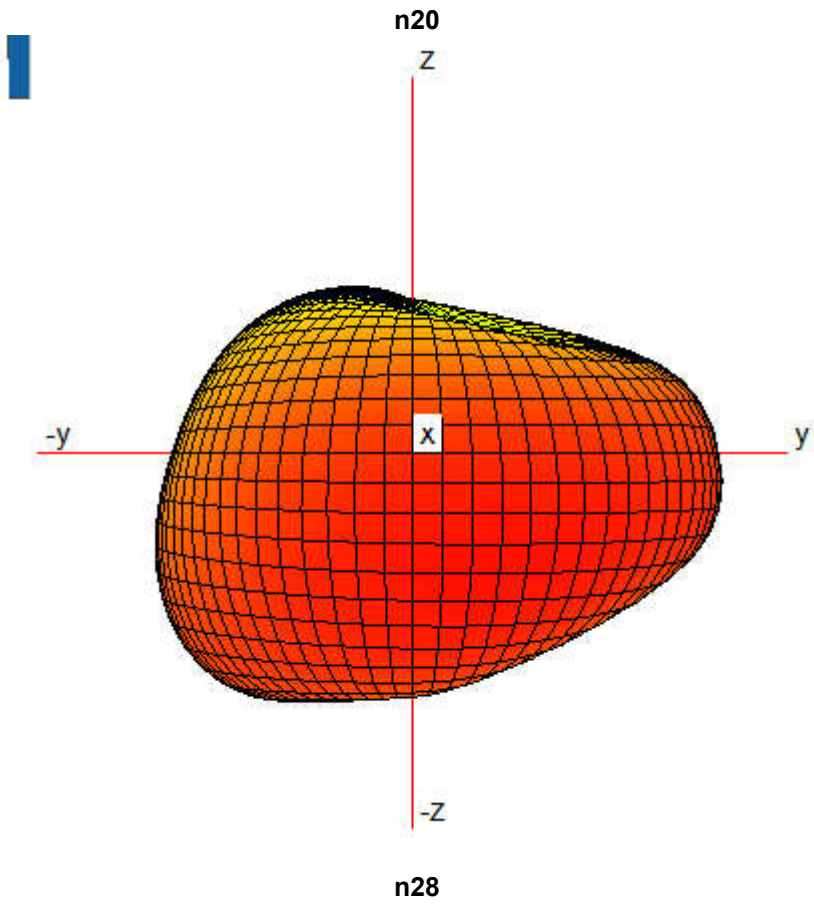
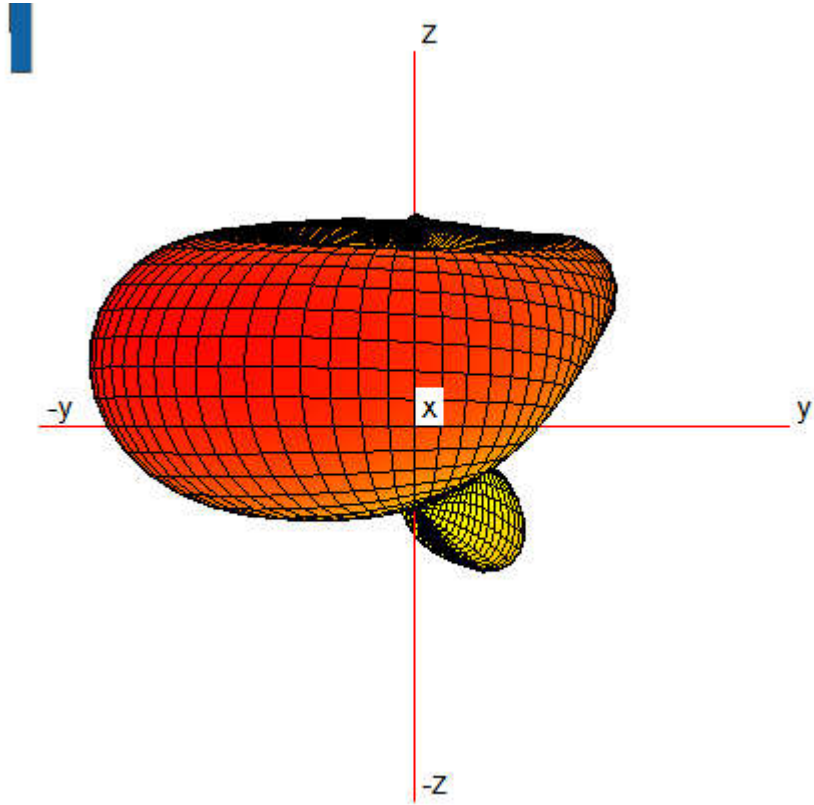

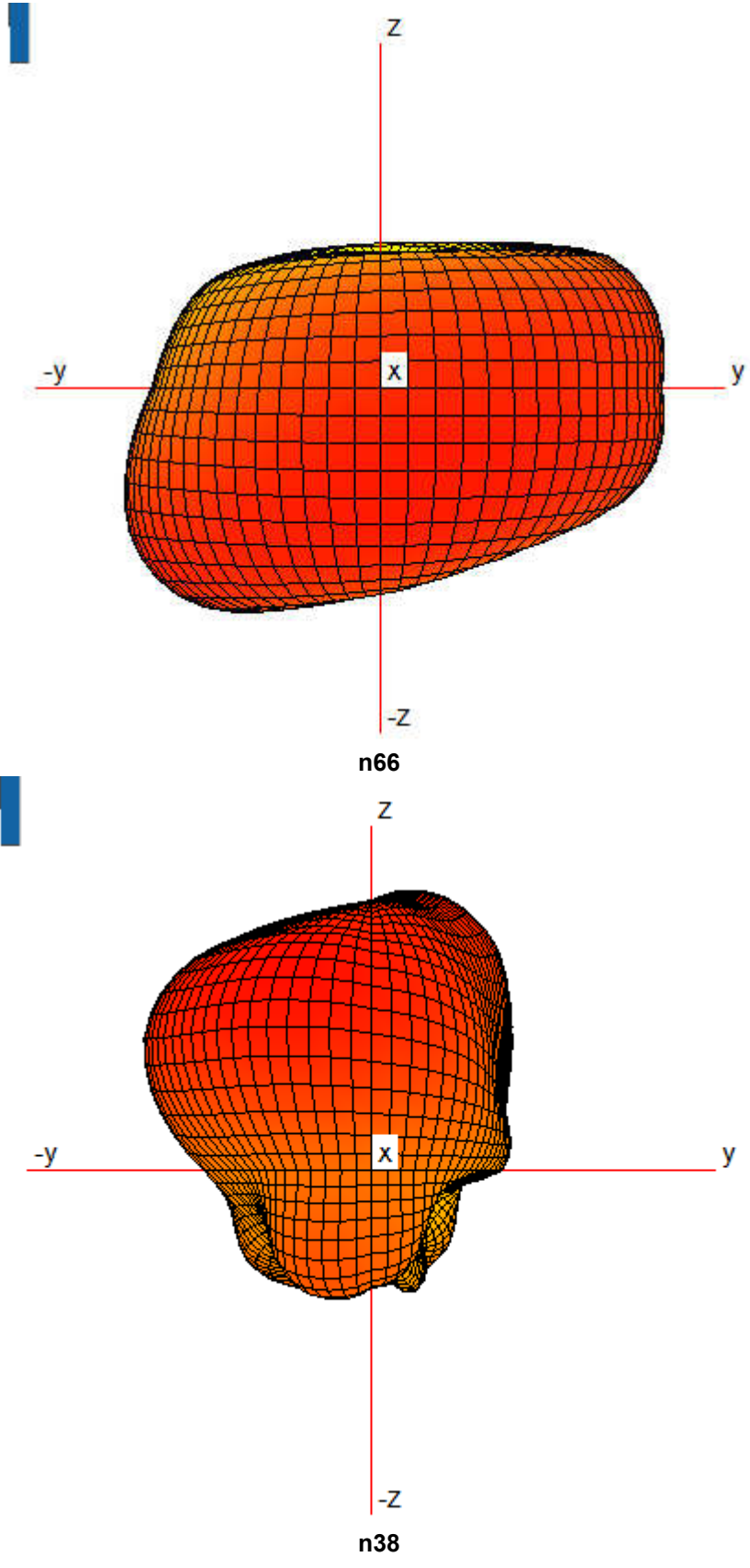

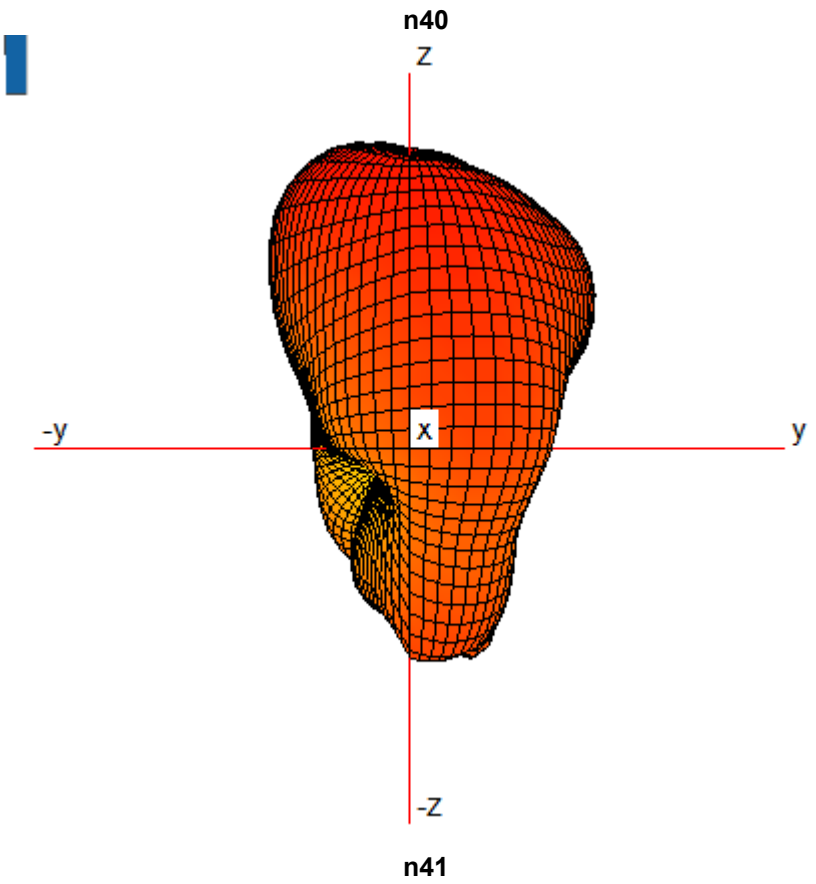
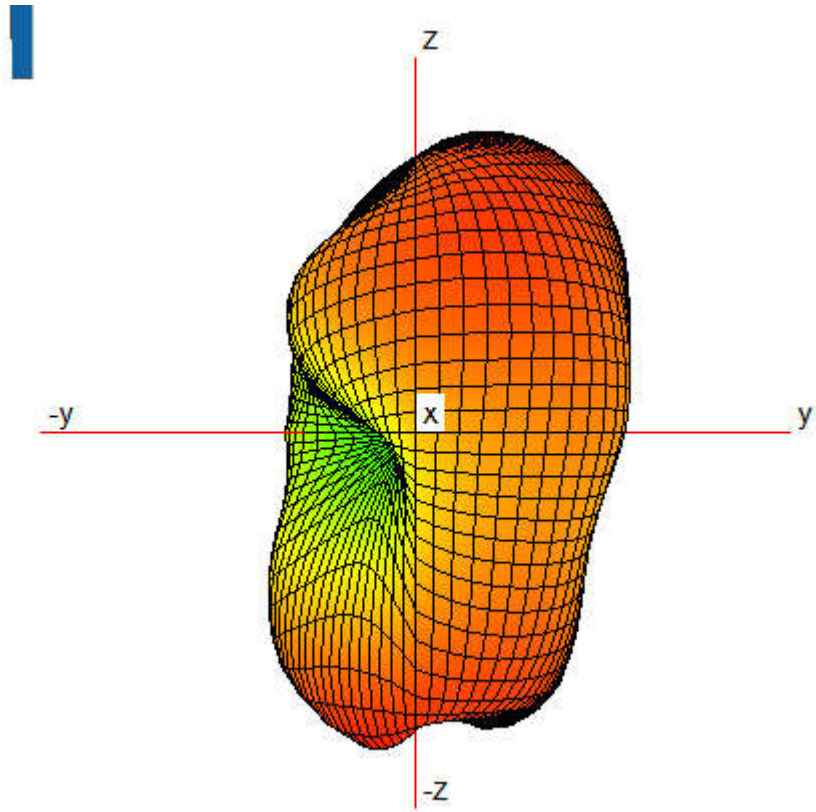



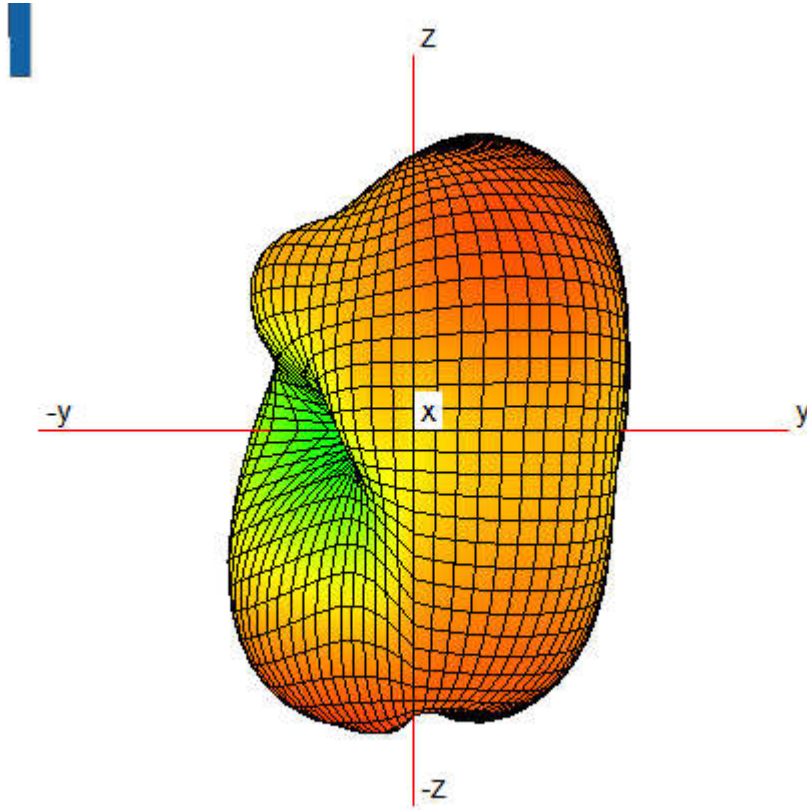

**ANT2**

**LTE B42**

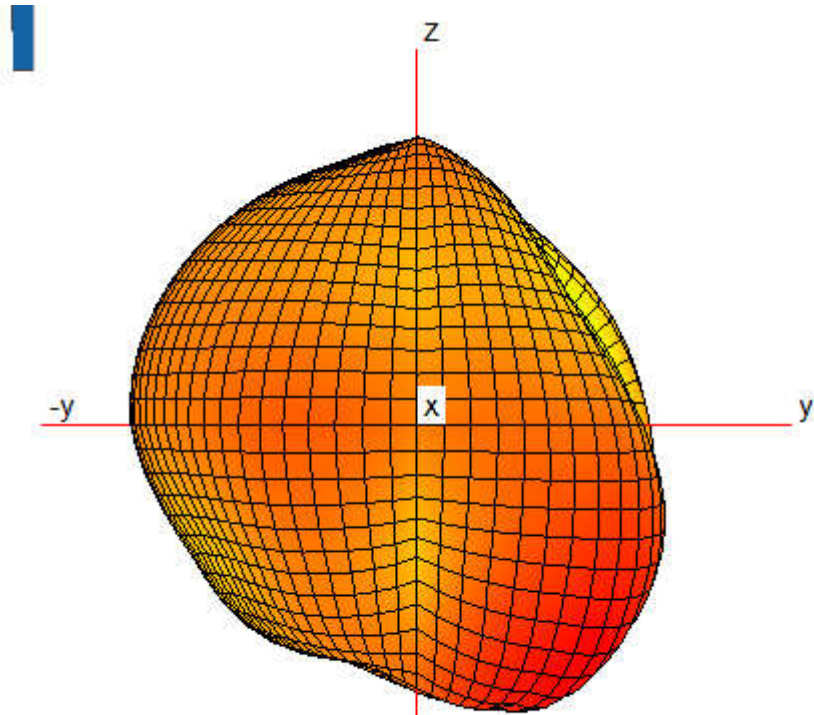

LTE B43

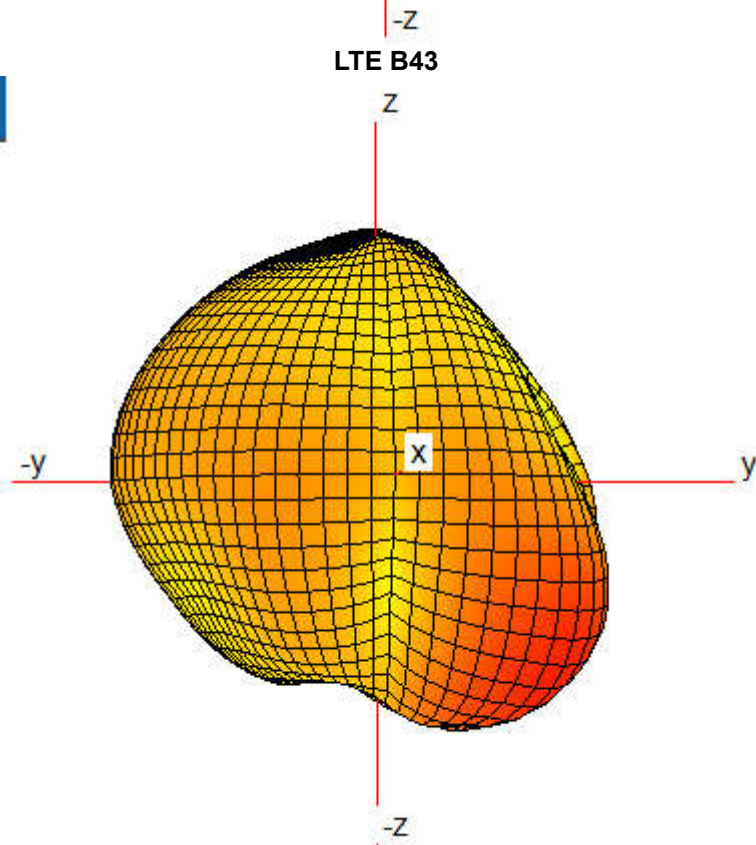

LTE B48

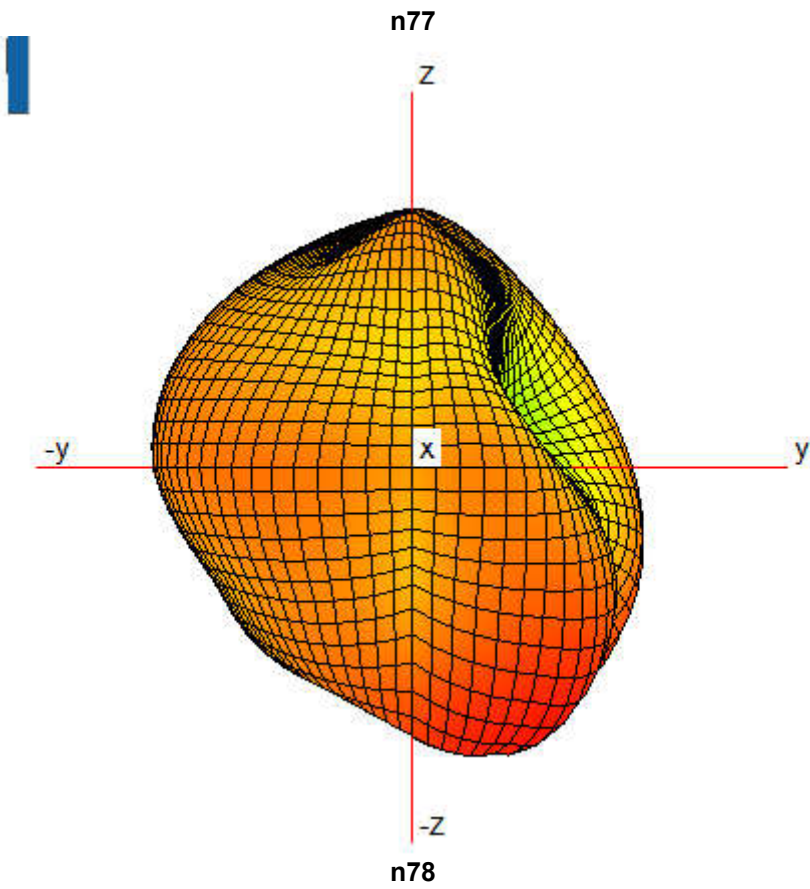
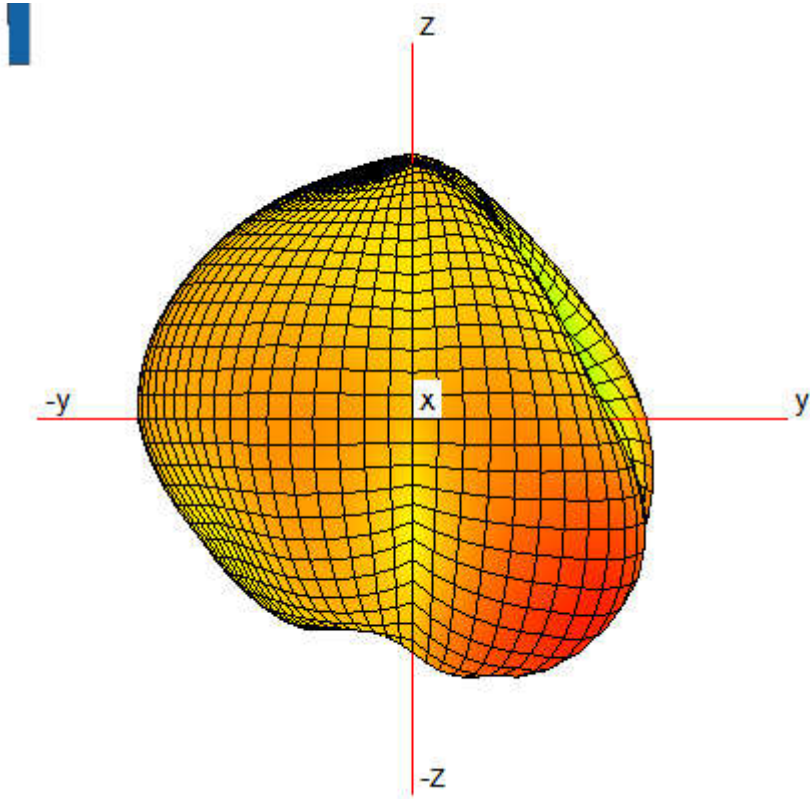

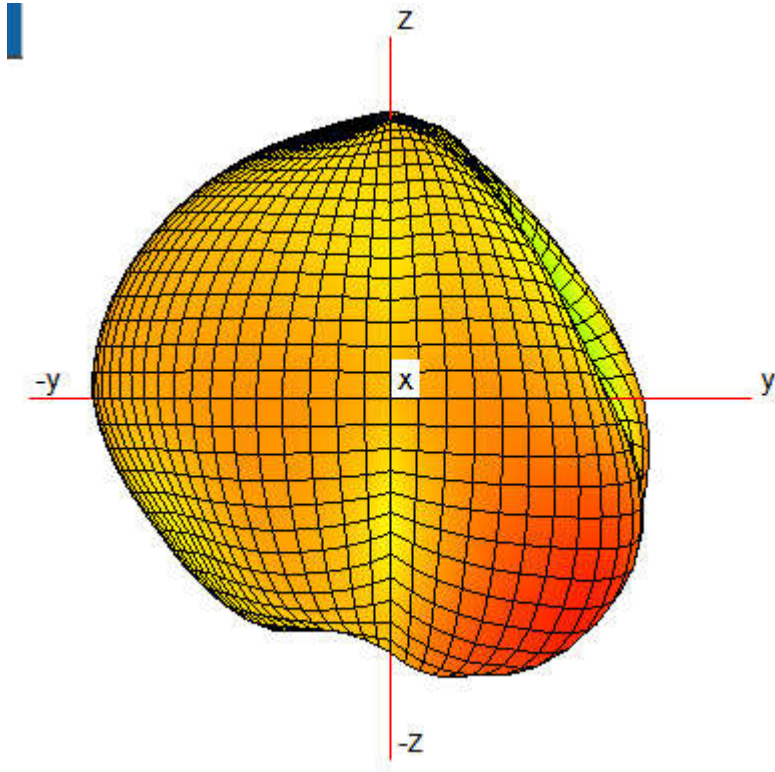

**ANT3**

**n77**

**n78**

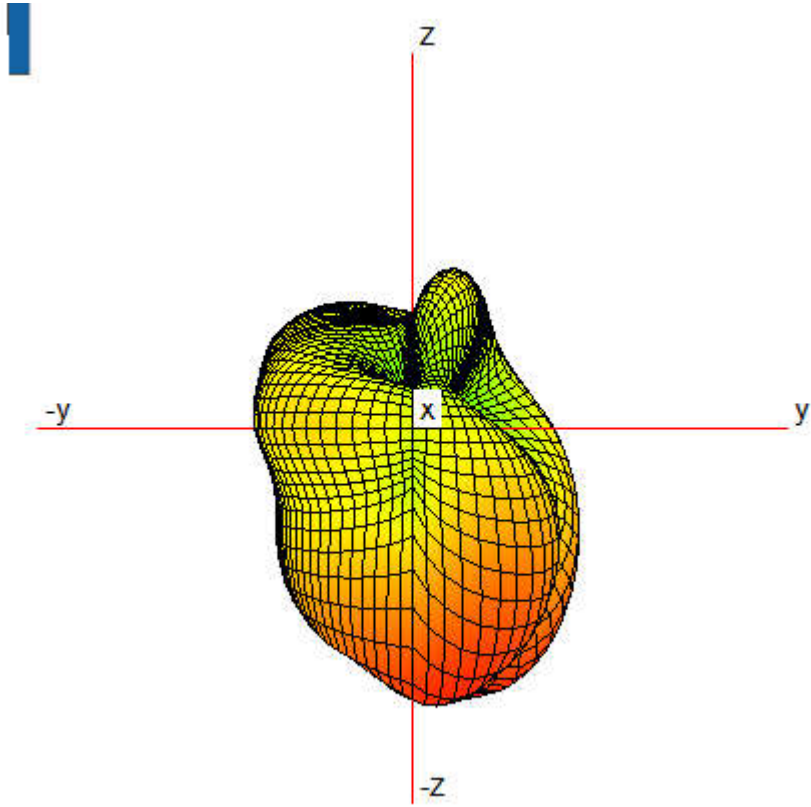

ANT5

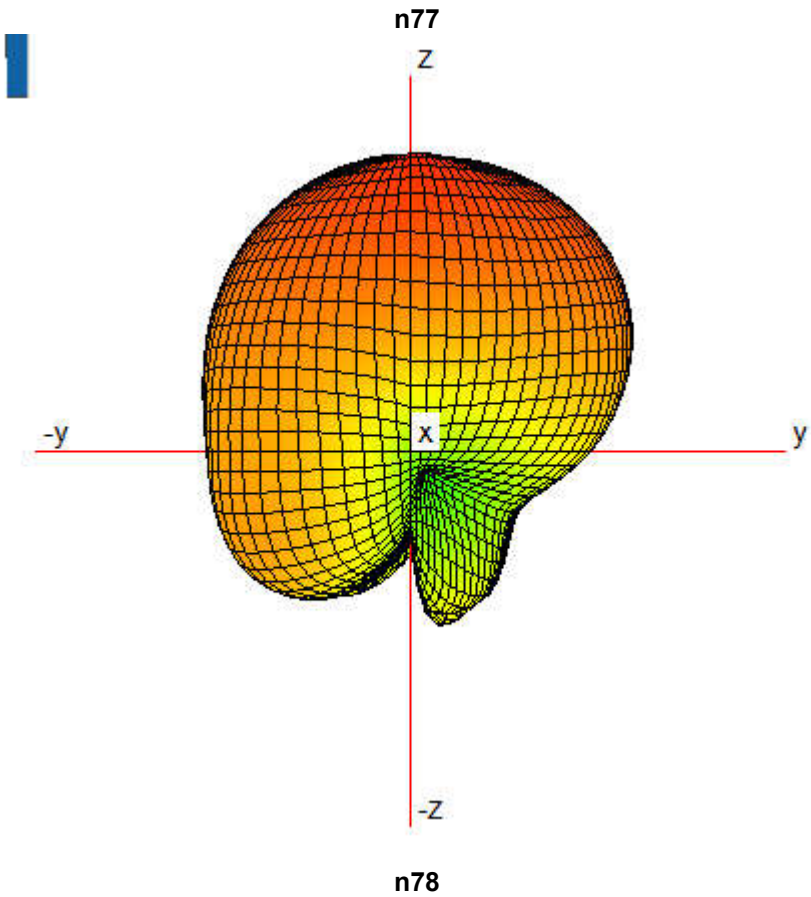

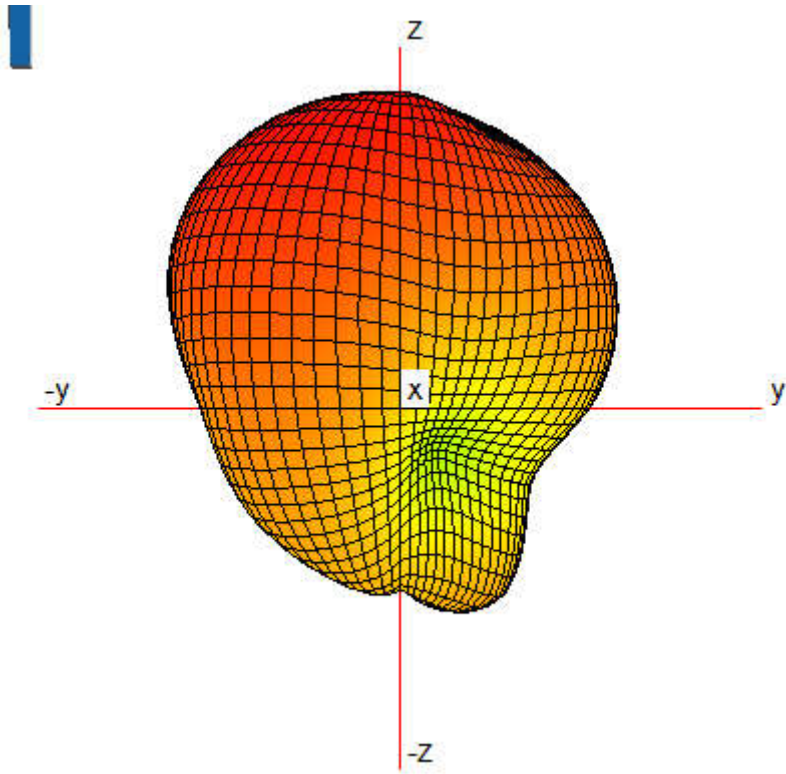

ANT7

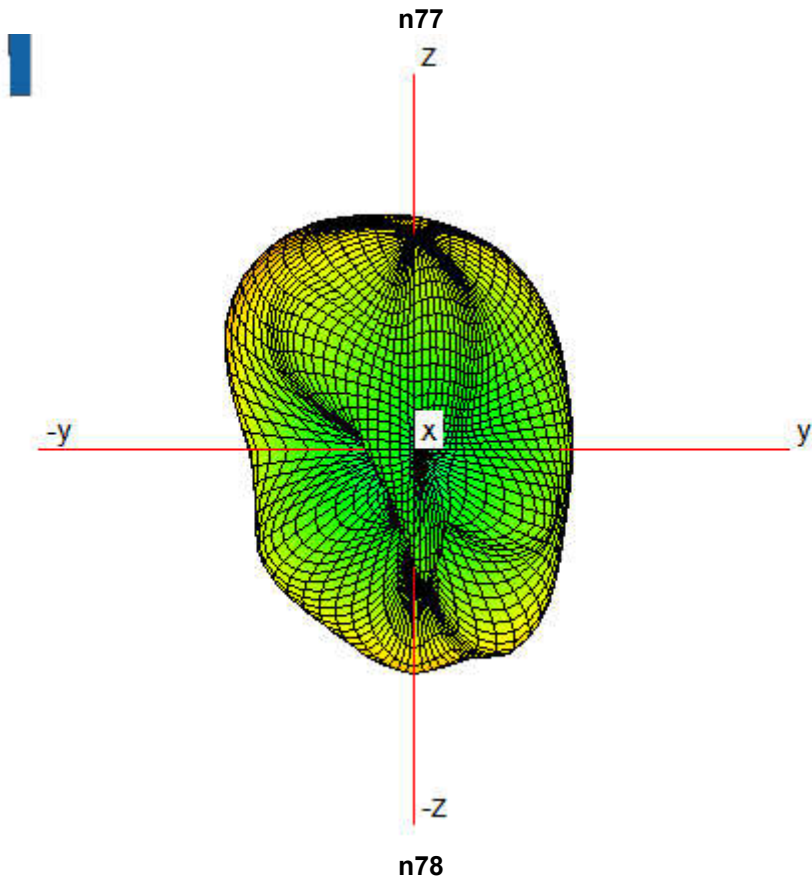

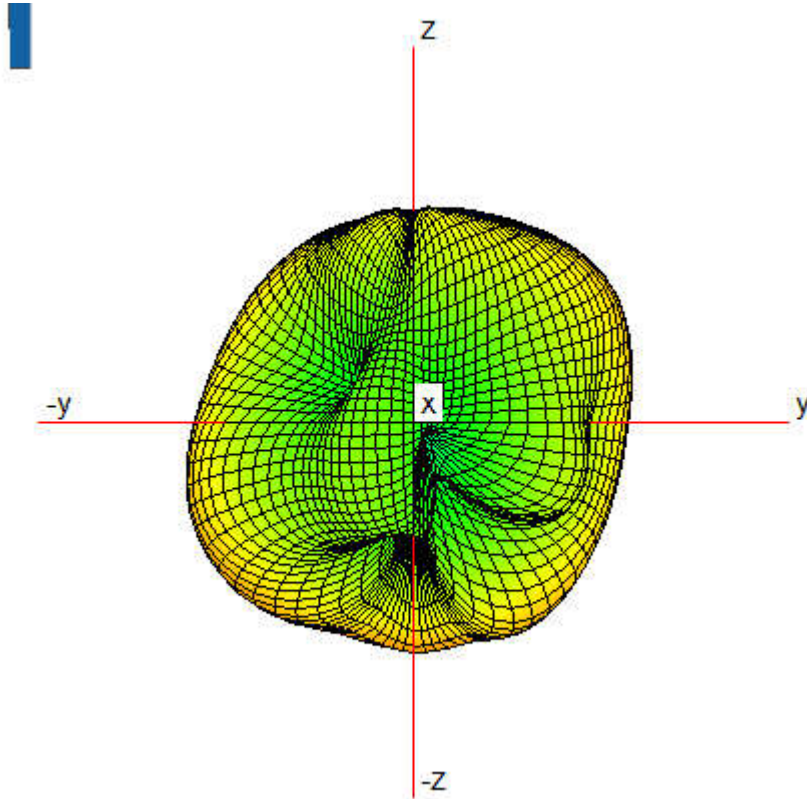

**ANT4 WIFI 2.4G TRx0**

**2450MHz**

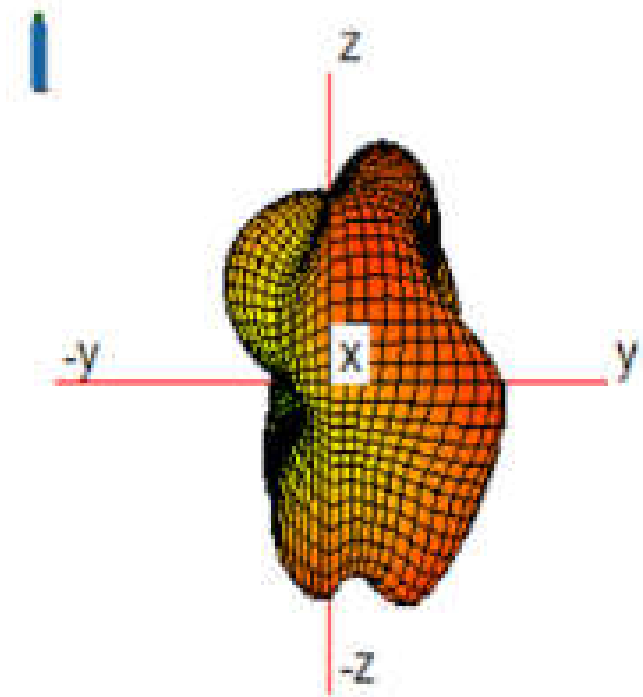

**ANT2 WIFI 5G TRx0**

5450MHz

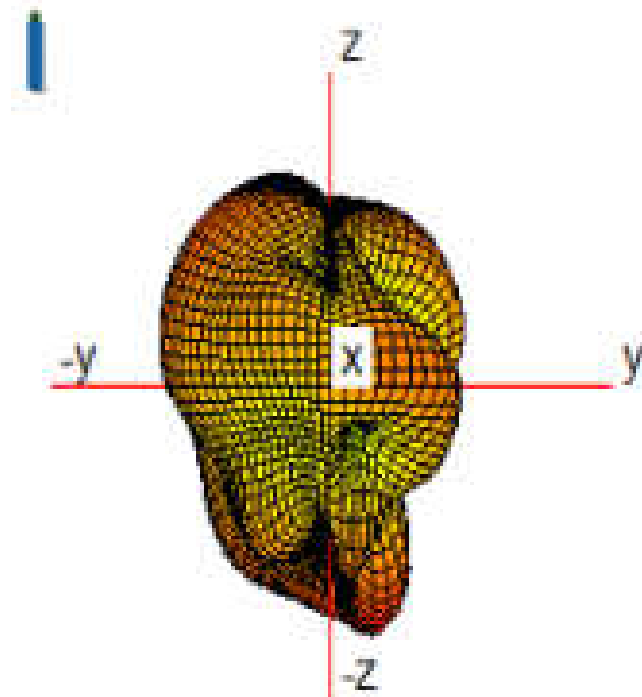

1



**ANT2 WIFI 6E TRx0**

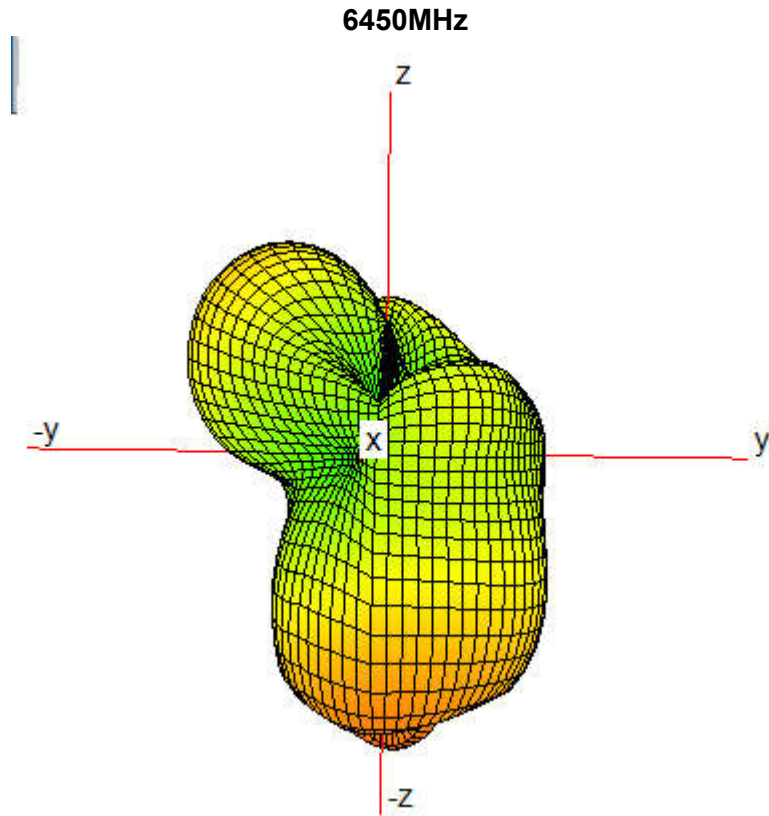

**ANT6 WIFI 2.4G/5G TRx1**

2450MHz

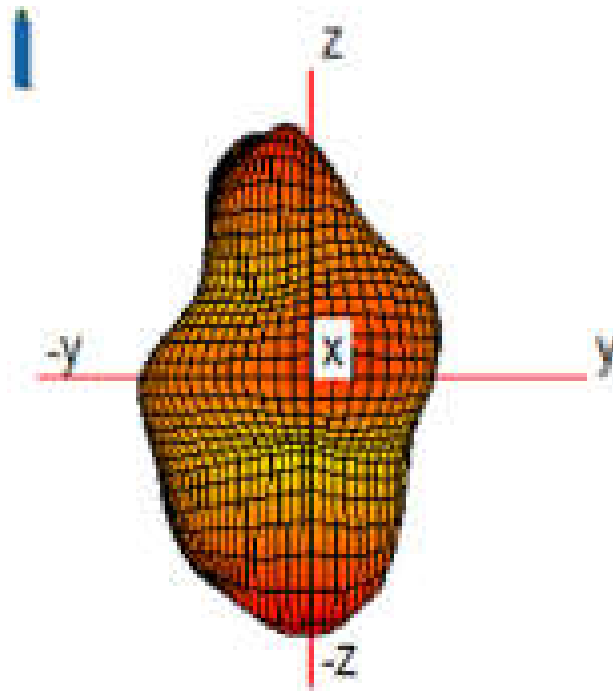

**ANT6 WIFI 5G TRx1**

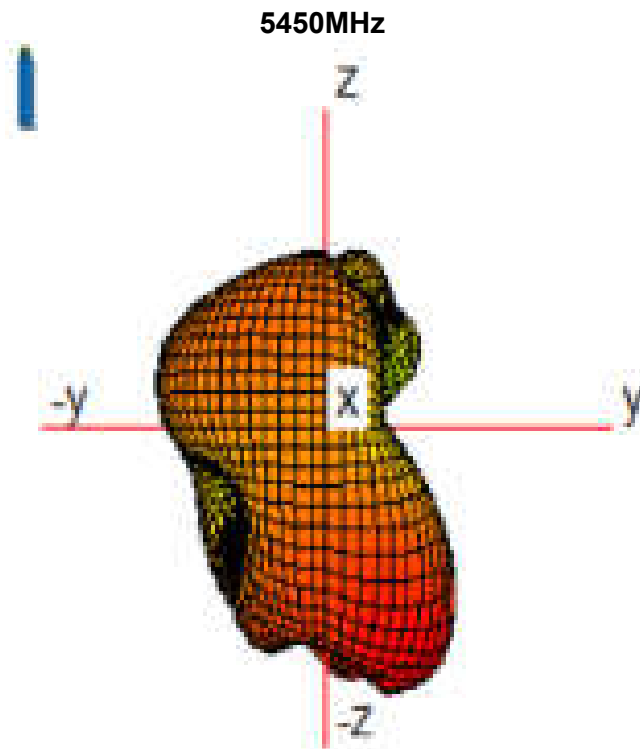

**ANT6 WIFI 6E TRx1**

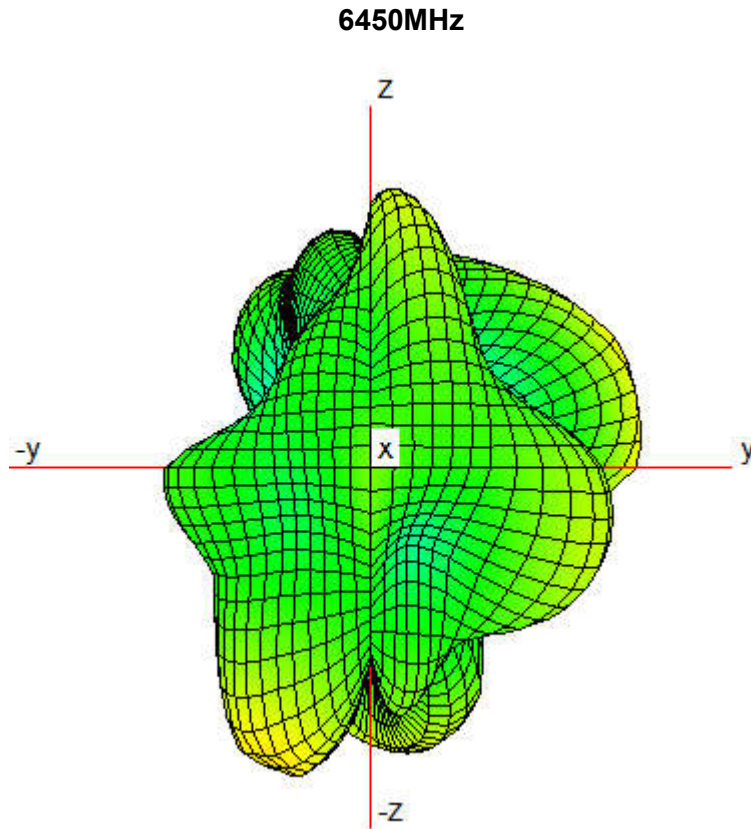

**S**