



# FCC RF Test Report

**APPLICANT** : Motorola Mobility LLC  
**EQUIPMENT** : Mobile Cellular Phone  
**BRAND NAME** : Motorola  
**MODEL NAME** : XT2241-2  
**FCC ID** : IHDT56AF6  
**STANDARD** : 47 CFR Part 2, Part 27 Subpart Q  
**CLASSIFICATION** : PCS Licensed Transmitter Held to Ear (PCE)  
**TEST DATE(S)** : Jun. 19, 2021 ~ Jun. 26, 2021

We, Sporton International Inc. (Kunshan), would like to declare that the tested sample has been evaluated in accordance with the procedures given in ANSI C63.26-2015 and shown compliance with the applicable technical standards.

The test results in this report apply exclusively to the tested model / sample. Without written approval of Sporton International Inc. (Kunshan), the test report shall not be reproduced except in full.

Jason Jia

Approved by: Jason Jia



**Sporton International Inc. (Kunshan)**

**No. 1098, Pengxi North Road, Kunshan Economic Development Zone Jiangsu Province 215300  
People's Republic of China**



TABLE OF CONTENTS

REVISION HISTORY..... 3
SUMMARY OF TEST RESULT ..... 4
1 GENERAL DESCRIPTION ..... 5
1.1 Applicant ..... 5
1.2 Manufacturer ..... 5
1.3 Product Feature of Equipment Under Test ..... 5
1.4 Product Specification of Equipment Under Test ..... 5
1.5 Modification of EUT ..... 5
1.6 Specification of Accessory ..... 6
1.7 Maximum EIRP Power and Emission Designator ..... 6
1.8 Testing Site ..... 6
1.9 Test Software ..... 7
1.10 Applied Standards ..... 7
2 TEST CONFIGURATION OF EQUIPMENT UNDER TEST ..... 8
2.1 Test Mode ..... 8
2.2 Connection Diagram of Test System ..... 9
2.3 Support Unit used in test configuration and system ..... 9
2.4 Measurement Results Explanation Example ..... 9
2.5 Frequency List of Low/Middle/High Channels ..... 10
3 CONDUCTED TEST ITEMS ..... 11
3.1 Measuring Instruments ..... 11
3.2 Test Setup ..... 11
3.3 Test Result of Conducted Test ..... 11
3.4 Conducted Output Power Measurement ..... 12
3.5 Peak-to-Average Ratio ..... 13
3.6 EIRP ..... 14
3.7 Occupied Bandwidth ..... 15
3.8 Conducted Band Edge Measurement ..... 16
3.9 Conducted Spurious Emission Measurement ..... 17
3.10 Frequency Stability Measurement ..... 18
4 RADIATED TEST ITEMS ..... 19
4.1 Measuring Instruments ..... 19
4.2 Test Setup ..... 19
4.3 Test Result of Radiated Test ..... 20
4.4 Radiated Spurious Emission Measurement ..... 21
5 LIST OF MEASURING EQUIPMENT ..... 22
6 UNCERTAINTY OF EVALUATION ..... 23
APPENDIX A. TEST RESULTS OF CONDUCTED TEST
APPENDIX B. TEST RESULTS OF RADIATED TEST
APPENDIX C. TEST SETUP PHOTOGRAPHS



### REVISION HISTORY

REPORT NO.	VERSION	DESCRIPTION	ISSUED DATE
FG252601E	Rev. 01	Initial issue of report	Jul. 11, 2022



### SUMMARY OF TEST RESULT

Report Section	FCC Rule	Description	Limit	Result	Remark
3.4	§2.1046	Conducted Output Power	—	Report Only	-
3.5	§27.50 (k)(4)	Peak-to-Average Ratio	<13dB	PASS	
3.6	§27.50 (k)(3)	EIRP	EIRP < 1W (30dBm)	PASS	-
3.7	§2.1049	Occupied Bandwidth	—	Report Only	-
3.8	§2.1051 §27.53 (n)(2)	Conducted Band Edge Measurement	-13dBm/MHz	PASS	-
3.9	§2.1051 §27.53 (n)(2)	Conducted Spurious Emission	-13dBm/MHz	PASS	-
3.10	§2.1055 §27.54	Frequency Stability Temperature & Voltage	Within the band	PASS	-
4.4	§2.1053 §27.53 (n)(2)	Radiated Spurious Emission	-13dBm/MHz	PASS	Under limit 24.15 dB at 17454.00 MHz

**Declaration of Conformity:**  
The test results with all measurement uncertainty excluded are presented in accordance with the regulation limits or requirements declared by manufacturers.

**Comments and Explanations:**  
The declared of product specification for EUT presented in the report are provided by the manufacturer, and the manufacturer takes all the responsibilities for the accuracy of product specification.



# 1 General Description

## 1.1 Applicant

Motorola Mobility LLC  
222 W, Merchandise Mart Plaza, Chicago IL 60654 USA

## 1.2 Manufacturer

Motorola Mobility LLC  
222 W, Merchandise Mart Plaza, Chicago IL 60654 USA

## 1.3 Product Feature of Equipment Under Test

Product Feature	
Equipment	Mobile Cellular Phone
Brand Name	Motorola
Model Name	XT2241-2
FCC ID	IHDT56AF6
IMEI Code	Conducted: 355222700012736/355222700012744 Radiation: 865911060029545/865911060036540
HW Version	DVT2
SW Version	SSQ32.54
EUT Stage	Identical Prototype

## 1.4 Product Specification of Equipment Under Test

Product Feature	
Tx/Rx Frequency	LTE Band 42: 3450 MHz ~ 3550 MHz
Bandwidth	5MHz / 10MHz / 15MHz / 20MHz
Antenna Type/Gain	Antenna 2: IFA antenna -4.1 dBi
Type of Modulation	QPSK / 16QAM / 64QAM / 256QAM

## 1.5 Modification of EUT

No modifications are made to the EUT during all test items.



### 1.6 Specification of Accessory

Specification of Accessory				
AC Adapter (US)	Brand Name	Motorola (AOHAI)	Model Name	MC-1251
AC Adapter (EU)	Brand Name	Motorola (AOHAI)	Model Name	MC-1252
AC Adapter (UK)	Brand Name	Motorola (AOHAI)	Model Name	MC-1253
AC Adapter (IN)	Brand Name	Motorola (AOHAI)	Model Name	MC-1254
AC Adapter (AU)	Brand Name	Motorola (AOHAI)	Model Name	MC-1255
AC Adapter (AR)	Brand Name	Motorola (AOHAI)	Model Name	MC-1256
AC Adapter (BR)	Brand Name	Motorola (AOHAI)	Model Name	MC-1257
AC Adapter (CHILE)	Brand Name	Motorola (AOHAI)	Model Name	MC-1259
Battery	Brand Name	Motorola(ATL)	Model Name	NF45
Earphone 1	Brand Name	Motorola (Lyand)	Model Name	MD211
Earphone 2	Brand Name	Motorola (LCHSE)	Model Name	MD211
USB Cable 1	Brand Name	Motorola(Saibao)	Model Name	SC18D58980
Wireless Charging dock	Marketing Name	TurboPower 50W Wireless Charging Stand	Model Name	MW-02(TBD)

### 1.7 Maximum EIRP Power and Emission Designator

LTE Band 42		QPSK		16QAM/64QAM/256QAM	
BW (MHz)	Frequency Range (MHz)	Maximum EIRP(W)	Emission Designator (99%OBW)	Maximum EIRP(W)	Emission Designator (99%OBW)
20	3460 ~ 3540	0.0569	17M9G7D	0.0555	17M9W7D

### 1.8 Testing Site

Sporton International Inc. (Kunshan) is accredited to ISO/IEC 17025:2017 by American Association for Laboratory Accreditation with Certificate Number 5145.02.

Test Firm	Sporton International Inc. (Kunshan)		
Test Site Location	No. 1098, Pengxi North Road, Kunshan Economic Development Zone Jiangsu Province 215300 People's Republic of China TEL : +86-512-57900158 FAX : +86-512-57900958		
Test Site No.	Sporton Site No.	FCC Designation No.	FCC Test Firm Registration No.
	03CH04-KS TH01-KS	CN1257	314309



### 1.9 Test Software

Item	Site	Manufacturer	Name	Version
1.	03CH04-KS	AUDIX	E3	6.2009-8-24a

### 1.10 Applied Standards

According to the specifications of the manufacturer, the EUT must comply with the requirements of the following standards:

- ♦ 47 CFR Part 2, Part 27 Subpart Q
- ♦ ANSI C63.26-2015
- ♦ FCC KDB 971168 Power Meas License Digital Systems D01 v03r01
- ♦ FCC KDB 412172 D01 Determining ERP and EIRP v01r01
- ♦

**Remark:**

1. All test items were verified and recorded according to the standards and without any deviation during the test.
2. This EUT has also been tested and complied with the requirements of FCC Part 15, Subpart B, recorded in a separate test report.



## 2 Test Configuration of Equipment Under Test

### 2.1 Test Mode

Antenna port conducted and radiated test items listed below are performed according to KDB 971168 D01 Power Meas. License Digital Systems v03r01 with maximum output power.

Radiated measurements are performed by rotating the EUT in three different orthogonal test planes to find the maximum emission.

Test Cases	Band	Bandwidth (MHz)	Modulation	RB #	Test Channel
		5M, 10M, 15M, 20M	QPSK, 16QAM, 64QAM, 256QAM	1RB, Partial RB, Full RB	L/M/H
Max. Output Power	LTE Band 42	5M, 10M, 15M, 20M	QPSK, 16QAM, 64QAM, 256QAM	1RB, Full RB	L, M, H
Peak-to-Average Ratio	LTE Band 42	20M	QPSK, 16QAM, 64QAM, 256QAM	Full RB	M
E.I.R.P	LTE Band 42	5M, 10M, 15M, 20M	QPSK, 16QAM, 64QAM, 256QAM	1RB, Full RB	L, M, H
26dB and 99% Bandwidth	LTE Band 42	20M	QPSK, 16QAM	Full RB	M
Conducted Band Edge	LTE Band 42	5M, 10M, 15M, 20M	QPSK, 16QAM, 64QAM, 256QAM	1RB, Full RB	L, H
Conducted Spurious Emission	LTE Band 42	5M, 10M, 15M, 20M	QPSK	1RB	L, M, H
Frequency Stability	LTE Band 42	20M	QPSK	1RB	M
Radiated Spurious Emission	LTE Band 42	Worst case			M

**Note:**

The device is investigated from 30MHz to 10 times of fundamental signal for radiated spurious emission test under different RB size/offset and modulations in exploratory test. Subsequently, only the worst case emissions are reported.



## 2.2 Connection Diagram of Test System

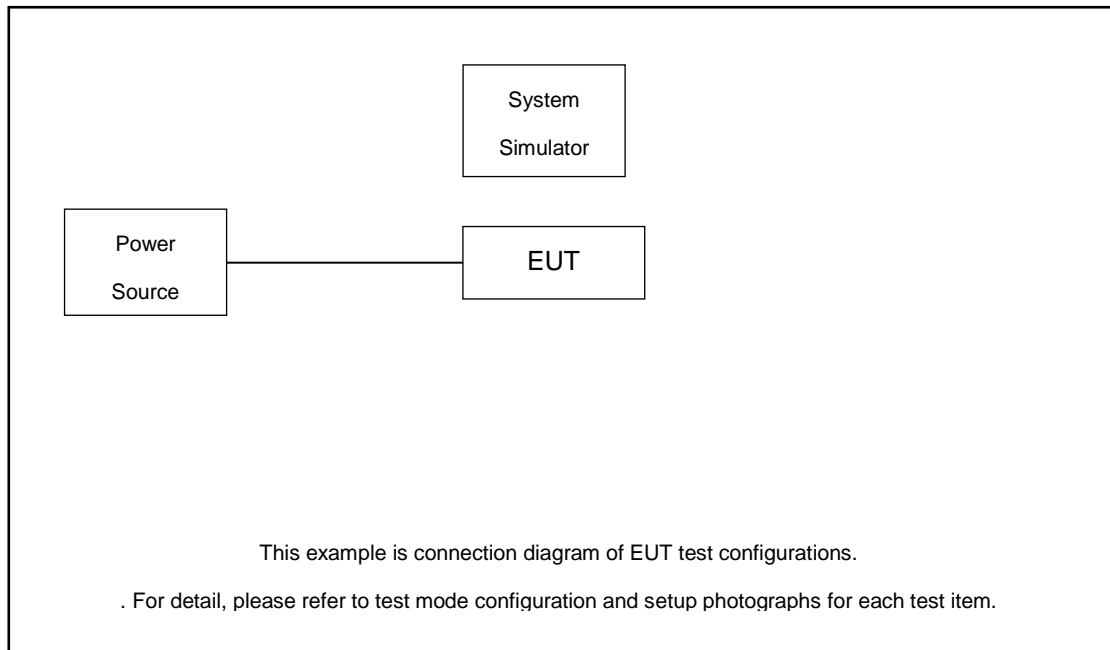

## 2.3 Support Unit used in test configuration and system

Item	Equipment	Trade Name	Model No.	FCC ID	Data Cable	Power Cord
1.	Power Supply	GWINSTEK	PSS-2002	N/A	N/A	Unshielded, 1.8 m
2.	LTE Base Station	Anritsu	MT8820C	N/A	N/A	Unshielded, 1.8 m

## 2.4 Measurement Results Explanation Example

### For all conducted test items:

The offset level is set in the spectrum analyzer to compensate the RF cable loss between EUT conducted output port and spectrum analyzer. With the offset compensation, the spectrum analyzer reading level is exactly the EUT RF output level.

The spectrum analyzer offset is derived from RF cable loss.

*Offset = RF cable loss.*

Following shows an offset computation example with cable loss 8.72dB.

Example :

*Offset(dB) = RF cable loss(dB).*

*= 8.72 (dB)*



## 2.5 Frequency List of Low/Middle/High Channels

LTE Band 42 Channel and Frequency List				
BW [MHz]	Channel/Frequency(MHz)	Lowest	Middle	Highest
20	Channel	42190	42590	42990
	Frequency	3460	3500	3540
15	Channel	42165	42590	43015
	Frequency	3457.5	3500	3542.5
10	Channel	42140	42590	43040
	Frequency	3455	3500	3545
5	Channel	42115	42590	43065
	Frequency	3452.5	3500	3547.5

### 3 Conducted Test Items

#### 3.1 Measuring Instruments

See list of measuring instruments of this test report.

#### 3.2 Test Setup

##### 3.2.1 Conducted Output Power

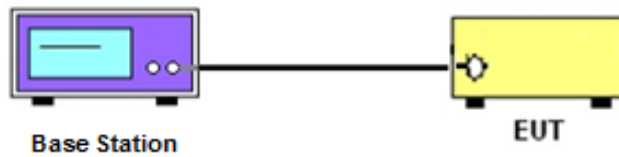

##### 3.2.2 Peak-to-Average Ratio, Occupied / 26dB Bandwidth ,Band-Edge and Conducted Spurious Emission

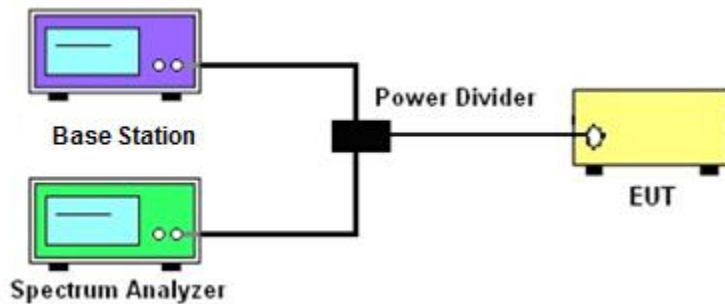

##### 3.2.3 Frequency Stability

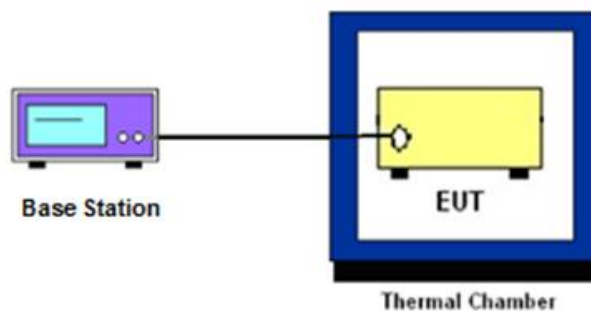

### 3.3 Test Result of Conducted Test

Please refer to Appendix A.



## **3.4 Conducted Output Power Measurement**

### **3.4.1 Description of the Conducted Output Power Measurement**

A base station simulator was used to establish communication with the EUT. Its parameters were set to transmit the maximum power on the EUT. The measured power in the radio frequency on the transmitter output terminals shall be reported.

### **3.4.2 Test Procedures**

1. The testing follows ANSI C63.26 Section 5.2
2. The transmitter output port was connected to the system simulator.
3. Set EUT at maximum power through the system simulator.
4. Select lowest, middle, and highest channels for each band and different modulation.
5. Measure and record the power level from the system simulator.



## **3.5 Peak-to-Average Ratio**

### **3.5.1 Description of the PAR Measurement**

Power Complementary Cumulative Distribution Function (CCDF) curves provide a means for characterizing the power peaks of a digitally modulated signal on a statistical basis. A CCDF curve depicts the probability of the peak signal amplitude exceeding the average power level. Most contemporary measurement instrumentation include the capability to produce CCDF curves for an input signal provided that the instrument's resolution bandwidth can be set wide enough to accommodate the entire input signal bandwidth. In measuring transmissions in this band using an average power technique, the peak-to-average ratio (PAR) of the transmission may not exceed 13 dB.

### **3.5.2 Test Procedures**

1. The testing follows ANSI C63.26 Section 5.2.3.4 (CCDF).
2. The EUT was connected to spectrum and system simulator via a power divider.
3. Set the CCDF (Complementary Cumulative Distribution Function) option in spectrum analyzer.
4. The highest RF powers were measured and recorded the maximum PAPR level associated with a probability of 0.1 %.
5. Record the deviation as Peak to Average Ratio.



## 3.6 EIRP

### 3.6.1 Description of EIRP Limit

#### § 27.50 (k)(3)

Mobile devices are limited to 1Watt (30 dBm) EIRP. Mobile devices operating in these bands must employ a means for limiting power to the minimum necessary for successful communications

### 3.6.2 Test Procedures

1. According to KDB 412172 D01 Power Approach,
2.  $EIRP = P_T + G_T - L_C$ ,  $ERP = EIRP - 2.15$ , where  
 $P_T$  = transmitter output power in dBm  
 $G_T$  = gain of the transmitting antenna in dBi  
 $L_C$  = signal attenuation in the connecting cable between the transmitter and antenna in dB



### 3.7 Occupied Bandwidth

#### 3.7.1 Description of Occupied Bandwidth Measurement

The occupied bandwidth is the width of a frequency band such that, below the lower and above the upper frequency limits, the mean powers emitted are each equal to a specified percentage 0.5% of the total mean transmitted power.

The 26 dB emission bandwidth is defined as the frequency range between two points, one above and one below the carrier frequency, at which the spectral density of the emission is attenuated 26 dB below the maximum in-band spectral density of the modulated signal. Spectral density (power per unit bandwidth) is to be measured with a detector of resolution bandwidth equal to approximately 1.0% of the emission bandwidth.

#### 3.7.2 Test Procedures

1. The testing follows ANSI C63.26 Section 5.4
2. The EUT was connected to spectrum analyzer and system simulator via a power divider.
3. The spectrum analyzer center frequency is set to the nominal EUT channel center frequency. The span range for the spectrum analyzer shall be between two and five times the anticipated OBW.
4. The nominal resolution bandwidth (RBW) shall be in the range of 1 to 5 % of the anticipated OBW, and the VBW shall be at least 3 times the RBW.
5. Set the detection mode to peak, and the trace mode to max hold.
6. Determine the reference value: Set the EUT to transmit a modulated signal. Allow the trace to stabilize. Set the spectrum analyzer marker to the highest level of the displayed trace.  
(this is the reference value)
7. Determine the “-26 dB down amplitude” as equal to (Reference Value – X).
8. Place two markers, one at the lowest and the other at the highest frequency of the envelope of the spectral display such that each marker is at or slightly below the “-X dB down amplitude” determined in step 6. If a marker is below this “-X dB down amplitude” value it shall be placed as close as possible to this value. The OBW is the positive frequency difference between the two markers.
9. Use the 99 % power bandwidth function of the spectrum analyzer and report the measured bandwidth.



## 3.8 Conducted Band Edge Measurement

### 3.8.1 Description of Conducted Band Edge Measurement

#### § 27.53 (n)(2)

For mobile operations in the 3450-3550 MHz band, the conducted power of any emission outside the licensee's authorized bandwidth shall not exceed  $-13$  dBm/MHz.

Compliance with this paragraph is based on the use of measurement instrumentation employing a resolution bandwidth of 1 megahertz or greater. However, in the 1 megahertz bands immediately outside and adjacent to the licensee's frequency block, a resolution bandwidth of at least one percent of the emission bandwidth of the fundamental emission of the transmitter may be employed, but limited to a maximum of 200 kHz. In the bands between 1 and 5 MHz removed from the licensee's frequency block, the minimum resolution bandwidth for the measurement shall be 500 kHz.

### 3.8.2 Test Procedures

1. The testing follows ANSI C63.26 section 5.7
2. The EUT was connected to spectrum analyzer and system simulator via a power divider.
3. The band edges of low and high channels for the highest RF powers were measured.
4. Set RBW  $\geq$  1% EBW but limited to a maximum of 200 kHz in the 1MHz band immediately outside and adjacent to the band edge.
5. Beyond the 1 MHz and 5 MHz removed from the band edge, set RBW  $\geq$  500KHz.
6. Beyond the 5 MHz removed from the band edge, set RBW = 1MHz.
7. Set spectrum analyzer with RMS detector.
8. The RF fundamental frequency should be excluded against the limit line in the operating frequency band.
9. Checked that all the results comply with the emission limit line.





## 3.9 Conducted Spurious Emission Measurement

### 3.9.1 Description of Conducted Spurious Emission Measurement

The power of any emission outside of the authorized operating frequency ranges shall not exceed  $-13$  dBm/MHz.

It is measured by means of a calibrated spectrum analyzer and scanned from 9 kHz up to a frequency including its 10<sup>th</sup> harmonic.

### 3.9.2 Test Procedures

1. The testing follows ANSI C63.26 section 5.7
2. The EUT was connected to spectrum analyzer and system simulator via a power divider.
3. The RF output of EUT was connected to the spectrum analyzer by RF cable and attenuator.  
The path loss was compensated to the results for each measurement.
4. The middle channel for the highest RF power within the transmitting frequency was measured.
5. The conducted spurious emission for the whole frequency range was taken.
6. Make the measurement with the spectrum analyzer's RBW = 1MHz, VBW = 3MHz.
7. Set spectrum analyzer with RMS detector.
8. Taking the record of maximum spurious emission.
9. The RF fundamental frequency should be excluded against the limit line in the operating frequency band.
10. Checked that all the results comply with the emission limit line.



## 3.10 Frequency Stability Measurement

### 3.10.1 Description of Frequency Stability Measurement

The frequency stability shall be measured by variation of ambient temperature and variation of primary supply voltage to ensure that the fundamental emission stays within the authorized frequency block.

### 3.10.2 Test Procedures for Temperature Variation

1. The testing follows ANSI C63.26 section 5.6.4
2. The EUT was set up in the thermal chamber and connected with the system simulator.
3. With power OFF, the temperature was decreased to  $-30^{\circ}\text{C}$  and the EUT was stabilized before testing. Power was applied and the maximum change in frequency was recorded within one minute.
4. With power OFF, the temperature was raised in  $10^{\circ}\text{C}$  step up to  $50^{\circ}\text{C}$ . The EUT was stabilized at each step for at least half an hour. Power was applied and the maximum frequency change was recorded within one minute.

### 3.10.3 Test Procedures for Voltage Variation

1. The testing follows ANSI C63.26 section 5.6.5.
2. The EUT was placed in a temperature chamber at  $20\pm 5^{\circ}\text{C}$  and connected with the system simulator.
3. The power supply voltage to the EUT was varied from 85% to 115% of the nominal value for other than hand carried battery equipment.
4. For hand carried, battery powered equipment, reduce the primary ac or dc supply voltage to the battery operating end point, which shall be specified by the manufacturer.
5. The variation in frequency was measured for the worst case.

## 4 Radiated Test Items

### 4.1 Measuring Instruments

See list of measuring instruments of this test report.

### 4.2 Test Setup

#### 4.2.1 For radiated test below 30MHz

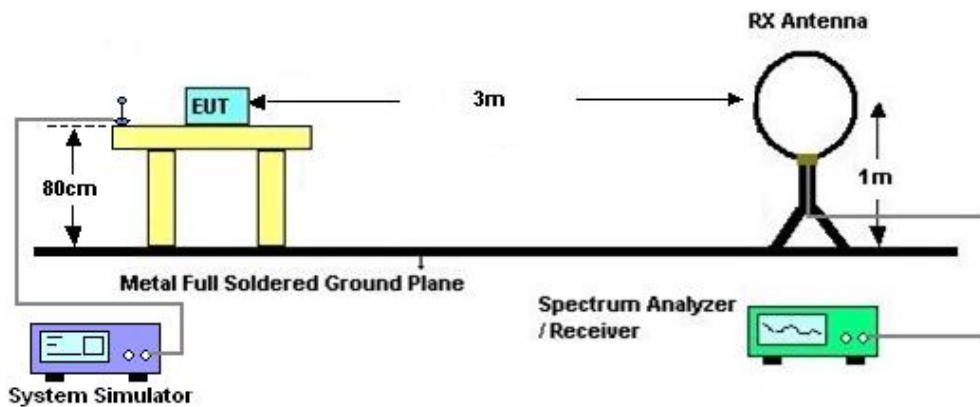

#### 4.2.2 For radiated test from 30MHz to 1GHz

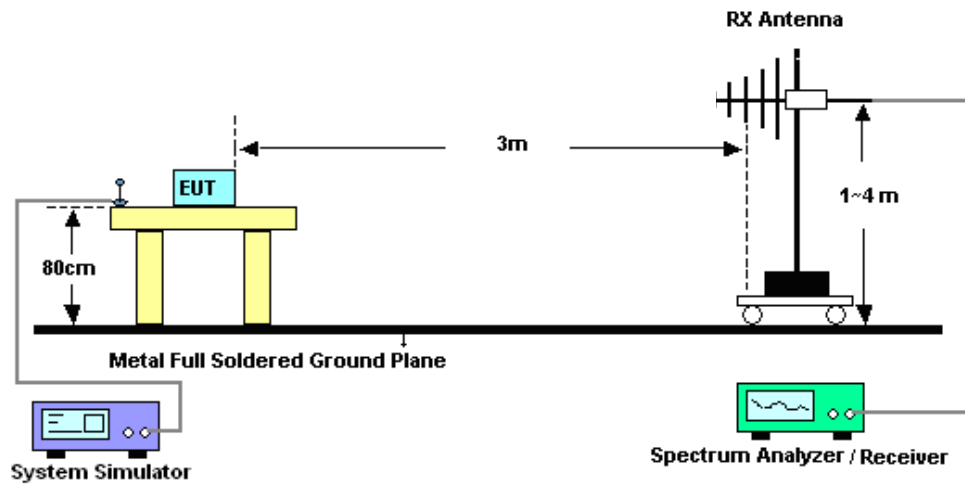

#### 4.2.3 For radiated test above 1GHz

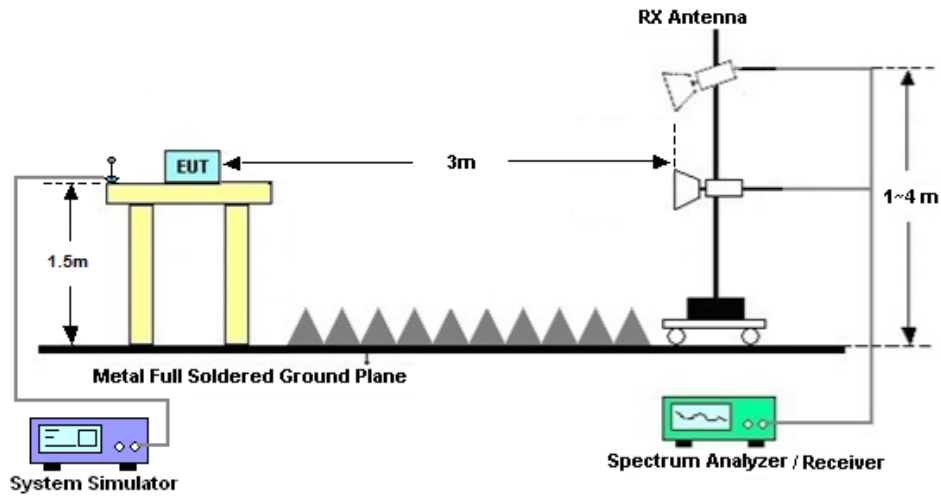

#### 4.3 Test Result of Radiated Test

The low frequency, which started from 9 kHz to 30MHz, was pre-scanned and the result which was 20dB lower than the limit line was not reported.

Please refer to Appendix B.



## 4.4 Radiated Spurious Emission Measurement

### 4.4.1 Description of Radiated Spurious Emission

The radiated spurious emission was measured by substitution method according to ANSI/TIA-603-E. The power of any emission outside of the authorized operating frequency ranges shall not exceed -13 dBm/MHz.

The spectrum is scanned from 30 MHz up to a frequency including its 10th harmonic.

### 4.4.2 Test Procedures

1. The testing follows ANSI C63.26 Section 5.5
2. The EUT was placed on a turntable with 0.8 meter height for frequency below 1GHz and 1.5 meter height for frequency above 1GHz respectively above ground.
3. The EUT was set 3 meters from the receiving antenna mounted on the antenna tower.
4. The table was rotated 360 degrees to determine the position of the highest spurious emission.
5. The height of the receiving antenna is varied between 1m to 4m to search the maximum spurious emission for both horizontal and vertical polarizations.
6. During the measurement, the system simulator parameters were set to force the EUT transmitting at maximum output power.
7. Make the measurement with the spectrum analyzer's RBW = 1MHz, VBW = 3MHz, taking the record of maximum spurious emission.
8. A horn antenna was substituted in place of the EUT and was driven by a signal generator.
9. Tune the output power of signal generator to the same emission level with EUT maximum spurious emission.  
$$\text{EIRP (dBm)} = \text{S.G. Power} - \text{Tx Cable Loss} + \text{Tx Antenna Gain}$$
$$\text{ERP (dBm)} = \text{EIRP} - 2.15$$
10. The RF fundamental frequency should be excluded against the limit line in the operating frequency band.



## 5 List of Measuring Equipment

Instrument	Manufacturer	Model No.	Serial No.	Characteristics	Calibration Date	Test Date	Due Date	Remark
Spectrum Analyzer	R&S	FSV40	101040	10Hz~40GHz	Oct. 14, 2021	Jun. 19, 2022~ Jun. 20, 2022	Oct. 13, 2022	Conducted (TH01-KS)
Power divider	STI	STI08-0055	-	0.5~40GHz	Aug. 26, 2021	Jun. 19, 2022~ Jun. 20, 2022	Aug. 25, 2022	Conducted (TH01-KS)
Temperature & humidity chamber	Hongzhan	LP-150U	H201401144 0	-40~+150°C 20%~95%RH	Jul. 12, 2022	Jun. 19, 2022~ Jun. 20, 2022	Jul. 11, 2023	Conducted (TH01-KS)
EXA Spectrum Analyzer	Keysight	N9010B	MY5754107 9	10Hz-44G,MAX 30dB	Oct. 14, 2021	Jun. 26, 2022	Oct. 13, 2022	Radiation (03CH04-KS)
Loop Antenna	R&S	HFH2-Z2	100321	9kHz~30MHz	Oct. 30, 2021	Jun. 26, 2022	Oct. 29, 2022	Radiation (03CH04-KS)
Bilog Antenna	TeseQ	CBL6111D	49922	30MHz-1GHz	May 24, 2022	Jun. 26, 2022	May 23, 2023	Radiation (03CH04-KS)
Horn Antenna	Schwarzbeck	BBHA9120 D	1284	1GHz~18GHz	Jan. 05, 2022	Jun. 26, 2022	Jan. 04, 2023	Radiation (03CH04-KS)
SHF-EHF Horn	Com-power	AH-840	101070	18GHz~40GHz	Jan. 05, 2022	Jun. 26, 2022	Jan. 04, 2023	Radiation (03CH04-KS)
Amplifier	SONOMA	310N	187289	9KHz-1GHz	Jan. 05, 2022	Jun. 26, 2022	Jan. 04, 2023	Radiation (03CH04-KS)
high gain Amplifier	MITEQ	AMF-7D-00 101800-30- 10P	2025788	1Ghz-18Ghz	Jul. 30, 2021	Jun. 26, 2022	Jul. 29, 2022	Radiation (03CH04-KS)
Amplifier	Keysight	83017A	MY5728010 6	500MHz~26.5G Hz	Oct. 13, 2021	Jun. 26, 2022	Oct. 12, 2022	Radiation (03CH04-KS)
Amplifier	MITEQ	EM18G40G GA	060728	18~40GHz	Jan. 05, 2022	Jun. 26, 2022	Jan. 04, 2023	Radiation (03CH04-KS)
AC Power Source	Chroma	61601	F104090004	N/A	NCR	Jun. 26, 2022	NCR	Radiation (03CH04-KS)
Turn Table	ChamPro	EM 1000-T	060762-T	0~360 degree	NCR	Jun. 26, 2022	NCR	Radiation (03CH04-KS)
Antenna Mast	ChamPro	EM 1000-A	060762-A	1 m~4 m	NCR	Jun. 26, 2022	NCR	Radiation (03CH04-KS)

NCR: No Calibration Required



## 6 Uncertainty of Evaluation

The measurement uncertainties shown below were calculated in accordance with the requirements of ANSI 63.26-2015. All the measurement uncertainty value were shown with a coverage K=2 to indicate 95% level of confidence. The measurement data show herein meets or exceeds the CISPR measurement uncertainty values specified in CISPR 16-4-2 and can be compared directly to specified limit to determine compliance.

### Uncertainty of Conducted Measurement

Test Item	Uncertainty
Conducted Power	0.56 dB
Conducted Emissions	0.92 dB
Occupied Channel Bandwidth	0.03 %
Conducted Power Spectral Density	0.54 dB
Conducted emission	0.92
Frequency tolerance	0.414ppm

### Uncertainty of Radiated Emission Measurement (30 MHz ~ 1000 MHz)

Measuring Uncertainty for a Level of Confidence of 95% (U = 2Uc(y))	3.3dB
---	-------

### Uncertainty of Radiated Emission Measurement (1 GHz ~ 18 GHz)

Measuring Uncertainty for a Level of Confidence of 95% (U = 2Uc(y))	2.8dB
---	-------

### Uncertainty of Radiated Emission Measurement (18 GHz ~ 40 GHz)

Measuring Uncertainty for a Level of Confidence of 95% (U = 2Uc(y))	2.8dB
---	-------

----- THE END -----



### Appendix A. Test Results of Conducted Test

#### Conducted Output Power(Average power) and EIRP

BW [MHz]	Modulation	RB Size	RB Offset	Power Low Ch. / Freq.	Power Middle Ch. / Freq.	Power High Ch. / Freq.	EIRP(W)		
Channel				42190	42590	42990	EIRP(W)		
Frequency (MHz)				3460	3500	3540	L	M	H
20	QPSK	1	0	21.45	21.65	21.39	0.0543	0.0569	0.0536
20	QPSK	1	99	21.36	21.49	21.40	0.0532	0.0548	0.0537
20	QPSK	100	0	20.45	20.51	20.45	0.0432	0.0438	0.0432
20	16QAM	1	0	21.35	21.54	21.39	0.0531	0.0555	0.0536
20	64QAM	1	0	21.50	21.49	21.50	0.0550	0.0548	0.0550
20	256QAM	1	0	18.51	18.58	18.52	0.0276	0.0281	0.0277
Channel				42165	42590	43015	EIRP(W)		
Frequency (MHz)				3457.5	3500	3542.5	L	M	H
15	QPSK	1	0	21.51	21.60	21.43	0.0551	0.0562	0.0541
15	16QAM	1	0	21.43	21.33	21.43	0.0541	0.0528	0.0541
Channel				42140	42590	43040	EIRP(W)		
Frequency (MHz)				3455	3500	3545	L	M	H
10	QPSK	1	0	21.53	21.53	21.46	0.0553	0.0553	0.0545
10	16QAM	1	0	21.49	21.45	21.44	0.0548	0.0543	0.0542
Channel				42115	42590	43065	EIRP(W)		
Frequency (MHz)				3452.5	3500	3547.5	L	M	H
5	QPSK	1	0	21.56	21.52	21.45	0.0557	0.0552	0.0543
5	16QAM	1	0	21.50	21.47	21.32	0.0550	0.0546	0.0527

Note: Antenna Gain = GT - LC = -4.1dBi





## LTE Band 42

### Peak-to-Average Ratio

Mode	LTE Band 42 / 20MHz				
Mod.	QPSK	16QAM	64QAM	256QAM	Limit: 13dB
RB Size	Full RB	Full RB	Full RB	Full RB	Result
Middle CH	4.96	6.90	7.04	6.41	<b>PASS</b>

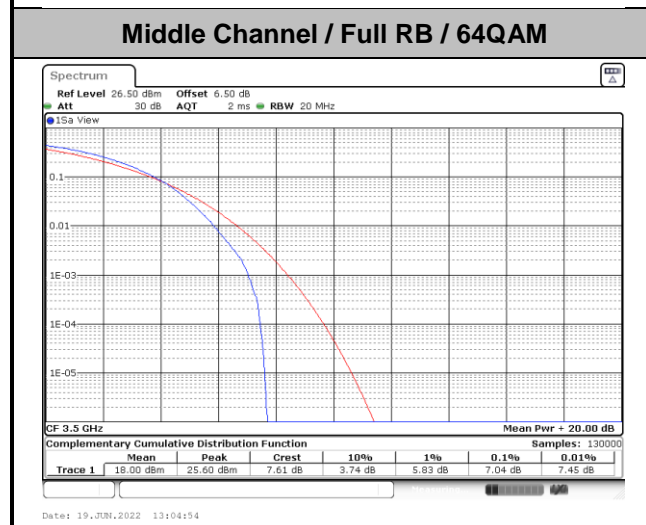
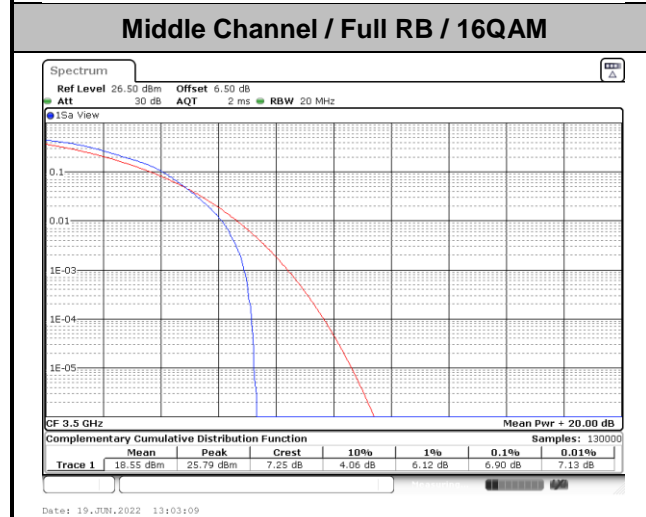
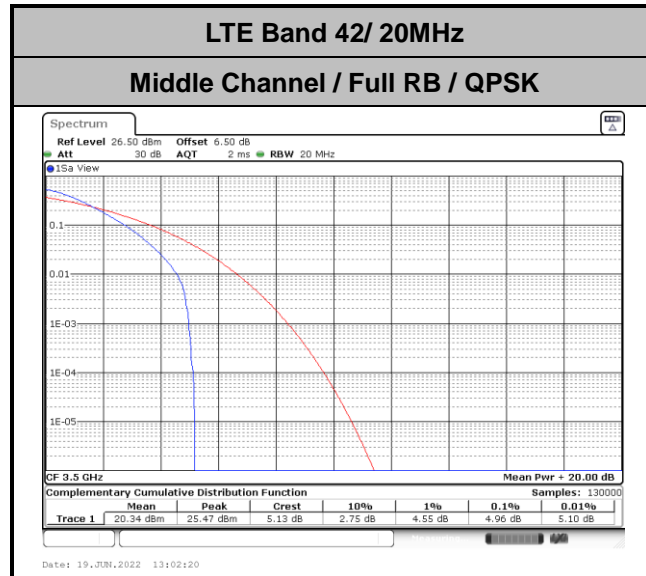

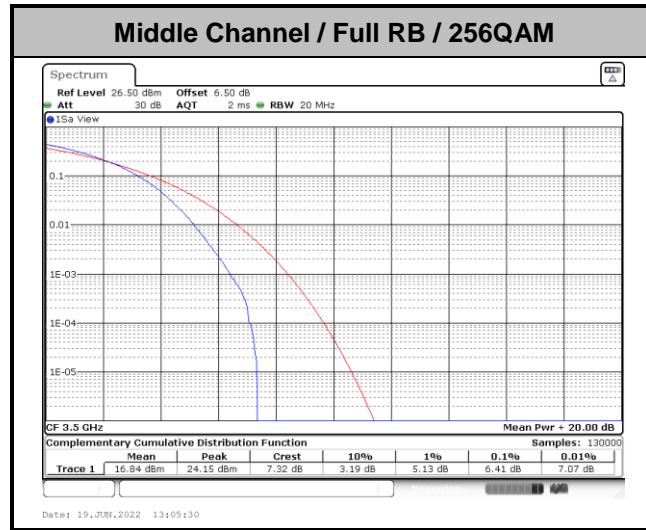



## 26dB Bandwidth

Mode	LTE Band 42 : 26dB BW(MHz)	
BW	20MHz	
Mod.	QPSK	16QAM
Middle CH	18.70	18.74

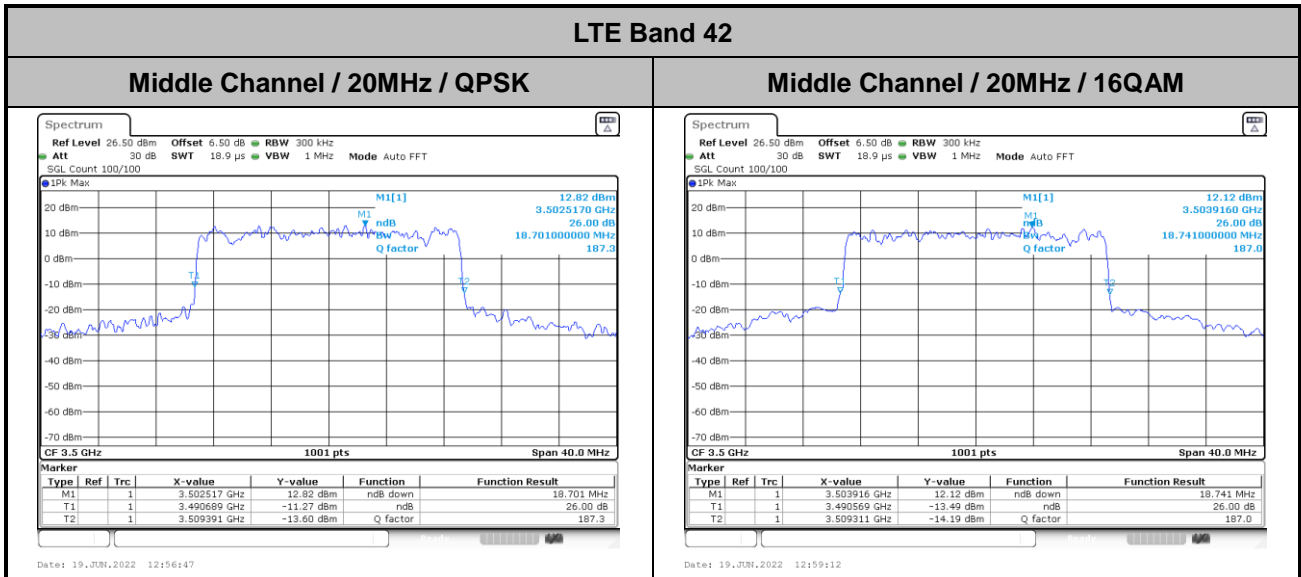



# Occupied Bandwidth

Mode	LTE Band 42 : 99%OBW(MHz)	
BW	20MHz	
Mod.	QPSK	16QAM
Middle CH	17.86	17.86

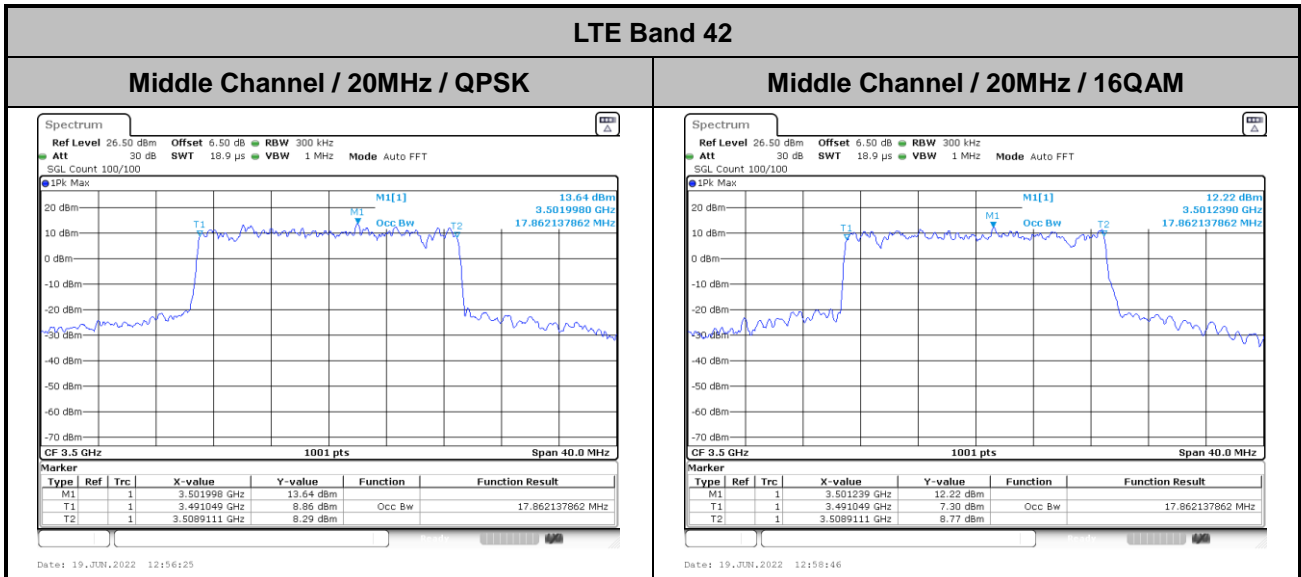



# Conducted Band Edge

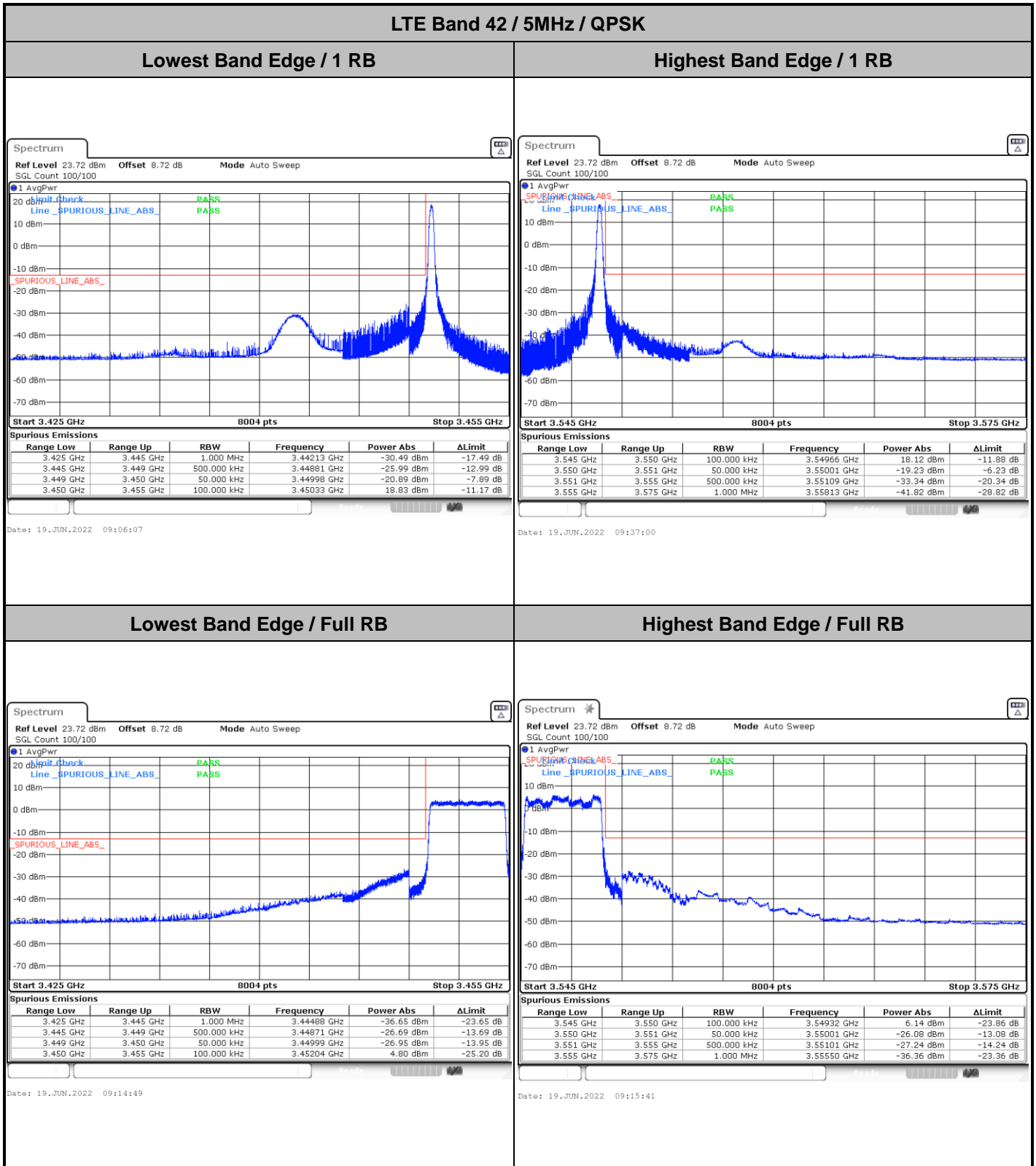



LTE Band 42 / 5MHz / 16QAM

Lowest Band Edge / 1RB

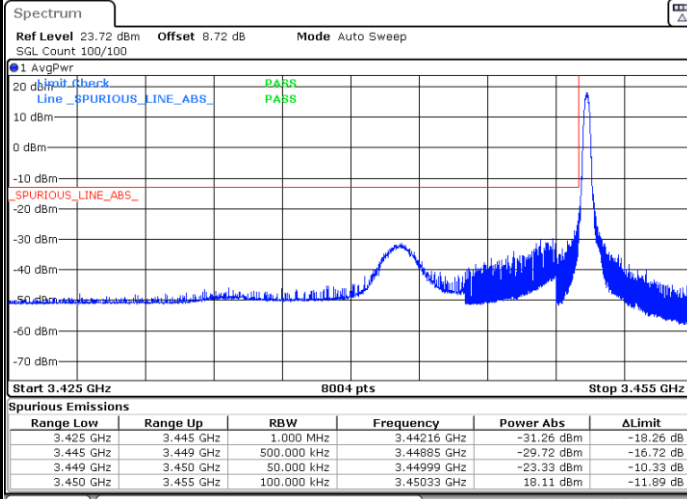

Date: 19 JUN.2022 09:06:49

Highest Band Edge / 1 RB

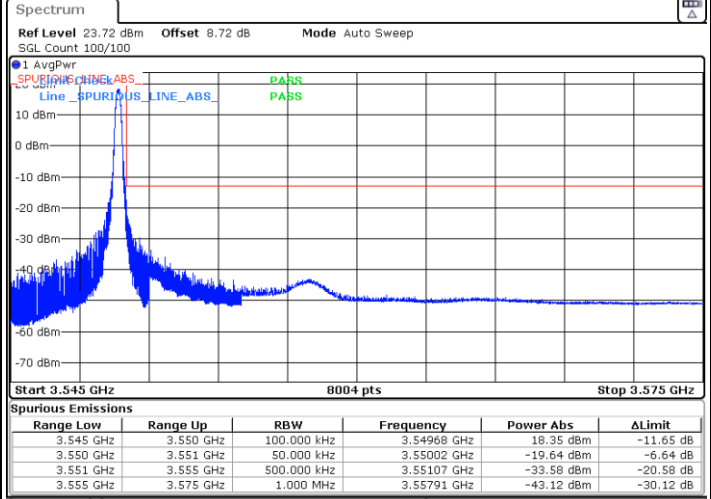

Date: 19 JUN.2022 09:27:25

Lowest Band Edge / Full RB

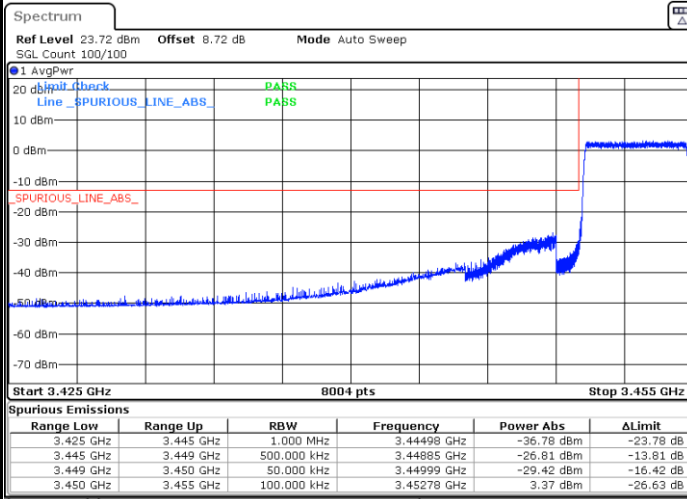

Date: 19 JUN.2022 09:13:26

Highest Band Edge / Full RB

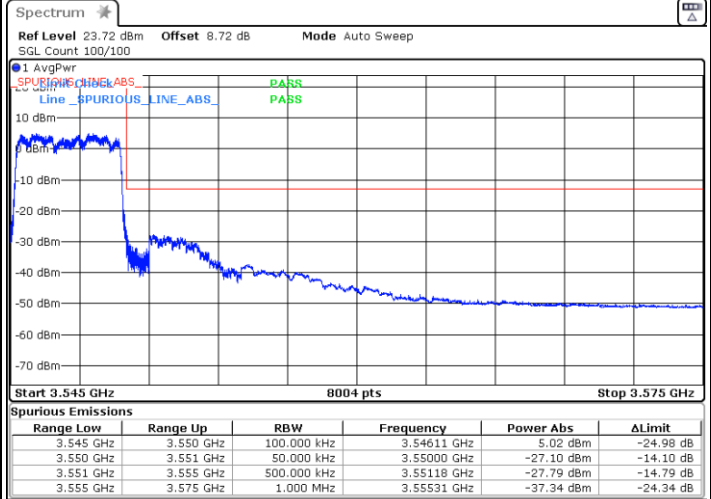

Date: 19 JUN.2022 09:17:17



LTE Band 42 / 5MHz / 64QAM

Lowest Band Edge / 1RB

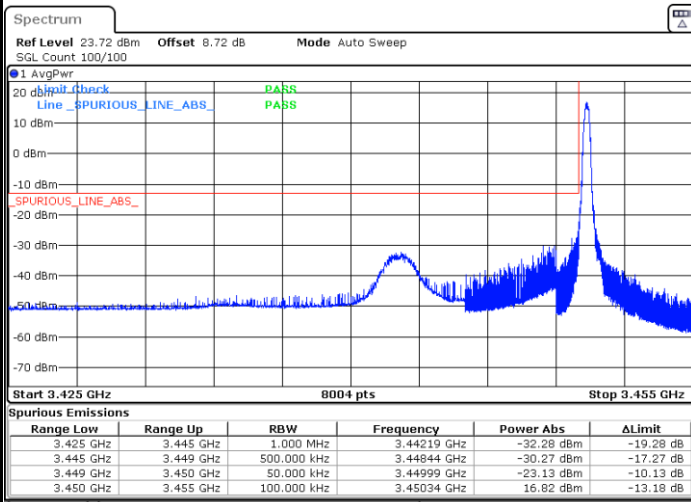

Date: 19 JUN 2022 09:09:15

Highest Band Edge / 1 RB

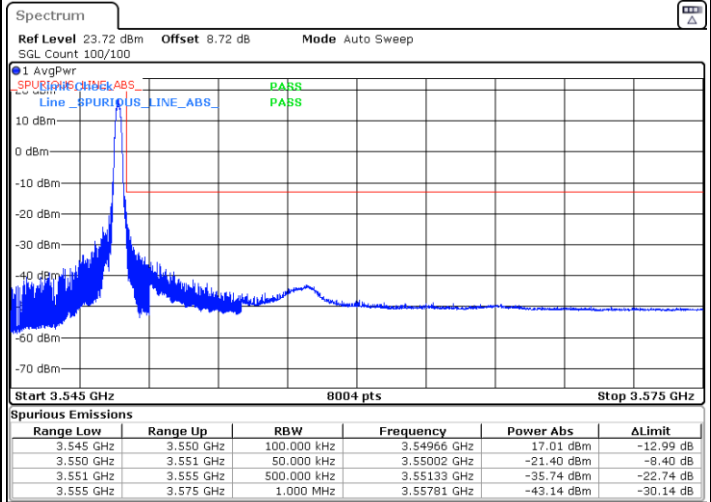

Date: 19 JUN 2022 09:25:55

Lowest Band Edge / Full RB

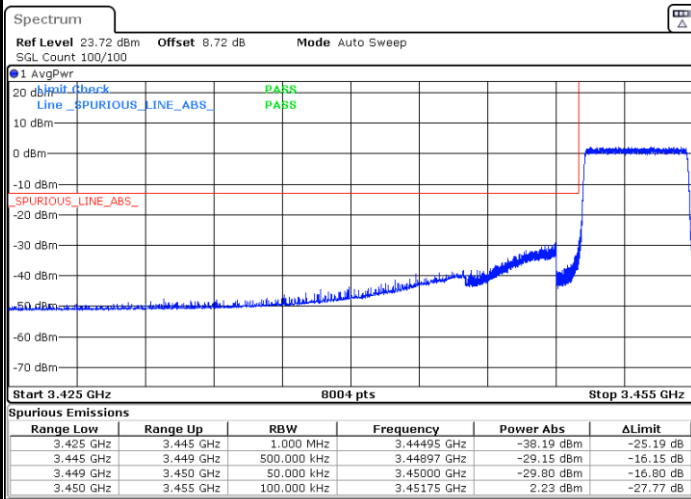

Date: 19 JUN 2022 09:12:17

Highest Band Edge / Full RB

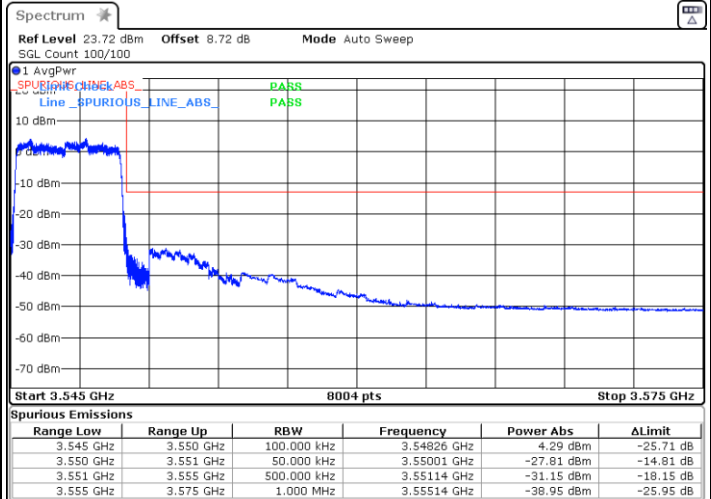

Date: 19 JUN 2022 09:20:53





LTE Band 42 / 5MHz / 256QAM

Lowest Band Edge / 1RB

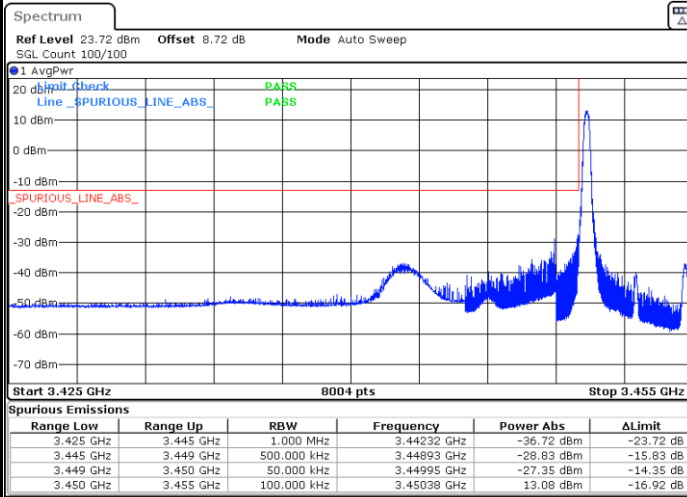

Date: 19 JUN.2022 09:10:35

Highest Band Edge / 1 RB



Date: 19 JUN.2022 09:22:45

Lowest Band Edge / Full RB

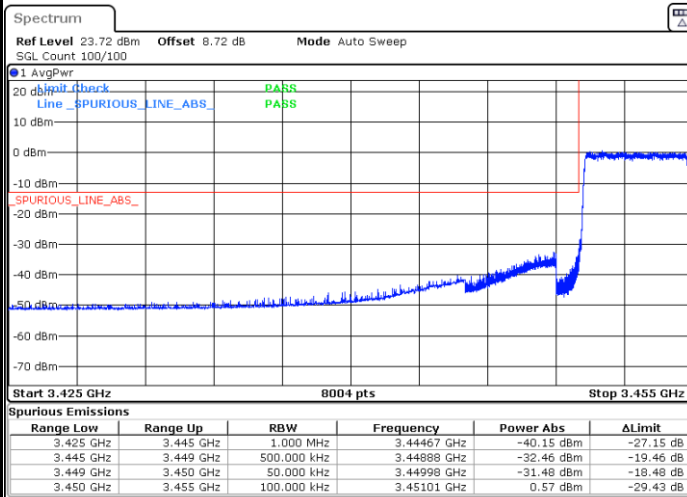

Date: 19 JUN.2022 09:11:31

Highest Band Edge / Full RB

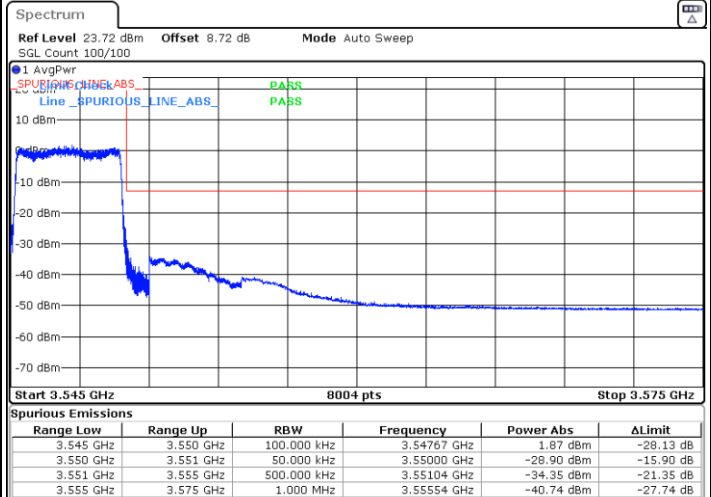

Date: 19 JUN.2022 09:21:41



LTE Band 42 / 10MHz / QPSK

Lowest Band Edge / 1 RB

Highest Band Edge / 1 RB

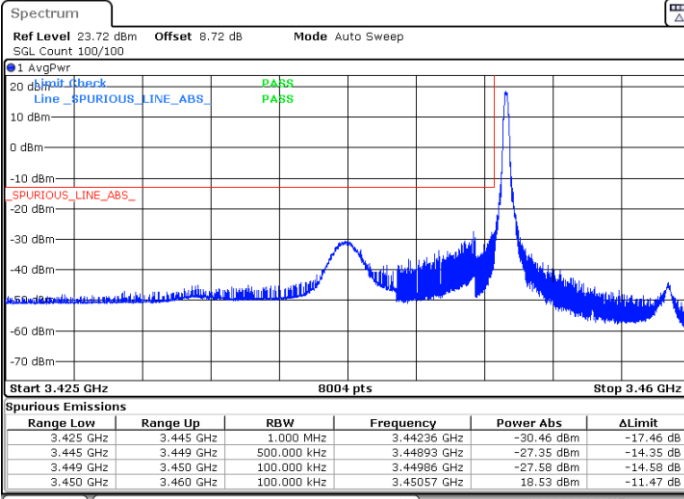

Date: 19 JUN.2022 09:38:28

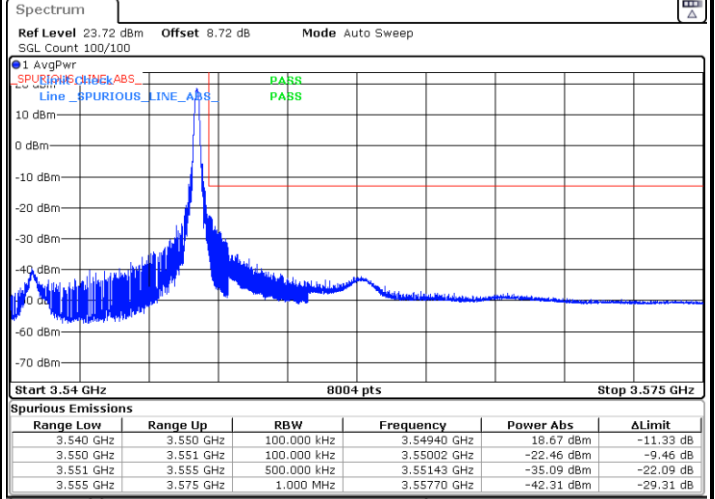

Date: 19 JUN.2022 11:05:53

Lowest Band Edge / Full RB

Highest Band Edge / Full RB

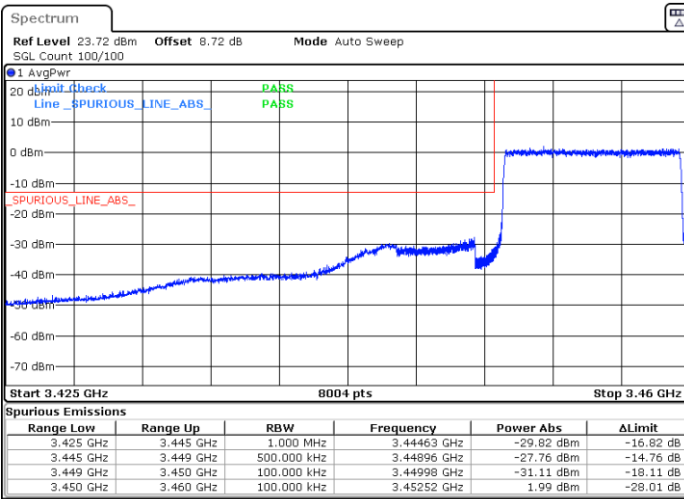

Date: 19 JUN.2022 10:04:46



Date: 19 JUN.2022 10:06:25



LTE Band 42 / 10MHz / 16QAM

Lowest Band Edge / 1 RB

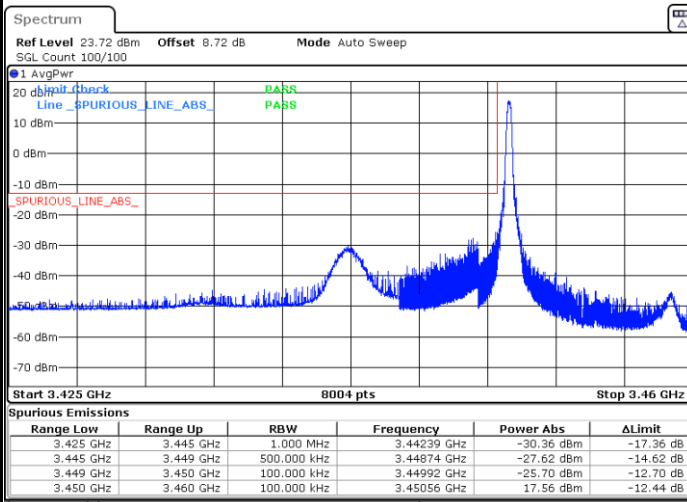

Date: 19 JUN 2022 09:39:13

Highest Band Edge / 1 RB

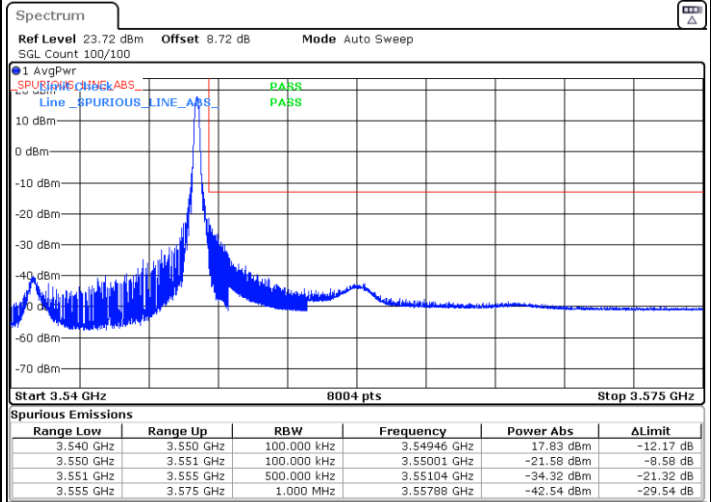

Date: 19 JUN 2022 11:03:51

Lowest Band Edge / Full RB

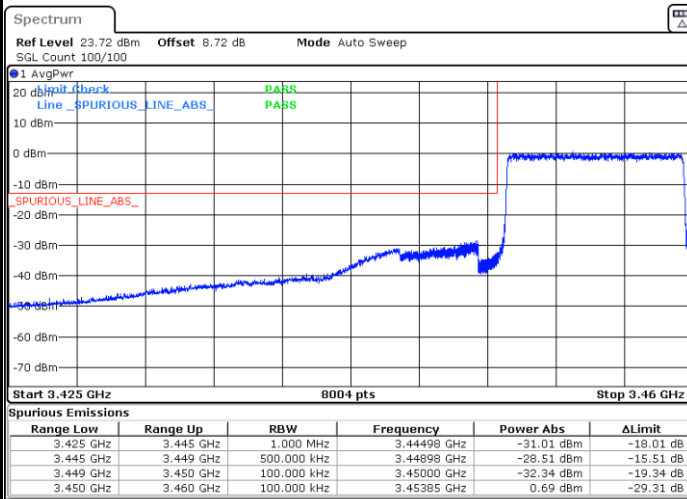

Date: 19 JUN 2022 10:02:11

Highest Band Edge / Full RB

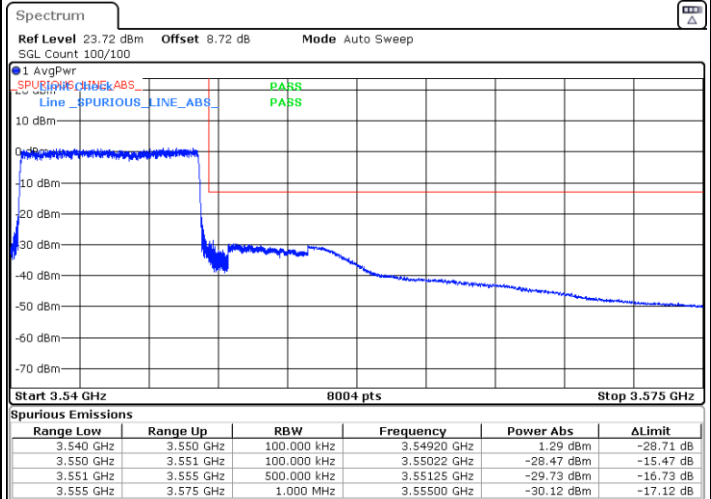

Date: 19 JUN 2022 10:19:17



LTE Band 42 / 10MHz / 64QAM

Lowest Band Edge / 1 RB

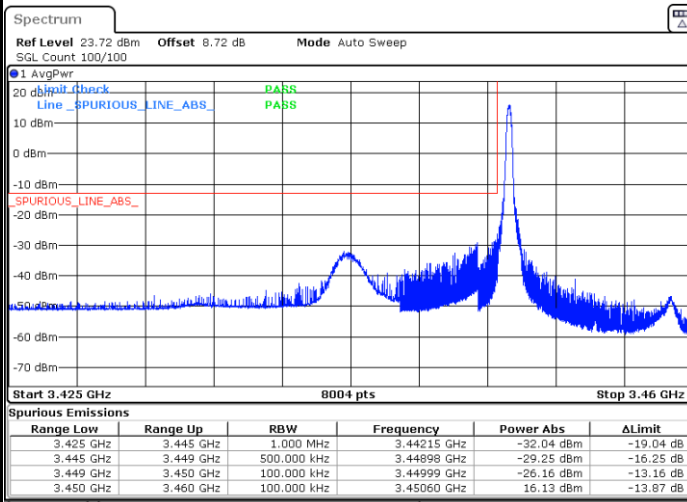

Date: 19 JUN.2022 09:43:40

Highest Band Edge / 1 RB

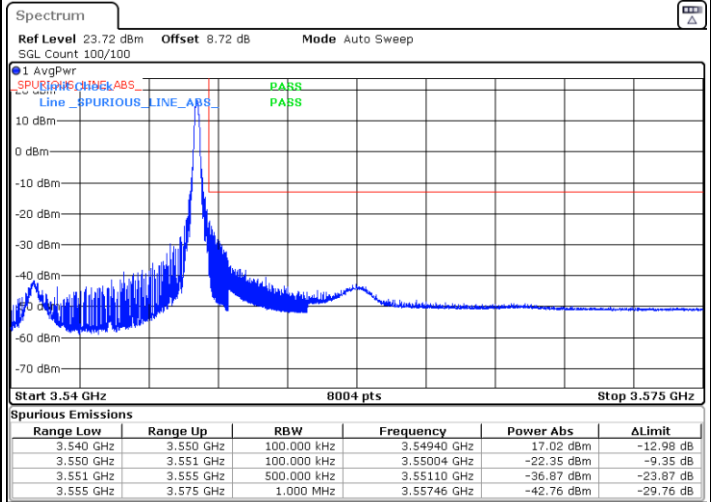

Date: 19 JUN.2022 10:42:14

Lowest Band Edge / Full RB

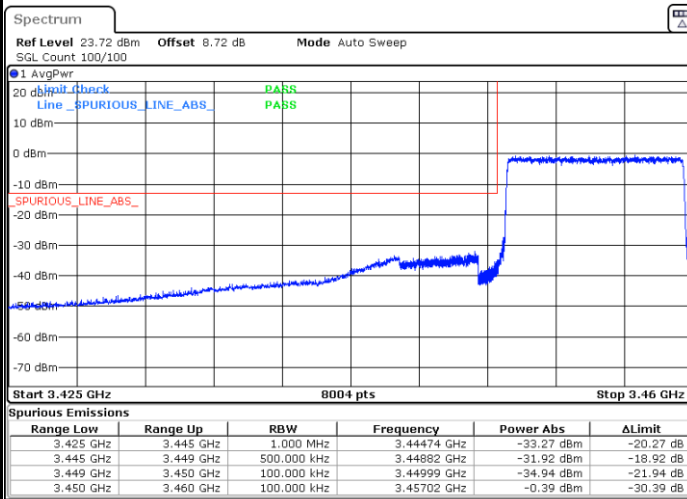

Date: 19 JUN.2022 09:53:54

Highest Band Edge / Full RB

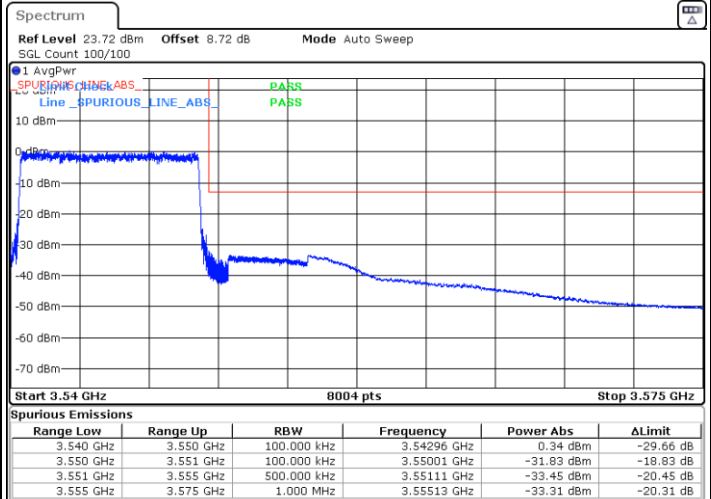

Date: 19 JUN.2022 10:21:43



LTE Band 42 / 10MHz / 256QAM

Lowest Band Edge / 1 RB

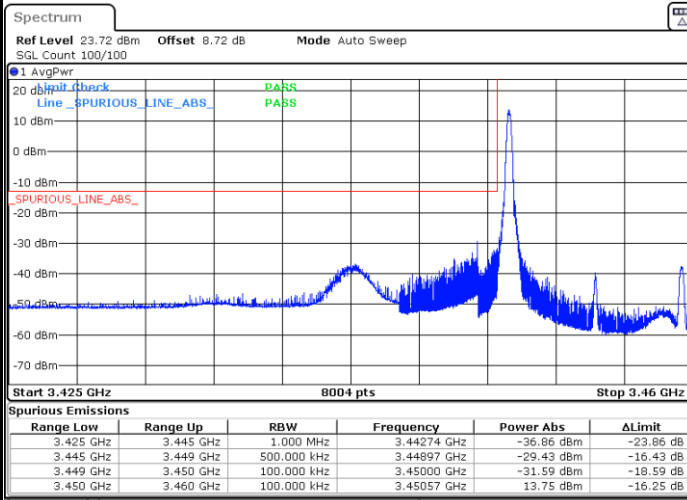

Date: 19 JUN.2022 09:44:17

Highest Band Edge / 1 RB

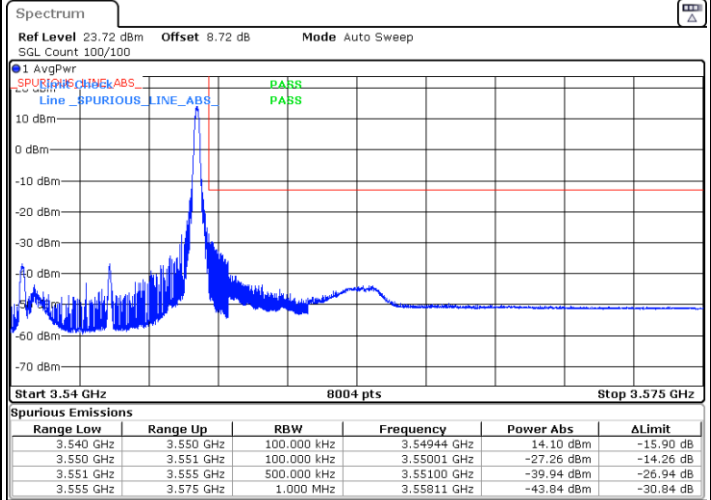

Date: 19 JUN.2022 10:40:44

Lowest Band Edge / Full RB

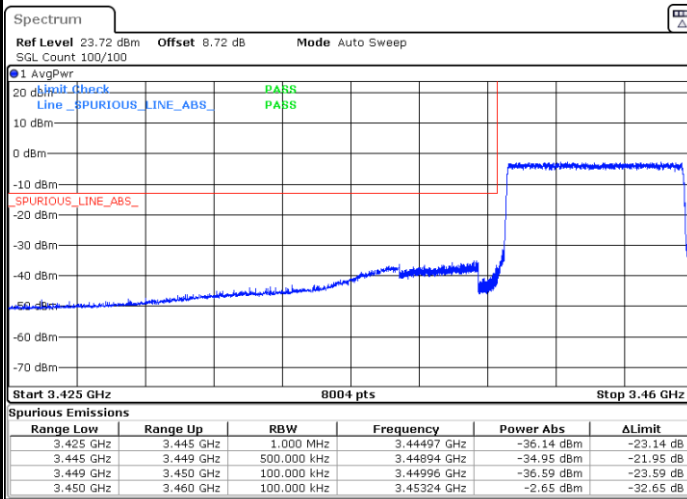

Date: 19 JUN.2022 09:49:51

Highest Band Edge / Full RB

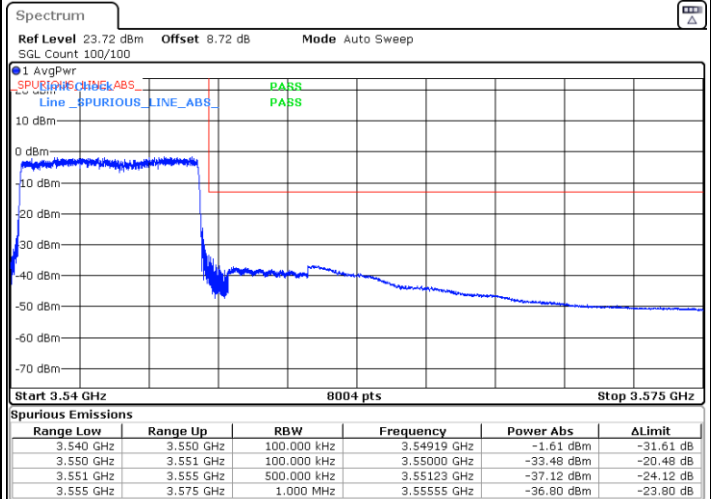

Date: 19 JUN.2022 10:25:14



LTE Band 42 / 15MHz / QPSK

Lowest Band Edge / 1 RB

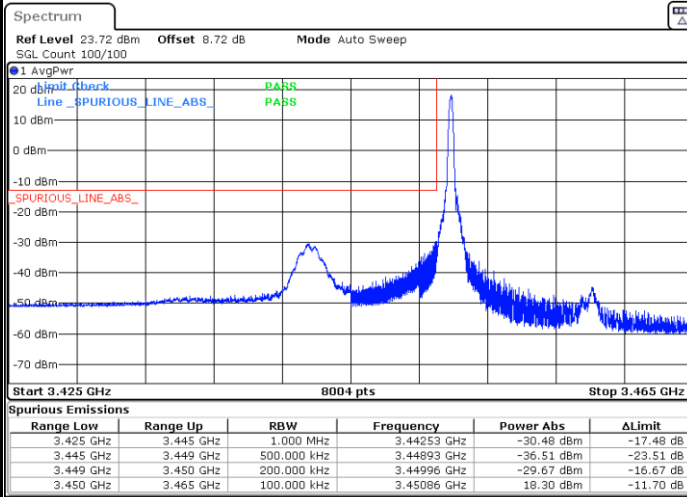

Date: 19 JUN 2022 11:09:15

Highest Band Edge / 1 RB

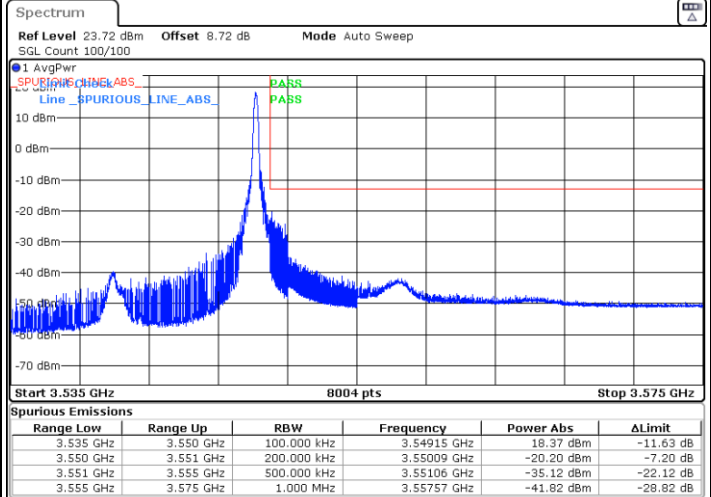

Date: 19 JUN 2022 11:34:57

Lowest Band Edge / Full RB

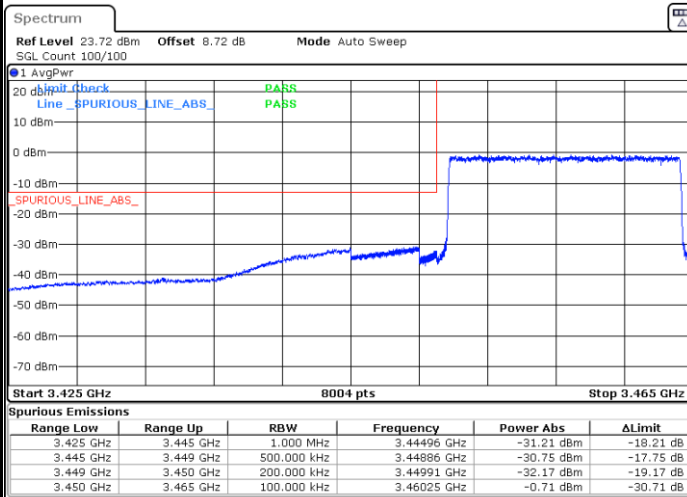

Date: 19 JUN 2022 11:19:25

Highest Band Edge / Full RB

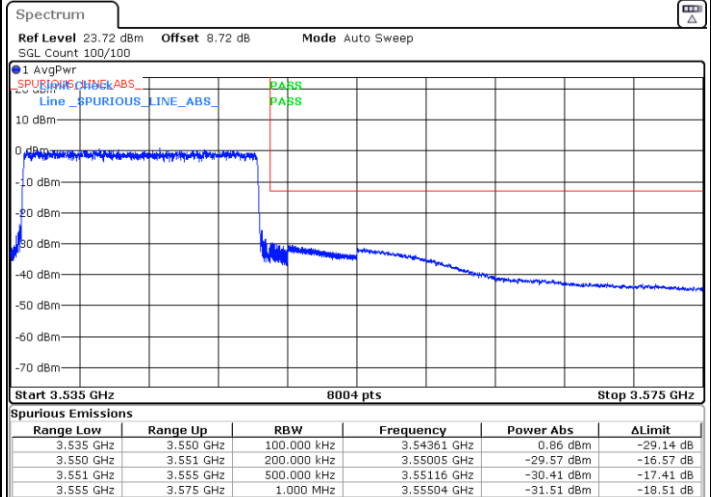

Date: 19 JUN 2022 11:20:50



LTE Band 42 / 15MHz / 16QAM

Lowest Band Edge / 1 RB

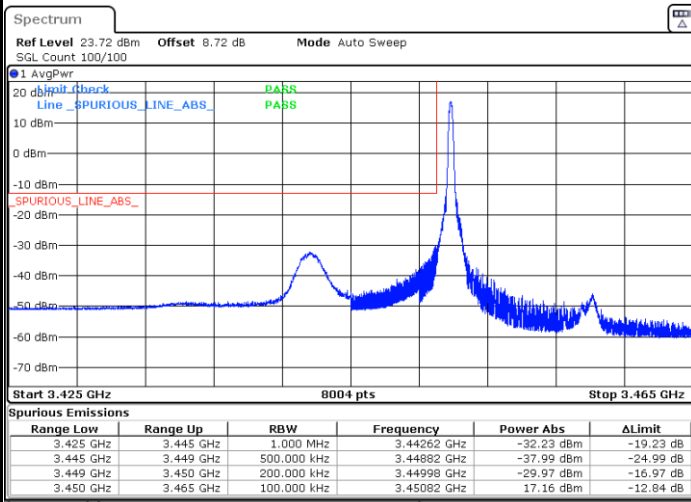

Date: 19 JUN.2022 11:10:32

Highest Band Edge / 1 RB

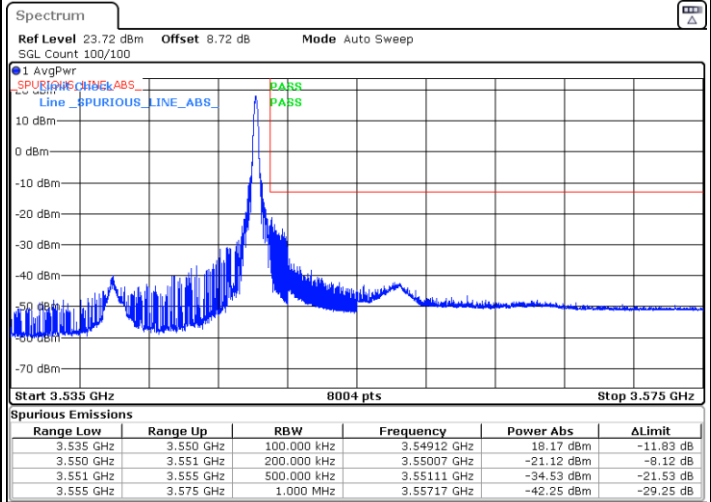

Date: 19 JUN.2022 11:34:02

Lowest Band Edge / Full RB

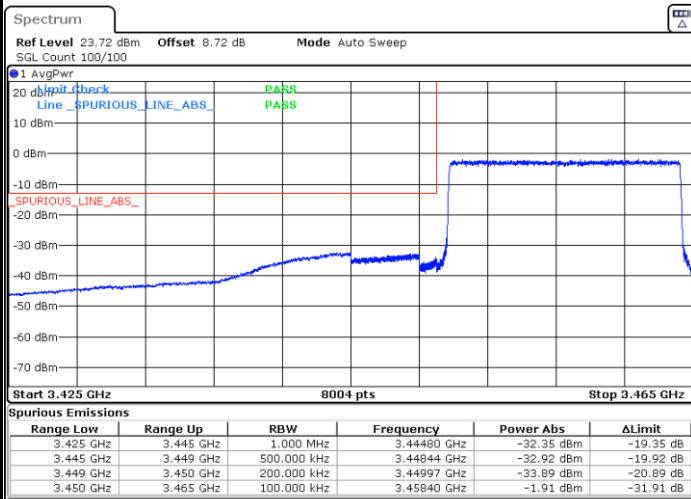

Date: 19 JUN.2022 11:18:36

Highest Band Edge / Full RB

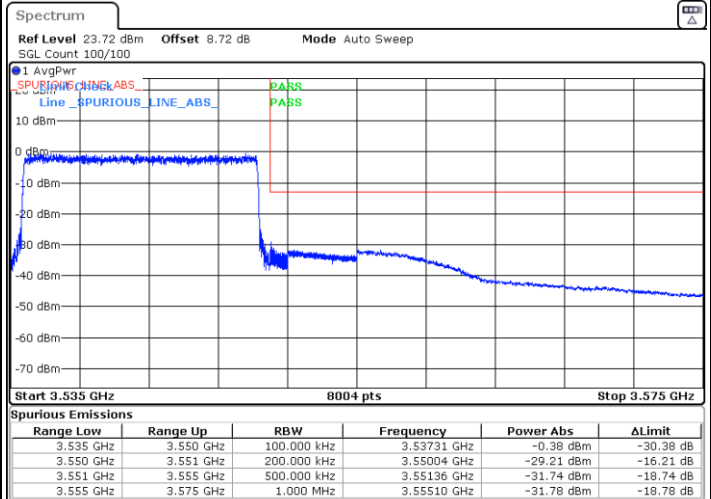

Date: 19 JUN.2022 11:28:31



LTE Band 42 / 15MHz / 64QAM

Lowest Band Edge / 1 RB

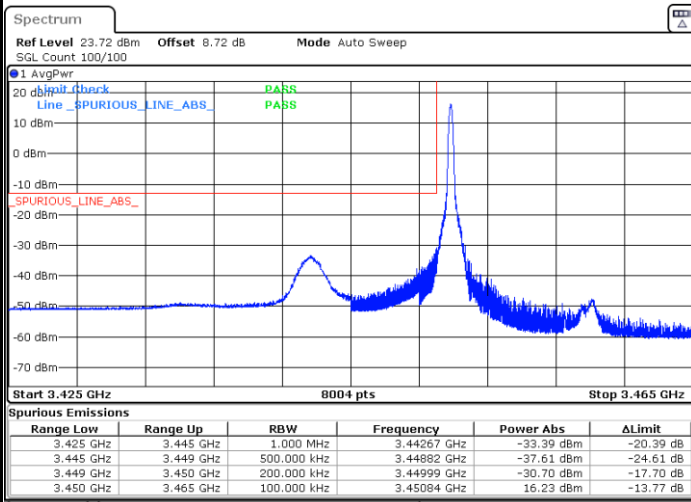

Date: 19 JUN.2022 11:12:04

Highest Band Edge / 1 RB

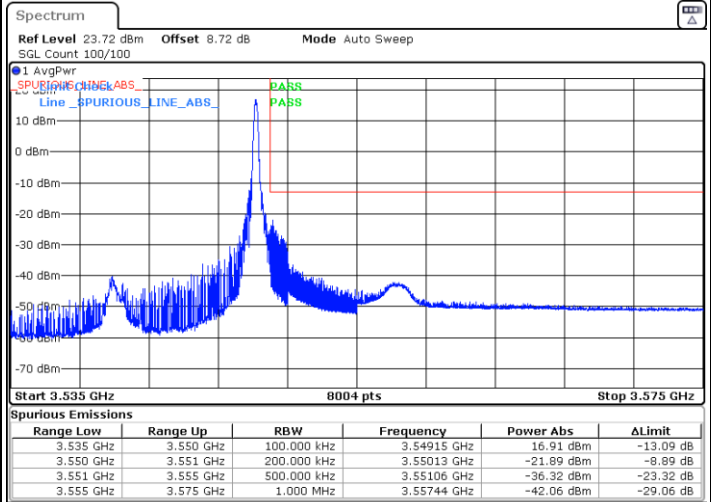

Date: 19 JUN.2022 11:32:53

Lowest Band Edge / Full RB

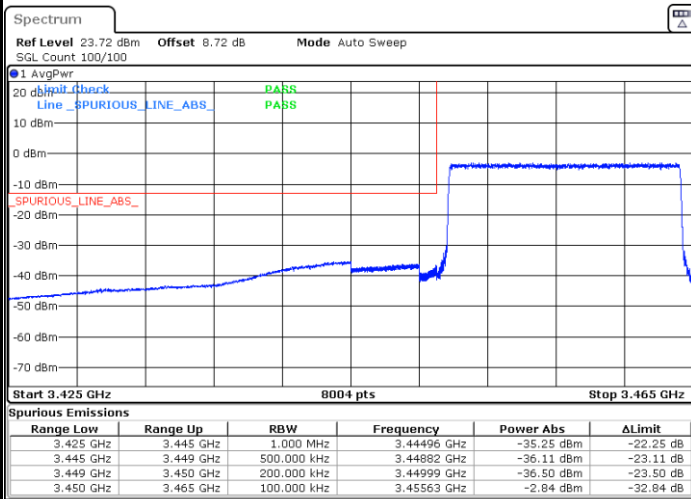

Date: 19 JUN.2022 11:15:04

Highest Band Edge / Full RB

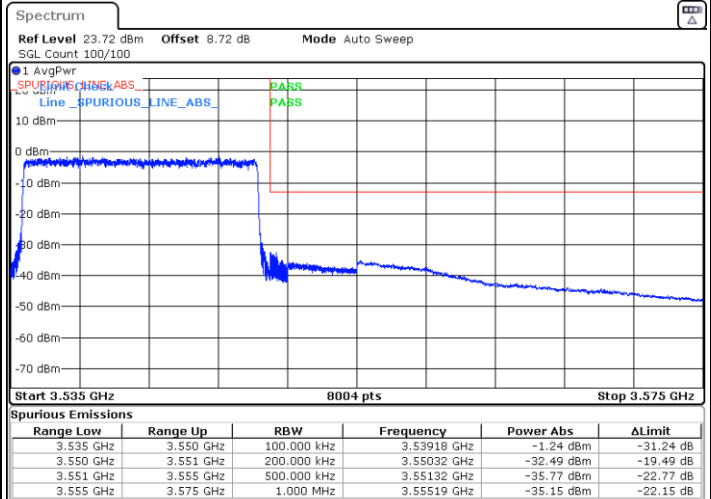

Date: 19 JUN.2022 11:29:21





LTE Band 42 / 15MHz / 256QAM

Lowest Band Edge / 1 RB

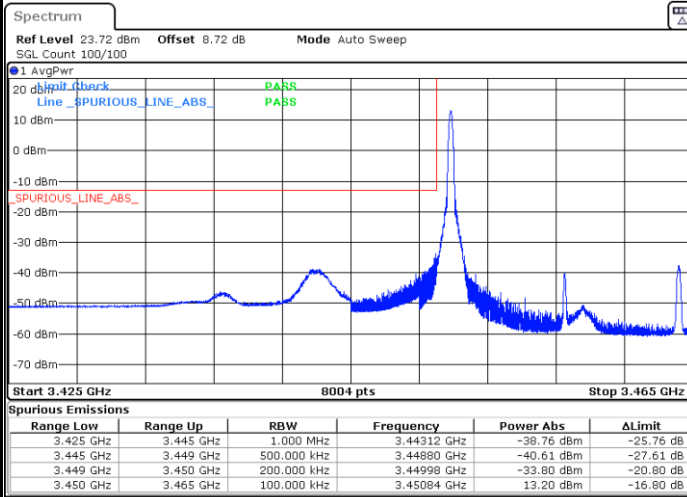

Date: 19 JUN 2022 11:13:05

Highest Band Edge / 1 RB

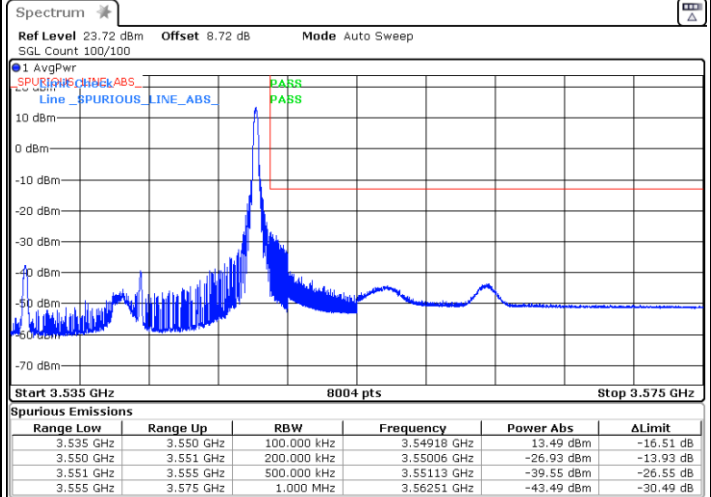

Date: 19 JUN 2022 11:31:36

Lowest Band Edge / Full RB

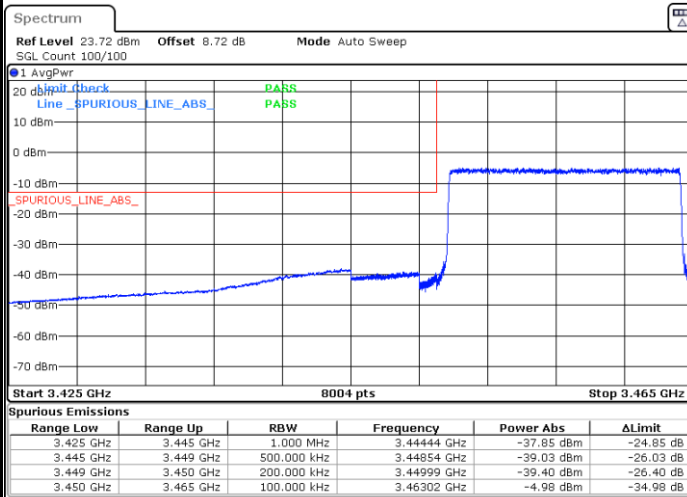

Date: 19 JUN 2022 11:14:08

Highest Band Edge / Full RB

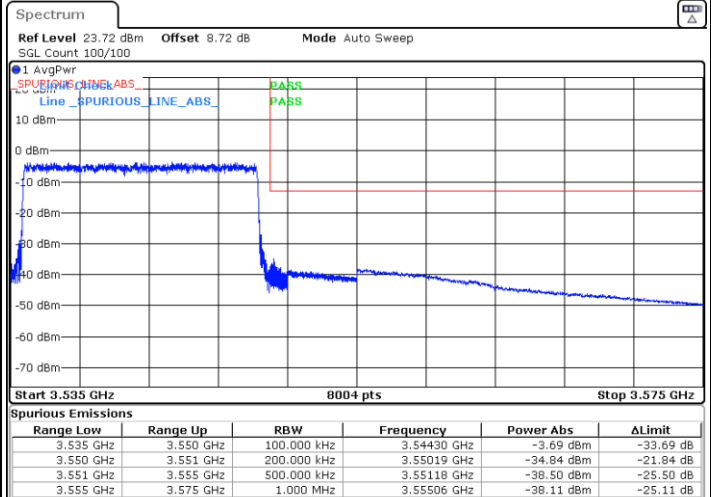

Date: 19 JUN 2022 11:30:33



LTE Band 42 / 20MHz / QPSK

Lowest Band Edge / 1 RB

Highest Band Edge / 1 RB

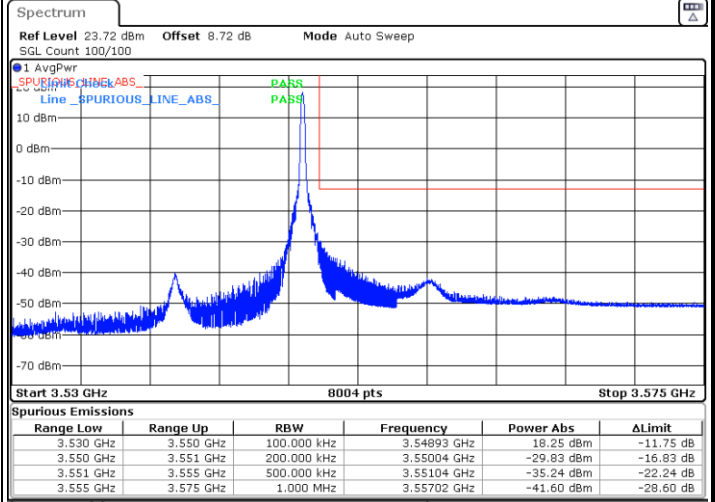
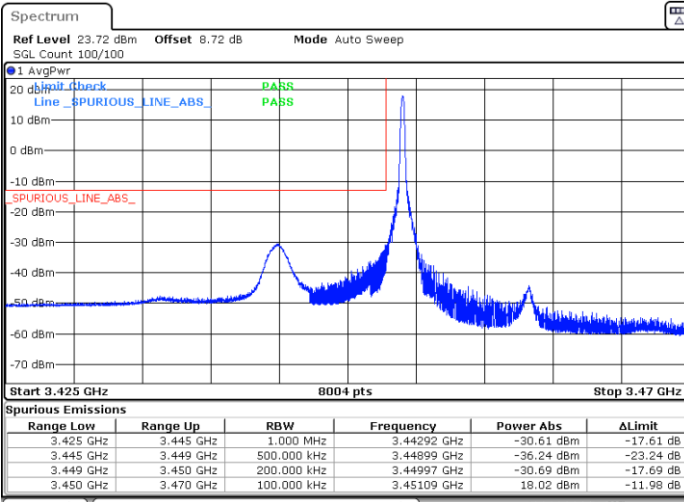

Date: 19 JUN 2022 11:38:32

Date: 19 JUN 2022 12:14:56

Lowest Band Edge / Full RB

Highest Band Edge / Full RB

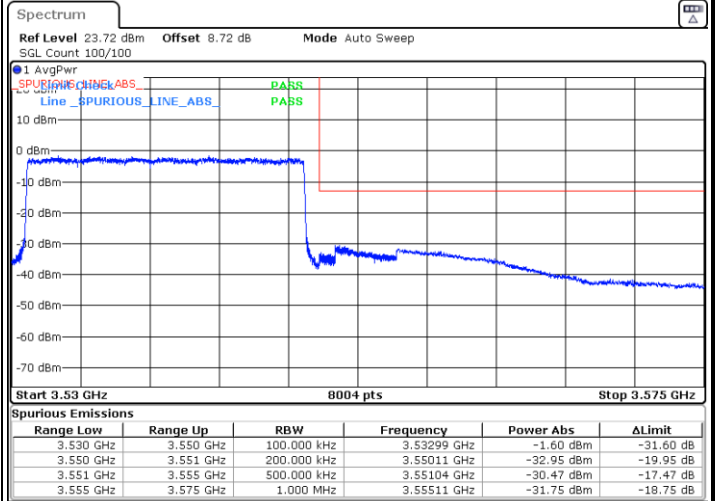
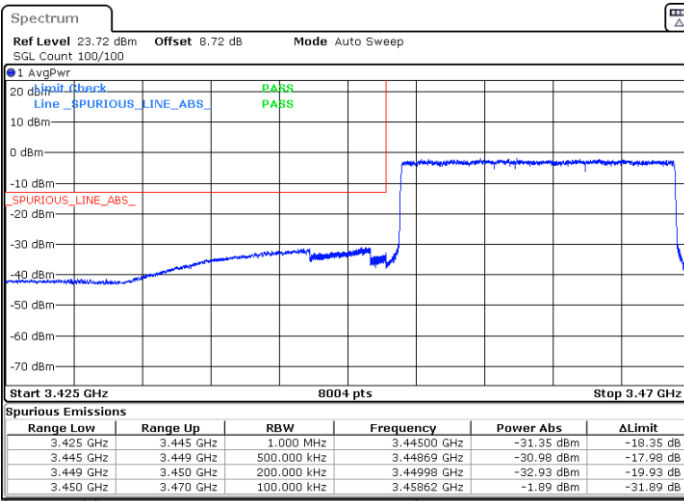

Date: 19 JUN 2022 11:51:13

Date: 19 JUN 2022 11:52:19



LTE Band 42 / 20MHz / 16QAM

Lowest Band Edge / 1 RB

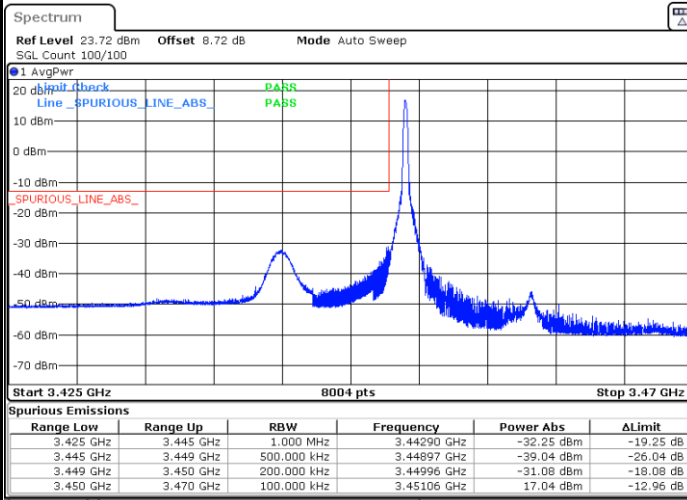

Date: 19 JUN.2022 11:40:51

Highest Band Edge / 1 RB

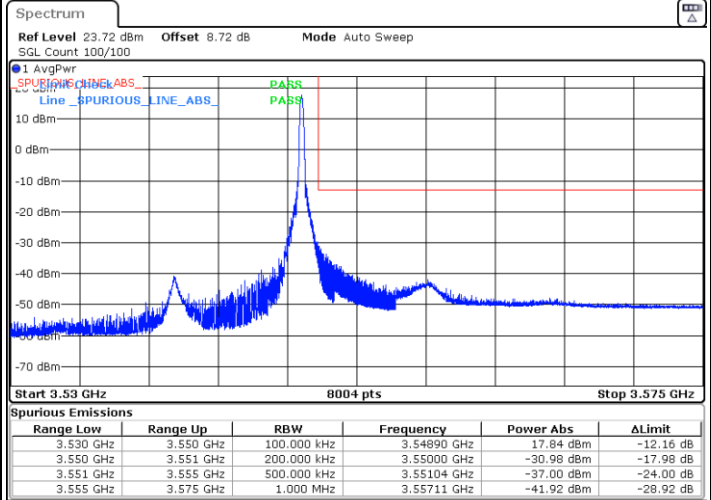

Date: 19 JUN.2022 12:13:58

Lowest Band Edge / Full RB

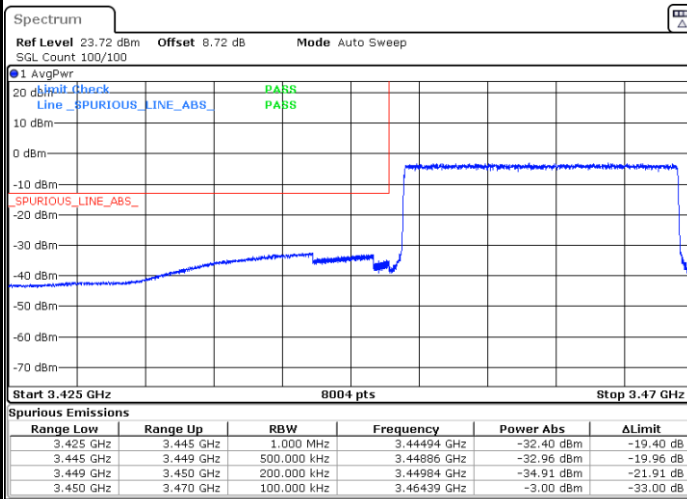

Date: 19 JUN.2022 11:46:35

Highest Band Edge / Full RB

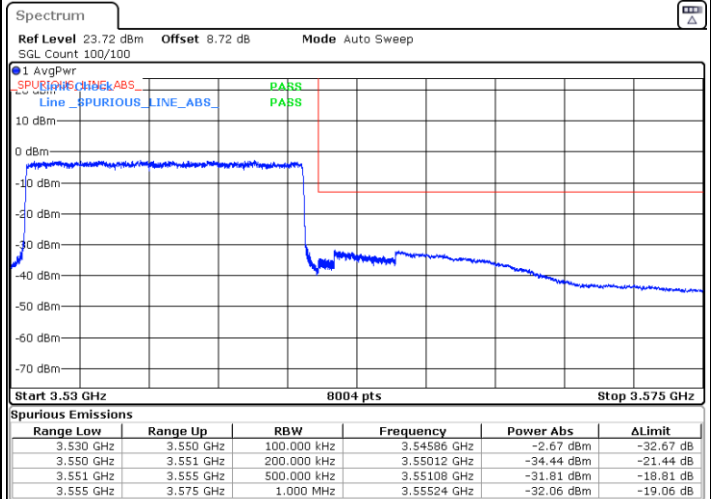

Date: 19 JUN.2022 12:10:05



LTE Band 42 / 20MHz / 64QAM

Lowest Band Edge / 1 RB

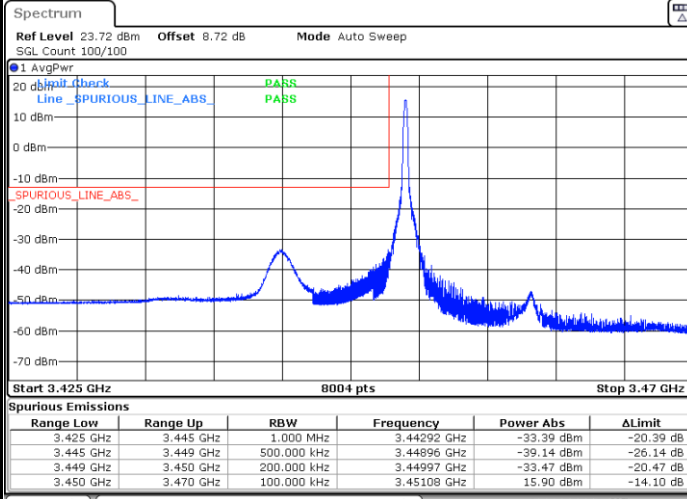

Date: 19 JUN 2022 11:41:50

Highest Band Edge / 1 RB

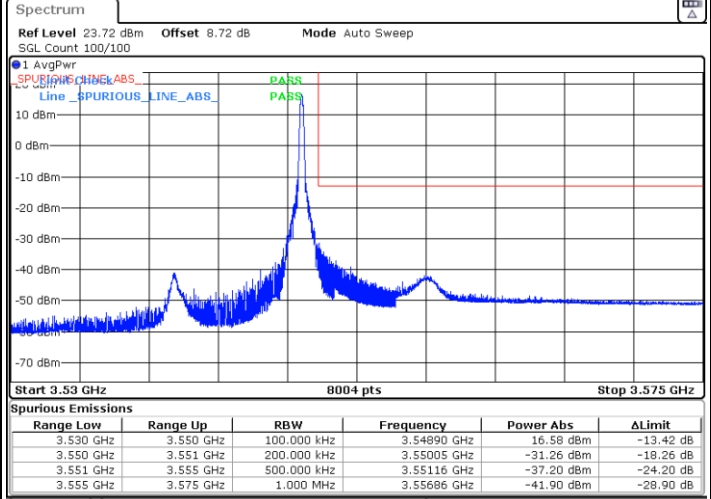

Date: 19 JUN 2022 12:13:11

Lowest Band Edge / Full RB

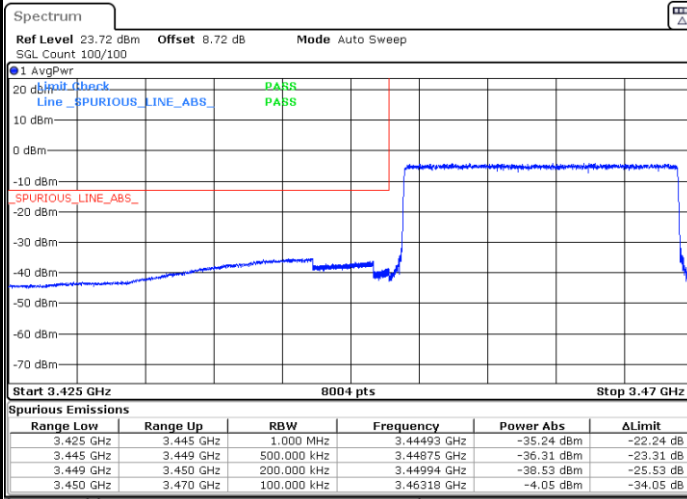

Date: 19 JUN 2022 11:45:47

Highest Band Edge / Full RB

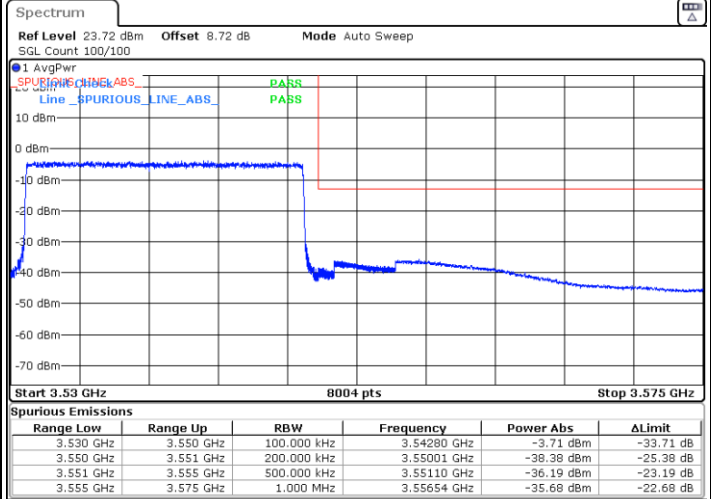

Date: 19 JUN 2022 12:10:47



LTE Band 42 / 20MHz / 256QAM

Lowest Band Edge / 1 RB

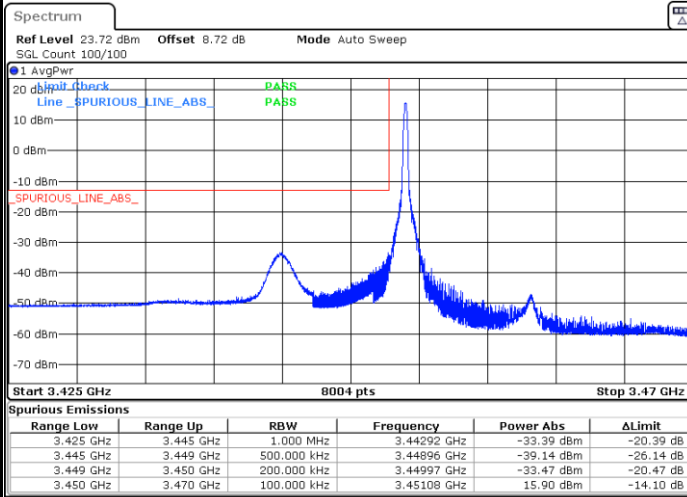

Date: 19 JUN 2022 11:41:50

Highest Band Edge / 1 RB

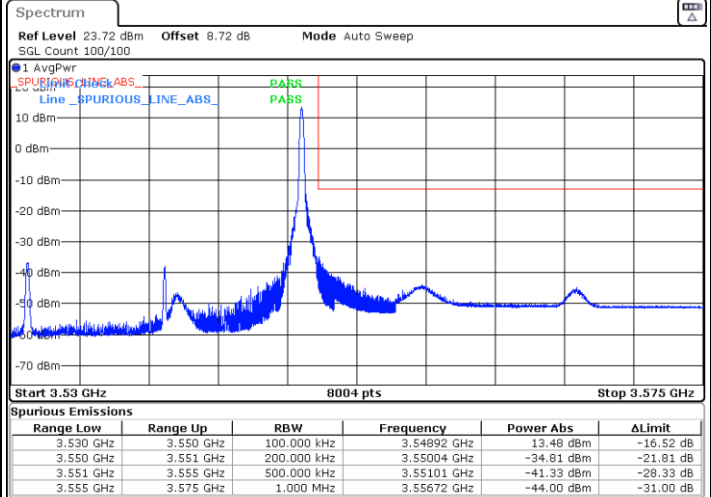

Date: 19 JUN 2022 12:12:23

Lowest Band Edge / Full RB

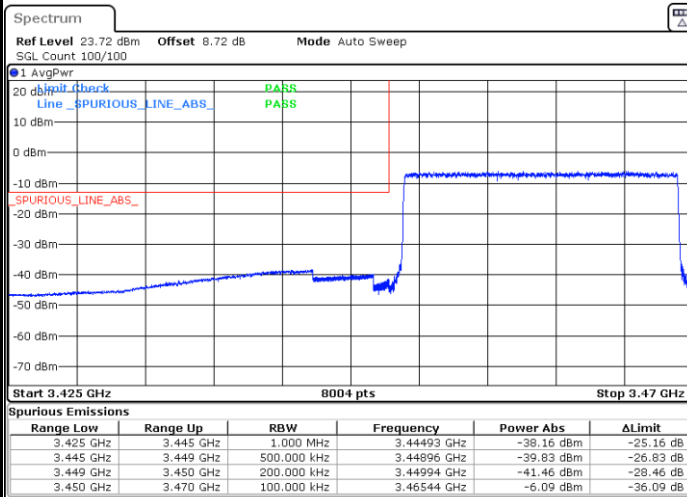

Date: 19 JUN 2022 11:44:35

Highest Band Edge / Full RB

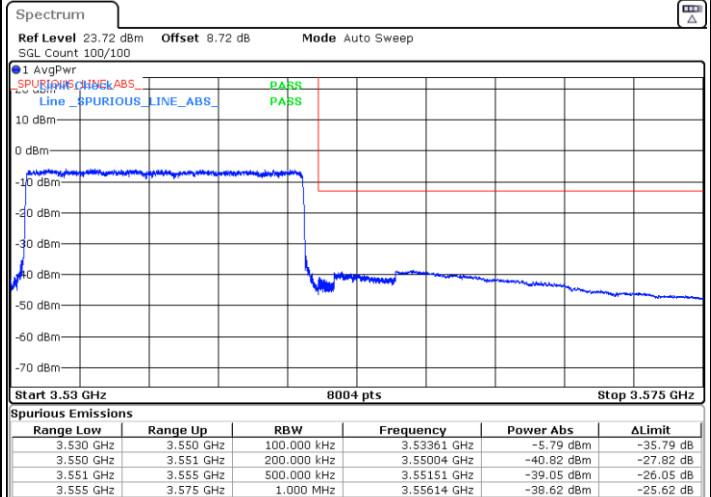

Date: 19 JUN 2022 12:11:31



# Conducted Spurious Emission

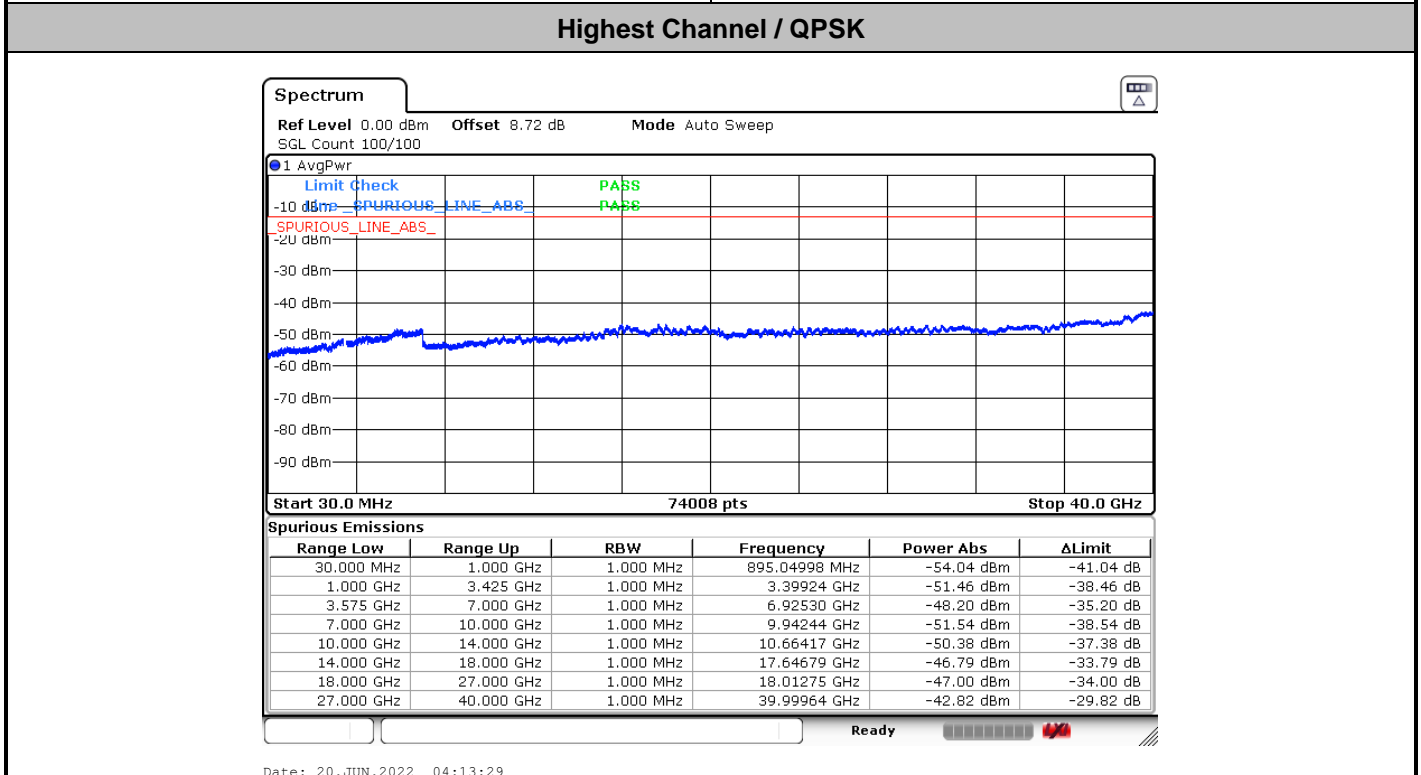
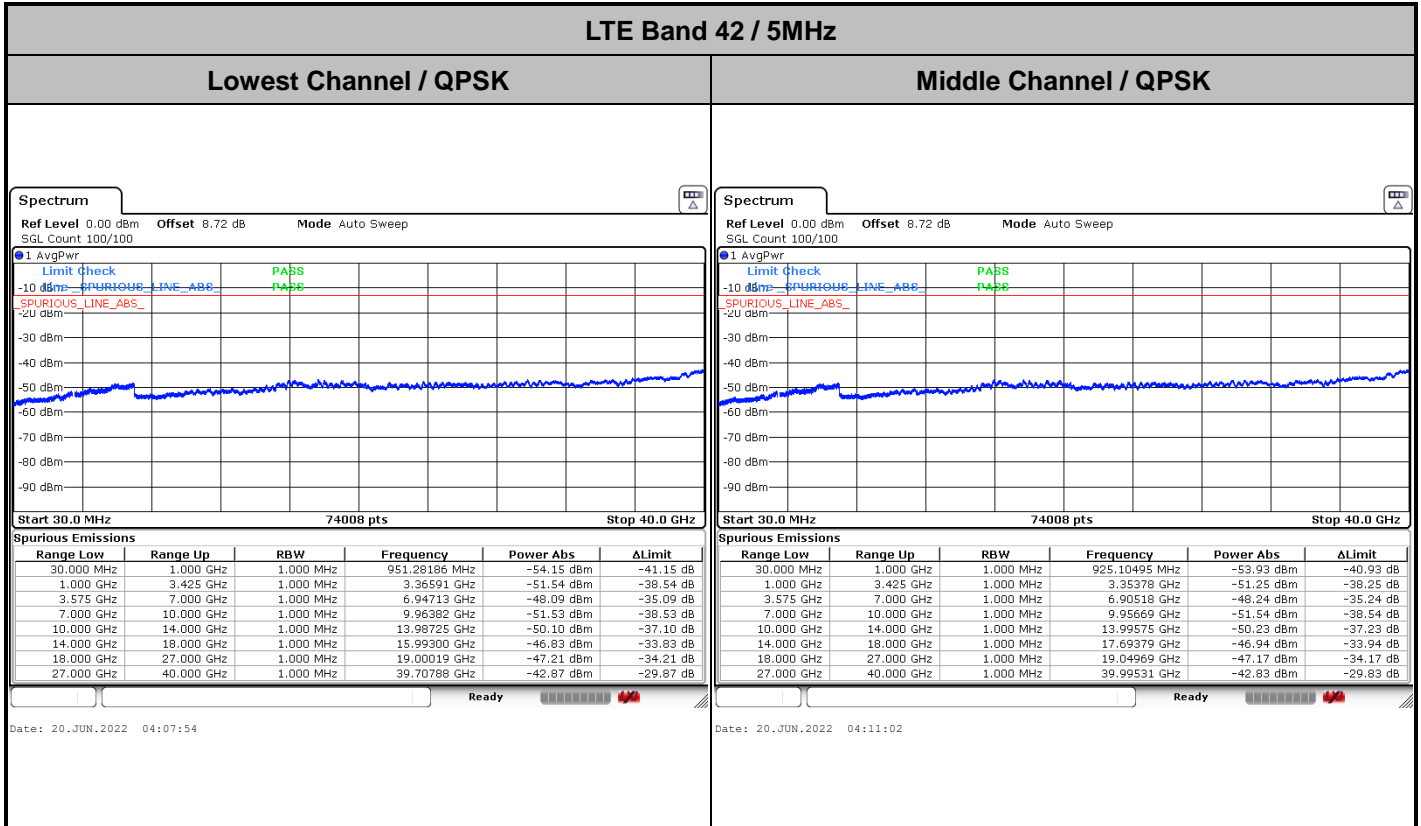



LTE Band 42 / 10MHz

Lowest Channel / QPSK

Middle Channel / QPSK

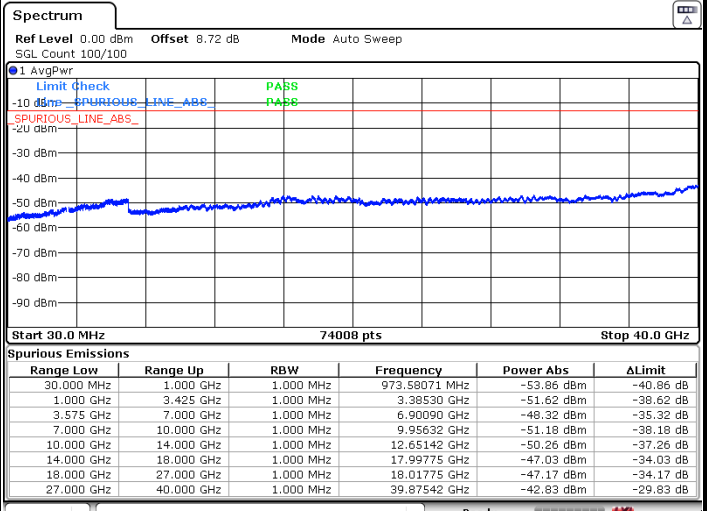
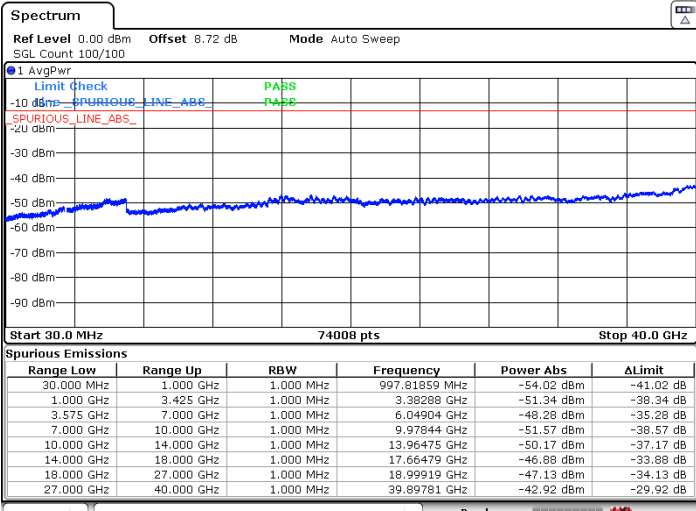

Highest Channel / QPSK

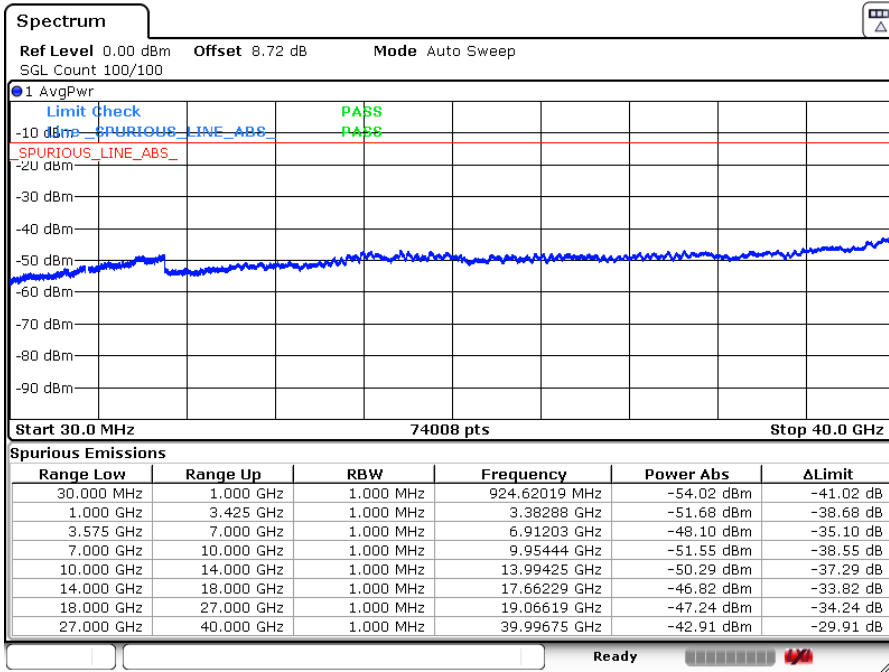



LTE Band 42 / 15MHz

Lowest Channel / QPSK

Middle Channel / QPSK

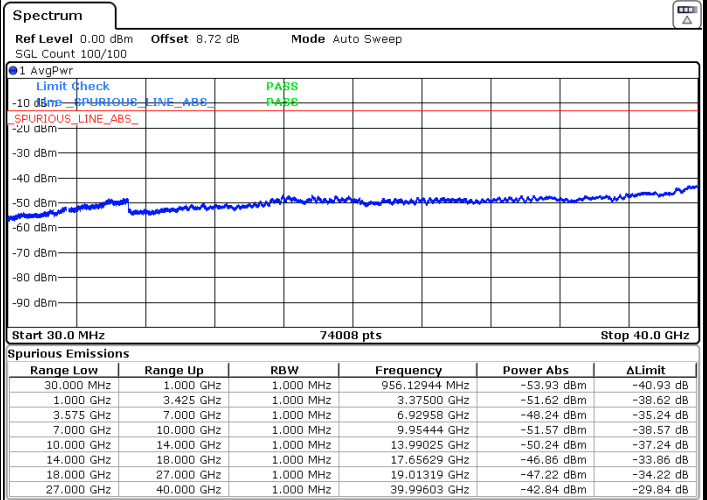
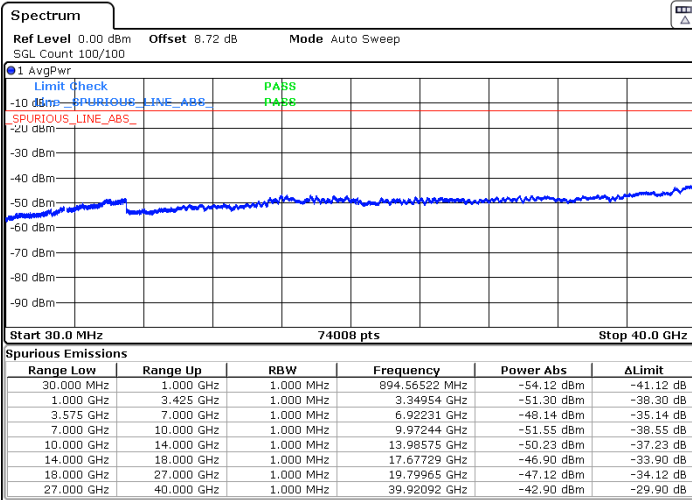

Date: 20 JUN.2022 04:21:56

Date: 20 JUN.2022 04:23:10

Highest Channel / QPSK

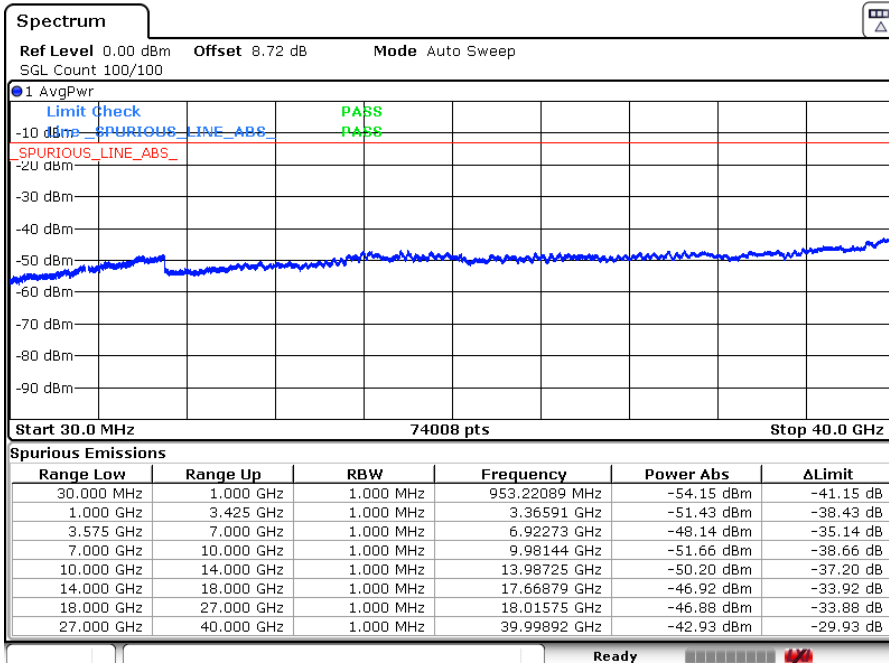

Date: 20 JUN.2022 04:24:30





**LTE Band 42 / 20MHz**

**Lowest Channel / QPSK**

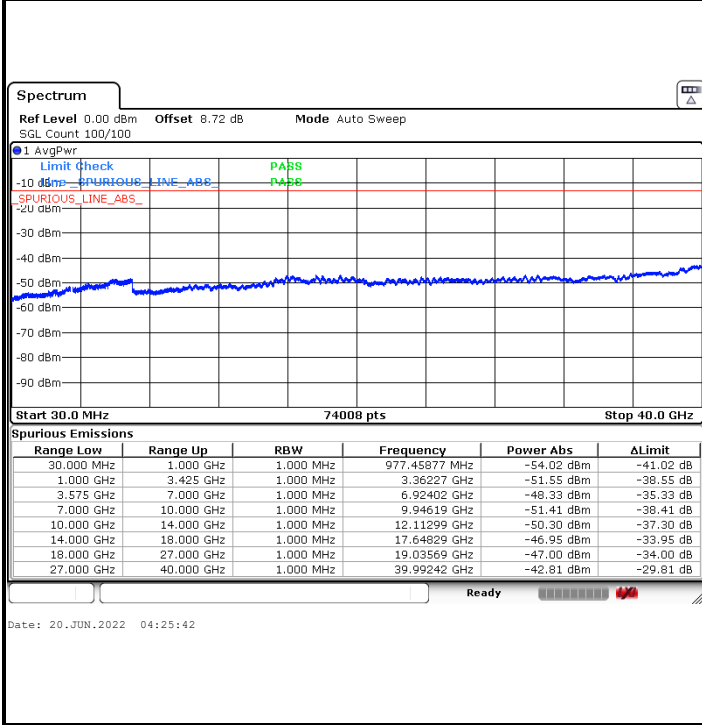

**Middle Channel / QPSK**

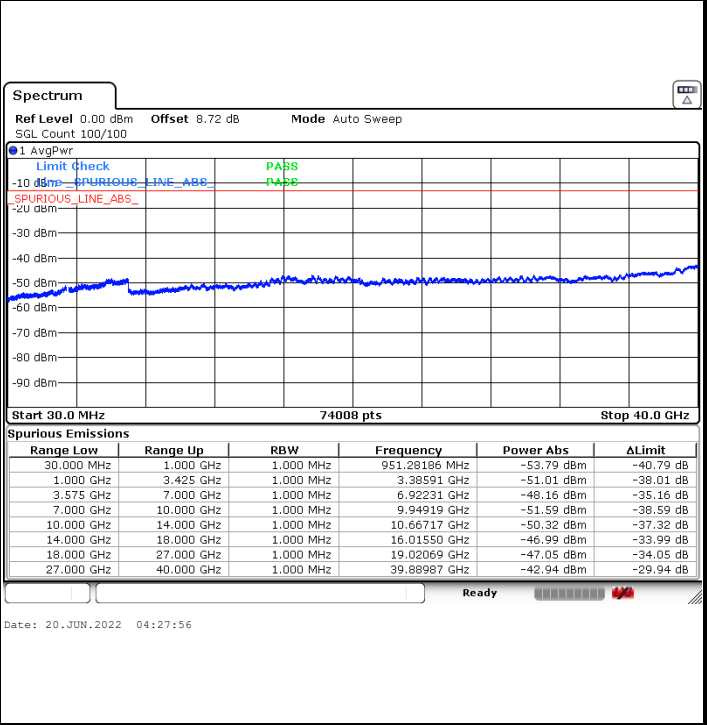

**Highest Channel / QPSK**

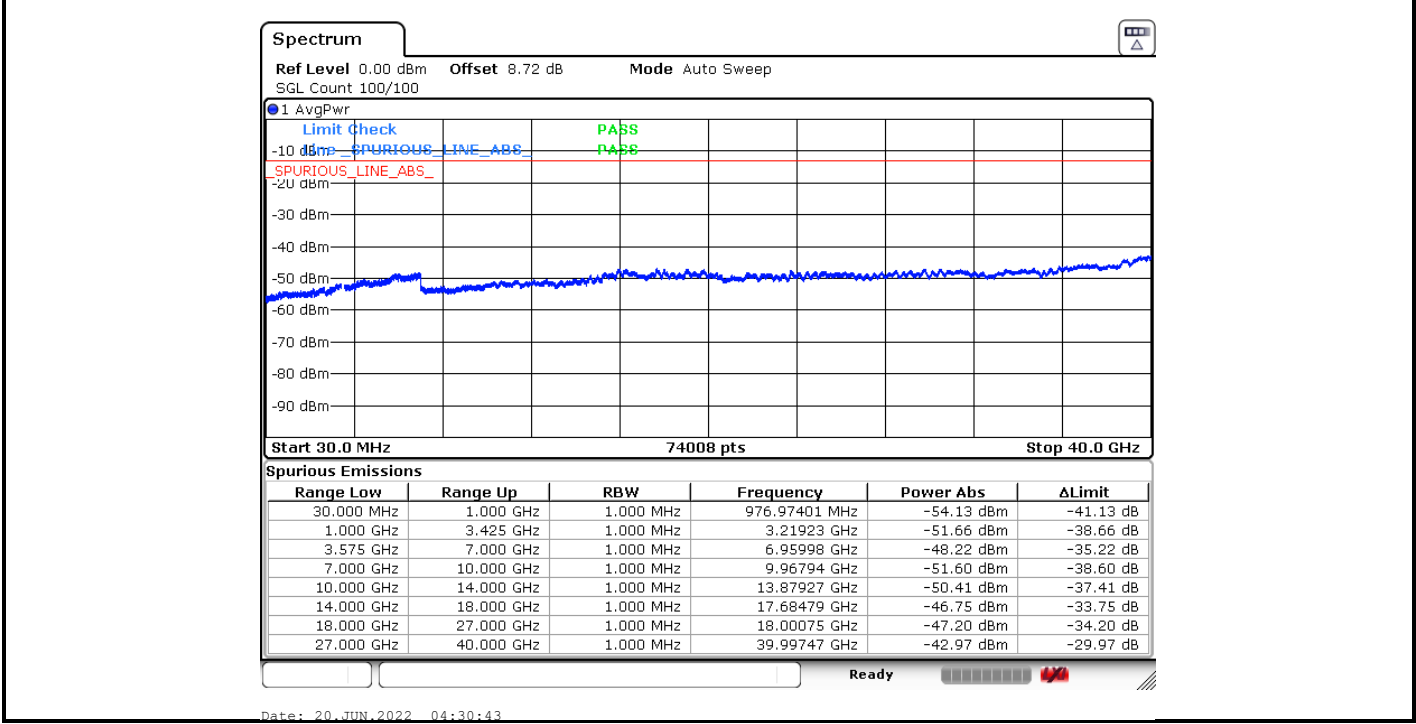



Frequency Stability

Test Conditions		LTE Band 42 (QPSK) / Middle Channel	Limit
Temperature (°C)	Voltage (Volt)	BW 10MHz	Note 2.
		Deviation (ppm)	Result
50	Normal Voltage	0.0013	PASS
40	Normal Voltage	0.0011	
30	Normal Voltage	0.0007	
20(Ref.)	Normal Voltage	0.0000	
10	Normal Voltage	0.0020	
0	Normal Voltage	0.0002	
-10	Normal Voltage	0.0007	
-20	Normal Voltage	0.0011	
-30	Normal Voltage	0.0023	
20	Maximum Voltage	0.0019	
20	Normal Voltage	0.0006	
20	Battery End Point	0.0019	

Note:

1. Normal Voltage = 3.89 V. ; Battery End Point (BEP) =3.4 V. ; Maximum Voltage =4.48 V.
2. Note: The frequency fundamental emissions stay within the authorized frequency block.



## Appendix B. Test Results of Radiated Test

### Radiated Spurious Emission

Test Engineer :	Simle Wang	Temperature :	23~25°C
		Relative Humidity :	41~42%

LTE Band 42 / 20MHz / QPSK								
Channel	Frequency ( MHz )	EIRP ( dBm )	Limit ( dBm )	Over Limit ( dB )	S.G. Power ( dBm )	TX Cable loss ( dB )	TX Antenna Gain (dBi)	Polarization (H/V)
Middle	6984	-54.44	-13	-41.44	-63.89	3.56	13.01	H
	10476	-52.30	-13	-39.30	-61.82	3.92	13.44	H
	13962	-58.68	-13	-45.68	-67.72	4.39	13.43	H
	17454	-46.72	-13	-33.72	-54.52	5.20	13.00	H
	6984	-54.48	-13	-41.48	-63.93	3.56	13.01	V
	10476	-57.09	-13	-44.09	-66.61	3.92	13.44	V
	13962	-54.40	-13	-41.40	-63.44	4.39	13.43	V
	17454	-37.15	-13	-24.15	-44.95	5.20	13.00	V

Remark: Spurious emissions within 30-1000MHz were found more than 20dB below limit line.