



FCC RF Test Report

APPLICANT : Motorola Mobility LLC
EQUIPMENT : Mobile Cellular Phone
BRAND NAME : Motorola
MODEL NAME : XT2241-2
FCC ID : IHDT56AF6
STANDARD : 47 CFR Part 2, 22, 24, 27
CLASSIFICATION : PCS Licensed Transmitter Held to Ear (PCE)
TEST DATE(S) : Jun. 07, 2022 ~ Jul. 12, 2022

We, Sporton International Inc. (Kunshan), would like to declare that the tested sample has been evaluated in accordance with the procedures given in ANSI C63.26-2015 and shown compliance with the applicable technical standards.

The test results in this report apply exclusively to the tested model / sample. Without written approval of Sporton International Inc. (Kunshan), the test report shall not be reproduced except in full.

Jason Jia

Approved by: Jason Jia



Sporton International Inc. (Kunshan)

**No. 1098, Pengxi North Road, Kunshan Economic Development Zone Jiangsu Province 215300
People's Republic of China**



TABLE OF CONTENTS

REVISION HISTORY...3
SUMMARY OF TEST RESULT...4
1 GENERAL DESCRIPTION...5
1.1 Applicant...5
1.2 Manufacturer...5
1.3 Product Feature of Equipment Under Test...5
1.4 Product Specification of Equipment Under Test...6
1.5 Modification of EUT...7
1.6 Specification of Accessory...7
1.7 Maximum ERP/EIRP Power and Emission Designator...8
1.8 Testing Location...9
1.9 Test Software...9
1.10 Applicable Standards...9
2 TEST CONFIGURATION OF EQUIPMENT UNDER TEST...10
2.1 Test Mode...10
2.2 Connection Diagram of Test System...12
2.3 Support Unit used in test configuration and system...12
2.4 Measurement Results Explanation Example...12
2.5 Frequency List of Low/Middle/High Channels...13
3 CONDUCTED TEST ITEMS...15
3.1 Measuring Instruments...15
3.2 Test Setup...15
3.3 Test Result of Conducted Test...15
3.4 Conducted Output Power and ERP/EIRP...16
3.5 Peak-to-Average Ratio...17
3.6 Occupied Bandwidth...18
3.7 Conducted Band Edge...19
3.8 Conducted Spurious Emission...21
3.9 Frequency Stability...22
4 RADIATED TEST ITEMS...23
4.1 Measuring Instruments...23
4.2 Test Setup...23
4.3 Test Result of Radiated Test...24
4.4 Radiated Spurious Emission...25
5 LIST OF MEASURING EQUIPMENT...26
6 UNCERTAINTY OF EVALUATION...27
APPENDIX A. TEST RESULTS OF CONDUCTED TEST
APPENDIX B. TEST RESULTS OF RADIATED TEST
APPENDIX C. TEST SETUP PHOTOGRAPHS



REVISION HISTORY

REPORT NO.	VERSION	DESCRIPTION	ISSUED DATE
FG252601I	Rev. 01	Initial issue of report	Jul. 11, 2022



SUMMARY OF TEST RESULT

Report Section	FCC Rule	Description	Limit	Result	Remark
3.4	§2.1046	Conducted Output Power	Reporting Only	PASS	-
	§22.913(a)(5)	Effective Radiated Power (5G NR n5)	ERP < 7 Watt		
	§24.232(c) §27.50(h)(2)	Equivalent Isotropic Radiated Power (5G NR n2) (5G NR n7, n41)	EIRP < 2Watt		
	§27.50(d)(4)	Equivalent Isotropic Radiated Power (5G NR n66)	EIRP < 1Watt		
3.5	§24.232(d)	Peak-to-Average Ratio	<13 dB	PASS	-
3.6	§2.1049	Occupied Bandwidth	Reporting Only	PASS	-
3.7	§2.1051 §22.917(a) §24.238(a) §27.53(h)	Conducted Band Edge Measurement (5G NR n5) (5G NR n2) (5G NR n66)	< 43+10log ₁₀ (P[Watts])	PASS	-
	§27.53(m)(4)	Conducted Band Edge Measurement (5G NR n7, n41)	§27.53(m)(4)		
3.8	§2.1051 §22.917(a) §24.238(a) §27.53(h)	Conducted Spurious Emission (5G NR n5) (5G NR n2) (5G NR n66)	< 43+10log ₁₀ (P[Watts])	PASS	-
	§2.1051 §27.53(m)(4)	Conducted Spurious Emission (5G NR n7, n41)	< 55+10log ₁₀ (P[Watts])		
3.9	§2.1055 §22.355	Frequency Stability Temperature & Voltage	< 2.5 ppm for Part 22	PASS	-
	§24.235 §27.54		Within Authorized Band		
4.4	§2.1053 §22.917(a) §24.238(a) §27.53(h)	Radiated Spurious Emission (5G NR n5) (5G NR n2) (5G NR n66)	< 43+10log ₁₀ (P[Watts])	PASS	Under limit 21.15 dB at 7542.000 MHz
	§2.1053 §27.53(m)(4)	Radiated Spurious Emission (5G NR n7, n41)	< 55+10log ₁₀ (P[Watts])		

Declaration of Conformity:

The test results with all measurement uncertainty excluded are presented in accordance with the regulation limits or requirements declared by manufacturers.

Comments and Explanations:

The declared of product specification for EUT presented in the report are provided by the manufacturer, and the manufacturer takes all the responsibilities for the accuracy of product specification.



1 General Description

1.1 Applicant

Motorola Mobility LLC
222 W, Merchandise Mart Plaza, Chicago IL 60654 USA

1.2 Manufacturer

Motorola Mobility LLC
222 W, Merchandise Mart Plaza, Chicago IL 60654 USA

1.3 Product Feature of Equipment Under Test

Product Feature	
Equipment	Mobile Cellular Phone
Brand Name	Motorola
Model Name	XT2241-2
FCC ID	IHDT56AF6
IMEI Code	Conducted : 355222700012736/355222700012744 Radiation : 355222700012934
HW Version	DVT2
SW Version	SSQ32.54
EUT Stage	Identical Prototype

Remark:

Only 5G NR bands are tested in this report, all the other RF bands are tested in the other reports separately.



1.4 Product Specification of Equipment Under Test

Standards-related Product Specification	
Tx Frequency	5G NR n2 : 1850 MHz ~ 1910 MHz 5G NR n5 : 824 MHz ~ 849 MHz 5G NR n7 : 2500 MHz ~ 2570 MHz 5G NR n41 : 2496 MHz ~ 2690 MHz 5G NR n66 : 1710 MHz ~ 1780 MHz
Rx Frequency	5G NR n2 : 1930 MHz ~ 1990 MHz 5G NR n5 : 869 MHz ~ 894 MHz 5G NR n7 : 2620 MHz ~ 2690 MHz 5G NR n41 : 2496 MHz ~ 2690 MHz 5G NR n66 : 2110 MHz~ 2200 MHz
SCS	n2, n5, n7, n66: 15kHz n41: 30kHz
Bandwidth	n2 (NSA), n5 (SA/NSA): 5MHz / 10MHz / 15MHz / 20MHz n7(SA/NSA): 5MHz / 10MHz / 15MHz / 20MHz / 25MHz / 30MHz / 40MHz n66 (SA/NSA): 5MHz / 10MHz / 15MHz / 20MHz / 30MHz / 40MHz n41 (SA/NSA): 20MHz / 30MHz / 40MHz / 50MHz / 60MHz / 70MHz / 80MHz / 90MHz / 100MHz
Antenna Gain	<Ant. 0> n2: -3.6 dBi n5: -4.9 dBi n7: -3.8 dBi n41: -3.6 dBi n66: -2.3 dBi <Ant. 1> n2: -1.6 dBi n5: -5.7 dBi n7: -2.4 dBi n41: -2.1 dBi n66: -2.6 dBi
Type of Modulation	CP-OFDM: QPSK / 16QAM / 64QAM / 256QAM DFT-s-OFDM: PI/2 BPSK / QPSK / 16QAM / 64QAM / 256QAM

Note:

1. The maximum ERP/EIRP is calculated from max output power and antenna gain, only the maximum ERP/EIRP is shown in the report: 5G NR n5, n7, n41, n66 for Ant.0 and n2 for Ant.1 and n41_UL MIMO for Ant.(0+1).
2. 5G NR n41 supports UL MIMO mode, only CP_OFDM mode.
3. 5G NR Bands support SA and NSA mode. The whole testing has assessed SA mode for n5, n41 and NSA mode for n7, n66 by referring to the higher conducted power for conducted test items.
4. The device supports two PAs for 5G NR n2/n5/n7/n66(main PA for SA mode and other PA for NSA mode), the maximum power of other PA is higher than the main PA for n2/n5/n7 and high main PA power for n66, therefore, we chose higher power PA to calculate the EIRP and show in the report.
5. All the supported ENDC combinations are verified conducted power, only the ENDC combination with highest power are shown in the report.
6. The EN-DC mode combination could be referred to the product spec.
7. The device supports HPUE mode for 5G NR n41.
8. MIMO Antenna gain = $10 \log[(10^{G1/20} + 10^{G2/20})^2 / 2]$.
9. For n41 MIMO mode, the conducted BE/Spurious are tested at single antenna port (Worst case) and add $10 \cdot \log(N_{ANT})$ according to KDB 662911 D01.



1.5 Modification of EUT

No modifications are made to the EUT during all test items.

1.6 Specification of Accessory

Specification of Accessory				
AC Adapter (US)	Brand Name	Motorola(AOHAI)	Model Name	MC-1251
AC Adapter (EU)	Brand Name	Motorola(AOHAI)	Model Name	MC-1252
AC Adapter (UK)	Brand Name	Motorola(AOHAI)	Model Name	MC-1253
AC Adapter (IN)	Brand Name	Motorola(AOHAI)	Model Name	MC-1254
AC Adapter (AU)	Brand Name	Motorola(AOHAI)	Model Name	MC-1255
AC Adapter (AR)	Brand Name	Motorola(AOHAI)	Model Name	MC-1256
AC Adapter (BR)	Brand Name	Motorola(AOHAI)	Model Name	MC-1257
AC Adapter (CHILE)	Brand Name	Motorola(AOHAI)	Model Name	MC-1259
Battery	Brand Name	Motorola(ATL)	Model Name	NF45
Earphone 1	Brand Name	Motorola(Lyand)	Model Name	MD211
Earphone 2	Brand Name	Motorola(LCHSE)	Model Name	MD211
USB Cable	Brand Name	Motorola (Saibao)	Model Name	SC18D58980
Wireless Charging dock	Marketing Name	TurboPower 50W Wireless Charging Stand	Model Name	MW-02



1.7 Maximum ERP/EIRP Power and Emission Designator

5G NR n2 (EN DC_7A-n2A)		PI/2 BPSK / QPSK		16QAM / 64QAM / 256QAM	
BW (MHz)	Frequency Range (MHz)	Maximum EIRP(W)	Emission Designator (99%OBW)	Maximum EIRP(W)	Emission Designator (99%OBW)
20	1860.0 ~ 1900.0	0.1476	19M5G7D	0.1542	19M5W7D

5G NR n5 SA		PI/2 BPSK / QPSK		16QAM / 64QAM / 256QAM	
BW (MHz)	Frequency Range (MHz)	Maximum ERP(W)	Emission Designator (99%OBW)	Maximum ERP(W)	Emission Designator (99%OBW)
20	834.0 ~ 839.0	0.0417	19M5G7D	0.0440	19M5W7D

5G NR n7 (EN DC_66A-n7A)		PI/2 BPSK / QPSK		16QAM / 64QAM / 256QAM	
BW (MHz)	Frequency Range (MHz)	Maximum EIRP(W)	Emission Designator (99%OBW)	Maximum EIRP(W)	Emission Designator (99%OBW)
40	2520 ~ 2550	0.0959	38M8G7D	0.0935	38M8W7D

5G NR n41 SA		PI/2 BPSK / QPSK		16QAM / 64QAM / 256QAM	
BW (MHz)	Frequency Range (MHz)	Maximum EIRP(W)	Emission Designator (99%OBW)	Maximum EIRP(W)	Emission Designator (99%OBW)
100	2546.01 ~ 2640.00	0.1959	97M1G7D	0.1592	97M3W7D

5G NR n41 UL MIMO SA		QPSK		16QAM / 64QAM / 256QAM	
BW (MHz)	Frequency Range (MHz)	Maximum EIRP(W)	Emission Designator (99%OBW)	Maximum EIRP(W)	Emission Designator (99%OBW)
100	2546.01 ~ 2640.00	0.3631	98M3G7D	0.3319	97M7W7D

5G NR n66 (EN DC_2A-n66A)		PI/2 BPSK / QPSK		16QAM / 64QAM / 256QAM	
BW (MHz)	Frequency Range (MHz)	Maximum EIRP(W)	Emission Designator (99%OBW)	Maximum EIRP(W)	Emission Designator (99%OBW)
40	1730.0 ~ 1760.0	0.1208	38M8G7D	0.1216	39M0W7D

Note :

1. All modulations have been tested, and only the worst test results of PSK & QAM are shown in the report.
2. Based on engineering evaluation, only the maximum bandwidth test results are shown in the report.



1.8 Testing Location

Sporton International Inc. (Kunshan) is accredited to ISO/IEC 17025:2017 by American Association for Laboratory Accreditation with Certificate Number 5145.02.

Test Firm	Sporton International Inc. (Kunshan)		
Test Site Location	No. 1098, Pengxi North Road, Kunshan Economic Development Zone Jiangsu Province 215300 People's Republic of China TEL : +86-512-57900158 FAX : +86-512-57900958		
Test Site No.	Sporton Site No.	FCC Designation No.	FCC Test Firm Registration No.
	03CH04-KS TH01-KS	CN1257	314309

1.9 Test Software

Item	Site	Manufacturer	Name	Version
1.	03CH04-KS	AUDIX	E3	6.2009-8-24a

1.10 Applicable Standards

According to the specifications of the manufacturer, the EUT must comply with the requirements of the following standards:

- 47 CFR Part 2, 22, 24, 27
- ANSI C63.26-2015
- FCC KDB 971168 D01 Power Meas License Digital Systems v03r01
- FCC KDB 412172 D01 Determining ERP and EIRP v01r01

Remark: All test items were verified and recorded according to the standards and without any deviation during the test.



2 Test Configuration of Equipment Under Test

2.1 Test Mode

Antenna port conducted and radiated test items are performed according to KDB 971168 D01 Power Meas License Digital Systems v03r01 with maximum output power.

For radiated measurement, pre-scanned in three orthogonal panels, X, Y, Z. The worst cases (Z, Y plane) were recorded in this report.

The device is investigated from 30MHz to 10 times of fundamental signal for radiated spurious emission test under different RB size/offset and modulations in exploratory test. Subsequently, only the worst case emissions are reported.

Orthogonal Planes of EUT	X Plane	Y Plane	Z Plane
			

Test Items	5G NR	Bandwidth (MHz)									Modulation					RB #		Test Channel		
		5	10/15	20	25	30	40	50	60-90	100	PI/2 BPSK	QPSK	16QAM	64QAM	256 QAM	1	Full	L	M	H
Max. Output Power	n2	v	v	v		-	-	-	-	-	v	v	v	v	v	v	v	v	v	v
	n5	v	v	v		-	-	-	-	-	v	v	v	v	v	v	v	v	v	v
	n7	v	v	v	v	v	v		-	-	v	v	v	v	v	v	v	v	v	v
	n41	-		v	-	v	v	v	v	v	v	v	v	v	v	v	v	v	v	v
	n66	v	v	v	-	v	v	-	-	-	v	v	v	v	v	v	v	v	v	v
Peak-to-Average Ratio	n2			v		-	-	-	-	-	v	v					v		v	
	n5			v		-	-	-	-	-	v	v					v		v	
	n7						v		-	-	v	v					v		v	
	n41	-			-				v		v	v					v		v	
	n66						v				v	v					v		v	
26dB and 99% Bandwidth	n2	v	v	v		-	-	-	-	-		v	v	v	v		v		v	
	n5	v	v	v		-	-	-	-	-		v	v	v	v		v		v	
	n7	v	v	v	v	v	v		-	-		v	v	v	v		v		v	
	n41	-		v	-	v	v	v	v	v		v	v	v	v		v		v	
	n66	v	v	v	-	v	v					v	v	v	v		v		v	



Test Items	5G NR	Bandwidth (MHz)									Modulation					RB #		Test Channel		
		5	10/15	20	25	30	40	50	60-90	100	PI/2 BPSK	QPSK	16QAM	64QAM	256 QAM	1	Full	L	M	H
Conducted Band Edge	n2	v	v	v		-	-	-	-	-	v	v				v	v	v		v
	n5	v	v	v		-	-	-	-	-	v	v				v	v	v		v
	n7	v	v	v			v				v	v				v	v	v		v
	n41	-		v	-				v	v	v	v				v	v	v		v
	n66	v		v			v				v	v				v	v	v		v
Conducted Spurious Emission	n2	v	v	v		-	-	-	-	-	v	v				v		v	v	v
	n5	v	v	v		-	-	-	-	-	v	v				v		v	v	v
	n7	v	v	v			v				v	v				v		v	v	v
	n41	-		v	-				v	v	v	v				v		v	v	v
	n66	v		v			v				v	v				v		v	v	v
Frequency Stability	n2			v		-	-	-	-	-		v					v		v	
	n5			v		-	-	-	-	-		v					v		v	
	n7			v								v					v		v	
	n41	-		v	-							v					v		v	
	n66			v								v					v		v	
E.R.P / E.I.R.P	n2	v	v	v		-	-	-	-	-	v	v	v	v	v	v	v	v	v	v
	n5	v	v	v		-	-	-	-	-	v	v	v	v	v	v	v	v	v	v
	n7	v	v	v	v	v	v				v	v	v	v	v	v	v	v	v	v
	n41	-		v	-	v	v	v	v	v	v	v	v	v	v	v	v	v	v	v
	n66	v	v	v	-	v	v	-	-	-	v	v	v	v	v	v	v	v	v	v
Radiated Spurious Emission	n2	Worst Case																	v	
	n5	Worst Case																	v	
	n7	Worst Case																	v	
	n41	Worst Case																	v	
	n66	Worst Case																	v	
Note	1. The mark "v" means that this configuration is chosen for testing 2. The mark "-" means that this bandwidth is not supported. 3. The device is investigated from 30MHz to 10 times of fundamental signal for radiated spurious emission test under different RB size/offset and modulations in exploratory test. Subsequently, only the worst case emissions are reported. 4. All modulations (BPSK/QPSK/16QAM/64QAM/256QAM) have been tested, and only the worst test results are shown in the report .																			

2.2 Connection Diagram of Test System

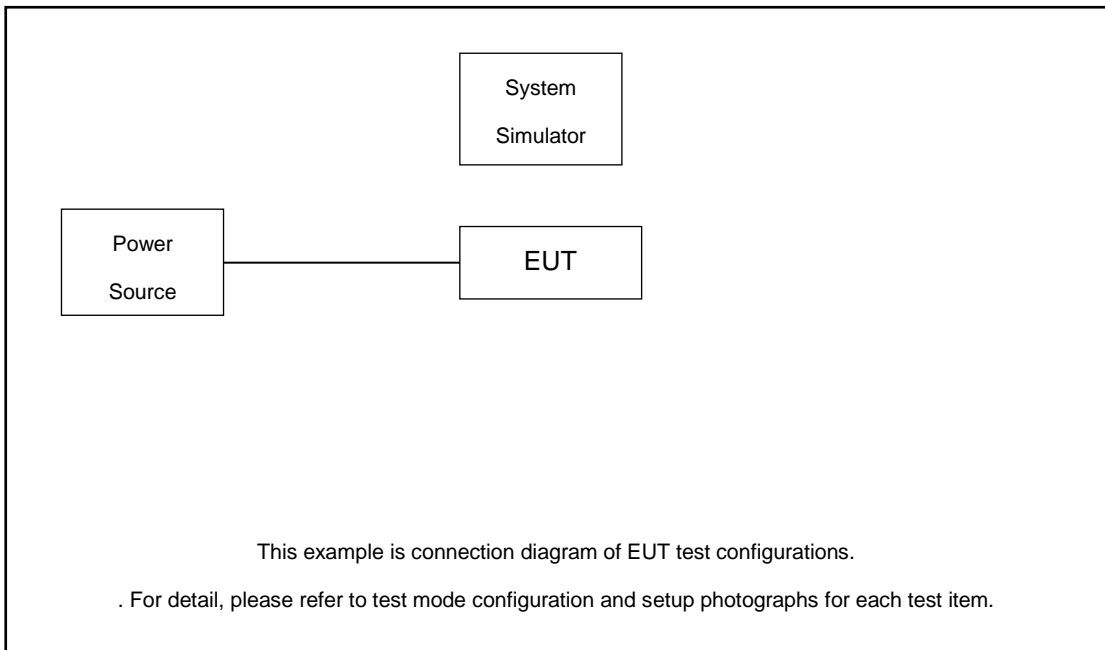

2.3 Support Unit used in test configuration and system

Item	Equipment	Trade Name	Model No.	FCC ID	Data Cable	Power Cord
1.	DC Power Supply	GW	GPS-3030D	N/A	N/A	Unshielded, 1.8 m
2.	LTE Base Station	Anritsu	MT8821C	N/A	N/A	Unshielded, 1.8 m
3.	NR Base Station	Anritsu	MT8000A	N/A	N/A	Unshielded, 1.8 m

2.4 Measurement Results Explanation Example

For all conducted test items:

The offset level is set in the spectrum analyzer to compensate the RF cable loss and attenuator factor between EUT conducted output port and spectrum analyzer. With the offset compensation, the spectrum analyzer reading level is exactly the EUT RF output level.

The spectrum analyzer offset is derived from RF cable loss

$$\text{Offset} = \text{RF cable loss}$$

Following shows an offset computation example with cable loss 9.7 dB.

Example :

$$\begin{aligned} \text{Offset(dB)} &= \text{RF cable loss(dB)}. \\ &= 9.7 \text{ (dB)} \end{aligned}$$



2.5 Frequency List of Low/Middle/High Channels

5G NR n2 Channel and Frequency List				
BW [MHz]	Channel/Frequency(MHz)	Lowest	Middle	Highest
20	Channel	372000	376000	380000
	Frequency	1860	1880	1900
15	Channel	371500	376000	380500
	Frequency	1857.5	1880	1902.5
10	Channel	371000	376000	381000
	Frequency	1855	1880	1905
5	Channel	370500	376000	381500
	Frequency	1852.5	1880	1907.5

5G NR n5 Channel and Frequency List				
BW [MHz]	Channel/Frequency(MHz)	Lowest	Middle	Highest
20	Channel	166800	167300	167800
	Frequency	834	836.5	839
15	Channel	166300	167300	168300
	Frequency	831.5	836.5	841.5
10	Channel	165800	167300	168800
	Frequency	829	836.5	844
5	Channel	165300	167300	169300
	Frequency	826.5	836.5	846.5

5G NR n7 Channel and Frequency List				
BW [MHz]	Channel/Frequency(MHz)	Lowest	Middle	Highest
40	Channel	504000	507000	510000
	Frequency	2520	2535	2550
30	Channel	503000	507000	511000
	Frequency	2515	2535	2555
25	Channel	502500	507000	511500
	Frequency	2512.5	2535	2557.5
20	Channel	502000	507000	512000
	Frequency	2510	2535	2560
15	Channel	501500	507000	512500
	Frequency	2507.5	2535	2562.5
10	Channel	501000	507000	513000
	Frequency	2505	2535	2565
5	Channel	500500	507000	513500
	Frequency	2502.5	2535	2567.5



5G NR n41 Channel and Frequency List				
BW [MHz]	Channel/Frequency(MHz)	Lowest	Middle	Highest
100	Channel	509202	518598	528000
	Frequency	2546.01	2592.99	2640
90	Channel	508200	518598	528996
	Frequency	2541	2592.99	2644.98
80	Channel	507204	518598	529998
	Frequency	2536.02	2592.99	2649.99
70	Channel	506202	518598	531000
	Frequency	2531.01	2592.99	2565
60	Channel	505200	518598	531996
	Frequency	2526	2592.99	2659.98
50	Channel	504204	518598	532998
	Frequency	2521.02	2592.99	2664.99
40	Channel	503202	518598	534000
	Frequency	2516.01	2592.99	2670
30	Channel	502200	518598	534996
	Frequency	2511	2592.99	2674.98
20	Channel	501204	518598	535998
	Frequency	2506.02	2592.99	2679.99

5G NR n66 Channel and Frequency List				
BW [MHz]	Channel/Frequency(MHz)	Lowest	Middle	Highest
40	Channel	346000	349000	352000
	Frequency	1730	1745	1760
30	Channel	345000	349000	353000
	Frequency	1725	1745	1765
20	Channel	344000	349000	354000
	Frequency	1720	1745	1770
15	Channel	343500	349000	354500
	Frequency	1717.5	1745	1772.5
10	Channel	343000	349000	355000
	Frequency	1715	1745	1775
5	Channel	342500	349000	355500
	Frequency	1712.5	1745	1777.5

3 Conducted Test Items

3.1 Measuring Instruments

See list of measuring instruments of this test report.

3.2 Test Setup

3.2.1 Conducted Output Power

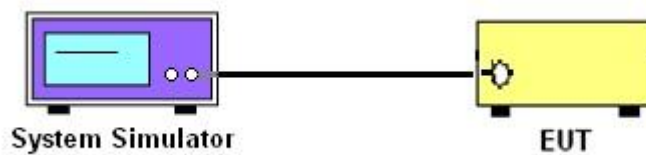

3.2.2 Peak-to-Average Ratio, Occupied Bandwidth ,Conducted Band-Edge and Conducted Spurious Emission

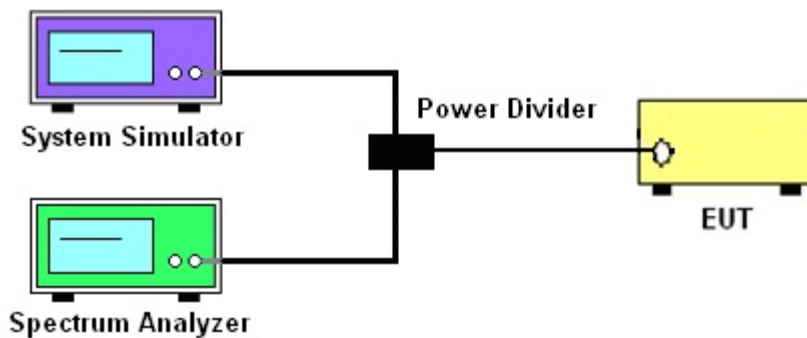

3.2.3 Frequency Stability

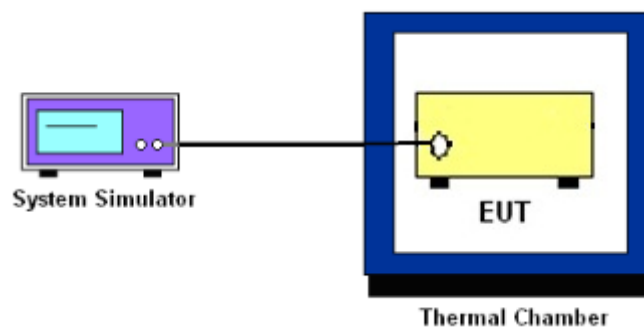

3.3 Test Result of Conducted Test

Please refer to Appendix A.



3.4 Conducted Output Power and ERP/EIRP

3.4.1 Description of the Conducted Output Power Measurement and ERP/EIRP Measurement

A system simulator was used to establish communication with the EUT. Its parameters were set to force the EUT transmitting at maximum output power. The measured power in the radio frequency on the transmitter output terminals shall be reported.

The ERP of mobile transmitters must not exceed 7 Watts for 5G NR n5.

The EIRP of mobile transmitters must not exceed 2 Watts for 5G NR n2 and n7, n41.

The EIRP of mobile transmitters must not exceed 1 Watts for 5G NR n66.

According to KDB 412172 D01 Power Approach,

$EIRP = P_T + G_T - L_C$, $ERP = EIRP - 2.15$, where

P_T = transmitter output power in dBm

G_T = gain of the transmitting antenna in dBi

L_C = signal attenuation in the connecting cable between the transmitter and antenna in dB

3.4.2 Test Procedures

1. The testing follows ANSI C63.26 Section 5.2
2. The transmitter output port was connected to the system simulator.
3. Set EUT at maximum power through the system simulator.
4. Select lowest, middle, and highest channels for each band and different modulation.
5. Measure and record the power level from the system simulator.



3.5 Peak-to-Average Ratio

3.5.1 Description of the PAR Measurement

Power Complementary Cumulative Distribution Function (CCDF) curves provide a means for characterizing the power peaks of a digitally modulated signal on a statistical basis. A CCDF curve depicts the probability of the peak signal amplitude exceeding the average power level. Most contemporary measurement instrumentation include the capability to produce CCDF curves for an input signal provided that the instrument's resolution bandwidth can be set wide enough to accommodate the entire input signal bandwidth. In measuring transmissions in this band using an average power technique, the peak-to-average ratio (PAR) of the transmission may not exceed 13 dB.

3.5.2 Test Procedures

1. The testing follows ANSI C63.26 Section 5.2.3.4 (CCDF).
2. The EUT was connected to spectrum and system simulator via a power divider.
3. Set the CCDF (Complementary Cumulative Distribution Function) option in spectrum analyzer.
4. The highest RF powers were measured and recorded the maximum PAPR level associated with a probability of 0.1 %.
5. Record the deviation as Peak to Average Ratio.

Or

1. The testing follows ANSI C63.26 Section 5.2.6 (PAPR).
2. The EUT was connected to spectrum and system simulator via a power divider.
3. Set EUT in maximum power output.
4. Set the RBW = 1MHz, VBW = 3MHz, Detector = Peak, Trace mode = max hold, Set span $\geq 2 \times$ OBW in spectrum analyzer.
5. Set the RBW = 1MHz, VBW = 3MHz, Detector = power averaging, Trace mode = max hold, Set span $\geq 2 \times$ OBW in spectrum analyzer.
6. Add $[10 \log (1/\text{duty cycle})]$ to the measured maximum power level to compute the average power during continuous transmission.

$$7. \text{ PAPR (dB)} = P_{Pk} \text{ (dBm)} - P_{Avg} \text{ (dBm)}$$

where

PAPR peak-to-average power ratio, in dB

P_{Pk} measured peak power level, in dBm

P_{Avg} measured average power level, in dBm

8. Record the deviation as Peak to Average Ratio.



3.6 Occupied Bandwidth

3.6.1 Description of Occupied Bandwidth Measurement

The occupied bandwidth is the width of a frequency band such that, below the lower and above the upper frequency limits, the mean powers emitted are each equal to a specified percentage 0.5% of the total mean transmitted power.

The 26 dB emission bandwidth is defined as the frequency range between two points, one above and one below the carrier frequency, at which the spectral density of the emission is attenuated 26 dB below the maximum in-band spectral density of the modulated signal. Spectral density (power per unit bandwidth) is to be measured with a detector of resolution bandwidth equal to approximately 1.0% of the emission bandwidth.

3.6.2 Test Procedures

1. The testing follows ANSI C63.26 Section 5.4
2. The EUT was connected to spectrum analyzer and system simulator via a power divider.
3. The spectrum analyzer center frequency is set to the nominal EUT channel center frequency. The span range for the spectrum analyzer shall be between two and five times the anticipated OBW.
4. The nominal resolution bandwidth (RBW) shall be in the range of 1 to 5 % of the anticipated OBW, and the VBW shall be at least 3 times the RBW.
5. Set the detection mode to peak, and the trace mode to max hold.
6. Determine the reference value: Set the EUT to transmit a modulated signal. Allow the trace to stabilize. Set the spectrum analyzer marker to the highest level of the displayed trace.
(this is the reference value)
7. Determine the “-26 dB down amplitude” as equal to (Reference Value – X).
8. Place two markers, one at the lowest and the other at the highest frequency of the envelope of the spectral display such that each marker is at or slightly below the “-X dB down amplitude” determined in step 6. If a marker is below this “-X dB down amplitude” value it shall be placed as close as possible to this value. The OBW is the positive frequency difference between the two markers.
9. Use the 99 % power bandwidth function of the spectrum analyzer and report the measured bandwidth.



3.7 Conducted Band Edge

3.7.1 Description of Conducted Band Edge Measurement

22.917(a)

For operations in the 824 – 849 MHz band, the FCC limit is $43 + 10\log_{10}(P[\text{Watts}])$ dB below the transmitter power $P(\text{Watts})$ in a 100kHz bandwidth. However, in the 1MHz bands immediately outside and adjacent to the licensee's frequency block, a resolution bandwidth of at least one percent of the emission bandwidth of the fundamental emission of the transmitter may be employed.

24.238 (a)

For operations in the 1850-1910 and 1930-1990 MHz band, the FCC limit is $43 + 10\log_{10}(P[\text{Watts}])$ dB below the transmitter power $P(\text{Watts})$ in a 1MHz bandwidth. However, in the 1 MHz bands immediately outside and adjacent to the frequency block a resolution bandwidth of at least one percent of the emission bandwidth of the fundamental emission of the transmitter may be employed.

27.53 (h)

For operations in the 1710 – 1755 MHz and 1710 – 1780 MHz band, the FCC limit is $43 + 10\log_{10}(P[\text{Watts}])$ dB below the transmitter power $P(\text{Watts})$ in a 1 MHz bandwidth. However, in the 1MHz bands immediately outside and adjacent to the licensee's frequency block, a resolution bandwidth of at least one percent of the emission bandwidth of the fundamental emission of the transmitter may be employed.

27.53(m)(4)

For mobile digital stations, the attenuation factor shall be not less than $40 + 10 \log (P)$ dB on all frequencies between the channel edge and 5 megahertz from the channel edge, $43 + 10 \log (P)$ dB on all frequencies between 5 megahertz and X megahertz from the channel edge, and $55 + 10 \log (P)$ dB on all frequencies more than X megahertz from the channel edge, where X is the greater of 6 megahertz or the actual emission bandwidth as defined in paragraph (m)(6) of this section. In addition, the attenuation factor shall not be less that $43 + 10 \log (P)$ dB on all frequencies between 2490.5 MHz and 2496 MHz and $55 + 10 \log (P)$ dB at or below 2490.5 MHz. Mobile Satellite Service licensees operating on frequencies below 2495 MHz may also submit a documented interference complaint against BRS licensees operating on channel BRS Channel 1 on the same terms and conditions as adjacent channel BRS or EBS licensees.



3.7.2 Test Procedures

1. The testing follows ANSI C63.26 section 5.7
2. The EUT was connected to spectrum analyzer and system simulator via a power divider.
3. The band edges of low and high channels for the highest RF powers were measured.
4. Set RBW \geq 1%/2% EBW in the 1MHz band immediately outside and adjacent to the band edge.
5. Beyond the 1 MHz band from the band edge, RBW=1MHz was used.
6. Set spectrum analyzer with RMS detector.
7. The RF fundamental frequency should be excluded against the limit line in the operating frequency band.
8. Offset has included the duty factor for Band n41. Duty factor = $10 \log (1/x)$, where x is the measured duty cycle.
9. Checked that all the results comply with the emission limit line.

Example:

The limit line is derived from $43 + 10\log(P)$ dB below the transmitter power P(Watts)
= $P(W) - [43 + 10\log(P)]$ (dB)
= $[30 + 10\log(P)]$ (dBm) - $[43 + 10\log(P)]$ (dB) = -13dBm.

10. For 5G NR n7/n41, the other 40 dB, and 55 dB have additionally applied same calculation above.
11. When using the integration method, the starting frequency of the integration shall be centered at one-half of the RBW away from the band edge.



3.8 Conducted Spurious Emission

3.8.1 Description of Conducted Spurious Emission Measurement

The power of any emission outside of the authorized operating frequency ranges must be lower than the transmitter power (P) by a factor of at least $43 + 10 \log (P)$ dB.

For 5G NR n7/n41:

The power of any emission outside of the authorized operating frequency ranges must be lower than the transmitter power (P) by a factor of at least $55 + 10 \log (P)$ dB.

It is measured by means of a calibrated spectrum analyzer and scanned from 30 MHz up to a frequency including its 10th harmonic.

3.8.2 Test Procedures

1. The testing follows ANSI C63.26 section 5.7
2. The EUT was connected to spectrum analyzer and system simulator via a power divider.
3. The RF output of EUT was connected to the spectrum analyzer by RF cable and attenuator. The path loss was compensated to the results for each measurement.
4. The middle channel for the highest RF power within the transmitting frequency was measured.
5. The conducted spurious emission for the whole frequency range was taken.
6. Make the measurement with the spectrum analyzer's RBW = 1MHz, VBW = 3MHz.
7. Set spectrum analyzer with RMS detector.
8. Offset has included the duty factor for Band n41. Duty factor = $10 \log (1/x)$, where x is the measured duty cycle.
9. Taking the record of maximum spurious emission.
10. The RF fundamental frequency should be excluded against the limit line in the operating frequency band.
11. The limit line is derived from $43 + 10 \log (P)$ dB below the transmitter power P(Watts)
= $P(W) - [43 + 10 \log (P)]$ (dB)
= $[30 + 10 \log (P)]$ (dBm) - $[43 + 10 \log (P)]$ (dB)
= -13dBm.
12. For 5G NR n7/n41
The limit line is derived from $55 + 10 \log (P)$ dB below the transmitter power P(Watts)
= $P(W) - [55 + 10 \log (P)]$ (dB)
= $[30 + 10 \log (P)]$ (dBm) - $[55 + 10 \log (P)]$ (dB)
= -25dBm.



3.9 Frequency Stability

3.9.1 Description of Frequency Stability Measurement

The frequency stability shall be measured by variation of ambient temperature and variation of primary supply voltage to ensure that the fundamental emission stays within the authorized frequency block. The frequency stability of the transmitter shall be maintained within $\pm 0.00025\%$ ($\pm 2.5\text{ppm}$) of the center frequency.

3.9.2 Test Procedures for Temperature Variation

1. The testing follows ANSI C63.26 section 5.6.4
2. The EUT was set up in the thermal chamber and connected with the system simulator.
3. With power OFF, the temperature was decreased to -30°C and the EUT was stabilized before testing. Power was applied and the maximum change in frequency was recorded within one minute.
4. With power OFF, the temperature was raised in 10°C step up to 50°C . The EUT was stabilized at each step for at least half an hour. Power was applied and the maximum frequency change was recorded within one minute.

3.9.3 Test Procedures for Voltage Variation

1. The testing follows ANSI C63.26 section 5.6.5
2. The EUT was placed in a temperature chamber at $20\pm 5^{\circ}\text{C}$ and connected with the system simulator.
3. The power supply voltage to the EUT was varied from 85% to 115% of the nominal value for other than hand carried battery equipment.
4. For hand carried, battery powered equipment, reduce the primary ac or dc supply voltage to the battery operating end point, which shall be specified by the manufacturer.
5. The variation in frequency was measured for the worst case.

4 Radiated Test Items

4.1 Measuring Instruments

See list of measuring instruments of this test report.

4.2 Test Setup

4.2.1 For radiated test below 30MHz

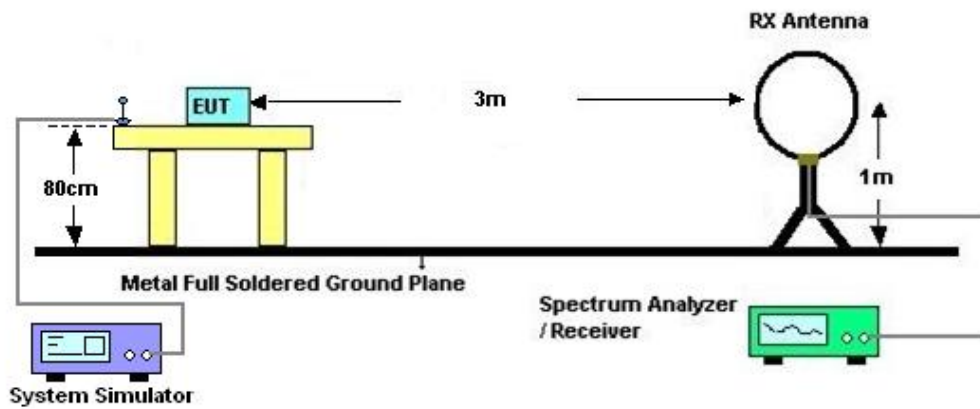

4.2.2 For radiated test from 30MHz to 1GHz

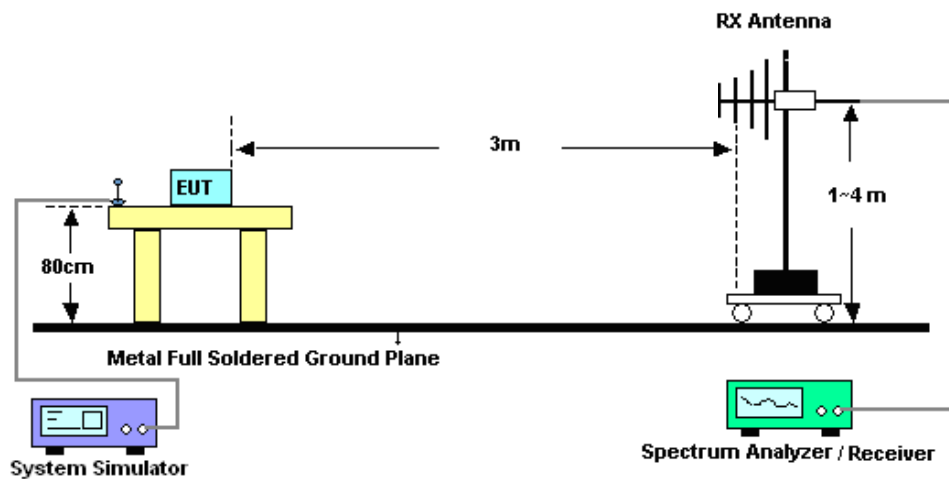

4.2.3 For radiated test above 1GHz

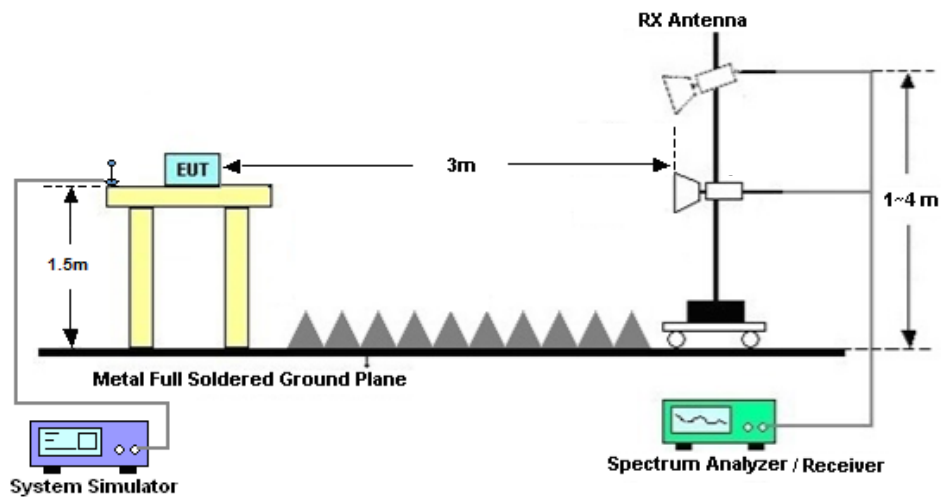

4.3 Test Result of Radiated Test

The low frequency, which started from 9 kHz to 30MHz, was pre-scanned and the result which was 20dB lower than the limit line was not reported.

Please refer to Appendix B.



4.4 Radiated Spurious Emission

4.4.1 Description of Radiated Spurious Emission

The radiated spurious emission was measured by substitution method according to ANSI C63.26. The power of any emission outside of the authorized operating frequency ranges must be attenuated below the transmitter power (P) by a factor of at least $43 + 10 \log (P)$ dB.

For 5G NR n7/n41

The power of any emission outside of the authorized operating frequency ranges must be attenuated below the transmitter power (P) by a factor of at least $55 + 10 \log (P)$ dB.

The spectrum is scanned from 30 MHz up to a frequency including its 10th harmonic.

4.4.2 Test Procedures

1. The testing follows ANSI C63.26 Section 5.5
2. The EUT was placed on a turntable with 0.8 meter height for frequency below 1GHz and 1.5 meter height for frequency above 1GHz respectively above ground.
3. The EUT was set 3 meters from the receiving antenna mounted on the antenna tower.
4. The table was rotated 360 degrees to determine the position of the highest spurious emission.
5. The height of the receiving antenna is varied between 1m to 4m to search the maximum spurious emission for both horizontal and vertical polarizations.
6. During the measurement, the system simulator parameters were set to force the EUT transmitting at maximum output power.
7. Make the measurement with the spectrum analyzer's RBW = 1MHz, VBW = 3MHz, taking the record of maximum spurious emission.
8. A horn antenna was substituted in place of the EUT and was driven by a signal generator.
9. Tune the output power of signal generator to the same emission level with EUT maximum spurious emission.
10. $EIRP \text{ (dBm)} = S.G. \text{ Power} - Tx \text{ Cable Loss} + Tx \text{ Antenna Gain}$
11. $ERP \text{ (dBm)} = EIRP - 2.15$
12. The RF fundamental frequency should be excluded against the limit line in the operating frequency band.

The limit line is derived from $43 + 10\log(P)$ dB below the transmitter power P(Watts)
 $= P(W) - [43 + 10\log(P)] \text{ (dB)}$
 $= [30 + 10\log(P)] \text{ (dBm)} - [43 + 10\log(P)] \text{ (dB)}$
 $= -13\text{dBm}.$

13. For 5G NR n7/n41:

The limit line is derived from $55 + 10\log(P)$ dB below the transmitter power P(Watts)The limit line is derived from $55 + 10\log(P)$ dB below the transmitter power P(Watts)



5 List of Measuring Equipment

Instrument	Manufacturer	Model No.	Serial No.	Characteristics	Calibration Date	Test Date	Due Date	Remark
Spectrum Analyzer	R&S	FSV40	101040	10Hz~40GHz	Oct. 14, 2021	Jun. 07, 2022~ Jul. 12, 2022	Oct. 13, 2022	Conducted (TH01-KS)
Power divider	STI	STI08-0055	-	0.5~40GHz	Aug. 26, 2021	Jun. 07, 2022~ Jul. 12, 2022	Aug. 25, 2022	Conducted (TH01-KS)
Temperature & humidity chamber	Hongzhan	LP-150U	H2014011 440	-40~+150°C 20%~95%RH	Jul. 12, 2021	Jun. 07, 2022~ Jul. 12, 2022	Jul. 11, 2022	Conducted (TH01-KS)
Temperature & humidity chamber	Hongzhan	LP-150U	H2014011 440	-40~+150°C 20%~95%RH	Jul. 11, 2022		Jul. 10, 2023	Conducted (TH01-KS)
EXA Spectrum Analyzer	Keysight	N9010B	MY575410 79	10Hz~44G,MAX 30dB	Oct. 14, 2021	Jun. 10, 2022	Oct. 13, 2022	Radiation (03CH04-KS)
Loop Antenna	R&S	HFH2-Z2	100321	9kHz~30MHz	Oct. 30, 2021	Jun. 10, 2022	Oct. 29, 2022	Radiation (03CH04-KS)
Bilog Antenna	TeseQ	CBL6111D	49922	30MHz-1GHz	May 24, 2022	Jun. 10, 2022	May 23, 2023	Radiation (03CH04-KS)
Horn Antenna	Schwarzbeck	BBHA9120D	1284	1GHz~18GHz	Jan. 05, 2022	Jun. 10, 2022	Jan. 04, 2023	Radiation (03CH04-KS)
SHF-EHF Horn	Com-power	AH-840	101070	18GHz~40GHz	Jan. 05, 2022	Jun. 10, 2022	Jan. 04, 2023	Radiation (03CH04-KS)
Amplifier	SONOMA	310N	187289	9KHz-1GHz	Jan. 05, 2022	Jun. 10, 2022	Jan. 04, 2023	Radiation (03CH04-KS)
Amplifier	MITEQ	EM18G40GG A	060728	18~40GHz	Jan. 05, 2022	Jun. 10, 2022	Jan. 04, 2023	Radiation (03CH04-KS)
high gain Amplifier	MITEQ	AMF-7D-0010 1800-30-10P	2025788	1Ghz-18Ghz	Jul. 30, 2021	Jun. 10, 2022	Jul. 29, 2022	Radiation (03CH04-KS)
Amplifier	Keysight	83017A	MY572801 06	500MHz~26.5G Hz	Oct. 13, 2021	Jun. 10, 2022	Oct. 12, 2022	Radiation (03CH04-KS)
AC Power Source	Chroma	61601	F1040900 04	N/A	NCR	Jun. 10, 2022	NCR	Radiation (03CH04-KS)
Turn Table	ChamPro	EM 1000-T	060762-T	0~360 degree	NCR	Jun. 10, 2022	NCR	Radiation (03CH04-KS)
Antenna Mast	ChamPro	EM 1000-A	060762-A	1 m~4 m	NCR	Jun. 10, 2022	NCR	Radiation (03CH04-KS)

NCR: No Calibration Required



6 Uncertainty of Evaluation

The measurement uncertainties shown below were calculated in accordance with the requirements of ANSI 63.26-2015. All the measurement uncertainty value were shown with a coverage K=2 to indicate 95% level of confidence. The measurement data show herein meets or exceeds the CISPR measurement uncertainty values specified in CISPR 16-4-2 and can be compared directly to specified limit to determine compliance.

Uncertainty of Radiated Emission Measurement (30 MHz ~ 1000 MHz)

Measuring Uncertainty for a Level of Confidence of 95% (U = 2Uc(y))	3.3dB
---	-------

Uncertainty of Radiated Emission Measurement (1 GHz ~ 18 GHz)

Measuring Uncertainty for a Level of Confidence of 95% (U = 2Uc(y))	2.8dB
---	-------

Uncertainty of Radiated Emission Measurement (18 GHz ~ 40 GHz)

Measuring Uncertainty for a Level of Confidence of 95% (U = 2Uc(y))	2.8dB
---	-------

----- THE END -----



Appendix A. Test Results of Conducted Test

Test Engineer :	Lex Wu	Temperature :	22~23°C
		Relative Humidity :	40~42%

Conducted Output Power(Average power and EIRP)

EN DC_7A-n2A (Other PA):

BW [MHz]	Modulation	RB Size	RB Offset	Power Low Ch. / Freq.	Power Middle Ch. / Freq.	Power High Ch. / Freq.	Gain	EIRP	EIRP	EIRP
				372000	376000	380000		L	M	H
Channel				372000	376000	380000				
Frequency (MHz)				1860	1880	1900				
20	PI/2 BPSK	1	1	22.88	22.89	23.24	-1.6	0.1343	0.1346	0.1459
20	QPSK	1	1	22.81	22.80	23.19	-1.6	0.1321	0.1318	0.1442
20	QPSK	1	53	22.86	22.81	23.10	-1.6	0.1337	0.1321	0.1413
20	QPSK	1	104	22.91	22.66	23.02	-1.6	0.1352	0.1276	0.1387
20	QPSK	50	0	22.95	22.96	23.26	-1.6	0.1365	0.1368	0.1466
20	QPSK	50	28	22.94	22.98	23.27	-1.6	0.1361	0.1374	0.1469
20	QPSK	50	56	22.96	22.99	23.29	-1.6	0.1368	0.1377	0.1476
20	QPSK	100	0	22.98	23.03	23.24	-1.6	0.1374	0.1390	0.1459
20	16QAM	1	1	22.91	22.95	23.48	-1.6	0.1352	0.1365	0.1542
20	64QAM	1	1	21.47	21.48	21.84	-1.6	0.0971	0.0973	0.1057
20	256QAM	1	1	19.37	19.17	19.76	-1.6	0.0598	0.0571	0.0655
Channel				371500	376000	380500	Gain	EIRP	EIRP	EIRP
Frequency (MHz)				1857.5	1880	1902.5				
15	QPSK	1	1	22.87	22.92	23.05	-1.6	0.1340	0.1355	0.1396
15	16QAM	1	1	23.09	23.24	23.41	-1.6	0.1409	0.1459	0.1517
Channel				371000	376000	381000	Gain	EIRP	EIRP	EIRP
Frequency (MHz)				1855	1880	1905				
10	QPSK	1	1	22.74	22.89	22.62	-1.6	0.1300	0.1346	0.1265
10	16QAM	1	1	23.02	23.21	22.91	-1.6	0.1387	0.1449	0.1352
Channel				370500	376000	381500	Gain	EIRP	EIRP	EIRP
Frequency (MHz)				1852.5	1880	1907.5				
5	QPSK	1	1	22.76	22.81	22.62	-1.6	0.1306	0.1321	0.1265
5	16QAM	1	1	22.98	23.15	22.94	-1.6	0.1374	0.1429	0.1361



5G NR n5(Other PA):

BW [MHz]	Modulation	RB Size	RB Offset	Power Low Ch. / Freq.	Power Middle Ch. / Freq.	Power High Ch. / Freq.	Gain	ERP	ERP	ERP
Channel				166800	167300	167800		L	M	H
Frequency (MHz)				834	836.5	839				
20	PI/2 BPSK	1	1	23.25	23.15	22.99	-4.9	0.0417	0.0407	0.0393
20	QPSK	1	1	23.06	23.08	22.94	-4.9	0.0399	0.0401	0.0388
20	QPSK	1	53	22.79	22.73	22.71	-4.9	0.0375	0.0370	0.0368
20	QPSK	1	104	22.44	22.40	22.35	-4.9	0.0346	0.0343	0.0339
20	QPSK	50	0	23.13	23.11	22.96	-4.9	0.0406	0.0404	0.0390
20	QPSK	50	28	22.91	22.95	22.83	-4.9	0.0385	0.0389	0.0378
20	QPSK	50	56	22.76	22.72	22.69	-4.9	0.0372	0.0369	0.0366
20	QPSK	100	0	22.94	22.95	22.81	-4.9	0.0388	0.0389	0.0377
20	16QAM	1	1	23.48	23.41	23.35	-4.9	0.0440	0.0433	0.0427
20	64QAM	1	1	21.65	21.63	21.44	-4.9	0.0288	0.0287	0.0275
20	256QAM	1	1	19.61	19.59	19.47	-4.9	0.0180	0.0179	0.0175
Channel				166300	167300	168300	Gain	ERP	ERP	ERP
Frequency (MHz)				831.5	836.5	841.5				
15	QPSK	1	1	23.19	22.98	22.81	-4.9	0.0411	0.0392	0.0377
15	16QAM	1	1	23.35	23.33	23.05	-4.9	0.0427	0.0425	0.0398
Channel				165800	167300	168800	Gain	ERP	ERP	ERP
Frequency (MHz)				829	836.5	844				
10	QPSK	1	1	23.14	22.78	22.54	-4.9	0.0406	0.0374	0.0354
10	16QAM	1	1	23.34	23.16	22.83	-4.9	0.0426	0.0408	0.0378
Channel				165300	167300	169300	Gain	ERP	ERP	ERP
Frequency (MHz)				826.5	836.5	846.5				
5	QPSK	1	1	23.18	22.76	22.45	-4.9	0.0410	0.0372	0.0347
5	16QAM	1	1	23.44	23.06	22.78	-4.9	0.0436	0.0399	0.0374



EN DC_66A-n7A (Other PA):

BW [MHz]	Modulation	RB Size	RB Offset	Power Low Ch. / Freq.	Power Middle Ch. / Freq.	Power High Ch. / Freq.	Gain	EIRP	EIRP	EIRP
Channel				504000	507000	510000				
Frequency (MHz)				2520	2535	2550		L	M	H
40	PI/2 BPSK	1	1	23.21	23.31	23.43	-3.80	0.0873	0.0893	0.0918
40	QPSK	1	1	23.07	23.17	23.37	-3.80	0.0845	0.0865	0.0906
40	QPSK	1	108	23.31	23.34	23.36	-3.80	0.0893	0.0899	0.0904
40	QPSK	1	215	23.05	23.01	23.02	-3.80	0.0841	0.0834	0.0836
40	QPSK	108	0	23.26	23.11	23.33	-3.80	0.0883	0.0853	0.0897
40	QPSK	108	54	23.49	23.45	23.62	-3.80	0.0931	0.0923	0.0959
40	QPSK	108	108	23.38	23.19	23.35	-3.80	0.0908	0.0869	0.0902
40	QPSK	216	0	23.21	23.16	23.27	-3.80	0.0873	0.0863	0.0885
40	16QAM	1	1	23.22	23.28	23.51	-3.80	0.0875	0.0887	0.0935
40	64QAM	1	1	21.47	21.40	21.64	-3.80	0.0585	0.0575	0.0608
40	256QAM	1	1	19.41	19.33	19.58	-3.80	0.0364	0.0357	0.0378
Channel				503000	507000	511000	Gain	EIRP	EIRP	EIRP
Frequency (MHz)				2515	2535	2555				
30	QPSK	1	1	23.10	23.24	23.22	-3.80	0.0851	0.0879	0.0875
30	16QAM	1	1	22.98	23.16	23.14	-3.80	0.0828	0.0863	0.0859
Channel				502500	507000	511500	Gain	EIRP	EIRP	EIRP
Frequency (MHz)				2512.5	2535	2557.5				
25	QPSK	1	1	23.51	23.45	23.56	-3.80	0.0935	0.0923	0.0946
25	16QAM	1	1	23.31	23.23	23.35	-3.80	0.0893	0.0877	0.0902
Channel				502000	507000	512000	Gain	EIRP	EIRP	EIRP
Frequency (MHz)				2510	2535	2560				
20	QPSK	1	1	23.31	23.26	23.42	-3.80	0.0893	0.0883	0.0916
20	16QAM	1	1	23.24	23.21	23.29	-3.80	0.0879	0.0873	0.0889
Channel				501500	507000	512500	Gain	EIRP	EIRP	EIRP
Frequency (MHz)				2507.5	2535	2562.5				
15	QPSK	1	1	23.08	23.32	23.42	-3.80	0.0847	0.0895	0.0916
15	16QAM	1	1	23.12	23.29	23.47	-3.80	0.0855	0.0889	0.0927
Channel				501000	507000	513000	Gain	EIRP	EIRP	EIRP
Frequency (MHz)				2505	2535	2565				
10	QPSK	1	1	22.80	22.99	22.96	-3.80	0.0794	0.0830	0.0824
10	16QAM	1	1	22.94	23.12	23.05	-3.80	0.0820	0.0855	0.0841
Channel				500500	507000	513500	Gain	EIRP	EIRP	EIRP
Frequency (MHz)				2502.5	2535	2567.5				
5	QPSK	1	1	23.02	23.04	22.99	-3.80	0.0836	0.0839	0.0830
5	16QAM	1	1	23.14	23.12	23.14	-3.80	0.0859	0.0855	0.0859



5G NR n41:

BW [MHz]	Modulation	RB Size	RB Offset	Power Low Ch. / Freq.	Power Middle Ch. / Freq.	Power High Ch. / Freq.	Gain	EIRP	EIRP	EIRP
Channel				509202	518598	528000				
Frequency (MHz)				2546.01	2592.99	2640		L	M	H
100	PI/2 BPSK	1	1	23.44	26.52	26.48	-3.60	0.0964	0.1959	0.1941
100	QPSK	1	1	26.01	26.06	26.07	-3.60	0.1742	0.1762	0.1766
100	QPSK	1	137	25.54	26.20	26.02	-3.60	0.1563	0.1820	0.1746
100	QPSK	1	271	26.04	26.06	25.87	-3.60	0.1754	0.1762	0.1687
100	QPSK	135	0	24.76	25.20	25.16	-3.60	0.1306	0.1445	0.1432
100	QPSK	135	69	25.73	26.27	26.21	-3.60	0.1633	0.1849	0.1824
100	QPSK	135	138	24.94	25.17	25.08	-3.60	0.1361	0.1435	0.1406
100	QPSK	270	0	24.75	25.16	25.15	-3.60	0.1303	0.1432	0.1429
100	16QAM	1	1	25.02	25.58	25.62	-3.60	0.1387	0.1578	0.1592
100	64QAM	1	1	22.69	23.13	23.10	-3.60	0.0811	0.0897	0.0891
100	256QAM	1	1	21.03	21.41	21.48	-3.60	0.0553	0.0604	0.0614
Channel				508200	518598	528996	Gain	EIRP	EIRP	EIRP
Frequency (MHz)				2541	2592.99	2644.98				
90	QPSK	1	1	25.67	26.15	26.07	-3.60	0.1611	0.1799	0.1766
90	16QAM	1	1	24.72	25.55	25.30	-3.60	0.1294	0.1567	0.1479
Channel				507204	518598	529998	Gain	EIRP	EIRP	EIRP
Frequency (MHz)				2536.02	2592.99	2649.99				
80	QPSK	1	1	26.11	26.21	26.01	-3.60	0.1782	0.1824	0.1742
80	16QAM	1	1	25.41	25.23	25.33	-3.60	0.1517	0.1455	0.1489
Channel				506202	518598	531000	Gain	EIRP	EIRP	EIRP
Frequency (MHz)				2531.01	2592.99	2565				
70	QPSK	1	1	25.78	26.11	26.01	-3.60	0.1652	0.1782	0.1742
70	16QAM	1	1	24.80	25.16	25.12	-3.60	0.1318	0.1432	0.1419
Channel				505200	518598	531996	Gain	EIRP	EIRP	EIRP
Frequency (MHz)				2526	2592.99	2659.98				
60	QPSK	1	1	25.82	26.35	26.32	-3.60	0.1667	0.1884	0.1871
60	16QAM	1	1	24.93	25.40	25.33	-3.60	0.1358	0.1514	0.1489
Channel				504204	518598	532998	Gain	EIRP	EIRP	EIRP
Frequency (MHz)				2521.02	2592.99	2664.99				
50	QPSK	1	1	25.98	26.27	26.34	-3.60	0.1730	0.1849	0.1879
50	16QAM	1	1	25.05	25.45	25.43	-3.60	0.1396	0.1531	0.1524
Channel				503202	518598	534000	Gain	EIRP	EIRP	EIRP
Frequency (MHz)				2516.01	2592.99	2670				
40	QPSK	1	1	26.23	26.47	26.33	-3.60	0.1832	0.1936	0.1875
40	16QAM	1	1	25.41	25.49	25.34	-3.60	0.1517	0.1545	0.1493
Channel				502200	518598	534996	Gain	EIRP	EIRP	EIRP
Frequency (MHz)				2511	2592.99	2674.98				
30	QPSK	1	1	26.09	26.45	26.39	-3.60	0.1774	0.1928	0.1901
30	16QAM	1	1	25.15	25.52	25.58	-3.60	0.1429	0.1556	0.1578
Channel				501204	518598	535998	Gain	EIRP	EIRP	EIRP
Frequency (MHz)				2506.02	2592.99	2679.99				
20	QPSK	1	1	26.01	26.47	26.25	-3.60	0.1742	0.1936	0.1841
20	16QAM	1	1	24.93	25.45	25.38	-3.60	0.1358	0.1531	0.1507



5G NR n41 UL MIMO:

BW [MHz]	Modulation	RB Size	RB Offset	Power Low Ch. / Freq.	Power Middle Ch. / Freq.	Power High Ch. / Freq.	Gain	EIRP	EIRP	EIRP
Channel				509202	518598	528000				
Frequency (MHz)				2546.01	2592.99	2640		L	M	H
100	QPSK	1	1	25.25	25.41	25.28	0.19	0.3499	0.3631	0.3524
100	QPSK	1	137	25.01	25.02	24.93	0.19	0.3311	0.3319	0.3251
100	QPSK	1	271	25.19	24.86	24.71	0.19	0.3451	0.3199	0.3090
100	QPSK	135	0	23.66	23.76	23.69	0.19	0.2427	0.2483	0.2443
100	QPSK	135	69	25.14	25.21	25.00	0.19	0.3412	0.3467	0.3304
100	QPSK	135	138	23.74	23.62	23.46	0.19	0.2472	0.2404	0.2317
100	QPSK	270	0	23.67	23.76	23.48	0.19	0.2432	0.2483	0.2328
100	16QAM	1	1	24.70	25.02	24.85	0.19	0.3083	0.3319	0.3192
100	64QAM	1	1	22.95	23.12	23.01	0.19	0.2061	0.2143	0.2089
100	256QAM	1	1	20.11	20.22	20.12	0.19	0.1072	0.1099	0.1074
Channel				508200	518598	528996	Gain	EIRP	EIRP	EIRP
Frequency (MHz)				2541	2592.99	2644.98				
90	QPSK	1	1	25.01	25.22	25.17	0.19	0.3311	0.3475	0.3436
90	16QAM	1	1	24.77	24.84	24.88	0.19	0.3133	0.3184	0.3214
Channel				507204	518598	529998	Gain	EIRP	EIRP	EIRP
Frequency (MHz)				2536.02	2592.99	2649.99				
80	QPSK	1	1	24.98	25.22	25.14	0.19	0.3289	0.3475	0.3412
80	16QAM	1	1	24.68	24.85	24.77	0.19	0.3069	0.3192	0.3133
Channel				506202	518598	531000	Gain	EIRP	EIRP	EIRP
Frequency (MHz)				2531.01	2592.99	2565				
70	QPSK	1	1	25.10	25.30	25.05	0.19	0.3381	0.3540	0.3342
70	16QAM	1	1	24.71	24.86	24.61	0.19	0.3090	0.3199	0.3020
Channel				505200	518598	531996	Gain	EIRP	EIRP	EIRP
Frequency (MHz)				2526	2592.99	2659.98				
60	QPSK	1	1	25.16	25.36	25.31	0.19	0.3428	0.3589	0.3548
60	16QAM	1	1	24.69	24.95	24.98	0.19	0.3076	0.3266	0.3289
Channel				504204	518598	532998	Gain	EIRP	EIRP	EIRP
Frequency (MHz)				2521.02	2592.99	2664.99				
50	QPSK	1	1	25.36	25.31	25.41	0.19	0.3589	0.3548	0.3631
50	16QAM	1	1	25.01	24.98	24.93	0.19	0.3311	0.3289	0.3251
Channel				503202	518598	534000	Gain	EIRP	EIRP	EIRP
Frequency (MHz)				2516.01	2592.99	2670				
40	QPSK	1	1	25.27	25.33	25.30	0.19	0.3516	0.3565	0.3540
40	16QAM	1	1	24.94	24.95	24.92	0.19	0.3258	0.3266	0.3243
Channel				502200	518598	534996	Gain	EIRP	EIRP	EIRP
Frequency (MHz)				2511	2592.99	2674.98				
30	QPSK	1	1	25.21	25.31	25.26	0.19	0.3467	0.3548	0.3508
30	16QAM	1	1	24.81	24.88	24.78	0.19	0.3162	0.3214	0.3141
Channel				501204	518598	535998	Gain	EIRP	EIRP	EIRP
Frequency (MHz)				2506.02	2592.99	2679.99				
20	QPSK	1	1	25.14	25.35	25.05	0.19	0.3412	0.3581	0.3342
20	16QAM	1	1	24.70	24.89	24.70	0.19	0.3083	0.3221	0.3083



EN DC_2A-n66A:

BW [MHz]	Modulation	RB Size	RB Offset	Power Low Ch. / Freq.	Power Middle Ch. / Freq.	Power High Ch. / Freq.	Gain	EIRP	EIRP	EIRP
Channel				346000	349000	352000		L	M	H
Frequency (MHz)				1730	1745	1760				
40	PI/2 BPSK	1	1	22.79	22.85	23.06	-2.30	0.1119	0.1135	0.1191
40	QPSK	1	1	22.70	22.75	23.01	-2.30	0.1096	0.1109	0.1178
40	QPSK	1	108	22.87	22.92	22.87	-2.30	0.1140	0.1153	0.1140
40	QPSK	1	214	22.83	22.82	22.76	-2.30	0.1130	0.1127	0.1112
40	QPSK	108	0	22.92	23.01	23.00	-2.30	0.1153	0.1178	0.1175
40	QPSK	108	54	22.99	23.10	22.96	-2.30	0.1172	0.1202	0.1164
40	QPSK	108	108	23.12	23.04	23.02	-2.30	0.1208	0.1186	0.1180
40	QPSK	216	0	23.02	23.08	23.04	-2.30	0.1180	0.1197	0.1186
40	16QAM	1	1	23.01	23.03	23.15	-2.30	0.1178	0.1183	0.1216
40	64QAM	1	1	21.48	21.45	21.61	-2.30	0.0828	0.0822	0.0853
40	256QAM	1	1	19.22	19.37	19.46	-2.30	0.0492	0.0509	0.0520
Channel				345000	349000	353000	Gain	EIRP	EIRP	EIRP
Frequency (MHz)				1725	1745	1765				
30	QPSK	1	1	22.89	22.83	22.97	-2.30	0.1146	0.1130	0.1167
30	16QAM	1	1	23.01	23.06	22.98	-2.30	0.1178	0.1191	0.1169
Channel				344000	349000	354000	Gain	EIRP	EIRP	EIRP
Frequency (MHz)				1720	1745	1770				
20	QPSK	1	1	22.98	22.95	22.79	-2.30	0.1169	0.1161	0.1119
20	16QAM	1	1	23.06	23.12	23.10	-2.30	0.1191	0.1208	0.1202
Channel				343500	349000	354500	Gain	EIRP	EIRP	EIRP
Frequency (MHz)				1717.5	1745	1772.5				
15	QPSK	1	1	22.90	23.01	22.85	-2.30	0.1148	0.1178	0.1135
15	16QAM	1	1	23.08	23.08	23.08	-2.30	0.1197	0.1197	0.1197
Channel				343000	349000	355000	Gain	EIRP	EIRP	EIRP
Frequency (MHz)				1715	1745	1775				
10	QPSK	1	1	22.80	22.94	22.80	-2.30	0.1122	0.1159	0.1122
10	16QAM	1	1	23.02	23.11	23.04	-2.30	0.1180	0.1205	0.1186
Channel				342500	349000	355500	Gain	EIRP	EIRP	EIRP
Frequency (MHz)				1712.5	1745	1777.5				
5	QPSK	1	1	22.67	22.86	22.73	-2.30	0.1089	0.1138	0.1104
5	16QAM	1	1	23.02	23.11	23.02	-2.30	0.1180	0.1205	0.1180



FR1 n2

Peak-to-Average Ratio

Mode	FR1 n2 / 20MHz / DFT-S OFDM				
Mod.	PI/2 BPSK	QPSK			Limit: 13dB
RB Size	Full RB	Full RB			Result
Middle CH	3.45	4.12			PASS

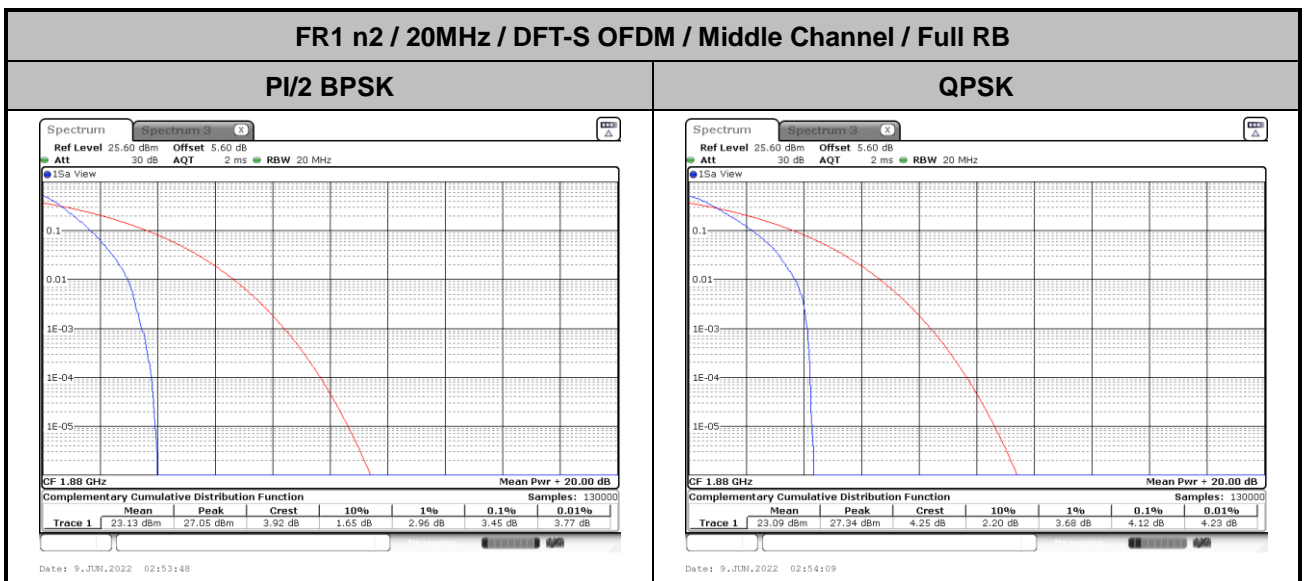



26dB Bandwidth

Mode	FR1 n2 : 26dBW (MHz) / DFT OFDM							
BW	5MHz		10MHz		15MHz		20MHz	
Mod.	QPSK		QPSK		QPSK		QPSK	
Middle CH	5.07		10.37		15.02		21.38	
Mod.	16QAM	64QAM	16QAM	64QAM	16QAM	64QAM	16QAM	64QAM
Middle CH	5.09	5.24	10.27	10.13	15.11	15.14	22.34	21.42
Mod.	256QAM		256QAM		256QAM		256QAM	
Middle CH	5.23		10.09		14.87		21.22	



FR1 n2 / 5MHz / CP OFDM / Middle Channel / Full RB

QPSK

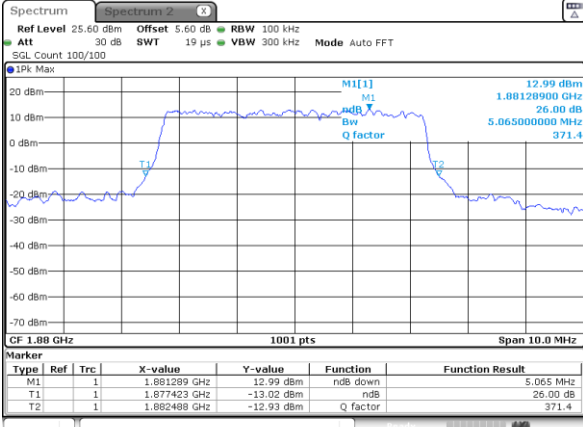

Date: 11 JUN 2022 00:01:09

16QAM

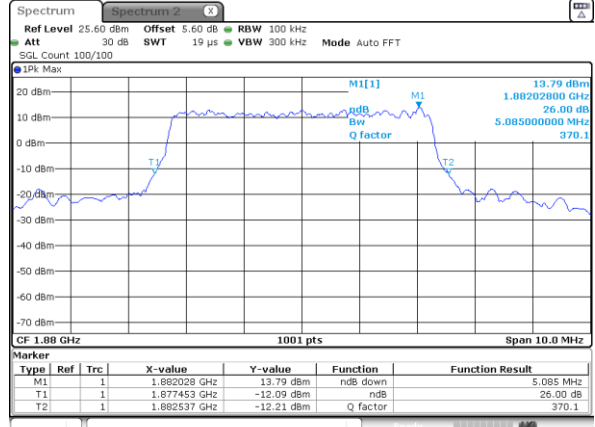

Date: 11 JUN 2022 00:01:39

64QAM

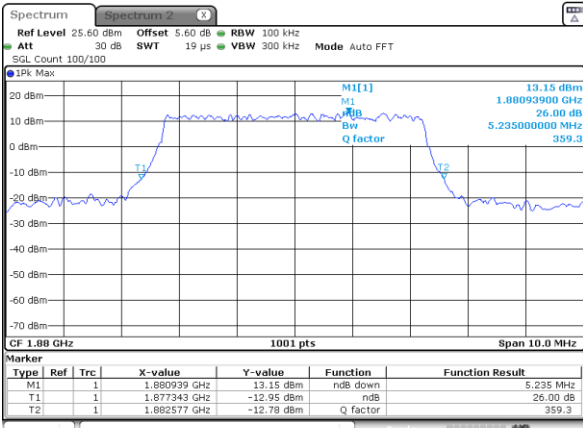

Date: 11 JUN 2022 00:01:58

256QAM

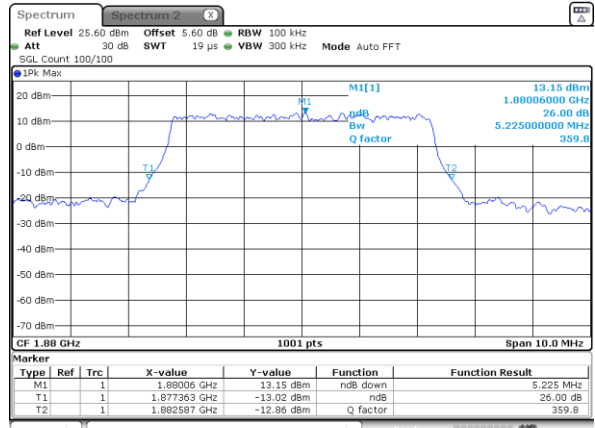

Date: 11 JUN 2022 00:02:17



FR1 n2 / 10MHz / CP OFDM / Middle Channel / Full RB

QPSK

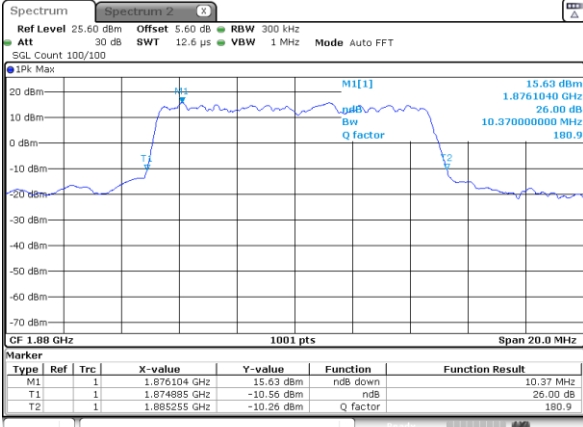

Date: 11.JUN.2022 00:03:56

16QAM

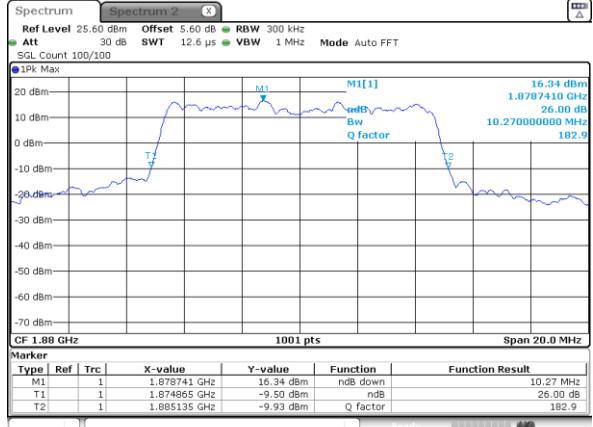

Date: 11.JUN.2022 00:04:17

64QAM

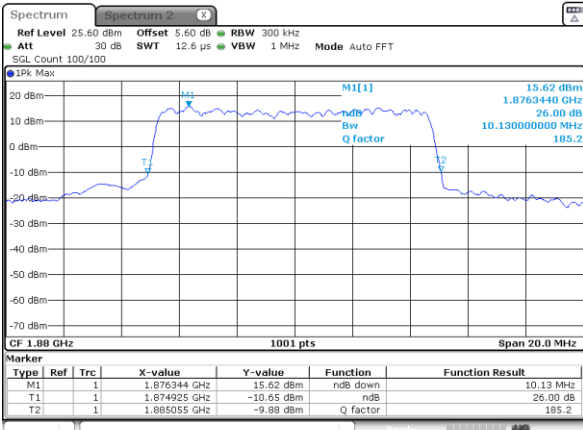

Date: 11.JUN.2022 00:04:50

256QAM

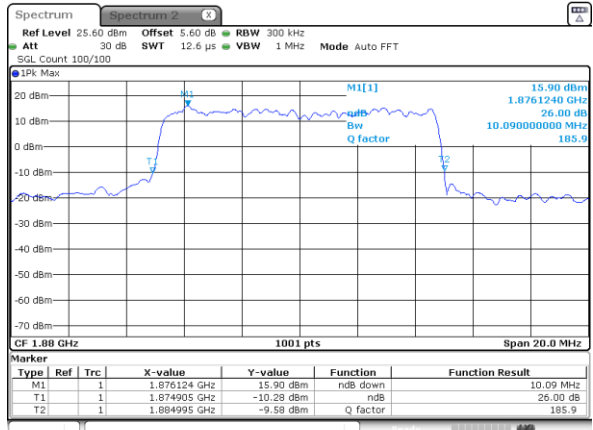

Date: 11.JUN.2022 00:05:07



FR1 n2 / 15MHz / CP OFDM / Middle Channel / Full RB

QPSK

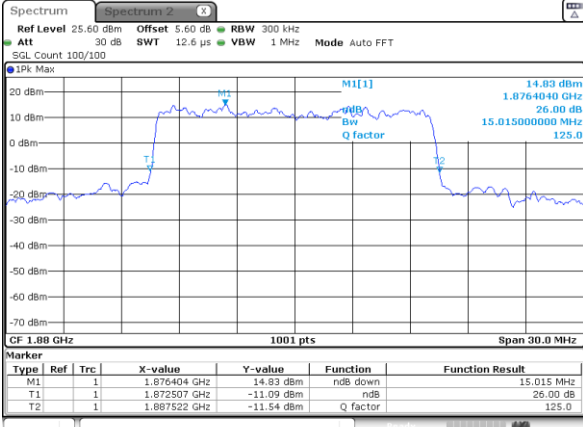

Date: 11.JUN.2022 00:07:14

16QAM

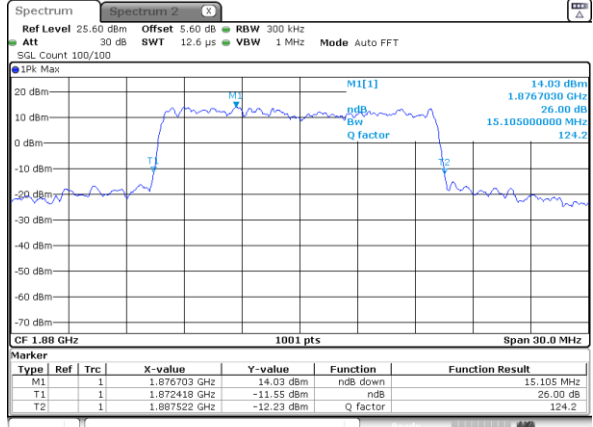

Date: 11.JUN.2022 00:07:35

64QAM

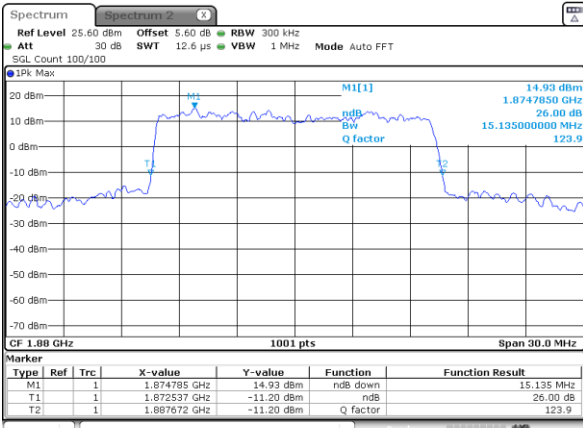

Date: 11.JUN.2022 00:07:56

256QAM

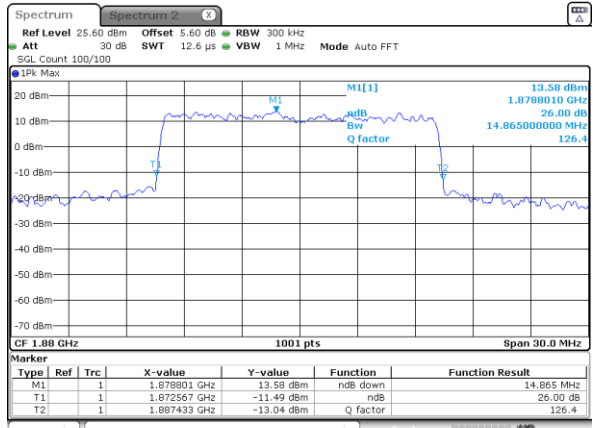

Date: 11.JUN.2022 00:08:13



FR1 n2 / 20MHz / DFT-S OFDM / Middle Channel / Full RB

QPSK

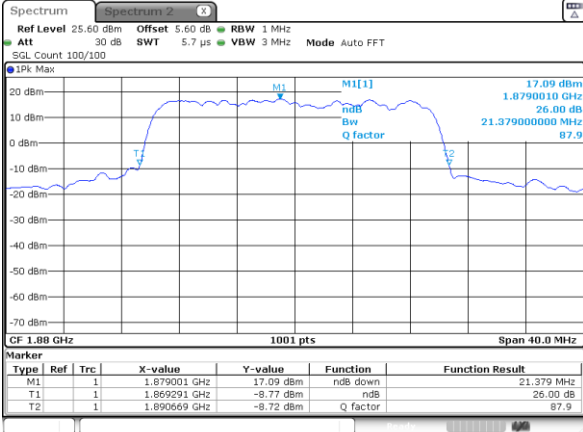

Date: 11.JUN.2022 00:09:14

16QAM

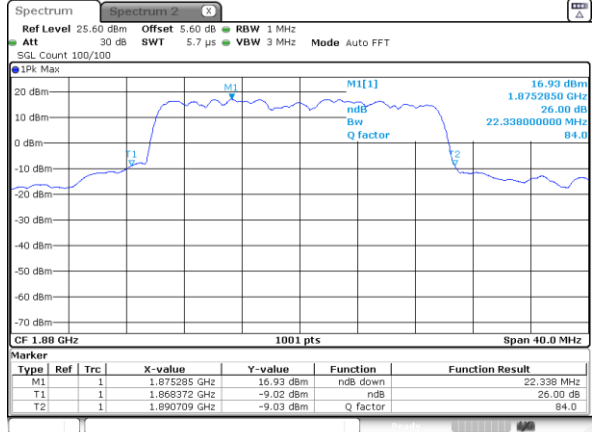

Date: 11.JUN.2022 00:09:17

64QAM

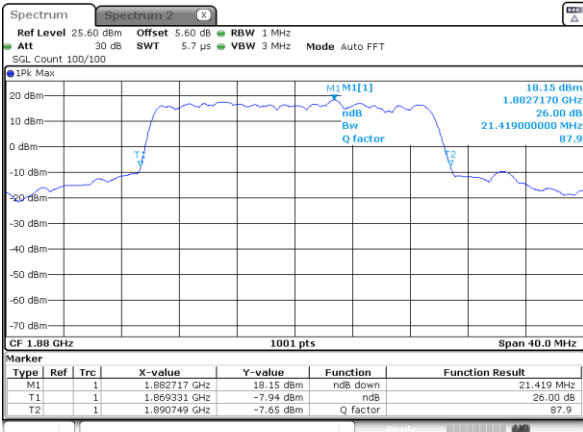

Date: 11.JUN.2022 00:08:58

256QAM

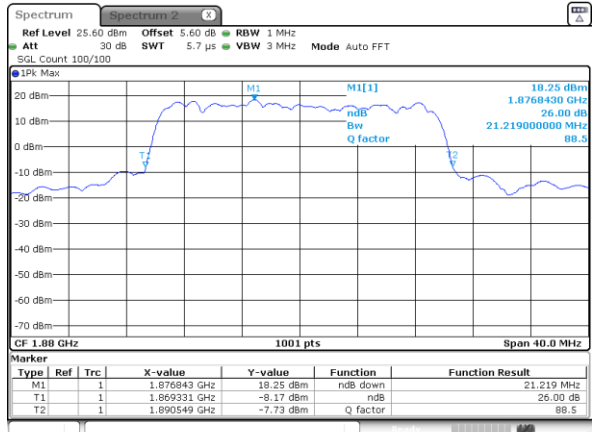

Date: 11.JUN.2022 00:08:38



Occupied Bandwidth

Mode	FR1 n2 : 99%OBW (MHz) / CP OFDM							
BW	5MHz		10MHz		15MHz		20MHz	
Mod.	QPSK		QPSK		QPSK		QPSK	
Middle CH	4.49		9.51		14.18		19.50	
Mod.	16QAM	64QAM	16QAM	64QAM	16QAM	64QAM	16QAM	64QAM
Middle CH	4.50	4.50	9.43	9.39	14.15	14.15	19.54	19.38
Mod.	256QAM		256QAM		256QAM		256QAM	
Middle CH	4.51		9.45		14.18		19.50	



FR1 n2 / 5MHz / CP OFDM / Middle Channel / Full RB

QPSK

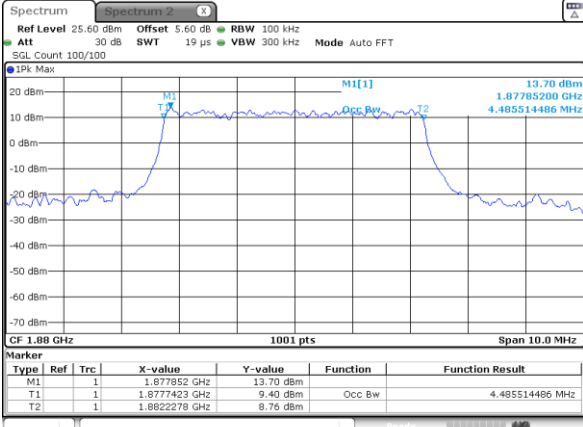

Date: 10 JUN 2022 23:59:53

16QAM

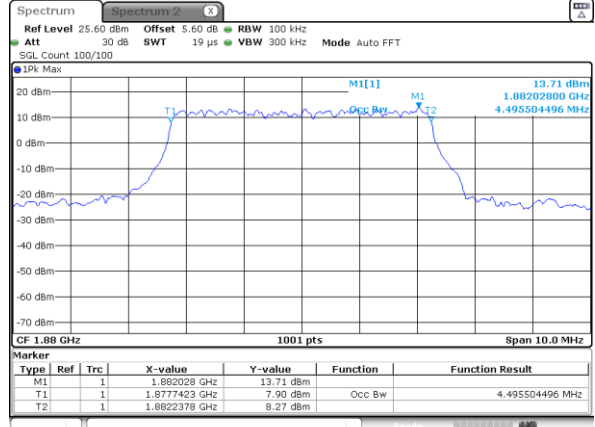

Date: 11 JUN 2022 00:01:46

64QAM

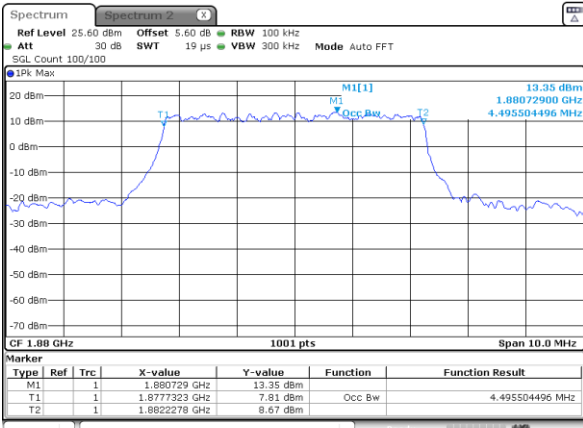

Date: 11 JUN 2022 00:02:04

256QAM

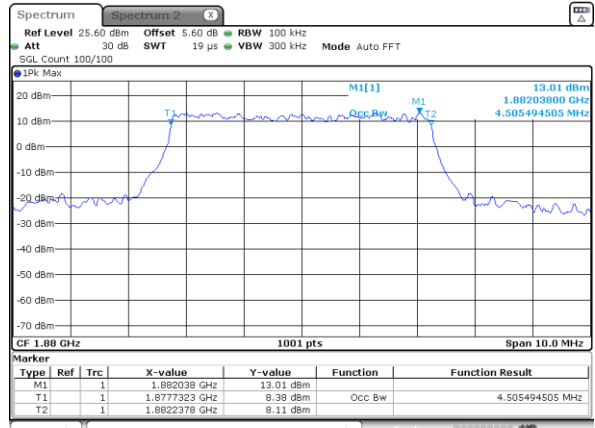

Date: 11 JUN 2022 00:02:38



FR1 n2 / 10MHz / CP OFDM / Middle Channel / Full RB

QPSK

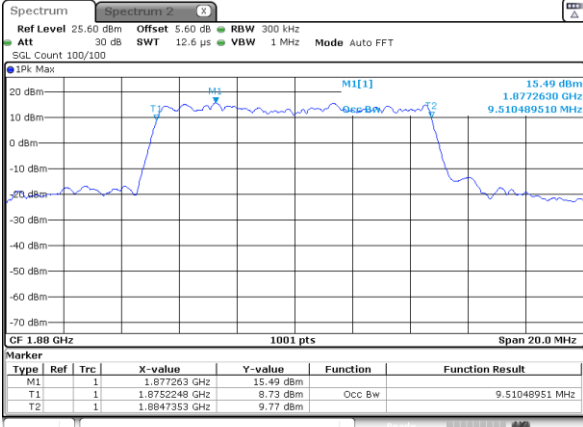

16QAM

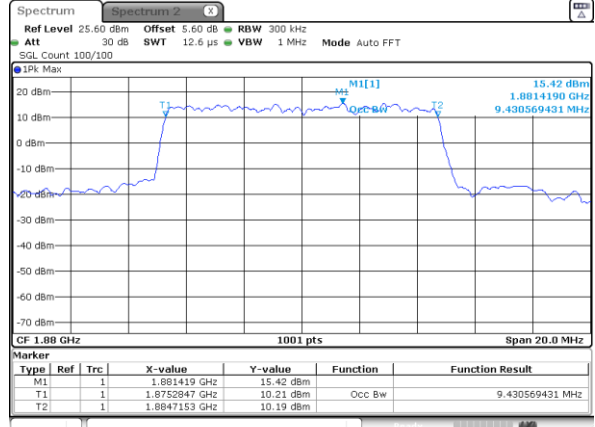

64QAM

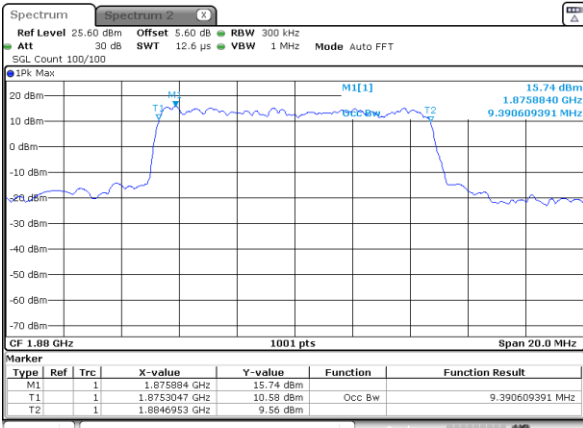

256QAM

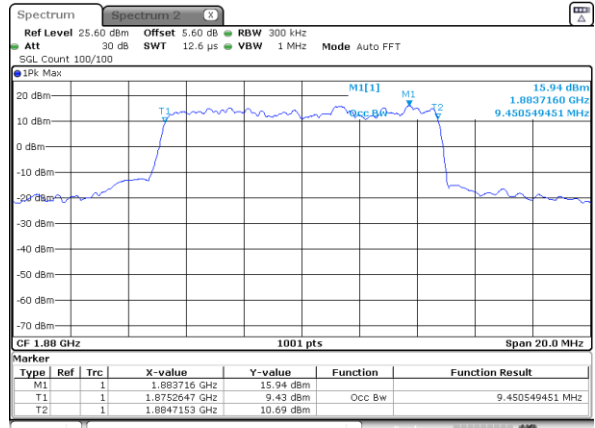



FR1 n2 / 15MHz / CP OFDM / Middle Channel / Full RB

QPSK

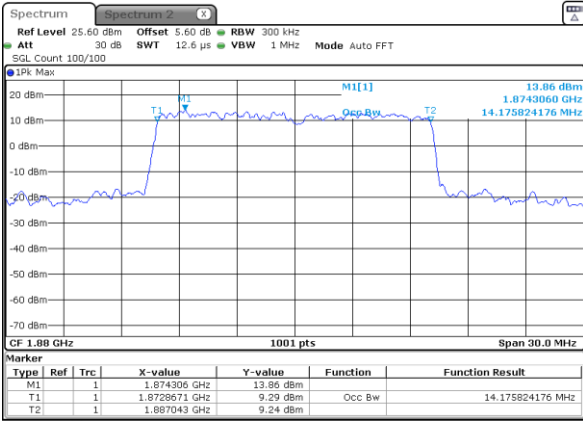

Date: 11.JUN.2022 00:07:20

16QAM

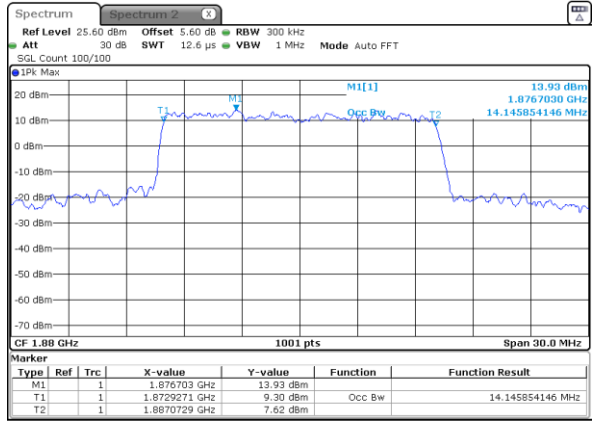

Date: 11.JUN.2022 00:07:42

64QAM

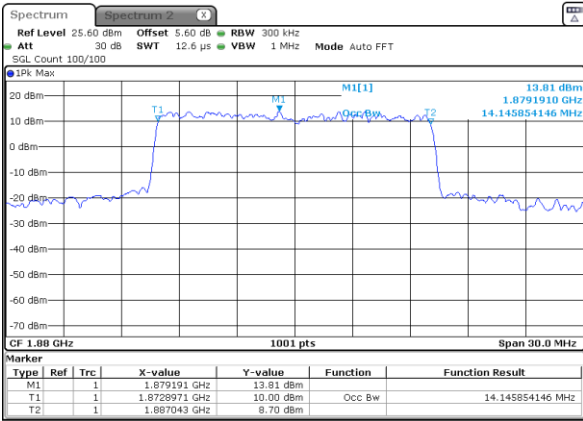

Date: 11.JUN.2022 00:08:02

256QAM

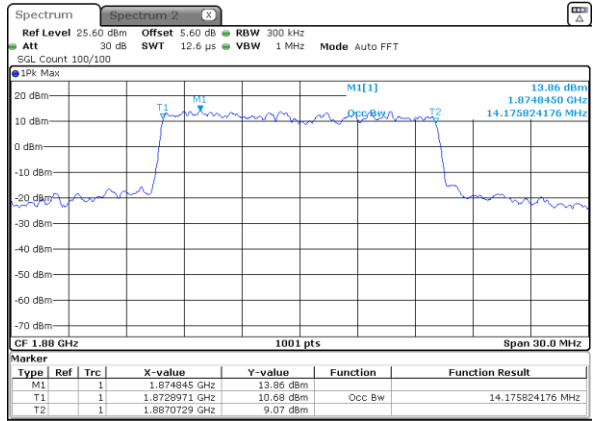

Date: 11.JUN.2022 00:08:19



FR1 n2 / 20MHz / CP OFDM / Middle Channel / Full RB

QPSK

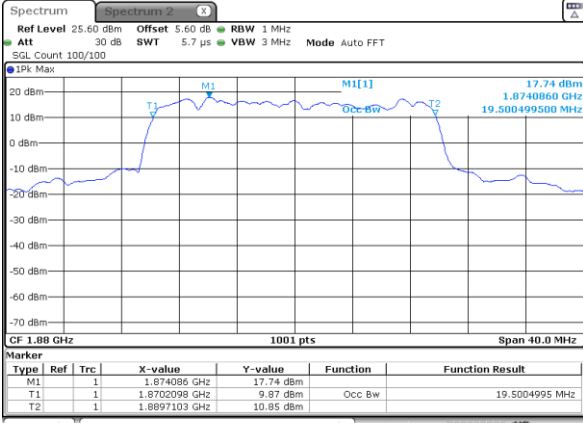

Date: 11.JUN.2022 00:09:41

16QAM

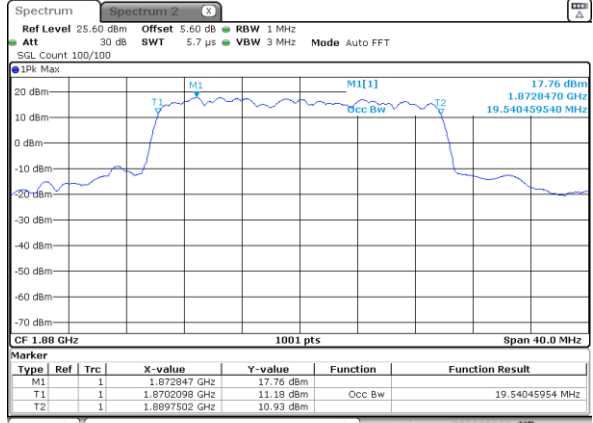

Date: 11.JUN.2022 00:10:23

64QAM

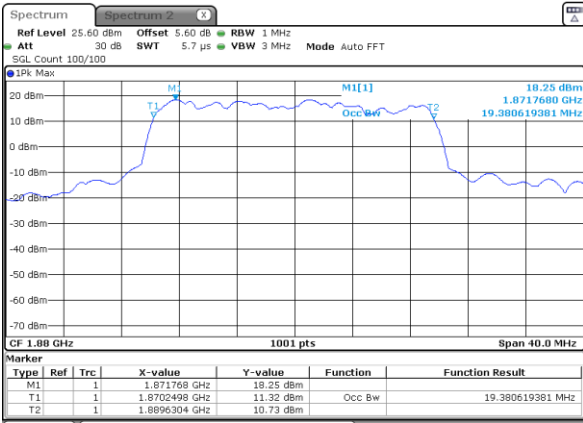

Date: 11.JUN.2022 00:09:05

256QAM

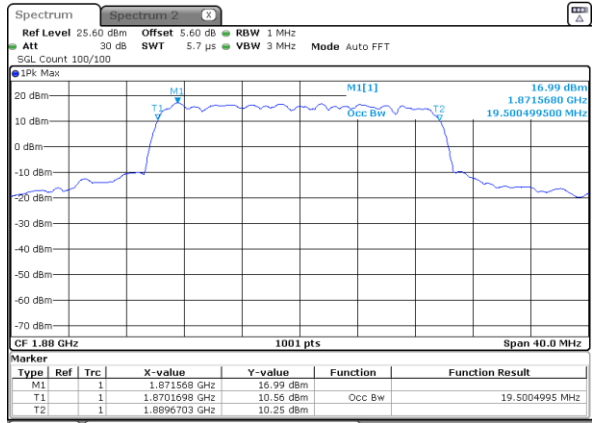

Date: 11.JUN.2022 00:08:44



Conducted Band Edge

FR1 n2 / 5MHz / DFT-S OFDM / PI/2 BPSK

Lowest Band Edge / 1RB0

Highest Band Edge / 1RBmax

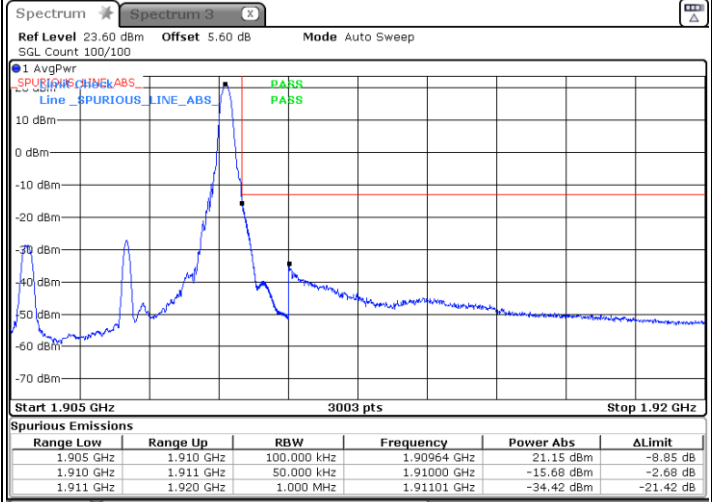
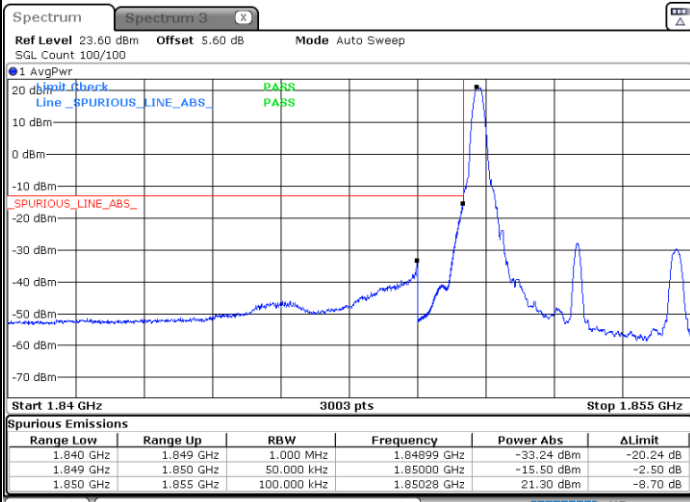

Date: 9 JUN.2022 04:16:42

Date: 9 JUN.2022 04:26:38

Lowest Band Edge / Full RB

Highest Band Edge / Full RB

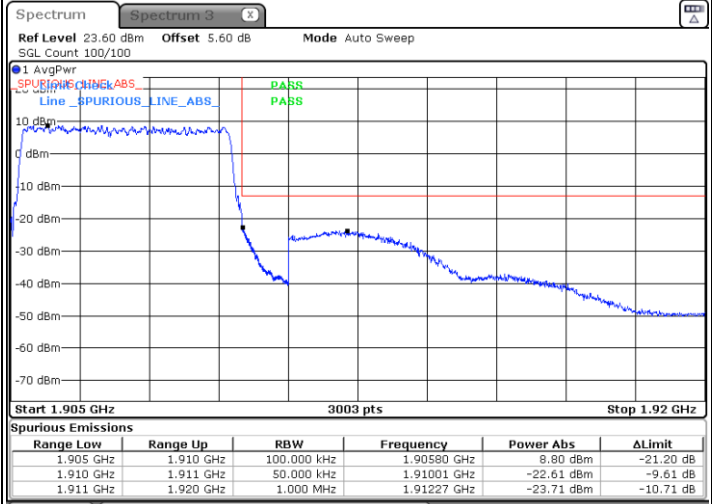
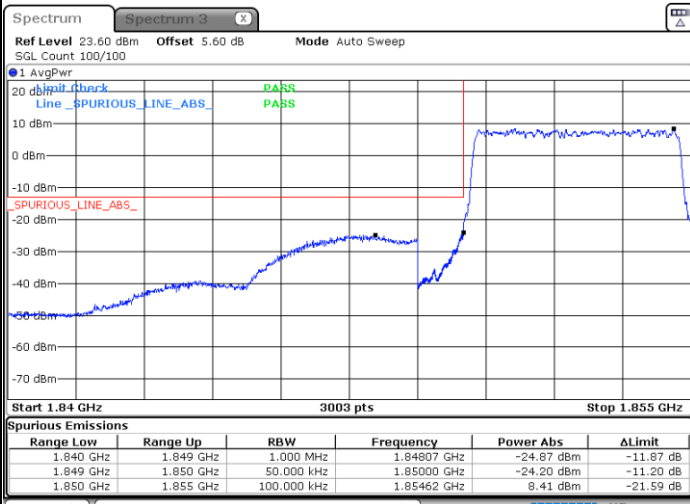

Date: 9 JUN.2022 04:17:40

Date: 9 JUN.2022 04:24:19



FR1 n2 / 5MHz / DFT-S OFDM / QPSK

Lowest Band Edge / 1RB0

Highest Band Edge / 1RBmax

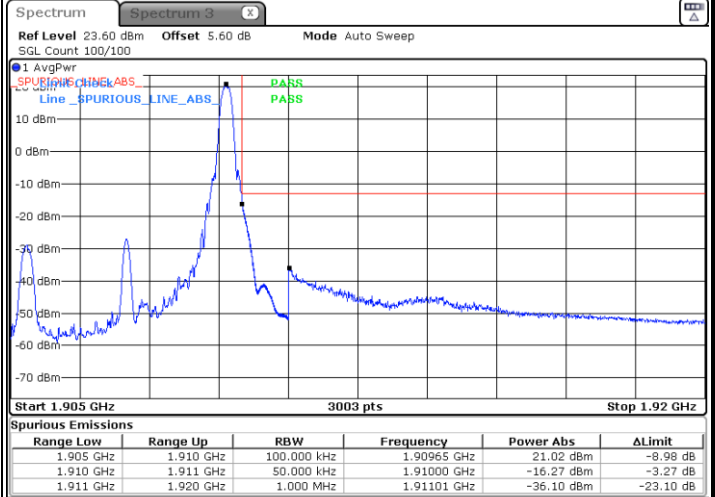
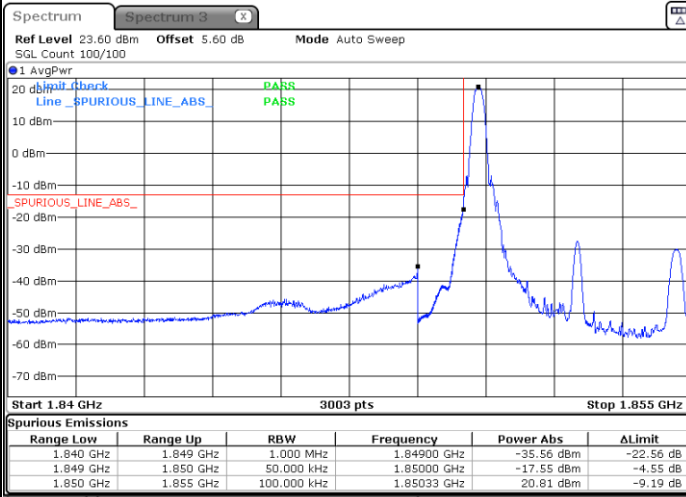

Date: 9.JUN.2022 04:16:13

Date: 9.JUN.2022 04:27:15

Lowest Band Edge / Full RB

Highest Band Edge / Full RB

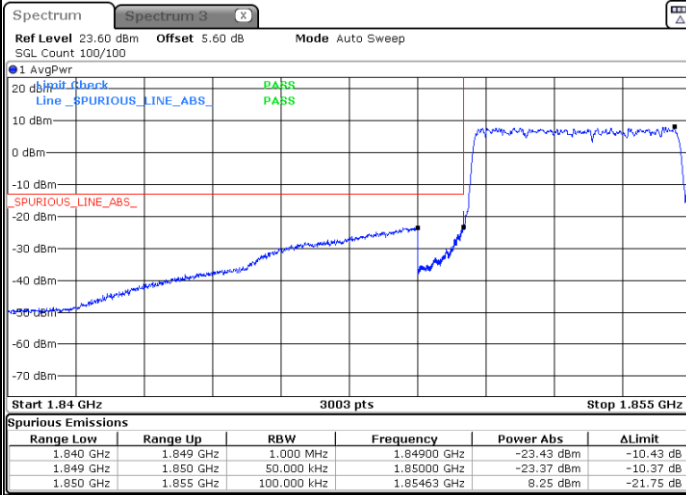

Date: 9.JUN.2022 04:20:58

Date: 9.JUN.2022 04:23:10



FR1 n2 / 10MHz / DFT-s-OFDM / PI/2 BPSK

Lowest Band Edge / 1RB0

Highest Band Edge / 1RBmax

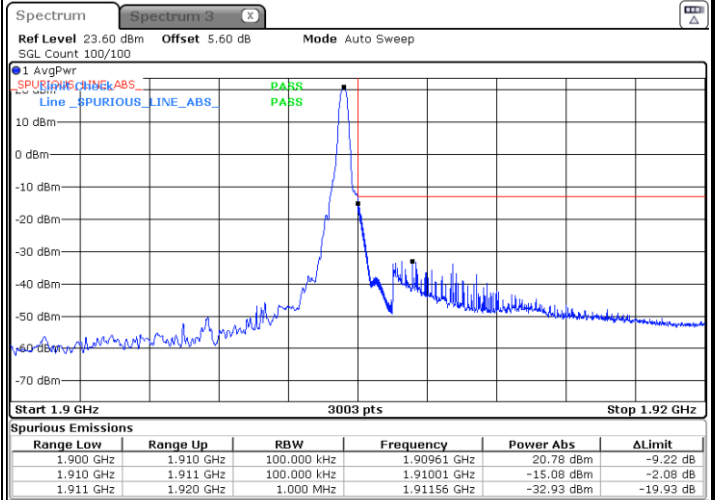
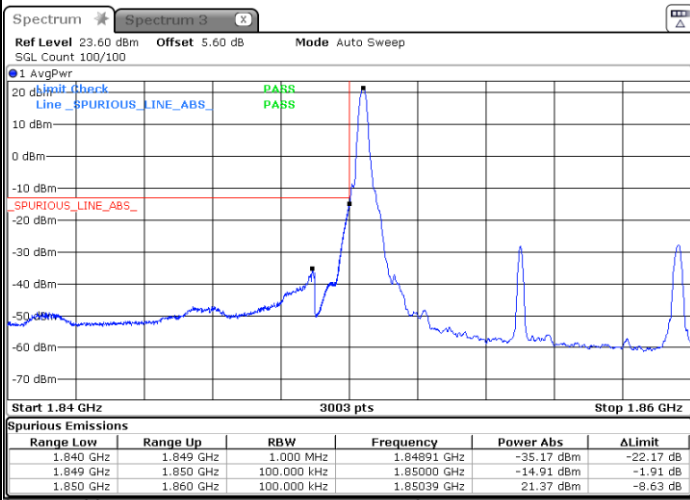

Date: 9 JUN 2022 03:34:03

Date: 9 JUN 2022 03:41:14

Lowest Band Edge / Full RB

Highest Band Edge / Full RB

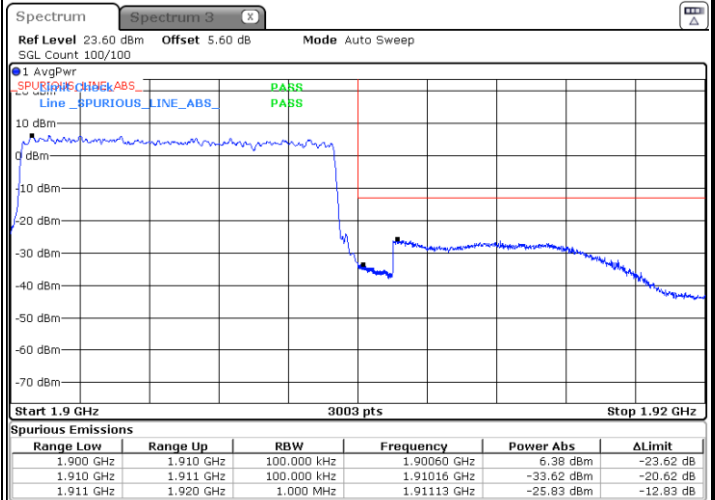
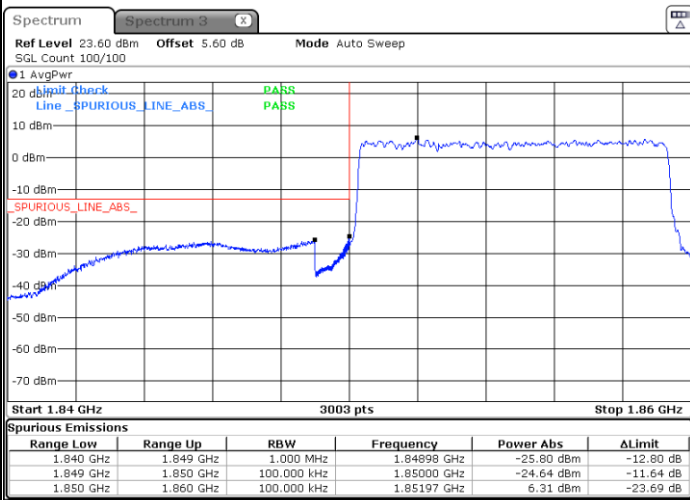

Date: 9 JUN 2022 03:36:37

Date: 9 JUN 2022 03:39:00



FR1 n2 / 10MHz / DFT-s-OFDM / QPSK

Lowest Band Edge / 1RB0

Highest Band Edge / 1RBmax

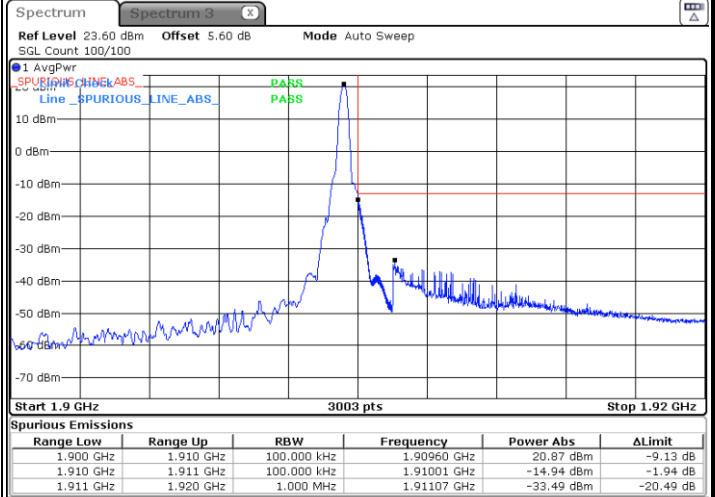
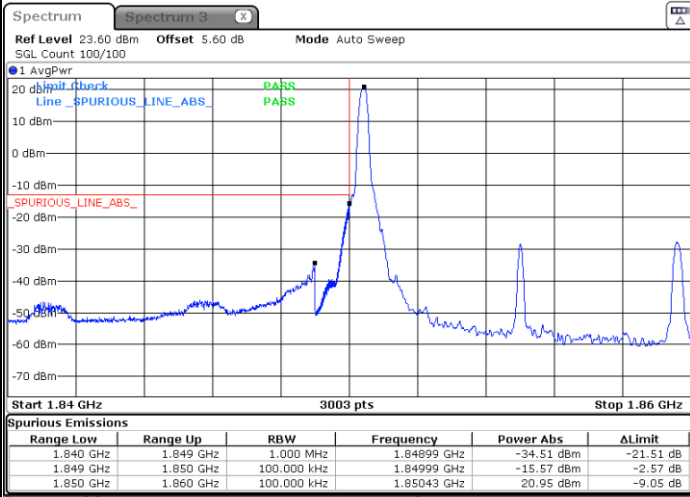

Date: 9 JUN 2022 03:35:03

Date: 9 JUN 2022 03:40:37

Lowest Band Edge / Full RB

Highest Band Edge / Full RB

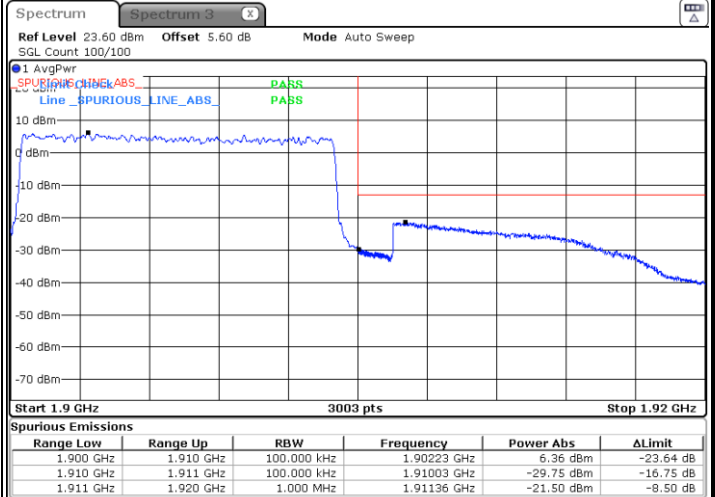
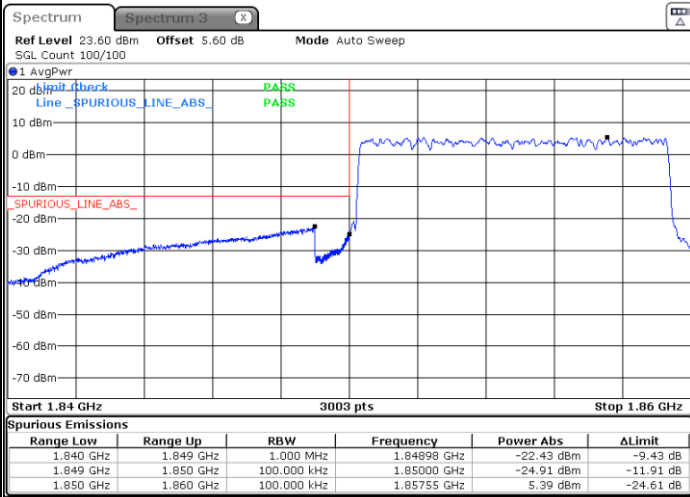

Date: 9 JUN 2022 03:36:01

Date: 9 JUN 2022 03:40:09



FR1 n2 / 20MHz / DFT-s-OFDM / PI/2 BPSK

Lowest Band Edge / 1RB0

Highest Band Edge / 1RBmax

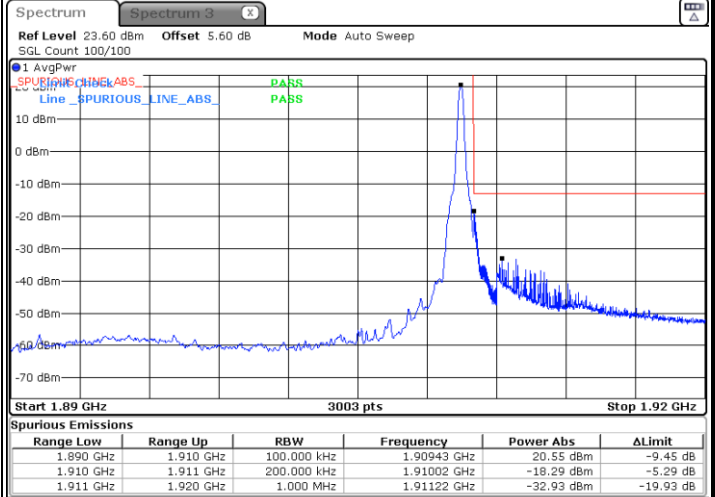
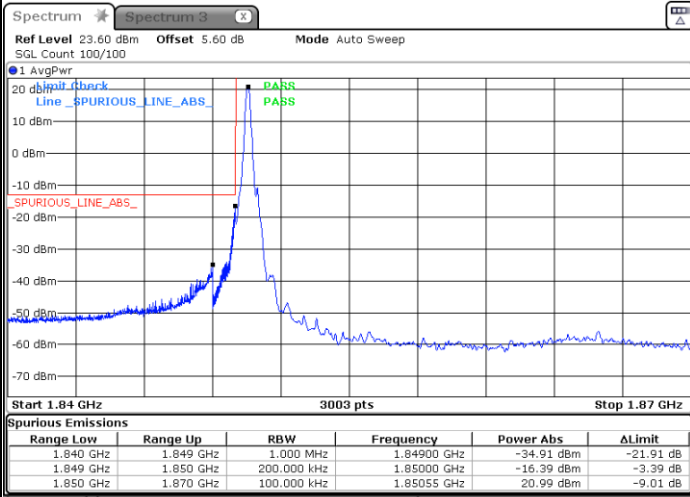

Date: 9 JUN.2022 02:39:19

Date: 9 JUN.2022 02:51:46

Lowest Band Edge / Full RB

Highest Band Edge / Full RB

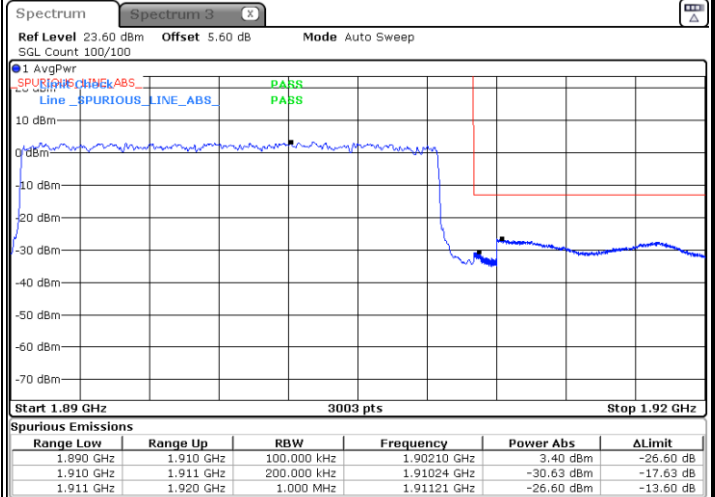
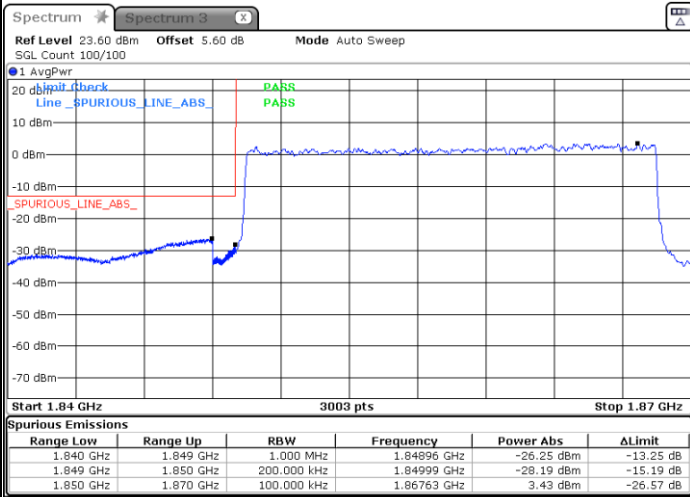

Date: 9 JUN.2022 02:48:16

Date: 9 JUN.2022 02:49:55



FR1 n2 / 20MHz / DFT-s-OFDM / QPSK

Lowest Band Edge / 1RB0

Highest Band Edge / 1RBmax

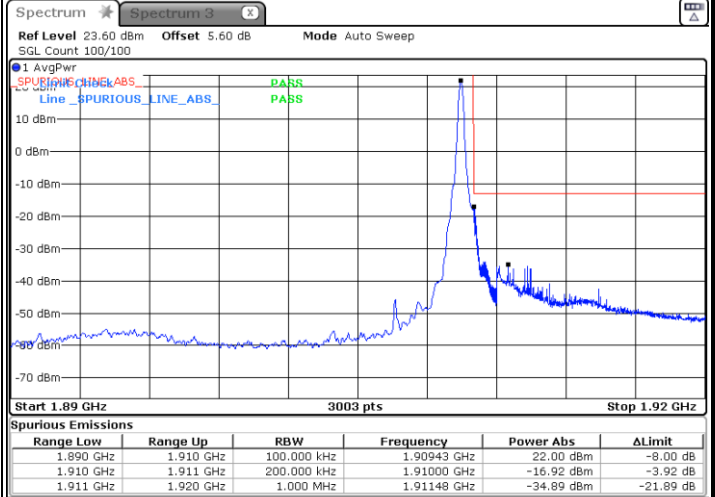
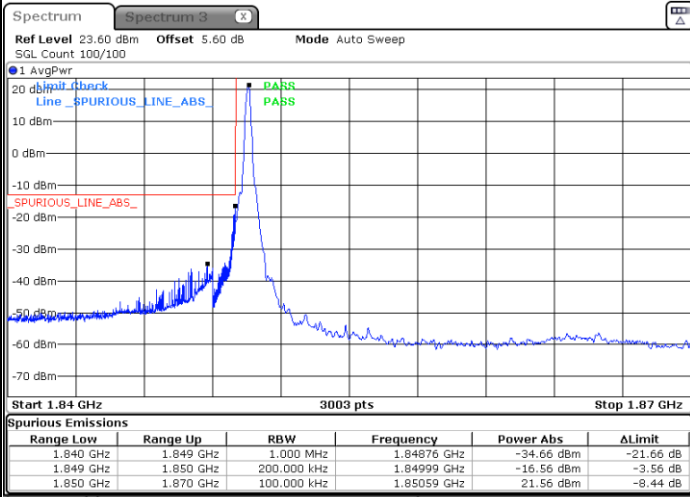

Date: 9 JUN 2022 02:42:58

Date: 9 JUN 2022 02:53:03

Lowest Band Edge / Full RB

Highest Band Edge / Full RB

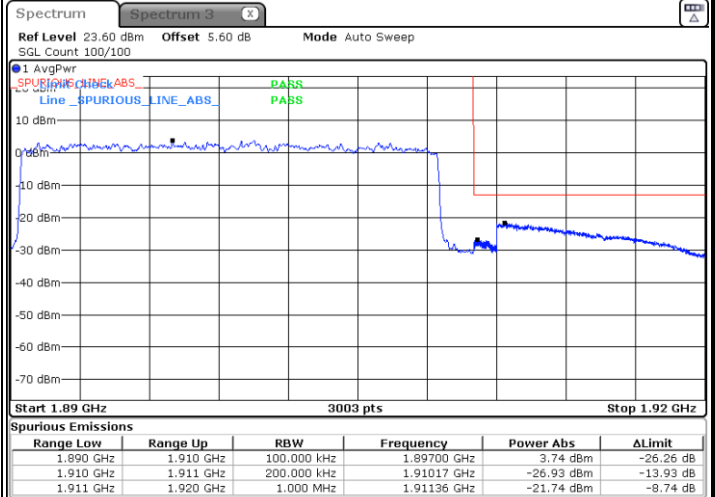
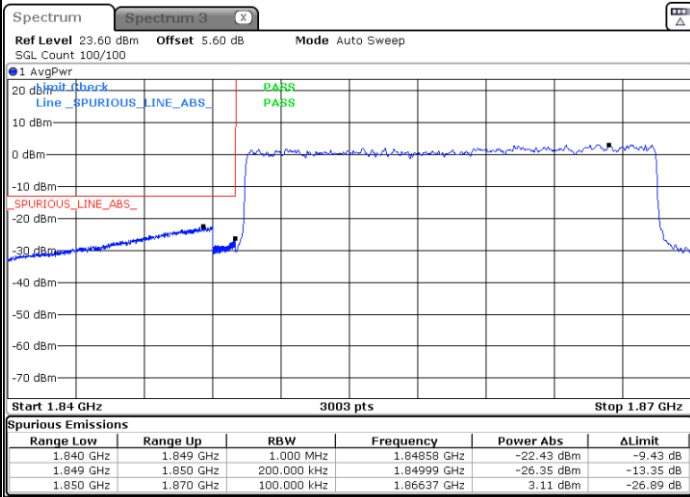

Date: 9 JUN 2022 02:49:05

Date: 9 JUN 2022 02:49:30



Conducted Spurious Emission

FR1 n2 / 5MHz / DFT-S OFDM / BPSK

Lowest Channel / 1RB1

Middle Channel / 1RB1

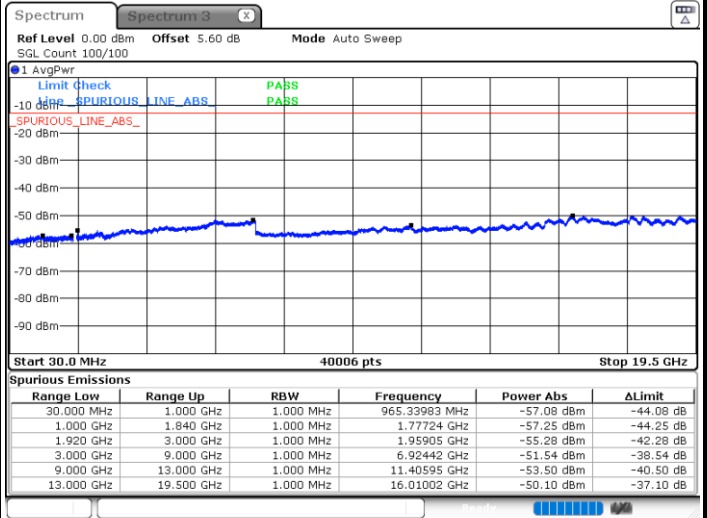
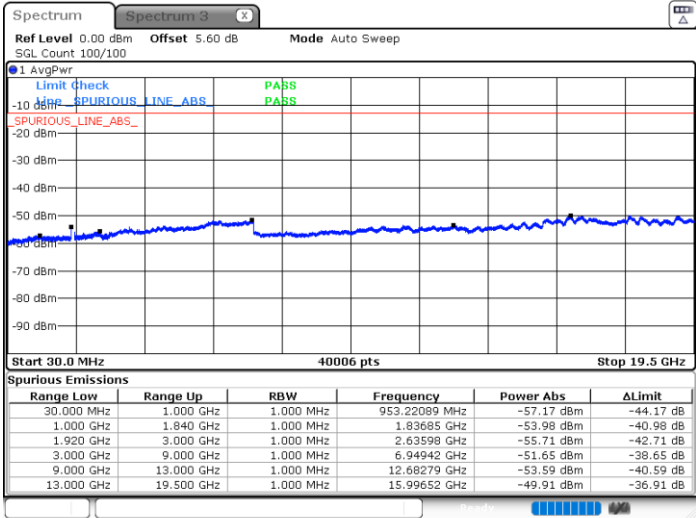

Date: 9 JUN 2022 04:09:26

Date: 9 JUN 2022 04:02:18

Highest Channel / 1RB1

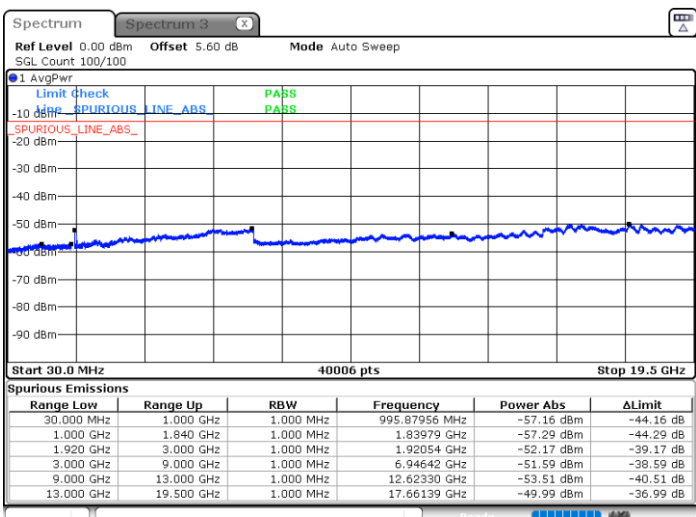

Date: 9 JUN 2022 04:33:52



FR1 n2 / 2MHz / DFT-S OFDM / QPSK

Lowest Channel / 1RB1

Middle Channel / 1RB1

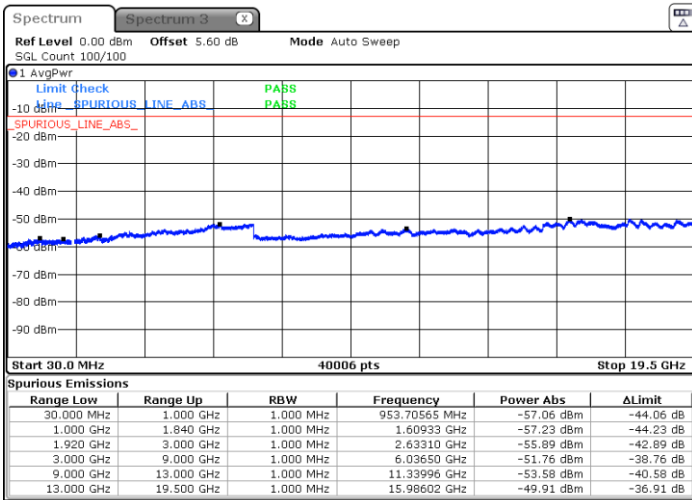

Date: 9 JUN 2022 04:10:45

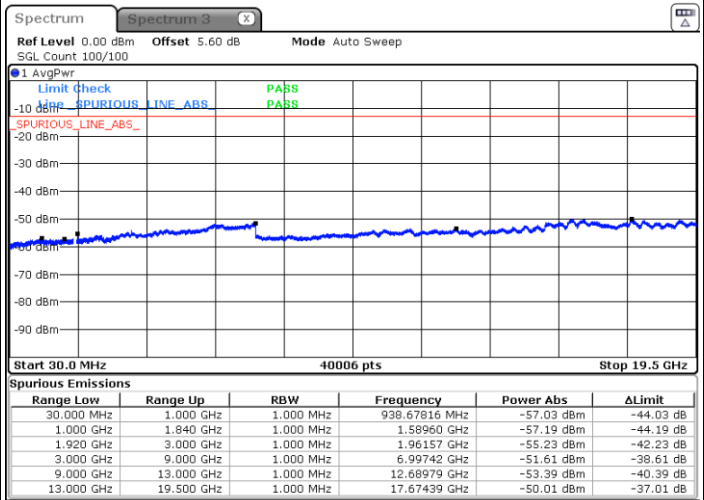

Date: 9 JUN 2022 03:59:36

Highest Channel / 1RB1

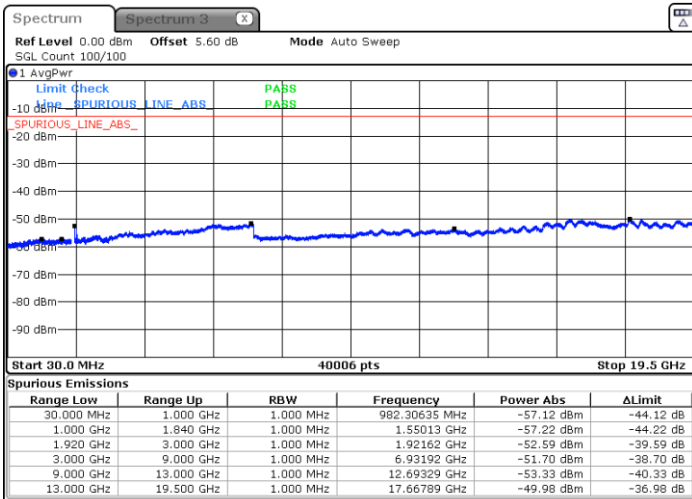

Date: 9 JUN 2022 04:10:54



FR1 n2 / 10MHz / DFT-S OFDM / BPSK

Lowest Channel / 1RB1

Middle Channel / 1RB1

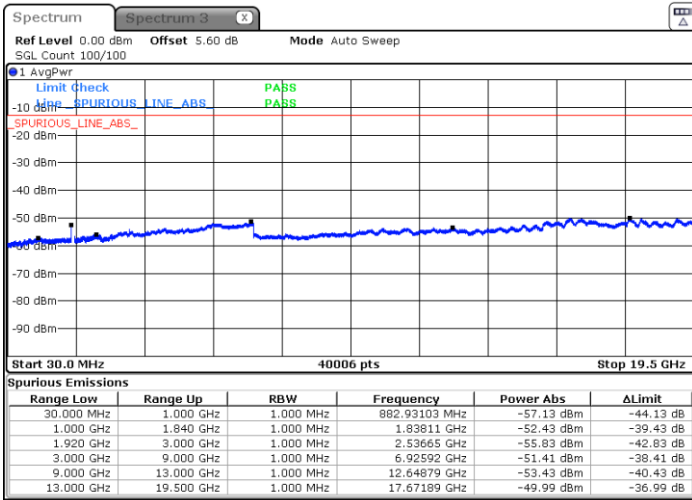

Date: 9 JUN.2022 03:52:19

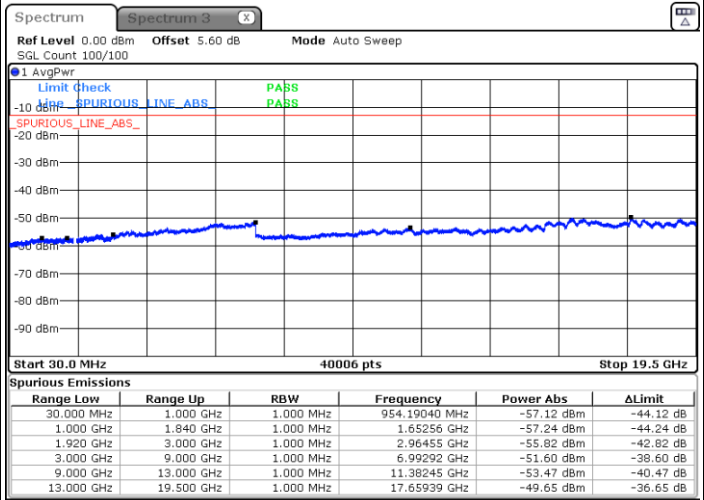

Date: 9 JUN.2022 03:14:02

Highest Channel / 1RB1

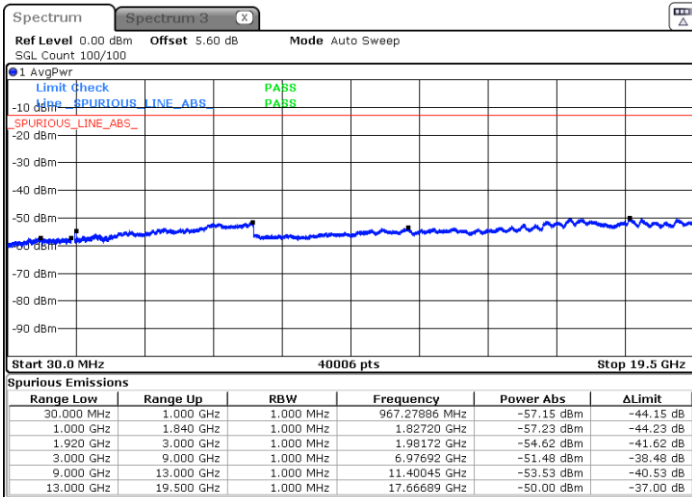

Date: 9 JUN.2022 03:43:11



FR1 n2 / 10MHz / DFT-S OFDM / QPSK

Lowest Channel / 1RB1

Middle Channel / 1RB1

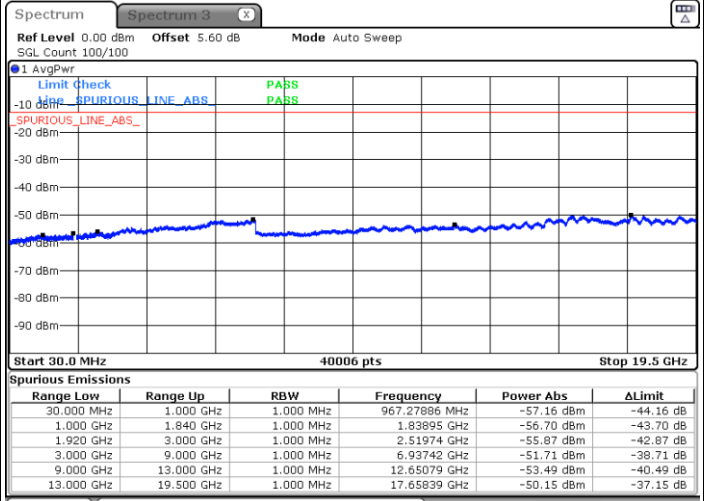
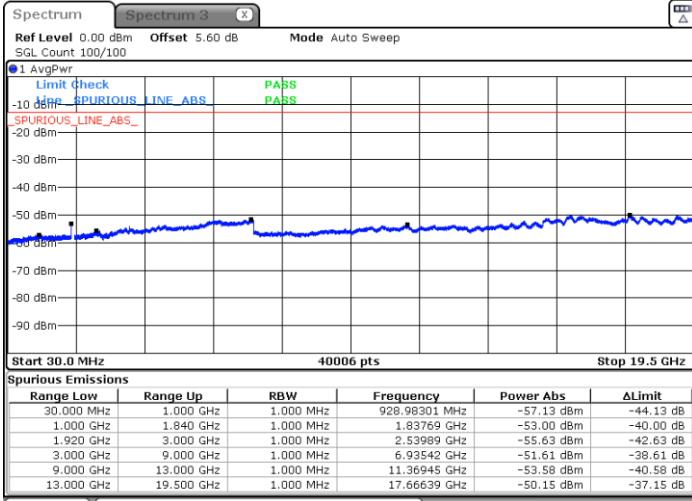

Date: 9. JUN. 2022 02:45:40

Date: 9. JUN. 2022 02:31:49

Highest Channel / 1RB1

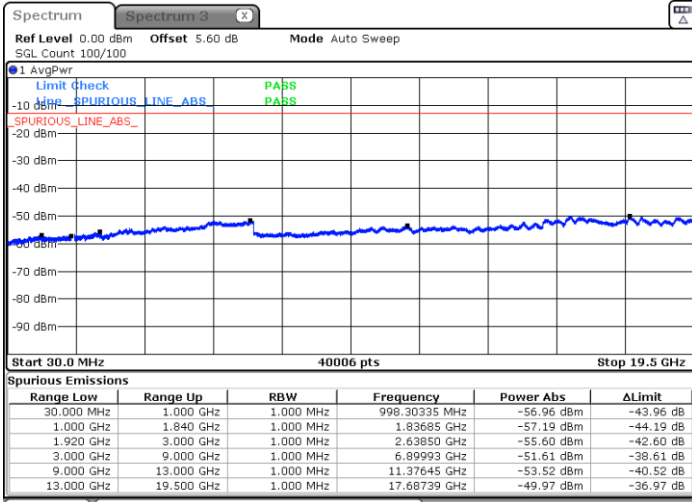

Date: 9. JUN. 2022 04:41:10



FR1 n2 / 20MHz / DFT-S OFDM / BPSK

Lowest Channel / 1RB1

Middle Channel / 1RB1

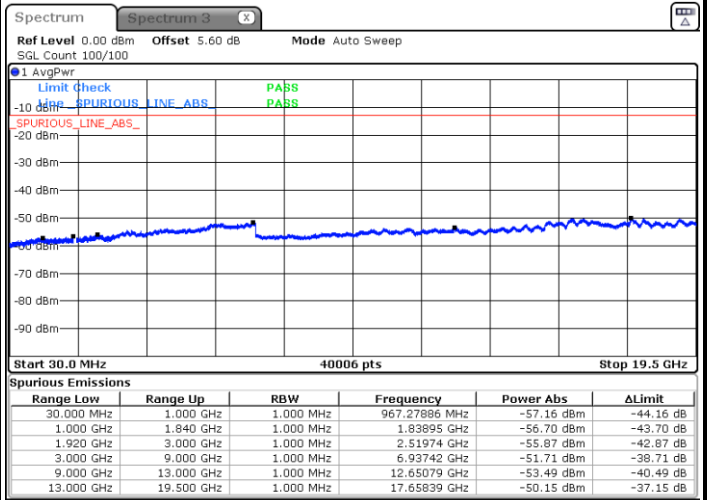
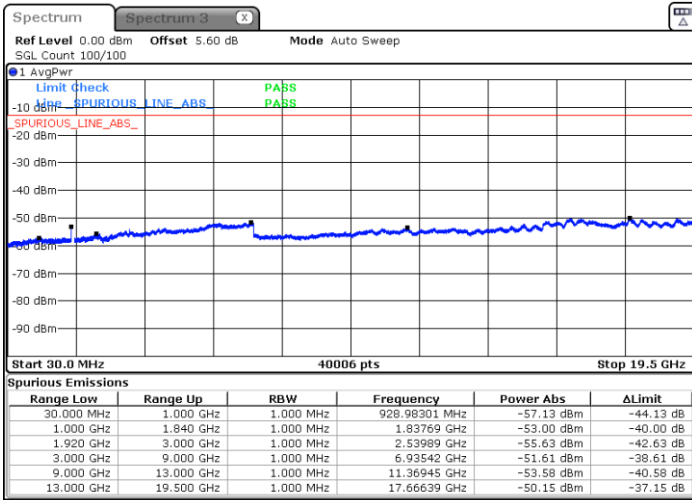

Date: 9. JUN. 2022 02:45:40

Date: 9. JUN. 2022 02:31:49

Highest Channel / 1RB1

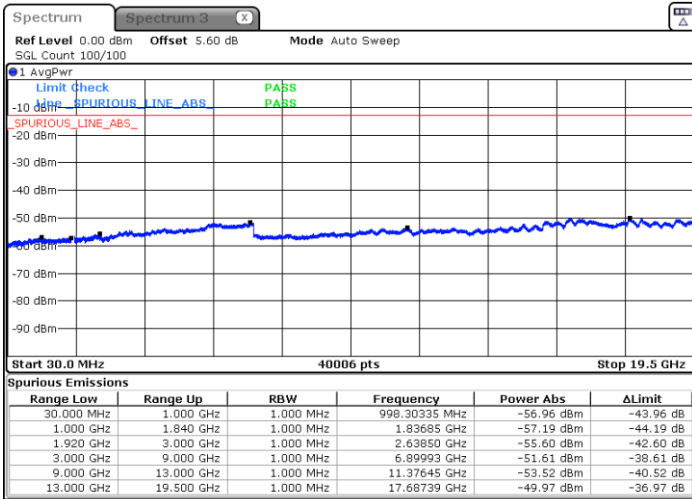

Date: 9. JUN. 2022 04:41:10



FR1 n2 / 20MHz / DFT-S OFDM / QPSK

Lowest Channel / 1RB1

Middle Channel / 1RB1

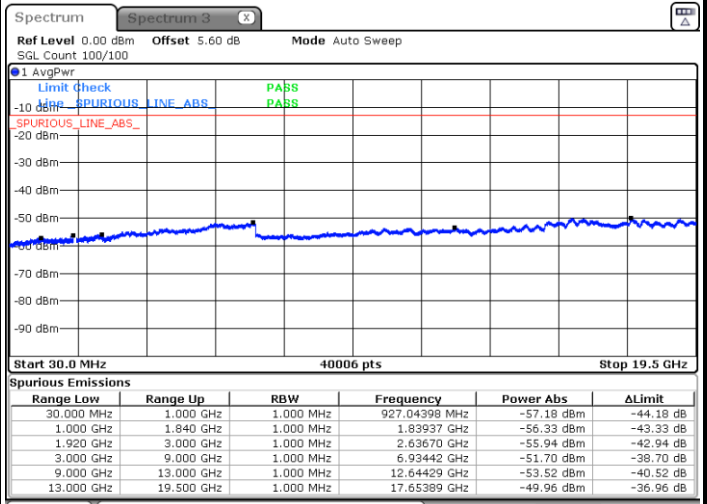
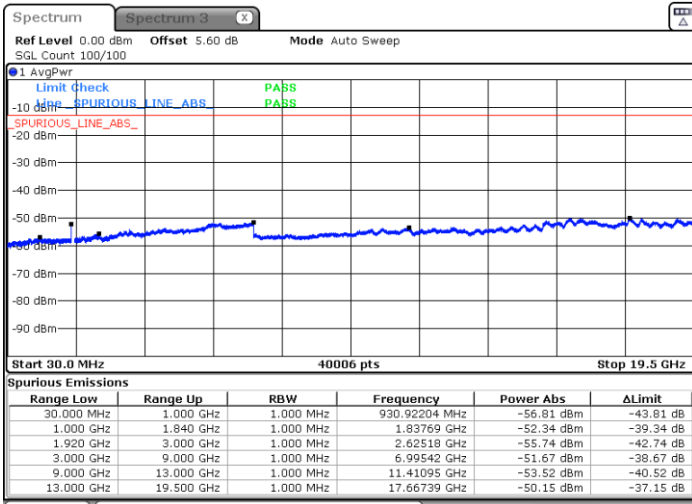

Date: 9. JUN. 2022 02:47:03

Date: 9. JUN. 2022 02:34:02

Highest Channel / 1RB1

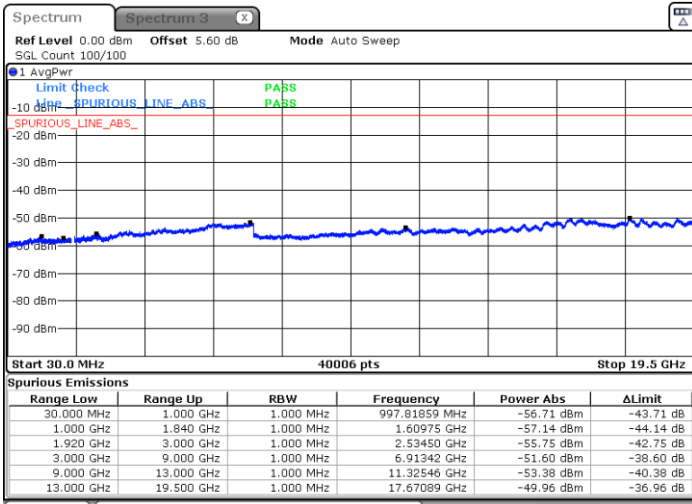

Date: 9. JUN. 2022 04:42:10



Frequency Stability

Test Conditions		FR1 n2 (QPSK) / Middle Channel	Limit
Temperature (°C)	Voltage (Volt)	BW 20MHz	Note 2.
		Deviation (ppm)	Result
20	Normal Voltage	0.0011	PASS
40	Normal Voltage	0.0023	
30	Normal Voltage	0.0043	
20(Ref.)	Normal Voltage	0.0000	
10	Normal Voltage	0.0052	
0	Normal Voltage	0.0011	
-10	Normal Voltage	0.0038	
-20	Normal Voltage	0.0021	
-30	Normal Voltage	0.0025	
20	Maximum Voltage	0.0017	
20	Normal Voltage	0.0000	
20	Battery End Point	0.0016	

Note:

1. Normal Voltage =3.89V. ; Battery End Point (BEP) =3. 4V. ; Maximum Voltage =4.48 V.
2. Note: The frequency fundamental emissions stay within the authorized frequency block.



FR1 n2(Other PA)

Peak-to-Average Ratio

Mode	FR1 n2 / 20MHz / DFT-S OFDM				
Mod.	PI/2 BPSK	QPSK			Limit: 13dB
RB Size	Full RB	Full RB			Result
Middle CH	3.59	4.67			PASS

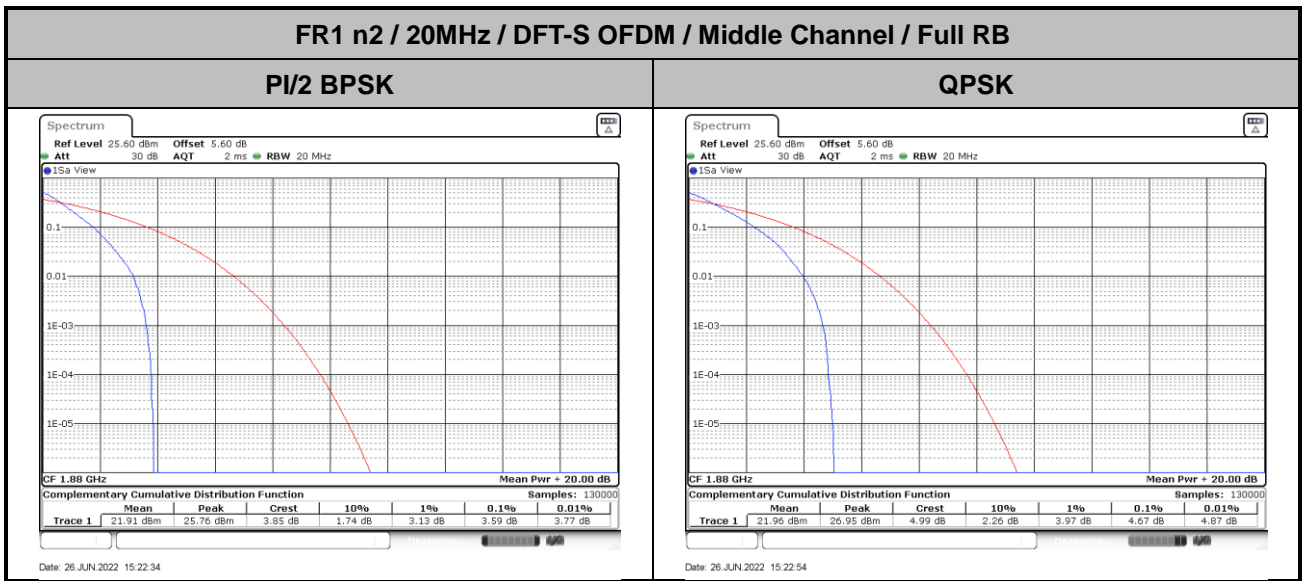



26dB Bandwidth

Mode	FR1 n2 : 26dBW (MHz) / DFT OFDM							
BW	5MHz		10MHz		15MHz		20MHz	
Mod.	QPSK		QPSK		QPSK		QPSK	
Middle CH	5.09		10.09		15.05		20.26	
Mod.	16QAM	64QAM	16QAM	64QAM	16QAM	64QAM	16QAM	64QAM
Middle CH	5.18	5.25	10.21	10.09	14.99	15.14	20.22	20.26
Mod.	256QAM		256QAM		256QAM		256QAM	
Middle CH	5.30		10.19		15.02		20.14	



FR1 n2 / 5MHz / CP OFDM / Middle Channel / Full RB

QPSK

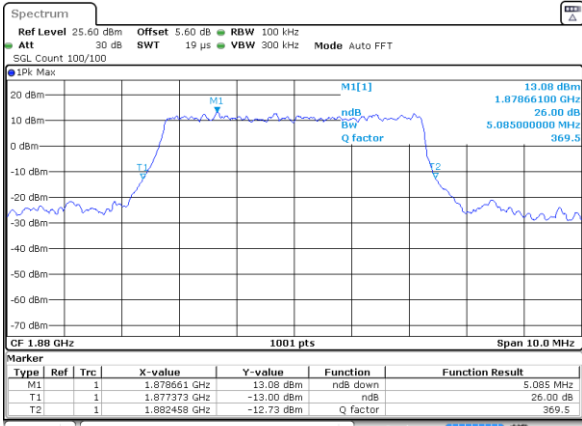

Date: 26 JUN 2022 15:47:43

16QAM

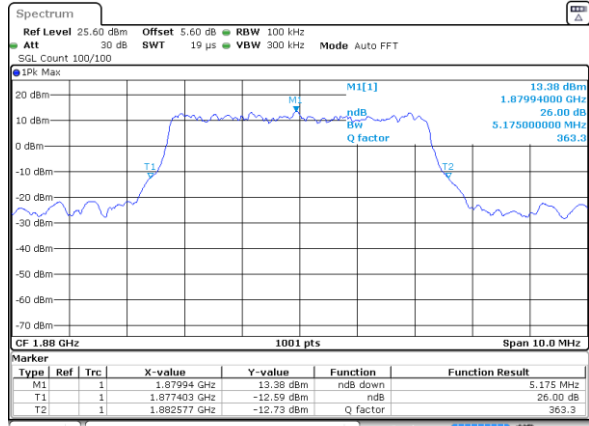

Date: 26 JUN 2022 15:48:00

64QAM

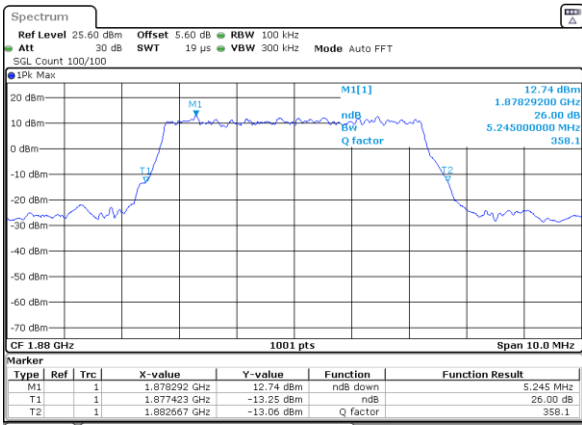

Date: 26 JUN 2022 15:48:25

256QAM

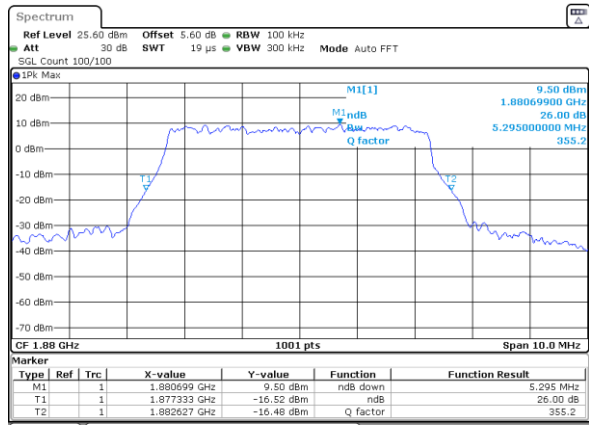

Date: 26 JUN 2022 15:48:48



FR1 n2 / 10MHz / CP OFDM / Middle Channel / Full RB

QPSK

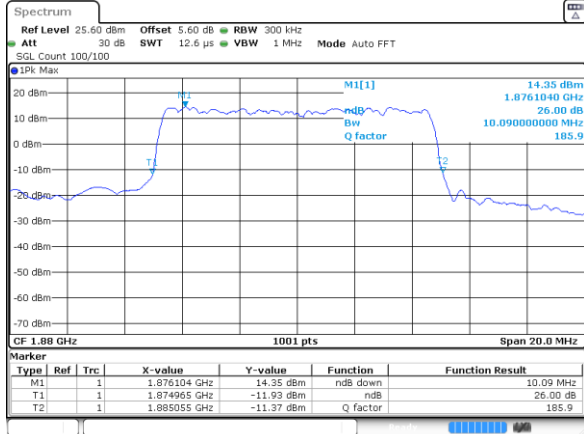

Date: 26 JUN 2022 15:36:02

16QAM

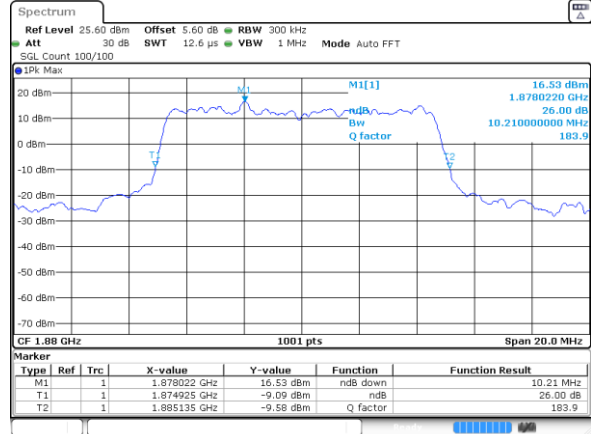

Date: 26 JUN 2022 15:35:41

64QAM

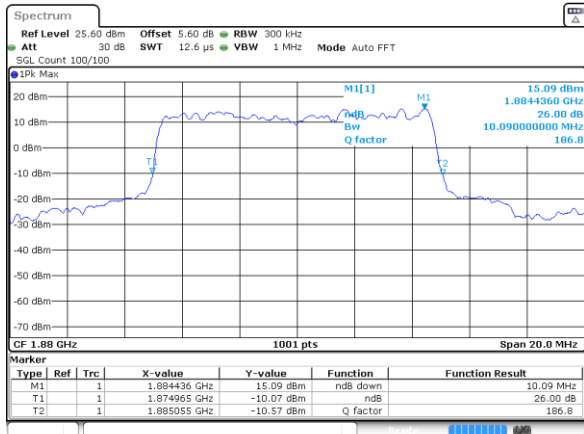

Date: 26 JUN 2022 15:35:20

256QAM

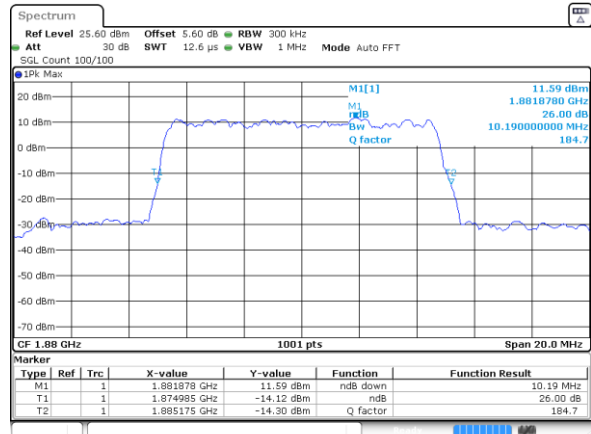

Date: 26 JUN 2022 15:34:59



FR1 n2 / 15MHz / CP OFDM / Middle Channel / Full RB

QPSK

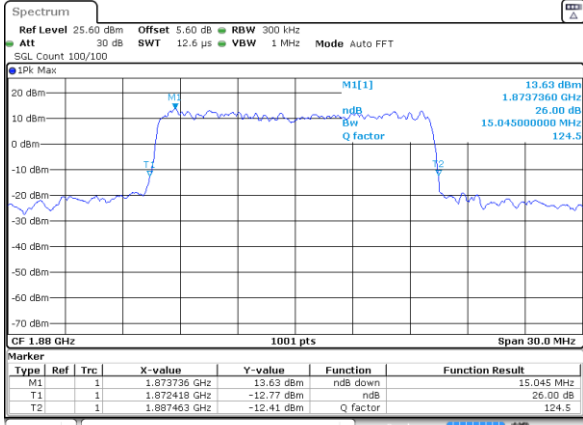

Date: 26 JUN 2022 15:33:29

16QAM

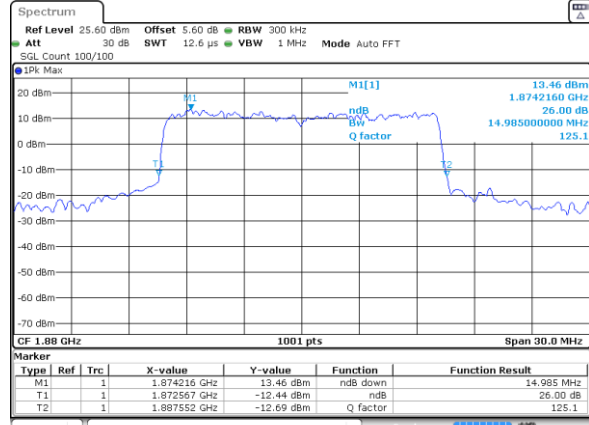

Date: 26 JUN 2022 15:33:48

64QAM

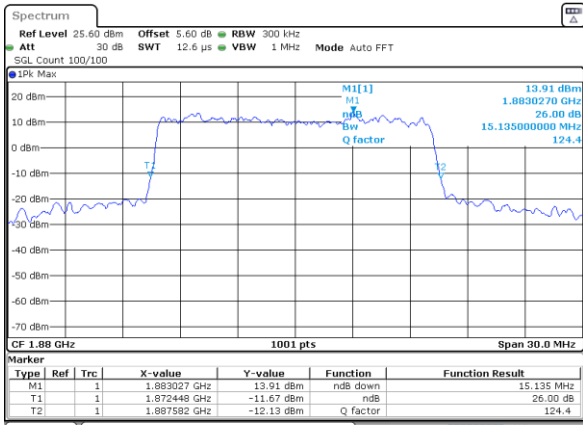

Date: 26 JUN 2022 15:34:07

256QAM

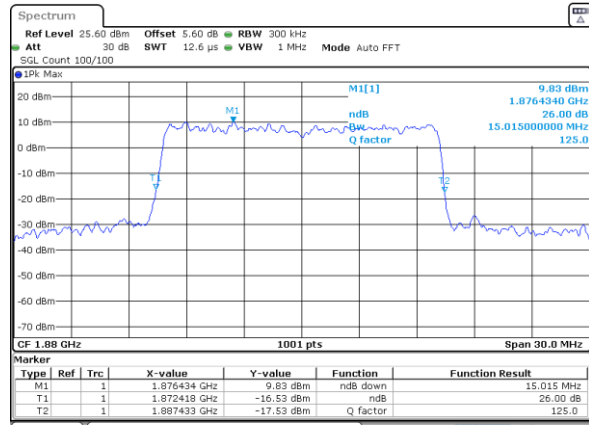

Date: 26 JUN 2022 15:34:31