



FCC RF Test Report

APPLICANT : Motorola Mobility LLC
EQUIPMENT : Mobile Cellular Phone
BRAND NAME : Motorola
MODEL NAME : XT2241-2
FCC ID : IHDT56AF6
STANDARD : 47 CFR Part 2, 27 Subpart O (3700-3980MHz)
CLASSIFICATION : PCS Licensed Transmitter Held to Ear (PCE)
TEST DATE(S) : Jun. 10, 2022 ~ Jun. 15, 2022

We, Sporton International Inc. (Kunshan), would like to declare that the tested sample has been evaluated in accordance with the procedures given in ANSI C63.26-2015 and shown compliance with the applicable technical standards.

The test results in this report apply exclusively to the tested model / sample. Without written approval of Sporton International Inc. (Kunshan), the test report shall not be reproduced except in full.

Jason Jia

Approved by: Jason Jia



Sporton International Inc. (Kunshan)

**No. 1098, Pengxi North Road, Kunshan Economic Development Zone Jiangsu Province 215300
People's Republic of China**



TABLE OF CONTENTS

REVISION HISTORY... 3
SUMMARY OF TEST RESULT ... 4
1 GENERAL DESCRIPTION ... 5
1.1 Applicant ... 5
1.2 Manufacturer ... 5
1.3 Product Feature of Equipment Under Test ... 5
1.4 Product Specification of Equipment Under Test ... 6
1.5 Modification of EUT ... 6
1.6 Maximum EIRP and Emission Designator ... 7
1.7 Testing Location ... 7
1.8 Test Software ... 7
1.9 Applicable Standards ... 8
1.10 Specification of Accessory ... 8
2 TEST CONFIGURATION OF EQUIPMENT UNDER TEST ... 9
2.1 Test Mode ... 9
2.2 Connection Diagram of Test System ... 10
2.3 Support Unit used in test configuration and system ... 10
2.4 Measurement Results Explanation Example ... 10
2.5 Frequency List of Low/Middle/High Channels ... 11
3 CONDUCTED TEST ITEMS ... 13
3.1 Measuring Instruments ... 13
3.2 Test Setup ... 13
3.3 Test Result of Conducted Test ... 13
3.4 Conducted Output Power and EIRP ... 14
3.5 Peak-to-Average Ratio ... 15
3.6 Occupied Bandwidth ... 16
3.7 Conducted Band Edge ... 17
3.8 Conducted Spurious Emission ... 18
3.9 Frequency Stability ... 19
4 RADIATED TEST ITEMS ... 20
4.1 Measuring Instruments ... 20
4.2 Test Setup ... 20
4.3 Test Result of Radiated Test ... 21
4.4 Radiated Spurious Emission ... 22
5 LIST OF MEASURING EQUIPMENT ... 23
6 UNCERTAINTY OF EVALUATION ... 24
APPENDIX A. TEST RESULTS OF CONDUCTED TEST
APPENDIX B. TEST RESULTS OF RADIATED TEST
APPENDIX C. TEST SETUP PHOTOGRAPHS



REVISION HISTORY

REPORT NO.	VERSION	DESCRIPTION	ISSUED DATE
FG252601J	Rev. 01	Initial issue of report	Jul. 11, 2022



SUMMARY OF TEST RESULT

Report Section	FCC Rule	Description	Limit	Result	Remark
3.4	§2.1046	Conducted Output Power	Reporting Only	PASS	-
	§27.50(j)(3)	Equivalent Isotropic Radiated Power (5G NR n77, n78)	EIRP < 1Watt		
3.5	§27.50(j)(4)	Peak-to-Average Ratio	<13 dB	PASS	-
3.6	§2.1049	Occupied Bandwidth	Reporting Only	PASS	-
3.7	§2.1051 §27.53(l)(2)	Conducted Band Edge Measurement (5G NR n77, n78)	< 43+10log10(P[Watts])	PASS	-
3.8	§2.1051 §27.53(l)(2)	Conducted Spurious Emission (5G NR n77, n78)	< 43+10log10(P[Watts])	PASS	-
3.9	§27.54	Frequency Stability Temperature & Voltage	Within Authorized Band	PASS	-
4.4	§2.1053 §27.53(l)(2)	Radiated Spurious Emission (5G NR n77, n78)	< 43+10log ₁₀ (P[Watts])	PASS	Under limit 32.49 dB at 11106.00 MHz

Declaration of Conformity:
The test results with all measurement uncertainty excluded are presented in accordance with the regulation limits or requirements declared by manufacturers.
Comments and Explanations:
The declared of product specification for EUT presented in the report are provided by the manufacturer, and the manufacturer takes all the responsibilities for the accuracy of product specification.



1 General Description

1.1 Applicant

Motorola Mobility LLC
222 W,Merchandise Mart Plaza, Chicago IL 60654 USA

1.2 Manufacturer

Motorola Mobility LLC
222 W,Merchandise Mart Plaza, Chicago IL 60654 USA

1.3 Product Feature of Equipment Under Test

Product Feature	
Equipment	Mobile Cellular Phone
Brand Name	Motorola
Model Name	XT2241-2
FCC ID	IHDT56AF6
IMEI Code	Conducted : 355222700012736/355222700012744 Radiation : 35522700012934
HW Version	DVT2
SW Version	SSQ32.54
EUT Stage	Identical Prototype

Remark: Only 5G NR n77/n78 (3700~3980MHz) are tested in this report, all the other RF bands are tested in the other reports separately.



1.4 Product Specification of Equipment Under Test

Standards-related Product Specification	
Tx/Rx Frequency	5G NR n77: 3700 MHz ~ 3980 MHz 5G NR n78: 3700 MHz ~ 3800 MHz
SCS	30kHz
Bandwidth	n77/n78: 10 / 15 / 20 / 30 / 40 / 50 / 60 / 70 / 80 / 90 / 100 MHz
Antenna Gain	Ant. 2: 5G NR n77: -4.1 dBi 5G NR n78: -4.1 dBi Ant. 3: 5G NR n77: -4.5 dBi 5G NR n78: -4.5 dBi Ant. 5: 5G NR n77: -4.3 dBi 5G NR n78: -4.3 dBi Ant. 7: 5G NR n77: -4.4 dBi 5G NR n78: -4.4 dBi
Type of Modulation	CP-OFDM: QPSK / 16QAM / 64QAM / 256QAM DFT-s-OFDM: PI/2 BPSK / QPSK / 16QAM / 64QAM / 256QAM

Remark:

1. The maximum EIRP is calculated from max output power and max antenna gain, only the maximum EIRP of Antenna 2 is shown in the report.
2. 5G NR n77/n78 support SA and NSA mode. The whole testing has assessed SA mode by referring to the higher conducted power for conducted test items.
3. The device supports HPUE mode for 5G NR n77/n78.
4. All the supported EN-DC combinations are verified conducted power, only the EN-DC combination with highest power are shown in the report.
5. The EN-DC mode combination could be referred to the product spec.

1.5 Modification of EUT

No modifications are made to the EUT during all test items.



1.6 Maximum EIRP and Emission Designator

5G NR n77		PI/2 BPSK / QPSK		16QAM / 64QAM / 256QAM	
BW (MHz)	Frequency Range (MHz)	Maximum EIRP(W)	Emission Designator (99%OBW)	Maximum EIRP(W)	Emission Designator (99%OBW)
100	3750.00 ~ 3930.00	0.1462	97M9G7D	0.1225	97M7W7D

5G NR n78		PI/2 BPSK / QPSK		16QAM / 64QAM / 256QAM	
BW (MHz)	Frequency Range (MHz)	Maximum EIRP(W)	Emission Designator (99%OBW)	Maximum EIRP(W)	Emission Designator (99%OBW)
100	3750.00 ~ 3750.00	0.1442	97M9G7D	0.1225	97M7W7D

Note:

1. 5G NR Band n77 overlaps the entire frequency range of Band n78. Therefore, the conducted test results provided in this report covers Band n77 as well as Band n78
2. All modulations have been tested, only the maximum bandwidth and the worst test results of PSK & QAM are shown in the report.

1.7 Testing Location

Sporton International Inc. (Kunshan) is accredited to ISO/IEC 17025:2017 by American Association for Laboratory Accreditation with Certificate Number 5145.02.

Test Firm	Sporton International Inc. (Kunshan)		
Test Site Location	No. 1098, Pengxi North Road, Kunshan Economic Development Zone Jiangsu Province 215300 People's Republic of China TEL : +86-512-57900158 FAX : +86-512-57900958		
Test Site No.	Sporton Site No.	FCC Designation No.	FCC Test Firm Registration No.
	03CH04-KS TH01-KS	CN1257	314309

1.8 Test Software

Item	Site	Manufacturer	Name	Version
1.	03CH04-KS	AUDIX	E3	6.2009-8-24a



1.9 Applicable Standards

According to the specifications of the manufacturer, the EUT must comply with the requirements of the following standards:

- 47 CFR Part 2, 27
- ANSI C63.26-2015
- FCC KDB 971168 D01 Power Meas License Digital Systems v03r01
- FCC KDB 412172 D01 Determining ERP and EIRP v01r01

Remark:

All test items were verified and recorded according to the standards and without any deviation during the test.

1.10 Specification of Accessory

Specification of Accessory				
AC Adapter(US)	Brand Name	Motorola(AOHAI)	Model Name	MC-1251
AC Adapter(EU)	Brand Name	Motorola(AOHAI)	Model Name	MC-1252
AC Adapter(UK)	Brand Name	Motorola(AOHAI)	Model Name	MC-1253
AC Adapter(IN)	Brand Name	Motorola(AOHAI)	Model Name	MC-1254
AC Adapter(AU)	Brand Name	Motorola(AOHAI)	Model Name	MC-1255
AC Adapter(AR)	Brand Name	Motorola(AOHAI)	Model Name	MC-1256
AC Adapter(BR)	Brand Name	Motorola(AOHAI)	Model Name	MC-1257
AC Adapter(CHILE)	Brand Name	Motorola(AOHAI)	Model Name	MC-1259
Battery	Brand Name	Motorola(ATL)	Model Name	NF45
Earphone 1	Brand Name	Motorola(Lyand)	Model Name	MD211
Earphone 2	Brand Name	Motorola(LCHSE)	Model Name	MD211
USB Cable	Brand Name	Motorola(Saibao)	Model Name	SC18D58980
Wireless Charging dock	Brand Name	TurboPower 50W Wireless Charging Stand	Model Name	MW-02



2 Test Configuration of Equipment Under Test

2.1 Test Mode

Antenna port conducted and radiated test items are performed according to KDB 971168 D01 Power Meas License Digital Systems v03r01 with maximum output power.

For radiated measurement, pre-scanned in three orthogonal panels, X, Y, Z. The worst cases (Z plane) were recorded in this report.

The device is investigated from 30MHz to 10 times of fundamental signal for radiated spurious emission test under different RB size/offset and modulations in exploratory test. Subsequently, only the worst case emissions are reported.

Orthogonal Planes of EUT	X Plane	Y Plane	Z Plane
			

Test Items	5G NR	Bandwidth (MHz)										Modulation					RB #		Test Channel		
		10	15	20	30	40	50	60	70-90	100	PI/2 BPSK	QPSK	16QAM	64QAM	256 QAM	1	Full	L	M	H	
Max. Output Power	n77	v	v	v	v	v	v	v	v	v	v	v	v	v	v	v	v	v	v	v	
	n78	v	v	v	v	v	v	v	v	v	v	v	v	v	v	v	v	v	v	v	
Peak-to-Average Ratio	n77									v	v					v		v			
26dB and 99% Bandwidth	n77	v	v	v	v	v	v	v	v		v	v	v	v		v		v			
Conducted Band Edge	n77	v						v		v	v					v	v	v		v	
Conducted Spurious Emission	n77	v						v		v	v					v		v	v	v	
Frequency Stability	n77			v							v						v		v		
E.R.P / E.I.R.P	n77	v	v	v	v	v	v	v	v	v	v	v	v	v	v	v	v	v	v	v	
	n78	v	v	v	v	v	v	v	v	v	v	v	v	v	v	v	v	v	v	v	
Radiated Spurious Emission	n77	Worst Case																		v	
	n78	Worst Case																		v	
Note	<ol style="list-style-type: none"> The mark "v" means that this configuration is chosen for testing The mark "-" means that this bandwidth is not supported. The device is investigated from 30MHz to 10 times of fundamental signal for radiated spurious emission test under different RB size/offset and modulations in exploratory test. Subsequently, only the worst case emissions are reported. Normal Voltage: 3.89Vdc, Extreme Voltage: 3.4Vdc ~4.48Vdc 																				

2.2 Connection Diagram of Test System

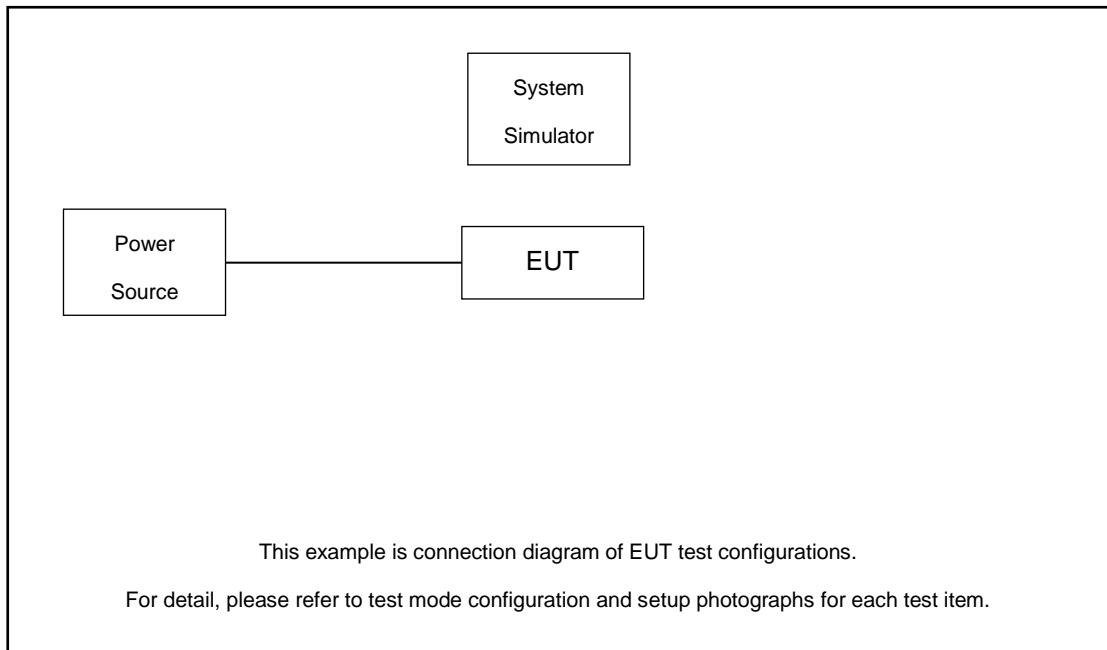

2.3 Support Unit used in test configuration and system

Item	Equipment	Trade Name	Model No.	FCC ID	Data Cable	Power Cord
1.	DC Power Supply	GW	GPS-3030D	N/A	N/A	Unshielded, 1.8 m
2.	LTE Base Station	Anritsu	MT8821C	N/A	N/A	Unshielded, 1.8 m
3.	NR Base Station	Anritsu	MT8000A	N/A	N/A	Unshielded, 1.8 m

2.4 Measurement Results Explanation Example

For all conducted test items:

The offset level is set in the spectrum analyzer to compensate the RF cable loss between EUT conducted output port and spectrum analyzer. With the offset compensation, the spectrum analyzer reading level is exactly the EUT RF output level.

The spectrum analyzer offset is derived from RF cable loss.

Offset = RF cable loss.

Following shows an offset computation example with cable loss 6.5 dB.

Example :

$$\begin{aligned} \text{Offset(dB)} &= \text{RF cable loss(dB)}. \\ &= 6.5 \text{ (dB)} \end{aligned}$$



2.5 Frequency List of Low/Middle/High Channels

5G n77 Channel and Frequency List				
BW [MHz]	Channel/Frequency(MHz)	Lowest	Middle	Highest
100	Channel	650000	656000	662000
	Frequency	3750	3840	3930
90	Channel	649668	656000	662334
	Frequency	3745.02	3840	3935.01
80	Channel	649334	656000	662666
	Frequency	3740.01	3840	3939.99
70	Channel	649000	656000	663000
	Frequency	3735	3840	3945
60	Channel	648668	656000	663332
	Frequency	3730.02	3840	3949.98
50	Channel	648334	656000	663668
	Frequency	3725.01	3840	3955.02
40	Channel	648000	656000	664000
	Frequency	3720	3840	3960
30	Channel	647668	656000	664332
	Frequency	3715.02	3840	3964.98
20	Channel	647334	656000	664666
	Frequency	3710.01	3840	3969.99
15	Channel	647168	656000	664832
	Frequency	3707.52	3840	3972.48
10	Channel	647000	656000	665000
	Frequency	3705	3840	3975



5G n78 Channel and Frequency List				
BW [MHz]	Channel/Frequency(MHz)	Lowest	Middle	Highest
100	Channel	650000		
	Frequency	3750		
90	Channel	649668	650000	650334
	Frequency	3745.02	3750	3755.01
80	Channel	649334	650000	650668
	Frequency	3740.01	3750	3760.02
70	Channel	649000	650000	651000
	Frequency	3735	3750	3765
60	Channel	648668	650000	651334
	Frequency	3730.02	3750	3770.01
50	Channel	648334	650000	651668
	Frequency	3725.01	3750	3775.02
40	Channel	648000	650000	652000
	Frequency	3720	3750	3780
30	Channel	647668	650000	652334
	Frequency	3715.02	3750	3785.01
20	Channel	647334	650000	652668
	Frequency	3710.01	3750	3790.02
15	Channel	647168	650000	652834
	Frequency	3707.52	3750	3792.51
10	Channel	647000	650000	653000
	Frequency	3705	3750	3795

3 Conducted Test Items

3.1 Measuring Instruments

See list of measuring instruments of this test report.

3.2 Test Setup

3.2.1 Conducted Output Power



3.2.2 Peak-to-Average Ratio, Occupied Bandwidth, Conducted Band-Edge and Conducted Spurious Emission

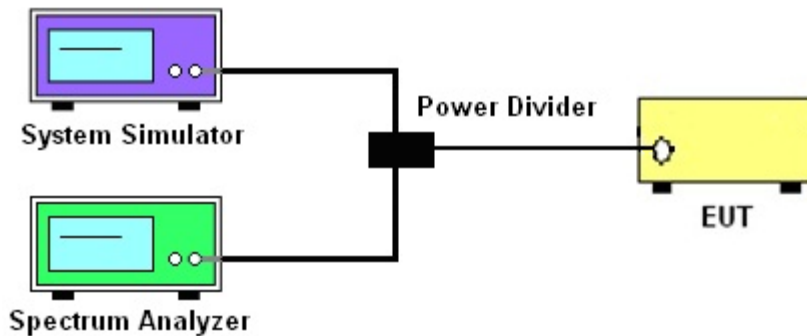

3.2.3 Frequency Stability

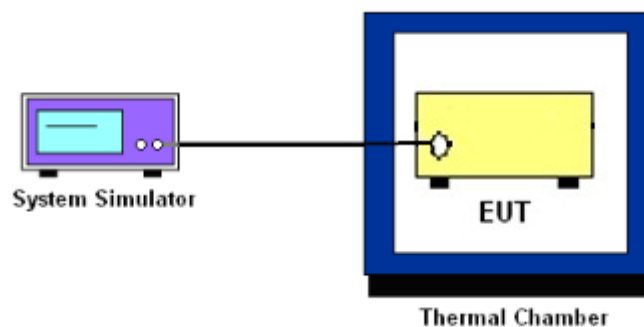

3.3 Test Result of Conducted Test

Please refer to Appendix A.



3.4 Conducted Output Power and EIRP

3.4.1 Description of the Conducted Output Power Measurement and EIRP Measurement

A system simulator was used to establish communication with the EUT. Its parameters were set to force the EUT transmitting at maximum output power. The measured power in the radio frequency on the transmitter output terminals shall be reported.

The EIRP of mobile transmitters must not exceed 1 Watts for 5G NR n77, n78.

According to KDB 412172 D01 Power Approach,

$EIRP = P_T + G_T - L_C$, $ERP = EIRP - 2.15$, where

P_T = transmitter output power in dBm

G_T = gain of the transmitting antenna in dBi

L_C = signal attenuation in the connecting cable between the transmitter and antenna in dB

3.4.2 Test Procedures

1. The testing follows ANSI C63.26 Section 5.2
2. The transmitter output port was connected to the system simulator.
3. Set EUT at maximum power through the system simulator.
4. Select lowest, middle, and highest channels for each band and different modulation.
5. Measure and record the power level from the system simulator.



3.5 Peak-to-Average Ratio

3.5.1 Description of the PAR Measurement

Power Complementary Cumulative Distribution Function (CCDF) curves provide a means for characterizing the power peaks of a digitally modulated signal on a statistical basis. A CCDF curve depicts the probability of the peak signal amplitude exceeding the average power level. Most contemporary measurement instrumentation include the capability to produce CCDF curves for an input signal provided that the instrument's resolution bandwidth can be set wide enough to accommodate the entire input signal bandwidth. In measuring transmissions in this band using an average power technique, the peak-to-average ratio (PAR) of the transmission may not exceed 13 dB.

3.5.2 Test Procedures

1. The testing follows ANSI C63.26 Section 5.2.3.4 (CCDF).
2. The EUT was connected to spectrum and system simulator via a power divider.
3. Set the CCDF (Complementary Cumulative Distribution Function) option in spectrum analyzer.
4. The highest RF powers were measured and recorded the maximum PAPR level associated with a probability of 0.1 %.
5. Record the deviation as Peak to Average Ratio.



3.6 Occupied Bandwidth

3.6.1 Description of Occupied Bandwidth Measurement

The occupied bandwidth is the width of a frequency band such that, below the lower and above the upper frequency limits, the mean powers emitted are each equal to a specified percentage 0.5% of the total mean transmitted power.

The 26 dB emission bandwidth is defined as the frequency range between two points, one above and one below the carrier frequency, at which the spectral density of the emission is attenuated 26 dB below the maximum in-band spectral density of the modulated signal. Spectral density (power per unit bandwidth) is to be measured with a detector of resolution bandwidth equal to approximately 1.0% of the emission bandwidth.

3.6.2 Test Procedures

1. The testing follows ANSI C63.26 Section 5.4
2. The EUT was connected to spectrum analyzer and system simulator via a power divider.
3. The spectrum analyzer center frequency is set to the nominal EUT channel center frequency. The span range for the spectrum analyzer shall be between two and five times the anticipated OBW.
4. The nominal resolution bandwidth (RBW) shall be in the range of 1 to 5 % of the anticipated OBW, and the VBW shall be at least 3 times the RBW.
5. Set the detection mode to peak, and the trace mode to max hold.
6. Determine the reference value: Set the EUT to transmit a modulated signal. Allow the trace to stabilize. Set the spectrum analyzer marker to the highest level of the displayed trace.
(this is the reference value)
7. Determine the “-26 dB down amplitude” as equal to (Reference Value – X).
8. Place two markers, one at the lowest and the other at the highest frequency of the envelope of the spectral display such that each marker is at or slightly below the “-X dB down amplitude” determined in step 6. If a marker is below this “-X dB down amplitude” value it shall be placed as close as possible to this value. The OBW is the positive frequency difference between the two markers.
9. Use the 99 % power bandwidth function of the spectrum analyzer and report the measured bandwidth.



3.7 Conducted Band Edge

3.7.1 Description of Conducted Band Edge Measurement

27.53(l)(2)

For mobile operations in the 3700-3980 MHz band, the conducted power of any emission outside the licensee's authorized bandwidth shall not exceed -13 dBm/MHz. Compliance with this paragraph is based on the use of measurement instrumentation employing a resolution bandwidth of 1 megahertz or greater. However, in the 1 megahertz bands immediately outside and adjacent to the licensee's frequency block, the minimum resolution bandwidth for the measurement shall be either one percent of the emission bandwidth of the fundamental emission of the transmitter or 350 kHz. In the bands between 1 and 5 MHz removed from the licensee's frequency block, the minimum resolution bandwidth for the measurement shall be 500 kHz.

3.7.2 Test Procedures

1. The testing follows ANSI C63.26 section 5.7
2. The EUT was connected to spectrum analyzer and system simulator via a power divider.
3. The band edges of low and high channels for the highest RF powers were measured.
4. Set RBW \geq 1% EBW in the 1MHz band immediately outside and adjacent to the band edge.
5. Beyond the 1 MHz band from the band edge, RBW=1MHz was used.
6. Set spectrum analyzer with RMS detector.
7. The RF fundamental frequency should be excluded against the limit line in the operating frequency band.
8. Checked that all the results comply with the emission limit line.

Example:

The limit line is derived from $43 + 10\log(P)$ dB below the transmitter power P(Watts)
 $= P(W) - [43 + 10\log(P)]$ (dB)
 $= [30 + 10\log(P)]$ (dBm) - $[43 + 10\log(P)]$ (dB) = -13dBm.

9. When using the integration method, the starting frequency of the integration shall be centered at one-half of the RBW away from the band edge.



3.8 Conducted Spurious Emission

3.8.1 Description of Conducted Spurious Emission Measurement

The power of any emission outside of the authorized operating frequency ranges must be lower than the transmitter power (P) by a factor of at least $43 + 10 \log (P)$ dB.

It is measured by means of a calibrated spectrum analyzer and scanned from 30 MHz up to a frequency including its 10th harmonic.

3.8.2 Test Procedures

1. The testing follows ANSI C63.26 section 5.7
2. The EUT was connected to spectrum analyzer and system simulator via a power divider.
3. The RF output of EUT was connected to the spectrum analyzer by RF cable and attenuator. The path loss was compensated to the results for each measurement.
4. The middle channel for the highest RF power within the transmitting frequency was measured.
5. The conducted spurious emission for the whole frequency range was taken.
6. Make the measurement with the spectrum analyzer's RBW = 1MHz, VBW = 3MHz.
7. Set spectrum analyzer with RMS detector.
8. Taking the record of maximum spurious emission.
9. The RF fundamental frequency should be excluded against the limit line in the operating frequency band.
10. The limit line is derived from $43 + 10\log(P)$ dB below the transmitter power P(Watts)
= P(W)- [43 + 10log(P)] (dB)
= [30 + 10log(P)] (dBm) - [43 + 10log(P)] (dB)
= -13dBm.



3.9 Frequency Stability

3.9.1 Description of Frequency Stability Measurement

The frequency stability shall be measured by variation of ambient temperature and variation of primary supply voltage to ensure that the fundamental emission stays within the authorized frequency block. The frequency stability of the transmitter shall be maintained within $\pm 0.00025\%$ ($\pm 2.5\text{ppm}$) of the center frequency.

3.9.2 Test Procedures for Temperature Variation

1. The testing follows ANSI C63.26 section 5.6.4
2. The EUT was set up in the thermal chamber and connected with the system simulator.
3. With power OFF, the temperature was decreased to -30°C and the EUT was stabilized before testing. Power was applied and the maximum change in frequency was recorded within one minute.
4. With power OFF, the temperature was raised in 10°C step up to 50°C . The EUT was stabilized at each step for at least half an hour. Power was applied and the maximum frequency change was recorded within one minute.

3.9.3 Test Procedures for Voltage Variation

1. The testing follows ANSI C63.26 section 5.6.5
2. The EUT was placed in a temperature chamber at $20\pm 5^{\circ}\text{C}$ and connected with the system simulator.
3. The power supply voltage to the EUT was varied from 85% to 115% of the nominal value for other than hand carried battery equipment.
4. For hand carried, battery powered equipment, reduce the primary ac or dc supply voltage to the battery operating end point, which shall be specified by the manufacturer.
5. The variation in frequency was measured for the worst case.

4 Radiated Test Items

4.1 Measuring Instruments

See list of measuring instruments of this test report.

4.2 Test Setup

4.2.1 For radiated test below 30MHz

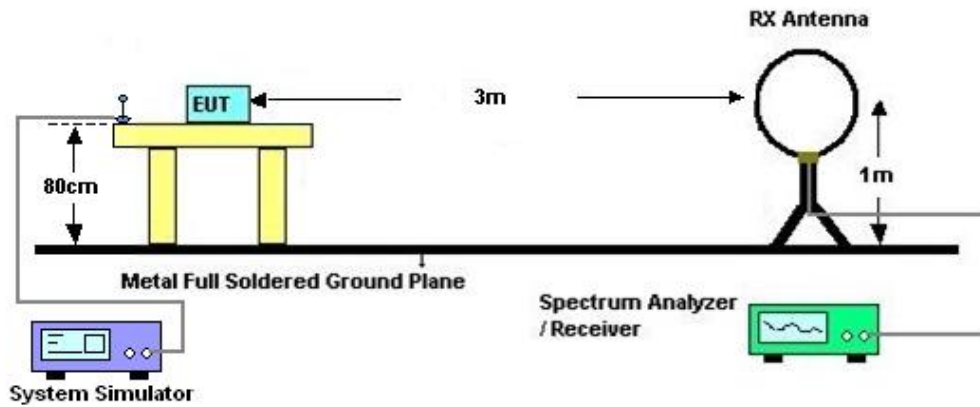

4.2.2 For radiated test from 30MHz to 1GHz

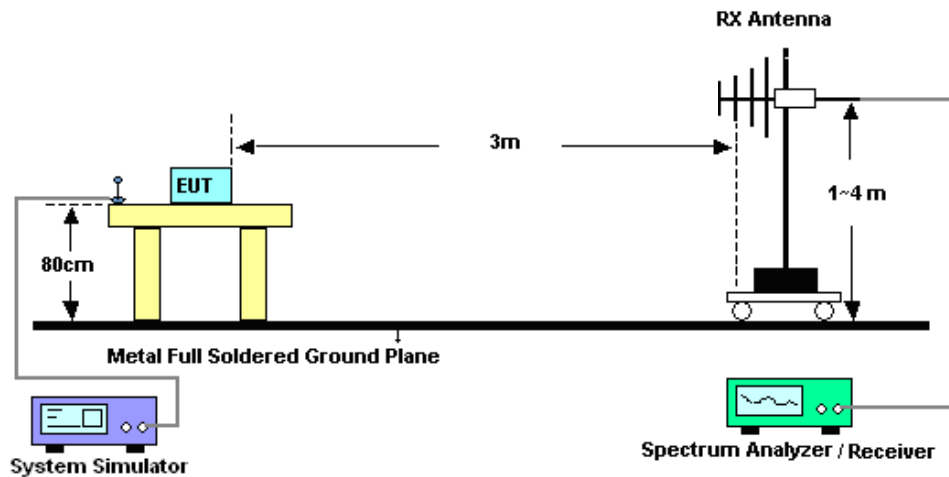

4.2.3 For radiated test above 1GHz

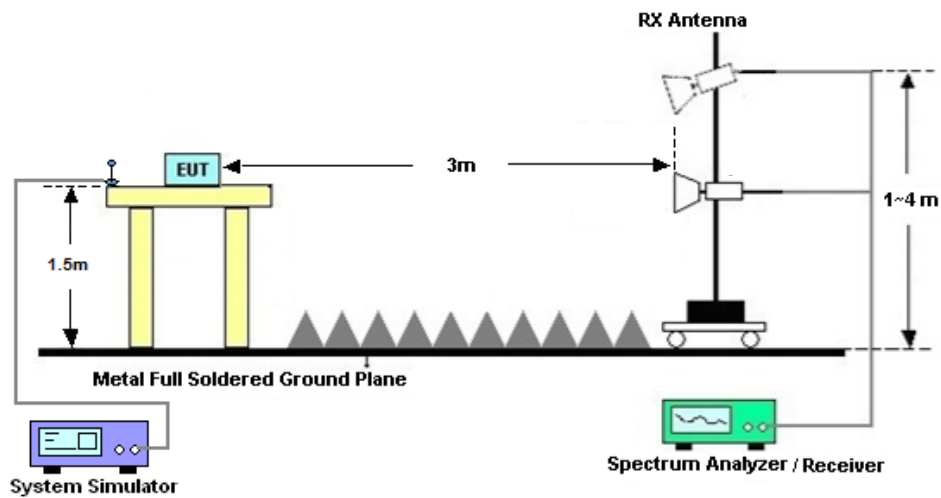

4.3 Test Result of Radiated Test

The low frequency, which started from 9 kHz to 30MHz, was pre-scanned and the result which was 20dB lower than the limit line was not reported.

Please refer to Appendix B.



4.4 Radiated Spurious Emission

4.4.1 Description of Radiated Spurious Emission

The radiated spurious emission was measured by substitution method according to ANSI C63.26. The power of any emission outside of the authorized operating frequency ranges must be attenuated below the transmitter power (P) by a factor of at least $43 + 10 \log (P)$ dB.

The spectrum is scanned from 30 MHz up to a frequency including its 10th harmonic.

4.4.2 Test Procedures

1. The testing follows ANSI C63.26 Section 5.5
2. The EUT was placed on a turntable with 0.8 meter height for frequency below 1GHz and 1.5 meter height for frequency above 1GHz respectively above ground.
3. The EUT was set 3 meters from the receiving antenna mounted on the antenna tower.
4. The table was rotated 360 degrees to determine the position of the highest spurious emission.
5. The height of the receiving antenna is varied between 1m to 4m to search the maximum spurious emission for both horizontal and vertical polarizations.
6. During the measurement, the system simulator parameters were set to force the EUT transmitting at maximum output power.
7. Make the measurement with the spectrum analyzer's RBW = 1MHz, VBW = 3MHz, taking the record of maximum spurious emission.
8. A horn antenna was substituted in place of the EUT and was driven by a signal generator.
9. Tune the output power of signal generator to the same emission level with EUT maximum spurious emission.
10. $EIRP \text{ (dBm)} = S.G. \text{ Power} - Tx \text{ Cable Loss} + Tx \text{ Antenna Gain}$
11. $ERP \text{ (dBm)} = EIRP - 2.15$
12. The RF fundamental frequency should be excluded against the limit line in the operating frequency band.

The limit line is derived from $43 + 10\log(P)$ dB below the transmitter power P(Watts)
= $P(W) - [43 + 10\log(P)] \text{ (dB)}$
= $[30 + 10\log(P)] \text{ (dBm)} - [43 + 10\log(P)] \text{ (dB)}$
= -13dBm.



5 List of Measuring Equipment

Instrument	Manufacturer	Model No.	Serial No.	Characteristics	Calibration Date	Test Date	Due Date	Remark
Spectrum Analyzer	R&S	FSV40	101040	10Hz~40GHz	Oct. 14, 2021	Jun. 12, 2022~ Jun. 15, 2022	Oct. 13, 2022	Conducted (TH01-KS)
Power divider	STI	STI08-0055	-	0.5~40GHz	Aug. 26, 2021	Jun. 12, 2022~ Jun. 15, 2022	Aug. 25, 2022	Conducted (TH01-KS)
Temperature & humidity chamber	Hongzhan	LP-150U	H2014011440	-40~+150°C 20%~95%RH	Jul. 12, 2022	Jun. 12, 2022~ Jun. 15, 2022	Jul. 11, 2023	Conducted (TH01-KS)
EXA Spectrum Analyzer	Keysight	N9010B	MY57541079	10Hz-44G,MAX 30dB	Oct. 13, 2021	Jun. 10, 2022	Oct. 12, 2022	Radiation (03CH04-KS)
Loop Antenna	R&S	HFH2-Z2	100321	9kHz~30MHz	Oct. 30, 2021	Jun. 10, 2022	Oct. 29, 2022	Radiation (03CH04-KS)
Bilog Antenna	TeseQ	CBL6111D	49922	30MHz-1GHz	May 24, 2022	Jun. 10, 2022	May 23, 2023	Radiation (03CH04-KS)
Horn Antenna	Schwarzbeck	BBHA9120D	1284	1GHz~18GHz	Jan. 05, 2022	Jun. 10, 2022	Jan. 04, 2023	Radiation (03CH04-KS)
SHF-EHF Horn	Com-power	AH-840	101070	18GHz~40GHz	Jan. 05, 2022	Jun. 10, 2022	Jan. 04, 2023	Radiation (03CH04-KS)
Amplifier	SONOMA	310N	187289	9KHz-1GHz	Jan. 05, 2022	Jun. 10, 2022	Jan. 04, 2023	Radiation (03CH04-KS)
high gain Amplifier	MITEQ	AMF-7D-00 101800-30-1 QP	2025788	1Ghz-18Ghz	Jul. 30, 2021	Jun. 10, 2022	Jul. 29, 2022	Radiation (03CH04-KS)
Amplifier	Keysight	83017A	MY57280106	500MHz~26.5GHz	Oct. 13, 2021	Jun. 10, 2022	Oct. 12, 2022	Radiation (03CH04-KS)
Amplifier	MITEQ	EM18G40G GA	060728	18~40GHz	Jan. 05, 2022	Jun. 10, 2022	Jan. 04, 2023	Radiation (03CH04-KS)
AC Power Source	Chroma	61601	F104090004	N/A	NCR	Jun. 10, 2022	NCR	Radiation (03CH04-KS)
Turn Table	ChamPro	EM 1000-T	060762-T	0~360 degree	NCR	Jun. 10, 2022	NCR	Radiation (03CH04-KS)
Antenna Mast	ChamPro	EM 1000-A	060762-A	1 m~4 m	NCR	Jun. 10, 2022	NCR	Radiation (03CH04-KS)

NCR: No Calibration Required



6 Uncertainty of Evaluation

The measurement uncertainties shown below were calculated in accordance with the requirements of ANSI 63.26-2015. All the measurement uncertainty value were shown with a coverage K=2 to indicate 95% level of confidence. The measurement data show herein meets or exceeds the CISPR measurement uncertainty values specified in CISPR 16-4-2 and can be compared directly to specified limit to determine compliance.

Uncertainty of Conducted Measurement

Test Item	Uncertainty
Conducted Power	0.56 dB
Conducted Emissions	0.92 dB
Occupied Channel Bandwidth	0.03 %
Conducted Power Spectral Density	0.54 dB
Conducted emission	0.92
Frequency tolerance	0.414ppm

Uncertainty of Radiated Emission Measurement (30 MHz ~ 1000 MHz)

Measuring Uncertainty for a Level of Confidence of 95% (U = 2Uc(y))	3.3dB
---	-------

Uncertainty of Radiated Emission Measurement (1 GHz ~ 18 GHz)

Measuring Uncertainty for a Level of Confidence of 95% (U = 2Uc(y))	2.8dB
---	-------

Uncertainty of Radiated Emission Measurement (18 GHz ~ 40 GHz)

Measuring Uncertainty for a Level of Confidence of 95% (U = 2Uc(y))	2.8dB
---	-------

----- THE END -----



Appendix A. Test Results of Conducted Test

Test Engineer :	Lex Wu	Temperature :	22~23°C
		Relative Humidity :	40~42%

Conducted Output Power and EIRP

5G NR n77 SA:

BW [MHz]	Modulation	RB Size	RB Offset	Power Low Ch. / Freq.	Power Middle Ch. / Freq.	Power High Ch. / Freq.	Gain	EIRP		
								L	M	H
Channel				650000	656000	662000		L	M	H
Frequency (MHz)				3750	3840	3930				
100	PI/2 BPSK	1	1	25.38	25.52	25.12	-4.1	0.1343	0.1387	0.1265
100	QPSK	1	1	25.41	25.75	25.01	-4.1	0.1352	0.1462	0.1233
100	QPSK	1	137	25.31	25.10	25.21	-4.1	0.1321	0.1259	0.1291
100	QPSK	1	271	25.08	24.97	24.98	-4.1	0.1253	0.1222	0.1225
100	QPSK	135	0	24.98	24.83	24.77	-4.1	0.1225	0.1183	0.1167
100	QPSK	135	69	25.29	25.19	25.13	-4.1	0.1315	0.1285	0.1268
100	QPSK	135	138	24.72	24.85	25.01	-4.1	0.1153	0.1189	0.1233
100	QPSK	270	0	24.89	24.71	24.97	-4.1	0.1199	0.1151	0.1222
100	16QAM	1	1	24.98	24.78	24.85	-4.1	0.1225	0.1169	0.1189
100	64QAM	1	1	23.10	22.81	23.01	-4.1	0.0794	0.0743	0.0778
100	256QAM	1	1	21.42	21.45	21.66	-4.1	0.0540	0.0543	0.0570
Channel				649668	656000	662334	Gain	L	M	H
Frequency (MHz)				3745.02	3840	3935.01				
90	PI/2 BPSK	1	1	25.41	25.34	24.95	-4.1	0.1352	0.1330	0.1216
Channel				649334	656000	662666	Gain	L	M	H
Frequency (MHz)				3740.01	3840	3939.99				
80	PI/2 BPSK	1	1	25.45	25.38	25.40	-4.1	0.1365	0.1343	0.1349
Channel				649000	656000	663000	Gain	L	M	H
Frequency (MHz)				3735	3840	3945				
70	PI/2 BPSK	1	1	25.45	25.34	25.00	-4.1	0.1365	0.1330	0.1230
Channel				648668	656000	663332	Gain	L	M	H
Frequency (MHz)				3730.02	3840	3949.98				
60	PI/2 BPSK	1	1	25.60	25.40	25.32	-4.1	0.1413	0.1349	0.1324
Channel				648334	656000	663668	Gain	L	M	H
Frequency (MHz)				3725.01	3840	3955.02				
50	PI/2 BPSK	1	1	25.41	25.47	25.34	-4.1	0.1352	0.1371	0.1330
Channel				648000	656000	664000	Gain	L	M	H
Frequency (MHz)				3720	3840	3960				
40	PI/2 BPSK	1	1	25.61	25.72	25.44	-4.1	0.1416	0.1452	0.1361
Channel				647668	656000	664332	Gain	L	M	H
Frequency (MHz)				3715.02	3840	3964.98				
30	PI/2 BPSK	1	1	25.61	25.62	25.44	-4.1	0.1416	0.1419	0.1361



Channel				647334	656000	664666	Gain	L	M	H
Frequency (MHz)				3710.01	3840	3969.99				
20	PI/2 BPSK	1	1	25.72	25.43	25.57	-4.1	0.1452	0.1358	0.1403
Channel				647168	656000	664832	Gain	L	M	H
Frequency (MHz)				3707.52	3840	3972.48				
15	PI/2 BPSK	1	1	25.69	25.57	25.45	-4.1	0.1442	0.1403	0.1365
Channel				647000	656000	665000	Gain	L	M	H
Frequency (MHz)				3705	3840	3975				
10	PI/2 BPSK	1	1	25.53	25.56	25.69	-4.1	0.1390	0.1400	0.1442



5G NR n78 SA:

BW [MHz]	Modulation	RB Size	RB Offset	Power Low Ch. / Freq.	Power Middle Ch. / Freq.	Power High Ch. / Freq.	Gain	EIRP		
Channel					650000					
Frequency (MHz)					3750				M	
100	PI/2 BPSK	1	1		25.40		-4.1		0.1349	
100	QPSK	1	1		25.69		-4.1		0.1442	
100	QPSK	1	137		25.40		-4.1		0.1349	
100	QPSK	1	271		25.11		-4.1		0.1262	
100	QPSK	135	0		25.02		-4.1		0.1236	
100	QPSK	135	69		25.12		-4.1		0.1265	
100	QPSK	135	138		24.80		-4.1		0.1175	
100	QPSK	270	0		24.85		-4.1		0.1189	
100	16QAM	1	1		24.98		-4.1		0.1225	
100	64QAM	1	1		23.01		-4.1		0.0778	
100	256QAM	1	1		21.74		-4.1		0.0581	
Channel				649668	650000	650334	Gain	L	M	H
Frequency (MHz)				3745.02	3750	3755.01				
90	PI/2 BPSK	1	1	25.20	25.26	25.24	-4.1	0.1288	0.1306	0.1300
Channel				649334	650000	650668	Gain	L	M	H
Frequency (MHz)				3740.01	3750	3760.02				
80	PI/2 BPSK	1	1	25.31	25.23	25.34	-4.1	0.1321	0.1297	0.1330
Channel				649000	650000	651000	Gain	L	M	H
Frequency (MHz)				3735	3750	3765				
70	PI/2 BPSK	1	1	25.32	25.34	25.12	-4.1	0.1324	0.1330	0.1265
Channel				648668	650000	651334	Gain	L	M	H
Frequency (MHz)				3730.02	3750	3770.01				
60	PI/2 BPSK	1	1	25.43	25.38	25.42	-4.1	0.1358	0.1343	0.1355
Channel				648334	650000	651668	Gain	L	M	H
Frequency (MHz)				3725.01	3750	3775.02				
50	PI/2 BPSK	1	1	25.23	25.39	25.34	-4.1	0.1297	0.1346	0.1330
Channel				648000	650000	652000	Gain	L	M	H
Frequency (MHz)				3720	3750	3780				
40	PI/2 BPSK	1	1	25.60	25.62	25.47	-4.1	0.1413	0.1419	0.1371
Channel				647668	650000	652334	Gain	L	M	H
Frequency (MHz)				3715.02	3750	3785.01				
30	PI/2 BPSK	1	1	25.62	25.65	25.49	-4.1	0.1419	0.1429	0.1377
Channel				647334	650000	652668	Gain	L	M	H
Frequency (MHz)				3710.01	3750	3790.02				
20	PI/2 BPSK	1	1	25.47	25.50	25.62	-4.1	0.1371	0.1380	0.1419
Channel				647168	650000	652834	Gain	L	M	H
Frequency (MHz)				3707.52	3750	3792.51				
15	PI/2 BPSK	1	1	25.61	25.50	25.43	-4.1	0.1416	0.1380	0.1358
Channel				647000	650000	653000	Gain	L	M	H
Frequency (MHz)				3705	3750	3795				
10	PI/2 BPSK	1	1	25.41	25.49	25.23	-4.1	0.1352	0.1377	0.1297



FR1 n77

Peak-to-Average Ratio

Mode	FR1 n77 / 20MHz / DFT-S OFDM		
Mod.	20M		Limit: 13dB
RB Size	BPSK	QPSK	Result
Middle CH	5.29	5.33	PASS

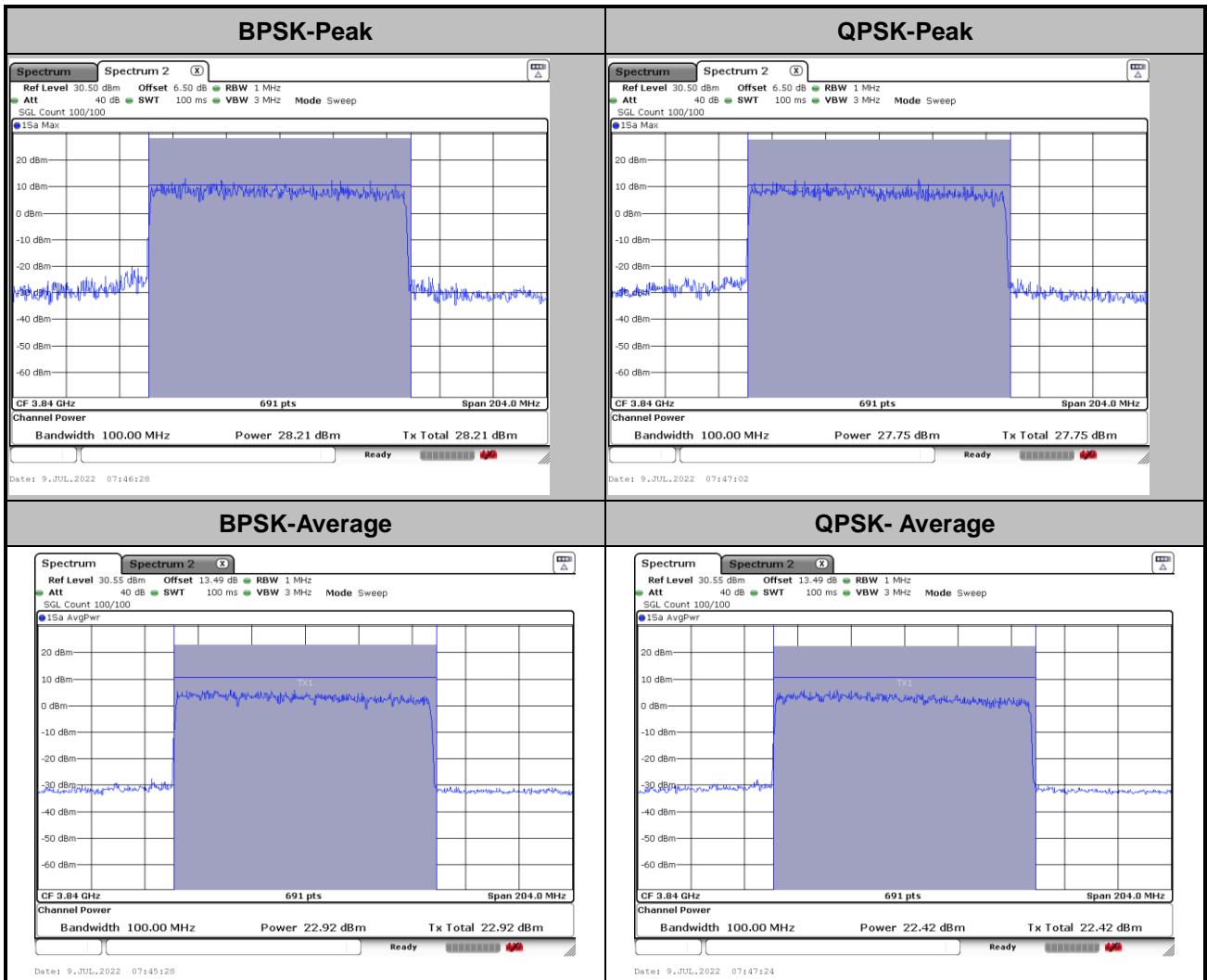



26dB Bandwidth

Mode	FR1 n77 : 26dB BW(10 MHz) / CP-OFDM			
Mod.	QPSK	16QAM	64QAM	256QAM
Middle CH	9.79	10.15	9.33	9.75
Mode	FR1 n77 : 26dB BW(15 MHz) / CP-OFDM			
Mod.	QPSK	16QAM	64QAM	256QAM
Middle CH	14.78	14.30	14.81	14.72
Mode	FR1 n77 : 26dB BW(20 MHz) / CP-OFDM			
Mod.	QPSK	16QAM	64QAM	256QAM
Middle CH	19.9	19.42	19.1	19.40
Mode	FR1 n77 : 26dB BW(30 MHz) / CP-OFDM			
Mod.	QPSK	16QAM	64QAM	256QAM
Middle CH	29.33	29.41	29.01	29.01
Mode	FR1 n77 : 26dB BW(40 MHz) / CP-OFDM			
Mod.	QPSK	16QAM	64QAM	256QAM
Middle CH	40.04	40.2	40.28	40.2
Mode	FR1 n77 : 26dB BW(50 MHz) / CP-OFDM			
Mod.	QPSK	16QAM	64QAM	256QAM
Middle CH	49.75	49.65	49.75	49.75
Mode	FR1 n77 : 26dB BW(60 MHz) / CP-OFDM			
Mod.	QPSK	16QAM	64QAM	256QAM
Middle CH	60.54	60.3	60.3	60.42
Mode	FR1 n77 : 26dB BW(70 MHz) / CP-OFDM			
Mod.	QPSK	16QAM	64QAM	256QAM
Middle CH	70.13	70.13	70.37	70.13
Mode	FR1 n77 : 26dB BW(80 MHz) / CP-OFDM			
Mod.	QPSK	16QAM	64QAM	256QAM
Middle CH	82.16	82.48	82.32	82.48
Mode	FR1 n77 : 26dB BW(90 MHz) / CP-OFDM			
Mod.	QPSK	16QAM	64QAM	256QAM
Middle CH	92.43	92.25	92.07	92.25
Mode	FR1 n77 : 26dB BW(100 MHz) / CP-OFDM			
Mod.	QPSK	16QAM	64QAM	256QAM
Middle CH	102.3	102.5	102.3	102.3



10MHz

QPSK

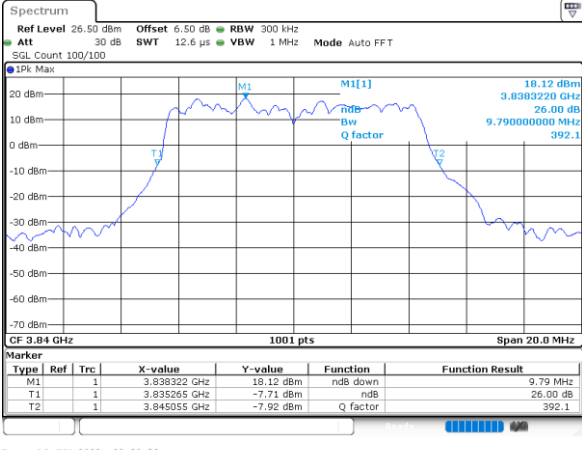

Date: 14 JUN 2022 23:30:53

16QAM

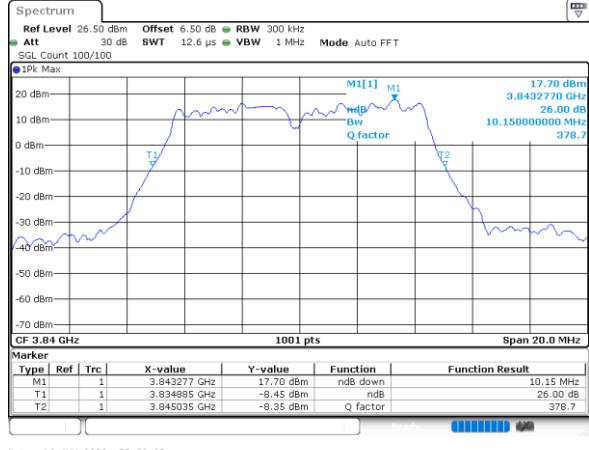

Date: 14 JUN 2022 23:29:35

64QAM

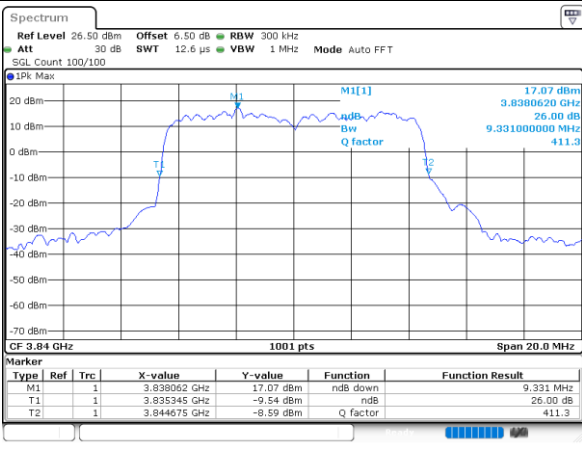

Date: 14 JUN 2022 23:27:15

256QAM

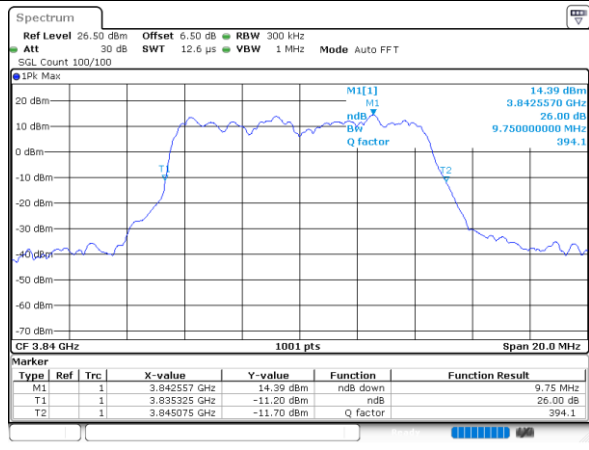

Date: 14 JUN 2022 23:25:27



15MHz

QPSK

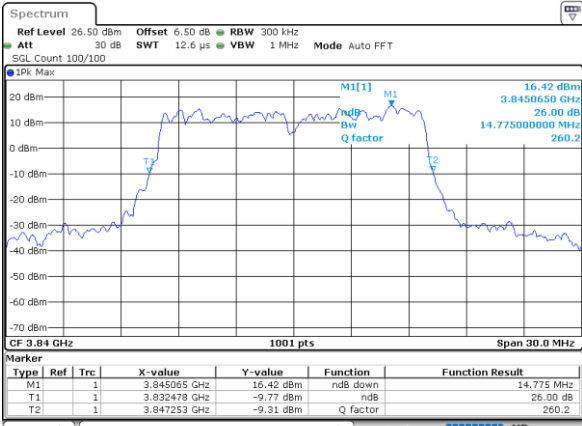

Date: 14 JUN 2022 23:19:15

16QAM

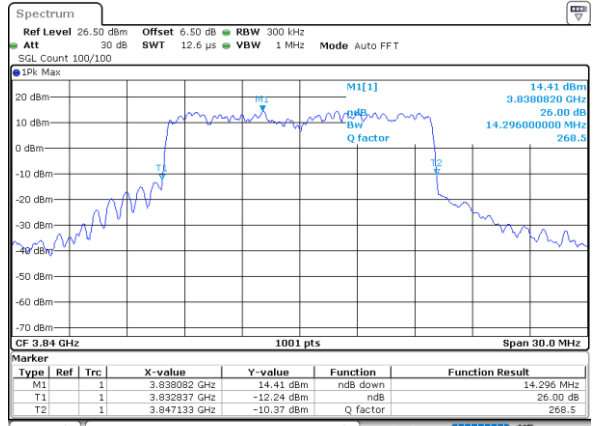

Date: 14 JUN 2022 23:19:51

64QAM

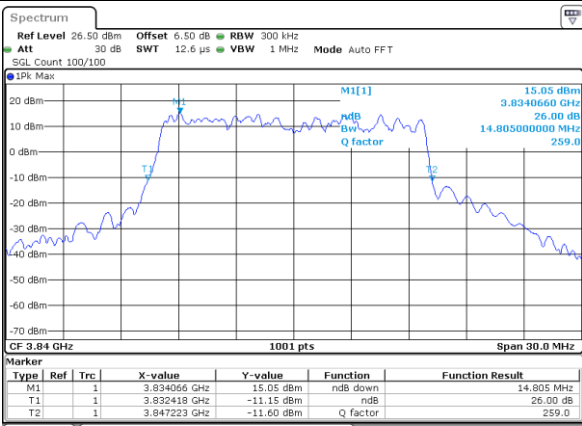

Date: 14 JUN 2022 23:20:42

256QAM

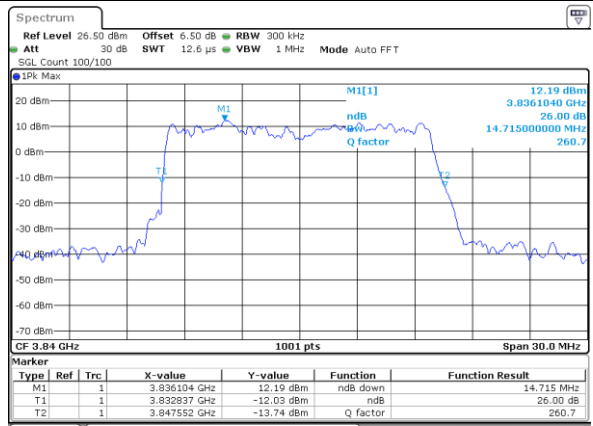

Date: 14 JUN 2022 23:22:29



20MHz

QPSK

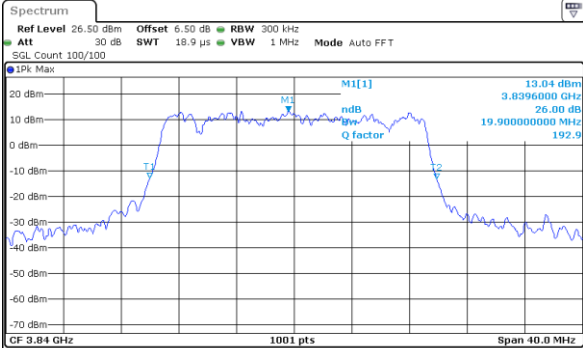

Date: 12_JUL_2022 06:12:09

16QAM

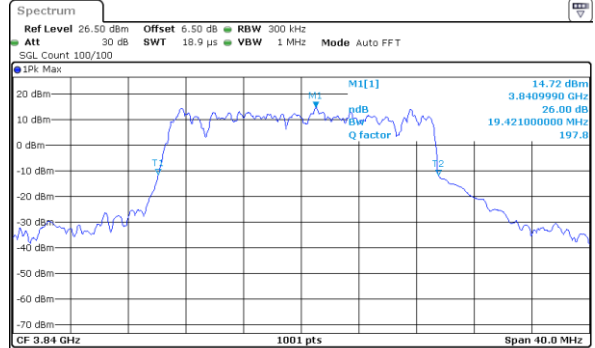

Date: 12_JUL_2022 06:12:157

64QAM

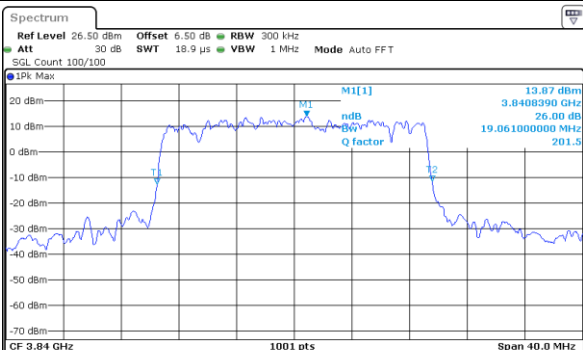

Date: 12_JUL_2022 06:12:143

256QAM

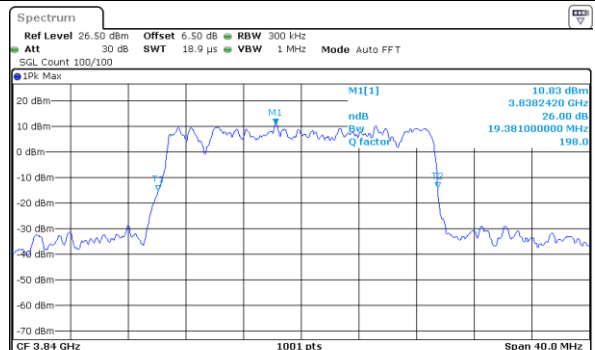

Date: 12_JUL_2022 06:12:329



30MHz

QPSK

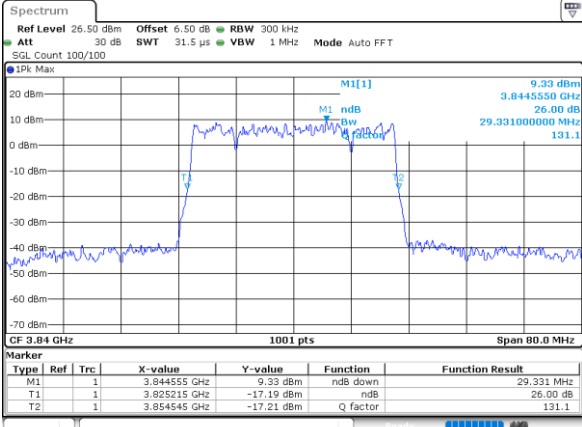

Date: 14 JUN 2022 23:09:56

16QAM

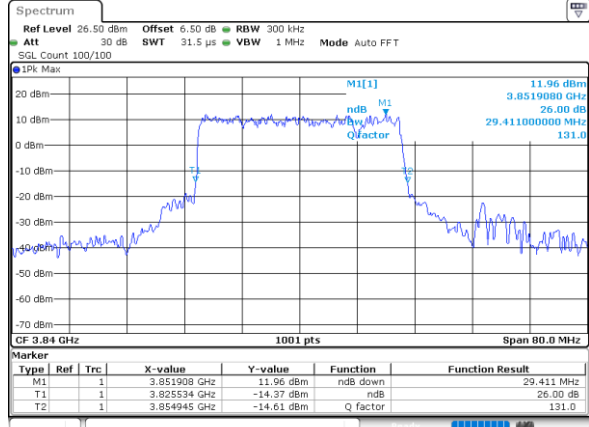

Date: 14 JUN 2022 23:10:49

64QAM

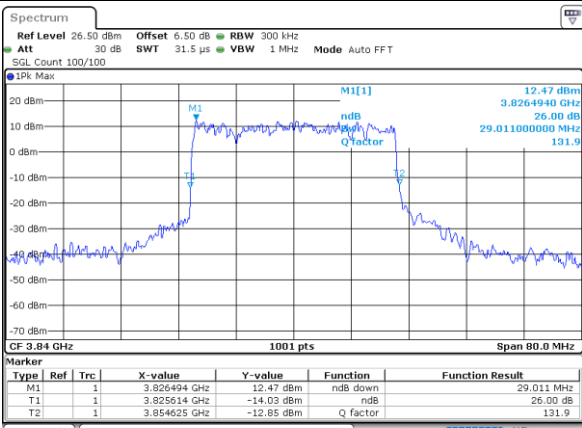

Date: 14 JUN 2022 23:11:17

256QAM

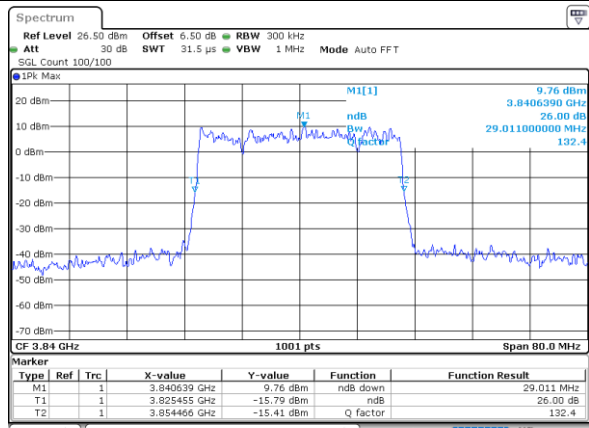

Date: 14 JUN 2022 23:11:41



40MHz

QPSK

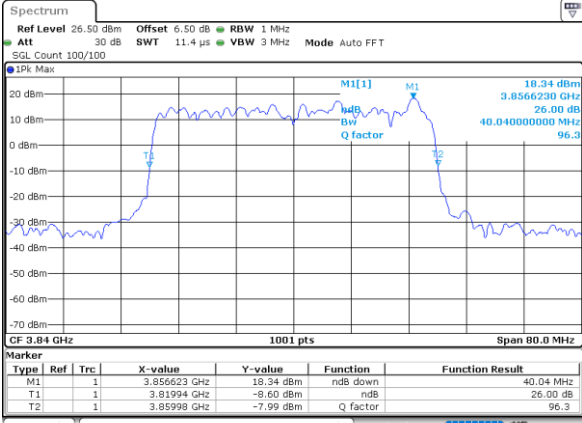

Date: 14 JUN 2022 22:57:51

16QAM

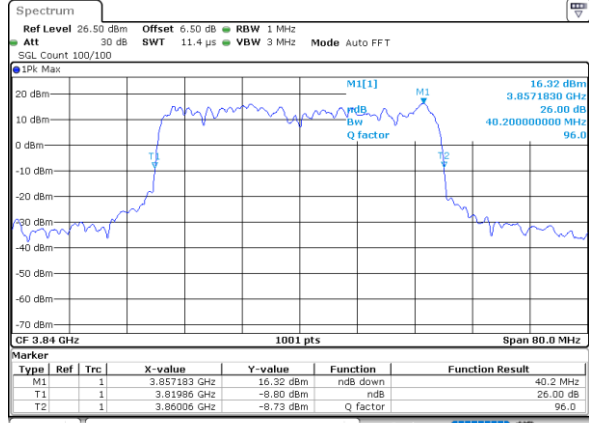

Date: 14 JUN 2022 22:59:44

64QAM

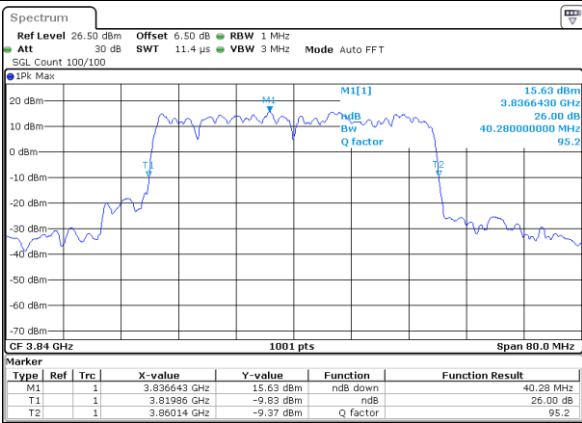

Date: 14 JUN 2022 23:00:07

256QAM

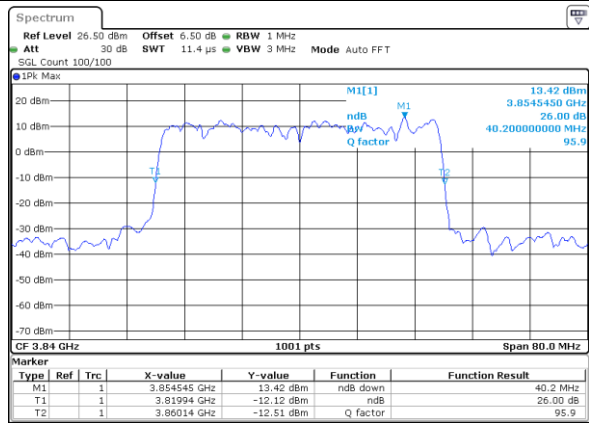

Date: 14 JUN 2022 23:00:38



50MHz

QPSK

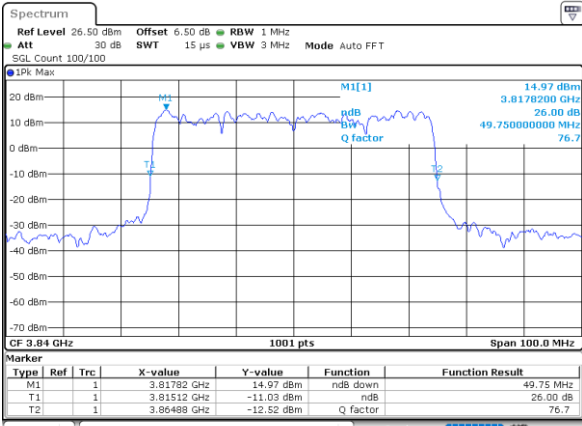

Date: 14 JUN 2022 22:54:36

16QAM

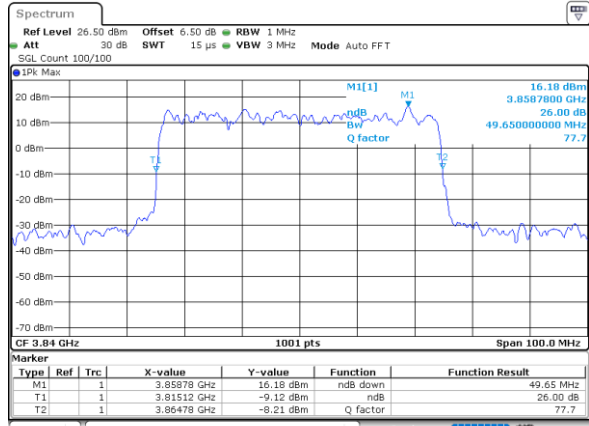

Date: 14 JUN 2022 22:54:58

64QAM

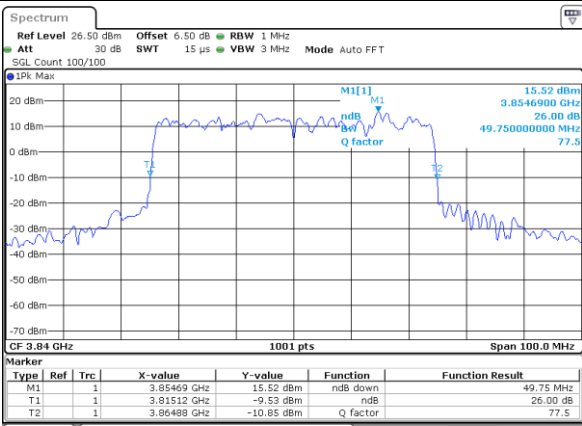

Date: 14 JUN 2022 22:56:28

256QAM

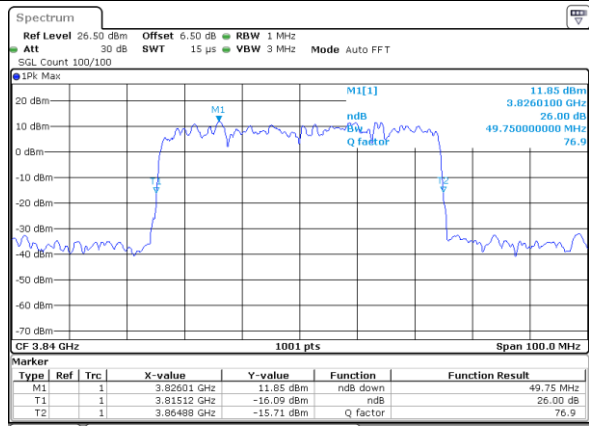

Date: 14 JUN 2022 22:56:59



60MHz

QPSK

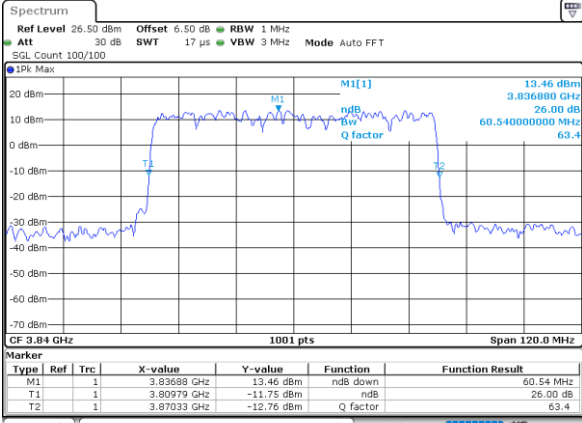

Date: 14 JUN 2022 22:08:11

16QAM

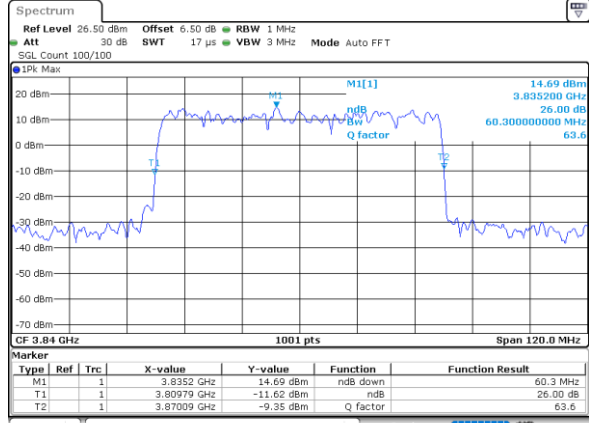

Date: 14 JUN 2022 22:08:34

64QAM

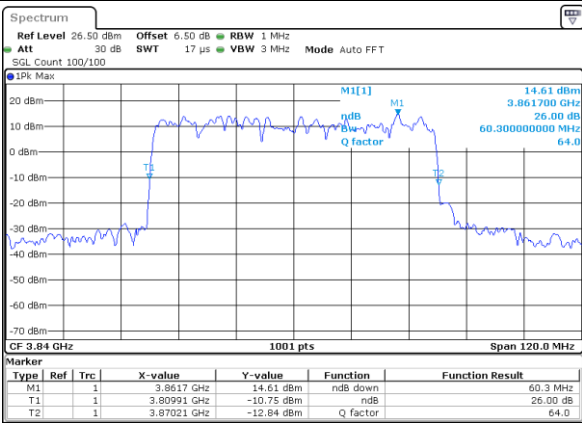

Date: 14 JUN 2022 22:08:53

256QAM

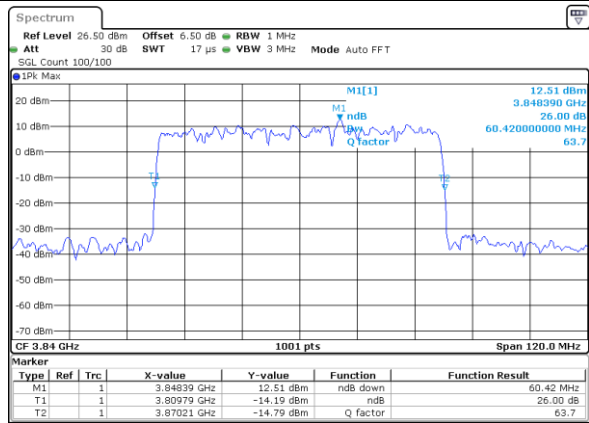

Date: 14 JUN 2022 22:09:19



70MHz

QPSK

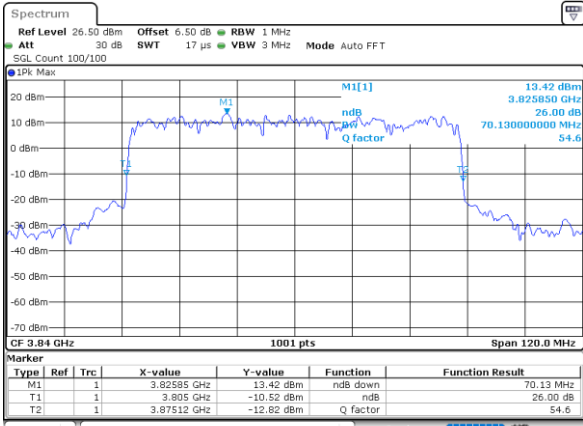

Date: 15 JUN 2022 21:50:12

16QAM

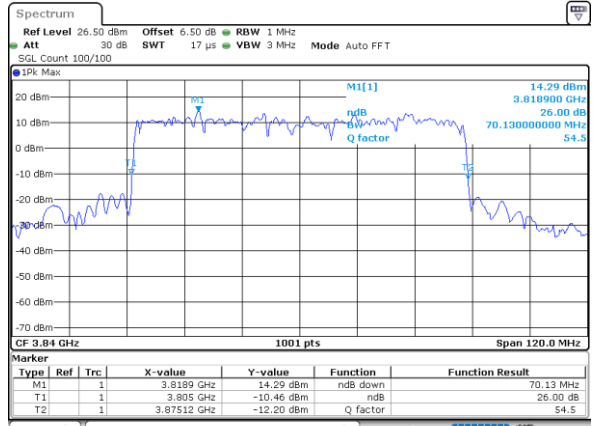

Date: 15 JUN 2022 21:50:57

64QAM

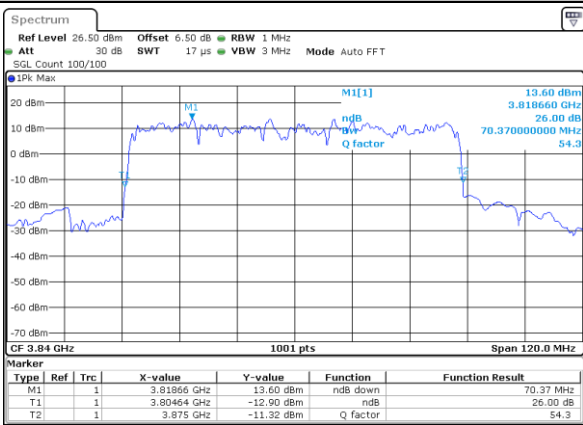

Date: 15 JUN 2022 21:51:15

256QAM

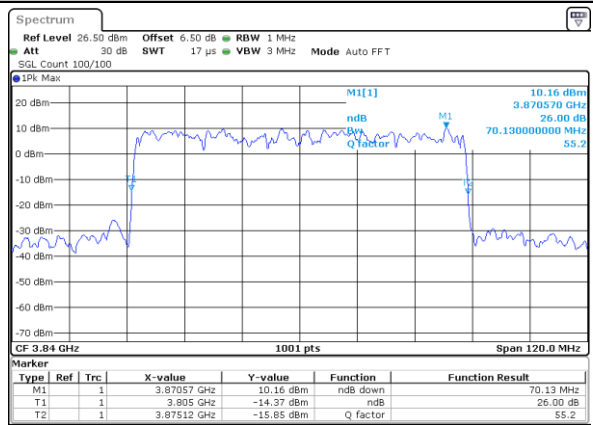

Date: 15 JUN 2022 21:51:39



80MHz

QPSK

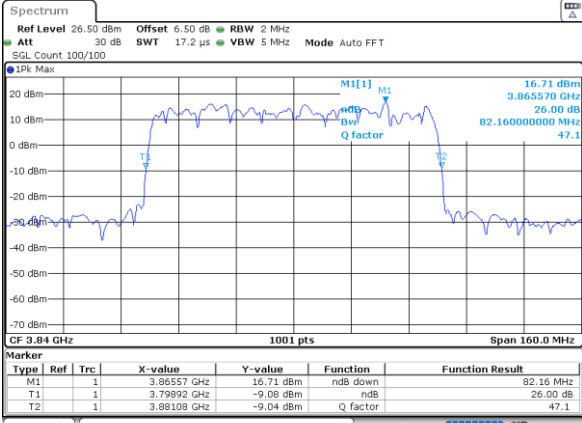

Date: 12 JUN 2022 05:03:42

16QAM

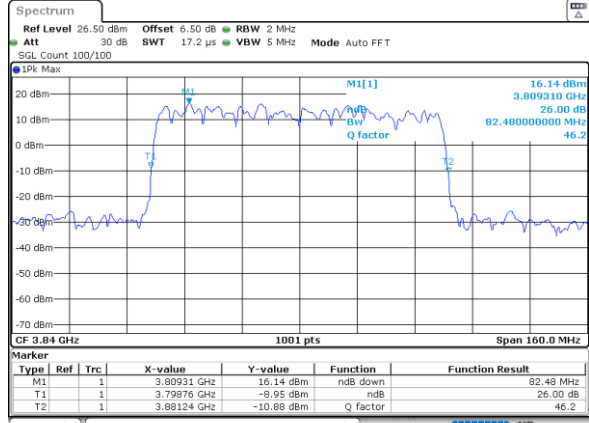

Date: 12 JUN 2022 05:02:17

64QAM

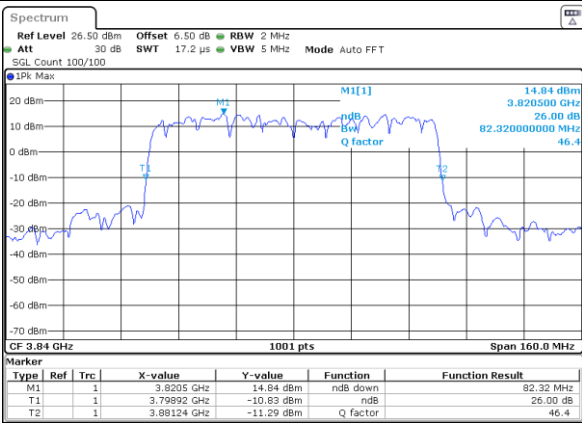

Date: 12 JUN 2022 05:01:50

256QAM

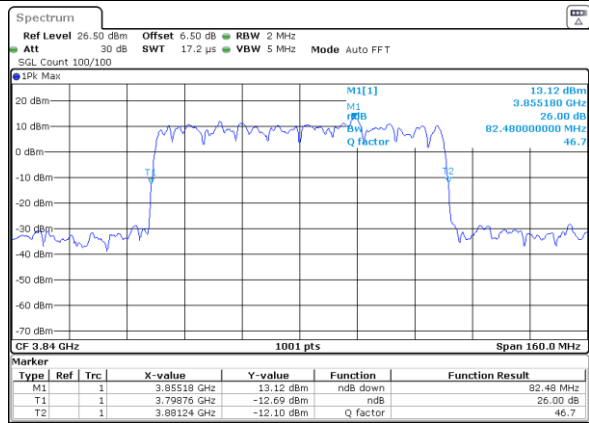

Date: 12 JUN 2022 05:01:20



90MHz

QPSK

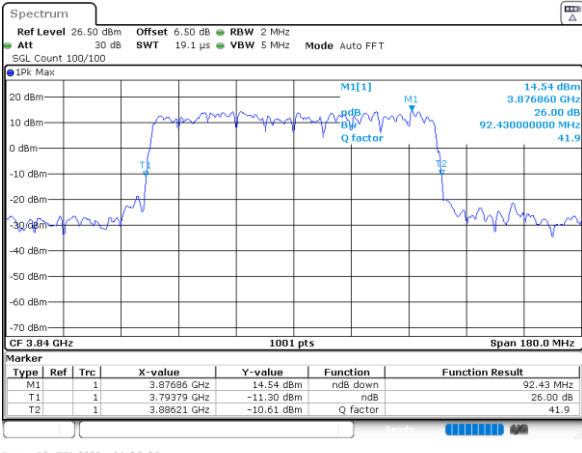

Date: 12 JUN 2022 04:56:36

16QAM

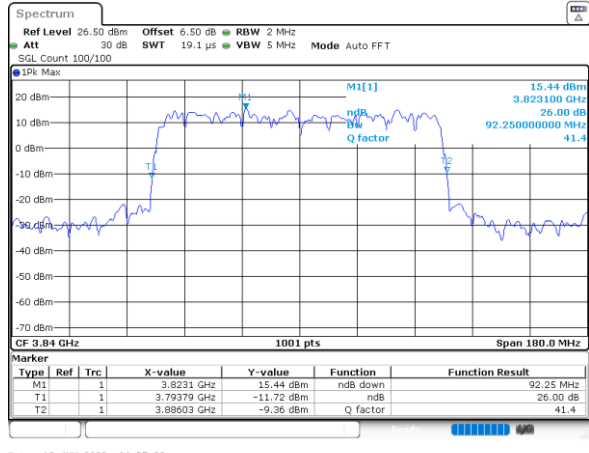

Date: 12 JUN 2022 04:57:39

64QAM

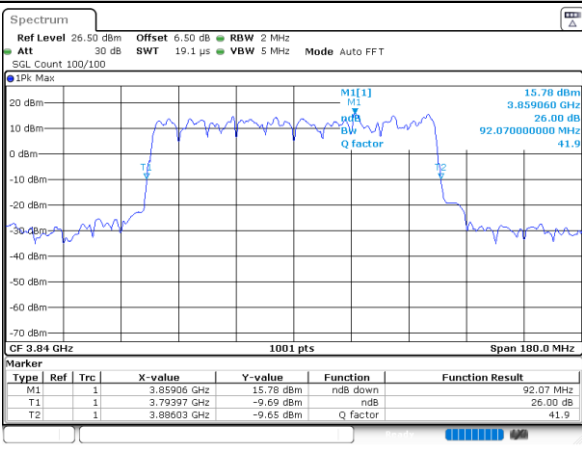

Date: 12 JUN 2022 04:58:58

256QAM

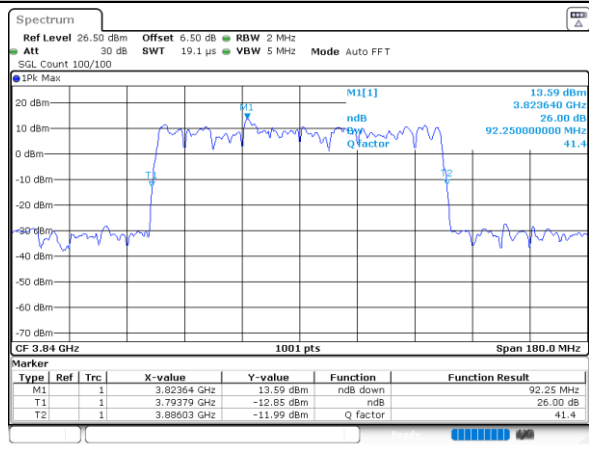

Date: 12 JUN 2022 04:59:26



100MHz

QPSK

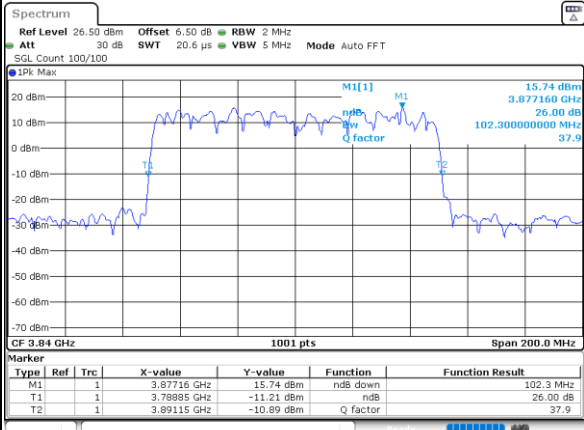

Date: 12 JUN 2022 04:10:14

16QAM

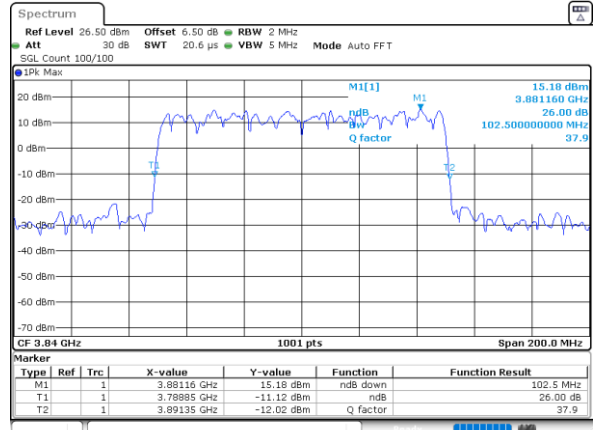

Date: 12 JUN 2022 04:13:34

64QAM

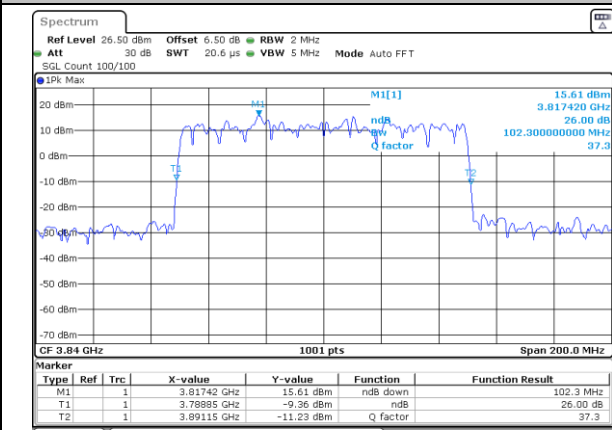

Date: 12 JUN 2022 04:13:58

256QAM

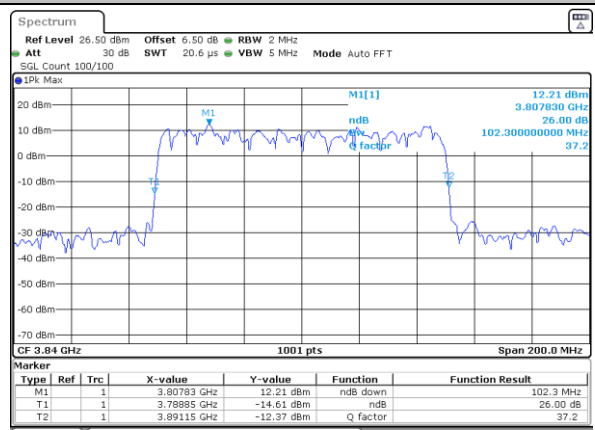

Date: 12 JUN 2022 04:14:33



Occupied Bandwidth

Mode	FR1 n77 : OB BW(10 MHz) / CP-S OFDM			
Mod.	QPSK	16QAM	64QAM	256QAM
Middle CH	8.73	8.69	8.67	8.75
Mode	FR1 n77 : OB BW(15 MHz) / CP-S OFDM			
Mod.	QPSK	16QAM	64QAM	256QAM
Middle CH	13.58	13.64	13.61	13.61
Mode	FR1 n77 : OB BW(20 MHz) / CP OFDM			
Mod.	QPSK	16QAM	64QAM	256QAM
Middle CH	18.27	18.10	18.30	18.22
Mode	FR1 n77 : OB BW(30 MHz) / CP OFDM			
Mod.	QPSK	16QAM	64QAM	256QAM
Middle CH	27.73	27.89	27.81	27.73
Mode	FR1 n77 : OB BW(40 MHz) / CP OFDM			
Mod.	QPSK	16QAM	64QAM	256QAM
Middle CH	38.04	38.04	38.12	37.88
Mode	FR1 n77 : OB BW(50 MHz) / CP OFDM			
Mod.	QPSK	16QAM	64QAM	256QAM
Middle CH	47.65	47.15	47.85	47.25
Mode	FR1 n77 : OB BW(60 MHz) / CP OFDM			
Mod.	QPSK	16QAM	64QAM	256QAM
Middle CH	58.02	57.42	57.90	57.54
Mode	FR1 n77 : OB BW(70 MHz) / CP OFDM			
Mod.	QPSK	16QAM	64QAM	256QAM
Middle CH	67.73	67.25	67.61	67.25
Mode	FR1 n77 : OB BW(80 MHz) / CP OFDM			
Mod.	QPSK	16QAM	64QAM	256QAM
Middle CH	78.16	77.84	78.64	77.84
Mode	FR1 n77 : OB BW(90 MHz) / CP OFDM			
Mod.	QPSK	16QAM	64QAM	256QAM
Middle CH	87.75	87.39	87.75	87.03
Mode	FR1 n77 : OB BW(100 MHz) / CP OFDM			
Mod.	QPSK	16QAM	64QAM	256QAM
Middle CH	97.90	97.30	97.70	97.70



10MHz

QPSK

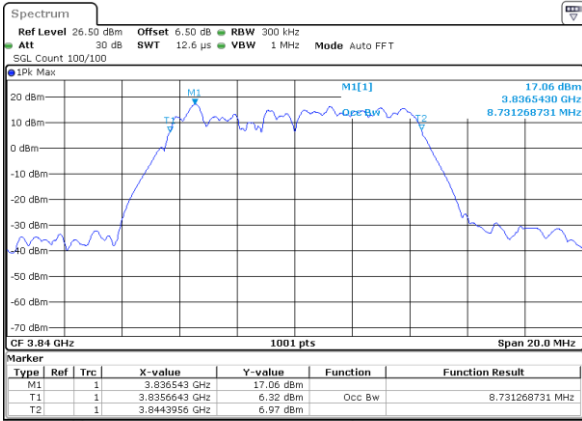

Date: 14 JUN 2022 23:30:45

16QAM

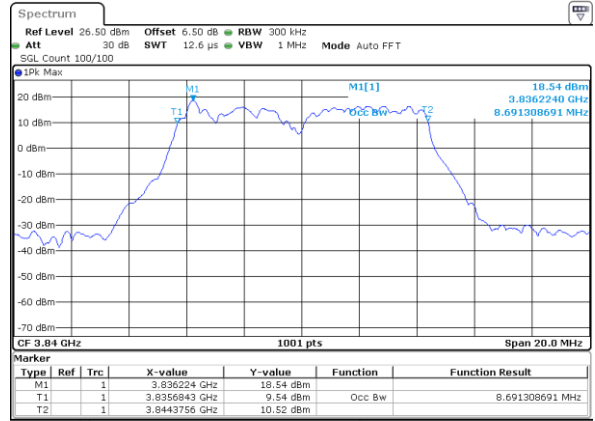

Date: 14 JUN 2022 23:29:15

64QAM

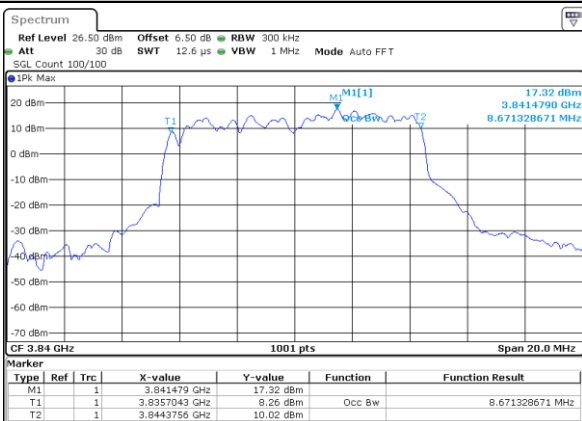

Date: 14 JUN 2022 23:27:01

256QAM

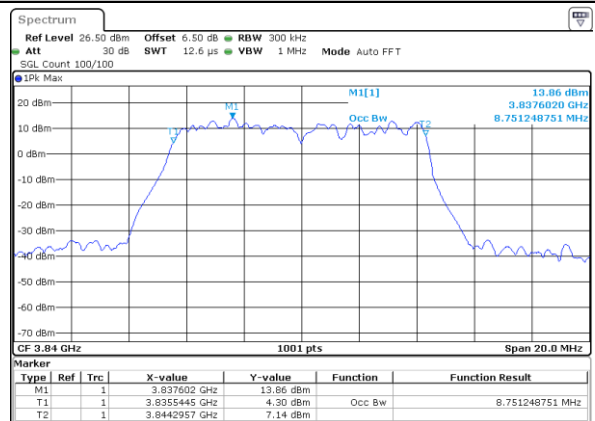

Date: 14 JUN 2022 23:24:32



15MHz

QPSK

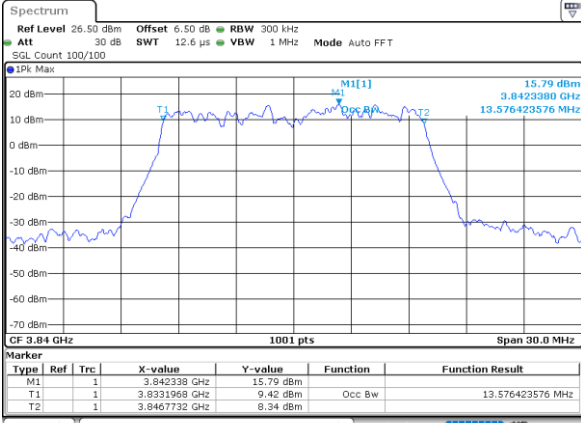

Date: 14 JUN 2022 23:18:55

16QAM

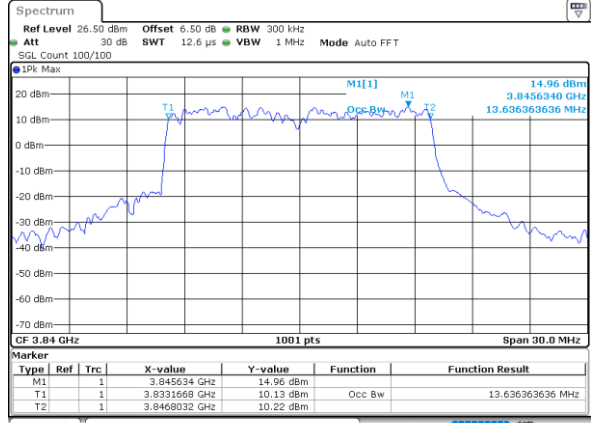

Date: 14 JUN 2022 23:19:35

64QAM

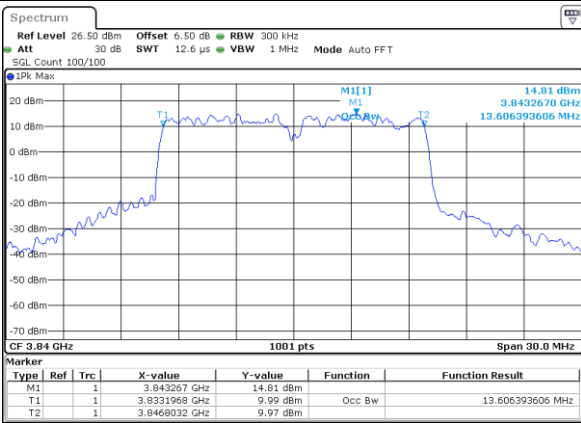

Date: 14 JUN 2022 23:20:05

256QAM

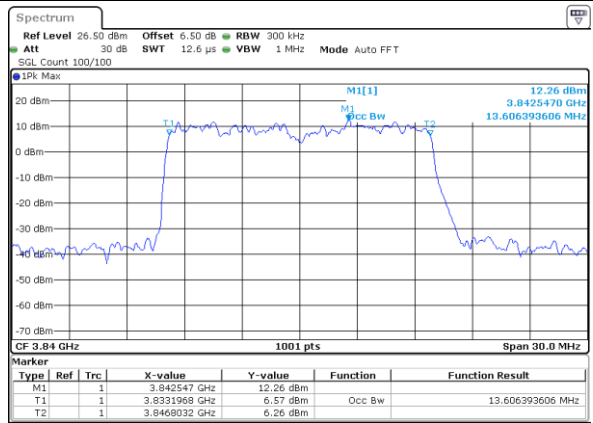

Date: 14 JUN 2022 23:22:22



20MHz

QPSK

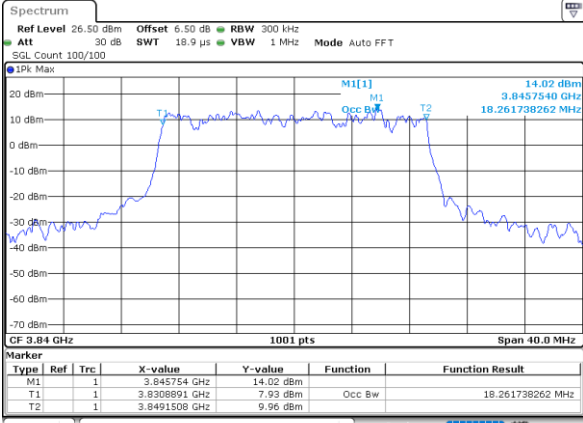

Date: 12_JUL_2022 05:33:22

16QAM

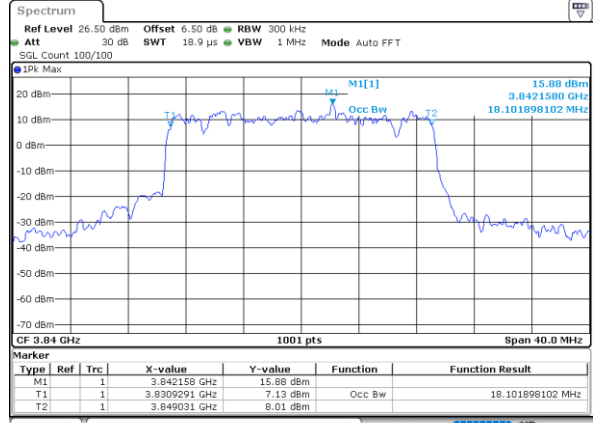

Date: 12_JUL_2022 05:33:44

64QAM

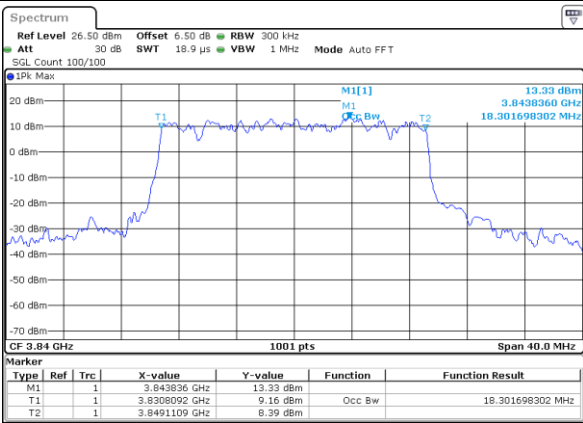

Date: 12_JUL_2022 05:34:07

256QAM

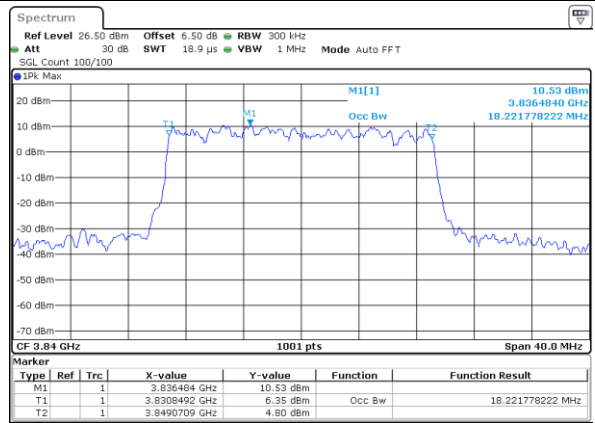

Date: 12_JUL_2022 05:34:32



30MHz

QPSK

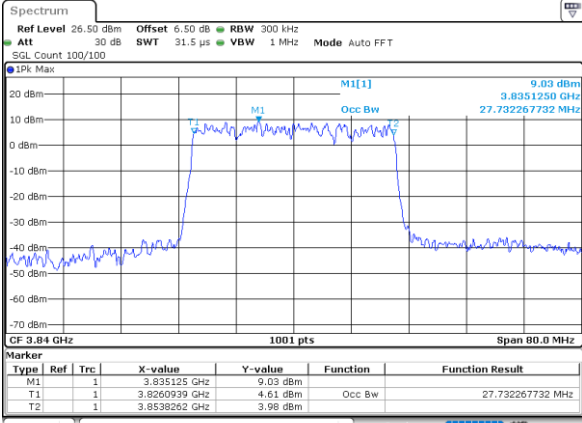

Date: 14 JUN 2022 23:09:49

16QAM

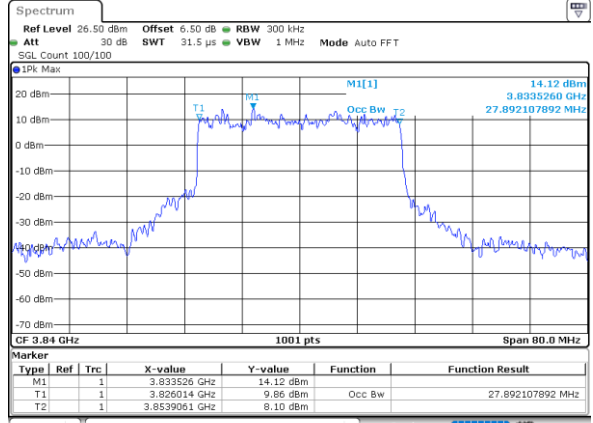

Date: 14 JUN 2022 23:10:11

64QAM

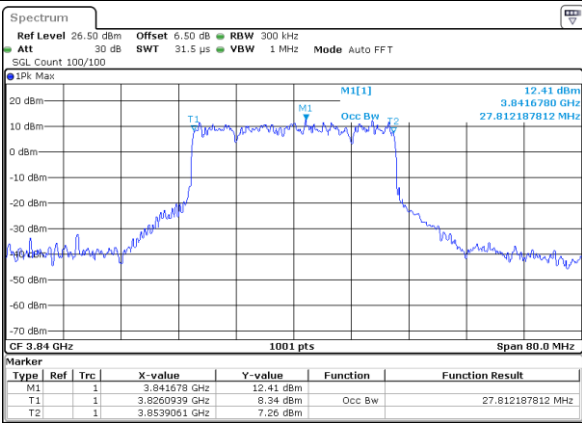

Date: 14 JUN 2022 23:11:02

256QAM

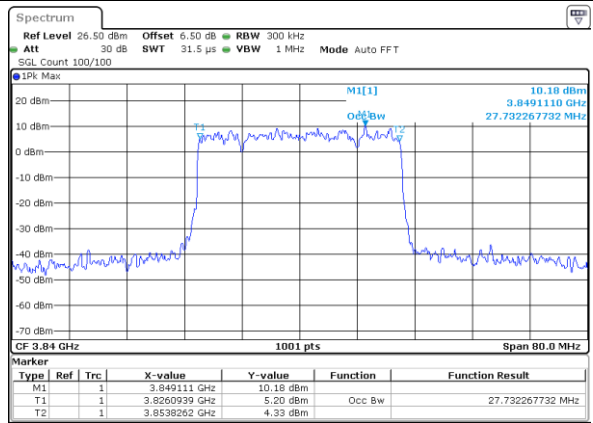

Date: 14 JUN 2022 23:11:29



40MHz

QPSK

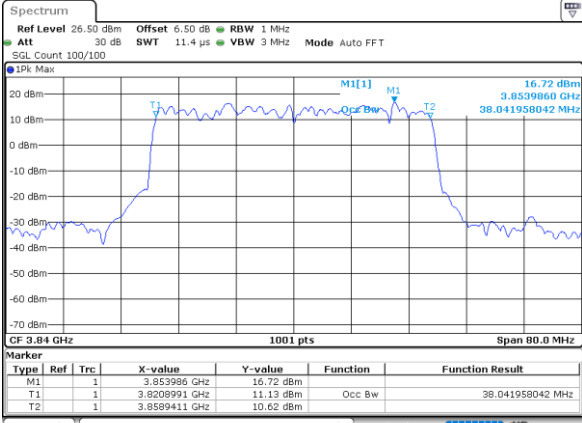

Date: 14 JUN 2022 22:57:45

16QAM

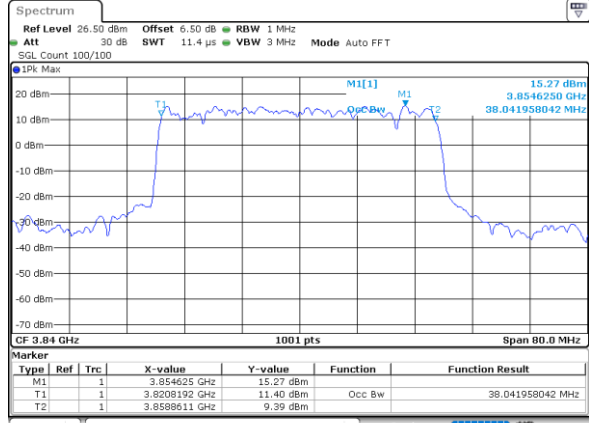

Date: 14 JUN 2022 22:58:03

64QAM

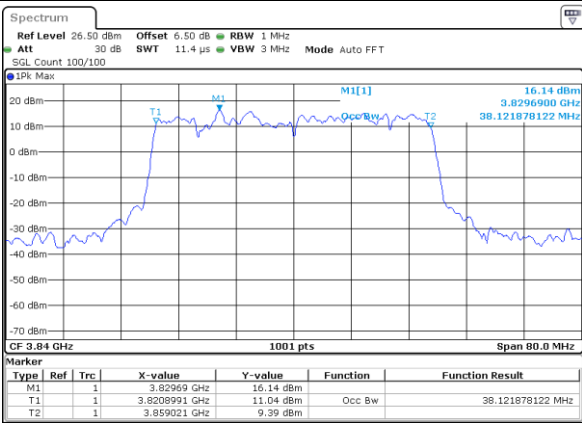

Date: 14 JUN 2022 22:59:59

256QAM

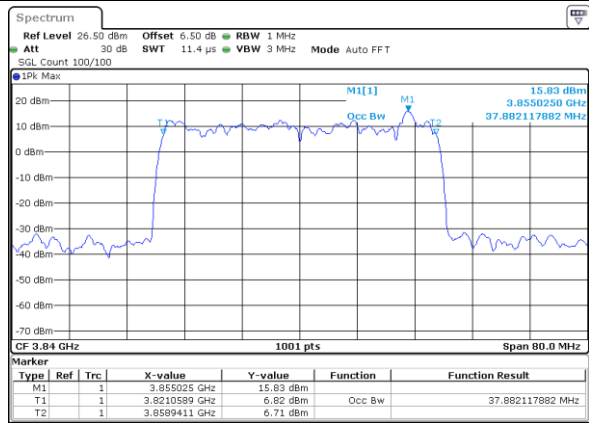

Date: 14 JUN 2022 23:00:30



50MHz

QPSK

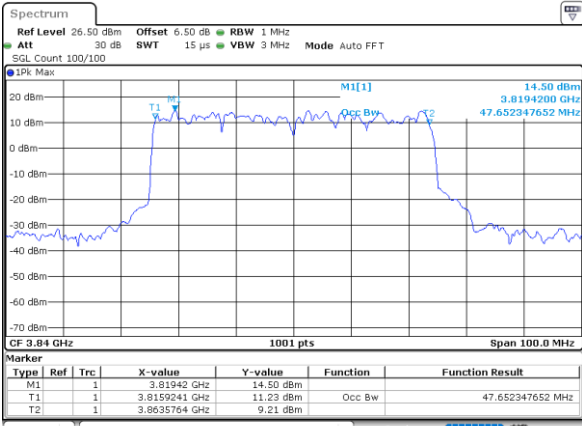

Date: 14 JUN 2022 22:49:10

16QAM

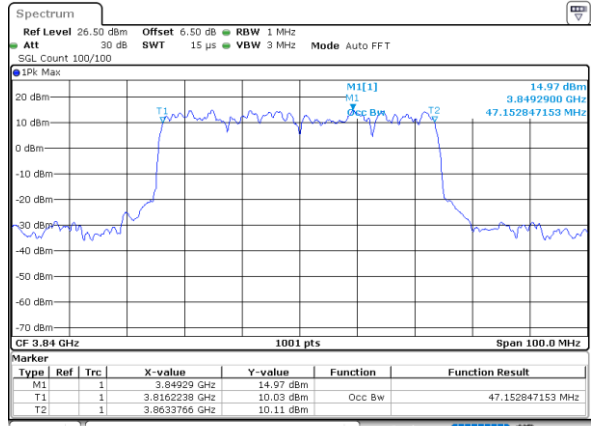

Date: 14 JUN 2022 22:54:49

64QAM

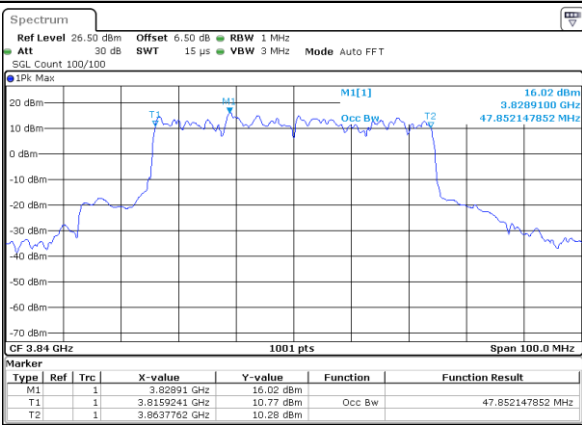

Date: 14 JUN 2022 22:56:06

256QAM

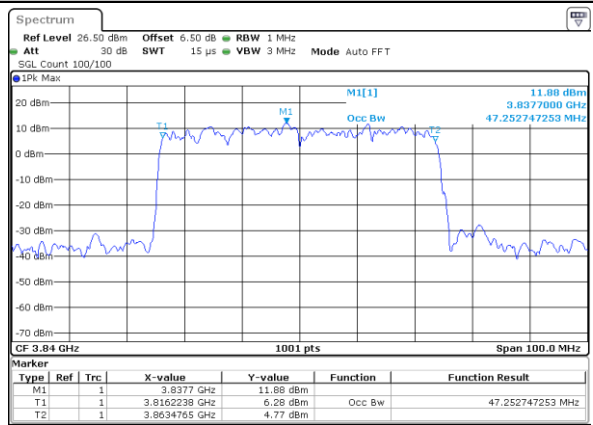

Date: 14 JUN 2022 22:56:50



60MHz

QPSK

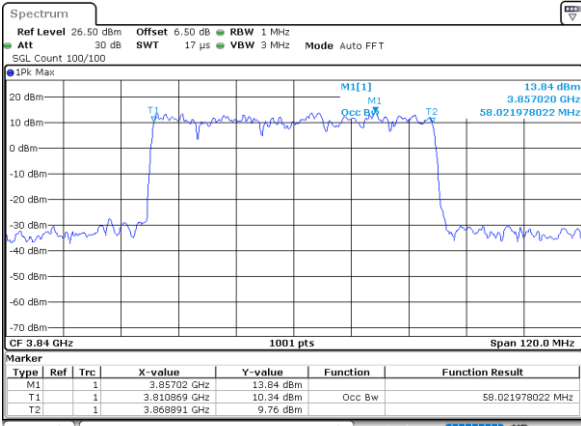

Date: 14 JUN 2022 22:06:28

16QAM

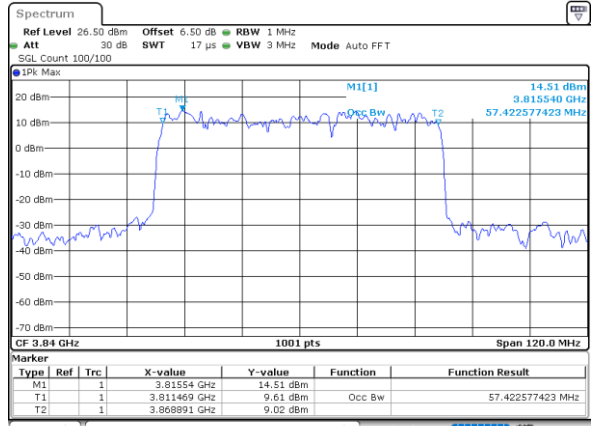

Date: 14 JUN 2022 22:08:22

64QAM

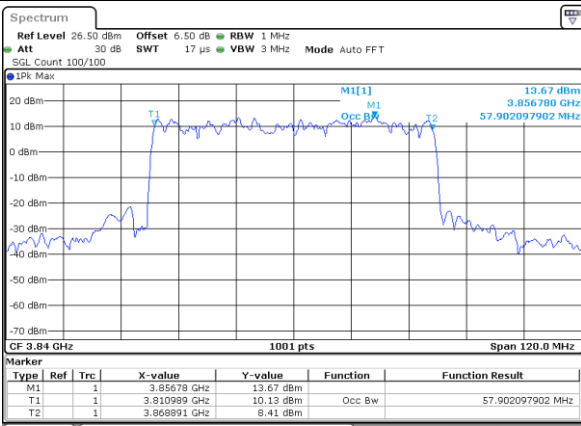

Date: 14 JUN 2022 22:08:47

256QAM

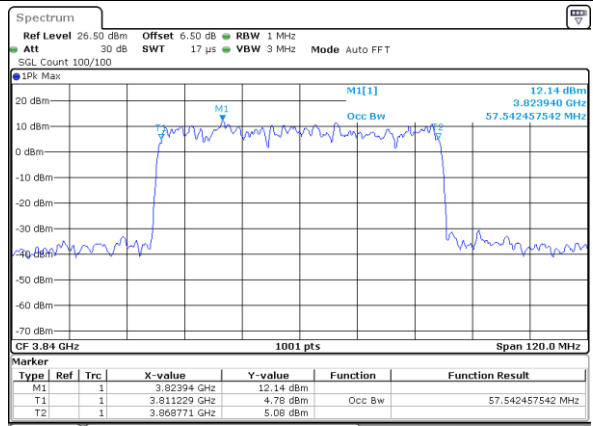

Date: 14 JUN 2022 22:09:11



70MHz

QPSK

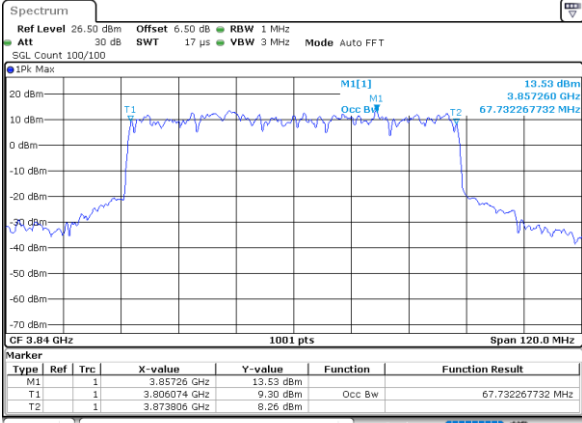

Date: 15 JUN 2022 21:50:05

16QAM

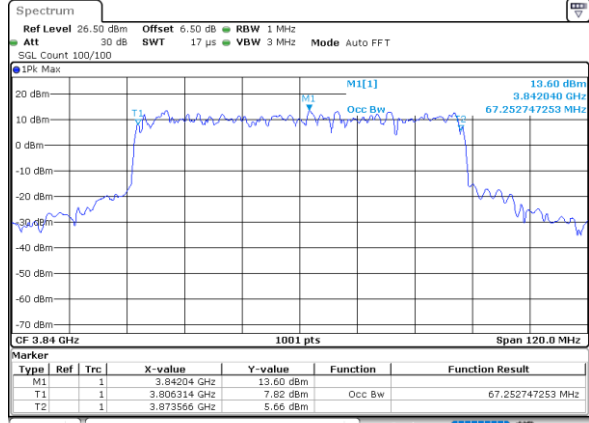

Date: 15 JUN 2022 21:50:44

64QAM

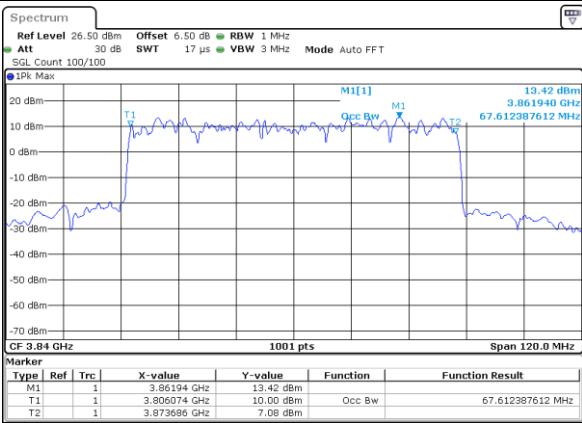

Date: 15 JUN 2022 21:51:09

256QAM

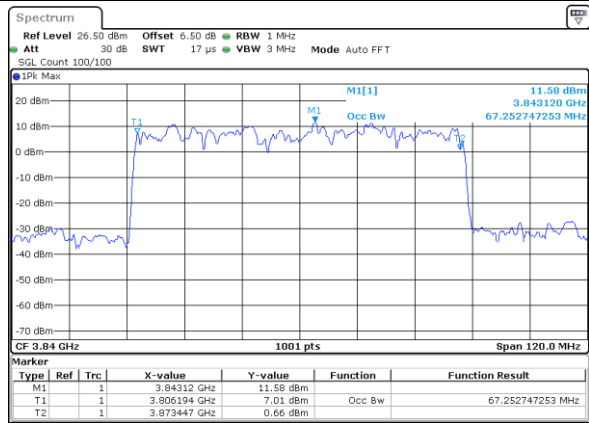

Date: 15 JUN 2022 21:51:31



80MHz

QPSK

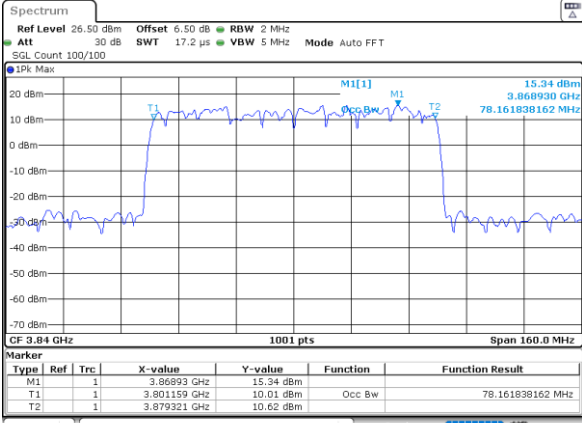

Date: 12 JUN 2022 05:02:40

16QAM

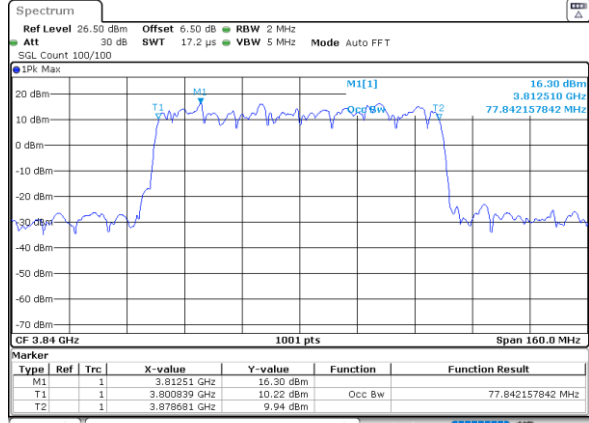

Date: 12 JUN 2022 05:02:09

64QAM

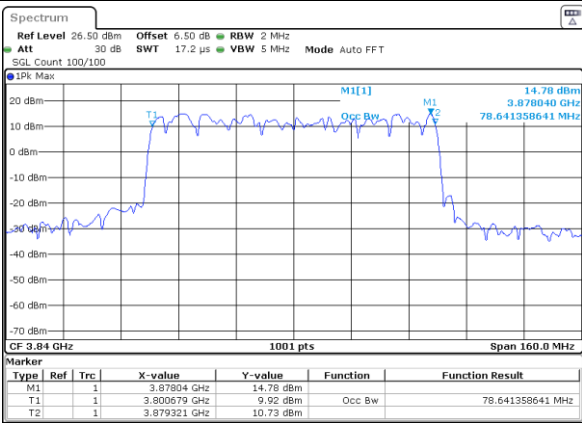

Date: 12 JUN 2022 05:01:43

256QAM

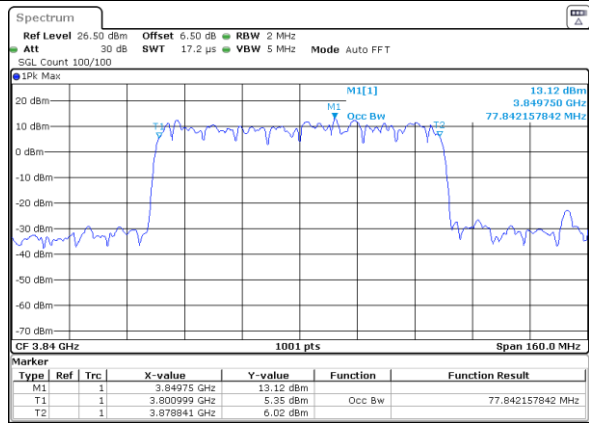

Date: 12 JUN 2022 05:00:04



90MHz

QPSK

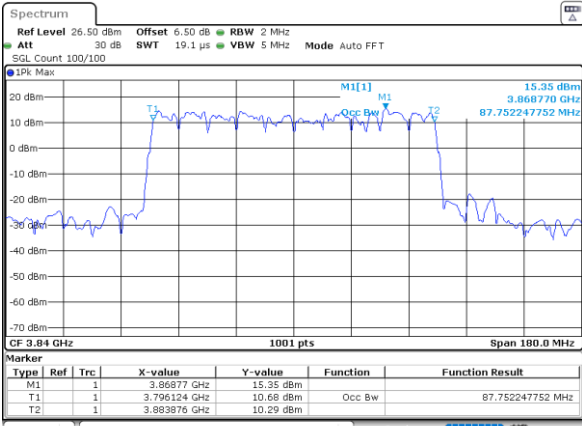

Date: 12 JUN 2022 04:55:49

16QAM

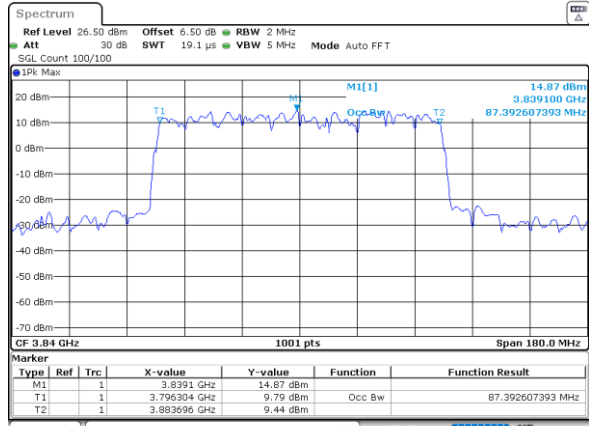

Date: 12 JUN 2022 04:56:48

64QAM

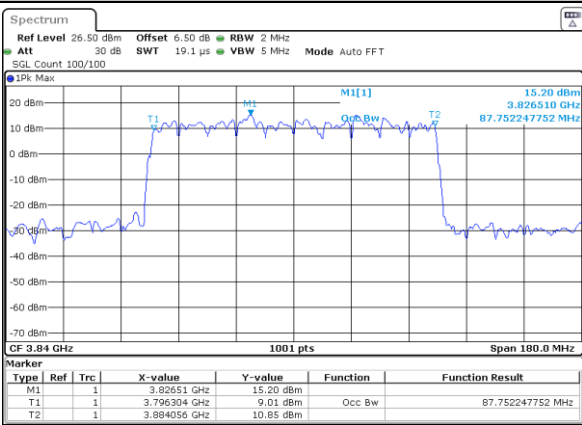

Date: 12 JUN 2022 04:58:18

256QAM

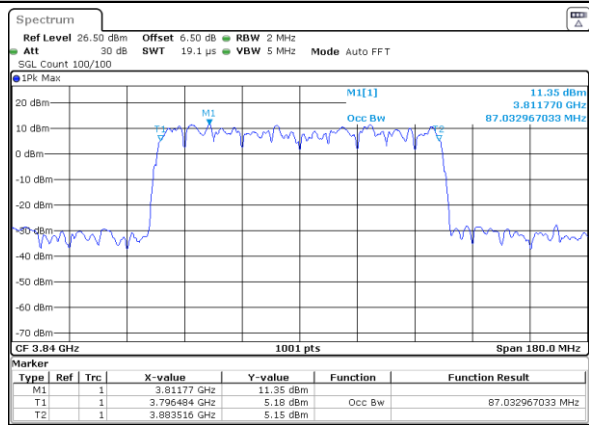

Date: 12 JUN 2022 04:59:18



100MHz

QPSK

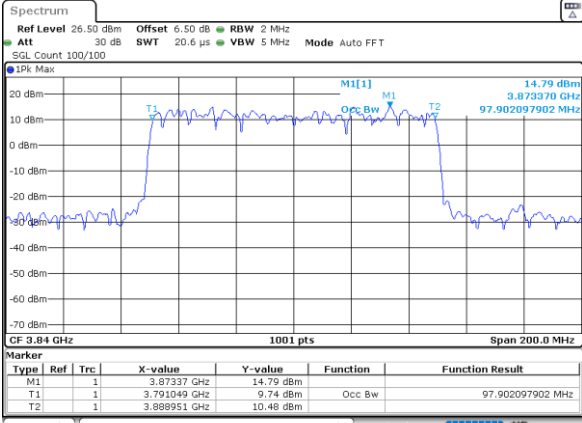

Date: 12 JUN 2022 04:10:07

16QAM

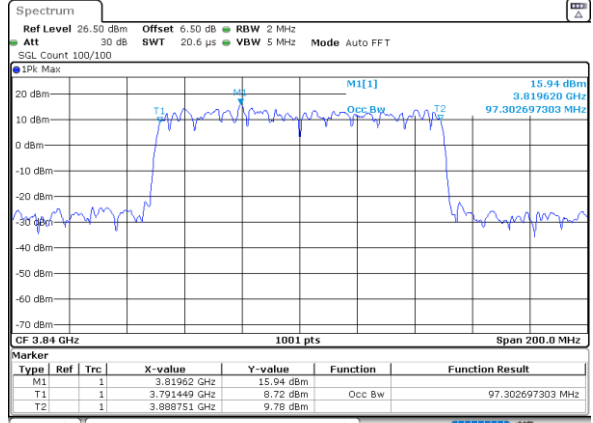

Date: 12 JUN 2022 04:10:27

64QAM

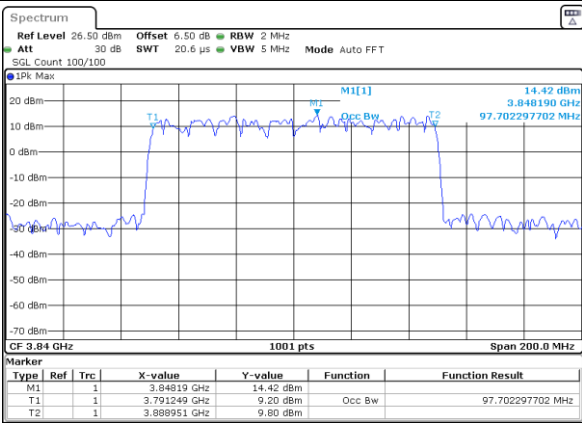

Date: 12 JUN 2022 04:13:50

256QAM

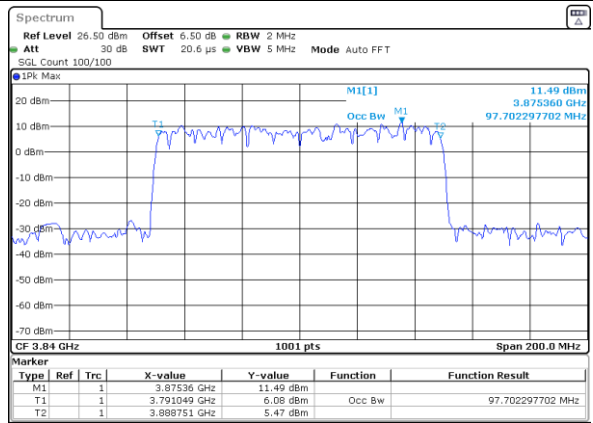

Date: 12 JUN 2022 04:14:24



Conducted Band Edge

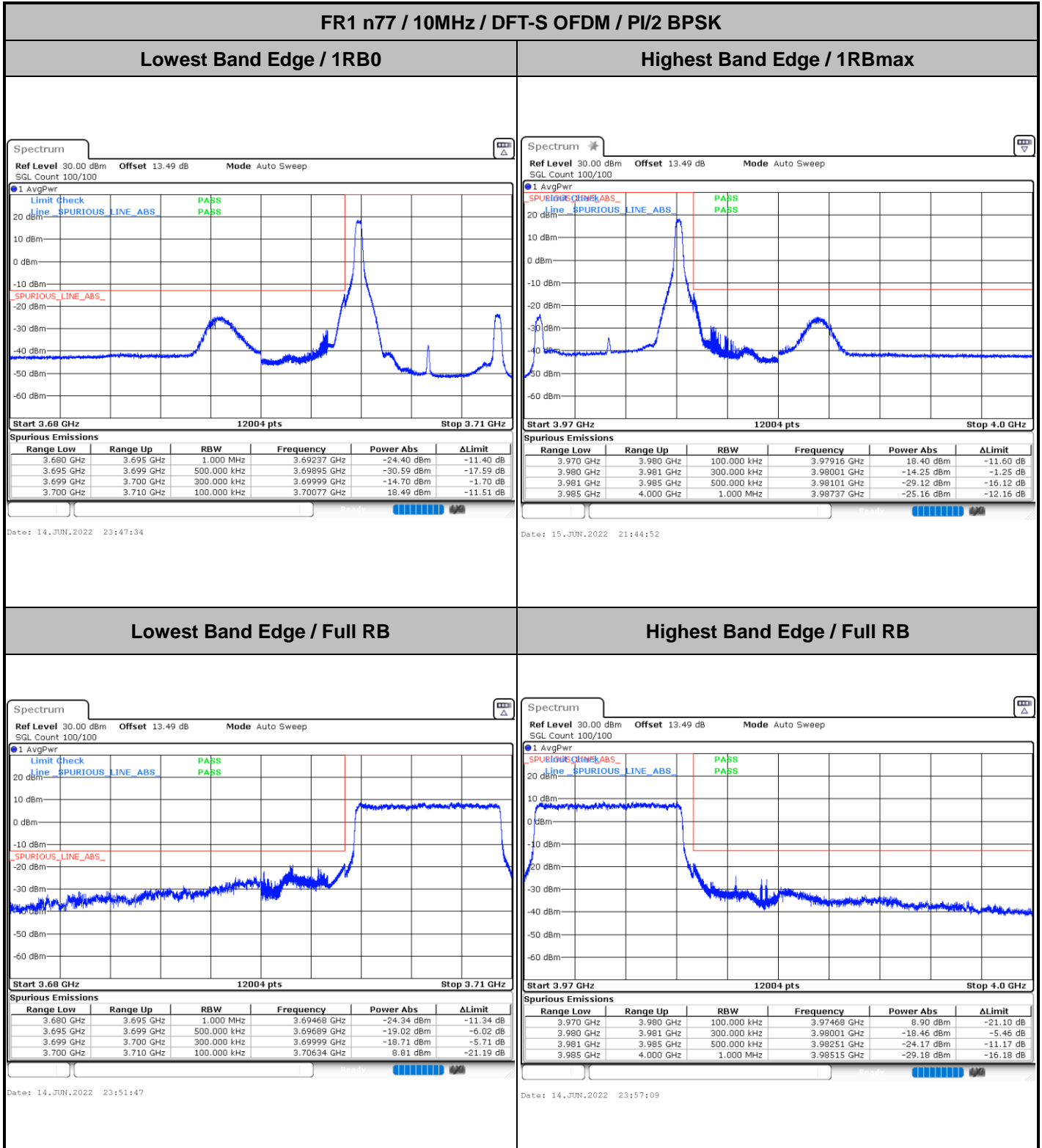



FR1 n77 / 10MHz / DFT-S OFDM / QPSK

Lowest Band Edge / 1RB0

Highest Band Edge / 1RBmax

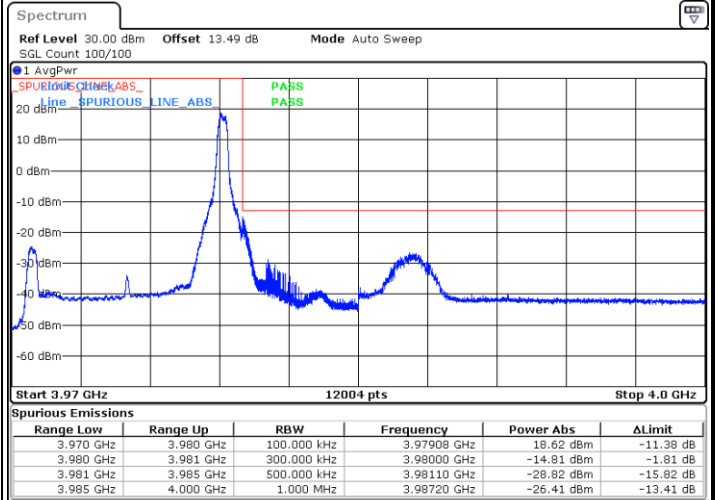
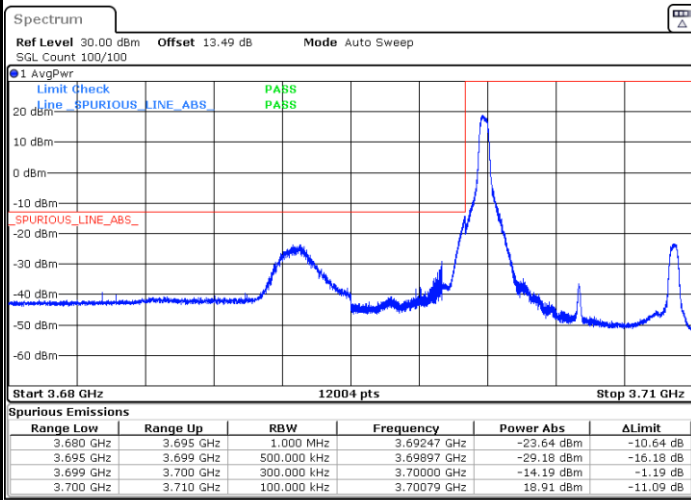

Date: 14. JUN. 2022 23:49:04

Date: 15. JUN. 2022 21:45:24

Lowest Band Edge / Full RB

Highest Band Edge / Full RB

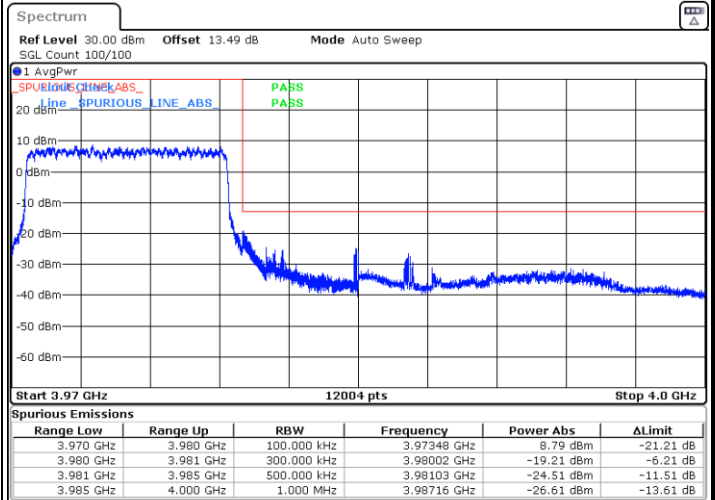
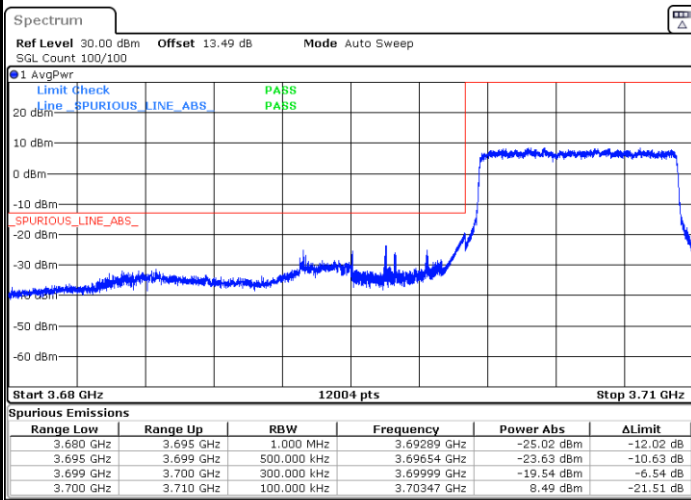

Date: 14. JUN. 2022 23:50:29

Date: 14. JUN. 2022 23:59:15