



# HEARING AID COMPATIBILITY RF EMISSIONS TEST REPORT

FCC ID : IHDT56AE4  
Equipment : Mobile Cellular Phone  
Brand Name : Motorola  
Model Name : XT2223-2  
M-Rating : M3  
Applicant : Motorola Mobility LLC  
222 W, Merchandise Mart Plaza, Chicago IL 60654 USA  
Manufacturer : Motorola Mobility LLC  
222 W, Merchandise Mart Plaza, Chicago IL 60654 USA  
Standard : FCC 47 CFR §20.19  
ANSI C63.19-2011

We, Sporton International Inc. (Kunshan), would like to declare that the tested sample has been evaluated in accordance with the test procedures and has been in compliance with the applicable technical standards.

The test results in this report apply exclusively to the tested model / sample. Without written approval of Sporton International Inc. (Kunshan), the test report shall not be reproduced except in full.



Approved by: Si Zhang

**Sporton International Inc. (Kunshan)**

No. 1098, Pengxi North Road, Kunshan Economic Development Zone Jiangsu Province 215300  
People's Republic of China



**Table of Contents**

1. General Information ..... 4

2. Testing Location..... 5

3. Applied Standards ..... 5

4. RF Audio Interference Level..... 5

5. Air Interface and Operating Mode..... 6

6. Measurement System Specification ..... 7

    6.1 E-Field Probe System..... 7

    6.2 Data Storage and Evaluation..... 8

7. RF Emissions Test Procedure..... 9

8. Test Equipment List .....12

9. Measurement System Validation .....13

10. Modulation Interference Factor.....14

11. Low-power Exemption.....15

12. Conducted RF Output Power (Unit: dBm).....19

13. HAC RF Emission Test Results.....20

14. Uncertainty Assessment .....21

15. References.....23

- Appendix A. Plots of System Performance Check
- Appendix B. Plots of RF Emission Measurement
- Appendix C. DASYS Calibration Certificate
- Appendix D. Test Setup Photos
- Appendix E. UID specifications for HAC RFE



### History of this test report

Report No.	Version	Description	Issued Date
HA230110-01A	Rev. 01	Initial issue of report	Apr. 22, 2022



**1. General Information**

Product Feature & Specification	
Applicant Name	Motorola Mobility LLC
Equipment Name	Mobile Cellular Phone
Brand Name	Motorola
Model Name	XT2223-2
IMEI Code	IMEI 1: 356081330019928 IMEI 2: 356081330019936
FCC ID	IHDT56AE4
HW	DVT2
SW	S1SS32.31
EUT Stage	Identical Prototype
Date Tested	2022/3/25 ~ 2022/3/26
Frequency Band	GSM850: 824 MHz ~ 849 MHz GSM1900: 1850 MHz ~ 1910 MHz WCDMA Band II: 1850 MHz ~ 1910 MHz WCDMA Band IV: 1710 MHz ~ 1755 MHz WCDMA Band V: 824 MHz ~ 849 MHz LTE Band 2: 1850 MHz ~ 1910 MHz LTE Band 4: 1710 MHz ~ 1755 MHz LTE Band 5: 824 MHz ~ 849 MHz LTE Band 7: 2500 MHz ~ 2570 MHz LTE Band 12: 699 MHz ~ 716 MHz LTE Band 13: 777 MHz ~ 787 MHz LTE Band 17: 704 MHz ~ 716 MHz LTE Band 26: 814 MHz ~ 849 MHz LTE Band 66: 1710 MHz ~ 1780 MHz LTE Band 38: 2570 MHz ~ 2620 MHz LTE Band 41: 2496 MHz ~ 2690 MHz LTE Band 42: 3450 MHz ~ 3550 MHz 5G NR n5: 824 MHz ~ 849 MHz 5G NR n7 : 2500 MHz ~ 2570 MHz 5G NR n66 : 1710 MHz ~ 1780 MHz 5G NR n78: 3450 MHz ~ 3550 MHz WLAN 2.4GHz Band: 2412 MHz ~ 2462 MHz WLAN 5.2GHz Band: 5180 MHz ~ 5240 MHz WLAN 5.3GHz Band: 5260 MHz ~ 5320 MHz WLAN 5.5GHz Band: 5500 MHz ~ 5700 MHz WLAN 5.8GHz Band: 5745 MHz ~ 5825 MHz Bluetooth: 2402 MHz ~ 2480 MHz NFC: 13.56 MHz
Mode	GSM/GPRS/EGPRS RMC/AMR 12.2Kbps HSDPA HSUPA DC-HSDPA HSPA+(16QAM uplink is supported) LTE: QPSK, 16QAM, 64QAM, 256QAM 5G NR : CP-OFDM / DFT-s-OFDM, PI/2 BPSK, QPSK, 16QAM, 64QAM, 256QAM WLAN 2.4GHz 802.11b/g/n HT20/HT40 WLAN 5GHz 802.11a/n HT20/HT40 WLAN 5GHz 802.11ac VHT20/VHT40/VHT80 Bluetooth BR/EDR/LE NFC: ASK



2. Testing Location

Sporton International Inc. (Kunshan) is accredited to ISO/IEC 17025:2017 by American Association for Laboratory Accreditation with Certificate Number 5145.02.

Table with 4 columns: Test Firm, Test Site Location, Test Site No., and FCC Designation No. / FCC Test Firm Registration No.

3. Applied Standards

- FCC CFR47 Part 20.19
ANSI C63.19-2011
FCC KDB 285076 D01 HAC Guidance v05r01
FCC KDB 285076 D03 HAC FAQ v01r04

4. RF Audio Interference Level

FCC wireless hearing aid compatibility rules ensure that consumers with hearing loss are able to access wireless communications services through a wide selection of handsets without experiencing disabling radio frequency (RF) interference or other technical obstacles.

To define and measure the hearing aid compatibility of handsets, in CFR47 part 20.19 ANSI C63.19 is referenced. A handset is considered hearing aid-compatible for acoustic coupling if it meets a rating of at least M3 under ANSI C63.19, and A handset is considered hearing aid compatible for inductive coupling if it meets a rating of at least T3. According to ANSI C63.19 2011 version, for acoustic coupling, the RF electric field emissions of wireless communication devices should be measured and rated according to the emission level as below.

Table with 3 columns: Emission Categories, <960Mhz, and >960Mhz. Rows include M1, M2, M3, and M4 categories.

Table 4.1 Telephone near-field categories in linear units



5. Air Interface and Operating Mode

Air Interface	Band MHz	Type	C63.19 Tested	Simultaneous Transmitter	Name of Voice Service	Power Reduction
GSM	GSM850	VO	Yes	WLAN, BT	CMRS Voice	No
	GSM1900			WLAN, BT		No
	EDGE850	VD	Yes	WLAN, BT	Google Duo	No
	EDGE1900			WLAN, BT		No
WCDMA	Band II	VO	No <sup>(1)</sup>	WLAN, BT	CMRS Voice	No
	Band IV			WLAN, BT		No
	Band V			WLAN, BT		No
	HSPA	VD	No <sup>(1)</sup>	WLAN, BT	Google Duo	No
LTE (FDD)	Band 2	VD	No <sup>(1)</sup>	5G NR, WLAN, BT	VoLTE / Google Duo	No
	Band 4			5G NR, WLAN, BT		No
	Band 5			5G NR, WLAN, BT		No
	Band 7			5G NR, WLAN, BT		No
	Band 12			5G NR, WLAN, BT		No
	Band 13			5G NR, WLAN, BT		No
	Band 17			5G NR, WLAN, BT		No
	Band 26			5G NR, WLAN, BT		No
	Band 66			5G NR, WLAN, BT		No
LTE (TDD)	Band 38	VD	Yes	5G NR, WLAN, BT	VoLTE / Google Duo	No
	Band 41			5G NR, WLAN, BT		No
	Band 42			5G NR, WLAN, BT		No
5G NR (FDD)	n5	VD	No <sup>(1)</sup>	LTE, WLAN, BT	VoNR / Google Duo	No
	n7			LTE, WLAN, BT		No
	n66			LTE, WLAN, BT		No
5G NR (TDD)	n78	VD	No <sup>(1)</sup>	LTE, WLAN, BT	VoNR / Google Duo	No
Wi-Fi	2450	VD	Yes	GSM,WCDMA,LTE,5G NR	VoWiFi / Google Duo	No
	5200	VD	Yes	GSM,WCDMA,LTE,5G NR, BT		No
	5300					No
	5500					No
	5800					No
BT	2450	DT	No	GSM,WCDMA,LTE,5G NR, WLAN 5GHz	NA	No

Type Transport:  
 VO= Voice only  
 DT= Digital Transport only (no voice)  
 VD= CMRS and IP Voice Service over Digital Transport

Remark:  
 1. The air interface is exempted from testing by low power exemption that its average antenna input power plus its MIF is ≤17 dBm, and is rated as M4.  
 2. The device have similar frequency in some LTE bands: LTE B38/41, since the supported frequency spans for the smaller LTE bands are completely cover by the larger LTE bands, therefore, only larger LTE bands were required to be tested for hearing-aid compliance.

## 6. Measurement System Specification

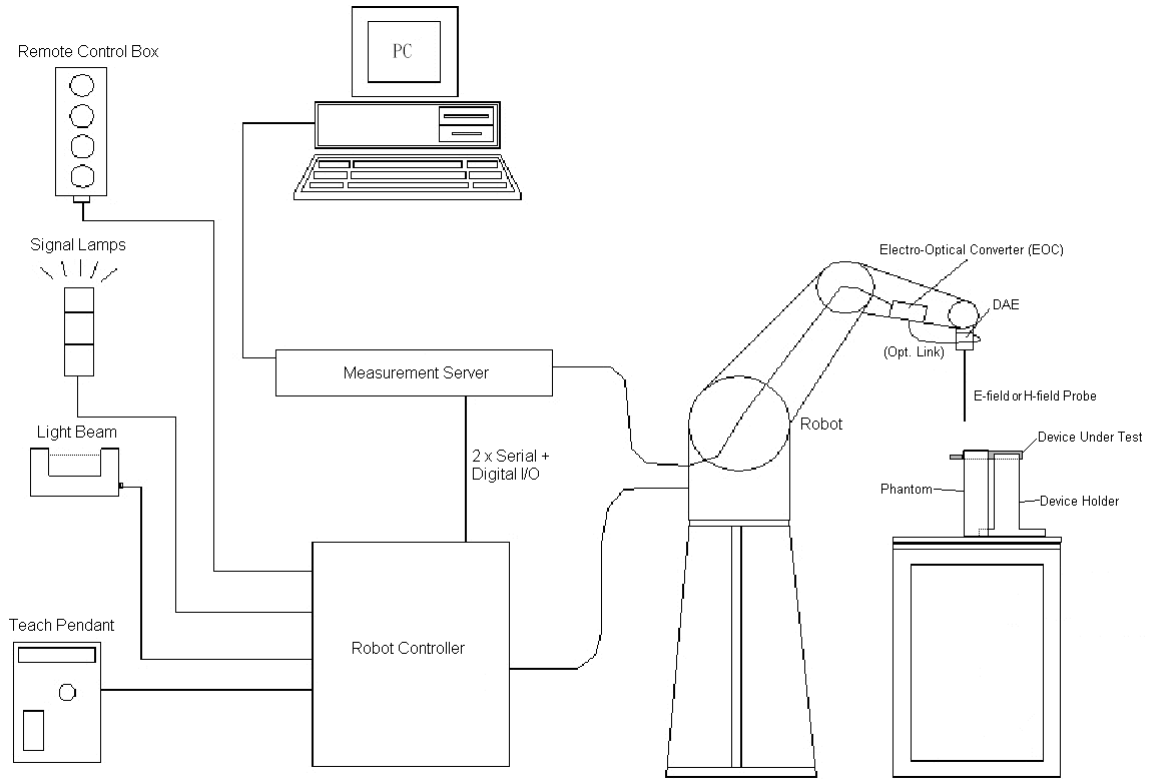

**Fig 6.1 System Configurations**

### 6.1 E-Field Probe System

#### E-Field Probe Specification

<EF3DV3>

<b>Construction</b>	One dipole parallel, two dipoles normal to probe axis Built-in shielding against static charges
<b>Calibration</b>	In air from 30 MHz to 6.0 GHz (absolute accuracy $\pm 6.0\%$ , $k=2$ )
<b>Frequency</b>	30 MHz to 6 GHz; Linearity: $\pm 2.0$ dB (100 MHz to 3 GHz)
<b>Directivity</b>	$\pm 0.2$ dB in air (rotation around probe axis) $\pm 0.4$ dB in air (rotation normal to probe axis)
<b>Dynamic Range</b>	2 V/m to 1000 V/m (M3 or better device readings fall well below diode compression point)
<b>Linearity</b>	$\pm 0.2$ dB
<b>Dimensions</b>	Overall length: 337 mm (Tip: 20 mm) Tip diameter: 4 mm (Body: 12 mm) Distance from probe tip to dipole centers: 1.5 mm



**Photo of E-field Probe**

#### Probe Tip Description:

HAC field measurements take place in the close near field with high gradients. Increasing the measuring distance from the source will generally decrease the measured field values (in case of the validation dipole approx. 10% per mm).

## **6.2 Data Storage and Evaluation**

The DASY software stores the assessed data from the data acquisition electronics as raw data (in microvolt readings from the probe sensors), together with all the necessary software parameters for the data evaluation (probe calibration data, and device frequency and modulation data) in measurement files.

<b>Probe parameters :</b>	- Sensitivity	Norm <sub>i</sub> , a <sub>i0</sub> , a <sub>i1</sub> , a <sub>i2</sub>
	- Conversion factor	ConvF <sub>i</sub>
	- Diode compression point	dcp <sub>i</sub>
<b>Device parameters :</b>	- Frequency	f
	- Crest factor	cf
<b>Media parameters :</b>	- Conductivity	σ
	- Density	ρ

The formula for each channel can be given as :

$$V_i = U_i + U_i^2 \cdot \frac{cf}{dcp_i}$$

with  $V_i$  = compensated signal of channel i, (i = x, y, z)  
 $U_i$  = input signal of channel i, (i = x, y, z)  
 cf = crest factor of exciting field (DASY parameter)  
 dcp<sub>i</sub> = diode compression point (DASY parameter)

From the compensated input signals, the primary field data for each channel can be evaluated :

$$\text{E-field Probes : } E_i = \sqrt{\frac{V_i}{\text{Norm}_i \cdot \text{ConvF}}}$$

with  $V_i$  = compensated signal of channel i, (i = x, y, z)  
 Norm<sub>i</sub> = sensor sensitivity of channel i, (i = x, y, z), μV/(V/m)<sup>2</sup> for E-field Probes  
 ConvF = sensitivity enhancement in solution  
 f = carrier frequency [GHz]  
 E<sub>i</sub> = electric field strength of channel i in V/m

The RSS value of the field components gives the total field strength (Hermitian magnitude) :

$$E_{\text{tot}} = \sqrt{E_x^2 + E_y^2 + E_z^2}$$

The primary field data are used to calculate the derived field units.





## **7. RF Emissions Test Procedure**

Referenced from ANSI C63.19 -2011 section 5.5.1

- a. Confirm the proper operation of the field probe, probe measurement system, and other instrumentation and the positioning system.
- b. Position the WD in its intended test position.
- c. Set the WD to transmit a fixed and repeatable combination of signal power and modulation characteristic that is representative of the worst case (highest interference potential) encountered in normal use. Transiently occurring start-up, changeover, or termination conditions, or other operations likely to occur less than 1% of the time during normal operation, may be excluded from consideration.
- d. The center sub-grid shall be centered on the T-Coil mode perpendicular measurement point or the acoustic output, as appropriate. Locate the field probe at the initial test position in the 50 mm by 50 mm grid, which is contained in the measurement plane, refer to illustrated in Figure 8.2. If the field alignment method is used, align the probe for maximum field reception.
- e. Record the reading at the output of the measurement system.
- f. Scan the entire 50 mm by 50 mm region in equality spaced increments and record the reading at each measurement point, The distance between measurement points shall be sufficient to assure the identification of the maximum reading.
- g. Identify the five contiguous sub-grids around the center sub-grid whose maximum reading is the lowest of all available choices. This eliminates the three sub-grids with the maximum readings. Thus, the six areas to be used to determine the WD's highest emissions are identified.
- h. Identify the maximum reading within the non-excluded sub-grids identified in step g).
  - i. Indirect measurement method
  - j. The RF audio interference level in dB (V/m) is obtained by adding the MIF (in dB) to the maximum steady-state rms field-strength reading, in dB (V/m)
- k. Compare this RF audio interference level with the categories in ANSI C63.19-2011 clause 8 and record the resulting WD category rating.
- l. For the T-Coil perpendicular measurement location is  $\geq 5.0$  mm from the center of the acoustic output, then two different 50 mm by 50 mm areas may need to be scanned, the first for the microphone mode assessment and the second for the T-Coil assessment.
- m. The second for the T-Coil assessment, with the grid shifted so that it is centered on the perpendicular measurement point. Record the WD category rating.

**Test Instructions**

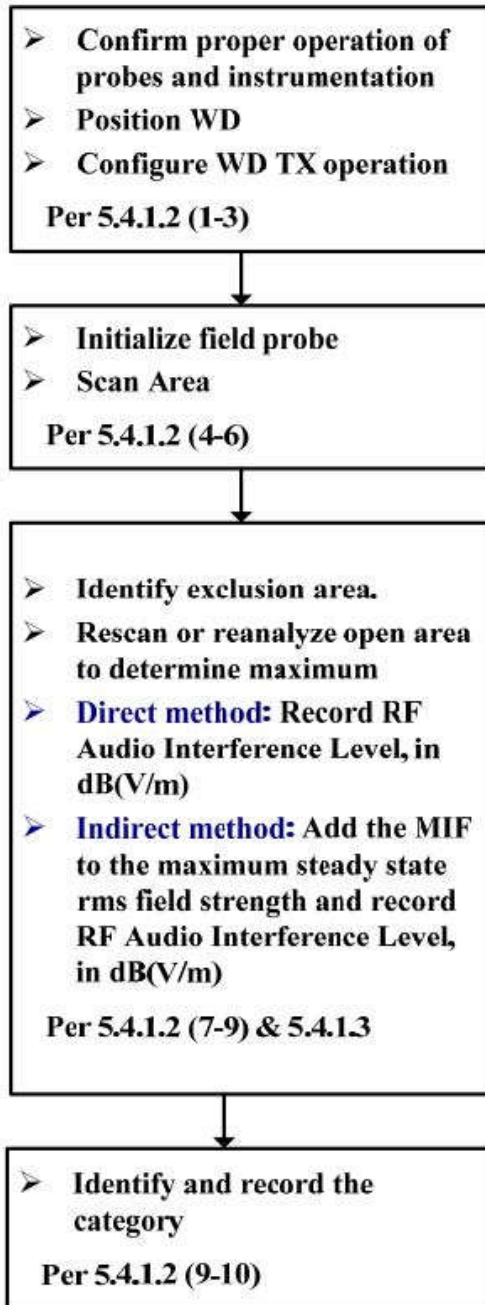

**Figure 8.1 RF Emissions Flow Chart**

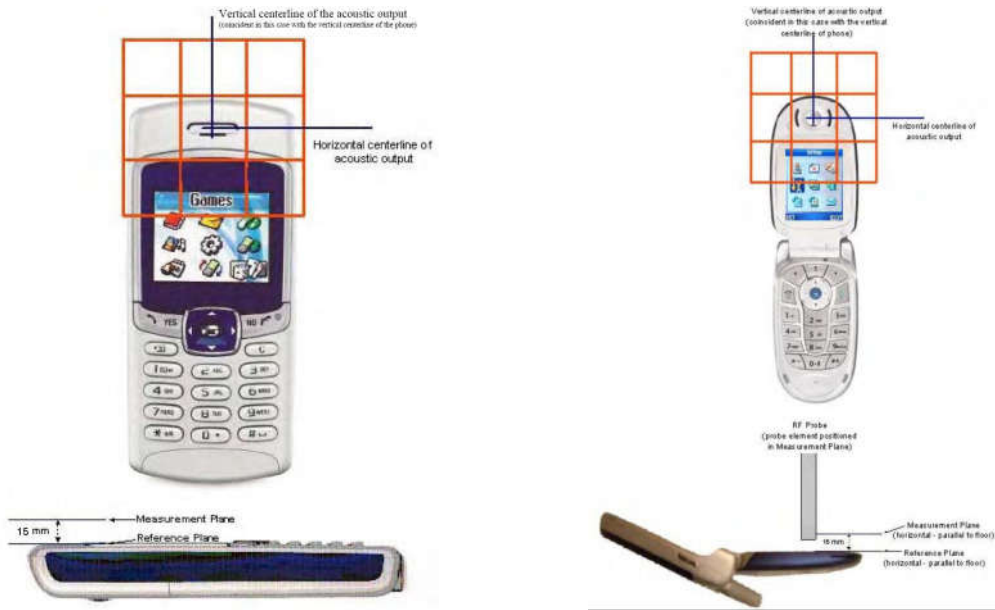

**Fig 8.2 EUT reference and plane for HAC RF emission measurements**

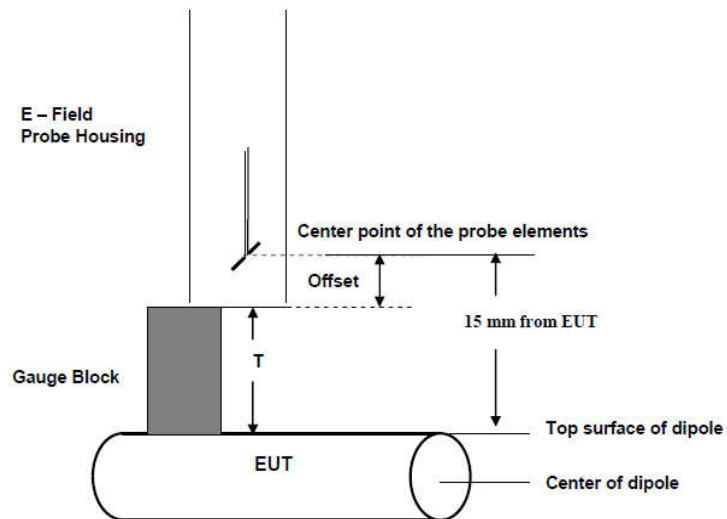

**Fig. 8.3 Gauge block with E-field probe**



8. Test Equipment List

Table with 6 columns: Manufacturer, Name of Equipment, Type/Model, Serial Number, Last Cal., Due Date. Rows include various equipment like Calibration Dipole, Base Station, Vector Signal Generator, Power Meter, etc.

Note:

- 1. NCR: "No-Calibration Required"
2. Referring to KDB 865664 D01v01r04, the dipole calibration interval can be extended to 3 years with justification.
3. The justification data of dipole can be found in appendix C. The return loss is < -20dB, within 20% of prior calibration, the impedance is within 5 ohm of prior calibration.

### 9. Measurement System Validation

Each DASY system is equipped with one or more system validation kits. These units, together with the predefined measurement procedures within the DASY software, enable the user to conduct the system performance check and system validation. System validation kit includes a dipole, tripod holder to fix it underneath the test Arch and a corresponding distance holder.

The system performance check verifies that the system operates within its specifications. System and operator errors can be detected and corrected. It is recommended that the system performance check be performed prior to any usage of the system in order to guarantee reproducible results. The system performance check uses normal HAC measurements in a simplified setup with a well characterized source. This setup was selected to give a high sensitivity to all parameters that might fail or vary over time. The system check does not intend to replace the calibration of the components, but indicates situations where the system uncertainty is exceeded due to drift or failure.

**<Test Setup>**

1. In the simplified setup for system evaluation, the EUT is replaced by a calibrated dipole and the power source is replaced by a continuous wave which comes from a signal generator.
2. The center point of the probe element(s) is 15mm from the closest surface of the dipole elements.
3. The calibrated dipole must be placed beneath the arch phantom. The equipment setup is shown below:
4. The output power on dipole port must be calibrated to 20dBm (100mW) before dipole is connected.

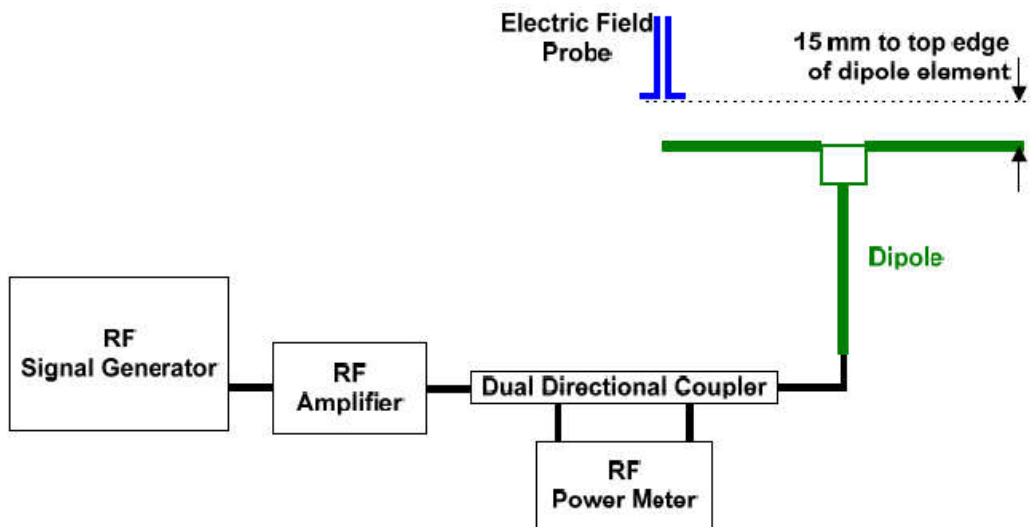

**Fig. 7.1 Setup Diagram**

**<Validation Results>**

Comparing to the original E-field value provided by SPEAG, the verification data should be within its specification of 18 %. Table 6.1 shows the target value and measured value. The table below indicates the system performance check can meet the variation criterion and the plots can be referred to appendix A of this report.

$$\text{Deviation} = ((\text{Average E-field Value}) - (\text{Target value})) / (\text{Target value}) * 100\%$$

Frequency (MHz)	Input Power (dBm)	Target Value (V/m)	E-Field 1 (V/m)	E-Field 2 (V/m)	Average Value (V/m)	Deviation (%)	Date
835	20	106.8	107.8	98.75	103.275	-3.30	Mar. 25, 2022
1880	20	85.5	101.8	96.59	99.195	16.02	Mar. 25, 2022
2450	20	85.1	93.89	91.53	92.71	8.94	Mar. 25, 2022
2600	20	86.1	91.83	89.32	90.575	5.20	Mar. 26, 2022
3500	20	83.4	88.81	87.76	88.285	5.86	Mar. 26, 2022



10. Modulation Interference Factor

The HAC Standard ANSI C63.19-2011 defines a new scaling using the Modulation Interference Factor (MIF). For any specific fixed and repeatable modulated signal, a modulation interference factor (MIF, expressed in dB) may be developed that relates its interference potential to its steady-state rms signal level or average power level. This factor is a function only of the audio-frequency amplitude modulation characteristics of the signal and is the same for field-strength and conducted power measurements. It is important to emphasize that the MIF is valid only for a specific repeatable audio-frequency amplitude modulation characteristic. Any change in modulation characteristic requires determination and application of a new MIF

The Modulation Interference factor (MIF, in dB) is added to the measured average E-field (in dBV/m) and converts it to the RF Audio Interference level (in dBV/m). This level considers the audible amplitude modulation components in the RF E-field. CW fields without amplitude modulation are assumed to not interfere with the hearing aid electronics. Modulations without time slots and low fluctuations at low frequencies have low MIF values, TDMA modulations with narrow transmission and repetition rates of few 100 Hz have high MIF values and give similar classifications as ANSI C63.19-2011.

ER3D, EF3D and EU2D E-field probes have a bandwidth <10 kHz and can therefore not evaluate the RF envelope in the full audio band. DASY52 is therefore using the indirect measurement method according to ANSI C63.19-2011 which is the primary method. These near field probes read the averaged E-field measurement. Especially for the new high peak-to-average (PAR) signal types, the probes shall be linearized by PMR calibration in order to not overestimate the field reading. Probe Modulation Response (PMR) calibration linearizes the probe response over its dynamic range for specific modulations which are characterized by their UID and result in an uncertainty specified in the probe calibration certificate. The MIF is characteristic for a given waveform envelope and can be used as a constant conversion factor if the probe has been PMR calibrated.

The evaluation method for the MIF is defined in ANSI C63.19-2011 section D.7. An RMS demodulated RF signal is fed to a spectral filter (similar to an A weighting filter) and forwarded to a temporal filter acting as a quasi-peak detector. The averaged output of these filtering is scaled to a 1 kHz 80% AM signal as reference. MIF measurement requires additional instrumentation and is not well suited for evaluation by the end user with reasonable uncertainty. It may alternatively be determined through analysis and simulation, because it is constant and characteristic for a communication signal. DASY52 uses well-defined signals for PMR calibration. The MIF of these signals has been determined by simulation and it is automatically applied.

The MIF measurement uncertainty is estimated as follows, declared by HAC equipment provider SPEAG, for modulation frequencies from slotted waveforms with fundamental frequency and at least 2 harmonics within 10 kHz:

- 1. 0.2 dB for MIF: -7 to +5 dB
2. 0.5 dB for MIF: -13 to +11 dB
3. 1 dB for MIF: > -20 dB

MIF values applied in this test report were provided by the HAC equipment provider of SPEAG, and the worst values for all air interface are listed below to be determine the Low-power Exemption.

Table with 3 columns: UID, Communication System Name, MIF(dB). Rows include GSM-FDD, EDGE-FDD, UMTS-FDD, LTE-FDD, 5G NR, and various IEEE WiFi standards.



### 11. Low-power Exemption

<Max Tune-up Limit>

<Antenna 0>

Frequency Band		Average Power (dBm)
LTE FDD	Band 7	24.00
LTE TDD	Band 38	24.00
	Band 41	24.00
5G NR FDD	n7	24.00

<Antenna 1>

Frequency Band		Average Power (dBm)
GSM	GSM850	33.50
	EDGE850	27.00
	GSM1900	30.00
	EDGE1900	25.00
WCDMA	Band V	24.00
	Band IV	24.00
	Band II	24.00
	HSPA	23.00
LTE FDD	Band 2	24.00
	Band 4	24.00
	Band 5	24.00
	Band 12	24.00
	Band 13	24.00
	Band 17	24.00
	Band 26	24.00
	Band 66	24.00
5G NR FDD	n5	24.00
	n66	24.00



**<Antenna 4>**

Frequency Band		Average Power (dBm)
LTE FDD	Band 2	18.00
	Band 4	22.50
	Band 5	23.00
	Band 7	16.50
	Band 66	22.50

**<Antenna 5>**

Frequency Band		Average Power (dBm)
LTE TDD	Band 42	23.00
5G NR TDD	n78 PC3	24.00

**<Antenna 6>**

Frequency Band		Average Power (dBm)
2.4GHz WLAN	802.11b	20.50
	802.11g	20.50
	802.11n-HT20	20.00
	802.11n-HT40	16.50
5GHz WLAN	802.11a	19.50
	802.11n-HT20	19.50
	802.11n-HT40	18.00
	802.11ac-VHT20	18.50
	802.11ac-VHT40	17.50
	802.11ac-VHT80	17.00





## &lt;Low Power Exemption&gt;

## &lt;Antenna 0&gt;

Air Interface	Max Average Antenna Input Power (dBm)	Worst Case MIF (dB)	Power + MIF(dB)	C63.19 test required
LTE - FDD	24.00	-9.76	14.24	No
LTE - TDD	24.00	-1.44	22.56	Yes
5G FR1 - FDD	24.00	-12.08	11.92	No

## &lt;Antenna 1&gt;

Air Interface	Max Average Antenna Input Power (dBm)	Worst Case MIF (dB)	Power + MIF(dB)	C63.19 test required
GSM850	33.50	3.63	37.13	Yes
EDGE850	27.00	3.75	30.75	No <sup>(1)</sup>
GSM1900	30.00	3.63	33.63	Yes
EDGE1900	25.00	3.75	28.75	No <sup>(1)</sup>
WCDMA	24.00	-25.43	-1.43	No
WCDMA - HSPA	24.00	-20.39	3.61	No
LTE - FDD	24.00	-9.76	14.24	No
5G FR1 - FDD	24.00	-12.08	11.92	No

## &lt;Antenna 4&gt;

Air Interface	Max Average Antenna Input Power (dBm)	Worst Case MIF (dB)	Power + MIF(dB)	C63.19 test required
LTE - FDD	23.00	-9.76	13.24	No

## &lt;Antenna 5&gt;

Air Interface	Max Average Antenna Input Power (dBm)	Worst Case MIF (dB)	Power + MIF(dB)	C63.19 test required
LTE - TDD	23.00	-1.44	21.56	Yes
5G NR - TDD	24.00	-12.08	11.92	No



<Antenna 6>

Air Interface	Max Average Antenna Input Power (dBm)	Worst Case MIF (dB)	Power + MIF(dB)	C63.19 test required
802.11b	20.50	-2.02	18.48	No <sup>(2)</sup>
802.11g	20.50	0.12	20.62	Yes
802.11n-HT20	20.00	-13.44	6.56	No
802.11n-HT40	16.50	-13.44	3.06	No
802.11a	19.50	-3.15	16.35	No
802.11n-HT20	19.50	-13.44	6.06	No
802.11n-HT40	18.00	-13.44	4.56	No
802.11ac-VHT20	18.50	-5.57	12.93	No
802.11ac-VHT40	17.50	-5.57	11.93	No
802.11ac-VHT80	17.00	-5.57	11.43	No

**General Note:**

1. EDGE data modes is not necessary due the GSM Voice mode is the worst case.
2. 802.11b is not necessary due to the 802.11g is the worst case.
3. According to ANSI C63.19 2011-version, for the air interface technology of a device is exempt from testing when its average antenna input power plus its MIF is  $\leq 17$  dBm for any of its operating modes.
4. HAC RF rating is M4 for the air interface which meets the low power exemption.



**12. Conducted RF Output Power (Unit: dBm)**

<GSM>

Average Antenna Input Power(dBm)						
Band	GSM850 ANT1			GSM1900 ANT1		
Channel	128	189	251	512	661	810
Frequency (MHz)	824.2	836.4	848.8	1850.2	1880.0	1909.8
GSM (GMSK, 1 Tx slot)	32.73	32.98	32.94	29.34	29.27	29.18

<LTE>

Band 38_Ant 0						
BW [MHz]	Modulation	RB Size	RB Offset	Power Low Ch. / Freq.	Power Middle Ch. / Freq.	Power High Ch. / Freq.
Channel				37850	38000	38150
Frequency (MHz)				2580	2595	2610
20	QPSK	1	0	22.41	22.59	22.33

Band 41_Ant 0								
BW [MHz]	Modulation	RB Size	RB Offset	Power Low Ch. / Freq.	Power Low Middle Ch. / Freq.	Power Middle Ch. / Freq.	Power High Middle Ch. / Freq.	Power High Ch. / Freq.
Channel				39750	40185	40620	41055	41490
Frequency (MHz)				2506	2549.5	2593	2636.5	2680
20	QPSK	1	0	22.52	22.48	22.67	22.43	22.41

Band 42_Ant 5						
BW [MHz]	Modulation	RB Size	RB Offset	Power Low Ch. / Freq.	Power Middle Ch. / Freq.	Power High Ch. / Freq.
Channel				42190	42590	42990
Frequency (MHz)				3460	3500	3540
20	QPSK	1	0	22.47	22.56	22.50

<WLAN>

2.4GHz WLAN	Mode	Channel	Frequency (MHz)	Average power (dBm)
	802.11g 6Mbps	1	2412	15.73
		6	2437	18.82
		11	2462	15.15



### 13. HAC RF Emission Test Results

Plot No.	Air Interface	Mode	Channel	Transmit Ant.	Average Antenna Input Power (dBm)	MIF	E-Field (dBV/m)	Margin to FCC M3 limit (dB)	E-Field M Rating
1	GSM850	Voice	128	Ant1	32.73	3.63	33.63	11.37	M4
2	GSM850	Voice	189	Ant1	32.98	3.63	34.11	10.89	M4
3	GSM850	Voice	251	Ant1	32.94	3.63	33.68	11.32	M4
4	GSM1900	Voice	512	Ant1	29.34	3.63	24.50	10.50	M4
5	GSM1900	Voice	661	Ant1	29.27	3.63	24.10	10.90	M4
6	GSM1900	Voice	810	Ant1	29.18	3.63	23.89	11.11	M4
7	LTE B41	20_QPSK_1_0	39750	Ant0	22.52	-1.44	26.76	8.24	M4
8	LTE B41	20_QPSK_1_0	40185	Ant0	22.48	-1.44	26.61	8.39	M4
9	LTE B41	20_QPSK_1_0	40620	Ant0	22.67	-1.44	26.34	8.66	M4
10	LTE B41	20_QPSK_1_0	41055	Ant0	22.43	-1.44	26.22	8.78	M4
11	LTE B41	20_QPSK_1_0	41490	Ant0	22.41	-1.44	26.02	8.98	M4
12	LTE B42	20_QPSK_1_0	42190	Ant5	22.47	-1.44	30.40	4.60	M3
13	LTE B42	20_QPSK_1_0	42590	Ant5	22.56	-1.44	30.85	4.15	M3
14	LTE B42	20_QPSK_1_0	42990	Ant5	22.50	-1.44	31.34	3.66	M3
15	WLAN2.4GHz	802.11g 6Mbps	1	Ant6	15.73	0.12	29.67	5.33	M4
16	WLAN2.4GHz	802.11g 6Mbps	6	Ant6	18.82	0.12	30.13	4.87	M3
17	WLAN2.4GHz	802.11g 6Mbps	11	Ant6	15.15	0.12	28.85	6.15	M4

**Remark:**

- 1. The HAC measurement system applies MIF value onto the measured RMS E-field, which is indirect method in ANSI C63.19 2011 version, and reports the RF audio interference level.
- 2. Phone Condition: Mute on; Backlight off; Max Volume

**Test Engineer :** Martin Li, Varus Wang, Light Wang



## **14. Uncertainty Assessment**

The component of uncertainty may generally be categorized according to the methods used to evaluate them. The evaluation of uncertainty by the statistical analysis of a series of observations is termed a Type A evaluation of uncertainty. The evaluation of uncertainty by means other than the statistical analysis of a series of observation is termed a Type B evaluation of uncertainty. Each component of uncertainty, however evaluated, is represented by an estimated standard deviation, termed standard uncertainty, which is determined by the positive square root of the estimated variance.

The combined standard uncertainty of the measurement result represents the estimated standard deviation of the result. It is obtained by combining the individual standard uncertainties of both Type A and Type B evaluation using the usual “root-sum-squares” (RSS) methods of combining standard deviations by taking the positive square root of the estimated variances. Expanded uncertainty is a measure of uncertainty that defines an interval about the measurement result within which the measured value is confidently believed to lie. It is obtained by multiplying the combined standard uncertainty by a coverage factor. For purpose of this document, a coverage factor two is used, which corresponds to confidence interval of about 95 %. The DASY uncertainty Budget is showed in Table 14.1.

The judgment of conformity in the report is based on the measurement results excluding the measurement uncertainty.



Error Description	Uncertainty Value (±%)	Probability	Divisor	(Ci) E	(Ci) H	Standard Uncertainty (E) (±%)
<b>Measurement System</b>						
Probe Calibration	5.1	N	1	1	1	5.1
Axial Isotropy	4.7	R	1.732	1	1	2.7
Sensor Displacement	16.5	R	1.732	1	0.145	9.5
Boundary Effects	2.4	R	1.732	1	1	1.4
Phantom Boundary Effect	7.2	R	1.732	1	0	4.2
Linearity	4.7	R	1.732	1	1	2.7
Scaling with PMR calibration	10.0	R	1.732	1	1	5.8
System Detection Limit	1.0	R	1.732	1	1	0.6
Readout Electronics	0.3	N	1	1	1	0.3
Response Time	2.6	R	1.732	1	1	1.5
Integration Time	2.6	R	1.732	1	1	1.5
RF Ambient Conditions	3.0	R	1.732	1	1	1.7
RF Reflections	12.0	R	1.732	1	1	6.9
Probe Positioner	1.2	R	1.732	1	0.67	0.7
Probe Positioning	4.7	R	1.732	1	0.67	2.7
Extrap. and Interpolation	1.0	R	1.732	1	1	0.6
<b>Test Sample Related</b>						
Device Positioning Vertical	4.7	R	1.732	1	0.67	2.7
Device Positioning Lateral	1.0	R	1.732	1	1	0.6
Device Holder and Phantom	2.4	R	1.732	1	1	1.4
Power Drift	5.0	R	1.732	1	1	2.9
<b>Phantom and Setup Related</b>						
Phantom Thickness	2.4	R	1.732	1	0.67	1.4
<b>Combined Std. Uncertainty</b>						16.4%
<b>Coverage Factor for 95 %</b>						K=2
<b>Expanded STD Uncertainty</b>						32.7%

**Table 14.1 Uncertainty Budget of HAC free field assessment**



## **15. References**

- [1] ANSI C63.19-2011, "American National Standard for Methods of Measurement of Compatibility between Wireless Communications Devices and Hearing Aids", 27 May 2011.
- [2] FCC KDB 285076 D01v05r01, "Equipment Authorization Guidance for Hearing Aid Compatibility", Apr 06, 2020
- [3] FCC KDB 285076 D03v01r04, "Hearing aid compatibility frequently asked questions", Apr 20, 2021.
- [4] SPEAG DASY System Handbook

-----THE END-----



---

**Appendix A. Plots of System Performance Check**

The plots are shown as follows.



**HAC\_E\_Dipole\_835**

**DUT: HAC-Dipole 835 MHz**

Communication System: UID 0, CW; Frequency: 835 MHz; Duty Cycle: 1:1

Medium: Air Medium parameters used:  $\sigma = 0$  S/m,  $\epsilon_r = 1$ ;  $\rho = 0$  kg/m<sup>3</sup>

Ambient Temperature : 23.2 °C;

DASY5 Configuration:

- Probe: EF3DV3 - SN4050; ConvF(1, 1, 1); Calibrated: 2022.1.31
- Electronics: DAE4 Sn1303; Calibrated: 2021.6.18
- Phantom: HAC Test Arch with AMCC; Type: SD HAC P01 BA;
- Measurement SW: DASY52, Version 52.10 (4); SEMCAD X Version 14.6.14 (7483)

**E Scan - measurement distance from the probe sensor center to CD835 = 15mm/Hearing Aid Compatibility Test at 15mm distance (41x361x1): Interpolated grid:**

dx=0.5000 mm, dy=0.5000 mm

Device Reference Point: 0, 0, -6.3 mm

Reference Value = 114.2 V/m; Power Drift = 0.07 dB

PMR not calibrated. PMF = 1.000 is applied.

E-field emissions = 107.8 V/m

Average value of Total=(107.8+98.75)/2=103.275 V/m

PMF scaled E-field

<b>Grid 1 M4</b> <b>104.4 V/m</b>	<b>Grid 2 M4</b> <b>107.8 V/m</b>	<b>Grid 3 M4</b> <b>102.5 V/m</b>
<b>Grid 4 M4</b> <b>62.20 V/m</b>	<b>Grid 5 M4</b> <b>63.24 V/m</b>	<b>Grid 6 M4</b> <b>59.80 V/m</b>
<b>Grid 7 M4</b> <b>97.59 V/m</b>	<b>Grid 8 M4</b> <b>98.75 V/m</b>	<b>Grid 9 M4</b> <b>95.38 V/m</b>

Total = 107.8 V/m

E Category: M4

Location: 0, -71.3, 9.7 mm

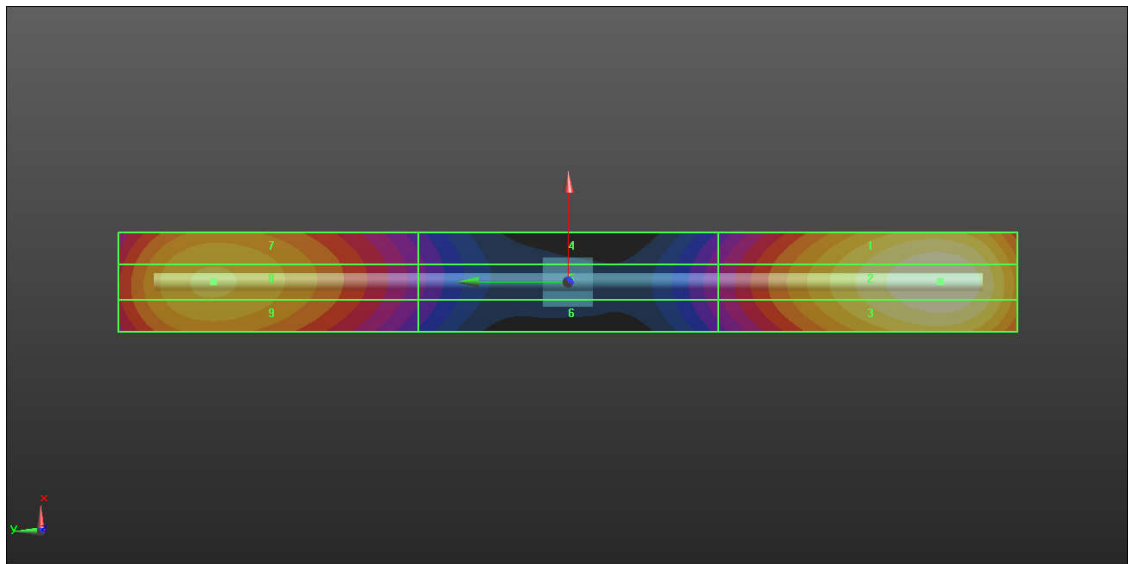
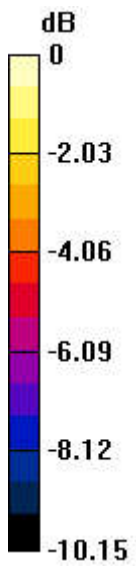

0 dB = 107.8 V/m = 40.13 dBV/m

**HAC\_E\_Dipole\_1880**

**DUT: HAC Dipole 1880 MHz**

Communication System: UID 0, CW; Frequency: 1880 MHz; Duty Cycle: 1:1

Medium: Air Medium parameters used:  $\sigma = 0$  S/m,  $\epsilon_r = 1$ ;  $\rho = 0$  kg/m<sup>3</sup>

Ambient Temperature : 23.3 °C;

DASY5 Configuration:

- Probe: EF3DV3 - SN4050; ConvF(1, 1, 1); Calibrated: 2022.1.31
- Electronics: DAE4 Sn1303; Calibrated: 2021.6.18
- Phantom: HAC Test Arch with AMCC; Type: SD HAC P01 BA;
- Measurement SW: DASY52, Version 52.10 (4); SEMCAD X Version 14.6.14 (7483)

**E Scan - measurement distance from the probe sensor center to CD1880 = 15mm/Hearing Aid Compatibility Test at 15mm distance (41x181x1): Interpolated grid:**

dx=0.5000 mm, dy=0.5000 mm

Device Reference Point: 0, 0, -6.3 mm

Reference Value = 135.4 V/m; Power Drift = -0.02 dB

PMR not calibrated. PMF = 1.000 is applied.

E-field emissions = 101.8 V/m

Average value of Total=(101.8+96.59)/2=99.195 V/m

PMF scaled E-field

<b>Grid 1 M3</b> <b>99.44 V/m</b>	<b>Grid 2 M3</b> <b>101.8 V/m</b>	<b>Grid 3 M3</b> <b>98.18 V/m</b>
<b>Grid 4 M3</b> <b>65.49 V/m</b>	<b>Grid 5 M3</b> <b>64.28 V/m</b>	<b>Grid 6 M3</b> <b>65.64 V/m</b>
<b>Grid 7 M3</b> <b>92.52 V/m</b>	<b>Grid 8 M3</b> <b>96.59 V/m</b>	<b>Grid 9 M3</b> <b>94.71 V/m</b>

Total = 101.8 V/m

E Category: M3

Location: 0, -34, 8.7 mm

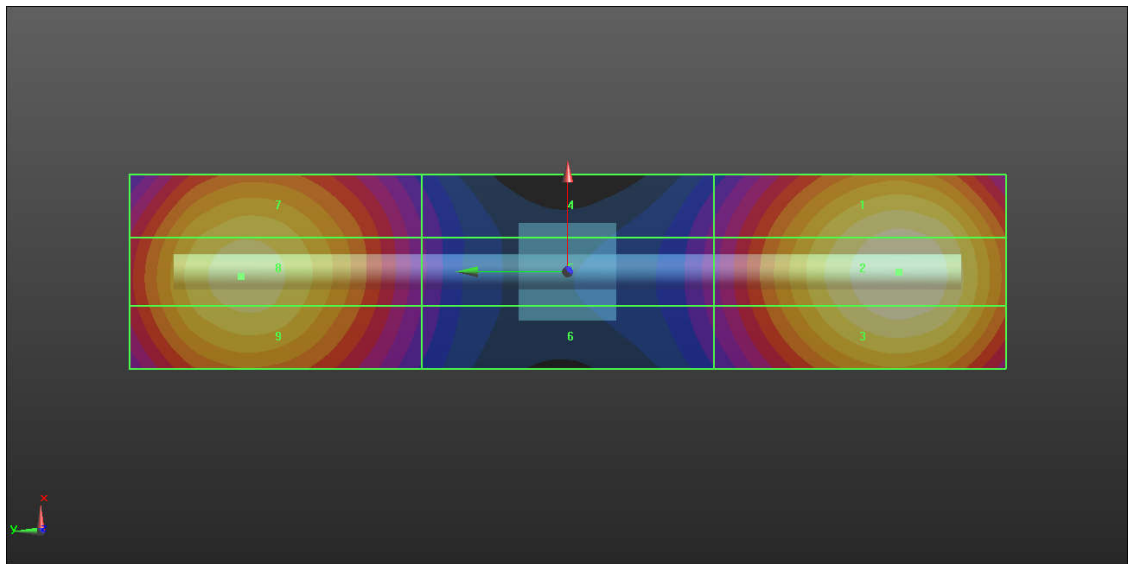
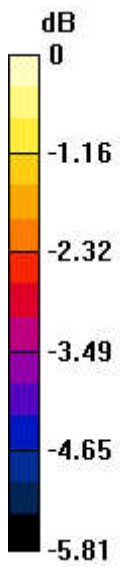

0 dB = 101.8 V/m = 39.73 dBV/m

**HAC\_E\_Dipole\_2450**

**DUT: HAC Dipole 2450 MHz**

Communication System: UID 0, CW; Frequency: 2450 MHz; Duty Cycle: 1:1

Medium: Air Medium parameters used:  $\sigma = 0$  S/m,  $\epsilon_r = 1$ ;  $\rho = 0$  kg/m<sup>3</sup>

Ambient Temperature : 23.2 °C;

DASY5 Configuration:

- Probe: EF3DV3 - SN4050; ConvF(1, 1, 1); Calibrated: 2022.1.31
- Electronics: DAE4 Sn1303; Calibrated: 2021.6.18
- Phantom: HAC Test Arch with AMCC; Type: SD HAC P01 BA;
- Measurement SW: DASY52, Version 52.10 (4); SEMCAD X Version 14.6.14 (7483)

**E Scan - measurement distance from the probe sensor center to CD2450 = 15mm/Hearing Aid Compatibility Test at 15mm distance (41x181x1):**

Interpolated grid: dx=0.5000 mm, dy=0.5000 mm

Device Reference Point: 0, 0, -6.3 mm

Reference Value = 66.91 V/m; Power Drift = -0.01 dB

PMR not calibrated. PMF = 1.000 is applied.

E-field emissions = 93.89 V/m

Average value of Total=(93.89+91.53)/2=92.71 V/m

PMF scaled E-field

<b>Grid 1 M3</b> <b>88.62 V/m</b>	<b>Grid 2 M3</b> <b>93.89 V/m</b>	<b>Grid 3 M3</b> <b>88.34 V/m</b>
<b>Grid 4 M3</b> <b>77.91 V/m</b>	<b>Grid 5 M3</b> <b>78.17 V/m</b>	<b>Grid 6 M3</b> <b>76.73 V/m</b>
<b>Grid 7 M3</b> <b>88.49 V/m</b>	<b>Grid 8 M3</b> <b>91.53 V/m</b>	<b>Grid 9 M3</b> <b>88.39 V/m</b>

Total = 93.89 V/m

E Category: M3

Location: 0.5, 21.7, 9.7 mm

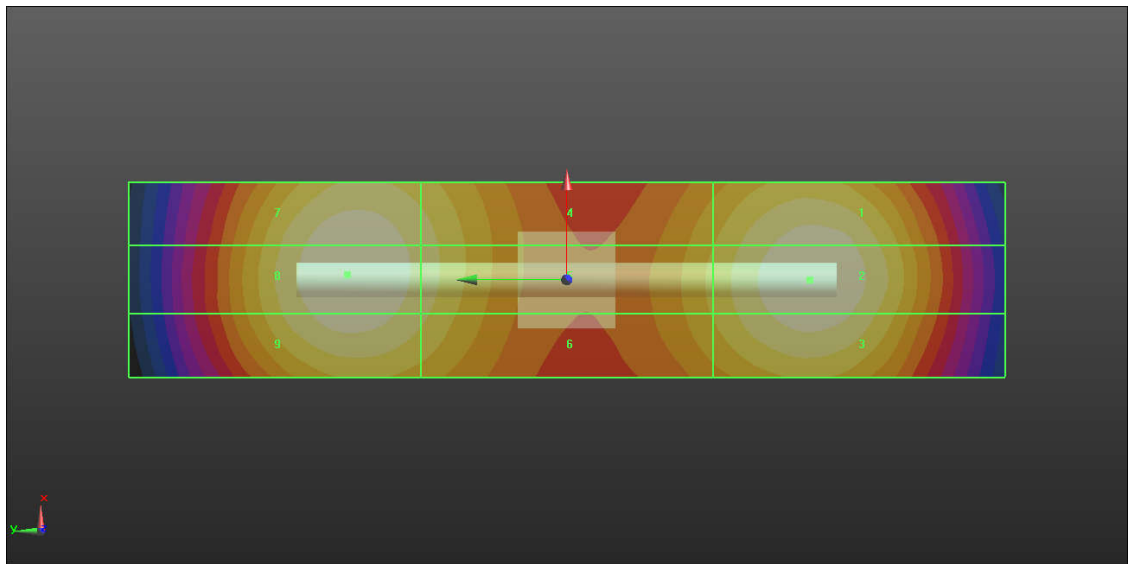
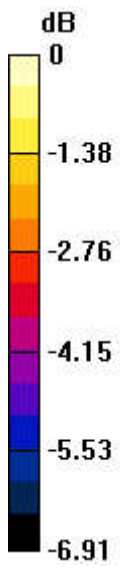

0 dB = 93.89 V/m = 40.04 dBV/m

**HAC\_E\_Dipole\_2600**

**DUT: HAC Dipole 2600 MHz**

Communication System: UID 0, CW (0); Frequency: 2600 MHz; Duty Cycle: 1:1

Medium: Air Medium parameters used:  $\sigma = 0$  S/m,  $\epsilon_r = 1$ ;  $\rho = 0$  kg/m<sup>3</sup>

Ambient Temperature : 23.3 °C;

DASY5 Configuration:

- Probe: EF3DV3 - SN4050; ConvF(1, 1, 1); Calibrated: 2022.1.31
- Electronics: DAE4 Sn1303; Calibrated: 2021.6.18
- Phantom: HAC Test Arch with AMCC; Type: SD HAC P01 BA;
- Measurement SW: DASY52, Version 52.10 (4); SEMCAD X Version 14.6.14 (7483)

**E Scan - measurement distance from the probe sensor center to CD2600 = 15mm/Hearing Aid Compatibility Test at 15mm distance (41x181x1): Interpolated grid:**

dx=0.5000 mm, dy=0.5000 mm

Device Reference Point: 0, 0, -6.3 mm

Reference Value = 73.76 V/m; Power Drift = 0.09 dB

PMR not calibrated. PMF = 1.000 is applied.

E-field emissions = 91.83 V/m

Average value of Total=(91.83+89.32)/2=90.575 V/m

PMF scaled E-field

<b>Grid 1 M3</b> <b>88.59 V/m</b>	<b>Grid 2 M3</b> <b>91.83 V/m</b>	<b>Grid 3 M3</b> <b>87.54 V/m</b>
<b>Grid 4 M3</b> <b>82.71 V/m</b>	<b>Grid 5 M3</b> <b>83.83 V/m</b>	<b>Grid 6 M3</b> <b>80.78 V/m</b>
<b>Grid 7 M3</b> <b>86.41 V/m</b>	<b>Grid 8 M3</b> <b>89.32 V/m</b>	<b>Grid 9 M3</b> <b>86.46 V/m</b>

Total = 91.83 V/m

E Category: M3

Location: 1, 22.5, 9.7 mm

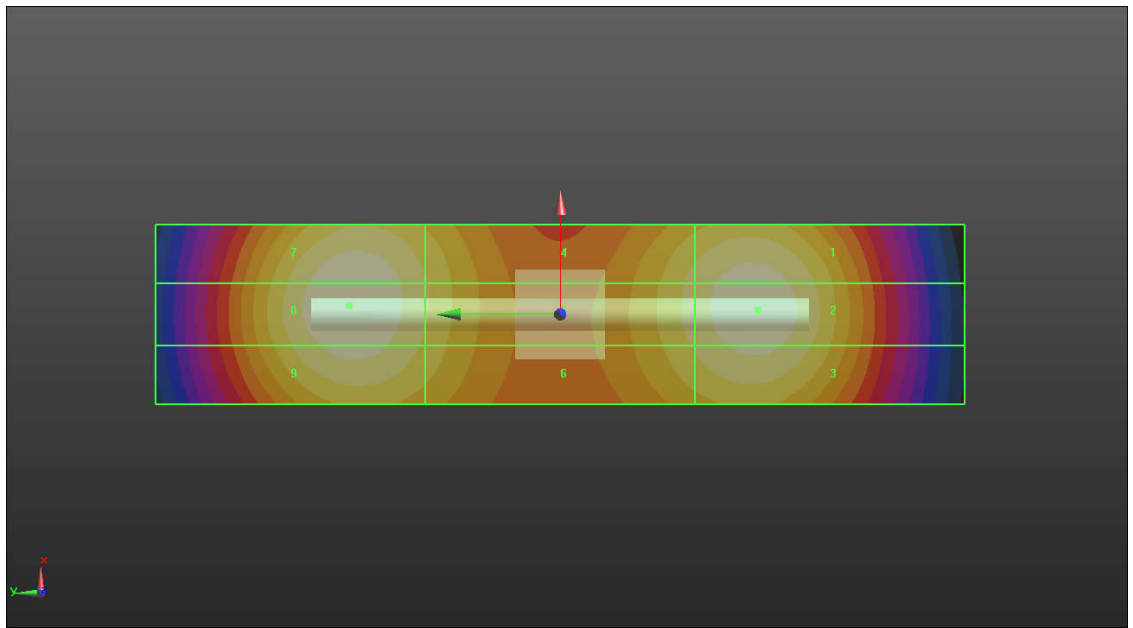
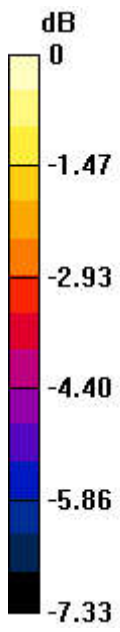

0 dB = 91.83 V/m = 38.96 dBV/m



**HAC\_E\_Dipole\_3500**

**DUT: HAC Dipole 3500 MHz**

Communication System: UID 0, CW (0); Frequency: 3500 MHz; Duty Cycle: 1:1

Medium: Air Medium parameters used:  $\sigma = 0$  S/m,  $\epsilon_r = 1$ ;  $\rho = 0$  kg/m<sup>3</sup>

Ambient Temperature : 23.3 °C

**DASY5 Configuration:**

- Probe: EF3DV3 - SN4050; ConvF(1, 1, 1); Calibrated: 2022.1.31
- Sensor-Surface: (Fix Surface)
- Electronics: DAE4 Sn1303; Calibrated: 2021.6.18
- Phantom: HAC Test Arch with AMCC; Type: SD HAC P01 BA;
- Measurement SW: DASY52, Version 52.10 (2); SEMCAD X Version 14.6.14 (7483)

**E Scan - measurement distance from the probe sensor center to CD3500 = 10mm & 15mm/Hearing Aid Compatibility Test at 15mm distance (41x121x1): Interpolated grid:**

dx=0.5000 mm, dy=0.5000 mm

Device Reference Point: 0, 0, -6.3 mm

Reference Value = 38.61 V/m; Power Drift = 0.02 dB

PMR not calibrated. PMF = 1.000 is applied.

E-field emissions = 88.81 V/m

Average value of Total=(88.81+87.76)/2 = 88.285 V/m

PMF scaled E-field

<b>Grid 1 M3</b> <b>86.26 V/m</b>	<b>Grid 2 M3</b> <b>88.81 V/m</b>	<b>Grid 3 M3</b> <b>86.32 V/m</b>
<b>Grid 4 M3</b> <b>83.06 V/m</b>	<b>Grid 5 M3</b> <b>84.84 V/m</b>	<b>Grid 6 M3</b> <b>84.71 V/m</b>
<b>Grid 7 M3</b> <b>86.57 V/m</b>	<b>Grid 8 M3</b> <b>87.76 V/m</b>	<b>Grid 9 M3</b> <b>85.62 V/m</b>

**Cursor:**

Total = 88.81 V/m

E Category: M3

Location: 0, -14.5, 9.7 mm

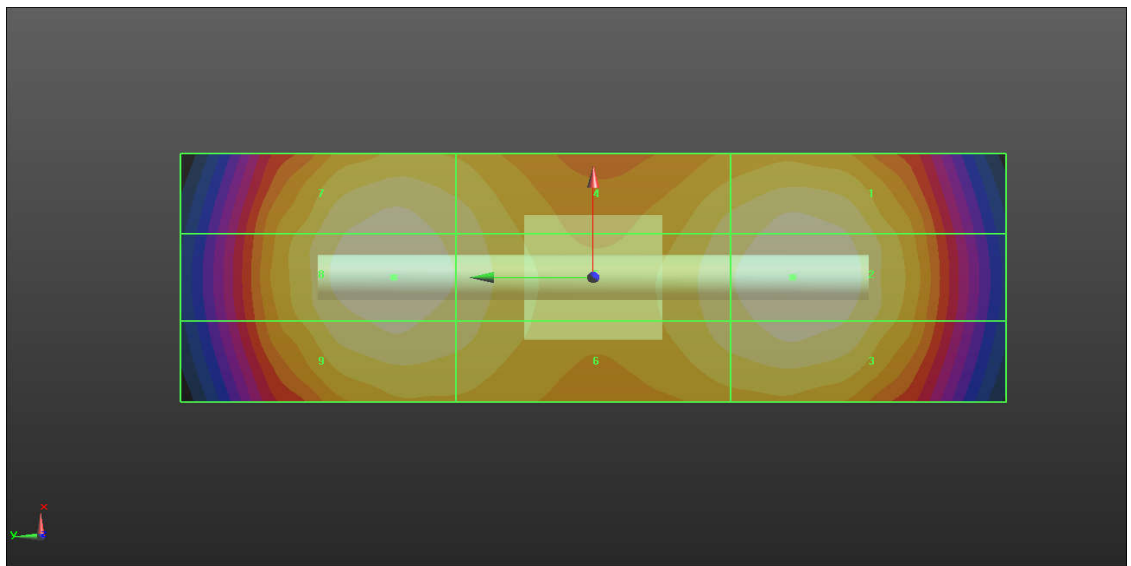
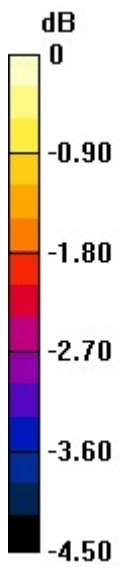

0 dB = 88.81 V/m = 38.99 dBV/m



---

**Appendix B. Plots of RF Emission Measurement**

The plots are shown as follows.

**01\_HAC RF GSM850\_Voice\_Ch128**

Communication System: UID 10021 - DAC, GSM-FDD (TDMA, GMSK); Frequency: 824.2 MHz; Duty Cycle: 1:8.69961

Medium: Air Medium parameters used:  $\sigma = 0 \text{ S/m}$ ,  $\epsilon_r = 1$ ;  $\rho = 0 \text{ kg/m}^3$

Ambient Temperature : 23.2 °C;

**DASY5 Configuration:**

- Probe: EF3DV3 - SN4050; ConvF(1, 1, 1); Calibrated: 2022.1.31
- Sensor-Surface: (Fix Surface)
- Electronics: DAE4 Sn1303; Calibrated: 2021.6.18
- Phantom: HAC Test Arch with AMCC; Type: SD HAC P01 BA;
- Measurement SW: DASY52, Version 52.10 (4); SEMCAD X Version 14.6.14 (7483)

**Ch128/Hearing Aid Compatibility Test (101x101x1):** Interpolated grid: dx=0.5000 mm, dy=0.5000 mm

Device Reference Point: 0, 0, -6.3 mm

Reference Value = 43.04 V/m; Power Drift = -0.09 dB

Applied MIF = 3.63 dB

RF audio interference level = 33.63 dBV/m

MIF scaled E-field

<b>Grid 1 M4</b> <b>33.27 dBV/m</b>	<b>Grid 2 M4</b> <b>33.63 dBV/m</b>	<b>Grid 3 M4</b> <b>33.15 dBV/m</b>
<b>Grid 4 M4</b> <b>33.28 dBV/m</b>	<b>Grid 5 M4</b> <b>33.6 dBV/m</b>	<b>Grid 6 M4</b> <b>33.09 dBV/m</b>
<b>Grid 7 M4</b> <b>32.94 dBV/m</b>	<b>Grid 8 M4</b> <b>33.27 dBV/m</b>	<b>Grid 9 M4</b> <b>32.72 dBV/m</b>

Total = 33.63 dBV/m

E Category: M4

Location: 0.5, -19.5, 8.7 mm

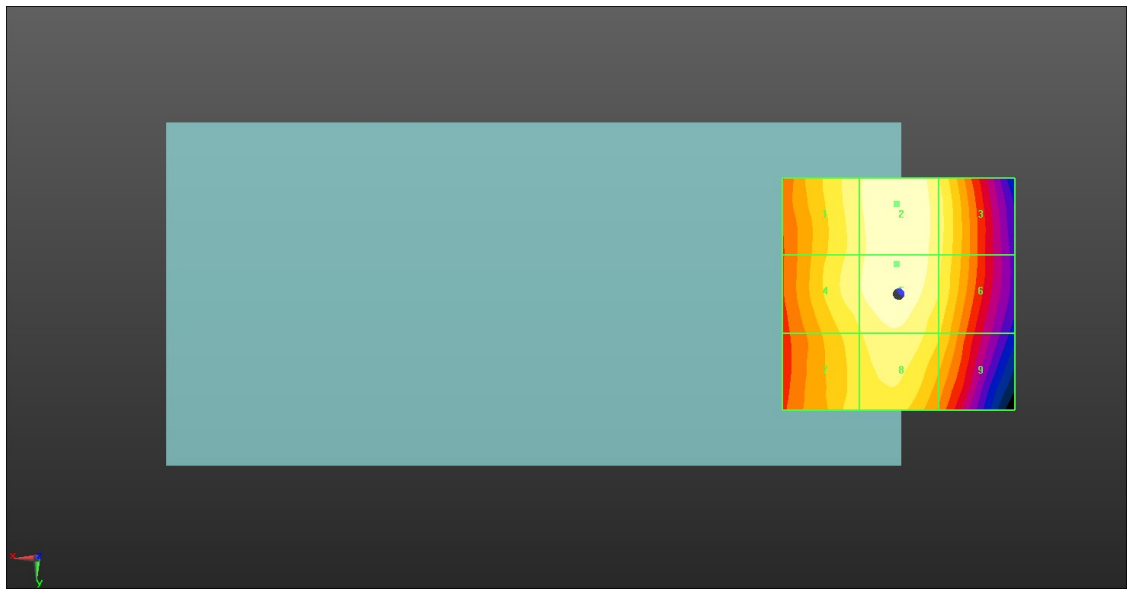
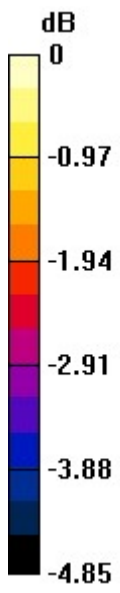

0 dB = 48.04 V/m = 33.63 dBV/m

**02\_HAC RF GSM850\_Voice\_Ch189**

Communication System: UID 10021 - DAC, GSM-FDD (TDMA, GMSK); Frequency: 836.4 MHz; Duty Cycle: 1:8.69961

Medium: Air Medium parameters used:  $\sigma = 0 \text{ S/m}$ ,  $\epsilon_r = 1$ ;  $\rho = 0 \text{ kg/m}^3$

Ambient Temperature : 23.2 °C;

**DASY5 Configuration:**

- Probe: EF3DV3 - SN4050; ConvF(1, 1, 1); Calibrated: 2022.1.31
- Sensor-Surface: (Fix Surface)
- Electronics: DAE4 Sn1303; Calibrated: 2021.6.18
- Phantom: HAC Test Arch with AMCC; Type: SD HAC P01 BA;
- Measurement SW: DASY52, Version 52.10 (4); SEMCAD X Version 14.6.14 (7483)

**Ch189/Hearing Aid Compatibility Test (101x101x1):** Interpolated grid: dx=0.5000 mm, dy=0.5000 mm

Device Reference Point: 0, 0, -6.3 mm

Reference Value = 46.51 V/m; Power Drift = 0.03 dB

Applied MIF = 3.63 dB

RF audio interference level = 34.11 dBV/m

MIF scaled E-field

<b>Grid 1 M4</b> <b>33.59 dBV/m</b>	<b>Grid 2 M4</b> <b>34.01 dBV/m</b>	<b>Grid 3 M4</b> <b>33.48 dBV/m</b>
<b>Grid 4 M4</b> <b>33.83 dBV/m</b>	<b>Grid 5 M4</b> <b>34.11 dBV/m</b>	<b>Grid 6 M4</b> <b>33.47 dBV/m</b>
<b>Grid 7 M4</b> <b>33.83 dBV/m</b>	<b>Grid 8 M4</b> <b>33.97 dBV/m</b>	<b>Grid 9 M4</b> <b>33.3 dBV/m</b>

Total = 34.11 dBV/m

E Category: M4

Location: 1.5, -0.5, 8.7 mm

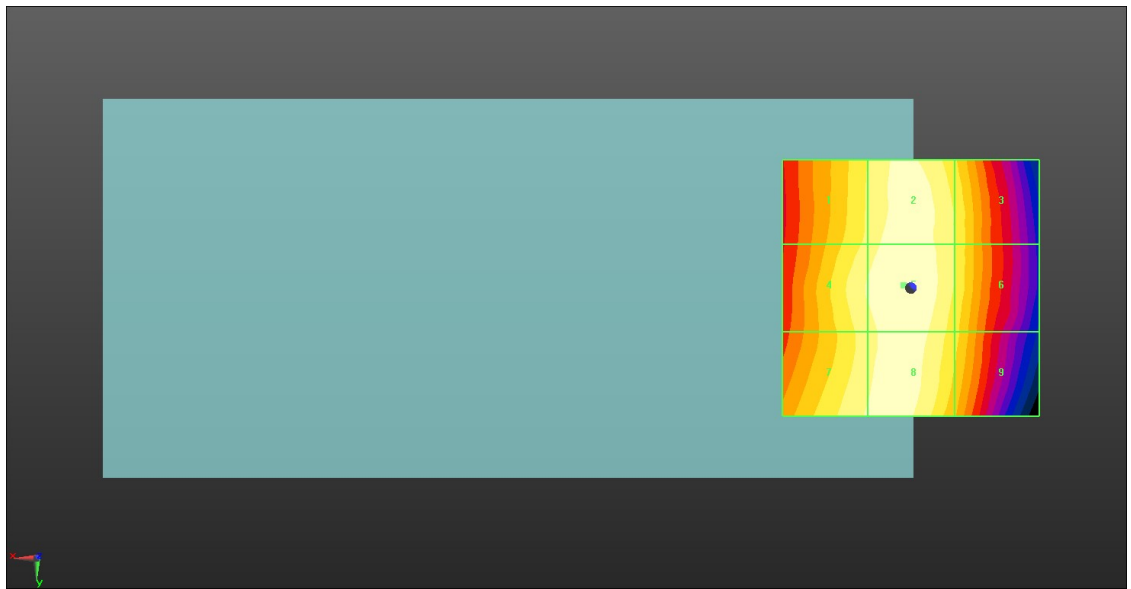
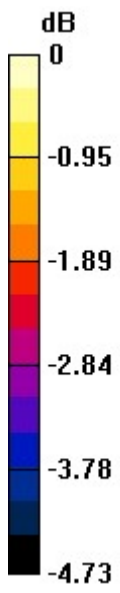

0 dB = 50.78 V/m = 34.11 dBV/m

**03\_HAC RF GSM850\_Voice\_Ch251**

Communication System: UID 10021 - DAC, GSM-FDD (TDMA, GMSK); Frequency: 848.8 MHz; Duty Cycle: 1:8.69961

Medium: Air Medium parameters used:  $\sigma = 0 \text{ S/m}$ ,  $\epsilon_r = 1$ ;  $\rho = 0 \text{ kg/m}^3$

Ambient Temperature : 23.2 °C;

**DASY5 Configuration:**

- Probe: EF3DV3 - SN4050; ConvF(1, 1, 1); Calibrated: 2022.1.31
- Sensor-Surface: (Fix Surface)
- Electronics: DAE4 Sn1303; Calibrated: 2021.6.18
- Phantom: HAC Test Arch with AMCC; Type: SD HAC P01 BA;
- Measurement SW: DASY52, Version 52.10 (4); SEMCAD X Version 14.6.14 (7483)

**Ch251/Hearing Aid Compatibility Test (101x101x1):** Interpolated grid: dx=0.5000 mm, dy=0.5000 mm

Device Reference Point: 0, 0, -6.3 mm

Reference Value = 42.16 V/m; Power Drift = -0.03 dB

Applied MIF = 3.63 dB

RF audio interference level = 33.68 dBV/m

MIF scaled E-field

<b>Grid 1 M4</b> <b>32.84 dBV/m</b>	<b>Grid 2 M4</b> <b>33.65 dBV/m</b>	<b>Grid 3 M4</b> <b>33.23 dBV/m</b>
<b>Grid 4 M4</b> <b>33.03 dBV/m</b>	<b>Grid 5 M4</b> <b>33.68 dBV/m</b>	<b>Grid 6 M4</b> <b>33.22 dBV/m</b>
<b>Grid 7 M4</b> <b>32.87 dBV/m</b>	<b>Grid 8 M4</b> <b>33.48 dBV/m</b>	<b>Grid 9 M4</b> <b>32.89 dBV/m</b>

Total = 33.68 dBV/m

E Category: M4

Location: -0.5, -1, 8.7 mm



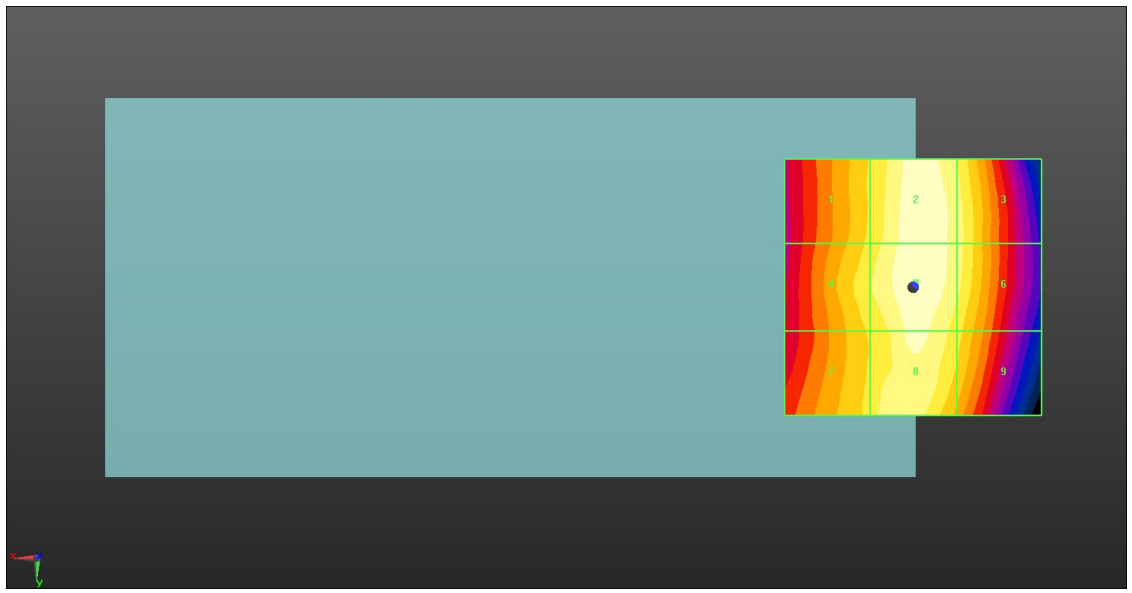
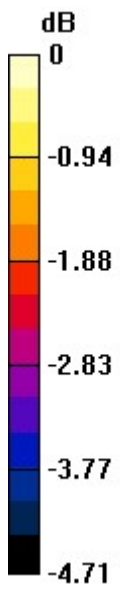

0 dB = 48.33 V/m = 33.68 dBV/m

**04\_HAC RF GSM1900\_Voice\_Ch512**

Communication System: UID 10021 - DAC, GSM-FDD (TDMA, GMSK); Frequency: 1850.2 MHz; Duty Cycle: 1:8.69961

Medium: Air Medium parameters used:  $\sigma = 0 \text{ S/m}$ ,  $\epsilon_r = 1$ ;  $\rho = 0 \text{ kg/m}^3$

Ambient Temperature : 23.3 °C;

DASY5 Configuration:

- Probe: EF3DV3 - SN4050; ConvF(1, 1, 1); Calibrated: 2022.1.31
- Sensor-Surface: (Fix Surface)
- Electronics: DAE4 Sn1303; Calibrated: 2021.6.18
- Phantom: HAC Test Arch with AMCC; Type: SD HAC P01 BA;
- Measurement SW: DASY52, Version 52.10 (4); SEMCAD X Version 14.6.14 (7483)

**Ch512/Hearing Aid Compatibility Test (101x101x1):** Interpolated grid: dx=0.5000 mm, dy=0.5000 mm

Device Reference Point: 0, 0, -6.3 mm

Reference Value = 8.258 V/m; Power Drift = -0.01 dB

Applied MIF = 3.63 dB

RF audio interference level = 24.50 dBV/m

MIF scaled E-field

<b>Grid 1 M4</b> <b>24.44 dBV/m</b>	<b>Grid 2 M4</b> <b>23.18 dBV/m</b>	<b>Grid 3 M4</b> <b>21.19 dBV/m</b>
<b>Grid 4 M4</b> <b>24.5 dBV/m</b>	<b>Grid 5 M4</b> <b>22.63 dBV/m</b>	<b>Grid 6 M4</b> <b>17.49 dBV/m</b>
<b>Grid 7 M4</b> <b>24.23 dBV/m</b>	<b>Grid 8 M4</b> <b>23.16 dBV/m</b>	<b>Grid 9 M4</b> <b>20.61 dBV/m</b>

Total = 24.50 dBV/m

E Category: M4

Location: 25, -5.5, 8.7 mm

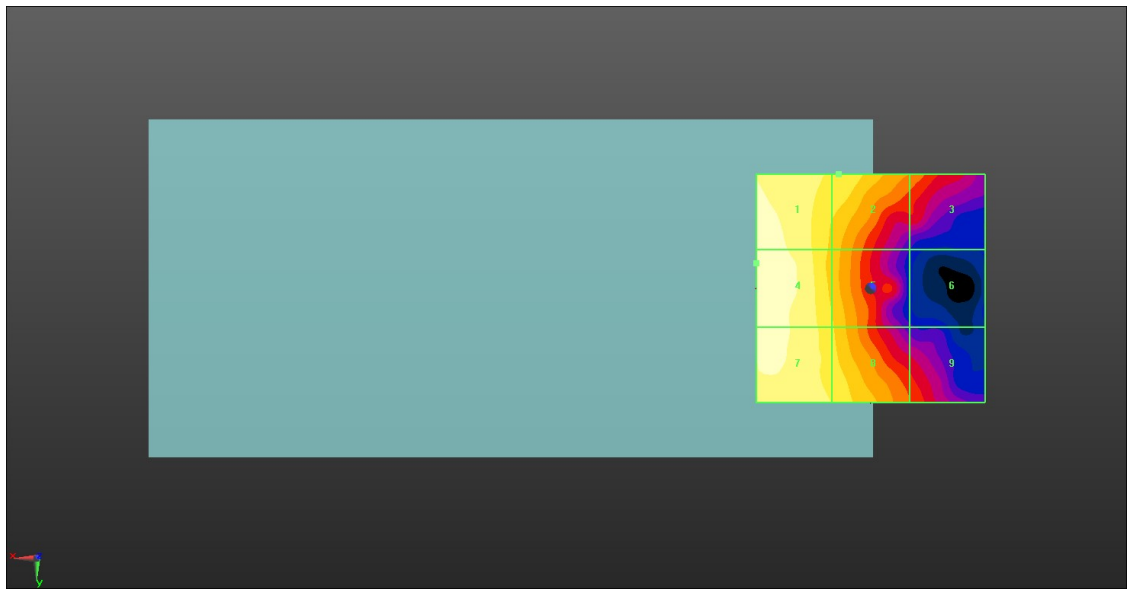
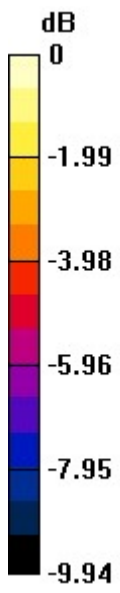

0 dB = 16.79 V/m = 24.50 dBV/m

**05\_HAC RF GSM1900\_Voice\_Ch661**

Communication System: UID 10021 - DAC, GSM-FDD (TDMA, GMSK); Frequency: 1880 MHz; Duty Cycle: 1:8.69961

Medium: Air Medium parameters used:  $\sigma = 0 \text{ S/m}$ ,  $\epsilon_r = 1$ ;  $\rho = 0 \text{ kg/m}^3$

Ambient Temperature : 23.3 °C;

DASY5 Configuration:

- Probe: EF3DV3 - SN4050; ConvF(1, 1, 1); Calibrated: 2022.1.31

- Sensor-Surface: (Fix Surface)

- Electronics: DAE4 Sn1303; Calibrated: 2021.6.18

- Phantom: HAC Test Arch with AMCC; Type: SD HAC P01 BA;

- Measurement SW: DASY52, Version 52.10 (4); SEMCAD X Version 14.6.14 (7483)

**Ch661/Hearing Aid Compatibility Test (101x101x1):** Interpolated grid: dx=0.5000 mm, dy=0.5000 mm

Device Reference Point: 0, 0, -6.3 mm

Reference Value = 7.837 V/m; Power Drift = 0.08 dB

Applied MIF = 3.63 dB

RF audio interference level = 24.10 dBV/m

MIF scaled E-field

<b>Grid 1 M4</b> <b>24.1 dBV/m</b>	<b>Grid 2 M4</b> <b>23.83 dBV/m</b>	<b>Grid 3 M4</b> <b>21.16 dBV/m</b>
<b>Grid 4 M4</b> <b>24.1 dBV/m</b>	<b>Grid 5 M4</b> <b>22.52 dBV/m</b>	<b>Grid 6 M4</b> <b>18.66 dBV/m</b>
<b>Grid 7 M4</b> <b>23.82 dBV/m</b>	<b>Grid 8 M4</b> <b>22.65 dBV/m</b>	<b>Grid 9 M4</b> <b>20.69 dBV/m</b>

Total = 24.10 dBV/m

E Category: M4

Location: 25, -9, 8.7 mm

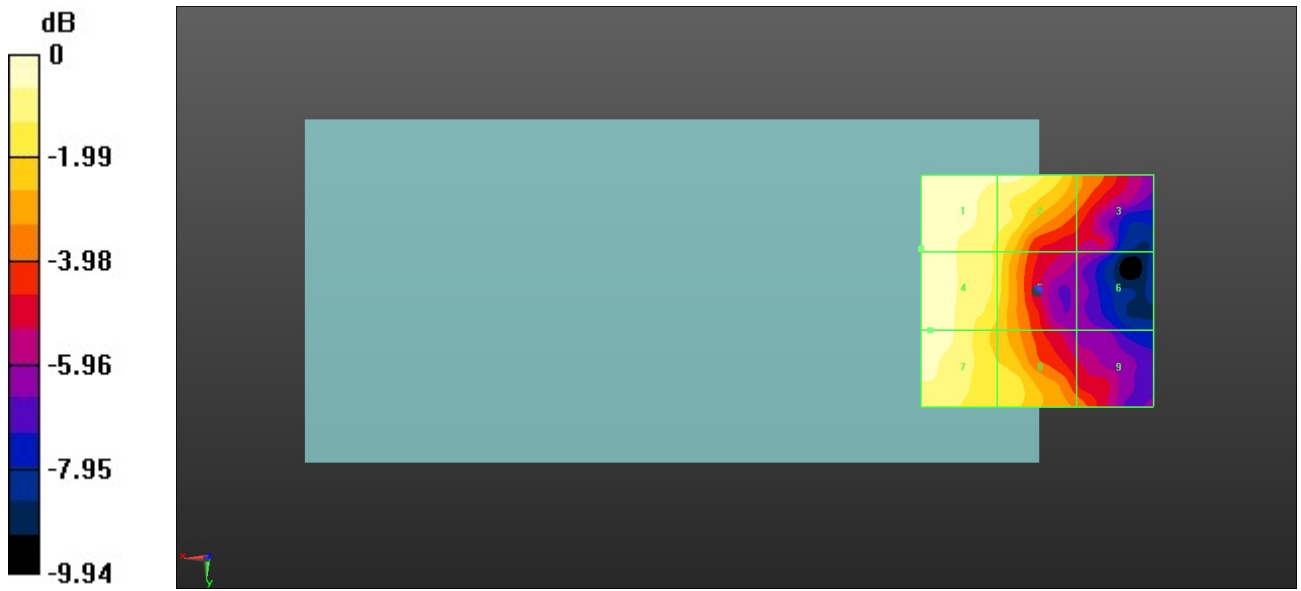

0 dB = 16.03 V/m = 24.10 dBV/m

**06\_HAC RF GSM1900\_Voice\_Ch810**

Communication System: UID 10021 - DAC, GSM-FDD (TDMA, GMSK); Frequency: 1909.8 MHz; Duty Cycle: 1:8.69961

Medium: Air Medium parameters used:  $\sigma = 0$  S/m,  $\epsilon_r = 1$ ;  $\rho = 0$  kg/m<sup>3</sup>

Ambient Temperature : 23.2 °C;

**DASY5 Configuration:**

- Probe: EF3DV3 - SN4050; ConvF(1, 1, 1); Calibrated: 2022.1.31
- Sensor-Surface: (Fix Surface)
- Electronics: DAE4 Sn1303; Calibrated: 2021.6.18
- Phantom: HAC Test Arch with AMCC; Type: SD HAC P01 BA;
- Measurement SW: DASY52, Version 52.10 (4); SEMCAD X Version 14.6.14 (7483)

**Ch810/Hearing Aid Compatibility Test (101x101x1):** Interpolated grid: dx=0.5000 mm, dy=0.5000 mm

Device Reference Point: 0, 0, -6.3 mm

Reference Value = 7.899 V/m; Power Drift = 0.06 dB

Applied MIF = 3.63 dB

RF audio interference level = 23.89 dBV/m

MIF scaled E-field

<b>Grid 1 M4</b> <b>23.75 dBV/m</b>	<b>Grid 2 M4</b> <b>22.69 dBV/m</b>	<b>Grid 3 M4</b> <b>22.43 dBV/m</b>
<b>Grid 4 M4</b> <b>23.89 dBV/m</b>	<b>Grid 5 M4</b> <b>21.9 dBV/m</b>	<b>Grid 6 M4</b> <b>16.38 dBV/m</b>
<b>Grid 7 M4</b> <b>23.61 dBV/m</b>	<b>Grid 8 M4</b> <b>22.14 dBV/m</b>	<b>Grid 9 M4</b> <b>19.4 dBV/m</b>

Total = 23.89 dBV/m

E Category: M4

Location: 25, -4, 8.7 mm

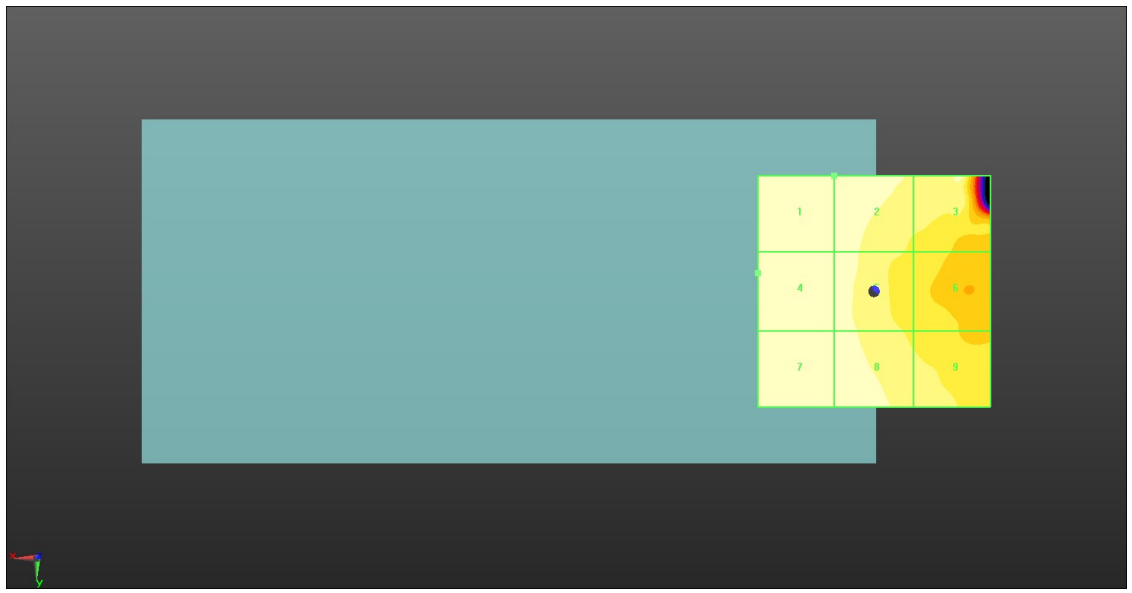
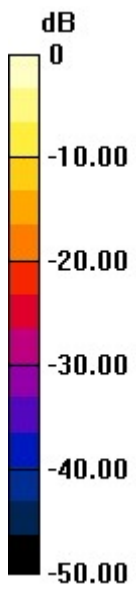

0 dB = 15.65 V/m = 23.89 dBV/m

**07\_HAC RF LTE B41\_20M\_QPSK\_1RB\_0Offset\_Ch39750**

Communication System: UID 10173 - CAG, LTE-TDD (SC-FDMA, 1 RB, 20 MHz, 16-QAM);  
 Frequency: 2506 MHz; Duty Cycle: 1:8.8736

Medium: Air Medium parameters used:  $\sigma = 0$  S/m,  $\epsilon_r = 1$ ;  $\rho = 0$  kg/m<sup>3</sup>

Ambient Temperature : 23.3 °C;

DASY5 Configuration:

- Probe: EF3DV3 - SN4050; ConvF(1, 1, 1); Calibrated: 2022.1.31
- Sensor-Surface: (Fix Surface)
- Electronics: DAE4 Sn1303; Calibrated: 2021.6.18
- Phantom: HAC Test Arch with AMCC; Type: SD HAC P01 BA;
- Measurement SW: DASY52, Version 52.10 (4); SEMCAD X Version 14.6.14 (7483)

**Ch39750/Hearing Aid Compatibility Test (101x101x1):** Interpolated grid: dx=0.5000 mm, dy=0.5000 mm

Device Reference Point: 0, 0, -6.3 mm

Reference Value = 16.22 V/m; Power Drift = -0.03 dB

Applied MIF = -1.44 dB

RF audio interference level = 26.76 dBV/m

MIF scaled E-field

<b>Grid 1 M4</b> <b>25.57 dBV/m</b>	<b>Grid 2 M4</b> <b>26.76 dBV/m</b>	<b>Grid 3 M4</b> <b>25.91 dBV/m</b>
<b>Grid 4 M4</b> <b>21.05 dBV/m</b>	<b>Grid 5 M4</b> <b>22.69 dBV/m</b>	<b>Grid 6 M4</b> <b>22.27 dBV/m</b>
<b>Grid 7 M4</b> <b>20.44 dBV/m</b>	<b>Grid 8 M4</b> <b>23.31 dBV/m</b>	<b>Grid 9 M4</b> <b>23.31 dBV/m</b>

Total = 26.76 dBV/m

E Category: M4

Location: -0.5, -25, 8.7 mm



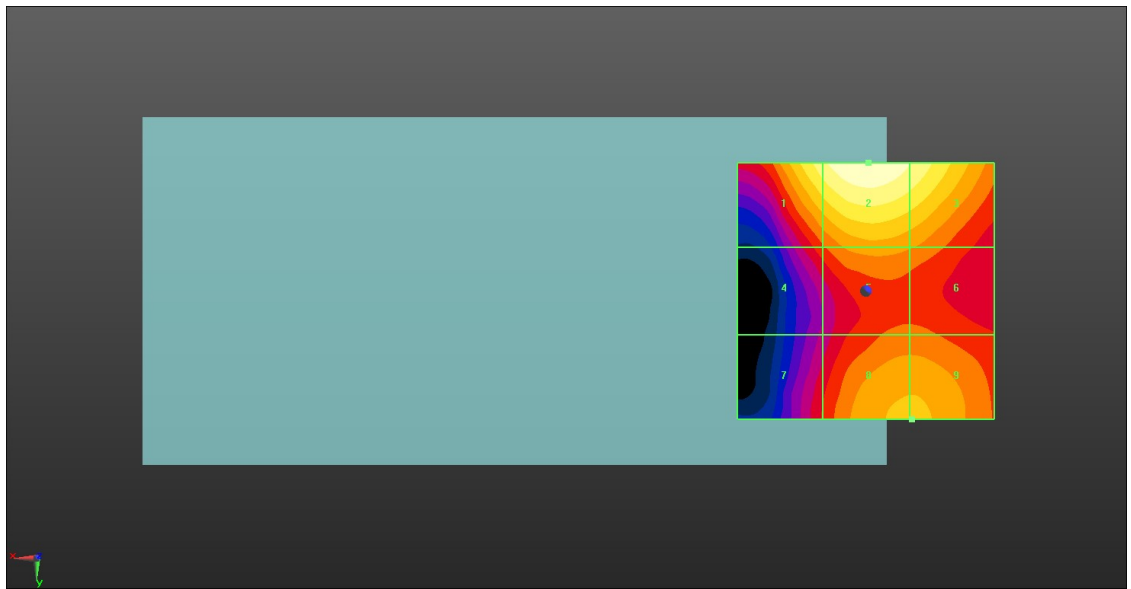
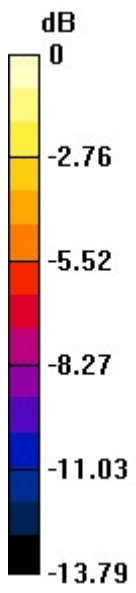

0 dB = 21.78 V/m = 26.76 dBV/m

**08\_HAC RF LTE B41\_20M\_QPSK\_1RB\_0Offset\_Ch40185**

Communication System: UID 10173 - CAG, LTE-TDD (SC-FDMA, 1 RB, 20 MHz, 16-QAM);  
 Frequency: 2549.5 MHz; Duty Cycle: 1:8.8736

Medium: Air Medium parameters used:  $\sigma = 0$  S/m,  $\epsilon_r = 1$ ;  $\rho = 0$  kg/m<sup>3</sup>

Ambient Temperature : 23.3 °C;

DASY5 Configuration:

- Probe: EF3DV3 - SN4050; ConvF(1, 1, 1); Calibrated: 2022.1.31
- Sensor-Surface: (Fix Surface)
- Electronics: DAE4 Sn1303; Calibrated: 2021.6.18
- Phantom: HAC Test Arch with AMCC; Type: SD HAC P01 BA;
- Measurement SW: DASY52, Version 52.10 (4); SEMCAD X Version 14.6.14 (7483)

**Ch40185/Hearing Aid Compatibility Test (101x101x1):** Interpolated grid: dx=0.5000 mm, dy=0.5000 mm

Device Reference Point: 0, 0, -6.3 mm

Reference Value = 16.61 V/m; Power Drift = 0.09 dB

Applied MIF = -1.44 dB

RF audio interference level = 26.61 dBV/m

MIF scaled E-field

<b>Grid 1 M4</b> <b>25.6 dBV/m</b>	<b>Grid 2 M4</b> <b>26.61 dBV/m</b>	<b>Grid 3 M4</b> <b>26.03 dBV/m</b>
<b>Grid 4 M4</b> <b>21.21 dBV/m</b>	<b>Grid 5 M4</b> <b>23.47 dBV/m</b>	<b>Grid 6 M4</b> <b>23.25 dBV/m</b>
<b>Grid 7 M4</b> <b>20.3 dBV/m</b>	<b>Grid 8 M4</b> <b>21.39 dBV/m</b>	<b>Grid 9 M4</b> <b>21.23 dBV/m</b>

Total = 26.61 dBV/m

E Category: M4

Location: -0.5, -25, 8.7 mm

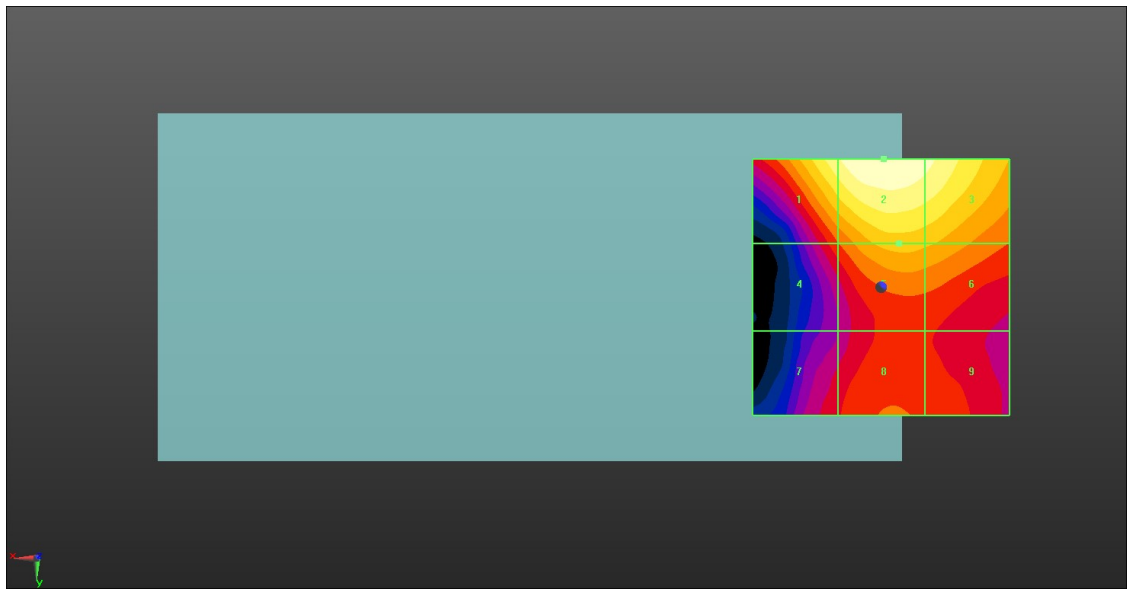
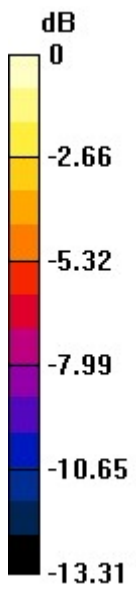

0 dB = 21.41 V/m = 26.61 dBV/m

**09\_HAC RF LTE B41\_20M\_QPSK\_1RB\_0Offset\_Ch40620**

Communication System: UID 10173 - CAG, LTE-TDD (SC-FDMA, 1 RB, 20 MHz, 16-QAM);  
 Frequency: 2593 MHz; Duty Cycle: 1:8.8736

Medium: Air Medium parameters used:  $\sigma = 0$  S/m,  $\epsilon_r = 1$ ;  $\rho = 0$  kg/m<sup>3</sup>

Ambient Temperature : 23.3 °C;

DASY5 Configuration:

- Probe: EF3DV3 - SN4050; ConvF(1, 1, 1); Calibrated: 2022.1.31
- Sensor-Surface: (Fix Surface)
- Electronics: DAE4 Sn1303; Calibrated: 2021.6.18
- Phantom: HAC Test Arch with AMCC; Type: SD HAC P01 BA;
- Measurement SW: DASY52, Version 52.10 (4); SEMCAD X Version 14.6.14 (7483)

**Ch40620/Hearing Aid Compatibility Test (101x101x1):** Interpolated grid: dx=0.5000 mm, dy=0.5000 mm

Device Reference Point: 0, 0, -6.3 mm

Reference Value = 15.07 V/m; Power Drift = 0.07 dB

Applied MIF = -1.44 dB

RF audio interference level = 26.34 dBV/m

MIF scaled E-field

<b>Grid 1 M4</b> <b>24.92 dBV/m</b>	<b>Grid 2 M4</b> <b>26.34 dBV/m</b>	<b>Grid 3 M4</b> <b>25.71 dBV/m</b>
<b>Grid 4 M4</b> <b>19.8 dBV/m</b>	<b>Grid 5 M4</b> <b>22.76 dBV/m</b>	<b>Grid 6 M4</b> <b>22.67 dBV/m</b>
<b>Grid 7 M4</b> <b>19.66 dBV/m</b>	<b>Grid 8 M4</b> <b>21.64 dBV/m</b>	<b>Grid 9 M4</b> <b>21.45 dBV/m</b>

Total = 26.34 dBV/m

E Category: M4

Location: -1, -25, 8.7 mm

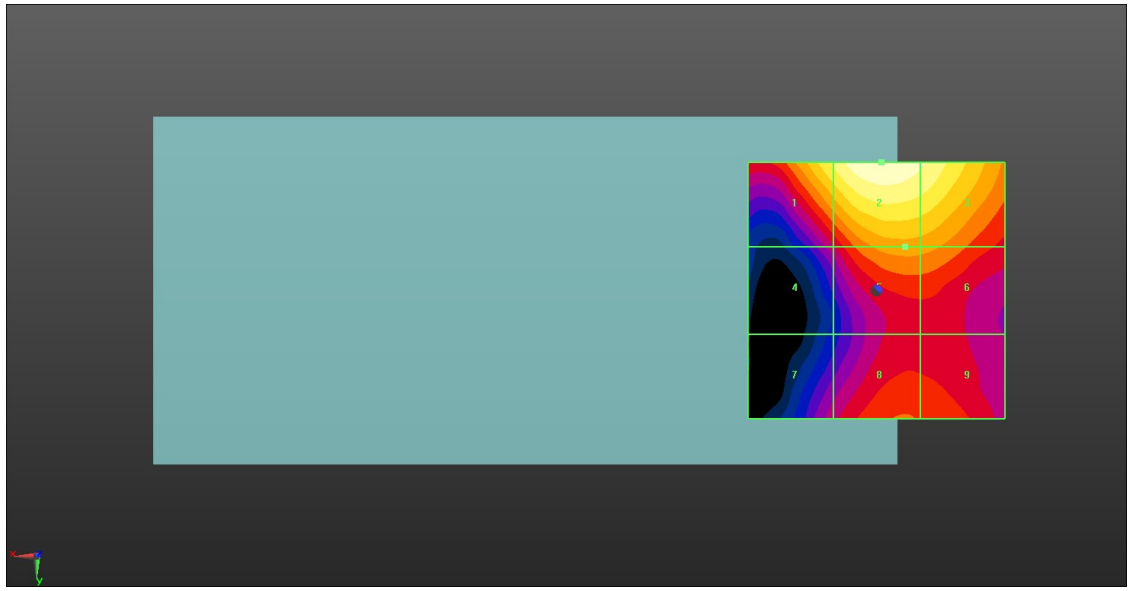
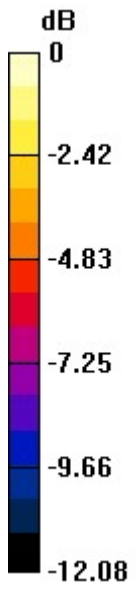

0 dB = 20.75 V/m = 26.34 dBV/m

**10\_HAC RF LTE B41\_20M\_QPSK\_1RB\_0Offset\_Ch41055**

Communication System: UID 10173 - CAG, LTE-TDD (SC-FDMA, 1 RB, 20 MHz, 16-QAM);  
 Frequency: 2636.5 MHz; Duty Cycle: 1:8.8736

Medium: Air Medium parameters used:  $\sigma = 0$  S/m,  $\epsilon_r = 1$ ;  $\rho = 0$  kg/m<sup>3</sup>

Ambient Temperature : 23.3 °C;

DASY5 Configuration:

- Probe: EF3DV3 - SN4050; ConvF(1, 1, 1); Calibrated: 2022.1.31
- Sensor-Surface: (Fix Surface)
- Electronics: DAE4 Sn1303; Calibrated: 2021.6.18
- Phantom: HAC Test Arch with AMCC; Type: SD HAC P01 BA;
- Measurement SW: DASY52, Version 52.10 (4); SEMCAD X Version 14.6.14 (7483)

**Ch41055/Hearing Aid Compatibility Test (101x101x1):** Interpolated grid: dx=0.5000 mm, dy=0.5000 mm

Device Reference Point: 0, 0, -6.3 mm

Reference Value = 14.34 V/m; Power Drift = 0.03 dB

Applied MIF = -1.44 dB

RF audio interference level = 26.22 dBV/m

MIF scaled E-field

<b>Grid 1 M4</b> <b>24.73 dBV/m</b>	<b>Grid 2 M4</b> <b>26.22 dBV/m</b>	<b>Grid 3 M4</b> <b>25.64 dBV/m</b>
<b>Grid 4 M4</b> <b>19.3 dBV/m</b>	<b>Grid 5 M4</b> <b>22.37 dBV/m</b>	<b>Grid 6 M4</b> <b>22.35 dBV/m</b>
<b>Grid 7 M4</b> <b>18.08 dBV/m</b>	<b>Grid 8 M4</b> <b>20.21 dBV/m</b>	<b>Grid 9 M4</b> <b>20.21 dBV/m</b>

Total = 26.22 dBV/m

E Category: M4

Location: -1, -25, 8.7 mm

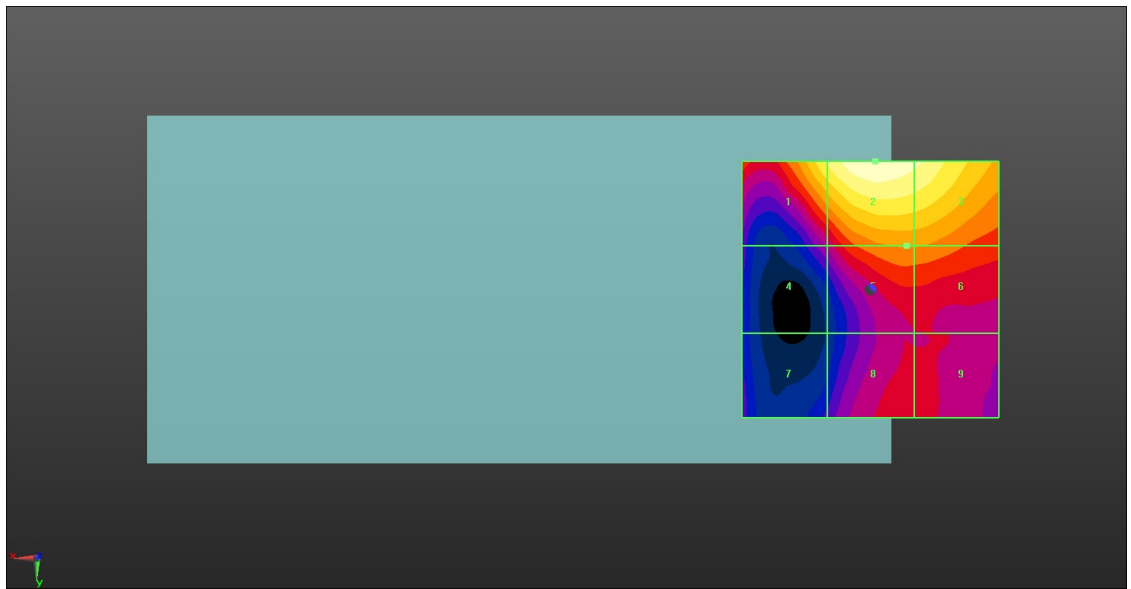
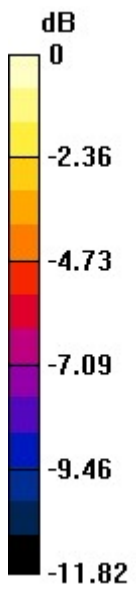

0 dB = 20.46 V/m = 26.22 dBV/m

**11\_HAC RF LTE B41\_20M\_QPSK\_1RB\_0Offset\_Ch41490**

Communication System: UID 10173 - CAG, LTE-TDD (SC-FDMA, 1 RB, 20 MHz, 16-QAM);  
 Frequency: 2680 MHz; Duty Cycle: 1:8.8736

Medium: Air Medium parameters used:  $\sigma = 0$  S/m,  $\epsilon_r = 1$ ;  $\rho = 0$  kg/m<sup>3</sup>

Ambient Temperature : 23.3 °C;

DASY5 Configuration:

- Probe: EF3DV3 - SN4050; ConvF(1, 1, 1); Calibrated: 2022.1.31
- Sensor-Surface: (Fix Surface)
- Electronics: DAE4 Sn1303; Calibrated: 2021.6.18
- Phantom: HAC Test Arch with AMCC; Type: SD HAC P01 BA;
- Measurement SW: DASY52, Version 52.10 (4); SEMCAD X Version 14.6.14 (7483)

**Ch41490/Hearing Aid Compatibility Test (101x101x1):** Interpolated grid: dx=0.5000 mm, dy=0.5000 mm

Device Reference Point: 0, 0, -6.3 mm

Reference Value = 11.58 V/m; Power Drift = 0.01 dB

Applied MIF = -1.44 dB

RF audio interference level = 26.02 dBV/m

MIF scaled E-field

<b>Grid 1 M4</b> <b>23.94 dBV/m</b>	<b>Grid 2 M4</b> <b>26.02 dBV/m</b>	<b>Grid 3 M4</b> <b>25.51 dBV/m</b>
<b>Grid 4 M4</b> <b>18.84 dBV/m</b>	<b>Grid 5 M4</b> <b>21.66 dBV/m</b>	<b>Grid 6 M4</b> <b>21.49 dBV/m</b>
<b>Grid 7 M4</b> <b>18.09 dBV/m</b>	<b>Grid 8 M4</b> <b>20.81 dBV/m</b>	<b>Grid 9 M4</b> <b>20.81 dBV/m</b>

Total = 26.02 dBV/m

E Category: M4

Location: -1.5, -25, 8.7 mm



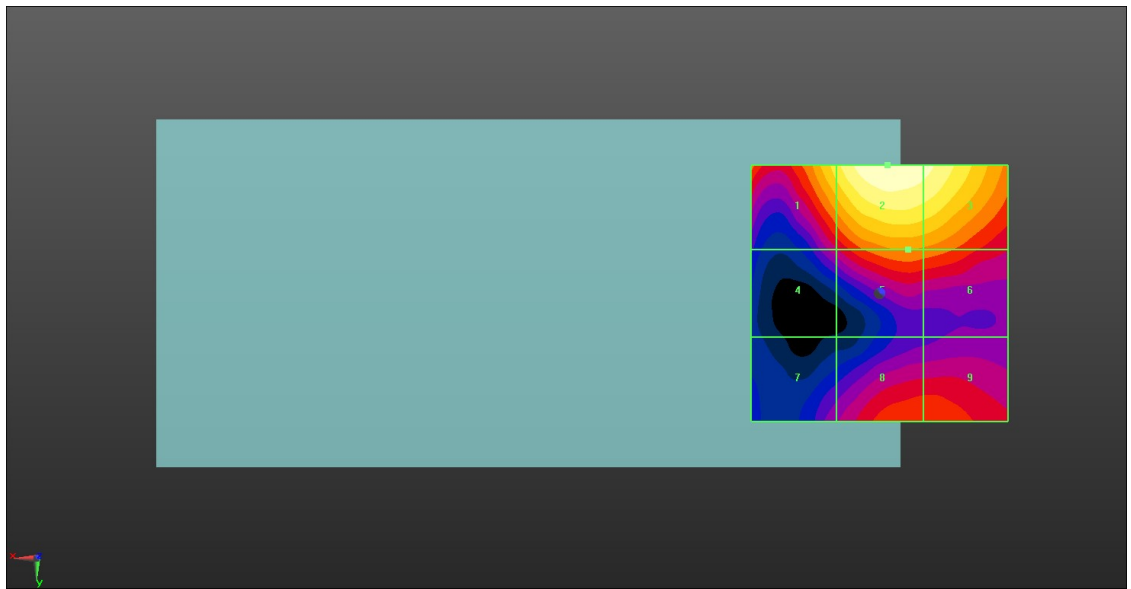
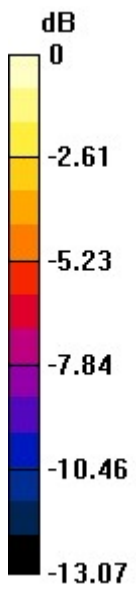

0 dB = 19.99 V/m = 26.02 dBV/m

**12\_HAC RF LTE B42\_20M\_QPSK\_1RB\_0Offset\_Ch42190**

Communication System: UID 10173 - CAG, LTE-TDD (SC-FDMA, 1 RB, 20 MHz, 16-QAM);  
 Frequency: 3460 MHz; Duty Cycle: 1:8.8736

Medium: Air Medium parameters used:  $\sigma = 0$  S/m,  $\epsilon_r = 1$ ;  $\rho = 0$  kg/m<sup>3</sup>

Ambient Temperature : 23.3 °C;

DASY5 Configuration:

- Probe: EF3DV3 - SN4050; ConvF(1, 1, 1); Calibrated: 2022.1.31
- Sensor-Surface: (Fix Surface)
- Electronics: DAE4 Sn1303; Calibrated: 2021.6.18
- Phantom: HAC Test Arch with AMCC; Type: SD HAC P01 BA;
- Measurement SW: DASY52, Version 52.10 (4); SEMCAD X Version 14.6.14 (7483)

**Ch42190/Hearing Aid Compatibility Test (101x101x1):** Interpolated grid: dx=0.5000 mm, dy=0.5000 mm

Device Reference Point: 0, 0, -6.3 mm

Reference Value = 57.76 V/m; Power Drift = -0.05 dB

Applied MIF = -1.44 dB

RF audio interference level = 30.40 dBV/m

MIF scaled E-field

<b>Grid 1 M4</b> <b>27.38 dBV/m</b>	<b>Grid 2 M4</b> <b>29.34 dBV/m</b>	<b>Grid 3 M4</b> <b>29.12 dBV/m</b>
<b>Grid 4 M4</b> <b>27.75 dBV/m</b>	<b>Grid 5 M4</b> <b>29.54 dBV/m</b>	<b>Grid 6 M4</b> <b>29.34 dBV/m</b>
<b>Grid 7 M3</b> <b>30.4 dBV/m</b>	<b>Grid 8 M4</b> <b>29.17 dBV/m</b>	<b>Grid 9 M4</b> <b>27.9 dBV/m</b>

Total = 30.40 dBV/m

E Category: M3

Location: 25, 25, 8.7 mm

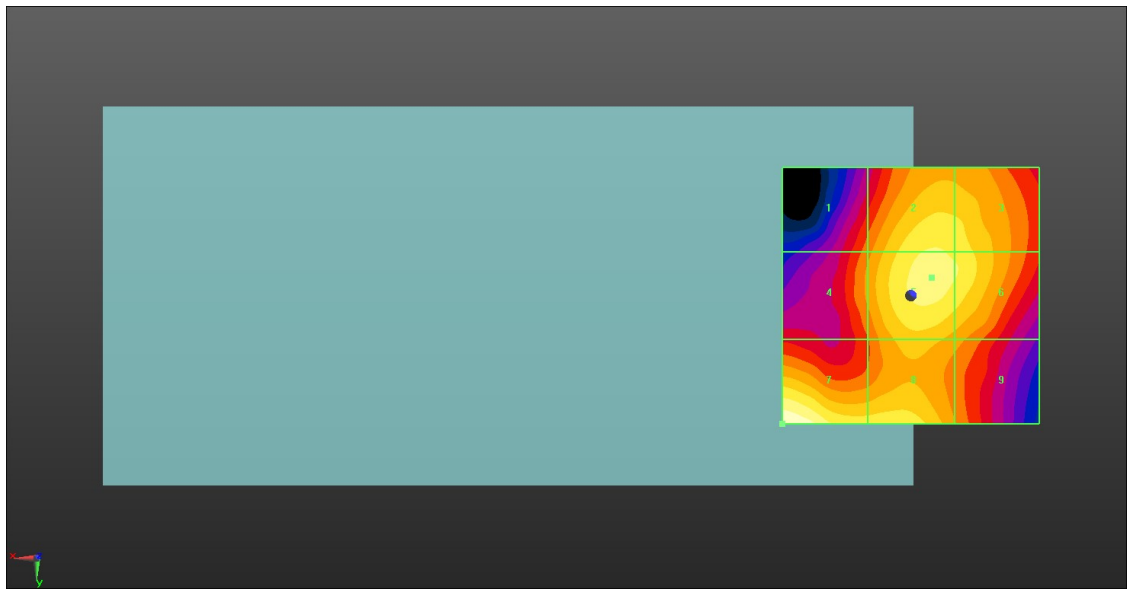
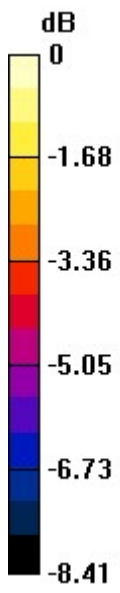

0 dB = 33.10 V/m = 30.40 dBV/m

**13\_HAC RF LTE B42\_20M\_QPSK\_1RB\_0Offset\_Ch42590**

Communication System: UID 10173 - CAG, LTE-TDD (SC-FDMA, 1 RB, 20 MHz, 16-QAM);  
 Frequency: 3500 MHz; Duty Cycle: 1:8.8736

Medium: Air Medium parameters used:  $\sigma = 0$  S/m,  $\epsilon_r = 1$ ;  $\rho = 0$  kg/m<sup>3</sup>

Ambient Temperature : 23.3 °C;

DASY5 Configuration:

- Probe: EF3DV3 - SN4050; ConvF(1, 1, 1); Calibrated: 2022.1.31
- Sensor-Surface: (Fix Surface)
- Electronics: DAE4 Sn1303; Calibrated: 2021.6.18
- Phantom: HAC Test Arch with AMCC; Type: SD HAC P01 BA;
- Measurement SW: DASY52, Version 52.10 (4); SEMCAD X Version 14.6.14 (7483)

**Ch42590/Hearing Aid Compatibility Test (101x101x1):** Interpolated grid: dx=0.5000 mm, dy=0.5000 mm

Device Reference Point: 0, 0, -6.3 mm

Reference Value = 68.73 V/m; Power Drift = -0.08 dB

Applied MIF = -1.44 dB

RF audio interference level = 30.85 dBV/m

MIF scaled E-field

Grid 1 <b>M4</b> <b>28.25 dBV/m</b>	Grid 2 <b>M3</b> <b>30.59 dBV/m</b>	Grid 3 <b>M3</b> <b>30.43 dBV/m</b>
Grid 4 <b>M4</b> <b>28.72 dBV/m</b>	Grid 5 <b>M3</b> <b>30.85 dBV/m</b>	Grid 6 <b>M3</b> <b>30.58 dBV/m</b>
Grid 7 <b>M3</b> <b>30.72 dBV/m</b>	Grid 8 <b>M3</b> <b>30.31 dBV/m</b>	Grid 9 <b>M4</b> <b>29.2 dBV/m</b>

Total = 30.85 dBV/m

E Category: M3

Location: -4, -3, 8.7 mm

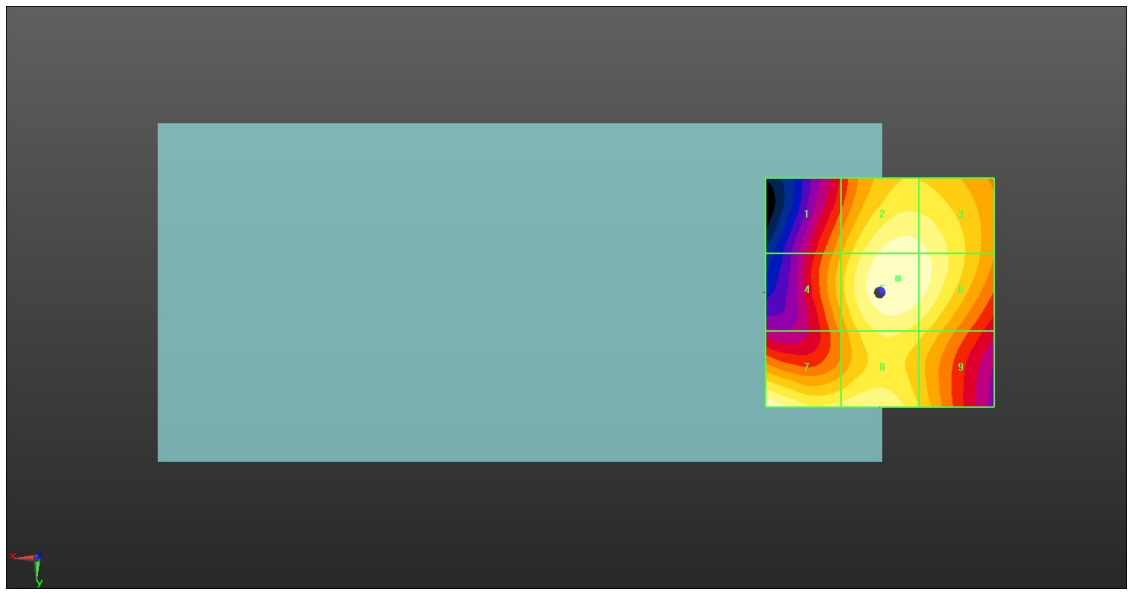
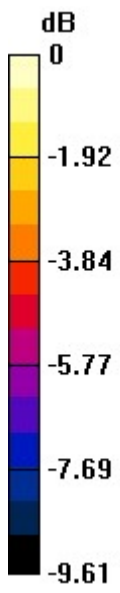

0 dB = 34.87 V/m = 30.85 dBV/m

**14\_HAC RF LTE B42\_20M\_QPSK\_1RB\_0Offset\_Ch42990**

Communication System: UID 10173 - CAG, LTE-TDD (SC-FDMA, 1 RB, 20 MHz, 16-QAM);  
 Frequency: 3540 MHz; Duty Cycle: 1:8.8736

Medium: Air Medium parameters used:  $\sigma = 0$  S/m,  $\epsilon_r = 1$ ;  $\rho = 0$  kg/m<sup>3</sup>

Ambient Temperature : 23.3 °C;

DASY5 Configuration:

- Probe: EF3DV3 - SN4050; ConvF(1, 1, 1); Calibrated: 2022.1.31
- Sensor-Surface: (Fix Surface)
- Electronics: DAE4 Sn1303; Calibrated: 2021.6.18
- Phantom: HAC Test Arch with AMCC; Type: SD HAC P01 BA;
- Measurement SW: DASY52, Version 52.10 (4); SEMCAD X Version 14.6.14 (7483)

**Ch42990/Hearing Aid Compatibility Test (101x101x1):** Interpolated grid: dx=0.5000 mm, dy=0.5000 mm

Device Reference Point: 0, 0, -6.3 mm

Reference Value = 70.88 V/m; Power Drift = -0.08 dB

Applied MIF = -1.44 dB

RF audio interference level = 31.34 dBV/m

MIF scaled E-field

<b>Grid 1 M4</b> <b>29.34 dBV/m</b>	<b>Grid 2 M3</b> <b>31.24 dBV/m</b>	<b>Grid 3 M3</b> <b>30.99 dBV/m</b>
<b>Grid 4 M4</b> <b>29.65 dBV/m</b>	<b>Grid 5 M3</b> <b>31.34 dBV/m</b>	<b>Grid 6 M3</b> <b>31.01 dBV/m</b>
<b>Grid 7 M3</b> <b>30.19 dBV/m</b>	<b>Grid 8 M4</b> <b>29.37 dBV/m</b>	<b>Grid 9 M4</b> <b>28.79 dBV/m</b>

Total = 31.34 dBV/m

E Category: M3

Location: -2, -5.5, 8.7 mm

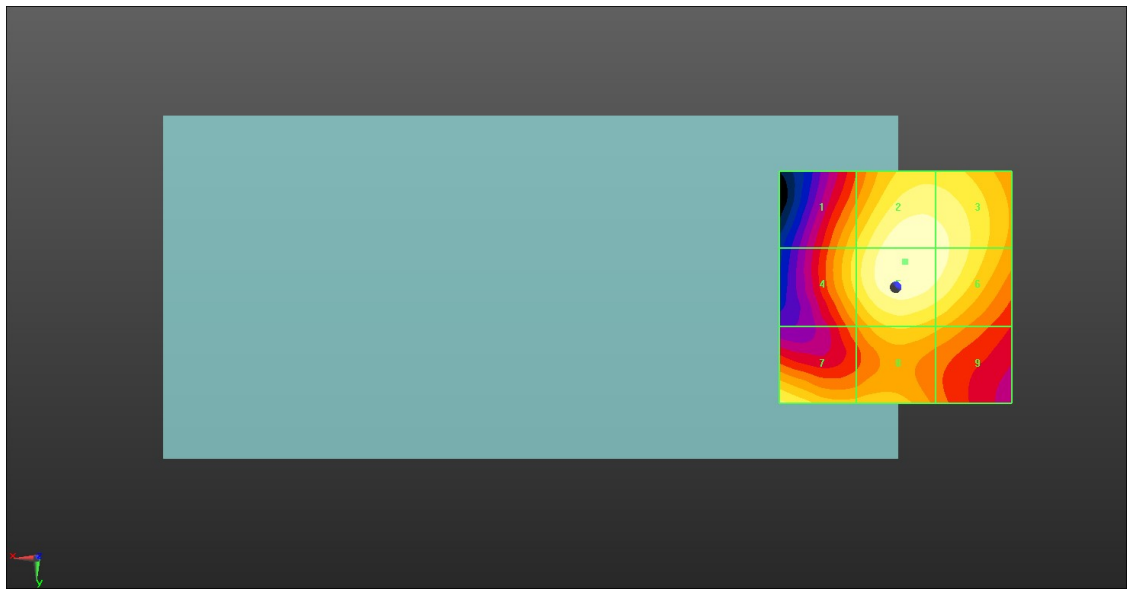
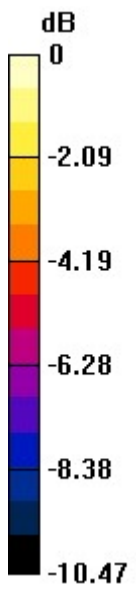

0 dB = 36.89 V/m = 31.34 dBV/m

**15\_HAC RF WLAN2.4GHz\_802.11g 6Mbps\_Ch1**

Communication System: UID 10077 - CAB, IEEE 802.11g WiFi 2.4 GHz (DSSS/OFDM, 54 Mbps);  
 Frequency: 2412 MHz; Duty Cycle: 1:12.5777

Medium: Air Medium parameters used:  $\sigma = 0 \text{ S/m}$ ,  $\epsilon_r = 1$ ;  $\rho = 0 \text{ kg/m}^3$

Ambient Temperature : 23.2 °C;

**DASY5 Configuration:**

- Probe: EF3DV3 - SN4050; ConvF(1, 1, 1); Calibrated: 2022.1.31
- Sensor-Surface: (Fix Surface)
- Electronics: DAE4 Sn1303; Calibrated: 2021.6.18
- Phantom: HAC Test Arch with AMCC; Type: SD HAC P01 BA;
- Measurement SW: DASY52, Version 52.10 (4); SEMCAD X Version 14.6.14 (7483)

**Ch1/Hearing Aid Compatibility Test (101x101x1):** Interpolated grid: dx=0.5000 mm, dy=0.5000 mm

Device Reference Point: 0, 0, -6.3 mm

Reference Value = 34.56 V/m; Power Drift = 0.02 dB

Applied MIF = 0.12 dB

RF audio interference level = 29.67 dBV/m

MIF scaled E-field

<b>Grid 1 M4</b> <b>24.97 dBV/m</b>	<b>Grid 2 M4</b> <b>26.32 dBV/m</b>	<b>Grid 3 M4</b> <b>26.1 dBV/m</b>
<b>Grid 4 M4</b> <b>27.73 dBV/m</b>	<b>Grid 5 M4</b> <b>28.37 dBV/m</b>	<b>Grid 6 M4</b> <b>28.12 dBV/m</b>
<b>Grid 7 M4</b> <b>29.53 dBV/m</b>	<b>Grid 8 M4</b> <b>29.67 dBV/m</b>	<b>Grid 9 M4</b> <b>28.7 dBV/m</b>

Total = 29.67 dBV/m

E Category: M4

Location: 5, 25, 8.7 mm



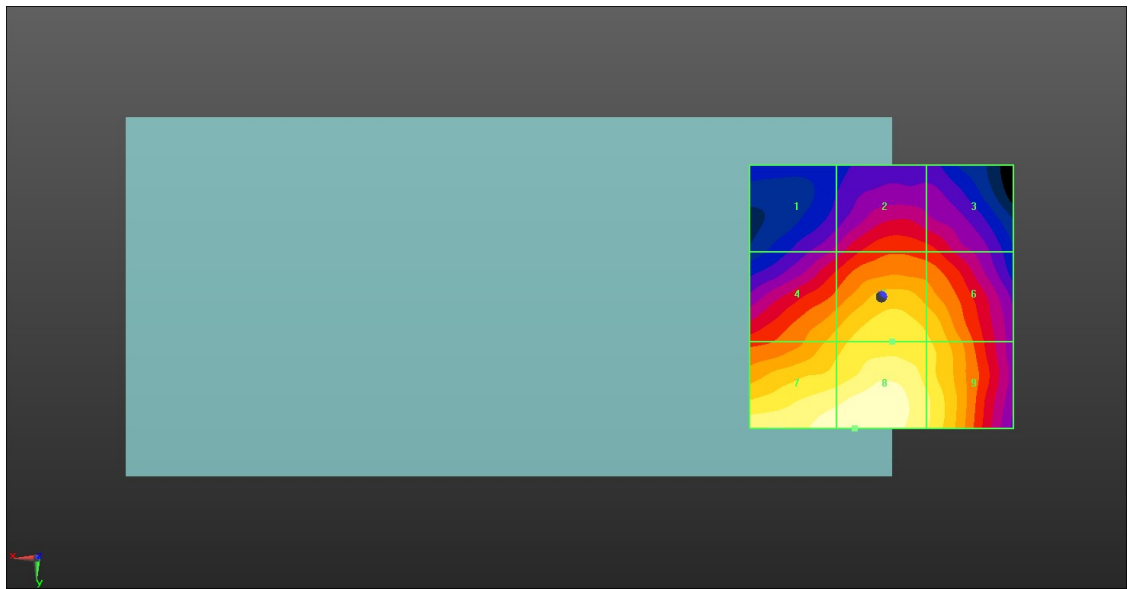
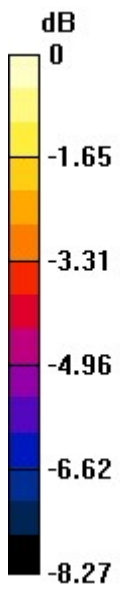

0 dB = 30.43 V/m = 29.67 dBV/m

**16\_HAC RF WLAN2.4GHz\_802.11g 6Mbps\_Ch6**

Communication System: UID 10077 - CAB, IEEE 802.11g WiFi 2.4 GHz (DSSS/OFDM, 54 Mbps);  
 Frequency: 2437 MHz;Duty Cycle: 1:12.5777

Medium: Air Medium parameters used:  $\sigma = 0 \text{ S/m}$ ,  $\epsilon_r = 1$ ;  $\rho = 0 \text{ kg/m}^3$

Ambient Temperature : 23.2 °C;

DASY5 Configuration:

- Probe: EF3DV3 - SN4050; ConvF(1, 1, 1); Calibrated: 2022.1.31
- Sensor-Surface: (Fix Surface)
- Electronics: DAE4 Sn1303; Calibrated: 2021.6.18
- Phantom: HAC Test Arch with AMCC; Type: SD HAC P01 BA;
- Measurement SW: DASY52, Version 52.10 (4); SEMCAD X Version 14.6.14 (7483)

**Ch6/Hearing Aid Compatibility Test (101x101x1):** Interpolated grid: dx=0.5000 mm,  
 dy=0.5000 mm

Device Reference Point: 0, 0, -6.3 mm

Reference Value = 37.48 V/m; Power Drift = -0.18 dB

Applied MIF = 0.12 dB

RF audio interference level = 30.13 dBV/m

MIF scaled E-field

<b>Grid 1 M4</b> <b>25.82 dBV/m</b>	<b>Grid 2 M4</b> <b>27.25 dBV/m</b>	<b>Grid 3 M4</b> <b>27.02 dBV/m</b>
<b>Grid 4 M4</b> <b>27.95 dBV/m</b>	<b>Grid 5 M4</b> <b>29.01 dBV/m</b>	<b>Grid 6 M4</b> <b>28.5 dBV/m</b>
<b>Grid 7 M4</b> <b>29.62 dBV/m</b>	<b>Grid 8 M3</b> <b>30.13 dBV/m</b>	<b>Grid 9 M4</b> <b>29.22 dBV/m</b>

Total = 30.13 dBV/m

E Category: M3

Location: 0.5, 25, 8.7 mm

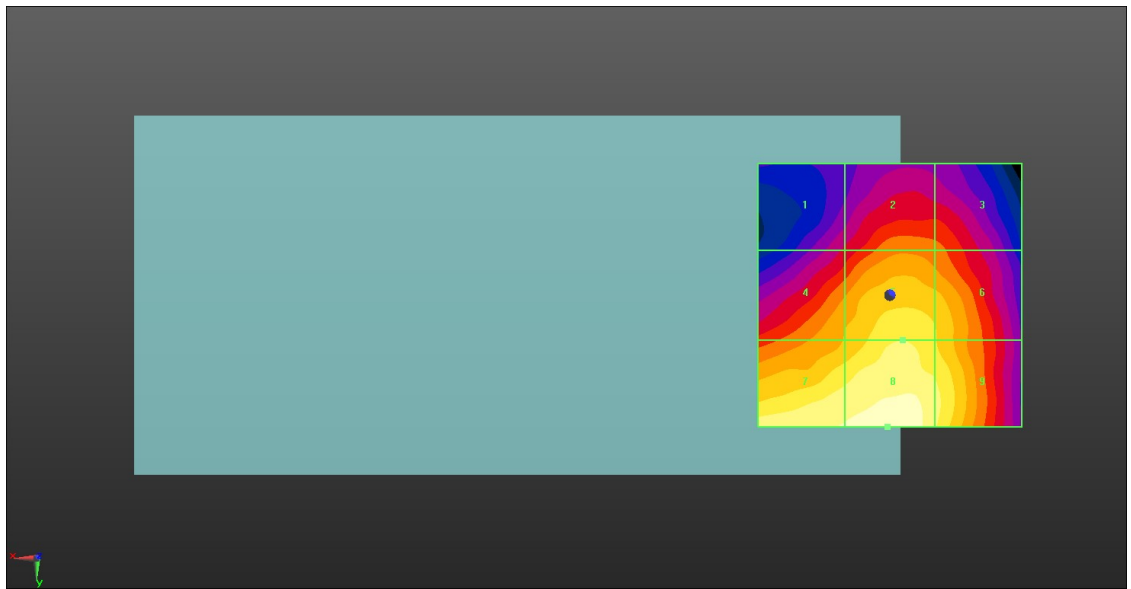
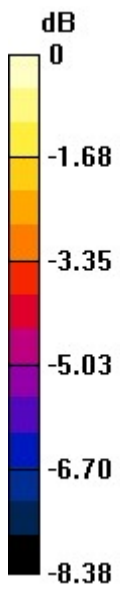

0 dB = 32.09 V/m = 30.13 dBV/m

**17\_HAC RF WLAN2.4GHz\_802.11g 6Mbps\_Ch11**

Communication System: UID 10077 - CAB, IEEE 802.11g WiFi 2.4 GHz (DSSS/OFDM, 54 Mbps);  
 Frequency: 2462 MHz;Duty Cycle: 1:12.5777

Medium: Air Medium parameters used:  $\sigma = 0$  S/m,  $\epsilon_r = 1$ ;  $\rho = 0$  kg/m<sup>3</sup>

Ambient Temperature : 23.2 °C;

DASY5 Configuration:

- Probe: EF3DV3 - SN4050; ConvF(1, 1, 1); Calibrated: 2022.1.31
- Sensor-Surface: (Fix Surface)
- Electronics: DAE4 Sn1303; Calibrated: 2021.6.18
- Phantom: HAC Test Arch with AMCC; Type: SD HAC P01 BA;
- Measurement SW: DASY52, Version 52.10 (4); SEMCAD X Version 14.6.14 (7483)

**Ch11/Hearing Aid Compatibility Test (101x101x1):** Interpolated grid: dx=0.5000 mm,  
 dy=0.5000 mm

Device Reference Point: 0, 0, -6.3 mm

Reference Value = 32.08 V/m; Power Drift = 0.03 dB

Applied MIF = 0.12 dB

RF audio interference level = 28.85 dBV/m

MIF scaled E-field

<b>Grid 1 M4</b> <b>24.24 dBV/m</b>	<b>Grid 2 M4</b> <b>25.76 dBV/m</b>	<b>Grid 3 M4</b> <b>25.44 dBV/m</b>
<b>Grid 4 M4</b> <b>26.95 dBV/m</b>	<b>Grid 5 M4</b> <b>27.87 dBV/m</b>	<b>Grid 6 M4</b> <b>27.54 dBV/m</b>
<b>Grid 7 M4</b> <b>28.52 dBV/m</b>	<b>Grid 8 M4</b> <b>28.85 dBV/m</b>	<b>Grid 9 M4</b> <b>28.19 dBV/m</b>

Total = 28.85 dBV/m

E Category: M4

Location: 0, 23, 8.7 mm

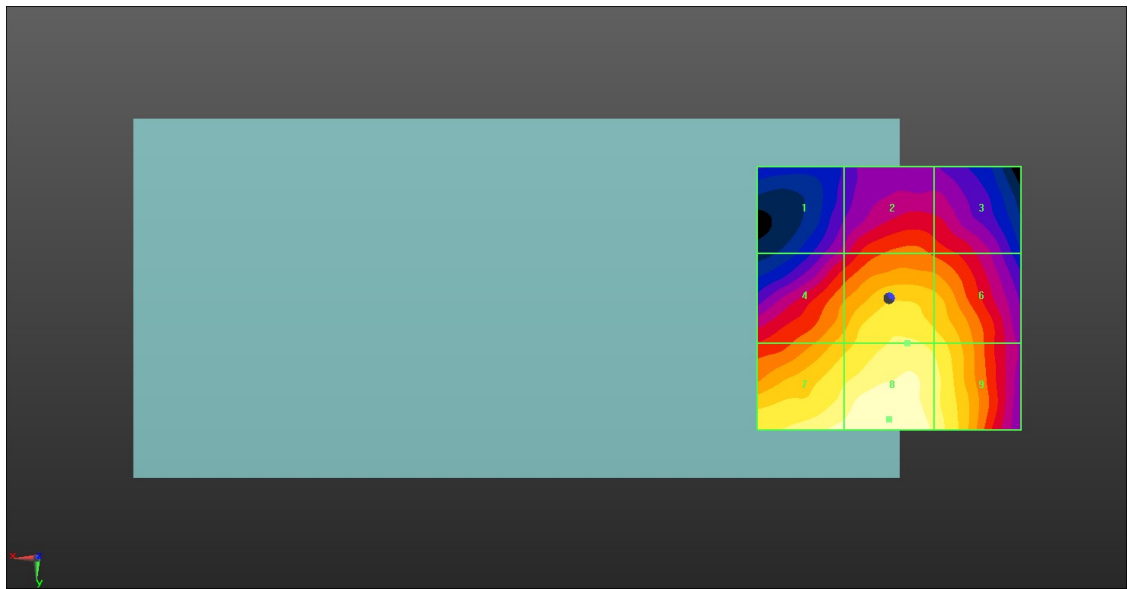
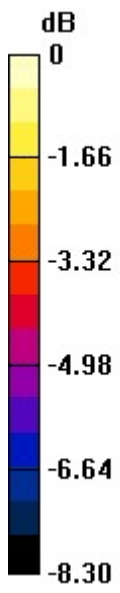

0 dB = 27.70 V/m = 28.85 dBV/m



---

**Appendix C. DASY Calibration Certificate**

The DASY calibration certificates are shown as follows.