

# FCC RF Test Report

APPLICANT : Motorola Mobility LLC  
EQUIPMENT : Mobile Cellular Phone  
BRAND NAME : Motorola  
MODEL NAME : XT2223-1  
FCC ID : IHDT56AE3  
STANDARD : 47 CFR Part 2, Part 27 Subpart Q  
CLASSIFICATION : PCS Licensed Transmitter Held to Ear (PCE)  
TEST DATE(S) : Mar. 14, 2022 ~ Apr. 03, 2022

We, Sporton International Inc. (Kunshan), would like to declare that the tested sample has been evaluated in accordance with the procedures given in ANSI C63.26-2015 and shown compliance with the applicable technical standards.

The test results in this report apply exclusively to the tested model / sample. Without written approval of Sporton International Inc. (Kunshan), the test report shall not be reproduced except in full.

Jason Jia

Reviewed by: Jason Jia / Supervisor

Alex Wang

Approved by: Alex Wang / Manager



**Sporton International Inc. (Kunshan)**

No. 1098, Pengxi North Road, Kunshan Economic Development Zone Jiangsu Province 215300  
People's Republic of China



TABLE OF CONTENTS

REVISION HISTORY..... 3
SUMMARY OF TEST RESULT ..... 4
1 GENERAL DESCRIPTION ..... 5
1.1 Applicant ..... 5
1.2 Manufacturer ..... 5
1.3 Product Feature of Equipment Under Test ..... 5
1.4 Product Specification of Equipment Under Test ..... 5
1.5 Specification of Accessory ..... 6
1.6 Modification of EUT ..... 7
1.7 Maximum EIRP Power and Emission Designator ..... 7
1.8 Testing Site ..... 7
1.9 Test Software ..... 8
1.10 Applied Standards ..... 8
2 TEST CONFIGURATION OF EQUIPMENT UNDER TEST ..... 9
2.1 Test Mode ..... 9
2.2 Connection Diagram of Test System ..... 10
2.3 Support Unit used in test configuration and system ..... 10
2.4 Measurement Results Explanation Example ..... 10
2.5 Frequency List of Low/Middle/High Channels ..... 11
3 CONDUCTED TEST ITEMS ..... 12
3.1 Measuring Instruments ..... 12
3.2 Test Setup ..... 12
3.3 Test Result of Conducted Test ..... 12
3.4 Conducted Output Power Measurement ..... 13
3.5 Peak-to-Average Ratio ..... 14
3.6 EIRP ..... 15
3.7 Occupied Bandwidth ..... 16
3.8 Conducted Band Edge Measurement ..... 17
3.9 Conducted Spurious Emission Measurement ..... 18
3.10 Frequency Stability Measurement ..... 19
4 RADIATED TEST ITEMS ..... 20
4.1 Measuring Instruments ..... 20
4.2 Test Setup ..... 20
4.3 Test Result of Radiated Test ..... 21
4.4 Radiated Spurious Emission Measurement ..... 22
5 LIST OF MEASURING EQUIPMENT ..... 23
6 UNCERTAINTY OF EVALUATION ..... 24
APPENDIX A. TEST RESULTS OF CONDUCTED TEST
APPENDIX B. TEST RESULTS OF RADIATED TEST
APPENDIX C. TEST SETUP PHOTOGRAPHS



### REVISION HISTORY

REPORT NO.	VERSION	DESCRIPTION	ISSUED DATE
FG230110G	Rev. 01	Initial issue of report	Apr. 12, 2022



### SUMMARY OF TEST RESULT

Report Section	FCC Rule	Description	Limit	Result	Remark
3.4	§2.1046	Conducted Output Power	—	Report Only	-
3.5	§27.50 (k)(4)	Peak-to-Average Ratio	<13dB	PASS	
3.6	§27.50 (k)(3)	EIRP	EIRP < 1W (30dBm)	PASS	-
3.7	§2.1049	Occupied Bandwidth	—	Report Only	-
3.8	§2.1051 §27.53 (n)(2)	Conducted Band Edge Measurement	-13dBm/MHz	PASS	-
3.9	§2.1051 §27.53 (n)(2)	Conducted Spurious Emission	-13dBm/MHz	PASS	-
3.10	§2.1055 §27.54	Frequency Stability Temperature & Voltage	Within the band	PASS	-
4.4	§2.1053 §27.53 (n)(2)	Radiated Spurious Emission	-13dBm/MHz	PASS	Under limit 36.47 dB at 10356.000 MHz

**Declaration of Conformity:**  
The test results with all measurement uncertainty excluded are presented in accordance with the regulation limits or requirements declared by manufacturers.

**Comments and Explanations:**  
The declared of product specification for EUT presented in the report are provided by the manufacturer, and the manufacturer takes all the responsibilities for the accuracy of product specification.



# 1 General Description

## 1.1 Applicant

**Motorola Mobility LLC**  
222 W, Merchandise Mart Plaza, Chicago IL 60654 USA

## 1.2 Manufacturer

**Motorola Mobility LLC**  
222 W, Merchandise Mart Plaza, Chicago IL 60654 USA

## 1.3 Product Feature of Equipment Under Test

Product Feature	
<b>Equipment</b>	Mobile Cellular Phone
<b>Brand Name</b>	Motorola
<b>Model Name</b>	XT2223-1
<b>FCC ID</b>	IHDT56AE3
<b>IMEI Code</b>	Conducted: 359131420065476/359131420065484 Radiation: 359131420066078/359131420066001
<b>HW Version</b>	DVT2
<b>SW Version</b>	S1SS32.38
<b>EUT Stage</b>	Identical Prototype

## 1.4 Product Specification of Equipment Under Test

Product Feature	
<b>Tx/Rx Frequency</b>	5G NR n77: 3450 MHz ~ 3550 MHz 5G NR n78: 3450 MHz ~ 3550 MHz
<b>Bandwidth</b>	20MHz / 30MHz / 40MHz / 50MHz / 60MHz / 70MHz / 80MHz / 90MHz / 100MHz
<b>SCS</b>	30kHz
<b>Maximum Output Power to Antenna</b>	<Ant. 5> 5G NR n77 : 23.48 dBm 5G NR n78 : 26.36 dBm
<b>Antenna Gain</b>	<Ant. 0>: n78: -4.00 dBi <Ant. 3>: n78: -0.70 dBi <Ant. 5>: n77: -4.50 dBi n78: -5.60 dBi <Ant. 8>: n78: -2.30 dBi
<b>Type of Modulation</b>	CP-OFDM: QPSK / 16QAM / 64QAM / 256QAM DFT-s-OFDM: PI/2 BPSK / QPSK / 16QAM / 64QAM / 256QAM

**Remark:**

1. 5G NR n78 supports SA and NSA mode, n77 supports NSA mode only. According to the maximum power between SA and NSA mode, SA covers NSA mode and 5G NR n78 covers n77.
2. The maximum EIRP is calculated from max output power and max antenna gain, only the maximum EIRP is shown in the report, 5G NR n78 for Antenna 3.
3. For NSA mode of all EN-DC combination, we only show the combination of the maximum power among all NSA combinations in the report.
4. 5G NR n78 supports HPUE mode.
5. The EN-DC mode combination could be referred to the product spec.
6. The device supports n78(1T4R) SRS resources on Ant.0/3/5/8, only the test data of worst Ant.5 is showed in the report according to the maximum power.

### 1.5 Specification of Accessory

Specification of Accessory				
AC Adapter 1(US)	Brand Name	Motorola(Salcomp)	Model Name	MC-101
AC Adapter 1(EU)	Brand Name	Motorola(Salcomp)	Model Name	MC-102
AC Adapter 1(UK)	Brand Name	Motorola(Salcomp)	Model Name	MC-103
AC Adapter 1(AU)	Brand Name	Motorola(Salcomp)	Model Name	MC-105
AC Adapter 1(AR)	Brand Name	Motorola(Salcomp)	Model Name	MC-106
AC Adapter 1(CHILE)	Brand Name	Motorola(Salcomp)	Model Name	MC-109
AC Adapter 2(US)	Brand Name	Motorola(Aohai)	Model Name	MC-101
AC Adapter 2(EU)	Brand Name	Motorola(Aohai)	Model Name	MC-102
AC Adapter 2(UK)	Brand Name	Motorola(Aohai)	Model Name	MC-103
AC Adapter 2(AU)	Brand Name	Motorola(Aohai)	Model Name	MC-105
AC Adapter 2(AR)	Brand Name	Motorola(Aohai)	Model Name	MC-106
AC Adapter 3(US)	Brand Name	Motorola(Chenyang)	Model Name	MC-101
AC Adapter 3(EU)	Brand Name	Motorola(Chenyang)	Model Name	MC-102
AC Adapter 3(UK)	Brand Name	Motorola(Chenyang)	Model Name	MC-103
AC Adapter 3(AU)	Brand Name	Motorola(Chenyang)	Model Name	MC-105
AC Adapter 3(AR)	Brand Name	Motorola(Chenyang)	Model Name	MC-106
AC Adapter 4(US)	Brand Name	Motorola(Chenyang)	Model Name	MC-201
AC Adapter 4(IN)	Brand Name	Motorola(Chenyang)	Model Name	MC-204
AC Adapter 5(US)	Brand Name	Motorola(Acbel)	Model Name	MC-201
AC Adapter 6(IN)	Brand Name	Motorola(Aohai)	Model Name	MC-204
AC Adapter 7(BR)	Brand Name	Motorola(Salcomp)	Model Name	MC-207
AC Adapter 8(BR)	Brand Name	Motorola(Flex)	Model Name	MC-207
Battery	Brand Name	Motorola(ATL)	Model Name	ND50
Earphone 1	Brand Name	Motorola(NLD)	Model Name	MH202
Earphone 2	Brand Name	Motorola(NLD)	Model Name	MI191
Earphone 3	Brand Name	Motorola(Lyand)	Model Name	MI191
Earphone 4	Brand Name	Motorola(LCHSE)	Model Name	MI191
USB Cable 1	Brand Name	Motorola(HX)	Model Name	S928D43190
USB Cable 2	Brand Name	Motorola(NAEE)	Model Name	S928D43191

## 1.6 Modification of EUT

No modifications are made to the EUT during all test items.

## 1.7 Maximum EIRP Power and Emission Designator

5G NR n77 NSA (EN DC 41A-n77A)		PI/2 BPSK / QPSK		16QAM / 64QAM / 256QAM	
BW (MHz)	Frequency Range (MHz)	Maximum EIRP(W)	Emission Designator (99%OBW)	Maximum EIRP(W)	Emission Designator (99%OBW)
100	3500.01 ~ 3500.01	0.0791	97M1G7D	0.0566	97M3W7D

5G NR n78		PI/2 BPSK / QPSK		16QAM / 64QAM / 256QAM	
BW (MHz)	Frequency Range (MHz)	Maximum EIRP(W)	Emission Designator (99%OBW)	Maximum EIRP(W)	Emission Designator (99%OBW)
100	3500.01 ~ 3500.01	0.3357	97M1G7D	0.2679	97M3W7D

**Note:**

1. All modulations have been tested, only the maximum bandwidth and the worst modulation test results are shown in the report.
2. 5G NR Band n78 overlaps the entire frequency range of Band n77. Therefore, the test results of conducted test items provided in this report covers Band n78 as well as Band n77.

## 1.8 Testing Site

Sporton International Inc. (Kunshan) is accredited to ISO/IEC 17025:2017 by American Association for Laboratory Accreditation with Certificate Number 5145.02.

<b>Test Firm</b>	Sporton International Inc. (Kunshan)		
<b>Test Site Location</b>	No. 1098, Pengxi North Road, Kunshan Economic Development Zone Jiangsu Province 215300 People's Republic of China TEL : +86-512-57900158 FAX : +86-512-57900958		
<b>Test Site No.</b>	<b>Sporton Site No.</b>	<b>FCC Designation No.</b>	<b>FCC Test Firm Registration No.</b>
	03CH04-KS TH01-KS	CN1257	314309

## 1.9 Test Software

Item	Site	Manufacturer	Name	Version
1.	03CH04-KS	AUDIX	E3	6.2009-8-24a

## 1.10 Applied Standards

According to the specifications of the manufacturer, the EUT must comply with the requirements of the following standards:

- ♦ 47 CFR Part 2, Part 27 Subpart Q
- ♦ ANSI C63.26-2015
- ♦ FCC KDB 971168 Power Meas License Digital Systems D01 v03r01
- ♦ FCC KDB 412172 D01 Determining ERP and EIRP v01r01
- ♦

### Remark:

1. All test items were verified and recorded according to the standards and without any deviation during the test.
2. This EUT has also been tested and complied with the requirements of FCC Part 15, Subpart B, recorded in a separate test report.



## 2 Test Configuration of Equipment Under Test

### 2.1 Test Mode

Antenna port conducted and radiated test items listed below are performed according to KDB 971168 D01 Power Meas. License Digital Systems v03r01 with maximum output power.

Radiated measurements are performed by rotating the EUT in three different orthogonal test planes to find the maximum emission. (Y-Plane)

Test Cases	Band	Bandwidth (MHz)	Modulation	RB #	Test Channel
		eg. 5M, 10M, 15M, 20M	eg. QPSK, 16QAM, 64QAM	1RB, Partial RB, Full RB	L/M/H
Max. Output Power	5G n77	20M, 30M, 40M, 50M, 60M, 70M, 80M, 90M, 100M	PI/2 BPSK, QPSK, 16QAM, 64QAM, 256QAM	1RB, Partial RB, Full RB	L, M, H
	5G n78	20M, 30M, 40M, 50M, 60M, 70M, 80M, 90M, 100M	PI/2 BPSK, QPSK, 16QAM, 64QAM, 256QAM	1RB, Partial RB, Full RB	L, M, H
Peak-to-Average Ratio	5G n78	100M	PI/2 BPSK, QPSK, 16QAM, 64QAM, 256QAM	Full RB	M
E.I.R.P	5G n77	20M, 30M, 40M, 50M, 60M, 70M, 80M, 90M, 100M	PI/2 BPSK, QPSK, 16QAM, 64QAM, 256QAM	1RB, Partial RB, Full RB	L, M, H
	5G n78	20M, 30M, 40M, 50M, 60M, 70M, 80M, 90M, 100M	PI/2 BPSK, QPSK, 16QAM, 64QAM, 256QAM	1RB, Partial RB, Full RB	L, M, H
26dB and 99% Bandwidth	5G n78	100M	QPSK, 16QAM	Full RB	M
Conducted Band Edge	5G n78	20M, 30M, 40M, 50M, 60M, 70M, 80M, 90M, 100M	PI/2 BPSK, QPSK, 16QAM, 64QAM, 256QAM	1RB, Full RB	L, H
Conducted Spurious Emission	5G n78	20M, 30M, 40M, 50M, 60M, 70M, 80M, 90M, 100M	QPSK	1RB	L, M, H
Frequency Stability	5G n78	20M	QPSK	1RB	M
Radiated Spurious Emission	5G n77	Worst case from maximum power			M
	5G n78	Worst case from maximum power			M

**Note:** The device is investigated from 30MHz to 10 times of fundamental signal for radiated spurious emission test under different RB size/offset and modulations in exploratory test. Subsequently, only the worst case emissions are reported.

## 2.2 Connection Diagram of Test System

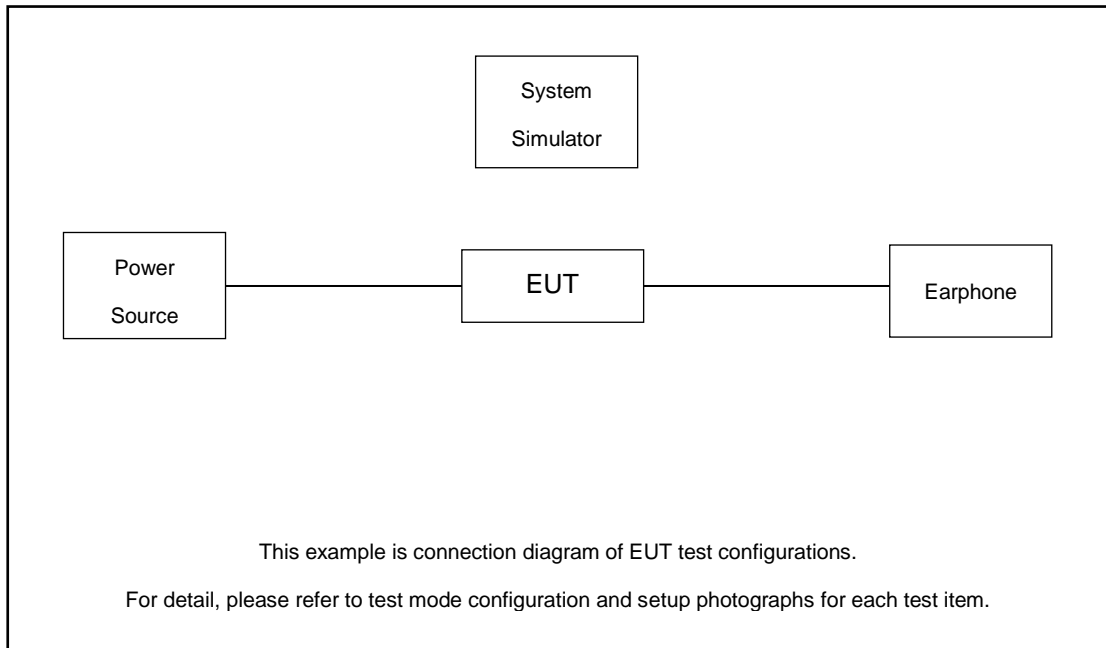

## 2.3 Support Unit used in test configuration and system

Item	Equipment	Trade Name	Model No.	FCC ID	Data Cable	Power Cord
1.	DC Power Supply	GW	GPS-3030D	N/A	N/A	Unshielded, 1.8 m
2.	LTE Base Station	Anritsu	MT8821C	N/A	N/A	Unshielded, 1.8 m
3.	NR Base Station	Anritsu	MT8000A	N/A	N/A	Unshielded, 1.8 m

## 2.4 Measurement Results Explanation Example

### For all conducted test items:

The offset level is set in the spectrum analyzer to compensate the RF cable loss and attenuator factor between EUT conducted output port and spectrum analyzer. With the offset compensation, the spectrum analyzer reading level is exactly the EUT RF output level.

The spectrum analyzer offset is derived from RF cable loss and attenuator factor.

*Offset = RF cable loss + attenuator factor.*

Following shows an offset computation example with cable loss 3.49 dB and 10dB attenuator.

Example :

$$\begin{aligned} \text{Offset(dB)} &= \text{RF cable loss(dB)} + \text{attenuator factor(dB)} \\ &= 3.49 + 10 = 13.49 \text{ (dB)} \end{aligned}$$

## 2.5 Frequency List of Low/Middle/High Channels

5G n77/n78 Channel and Frequency List for SCS 30kHz				
BW [MHz]	Channel/Frequency(MHz)	Lowest	Middle	Highest
100	Channel	-	633334	-
	Frequency	-	3500.01	-
90	Channel	633000	633334	633666
	Frequency	3495	3500.01	3504.99
80	Channel	632668	633334	634000
	Frequency	3490.02	3500.01	3510
70	Channel	632334	633334	634332
	Frequency	3485.01	3500.01	3514.98
60	Channel	632000	633334	634666
	Frequency	3480	3500.01	3519.99
50	Channel	631668	633334	635000
	Frequency	3475.02	3500.01	3525
40	Channel	631334	633334	635332
	Frequency	3470.01	3500.01	3529.98
30	Channel	631000	633334	635666
	Frequency	3465	3500.01	3534.99
20	Channel	630668	633334	636000
	Frequency	3460.02	3500.01	3540

### 3 Conducted Test Items

#### 3.1 Measuring Instruments

See list of measuring instruments of this test report.

#### 3.2 Test Setup

##### 3.2.1 Conducted Output Power

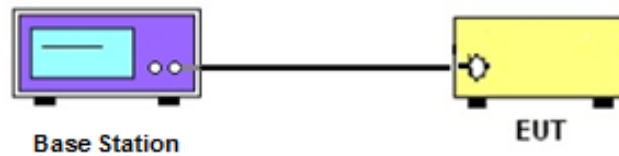

##### 3.2.2 Peak-to-Average Ratio, Occupied / 26dB Bandwidth, Band-Edge and Conducted Spurious Emission

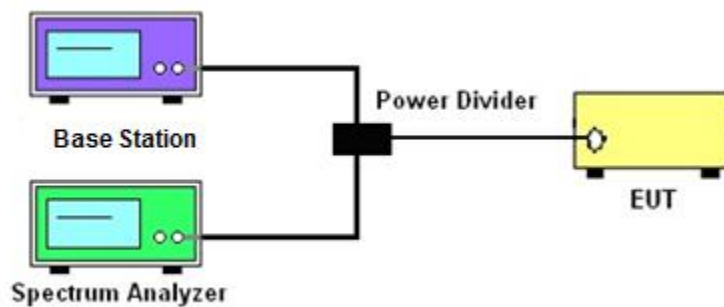

##### 3.2.3 Frequency Stability

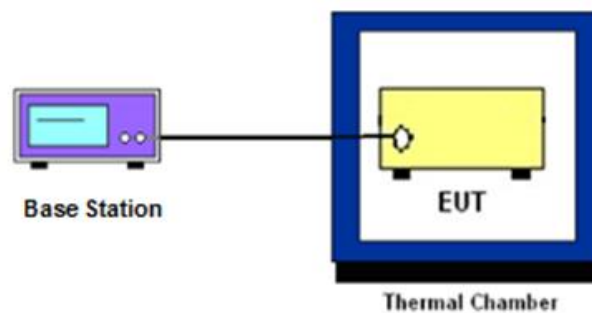

### 3.3 Test Result of Conducted Test

Please refer to Appendix A.



## 3.4 Conducted Output Power Measurement

### 3.4.1 Description of the Conducted Output Power Measurement

A base station simulator was used to establish communication with the EUT. Its parameters were set to transmit the maximum power on the EUT. The measured power in the radio frequency on the transmitter output terminals shall be reported.

### 3.4.2 Test Procedures

1. The testing follows ANSI C63.26 Section 5.2
2. The transmitter output port was connected to the system simulator.
3. Set EUT at maximum power through the system simulator.
4. Select lowest, middle, and highest channels for each band and different modulation.
5. Measure and record the power level from the system simulator.

## 3.5 Peak-to-Average Ratio

### 3.5.1 Description of the PAR Measurement

Power Complementary Cumulative Distribution Function (CCDF) curves provide a means for characterizing the power peaks of a digitally modulated signal on a statistical basis. A CCDF curve depicts the probability of the peak signal amplitude exceeding the average power level. Most contemporary measurement instrumentation include the capability to produce CCDF curves for an input signal provided that the instrument's resolution bandwidth can be set wide enough to accommodate the entire input signal bandwidth. In measuring transmissions in this band using an average power technique, the peak-to-average ratio (PAR) of the transmission may not exceed 13 dB.

### 3.5.2 Test Procedures

1. The testing follows ANSI C63.26 Section 5.2.6 (PAPR).
2. The EUT was connected to spectrum and system simulator via a power divider.
3. Set EUT in maximum power output.
4. Set the RBW = 1MHz, VBW = 3MHz, Detector = Peak, Trace mode = max hold, Set span  $\geq 2 \times$  OBW in spectrum analyzer.
5. Set the RBW = 1MHz, VBW = 3MHz, Detector = power averaging, Trace mode = max hold, Set span  $\geq 2 \times$  OBW in spectrum analyzer.
6. Add  $[10 \log (1/\text{duty cycle})]$  to the measured maximum power level to compute the average power during continuous transmission.
7.  $\text{PAPR (dB)} = P_{\text{Pk}} \text{ (dBm)} - P_{\text{Avg}} \text{ (dBm)}$   
where  
PAPR peak-to-average power ratio, in dB  
 $P_{\text{Pk}}$  measured peak power level, in dBm  
 $P_{\text{Avg}}$  measured average power level, in dBm
8. Record the deviation as Peak to Average Ratio.

## 3.6 EIRP

### 3.6.1 Description of EIRP Limit

#### § 27.50 (k)(3)

Mobile devices are limited to 1Watt (30 dBm) EIRP. Mobile devices operating in these bands must employ a means for limiting power to the minimum necessary for successful communications

### 3.6.2 Test Procedures

1. According to KDB 412172 D01 Power Approach,
2.  $EIRP = P_T + G_T - L_C$ ,  $ERP = EIRP - 2.15$ , where  
 $P_T$  = transmitter output power in dBm  
 $G_T$  = gain of the transmitting antenna in dBi  
 $L_C$  = signal attenuation in the connecting cable between the transmitter and antenna in dB

## 3.7 Occupied Bandwidth

### 3.7.1 Description of Occupied Bandwidth Measurement

The occupied bandwidth is the width of a frequency band such that, below the lower and above the upper frequency limits, the mean powers emitted are each equal to a specified percentage 0.5% of the total mean transmitted power.

The 26 dB emission bandwidth is defined as the frequency range between two points, one above and one below the carrier frequency, at which the spectral density of the emission is attenuated 26 dB below the maximum in-band spectral density of the modulated signal. Spectral density (power per unit bandwidth) is to be measured with a detector of resolution bandwidth equal to approximately 1.0% of the emission bandwidth.

### 3.7.2 Test Procedures

1. The testing follows ANSI C63.26 Section 5.4
2. The EUT was connected to spectrum analyzer and system simulator via a power divider.
3. The spectrum analyzer center frequency is set to the nominal EUT channel center frequency. The span range for the spectrum analyzer shall be between two and five times the anticipated OBW.
4. The nominal resolution bandwidth (RBW) shall be in the range of 1 to 5 % of the anticipated OBW, and the VBW shall be at least 3 times the RBW.
5. Set the detection mode to peak, and the trace mode to max hold.
6. Determine the reference value: Set the EUT to transmit a modulated signal. Allow the trace to stabilize. Set the spectrum analyzer marker to the highest level of the displayed trace.  
(this is the reference value)
7. Determine the “-26 dB down amplitude” as equal to (Reference Value – X).
8. Place two markers, one at the lowest and the other at the highest frequency of the envelope of the spectral display such that each marker is at or slightly below the “-X dB down amplitude” determined in step 6. If a marker is below this “-X dB down amplitude” value it shall be placed as close as possible to this value. The OBW is the positive frequency difference between the two markers.
9. Use the 99 % power bandwidth function of the spectrum analyzer and report the measured bandwidth.



## 3.8 Conducted Band Edge Measurement

### 3.8.1 Description of Conducted Band Edge Measurement

#### § 27.53 (n)(2)

For mobile operations in the 3450-3550 MHz band, the conducted power of any emission outside the licensee's authorized bandwidth shall not exceed  $-13$  dBm/MHz.

Compliance with this paragraph is based on the use of measurement instrumentation employing a resolution bandwidth of 1 megahertz or greater. However, in the 1 megahertz bands immediately outside and adjacent to the licensee's frequency block, a resolution bandwidth of at least one percent of the emission bandwidth of the fundamental emission of the transmitter may be employed, but limited to a maximum of 200 kHz. In the bands between 1 and 5 MHz removed from the licensee's frequency block, the minimum resolution bandwidth for the measurement shall be 500 kHz.

### 3.8.2 Test Procedures

1. The testing follows ANSI C63.26 section 5.7
2. The EUT was connected to spectrum analyzer and system simulator via a power divider.
3. The band edges of low and high channels for the highest RF powers were measured.
4. Set RBW  $\geq$  1% EBW but limited to a maximum of 200 kHz in the 1MHz band immediately outside and adjacent to the band edge.
5. Beyond the 1 MHz and 5 MHz removed from the band edge, set RBW  $\geq$  500KHz.
6. Beyond the 5 MHz removed from the band edge, set RBW = 1MHz.
7. Set spectrum analyzer with RMS detector.
8. The RF fundamental frequency should be excluded against the limit line in the operating frequency band.
9. Checked that all the results comply with the emission limit line.

## 3.9 Conducted Spurious Emission Measurement

### 3.9.1 Description of Conducted Spurious Emission Measurement

The power of any emission outside of the authorized operating frequency ranges shall not exceed -13 dBm/MHz.

It is measured by means of a calibrated spectrum analyzer and scanned from 30MHz up to a frequency including its 10<sup>th</sup> harmonic.

### 3.9.2 Test Procedures

1. The testing follows ANSI C63.26 section 5.7
2. The EUT was connected to spectrum analyzer and system simulator via a power divider.
3. The RF output of EUT was connected to the spectrum analyzer by RF cable and attenuator. The path loss was compensated to the results for each measurement.
4. The middle channel for the highest RF power within the transmitting frequency was measured.
5. The conducted spurious emission for the whole frequency range was taken.
6. Make the measurement with the spectrum analyzer's RBW = 1MHz, VBW = 3MHz.
7. Set spectrum analyzer with RMS detector.
8. Taking the record of maximum spurious emission.
9. The RF fundamental frequency should be excluded against the limit line in the operating frequency band.
10. Checked that all the results comply with the emission limit line.

## 3.10 Frequency Stability Measurement

### 3.10.1 Description of Frequency Stability Measurement

The frequency stability shall be measured by variation of ambient temperature and variation of primary supply voltage to ensure that the fundamental emission stays within the authorized frequency block.

### 3.10.2 Test Procedures for Temperature Variation

1. The testing follows ANSI C63.26 section 5.6.4
2. The EUT was set up in the thermal chamber and connected with the system simulator.
3. With power OFF, the temperature was decreased to  $-30^{\circ}\text{C}$  and the EUT was stabilized before testing. Power was applied and the maximum change in frequency was recorded within one minute.
4. With power OFF, the temperature was raised in  $10^{\circ}\text{C}$  step up to  $50^{\circ}\text{C}$ . The EUT was stabilized at each step for at least half an hour. Power was applied and the maximum frequency change was recorded within one minute.

### 3.10.3 Test Procedures for Voltage Variation

1. The testing follows ANSI C63.26 section 5.6.5.
2. The EUT was placed in a temperature chamber at  $20\pm 5^{\circ}\text{C}$  and connected with the system simulator.
3. The power supply voltage to the EUT was varied from 85% to 115% of the nominal value for other than hand carried battery equipment.
4. For hand carried, battery powered equipment, reduce the primary ac or dc supply voltage to the battery operating end point, which shall be specified by the manufacturer.
5. The variation in frequency was measured for the worst case.

## 4 Radiated Test Items

### 4.1 Measuring Instruments

See list of measuring instruments of this test report.

### 4.2 Test Setup

#### 4.2.1 For radiated test below 30MHz

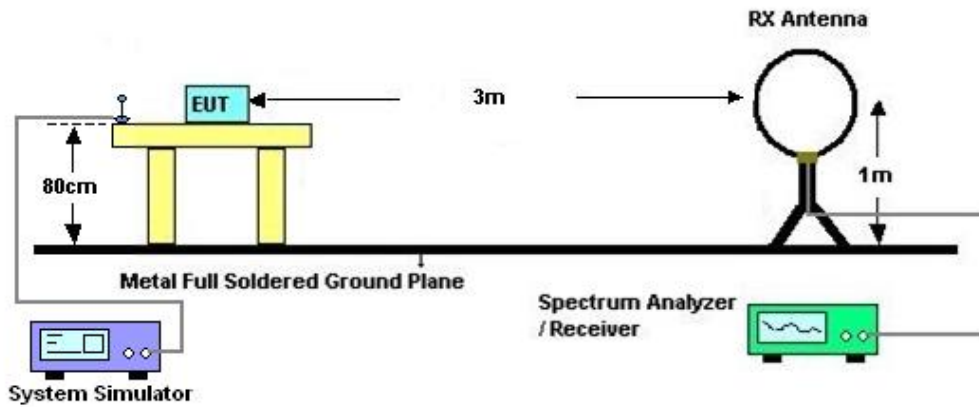

#### 4.2.2 For radiated test from 30MHz to 1GHz

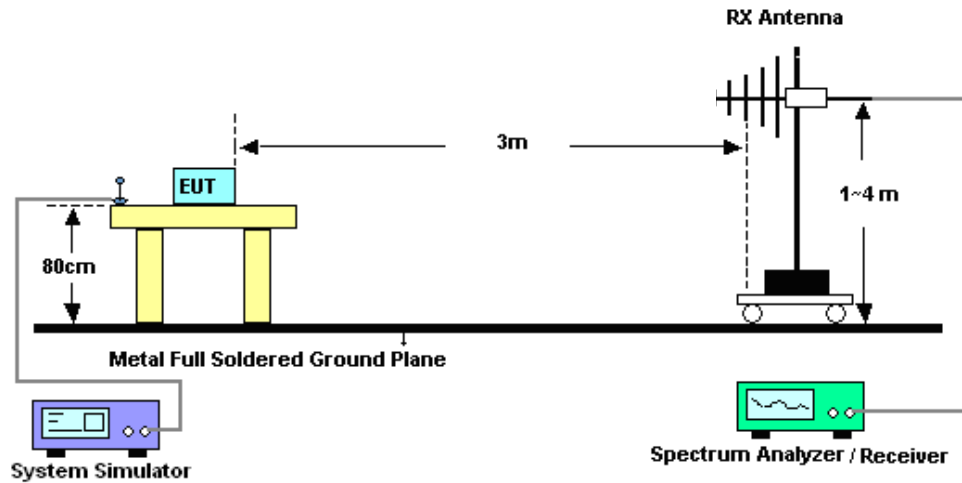

### 4.2.3 For radiated test above 1GHz



### 4.3 Test Result of Radiated Test

The low frequency, which started from 9 kHz to 30MHz, was pre-scanned and the result which was 20dB lower than the limit line was not reported.

Please refer to Appendix B.

## 4.4 Radiated Spurious Emission Measurement

### 4.4.1 Description of Radiated Spurious Emission

The radiated spurious emission was measured by substitution method according to ANSI/TIA-603-E. The power of any emission outside of the authorized operating frequency ranges shall not exceed -13 dBm/MHz.

The spectrum is scanned from 30 MHz up to a frequency including its 10th harmonic.

### 4.4.2 Test Procedures

1. The testing follows ANSI C63.26 Section 5.5
2. The EUT was placed on a turntable with 0.8 meter height for frequency below 1GHz and 1.5 meter height for frequency above 1GHz respectively above ground.
3. The EUT was set 3 meters from the receiving antenna mounted on the antenna tower.
4. The table was rotated 360 degrees to determine the position of the highest spurious emission.
5. The height of the receiving antenna is varied between 1m to 4m to search the maximum spurious emission for both horizontal and vertical polarizations.
6. During the measurement, the system simulator parameters were set to force the EUT transmitting at maximum output power.
7. Make the measurement with the spectrum analyzer's RBW = 1MHz, VBW = 3MHz, taking the record of maximum spurious emission.
8. A horn antenna was substituted in place of the EUT and was driven by a signal generator.
9. Tune the output power of signal generator to the same emission level with EUT maximum spurious emission.  
$$\text{EIRP (dBm)} = \text{S.G. Power} - \text{Tx Cable Loss} + \text{Tx Antenna Gain}$$
$$\text{ERP (dBm)} = \text{EIRP} - 2.15$$
10. The RF fundamental frequency should be excluded against the limit line in the operating frequency band.



## 5 List of Measuring Equipment

Instrument	Manufacturer	Model No.	Serial No.	Characteristics	Calibration Date	Test Date	Due Date	Remark
Spectrum Analyzer	R&S	FSV40	101040	10Hz~40GHz	Oct. 14, 2021	Mar. 14, 2022~ Apr. 03, 2022	Oct. 13, 2022	Conducted (TH01-KS)
Power divider	STI	STI08-0055	-	0.5~40GHz	Aug. 26, 2021	Mar. 14, 2022~ Apr. 03, 2022	Aug. 25, 2022	Conducted (TH01-KS)
Temperature & humidity chamber	Hongzhan	LP-150U	H2014011440	-40~+150°C 20%~95%RH	Jul. 12, 2021	Mar. 14, 2022~ Apr. 03, 2022	Jul. 11, 2022	Conducted (TH01-KS)
EXA Spectrum Analyzer	Keysight	N9010A	MY55150244	10Hz-44G,MAX 30dB	Apr. 13, 2021	Mar. 25, 2022	Apr. 12, 2022	Radiation (03CH04-KS)
Loop Antenna	R&S	HFH2-Z2	100321	9kHz~30MHz	Oct. 30, 2021	Mar. 25, 2022	Oct. 29, 2022	Radiation (03CH04-KS)
Bilog Antenna	TeseQ	CBL6111D	49922	30MHz-1GHz	May 30, 2021	Mar. 25, 2022	May 29, 2022	Radiation (03CH04-KS)
Double Ridge Horn Antenna	ETS-Lindgren	3117	00218652	1GHz~18GHz	Apr. 25, 2021	Mar. 25, 2022	Apr. 24, 2022	Radiation (03CH04-KS)
SHF-EHF Horn	Com-power	AH-840	101115	18GHz~40GHz	Jan. 05, 2022	Mar. 25, 2022	Jan. 04, 2023	Radiation (03CH04-KS)
Amplifier	SONOMA	310N	187289	9KHz-1GHz	Jan. 05, 2022	Mar. 25, 2022	Jan. 04, 2023	Radiation (03CH04-KS)
Amplifier	MITEQ	EM18G40G GA	060728	18~40GHz	Jan. 05, 2022	Mar. 25, 2022	Jan. 04, 2023	Radiation (03CH04-KS)
high gain Amplifier	MITEQ	AMF-7D-00 101800-30-1 0P	2025788	1Ghz-18Ghz	Jan. 05, 2022	Mar. 25, 2022	Jan. 04, 2023	Radiation (03CH04-KS)
Amplifier	Keysight	83017A	MY57280106	500MHz~26.5GHz	Oct. 13, 2021	Mar. 25, 2022	Oct. 12, 2022	Radiation (03CH04-KS)
AC Power Source	Chroma	61601	F104090004	N/A	NCR	Mar. 25, 2022	NCR	Radiation (03CH04-KS)
Turn Table	ChamPro	EM 1000-T	060762-T	0~360 degree	NCR	Mar. 25, 2022	NCR	Radiation (03CH04-KS)
Antenna Mast	ChamPro	EM 1000-A	060762-A	1 m~4 m	NCR	Mar. 25, 2022	NCR	Radiation (03CH04-KS)

NCR: No Calibration Required

## 6 Uncertainty of Evaluation

The measurement uncertainties shown below were calculated in accordance with the requirements of ANSI 63.26-2015. All the measurement uncertainty value were shown with a coverage K=2 to indicate 95% level of confidence. The measurement data show herein meets or exceeds the CISPR measurement uncertainty values specified in CISPR 16-4-2 and can be compared directly to specified limit to determine compliance.

### Uncertainty of Conducted Measurement

Test Item	Uncertainty
Conducted Power	±0.56 dB
Conducted Emissions	±0.92 dB
Occupied Channel Bandwidth	±0.03 %

### Uncertainty of Radiated Emission Measurement (30 MHz ~ 1000 MHz)

Measuring Uncertainty for a Level of Confidence of 95% (U = 2Uc(y))	3.3dB
---	-------

### Uncertainty of Radiated Emission Measurement (1 GHz ~ 40 GHz)

Measuring Uncertainty for a Level of Confidence of 95% (U = 2Uc(y))	2.8dB
---	-------

----- THE END -----





## Appendix A. Test Results of Conducted Test

Test Engineer :	Lex Wu	Temperature :	22~23°C
		Relative Humidity :	40~42%

### Conducted Output Power(Average power) and EIRP

5G NR n77:

BW [MHz]	Modulation	RB Size	RB Offset	Power Low Ch. / Freq.	Power Middle Ch. / Freq.	Power High Ch. / Freq.	Gain	EIRP		
									M	
Channel					633334					
Frequency (MHz)					3500.01					
100	PI/2 BPSK	1	1		23.48		-4.50		0.0791	
100	PI/2 BPSK	1	137		22.82		-4.50		0.0679	
100	PI/2 BPSK	1	271		23.13		-4.50		0.0729	
100	PI/2 BPSK	135	0		22.53		-4.50		0.0635	
100	PI/2 BPSK	135	67		22.83		-4.50		0.0681	
100	PI/2 BPSK	135	138		22.41		-4.50		0.0618	
100	PI/2 BPSK	270	0		22.56		-4.50		0.0640	
100	QPSK	1	1		22.95		-4.50		0.0700	
100	QPSK	1	137		22.86		-4.50		0.0685	
100	QPSK	1	271		23.06		-4.50		0.0718	
100	QPSK	135	0		21.98		-4.50		0.0560	
100	QPSK	135	67		22.99		-4.50		0.0706	
100	QPSK	135	138		22.16		-4.50		0.0583	
100	QPSK	270	0		22.06		-4.50		0.0570	
100	16QAM	1	1		22.03		-4.50		0.0566	
100	64QAM	1	1		20.26		-4.50		0.0377	
100	256QAM	1	1		18.56		-4.50		0.0255	
Channel				633000	633334	633668	Gain	L	M	H
Frequency (MHz)				3495	3500.01	3505.02				
90	PI/2 BPSK	1	1	23.06	23.08	23.12	-4.50	0.0718	0.0721	0.0728
Channel				632668	633334	634000	Gain	L	M	H
Frequency (MHz)				3490.02	3500.01	3510				
80	PI/2 BPSK	1	1	23.12	23.16	23.22	-4.50	0.0728	0.0735	0.0745
Channel				632334	633334	634334	Gain	L	M	H
Frequency (MHz)				3485.01	3500.01	3515.01				
70	PI/2 BPSK	1	1	23.05	23.15	22.86	-4.50	0.0716	0.0733	0.0685
Channel				632000	633334	634668	Gain	L	M	H
Frequency (MHz)				3480	3500.01	3520.02				
60	PI/2 BPSK	1	1	23.31	23.41	23.03	-4.50	0.0760	0.0778	0.0713
Channel				631668	633334	635000	Gain	L	M	H



Frequency (MHz)				3475.02	3500.01	3525				
50	PI/2 BPSK	1	1	23.23	23.33	22.96	-4.50	0.0746	0.0764	0.0701
Channel				631334	633334	635334	Gain	L	M	H
Frequency (MHz)				3470.01	3500.01	3530.01				
40	PI/2 BPSK	1	1	23.42	23.39	23.41	-4.50	0.0780	0.0774	0.0778
Channel				631000	633334	635668	Gain	L	M	H
Frequency (MHz)				3465	3500.01	3535.02				
30	PI/2 BPSK	1	1	23.39	23.36	23.27	-4.50	0.0774	0.0769	0.0753
Channel				630668	633334	636000	Gain	L	M	H
Frequency (MHz)				3460.02	3500.01	3540				
20	PI/2 BPSK	1	1	23.42	23.46	23.47	-4.50	0.0780	0.0787	0.0789

5G NR n78:

Ant.5

BW [MHz]	Modulation	RB Size	RB Offset	Power Low Ch. / Freq.	Power Middle Ch. / Freq.	Power High Ch. / Freq.	Gain	EIRP		
								L	M	H
Channel					633334			L	M	H
Frequency (MHz)					3500.01					
100	PI/2 BPSK	1	1		26.36		-5.60		0.1191	
100	PI/2 BPSK	1	137		25.78		-5.60		0.1042	
100	PI/2 BPSK	1	271		26.03		-5.60		0.1104	
100	PI/2 BPSK	135	0		25.52		-5.60		0.0982	
100	PI/2 BPSK	135	67		25.92		-5.60		0.1076	
100	PI/2 BPSK	135	138		25.49		-5.60		0.0975	
100	PI/2 BPSK	270	0		25.44		-5.60		0.0964	
100	QPSK	1	1		25.89		-5.60		0.1069	
100	QPSK	1	137		25.69		-5.60		0.1021	
100	QPSK	1	271		25.99		-5.60		0.1094	
100	QPSK	135	0		25.02		-5.60		0.0875	
100	QPSK	135	67		25.93		-5.60		0.1079	
100	QPSK	135	138		25.06		-5.60		0.0883	
100	QPSK	270	0		24.96		-5.60		0.0863	
100	16QAM	1	1		25.15		-5.60		0.0902	
100	64QAM	1	1		23.05		-5.60		0.0556	
100	256QAM	1	1		24.44		-5.60		0.0766	
Channel				633000	633334	633668	Gain	L	M	H
Frequency (MHz)				3495	3500.01	3505.02				
90	PI/2 BPSK	1	1	25.96	26.22	26.05	-5.60	0.1086	0.1153	0.1109
Channel				632668	633334	634000	Gain	L	M	H
Frequency (MHz)				3490.02	3500.01	3510				
80	PI/2 BPSK	1	1	25.96	26.09	26.22	-5.60	0.1086	0.1119	0.1153
Channel				632334	633334	634334	Gain	L	M	H
Frequency (MHz)				3485.01	3500.01	3515.01				



70	QPSK	1	1	26.03	26.16	25.86	-5.60	0.1104	0.1138	0.1062
Channel				632000	633334	634668	Gain	L	M	H
Frequency (MHz)				3480	3500.01	3520.02				
60	PI/2 BPSK	1	1	25.89	26.35	25.96	-5.60	0.1069	0.1189	0.1086
Channel				631668	633334	635000	Gain	L	M	H
Frequency (MHz)				3475.02	3500.01	3525				
50	PI/2 BPSK	1	1	26.22	26.13	25.75	-5.60	0.1153	0.1130	0.1035
Channel				631334	633334	635334	Gain	L	M	H
Frequency (MHz)				3470.01	3500.01	3530.01				
40	PI/2 BPSK	1	1	26.31	26.28	26.32	-5.60	0.1178	0.1169	0.1180
Channel				631000	633334	635668	Gain	L	M	H
Frequency (MHz)				3465	3500.01	3535.02				
30	PI/2 BPSK	1	1	26.28	26.35	26.21	-5.60	0.1169	0.1189	0.1151
Channel				630668	633334	636000	Gain	L	M	H
Frequency (MHz)				3460.02	3500.01	3540				
20	PI/2 BPSK	1	1	26.34	26.23	26.33	-5.60	0.1186	0.1156	0.1183

Ant.3

BW [MHz]	Modulation	RB Size	RB Offset	Power Low Ch. / Freq.	Power Middle Ch. / Freq.	Power High Ch. / Freq.	Gain	EIRP		
								L	M	H
Channel					633334			L	M	H
Frequency (MHz)					3500.01					
100	PI/2 BPSK	1	1		25.91		-0.70		0.3319	
100	PI/2 BPSK	1	137		25.86		-0.70		0.3281	
100	PI/2 BPSK	1	271		25.83		-0.70		0.3258	
100	PI/2 BPSK	135	0		25.44		-0.70		0.2979	
100	PI/2 BPSK	135	67		25.88		-0.70		0.3296	
100	PI/2 BPSK	135	138		25.43		-0.70		0.2972	
100	PI/2 BPSK	270	0		25.41		-0.70		0.2958	
100	QPSK	1	1		25.96		-0.70		0.3357	
100	QPSK	1	137		25.90		-0.70		0.3311	
100	QPSK	1	271		25.85		-0.70		0.3273	
100	QPSK	135	0		24.99		-0.70		0.2685	
100	QPSK	135	67		25.85		-0.70		0.3273	
100	QPSK	135	138		24.93		-0.70		0.2649	
100	QPSK	270	0		24.97		-0.70		0.2673	
100	16QAM	1	1		24.98		-0.70		0.2679	
100	64QAM	1	1		22.84		-0.70		0.1637	
100	256QAM	1	1		21.21		-0.70		0.1125	



# FR1 n78

## Peak-to-Average Ratio

Mode	FR1 n78 / 100MHz / DFT-S OFDM				
Mod.	100M				Limit: 13dB
RB Size	BPSK	QPSK	16QAM	64QAM	Result
Middle CH	5.4	5.29	5.29	5.49	PASS
RB Size	256QAM				
Middle CH	5.39				

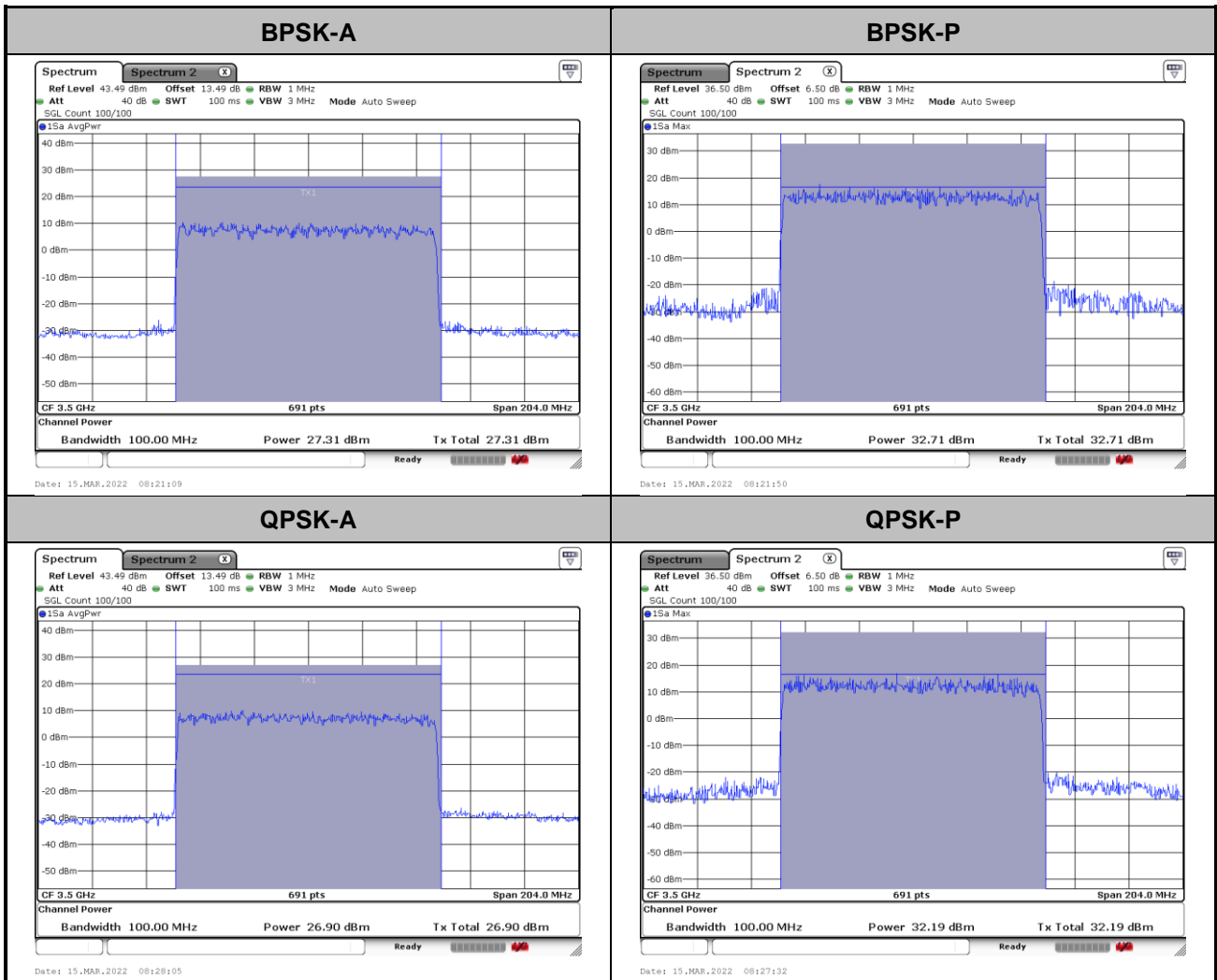

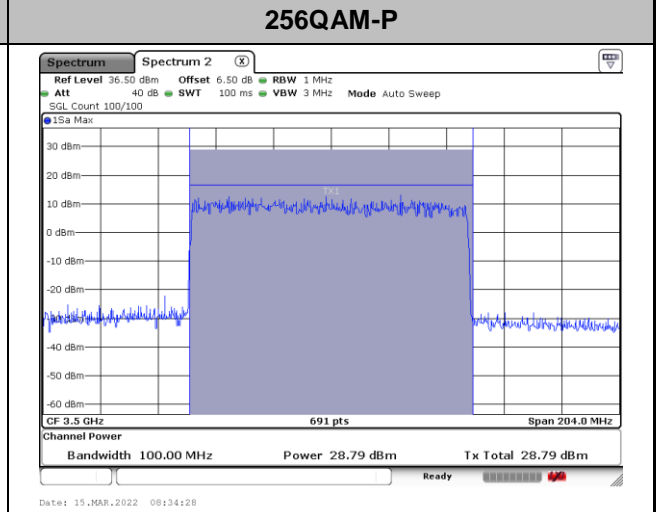
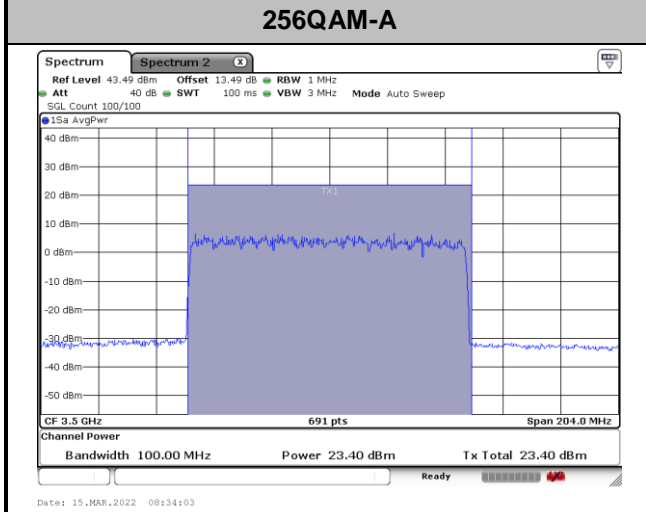
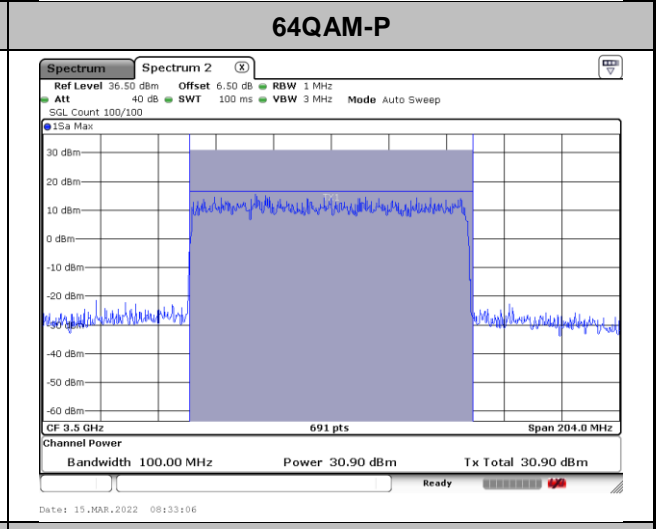
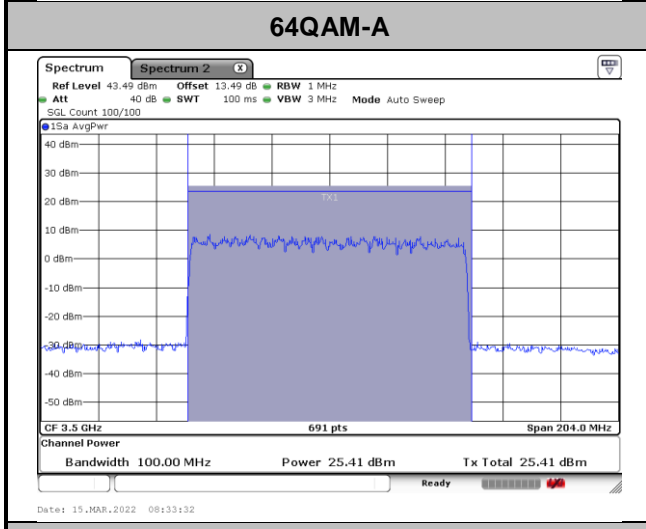
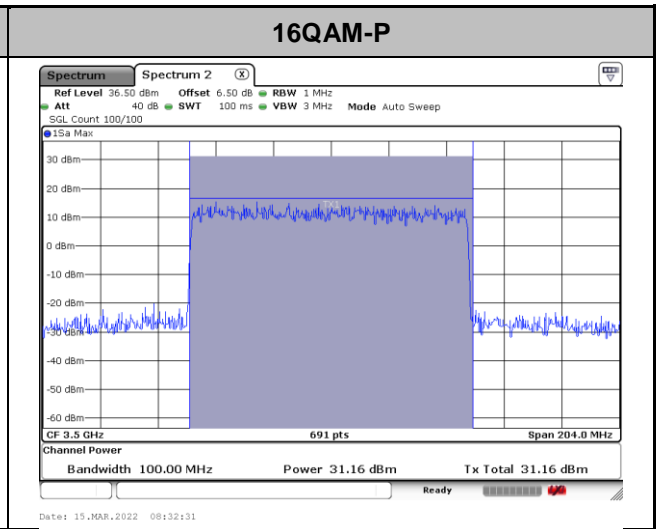
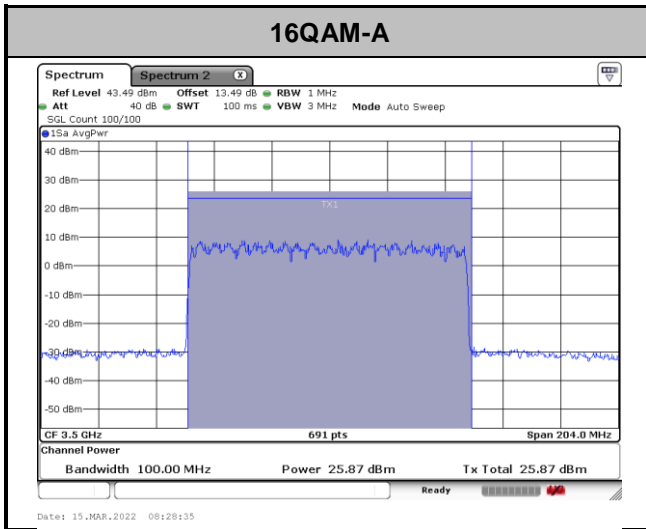



## 26dB Bandwidth

Mode	FR1 n78 : 26dB BW(MHz) / DFT-S OFDM	
BW	100MHz	
Mod.	QPSK	16QAM
Middle CH	102.3	102.5

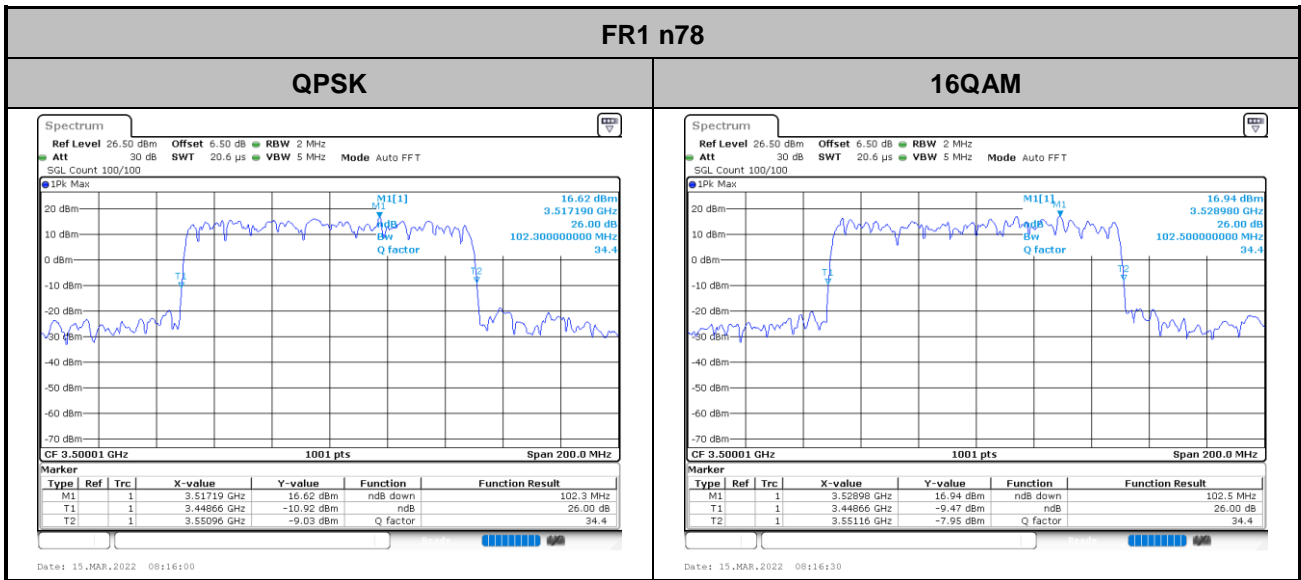



# Occupied Bandwidth

Mode	FR1 n78: OB BW(MHz) / DFT-S OFDM	
BW	100MHz	
Mod.	QPSK	16QAM
Middle CH	97.10	97.30

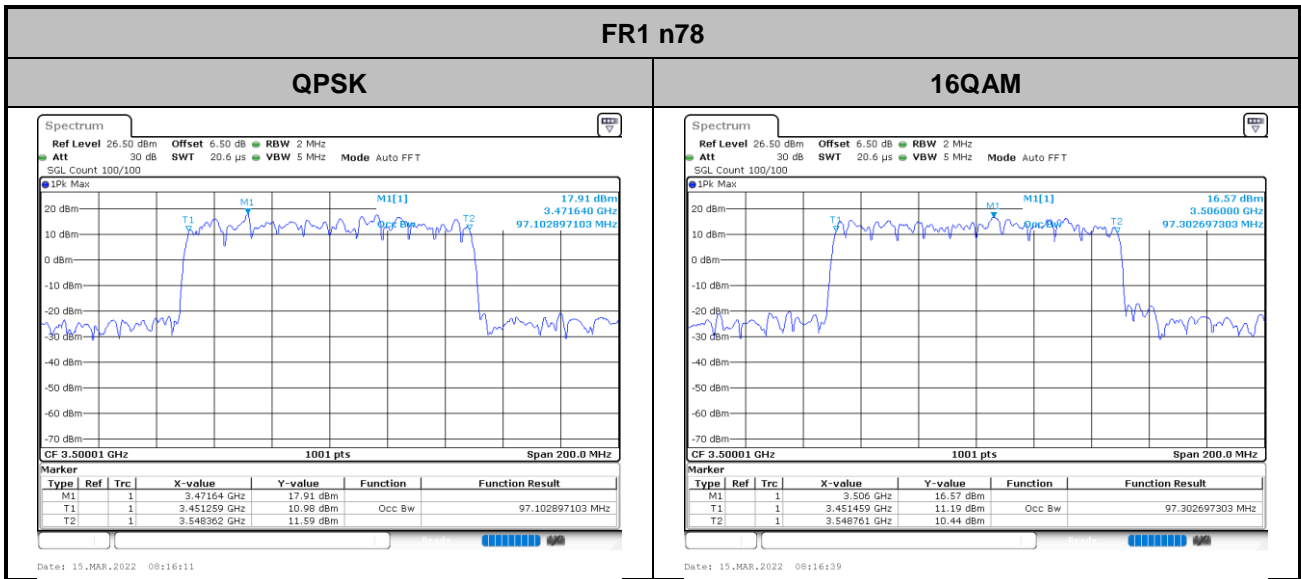



# Conducted Band Edge

## FR1 n78 / 20MHz / DFT-S OFDM / PI/2 BPSK

### Lowest Band Edge / 1RB0

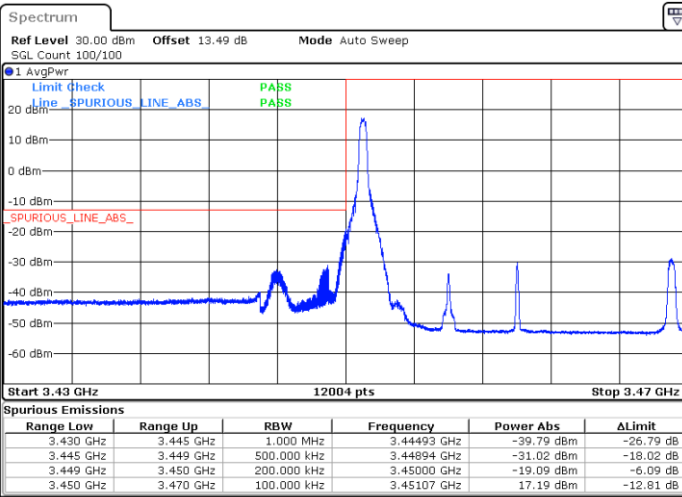

Date: 3.APR.2022 12:28:35

### Highest Band Edge / 1RBmax

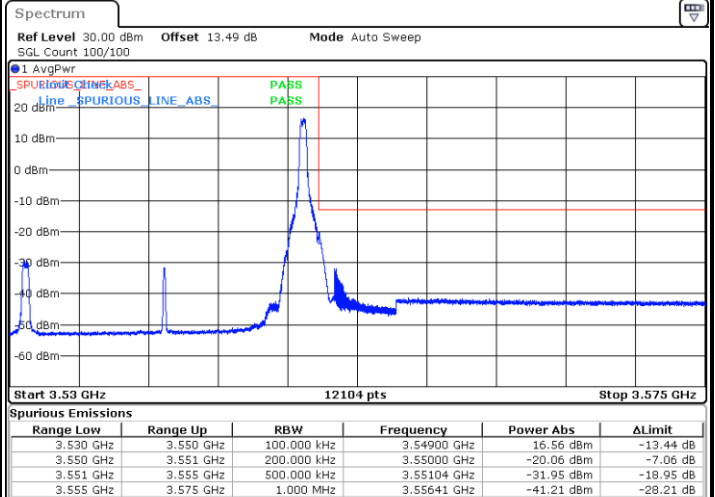

Date: 3.APR.2022 12:36:57

### Lowest Band Edge / Full RB

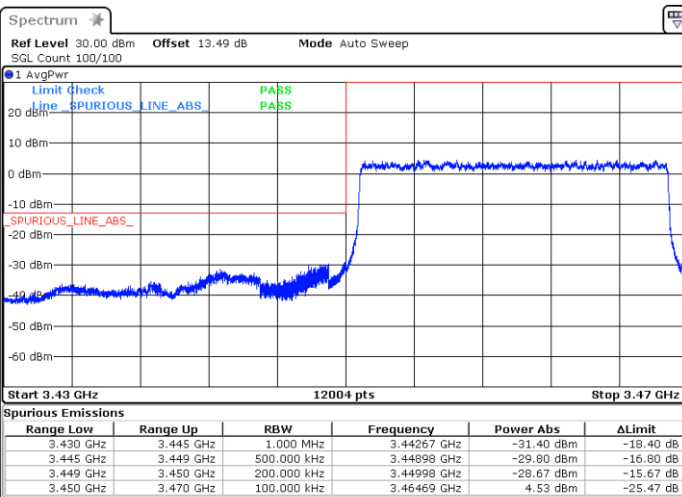

Date: 3.APR.2022 12:20:10

### Highest Band Edge / Full RB

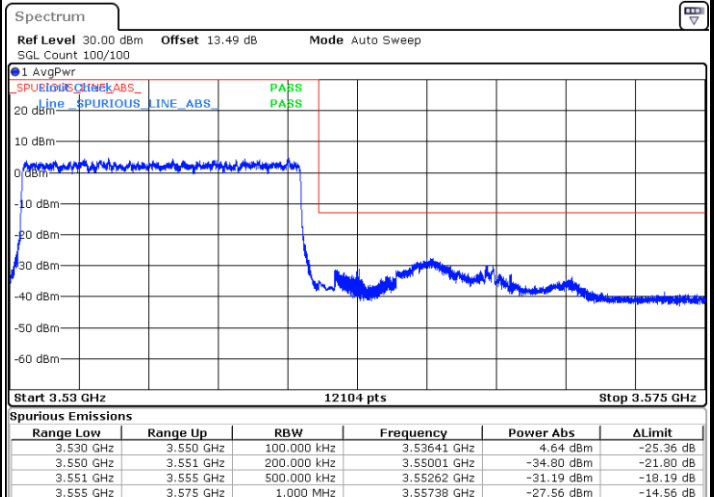

Date: 3.APR.2022 12:30:08





FR1 n78 / 20MHz / DFT-S OFDM / QPSK

Lowest Band Edge / 1RB0

Highest Band Edge / 1RBmax

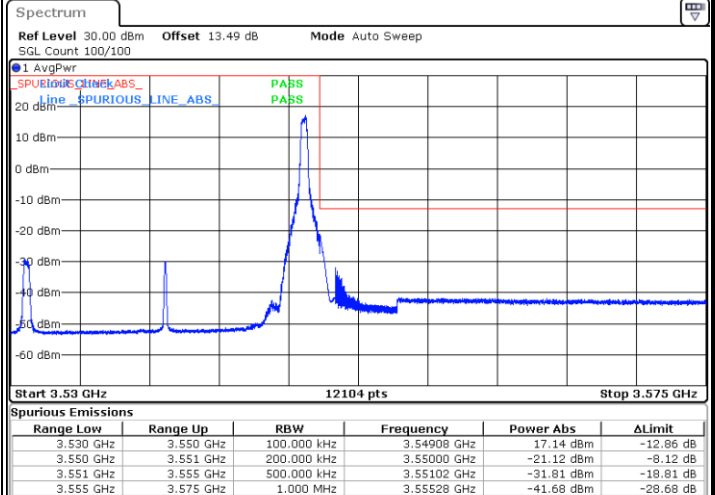
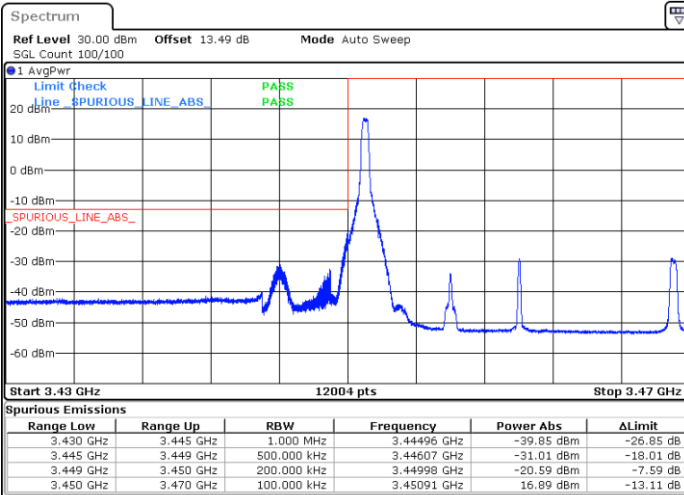

Date: 3.APR.2022 12:27:46

Date: 3.APR.2022 12:36:13

Lowest Band Edge / Full RB

Highest Band Edge / Full RB

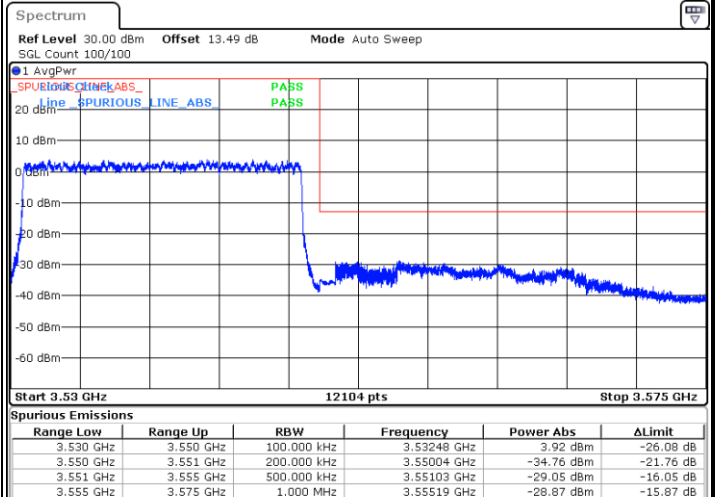
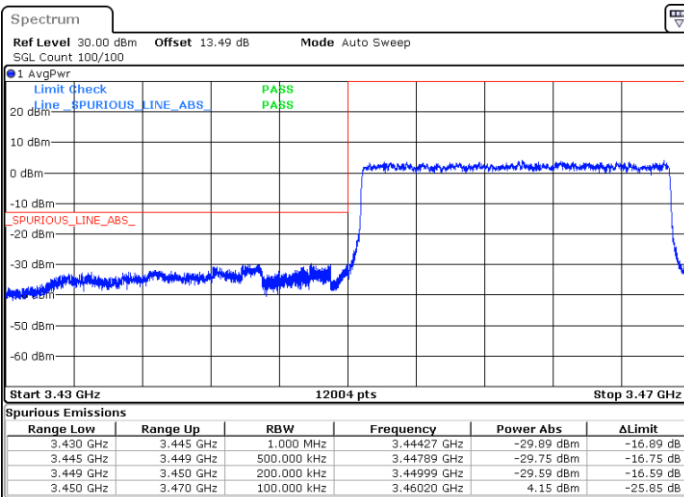

Date: 3.APR.2022 12:22:30

Date: 3.APR.2022 12:30:51



FR1 n78 / 20MHz / DFT-S OFDM / 16QAM

Lowest Band Edge / 1RB0

Highest Band Edge / 1RBmax

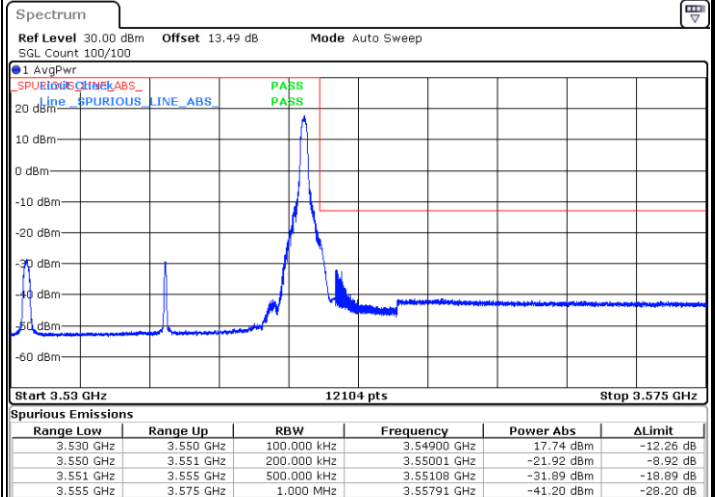
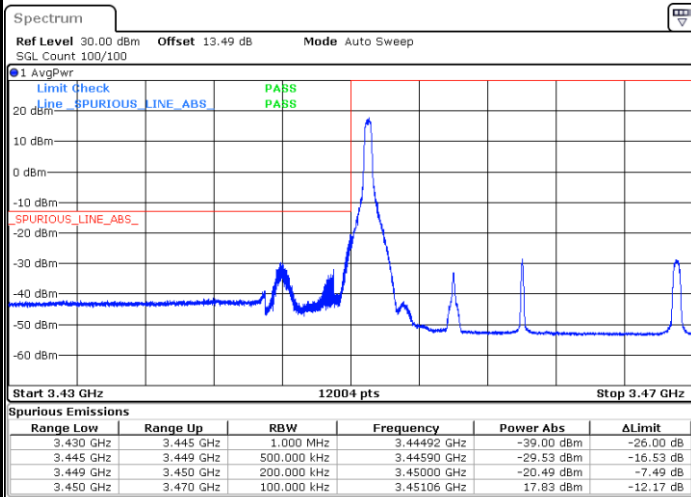

Date: 3.APR.2022 12:27:04

Date: 3.APR.2022 12:35:35

Lowest Band Edge / Full RB

Highest Band Edge / Full RB

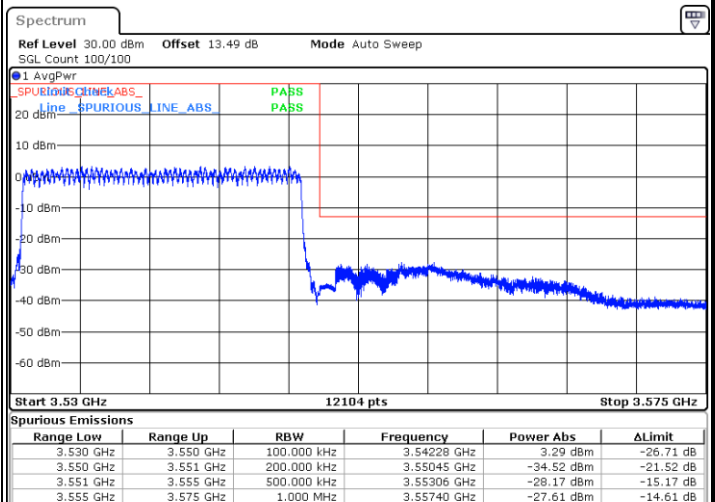
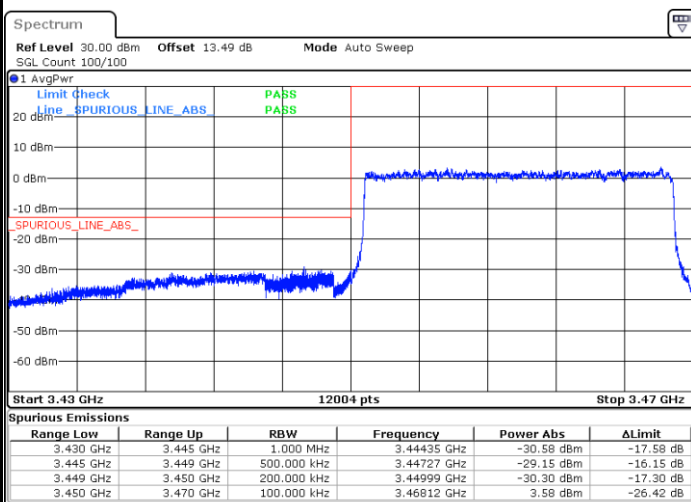

Date: 3.APR.2022 12:23:11

Date: 3.APR.2022 12:31:29



FR1 n78 / 20MHz / DFT-S OFDM / 64QAM

Lowest Band Edge / 1RB0

Highest Band Edge / 1RBmax

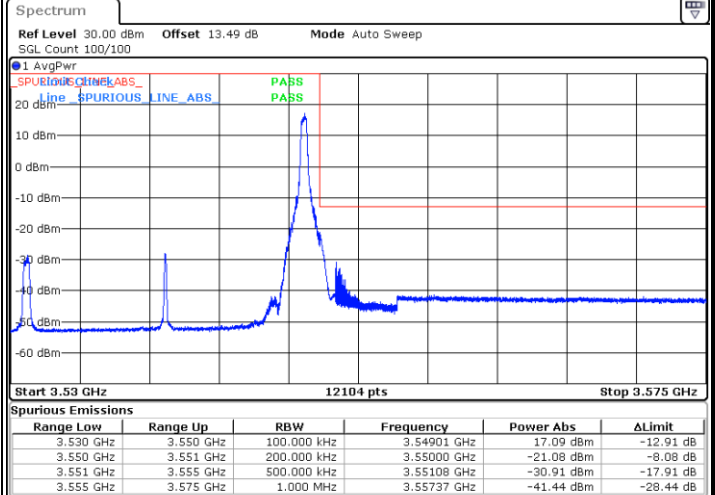
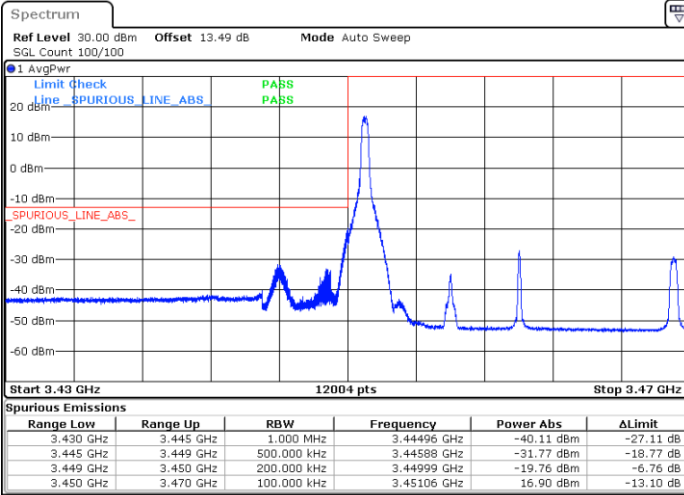

Date: 3.APR.2022 12:26:22

Date: 3.APR.2022 12:34:55

Lowest Band Edge / Full RB

Highest Band Edge / Full RB

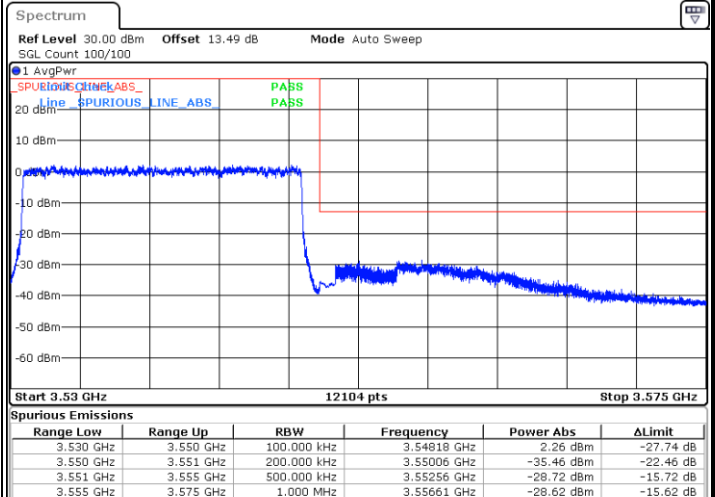
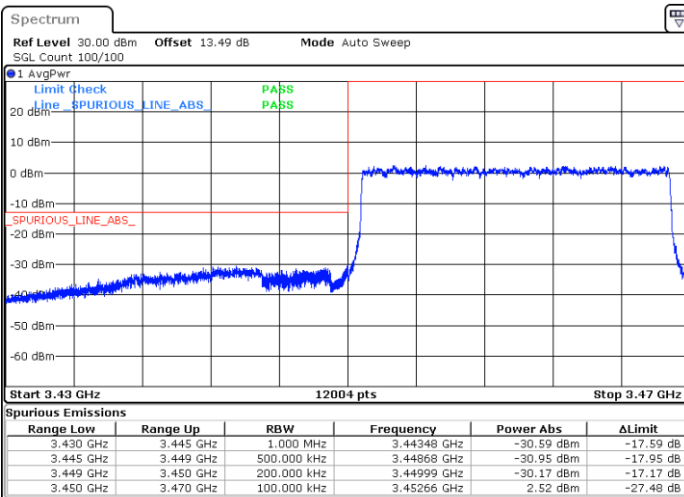

Date: 3.APR.2022 12:23:52

Date: 3.APR.2022 12:32:14



FR1 n78 / 20MHz / DFT-S OFDM / 256QAM

Lowest Band Edge / 1RB0

Highest Band Edge / 1RBmax

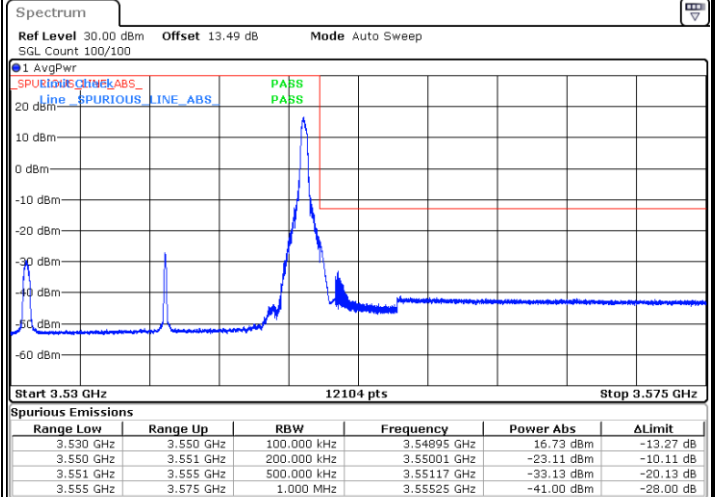
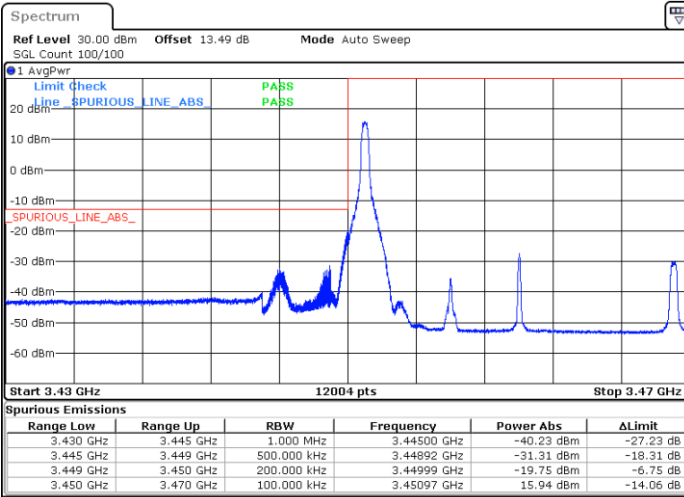

Date: 3.APR.2022 12:25:44

Date: 3.APR.2022 12:33:52

Lowest Band Edge / Full RB

Highest Band Edge / Full RB

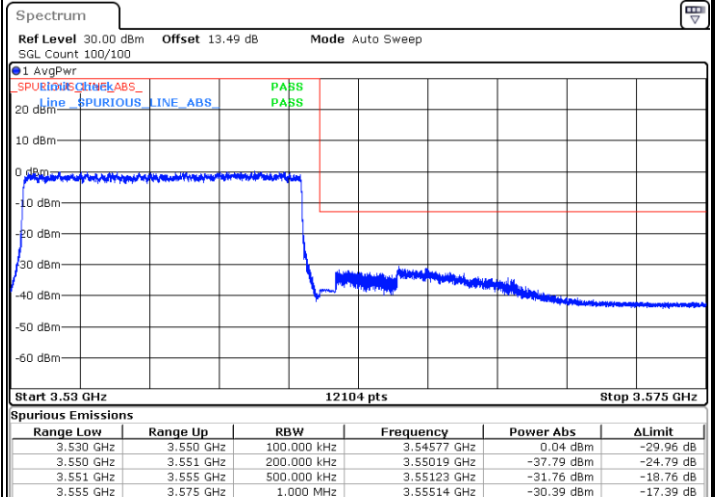
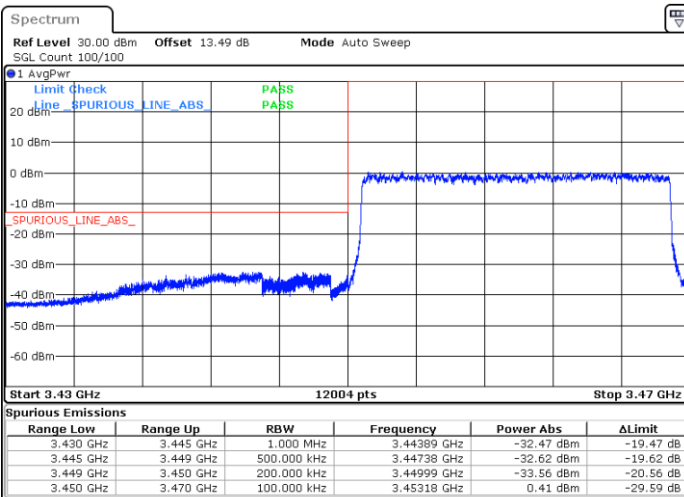

Date: 3.APR.2022 12:24:51

Date: 3.APR.2022 12:33:05



FR1 n78/ 30MHz / DFT-S OFDM / PI/2 BPSK

Lowest Band Edge / 1RB0

Highest Band Edge / 1RBmax

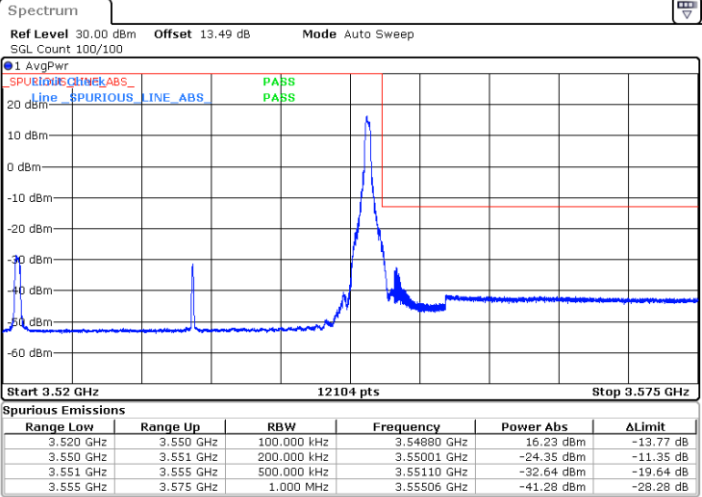
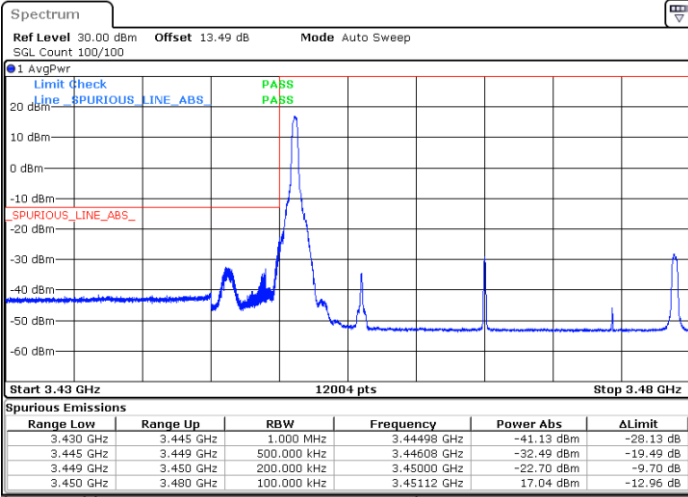

Date: 3.APR.2022 12:50:36

Date: 3.APR.2022 13:29:07

Lowest Band Edge / Full RB

Highest Band Edge / Full RB

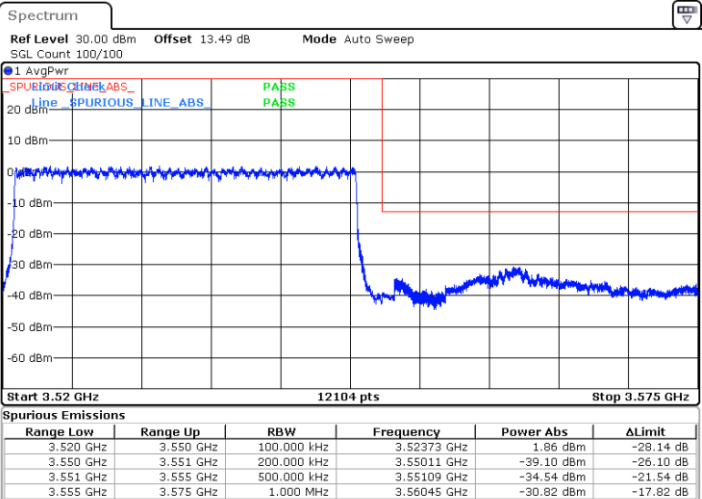
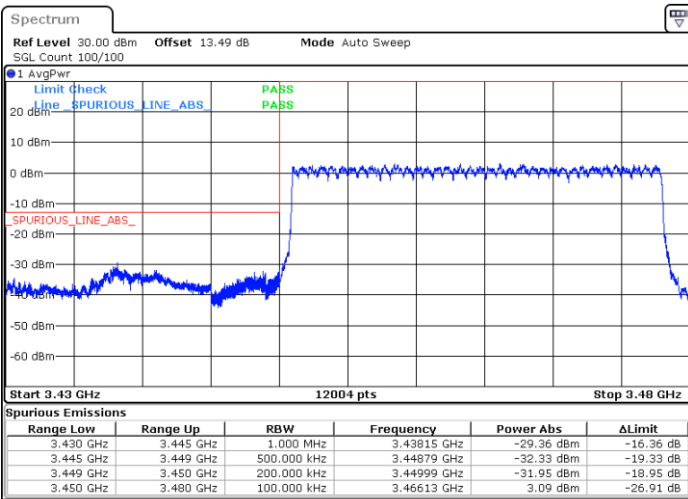

Date: 3.APR.2022 12:43:02

Date: 3.APR.2022 12:51:57



FR1 n78 / 30MHz / DFT-S OFDM / QPSK

Lowest Band Edge / 1RB0

Highest Band Edge / 1RBmax

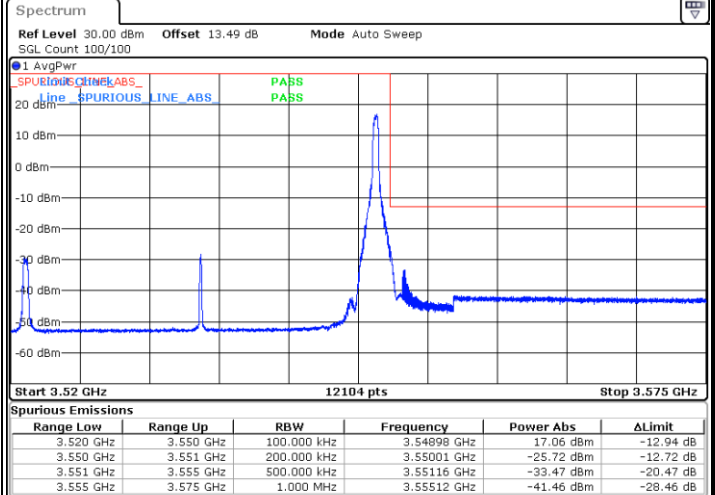
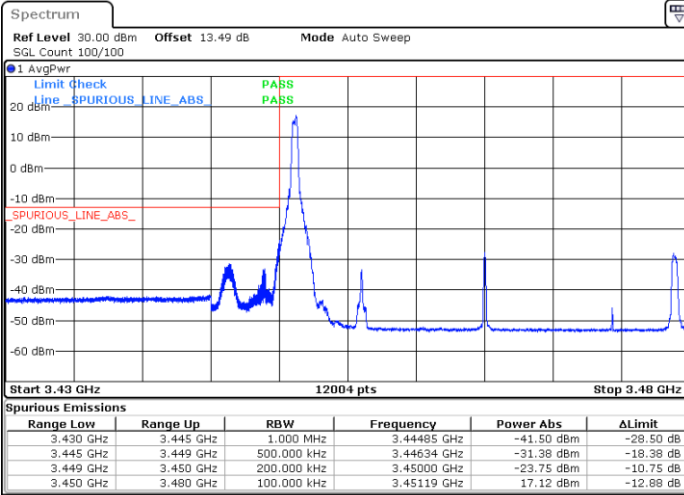

Date: 3.APR.2022 12:49:25

Date: 3.APR.2022 12:57:36

Lowest Band Edge / Full RB

Highest Band Edge / Full RB

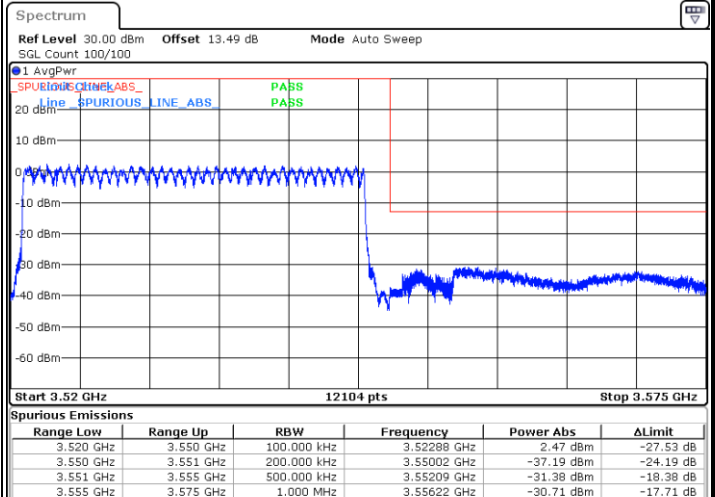
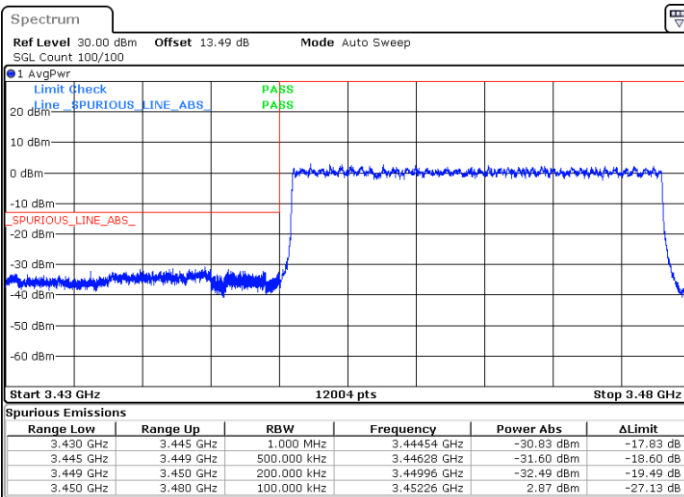

Date: 3.APR.2022 12:43:48

Date: 3.APR.2022 12:52:47



FR1 n78 / 30MHz / DFT-S OFDM / 16QAM

Lowest Band Edge / 1RB0

Highest Band Edge / 1RBmax

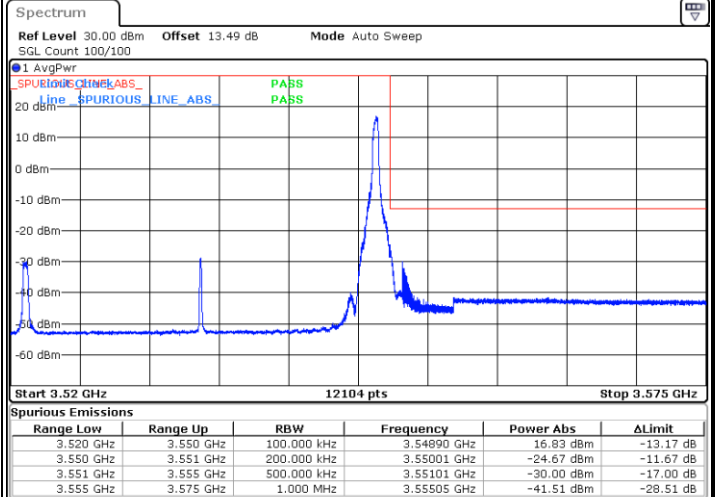
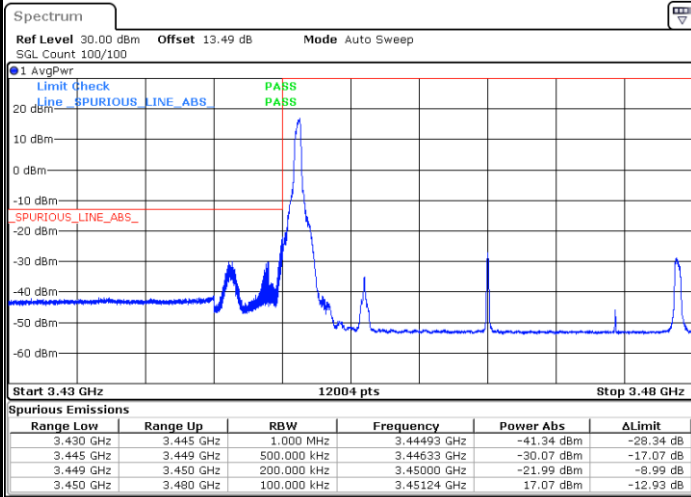

Date: 3.APR.2022 12:48:38

Date: 3.APR.2022 12:57:00

Lowest Band Edge / Full RB

Highest Band Edge / Full RB

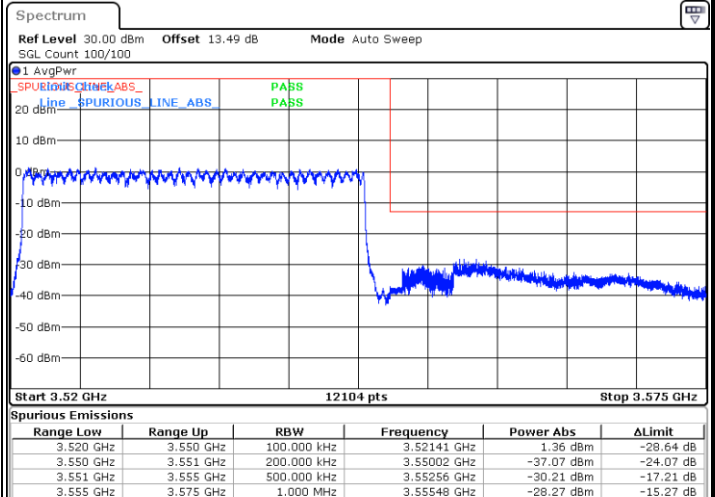
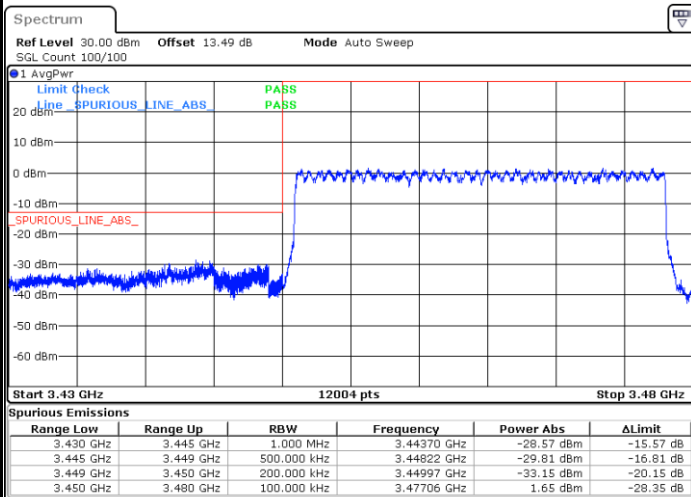

Date: 3.APR.2022 12:44:42

Date: 3.APR.2022 12:53:27





FR1 n78 / 30MHz / DFT-S OFDM / 64QAM

Lowest Band Edge / 1RB0

Highest Band Edge / 1RBmax

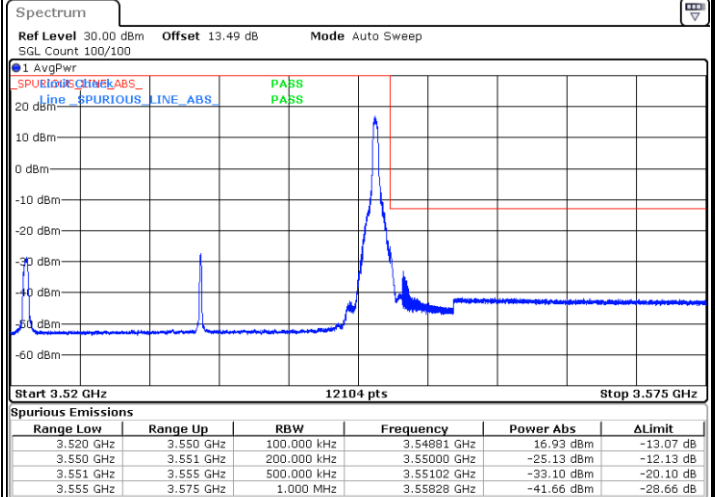
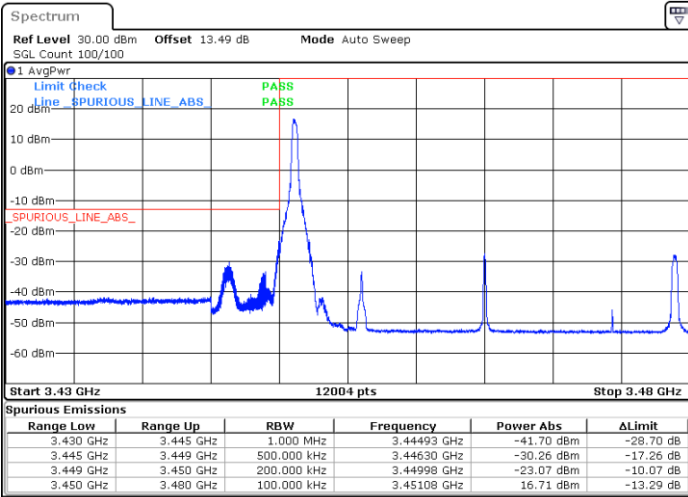

Date: 3.APR.2022 12:48:00

Date: 3.APR.2022 12:56:22

Lowest Band Edge / Full RB

Highest Band Edge / Full RB

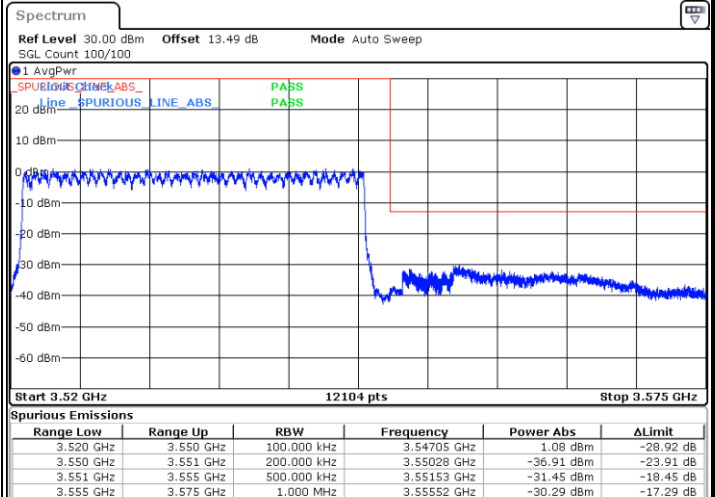
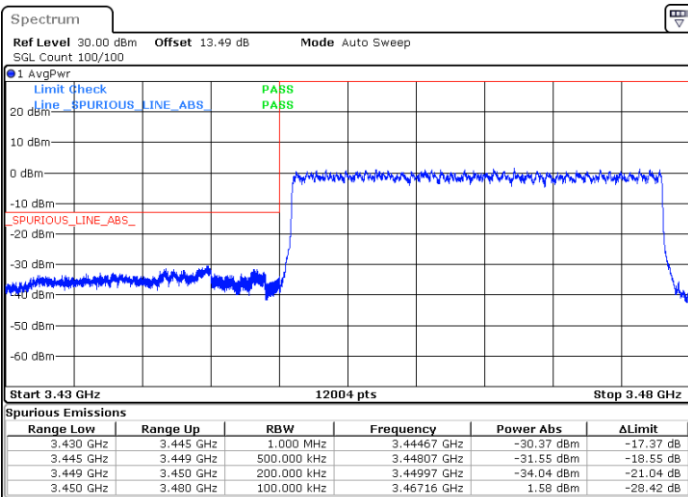

Date: 3.APR.2022 12:45:37

Date: 3.APR.2022 12:54:03





FR1 n78 / 30MHz / DFT-S OFDM / 256QAM

Lowest Band Edge / 1RB0

Highest Band Edge / 1RBmax

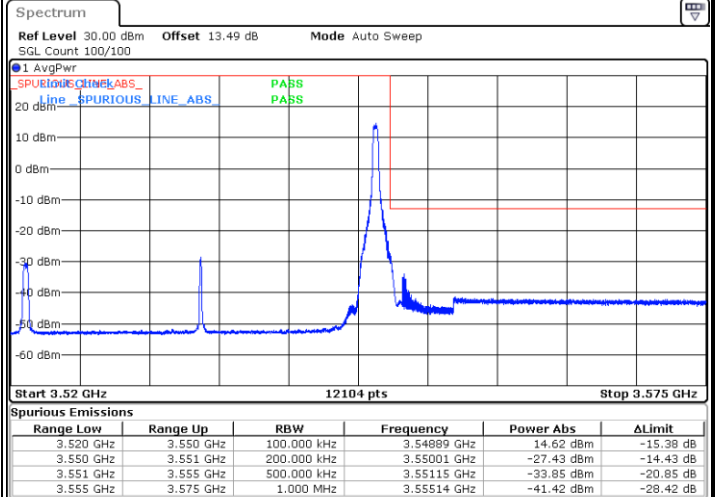
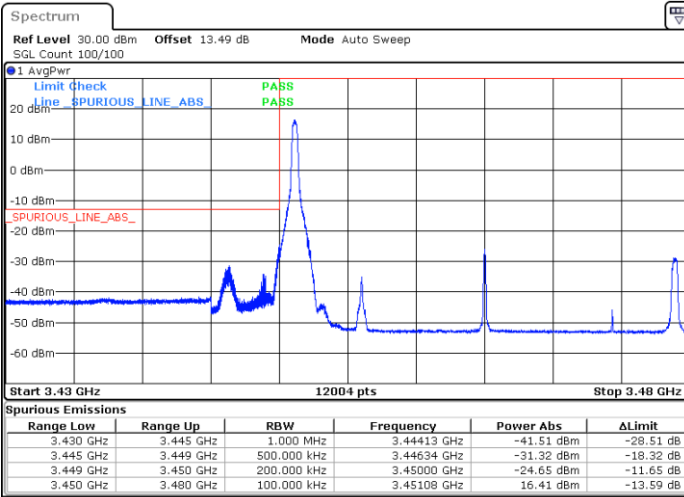

Date: 3.APR.2022 12:47:17

Date: 3.APR.2022 12:55:46

Lowest Band Edge / Full RB

Highest Band Edge / Full RB

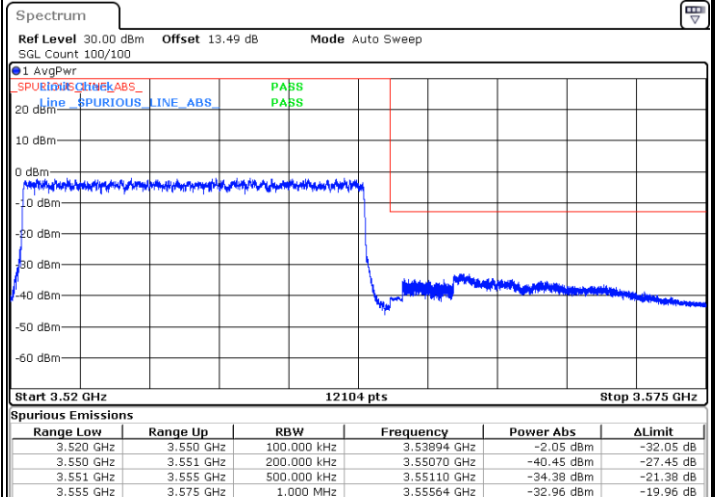
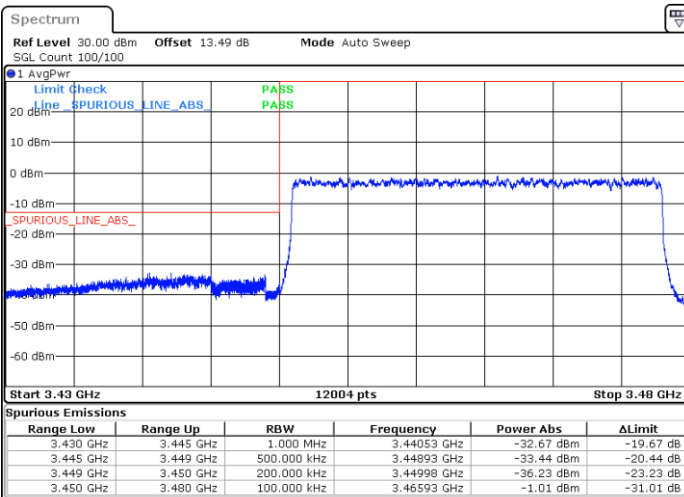

Date: 3.APR.2022 12:46:20

Date: 3.APR.2022 12:55:01



FR1 n78 / 40MHz / DFT-S OFDM / PI/2 BPSK

Lowest Band Edge / 1RB0

Highest Band Edge / 1RBmax

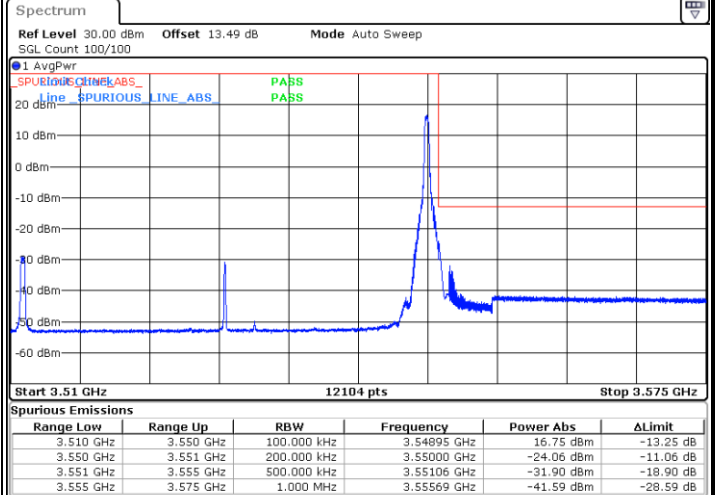
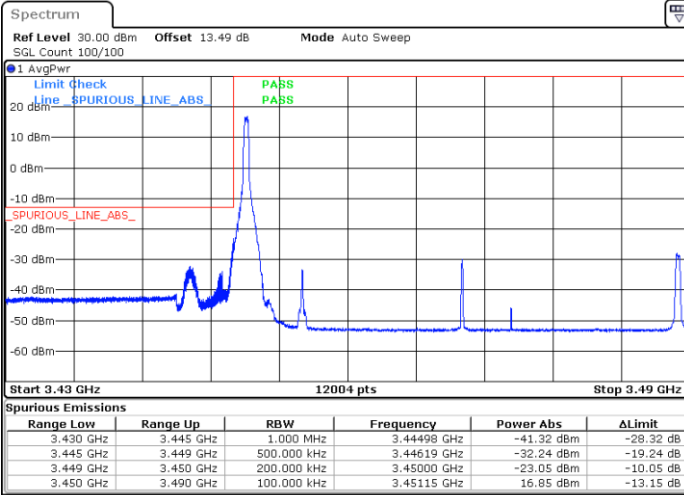

Date: 3.APR.2022 13:40:09

Date: 3.APR.2022 13:49:30

Lowest Band Edge / Full RB

Highest Band Edge / Full RB

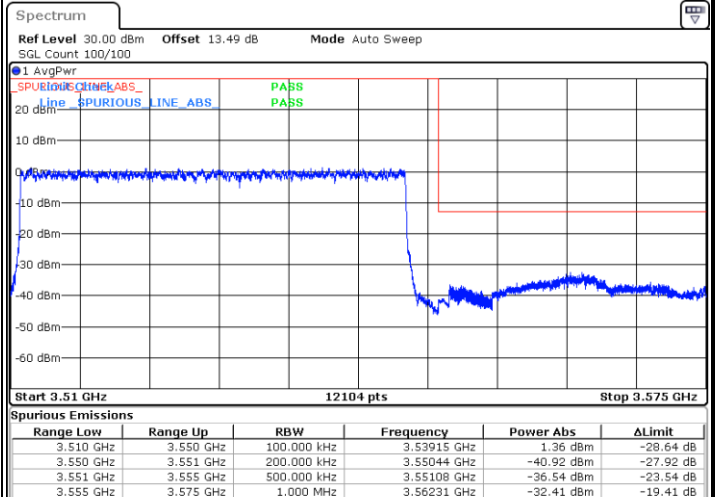
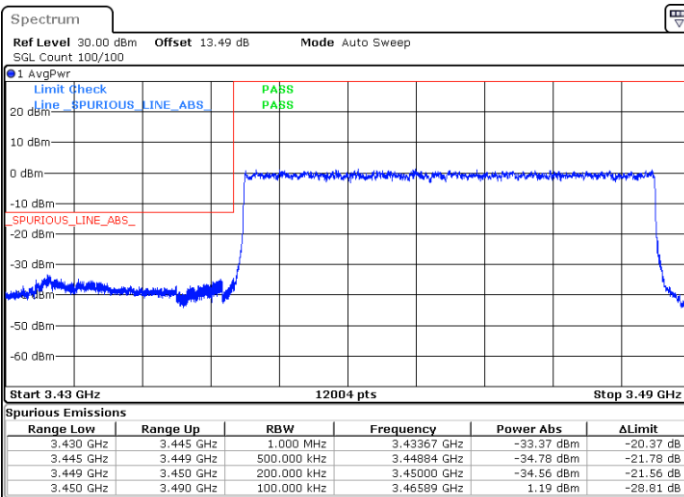

Date: 3.APR.2022 13:32:57

Date: 3.APR.2022 13:41:54



FR1 n78 / 40MHz / DFT-S OFDM / QPSK

Lowest Band Edge / 1RB0

Highest Band Edge / 1RBmax

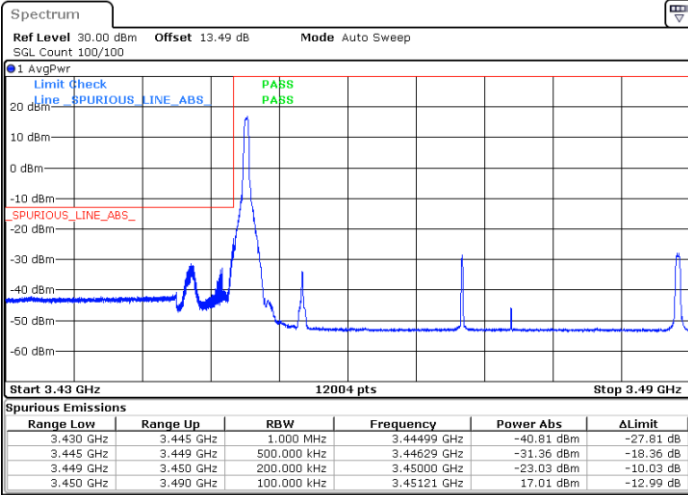

Date: 3.APR.2022 13:39:15

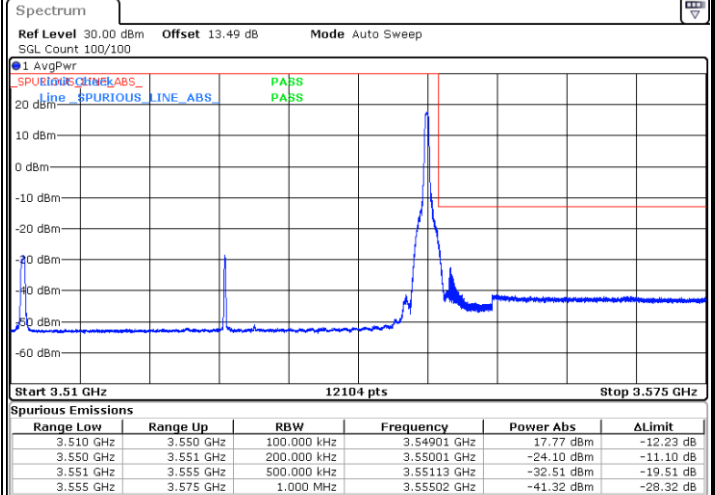

Date: 3.APR.2022 13:40:39

Lowest Band Edge / Full RB

Highest Band Edge / Full RB

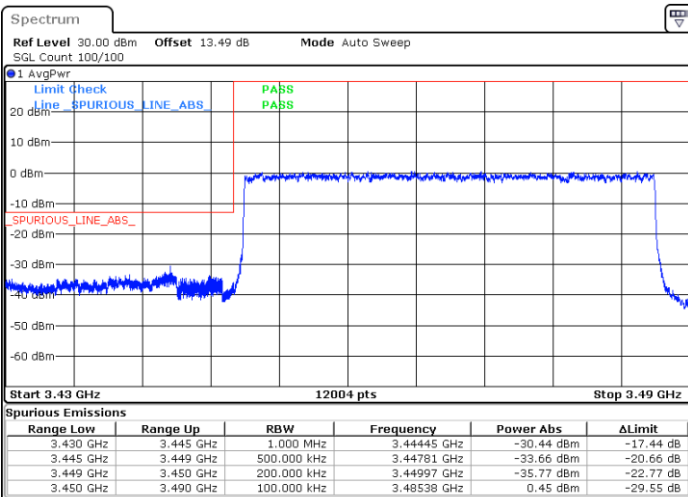

Date: 3.APR.2022 13:33:39

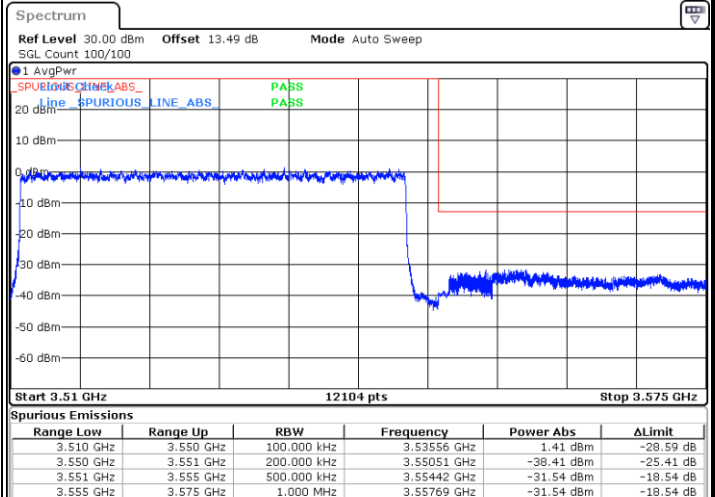

Date: 3.APR.2022 13:42:53



FR1 n78 / 40MHz / DFT-S OFDM / 16QAM

Lowest Band Edge / 1RB0

Highest Band Edge / 1RBmax

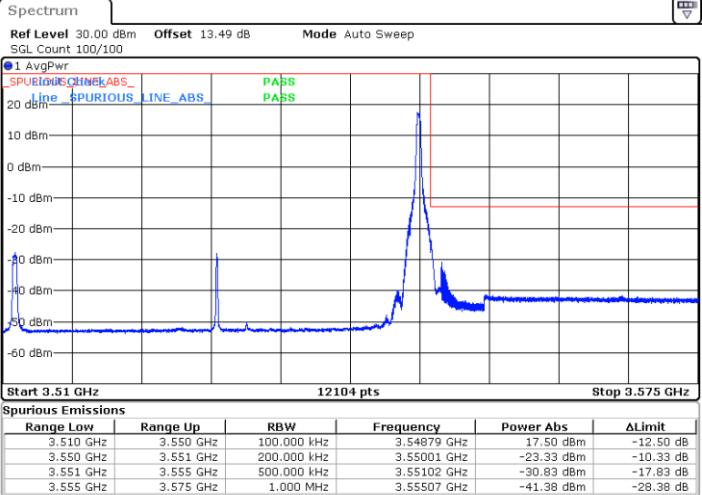
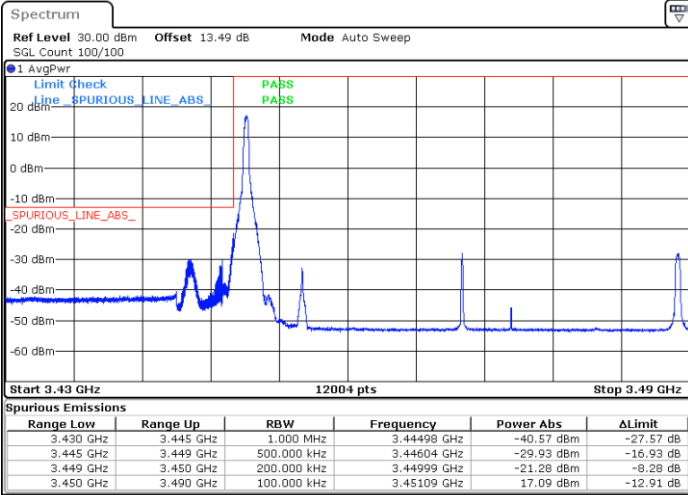

Date: 3.APR.2022 13:38:28

Date: 3.APR.2022 13:47:47

Lowest Band Edge / Full RB

Highest Band Edge / Full RB

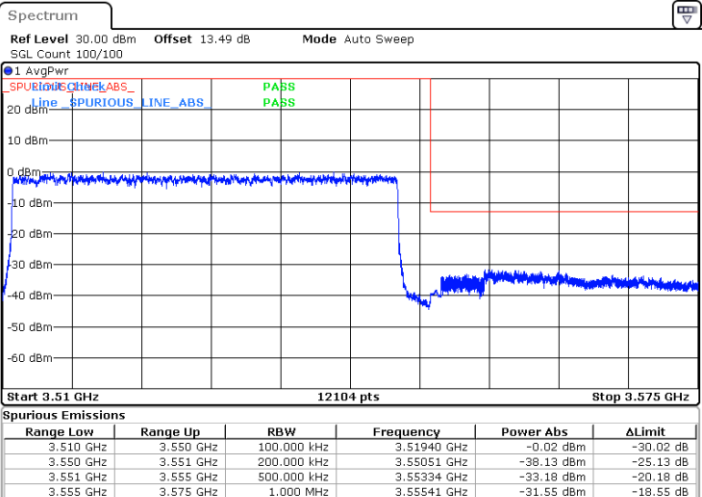
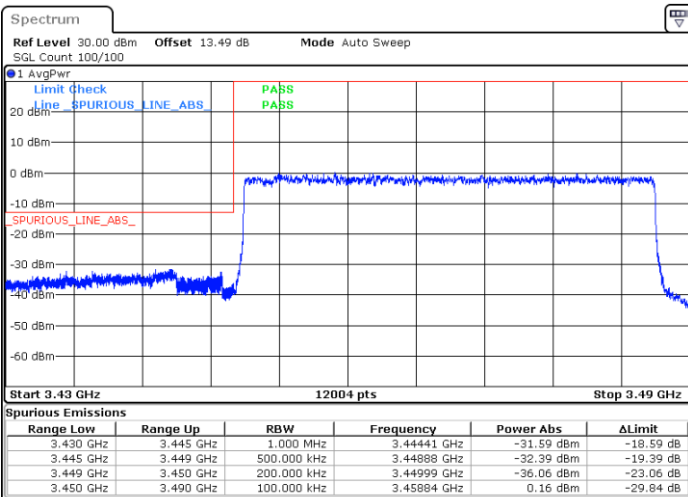

Date: 3.APR.2022 13:34:38

Date: 3.APR.2022 13:43:35



FR1 n78 / 40MHz / DFT-S OFDM / 64QAM

Lowest Band Edge / 1RB0

Highest Band Edge / 1RBmax

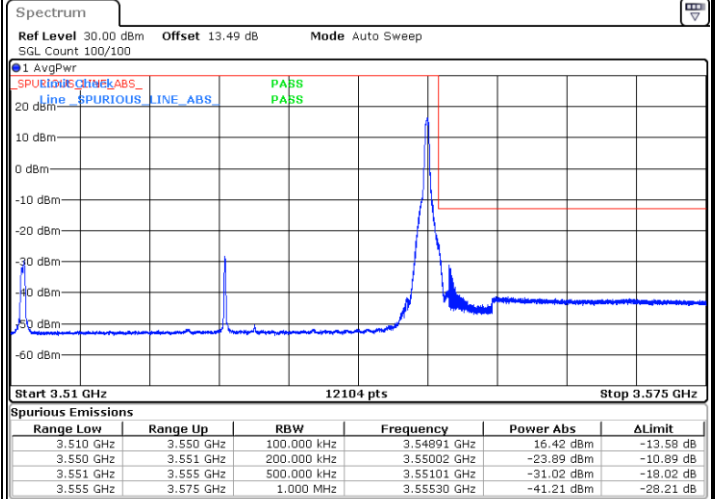
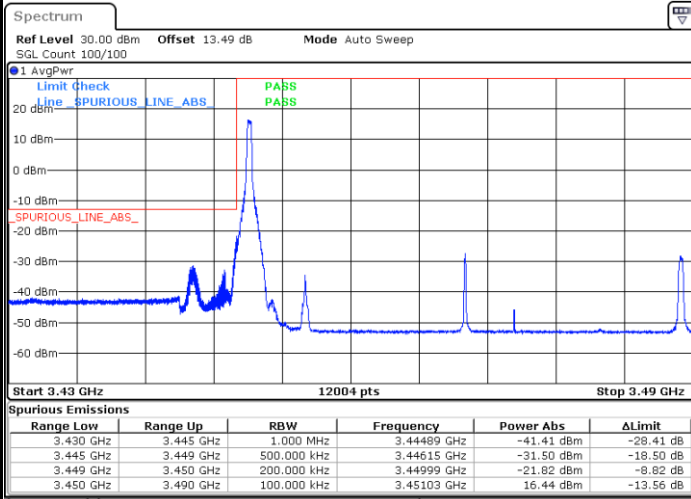

Date: 3.APR.2022 13:37:30

Date: 3.APR.2022 13:46:54

Lowest Band Edge / Full RB

Highest Band Edge / Full RB

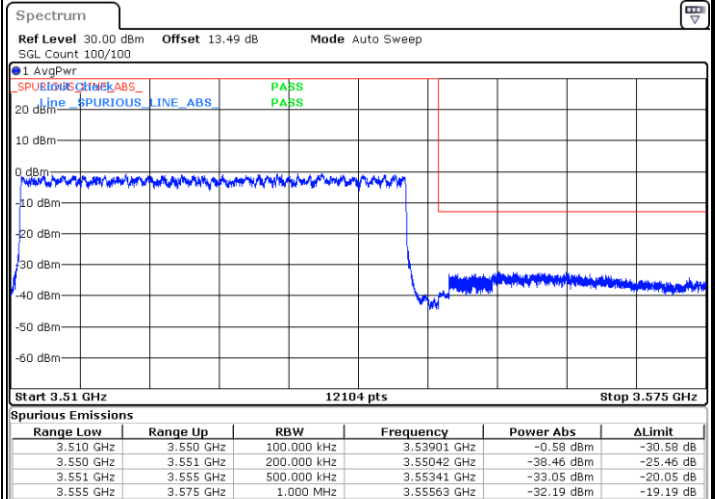
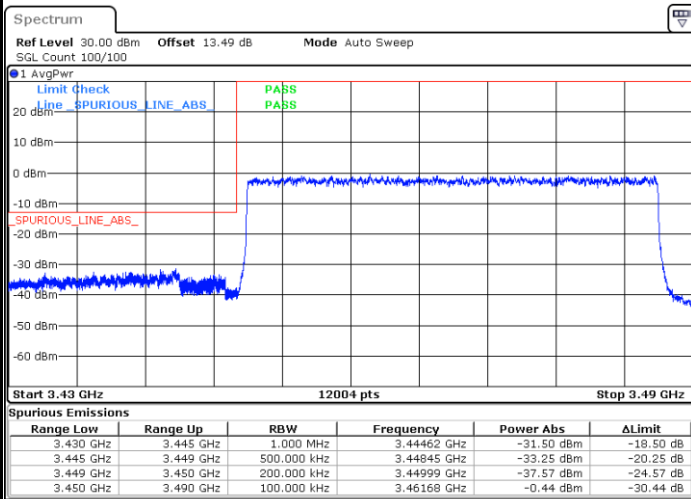

Date: 3.APR.2022 13:35:23

Date: 3.APR.2022 13:44:27



FR1 n78 / 40MHz / DFT-S OFDM / 256QAM

Lowest Band Edge / 1RB0

Highest Band Edge / 1RBmax

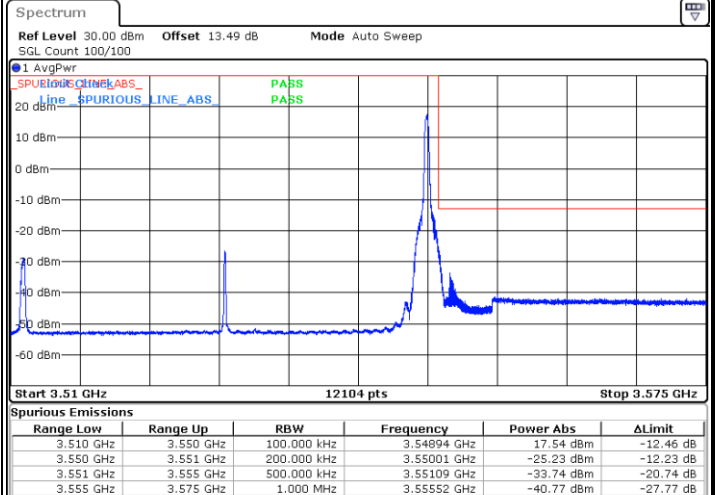
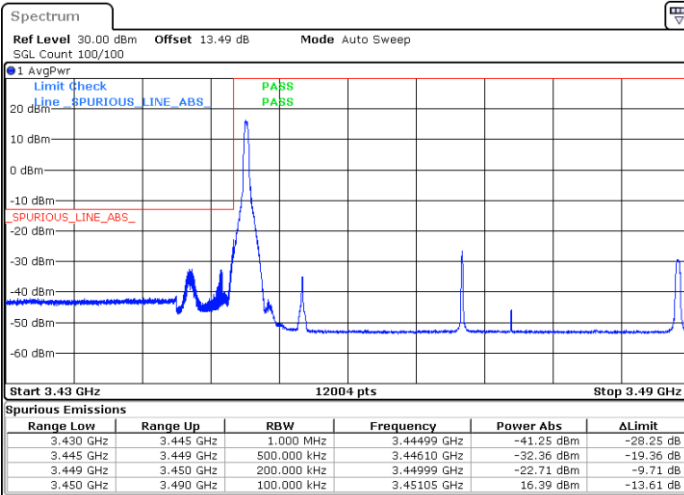

Date: 3.APR.2022 13:36:49

Date: 3.APR.2022 13:46:10

Lowest Band Edge / Full RB

Highest Band Edge / Full RB

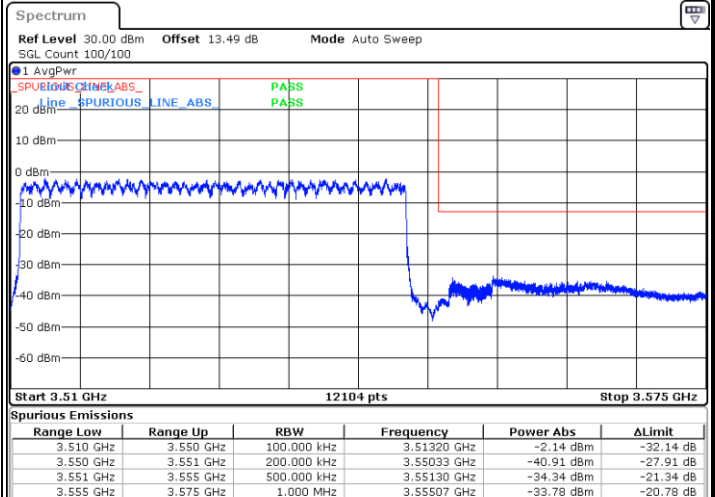
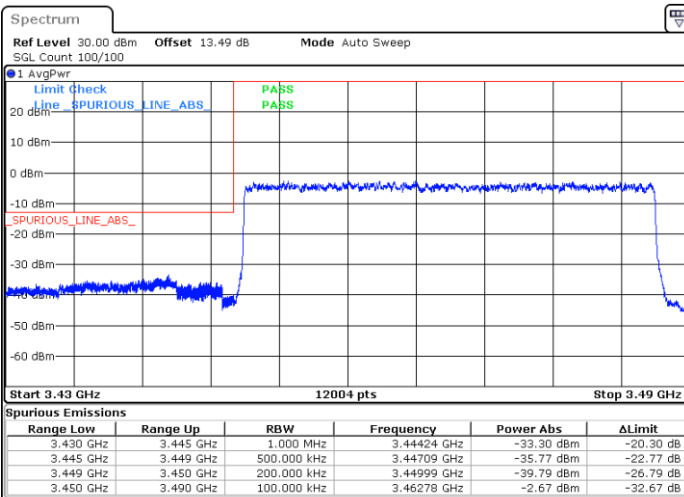

Date: 3.APR.2022 13:36:06

Date: 3.APR.2022 13:45:23



FR1 n78 / 50MHz / DFT-S OFDM / BPSK

Lowest Band Edge / 1RB0

Highest Band Edge / 1RBmax

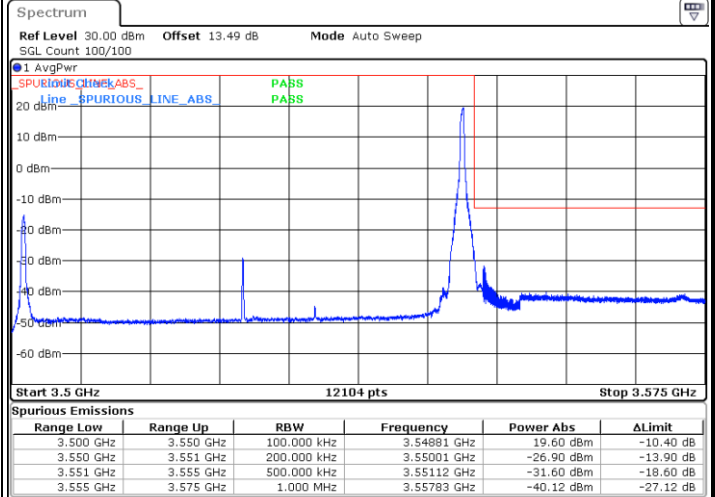
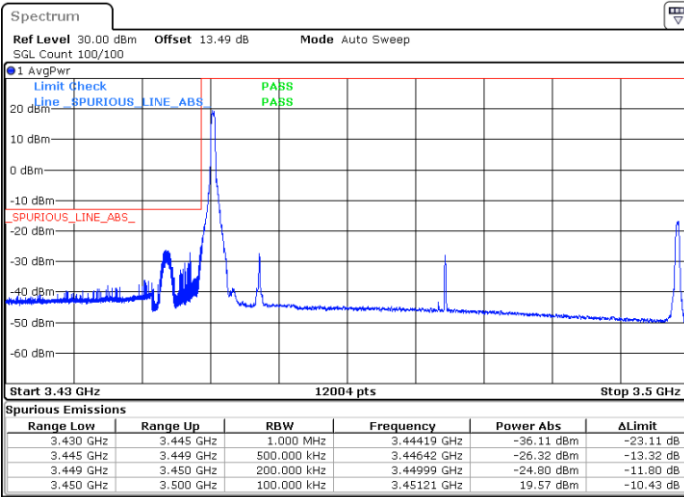

Date: 15.MAR.2022 02:09:13

Date: 15.MAR.2022 02:31:49

Lowest Band Edge / Full RB

Highest Band Edge / Full RB

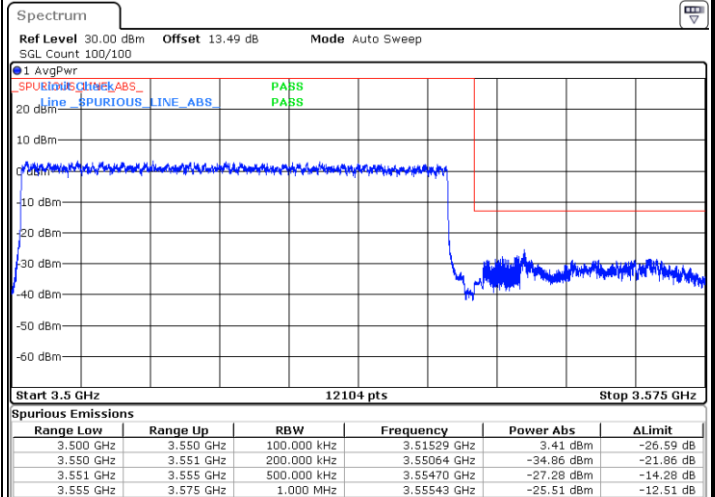
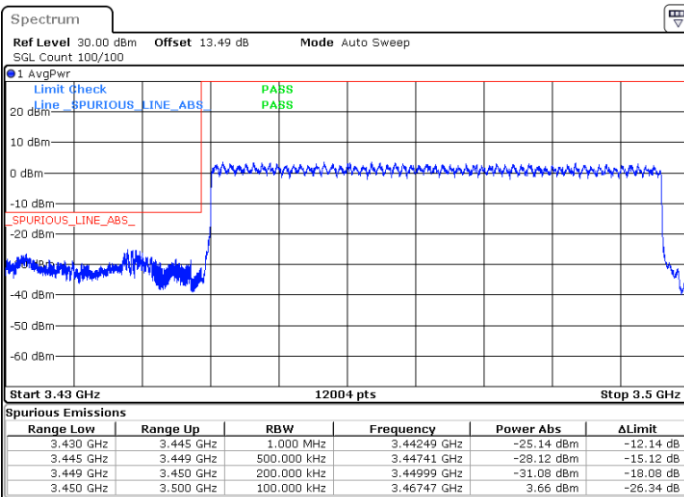

Date: 15.MAR.2022 02:10:03

Date: 15.MAR.2022 02:30:58





FR1 n78 / 50MHz / DFT-S OFDM / QPSK

Lowest Band Edge / 1RB0

Highest Band Edge / 1RBmax

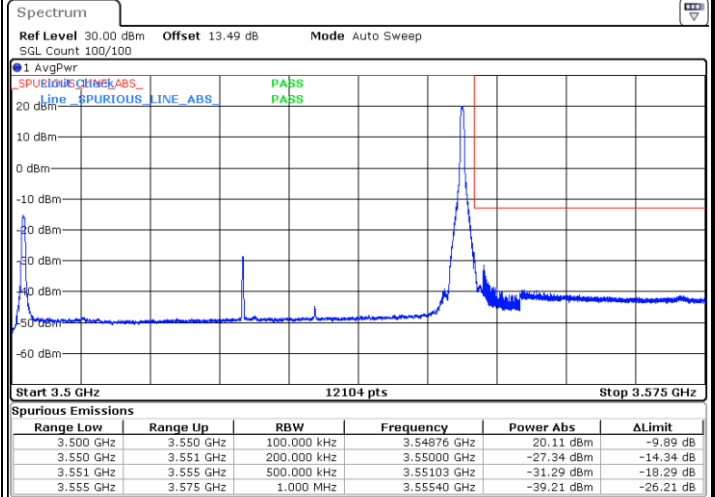
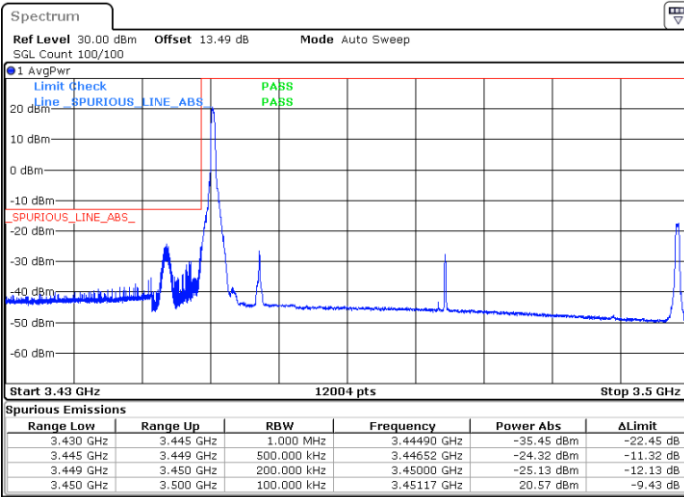

Date: 15.MAR.2022 02:17:30

Date: 15.MAR.2022 02:22:43

Lowest Band Edge / Full RB

Highest Band Edge / Full RB

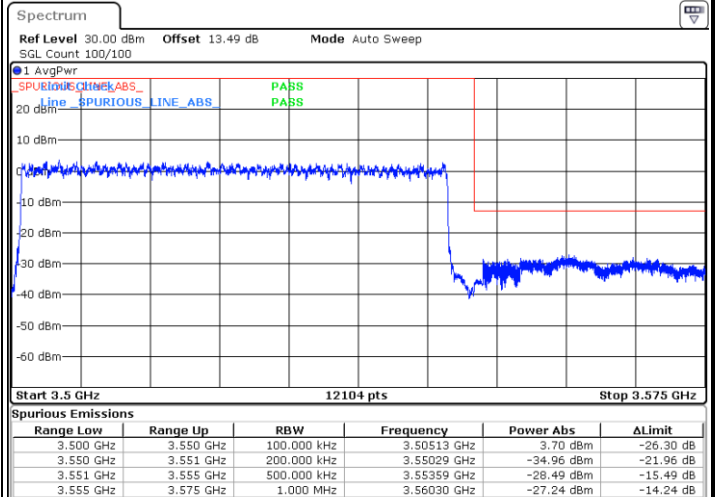
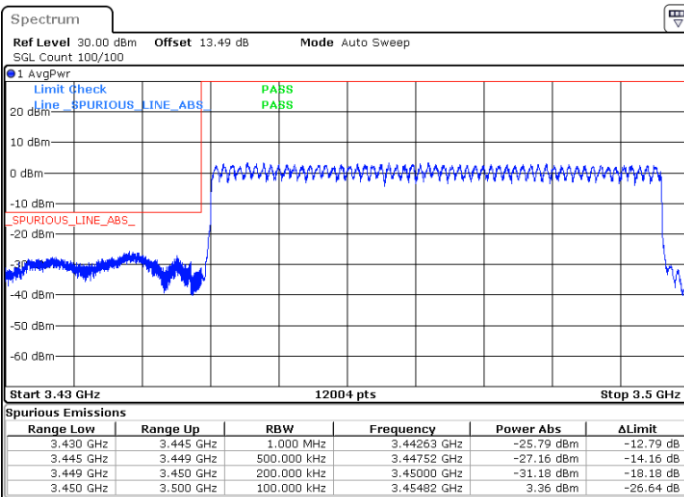

Date: 15.MAR.2022 02:11:12

Date: 15.MAR.2022 02:29:10





FR1 n78 / 50MHz / DFT-S OFDM / 16QAM

Lowest Band Edge / 1RB0

Highest Band Edge / 1RBmax

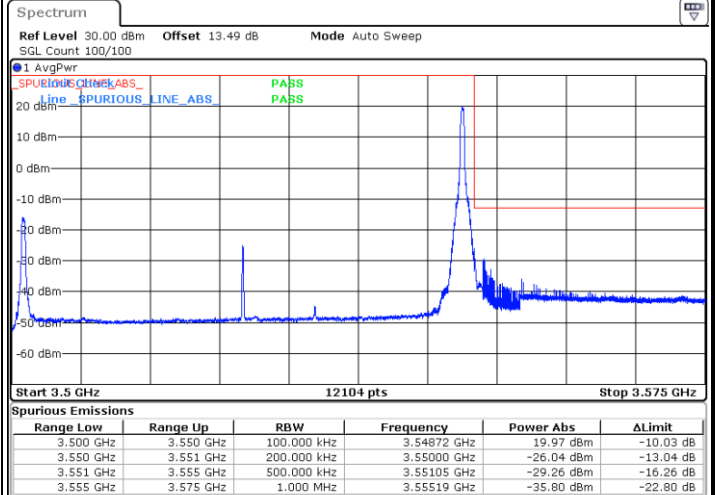
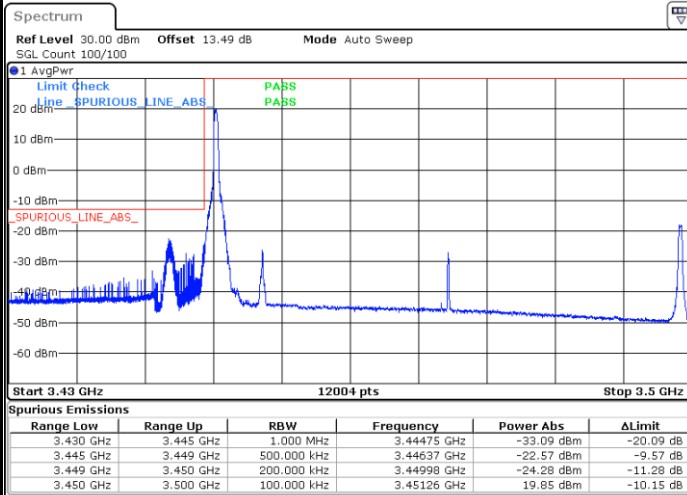

Date: 15.MAR.2022 02:16:41

Date: 15.MAR.2022 02:23:44

Lowest Band Edge / Full RB

Highest Band Edge / Full RB

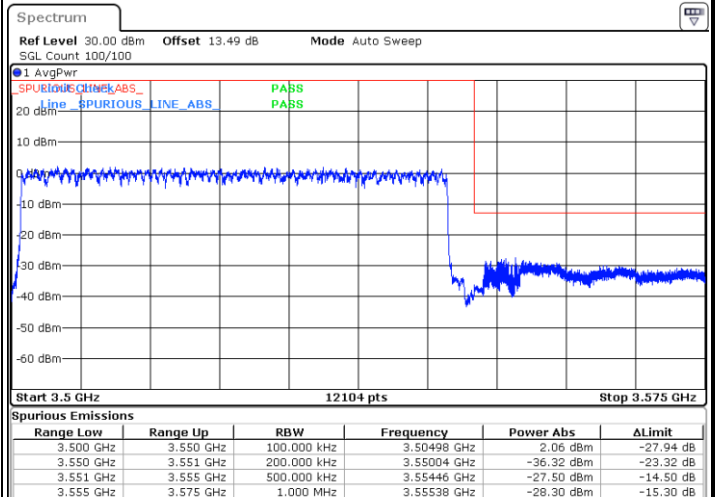
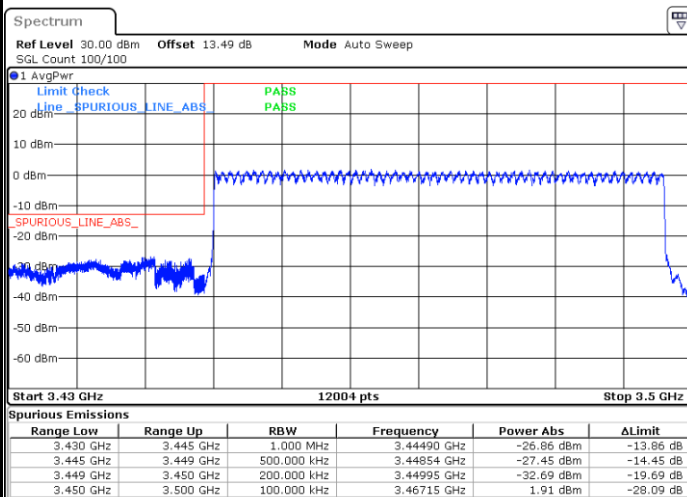

Date: 15.MAR.2022 02:11:54

Date: 15.MAR.2022 02:28:25