



# FCC RF Test Report

**APPLICANT** : Motorola Mobility LLC  
**EQUIPMENT** : Mobile Cellular Phone  
**BRAND NAME** : Motorola  
**MODEL NAME** : XT2229-3  
**FCC ID** : IHDT56AC7  
**STANDARD** : 47 CFR Part 2, 27(M)  
**CLASSIFICATION** : PCS Licensed Transmitter Held to Ear (PCE)  
**TEST DATE(S)** : Feb. 28, 2022 ~ Mar. 04, 2022

We, Sporton International Inc. (ShenZhen), would like to declare that the tested sample has been evaluated in accordance with the procedures given in ANSI C63.26-2015 and shown compliance with the applicable technical standards.

The test results in this report apply exclusively to the tested model / sample. Without written approval of Sporton International Inc. (ShenZhen), the test report shall not be reproduced except in full.

Reviewed by: Derreck Chen / Supervisor

Approved by: Eric Shih / Manager



**Sporton International Inc. (ShenZhen)**

**1/F, 2/F, Bldg 5, Shiling Industrial Zone, Xinwei Village, Xili, Nanshan, Shenzhen, 518055**

**People's Republic of China**



TABLE OF CONTENTS

REVISION HISTORY... 3
SUMMARY OF TEST RESULT ... 4
1 GENERAL DESCRIPTION ... 5
1.1 Applicant ... 5
1.2 Manufacturer ... 5
1.3 Product Feature of Equipment Under Test ... 5
1.4 Product Specification of Equipment Under Test ... 5
1.5 Modification of EUT ... 5
1.6 Maximum EIRP Power and Emission Designator ... 6
1.7 Testing Location ... 6
1.8 Test Software ... 7
1.9 Applicable Standards ... 7
1.10 Specification of Accessory ... 8
2 TEST CONFIGURATION OF EQUIPMENT UNDER TEST ... 9
2.1 Test Mode ... 9
2.2 Connection Diagram of Test System ... 10
2.3 Support Unit used in test configuration and system ... 10
2.4 Measurement Results Explanation Example ... 10
2.5 Frequency List of Low/Middle/High Channels ... 11
3 CONDUCTED TEST ITEMS ... 12
3.1 Measuring Instruments ... 12
3.2 Test Setup ... 12
3.3 Test Result of Conducted Test ... 12
3.4 Conducted Output Power and EIRP ... 13
3.5 Peak-to-Average Ratio ... 14
3.6 Occupied Bandwidth ... 15
3.7 Conducted Band Edge ... 16
3.8 Conducted Spurious Emission ... 17
3.9 Frequency Stability ... 18
4 RADIATED TEST ITEMS ... 19
4.1 Measuring Instruments ... 19
4.2 Test Setup ... 19
4.3 Test Result of Radiated Test ... 20
4.4 Radiated Spurious Emission ... 21
5 LIST OF MEASURING EQUIPMENT ... 22
6 UNCERTAINTY OF EVALUATION ... 23
APPENDIX A. TEST RESULTS OF CONDUCTED TEST
APPENDIX B. TEST RESULTS OF RADIATED TEST
APPENDIX C. TEST SETUP PHOTOGRAPHS





### SUMMARY OF TEST RESULT

Report Section	FCC Rule	Description	Limit	Result	Remark
3.4	§2.1046	Conducted Output Power	-	Report Only	-
	§27.50(h)(2)	Equivalent Isotropic Radiated Power (Band 41)	EIRP < 2Watt	PASS	-
3.5	N/A	Peak-to-Average Ratio	<13 dB	PASS	-
3.6	§2.1049	Occupied Bandwidth	-	Report Only	-
3.7	§27.53(m)(4)	Conducted Band Edge Measurement (Band 41)	§27.53(m)(4)	PASS	-
3.8	§2.1051 §27.53(m)(4)	Conducted Spurious Emission (Band 41)	< 55+10log <sub>10</sub> (P[Watts])	PASS	-
3.9	§2.1055 §27.54	Frequency Stability Temperature & Voltage	Within Authorized Band	PASS	-
4.4	§2.1053 §27.53(m)(4)	Radiated Spurious Emission (Band 41)	< 55+10log <sub>10</sub> (P[Watts])	PASS	Under limit 24.95 dB at 10336.360 MHz

**Declaration of Conformity:**

The test results with all measurement uncertainty excluded are presented in accordance with the regulation limits or requirements declared by manufacturers.

**Comments and Explanations:**

The declared of product specification for EUT presented in the report are provided by the manufacturer, and the manufacturer takes all the responsibilities for the accuracy of product specification.



# 1 General Description

## 1.1 Applicant

Motorola Mobility LLC  
222 W,Merchandise Mart Plaza,Chicago,IL60654 USA

## 1.2 Manufacturer

Motorola Mobility LLC  
222 W,Merchandise Mart Plaza,Chicago,IL60654 USA

## 1.3 Product Feature of Equipment Under Test

Product Feature	
Equipment	Mobile Cellular Phone
Brand Name	Motorola
Model Name	XT2229-3
FCC ID	IHDT56AC7
IMEI Code	Radiation: 350634170005864/350634170006722 for Sample 1 350634170007084/350634170007563 for Sample 2 Conducted: 350634170005484/350634170006342
HW Version	DVT2
SW Version	STA32.48
EUT Stage	Identical Prototype

## 1.4 Product Specification of Equipment Under Test

Standards-related Product Specification	
Tx Frequency	LTE Band 41 : 2496 MHz ~ 2690 MHz
Rx Frequency	LTE Band 41 : 2496 MHz ~ 2690 MHz
Bandwidth	LTE Band 41 : 5MHz / 10MHz / 15MHz / 20MHz
Maximum Output Power to Antenna	LTE Band 41 : 23.12 dBm
Antenna Gain	LTE Band 41 : -2.9 dBi
Type of Modulation	QPSK / 16QAM / 64QAM

## 1.5 Modification of EUT

No modifications are made to the EUT during all test items.



### 1.6 Maximum EIRP Power and Emission Designator

LTE Band 41		QPSK		16QAM/64QAM	
BW (MHz)	Frequency Range (MHz)	Maximum EIRP(W)	Emission Designator (99%OBW)	Maximum EIRP(W)	Emission Designator (99%OBW)
5	2498.5 ~ 2687.5	0.1030	4M50G7D	0.0883	4M51W7D
10	2501.0 ~ 2685.0	0.1052	9M07G7D	0.0904	9M07W7D
15	2503.5 ~ 2682.5	0.1050	13M5G7D	0.0883	13M6W7D
20	2506.0 ~ 2680.0	0.1033	17M9G7D	0.0891	17M9W7D

### 1.7 Testing Location

Sporton International Inc. (Shenzhen) is accredited to ISO/IEC 17025:2017 by American Association for Laboratory Accreditation with Certificate Number 5145.01.

<b>Test Firm</b>	Sporton International Inc. (Shenzhen)		
<b>Test Site Location</b>	1/F, 2/F, Bldg 5, Shiling Industrial Zone, Xinwei Village, Xili, Nanshan, Shenzhen, 518055 People's Republic of China TEL: +86-755-86379589 FAX: +86-755-86379595		
<b>Test Site No.</b>	<b>Sporton Site No.</b>	<b>FCC Designation No.</b>	<b>FCC Test Firm Registration No.</b>
	TH01-SZ	CN1256	421272

<b>Test Firm</b>	Sporton International Inc. (Shenzhen)		
<b>Test Site Location</b>	101, 1st Floor, Block B, Building 1, No. 2, Tengfeng 4th Road, Fenghuang Community, Fuyong Street, Baoan District, Shenzhen City Guangdong Province China 518103 TEL: +86-755-33202398		
<b>Test Site No.</b>	<b>Sporton Site No.</b>	<b>FCC Designation No.</b>	<b>FCC Test Firm Registration No.</b>
	03CH01-SZ	CN1256	421272



### 1.8 Test Software

Item	Site	Manufacture	Name	Version
1.	03CH01-SZ	AUDIX	E3	6.2009-8-24

### 1.9 Applicable Standards

According to the specifications of the manufacturer, the EUT must comply with the requirements of the following standards:

- ♦ 47 CFR Part 2, 27(M)
- ♦ ANSI C63.26-2015
- ♦ FCC KDB 971168 D01 Power Meas License Digital Systems v03r01
- ♦ FCC KDB 412172 D01 Determining ERP and EIRP v01r01

**Remark:**

1. All test items were verified and recorded according to the standards and without any deviation during the test.
2. This EUT has also been tested and complied with the requirements of FCC Part 15, Subpart B, recorded in a separate test report.



### 1.10 Specification of Accessory

Specification of Accessory				
AC Adapter 1(US)	Brand Name	Motorola(Chenyang)	Model Name	MC-201
AC Adapter 1(EU)	Brand Name	Motorola(Chenyang)	Model Name	MC-202
AC Adapter 1(AR)	Brand Name	Motorola(Chenyang)	Model Name	MC-206
AC Adapter 2(US)	Brand Name	Motorola(Acbel)	Model Name	MC-201
AC Adapter 2(EU)	Brand Name	Motorola(Acbel)	Model Name	MC-202
AC Adapter 2(AR)	Brand Name	Motorola(Acbel)	Model Name	MC-206
AC Adapter 2(CHILE)	Brand Name	Motorola(Acbel)	Model Name	MC-209
AC Adapter 3(IN)	Brand Name	Motorola(Chenyang)	Model Name	MC-204
AC Adapter 4(IN)	Brand Name	Motorola(Aohai)	Model Name	MC-204
AC Adapter 5(BR)	Brand Name	Motorola(Flex)	Model Name	MC-207
AC Adapter 6(BR)	Brand Name	Motorola(Salcomp)	Model Name	MC-207
AC Adapter 7(US)	Brand Name	Motorola(Chenyang)	Model Name	MC-101
AC Adapter 7(EU)	Brand Name	Motorola(Chenyang)	Model Name	MC-102
AC Adapter 7(UK)	Brand Name	Motorola(Chenyang)	Model Name	MC-103
AC Adapter 7(AU)	Brand Name	Motorola(Chenyang)	Model Name	MC-105
AC Adapter 8(US)	Brand Name	Motorola(Salcomp)	Model Name	MC-101
AC Adapter 8(EU)	Brand Name	Motorola(Salcomp)	Model Name	MC-102
AC Adapter 8(UK)	Brand Name	Motorola(Salcomp)	Model Name	MC-103
AC Adapter 8(AU)	Brand Name	Motorola(Salcomp)	Model Name	MC-105
AC Adapter 9(US)	Brand Name	Motorola(Aohai)	Model Name	MC-101
AC Adapter 9(EU)	Brand Name	Motorola(Aohai)	Model Name	MC-102
AC Adapter 9(UK)	Brand Name	Motorola(Aohai)	Model Name	MC-103
AC Adapter 10(IN)	Brand Name	Motorola(Chenyang)	Model Name	MC-104
AC Adapter 11(IN)	Brand Name	Motorola(Aohai)	Model Name	MC-104
AC Adapter 12(AU)	Brand Name	Motorola(Aohai)	Model Name	MC-105
AC Adapter 13(EU)	Brand Name	Motorola(Salom)	Model Name	SC-42
AC Adapter 14(UK)	Brand Name	Motorola(Chenyang)	Model Name	SC-43
Earphone 1	Brand Name	Motorola(Lyand)	Model Name	LYM239-76C-003
Earphone 2	Brand Name	Motorola(LCHSE)	Model Name	MEND1432B875000
Earphone 3	Brand Name	Motorola(New Leader)	Model Name	MH202
USB Cable 1	Brand Name	Motorola(Yihuaxing)	Model Name	T365-011B
USB Cable 2	Brand Name	Motorola (SUNTOPS)	Model Name	336258
USB Cable 3	Brand Name	Motorola (SUNTOPS)	Model Name	336281
USB Cable 4	Brand Name	Motorola (I SHENG)	Model Name	SC18D33506
USB Cable 5	Brand Name	Motorola (Yihuaxing)	Model Name	T365-012B
Battery 1	Brand Name	Motorola(Sunwoda)	Model Name	NH50
Battery 2	Brand Name	Motorola (SCUD)	Model Name	NH50





## 2 Test Configuration of Equipment Under Test

### 2.1 Test Mode

Antenna port conducted and radiated test items listed below are performed according to KDB 971168 D01 Power Meas License Digital Systems v03r01 with maximum output power.

Radiated measurements are performed by rotating the EUT in three different orthogonal test planes to find the maximum emission.

Test Items	Band	Bandwidth (MHz)						Modulation			RB #			Test Channel		
		1.4	3	5	10	15	20	QPSK	16QAM	64QAM	1	Half	Full	L	M	H
Max. Output Power	41	-	-	v	v	v	v	v	v	v	v	v	v	v	v	v
Peak-to-Average Ratio	41	-	-				v	v	v	v	v		v	v	v	v
26dB and 99% Bandwidth	41	-	-	v	v	v	v	v	v	v			v	v	v	v
Conducted Band Edge	41	-	-	v	v	v	v	v	v	v	v		v	v		v
Conducted Spurious Emission	41	-	-	v	v	v	v	v	v	v	v			v	v	v
Frequency Stability	41	-	-		v			v					v		v	
E.R.P / E.I.R.P	41	-	-	v	v	v	v	v	v	v	v			v	v	v
Radiated Spurious Emission	41	<b>Worst Case</b>												v		
Note	<ol style="list-style-type: none"> <li>The mark "v " means that this configuration is chosen for testing</li> <li>The mark "- " means that this bandwidth is not supported.</li> <li>The device is investigated from 30MHz to 10 times of fundamental signal for radiated spurious emission test under different RB size/offset and modulations in exploratory test. Subsequently, only the worst case emissions are reported.</li> </ol>															

## 2.2 Connection Diagram of Test System

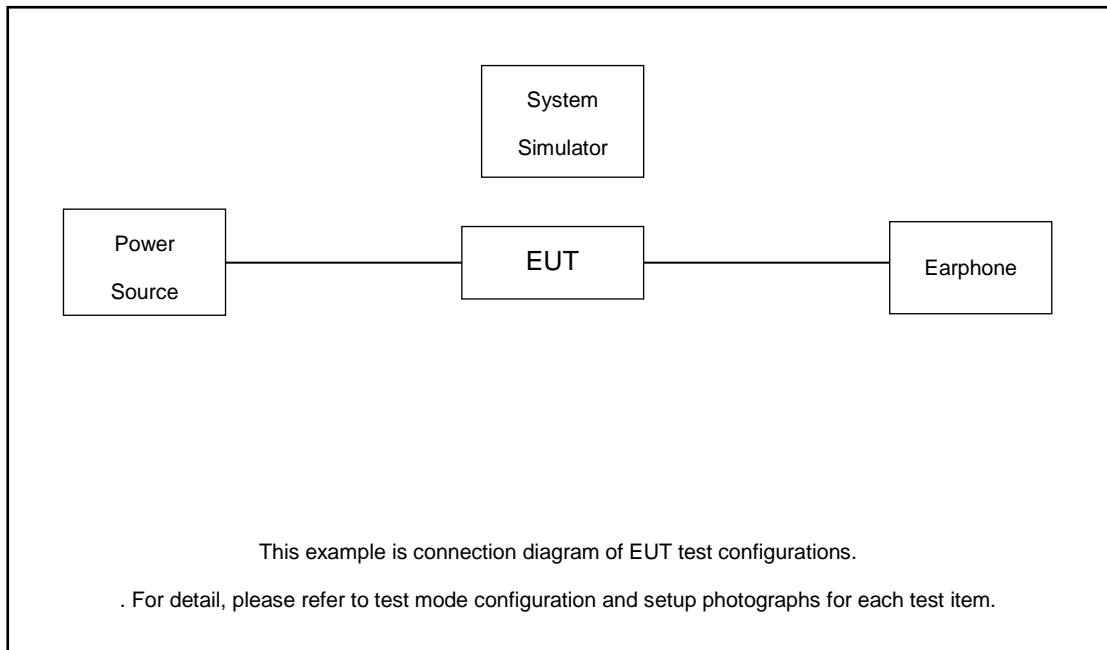

## 2.3 Support Unit used in test configuration and system

Item	Equipment	Trade Name	Model No.	FCC ID	Data Cable	Power Cord
1.	Power Supply	GWINSTEK	GPS-3030D	N/A	N/A	Unshielded, 1.8 m
2.	LTE Base Station	Anritsu	MT8820C	N/A	N/A	Unshielded, 1.8 m

## 2.4 Measurement Results Explanation Example

### For all conducted test items:

The offset level is set in the spectrum analyzer to compensate the RF cable loss and attenuator factor between EUT conducted output port and spectrum analyzer. With the offset compensation, the spectrum analyzer reading level is exactly the EUT RF output level.

The spectrum analyzer offset is derived from RF cable loss and attenuator factor.

$$\text{Offset} = \text{RF cable loss} + \text{attenuator factor}.$$

Following shows an offset computation example with cable loss 5.0 dB and 10dB attenuator.

Example :

$$\begin{aligned} \text{Offset(dB)} &= \text{RF cable loss(dB)} + \text{attenuator factor(dB)}. \\ &= 5.0 + 10 = 15.0 \text{ (dB)} \end{aligned}$$



## 2.5 Frequency List of Low/Middle/High Channels

LTE Band 41 Channel and Frequency List				
BW [MHz]	Channel/Frequency(MHz)	Lowest	Middle	Highest
20	Channel	39750	40620	41490
	Frequency	2506	2593	2680
15	Channel	39725	40620	41515
	Frequency	2503.5	2593	2682.5
10	Channel	39700	40620	41540
	Frequency	2501	2593	2685
5	Channel	39675	40620	41565
	Frequency	2498.5	2593	2687.5

### 3 Conducted Test Items

#### 3.1 Measuring Instruments

See list of measuring instruments of this test report.

#### 3.2 Test Setup

##### 3.2.1 Conducted Output Power



##### 3.2.2 Peak-to-Average Ratio, Occupied Bandwidth ,Conducted Band-Edge and Conducted Spurious Emission

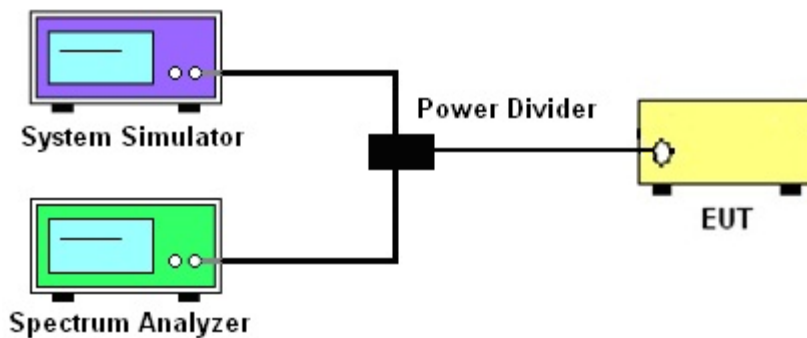

##### 3.2.3 Frequency Stability

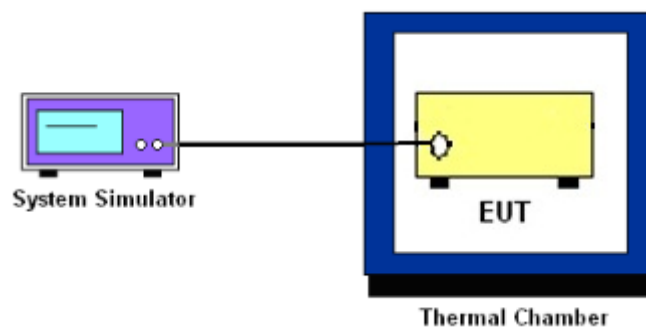

### 3.3 Test Result of Conducted Test

Please refer to Appendix A.



### 3.4 Conducted Output Power and EIRP

#### 3.4.1 Description of the Conducted Output Power Measurement and EIRP Measurement

A system simulator was used to establish communication with the EUT. Its parameters were set to force the EUT transmitting at maximum output power. The measured power in the radio frequency on the transmitter output terminals shall be reported.

The EIRP of mobile transmitters must not exceed 2 Watts for LTE Band 41.

According to KDB 412172 D01 Power Approach,

$EIRP = P_T + G_T - L_C$ ,  $ERP = EIRP - 2.15$ , where

$P_T$  = transmitter output power in dBm

$G_T$  = gain of the transmitting antenna in dBi

$L_C$  = signal attenuation in the connecting cable between the transmitter and antenna in dB

#### 3.4.2 Test Procedures

1. The testing follows ANSI C63.26 Section 5.2
2. The transmitter output port was connected to the system simulator.
3. Set EUT at maximum power through the system simulator.
4. Select lowest, middle, and highest channels for each band and different modulation.
5. Measure and record the power level from the system simulator.



## **3.5 Peak-to-Average Ratio**

### **3.5.1 Description of the PAR Measurement**

Power Complementary Cumulative Distribution Function (CCDF) curves provide a means for characterizing the power peaks of a digitally modulated signal on a statistical basis. A CCDF curve depicts the probability of the peak signal amplitude exceeding the average power level. Most contemporary measurement instrumentation include the capability to produce CCDF curves for an input signal provided that the instrument's resolution bandwidth can be set wide enough to accommodate the entire input signal bandwidth. In measuring transmissions in this band using an average power technique, the peak-to-average ratio (PAR) of the transmission may not exceed 13 dB.

### **3.5.2 Test Procedures**

1. The testing follows ANSI C63.26 Section 5.2.3.4 (CCDF).
2. The EUT was connected to spectrum and system simulator via a power divider.
3. Set the CCDF (Complementary Cumulative Distribution Function) option in spectrum analyzer.
4. The highest RF powers were measured and recorded the maximum PAPR level associated with a probability of 0.1 %.
5. Record the deviation as Peak to Average Ratio.



### 3.6 Occupied Bandwidth

#### 3.6.1 Description of Occupied Bandwidth Measurement

The occupied bandwidth is the width of a frequency band such that, below the lower and above the upper frequency limits, the mean powers emitted are each equal to a specified percentage 0.5% of the total mean transmitted power.

The 26 dB emission bandwidth is defined as the frequency range between two points, one above and one below the carrier frequency, at which the spectral density of the emission is attenuated 26 dB below the maximum in-band spectral density of the modulated signal. Spectral density (power per unit bandwidth) is to be measured with a detector of resolution bandwidth equal to approximately 1.0% of the emission bandwidth.

#### 3.6.2 Test Procedures

1. The testing follows ANSI C63.26 Section 5.4
2. The EUT was connected to spectrum analyzer and system simulator via a power divider.
3. The spectrum analyzer center frequency is set to the nominal EUT channel center frequency. The span range for the spectrum analyzer shall be between two and five times the anticipated OBW.
4. The nominal resolution bandwidth (RBW) shall be in the range of 1 to 5 % of the anticipated OBW, and the VBW shall be at least 3 times the RBW.
5. Set the detection mode to peak, and the trace mode to max hold.
6. Determine the reference value: Set the EUT to transmit a modulated signal. Allow the trace to stabilize. Set the spectrum analyzer marker to the highest level of the displayed trace.  
(this is the reference value)
7. Determine the “-26 dB down amplitude” as equal to (Reference Value – X).
8. Place two markers, one at the lowest and the other at the highest frequency of the envelope of the spectral display such that each marker is at or slightly below the “-X dB down amplitude” determined in step 6. If a marker is below this “-X dB down amplitude” value it shall be placed as close as possible to this value. The OBW is the positive frequency difference between the two markers.
9. Use the 99 % power bandwidth function of the spectrum analyzer and report the measured bandwidth.



### 3.7 Conducted Band Edge

#### 3.7.1 Description of Conducted Band Edge Measurement

27.53(m)(4)

For mobile digital stations, the attenuation factor shall be not less than  $40 + 10 \log (P)$  dB on all frequencies between the channel edge and 5 megahertz from the channel edge,  $43 + 10 \log (P)$  dB on all frequencies between 5 megahertz and X megahertz from the channel edge, and  $55 + 10 \log (P)$  dB on all frequencies more than X megahertz from the channel edge, where X is the greater of 6 megahertz or the actual emission bandwidth as defined in paragraph (m)(6) of this section. In addition, the attenuation factor shall not be less that  $43 + 10 \log (P)$  dB on all frequencies between 2490.5 MHz and 2496 MHz and  $55 + 10 \log (P)$  dB at or below 2490.5 MHz. Mobile Satellite Service licensees operating on frequencies below 2495 MHz may also submit a documented interference complaint against BRS licensees operating on channel BRS Channel 1 on the same terms and conditions as adjacent channel BRS or EBS licensees.

#### 3.7.2 Test Procedures

1. The testing follows ANSI C63.26 section 5.7
2. The EUT was connected to spectrum analyzer and system simulator via a power divider.
3. The band edges of low and high channels for the highest RF powers were measured.
4. Set RBW  $\geq$  1% EBW in the 1MHz band immediately outside and adjacent to the band edge.
5. Beyond the 1 MHz band from the band edge, RBW=1MHz was used or a narrower RBW was used and the measured power was integrated over the full required measurement bandwidth of 1 MHz.
6. Set spectrum analyzer with RMS detector.
7. The RF fundamental frequency should be excluded against the limit line in the operating frequency band.
8. Checked that all the results comply with the emission limit line.

Example:

The limit line is derived from  $43 + 10\log(P)$ dB below the transmitter power P(Watts)  
 $= P(W) - [43 + 10\log(P)]$  (dB)  
 $= [30 + 10\log(P)]$  (dBm) -  $[43 + 10\log(P)]$  (dB) = -13dBm.

9. For LTE Band 7, 38, 41, the other 40 dB, and 55 dB have additionally applied same calculation above.
10. When using the integration method, the starting frequency of the integration shall be centered at one-half of the RBW away from the band edge.





### 3.8 Conducted Spurious Emission

#### 3.8.1 Description of Conducted Spurious Emission Measurement

For Band 41:

The power of any emission outside of the authorized operating frequency ranges must be lower than the transmitter power (P) by a factor of at least  $55 + 10 \log (P)$  dB.

It is measured by means of a calibrated spectrum analyzer and scanned from 30 MHz up to a frequency including its 10<sup>th</sup> harmonic.

#### 3.8.2 Test Procedures

1. The testing follows ANSI C63.26 section 5.7
2. The EUT was connected to spectrum analyzer and system simulator via a power divider.
3. The RF output of EUT was connected to the spectrum analyzer by RF cable and attenuator. The path loss was compensated to the results for each measurement.
4. The middle channel for the highest RF power within the transmitting frequency was measured.
5. The conducted spurious emission for the whole frequency range was taken.
6. Make the measurement with the spectrum analyzer's RBW = 1MHz, VBW = 3MHz.
7. Set spectrum analyzer with RMS detector.
8. Taking the record of maximum spurious emission.
9. The RF fundamental frequency should be excluded against the limit line in the operating frequency band.

10. For Band 41

The limit line is derived from  $55 + 10\log(P)$ dB below the transmitter power P(Watts)  
= P(W)- [55+ 10log(P)] (dB)  
= [30+ 10log(P)] (dBm) - [55+ 10log(P)] (dB)  
= -25dBm.



### 3.9 Frequency Stability

#### 3.9.1 Description of Frequency Stability Measurement

The frequency stability shall be measured by variation of ambient temperature and variation of primary supply voltage to ensure that the fundamental emission stays within the authorized frequency block. The frequency stability of the transmitter shall be maintained within  $\pm 0.00025\%$  ( $\pm 2.5\text{ppm}$ ) of the center frequency.

#### 3.9.2 Test Procedures for Temperature Variation

1. The testing follows ANSI C63.26 section 5.6.4
2. The EUT was set up in the thermal chamber and connected with the system simulator.
3. With power OFF, the temperature was decreased to  $-30^{\circ}\text{C}$  and the EUT was stabilized before testing. Power was applied and the maximum change in frequency was recorded within one minute.
4. With power OFF, the temperature was raised in  $10^{\circ}\text{C}$  step up to  $50^{\circ}\text{C}$ . The EUT was stabilized at each step for at least half an hour. Power was applied and the maximum frequency change was recorded within one minute.

#### 3.9.3 Test Procedures for Voltage Variation

1. The testing follows ANSI C63.26 section 5.6.5
2. The EUT was placed in a temperature chamber at  $20\pm 5^{\circ}\text{C}$  and connected with the system simulator.
3. The power supply voltage to the EUT was varied from 85% to 115% of the nominal value for other than hand carried battery equipment.
4. For hand carried, battery powered equipment, reduce the primary ac or dc supply voltage to the battery operating end point, which shall be specified by the manufacturer.
5. The variation in frequency was measured for the worst case.

## 4 Radiated Test Items

### 4.1 Measuring Instruments

See list of measuring instruments of this test report.

### 4.2 Test Setup

#### 4.2.1 For radiated test below 30MHz

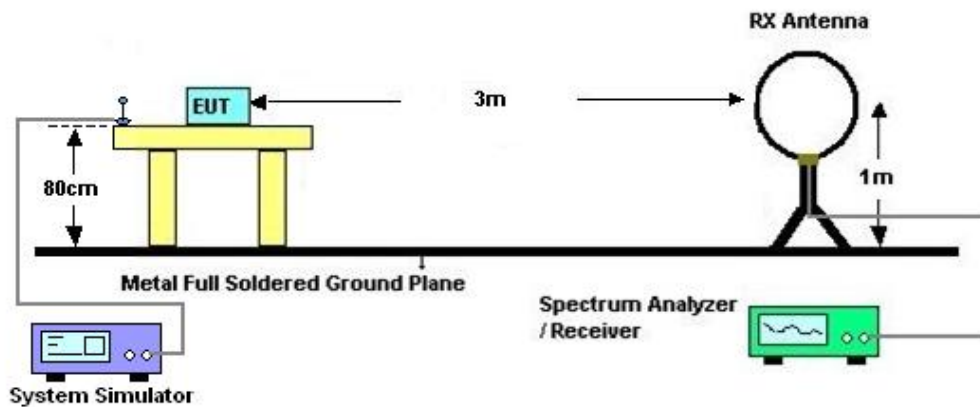

#### 4.2.2 For radiated test from 30MHz to 1GHz

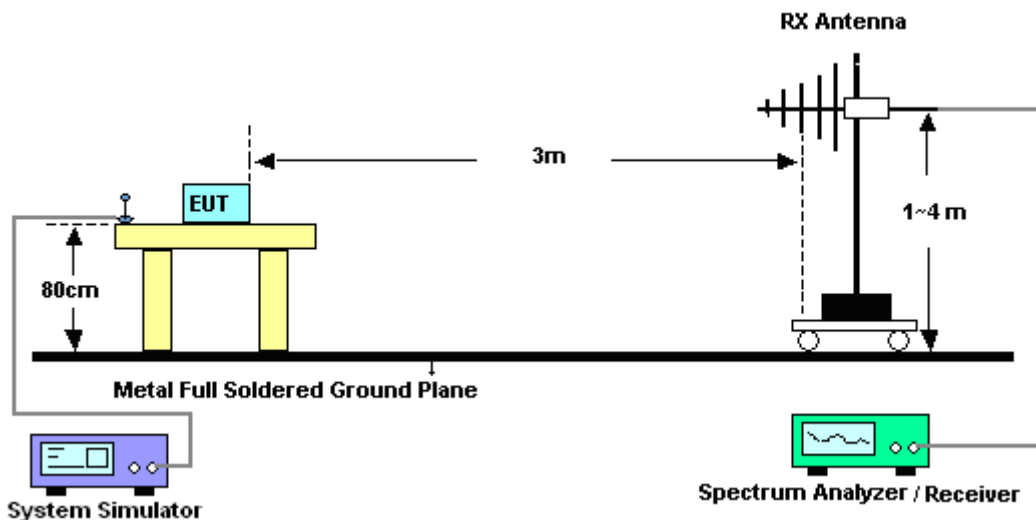

#### 4.2.3 For radiated test above 1GHz

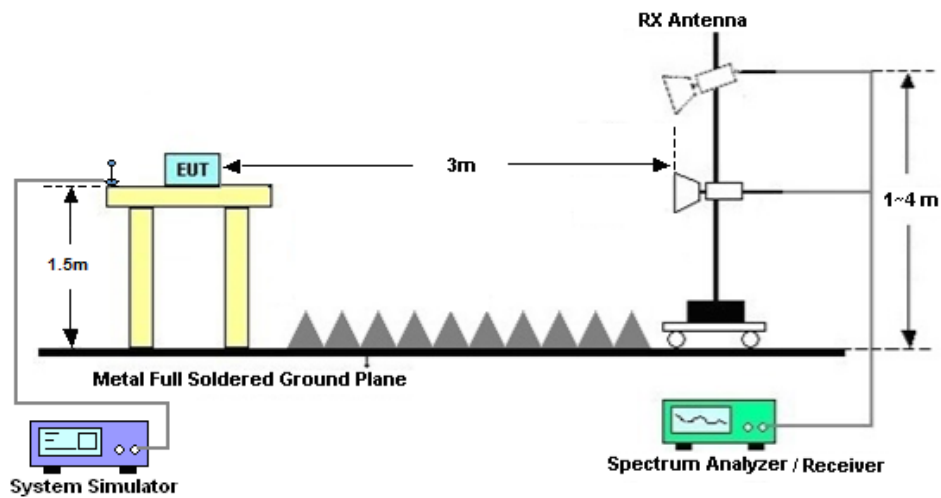

#### 4.3 Test Result of Radiated Test

The low frequency, which started from 9 kHz to 30MHz, was pre-scanned and the result which was 20dB lower than the limit line was not reported.

Please refer to Appendix B.



## 4.4 Radiated Spurious Emission

### 4.4.1 Description of Radiated Spurious Emission

The radiated spurious emission was measured by substitution method according to ANSI C63.26.

For Band 41

The power of any emission outside of the authorized operating frequency ranges must be attenuated below the transmitter power (P) by a factor of at least  $55 + 10 \log(P)$  dB.

The spectrum is scanned from 30 MHz up to a frequency including its 10th harmonic.

### 4.4.2 Test Procedures

1. The testing follows ANSI C63.26 Section 5.5
2. The EUT was placed on a turntable with 0.8 meter height for frequency below 1GHz and 1.5 meter height for frequency above 1GHz respectively above ground.
3. The EUT was set 3 meters from the receiving antenna mounted on the antenna tower.
4. The table was rotated 360 degrees to determine the position of the highest spurious emission.
5. The height of the receiving antenna is varied between 1m to 4m to search the maximum spurious emission for both horizontal and vertical polarizations.
6. During the measurement, the system simulator parameters were set to force the EUT transmitting at maximum output power.
7. Make the measurement with the spectrum analyzer's RBW = 1MHz, VBW = 3MHz, taking the record of maximum spurious emission.
8. A horn antenna was substituted in place of the EUT and was driven by a signal generator.
9. Tune the output power of signal generator to the same emission level with EUT maximum spurious emission.
10.  $EIRP (dBm) = S.G. Power - Tx Cable Loss + Tx Antenna Gain$
11.  $ERP (dBm) = EIRP - 2.15$
12. The RF fundamental frequency should be excluded against the limit line in the operating frequency band.

The limit line is derived from  $43 + 10\log(P)$ dB below the transmitter power P(Watts)  
 $= P(W) - [43 + 10\log(P)] (dB)$   
 $= [30 + 10\log(P)] (dBm) - [43 + 10\log(P)] (dB)$   
 $= -13dBm.$

13. For Band 41:

The limit line is derived from  $55 + 10\log(P)$ dB below the transmitter power P(Watts)



## 5 List of Measuring Equipment

Instrument	Manufacturer	Model No.	Serial No.	Characteristics	Calibration Date	Test Date	Due Date	Remark
Spectrum Analyzer	R&S	FSV40	101078	10Hz~40GHz	Apr. 08, 2021	Mar. 03, 2022~ Mar. 04, 2022	Apr. 07, 2022	Conducted (TH01-SZ)
Power Divider	TOJOIN	PS-2SM-04 265	60.06.020.007 7	0.4GHz~26.5GHz	Dec. 25, 2021	Mar. 03, 2022~ Mar. 04, 2022	Dec. 24, 2022	Conducted (TH01-SZ)
Thermal Chamber	Ten Billion Hongzhangroup	LP-150U	H2014081803	-40~+150°C	Jul. 14, 2021	Mar. 03, 2022~ Mar. 04, 2022	Jul. 13, 2022	Conducted (TH01-SZ)
EMI Test Receiver&SA	Agilent	N9038A	MY52260185	20Hz~26.5GHz	Dec. 02, 2021	Feb. 28, 2022	Dec. 01, 2022	Radiation (03CH01-SZ)
Loop Antenna	R&S	HFH2-Z2	100354	9kHz~30MHz	Jun. 22, 2021	Feb. 28, 2022	Jun. 21, 2022	Radiation (03CH01-SZ)
HF Amplifier	KEYSIGHT	83017A	MY53270105	0.5GHz~26.5GHz	Oct. 16, 2021	Feb. 28, 2022	Oct. 15, 2022	Radiation (03CH01-SZ)
Bilog Antenna	TeseQ	CBL6112D	35407	30MHz-2GHz	Jul. 15, 2021	Feb. 28, 2022	Jul. 14, 2022	Radiation (03CH01-SZ)
Double Ridge Horn Antenna	ETS-Lindgren	3117	00119436	1GHz~18GHz	Jul. 25, 2021	Feb. 28, 2022	Jul. 24, 2022	Radiation (03CH01-SZ)
SHF-EHF Horn	com-power	AH-840	101071	18GHz-40GHz	Apr. 11, 2021	Feb. 28, 2022	Apr. 10, 2022	Radiation (03CH01-SZ)
LF Amplifier	Burgeon	BPA-530	102209	0.01~3000Mhz	Apr. 07, 2021	Feb. 28, 2022	Apr. 06, 2022	Radiation (03CH01-SZ)
HF Amplifier	MITEQ	AMF-7D-00 101800-30-1 0P-R	1943528	1GHz~18GHz	Oct. 15, 2021	Feb. 28, 2022	Oct. 14, 2022	Radiation (03CH01-SZ)
HF Amplifier	MITEQ	TTA1840-35 -HG	1871923	18GHz~40GHz	Jul. 21, 2021	Feb. 28, 2022	Jul. 20, 2022	Radiation (03CH01-SZ)
AC Power Source	Chroma	61601	616010001985	N/A	NCR	Feb. 28, 2022	NCR	Radiation (03CH01-SZ)
Turn Table	EM	EM1000	N/A	0~360 degree	NCR	Feb. 28, 2022	NCR	Radiation (03CH01-SZ)
Antenna Mast	EM	EM1000	N/A	1 m~4 m	NCR	Feb. 28, 2022	NCR	Radiation (03CH01-SZ)

NCR: No Calibration Required



## 6 Uncertainty of Evaluation

The measurement uncertainties shown below were calculated in accordance with the requirements of ANSI 63.26-2015. All the measurement uncertainty value were shown with a coverage K=2 to indicate 95% level of confidence. The measurement data show herein meets or exceeds the CISPR measurement uncertainty values specified in CISPR 16-4-2 and can be compared directly to specified limit to determine compliance.

### Uncertainty of Radiated Emission Measurement (30 MHz ~ 1000 MHz)

Measuring Uncertainty for a Level of Confidence of 95% (U = 2Uc(y))	2.48dB
---	--------

### Uncertainty of Radiated Emission Measurement (1 GHz ~ 18 GHz)

Measuring Uncertainty for a Level of Confidence of 95% (U = 2Uc(y))	3.53dB
---	--------

### Uncertainty of Radiated Emission Measurement (18 GHz ~ 40 GHz)

Measuring Uncertainty for a Level of Confidence of 95% (U = 2Uc(y))	4.02dB
---	--------



### Appendix A. Test Results of Conducted Test

Test Engineer :	Sam Zheng	Temperature :	24~26°C
		Relative Humidity :	50~53%

### Conducted Output Power(Average power)

BW [MHz]	Modulation	RB Size	RB Offset	Power Low Ch. / Freq.	Power Middle Ch. / Freq.	Power High Ch. / Freq.
Channel				39750	40620	41490
Frequency (MHz)				2506	2593	2680
20	QPSK	1	0	22.99	22.88	22.86
20	QPSK	1	49	23.04	23.03	23.01
20	QPSK	1	99	22.97	22.80	22.82
20	QPSK	50	0	22.09	22.09	22.08
20	QPSK	50	24	22.06	22.05	22.06
20	QPSK	50	50	22.06	22.04	22.06
20	QPSK	100	0	22.01	22.01	22.04
20	16QAM	1	0	22.03	22.11	22.05
20	16QAM	1	49	22.40	22.38	22.36
20	16QAM	1	99	22.10	22.06	22.07
20	16QAM	50	0	21.06	21.09	21.00
20	16QAM	50	24	21.07	21.12	21.16
20	16QAM	50	50	21.12	21.08	21.08
20	16QAM	100	0	21.12	21.12	21.06
20	64QAM	1	0	20.88	20.84	20.92
20	64QAM	1	49	21.18	21.19	21.17
20	64QAM	1	99	20.94	20.96	20.86
20	64QAM	50	0	20.06	20.06	20.04
20	64QAM	50	24	20.11	20.11	20.13
20	64QAM	50	50	20.18	20.09	20.05
20	64QAM	100	0	20.12	20.14	20.13
Channel				39725	40620	41515
Frequency (MHz)				2503.5	2593	2682.5





15	QPSK	1	0	22.94	23.01	22.93
15	QPSK	1	37	23.11	23.08	23.05
15	QPSK	1	74	22.98	22.87	23.04
15	QPSK	36	0	22.00	22.10	22.03
15	QPSK	36	20	22.10	22.02	22.19
15	QPSK	36	39	22.05	22.09	22.13
15	QPSK	75	0	22.07	22.04	22.09
15	16QAM	1	0	22.15	22.16	22.19
15	16QAM	1	37	22.35	22.33	22.36
15	16QAM	1	74	22.28	22.17	22.15
15	16QAM	36	0	21.03	21.01	21.07
15	16QAM	36	20	21.07	21.00	21.09
15	16QAM	36	39	21.01	21.03	21.09
15	16QAM	75	0	21.10	21.14	21.15
15	64QAM	1	0	21.07	21.08	21.03
15	64QAM	1	37	21.16	21.14	21.14
15	64QAM	1	74	21.18	21.03	21.11
15	64QAM	36	0	20.10	20.11	20.14
15	64QAM	36	20	20.15	20.12	20.18
15	64QAM	36	39	20.11	20.09	20.15
15	64QAM	75	0	20.14	20.10	20.15
Channel				39700	40620	41540
Frequency (MHz)				2501	2593	2685
10	QPSK	1	0	22.95	23.00	23.09
10	QPSK	1	25	23.05	23.08	23.12
10	QPSK	1	49	23.06	23.01	23.02
10	QPSK	25	0	22.15	22.14	22.20
10	QPSK	25	12	22.17	22.13	22.19
10	QPSK	25	25	22.16	22.15	22.22
10	QPSK	50	0	22.14	22.16	22.23
10	16QAM	1	0	22.24	22.34	22.31
10	16QAM	1	25	22.46	22.43	22.45
10	16QAM	1	49	22.34	22.29	22.36
10	16QAM	25	0	21.22	21.21	21.23
10	16QAM	25	12	21.16	21.20	21.26
10	16QAM	25	25	21.27	21.24	21.17



10	16QAM	50	0	21.16	21.19	21.19
10	64QAM	1	0	21.05	21.17	21.26
10	64QAM	1	25	21.33	21.25	21.31
10	64QAM	1	49	21.17	21.12	21.15
10	64QAM	25	0	20.31	20.26	20.34
10	64QAM	25	12	20.24	20.32	20.31
10	64QAM	25	25	20.26	20.24	20.32
10	64QAM	50	0	20.23	20.19	20.19
Channel				39675	40620	41565
Frequency (MHz)				2498.5	2593	2687.5
5	QPSK	1	0	22.82	22.82	22.86
5	QPSK	1	12	22.95	23.01	23.03
5	QPSK	1	24	22.83	22.81	22.90
5	QPSK	12	0	21.92	22.13	22.15
5	QPSK	12	7	22.05	22.08	22.13
5	QPSK	12	13	22.07	22.04	22.09
5	QPSK	25	0	22.02	22.01	22.06
5	16QAM	1	0	22.11	22.15	22.29
5	16QAM	1	12	22.21	22.34	22.36
5	16QAM	1	24	22.11	22.22	22.27
5	16QAM	12	0	21.14	21.04	21.14
5	16QAM	12	7	21.16	21.18	21.17
5	16QAM	12	13	21.06	21.05	21.18
5	16QAM	25	0	21.11	21.17	21.17
5	64QAM	1	0	21.05	21.12	21.13
5	64QAM	1	12	21.16	21.17	21.24
5	64QAM	1	24	21.10	20.99	21.12
5	64QAM	12	0	20.08	20.04	20.21
5	64QAM	12	7	20.14	20.10	20.22
5	64QAM	12	13	20.13	20.10	20.17
5	64QAM	25	0	20.17	20.20	20.19



**EIRP**

LTE Band 41 (G <sub>T</sub> - L <sub>C</sub> = -2.9dB) QPSK									
Bandwidth	5M			10M			15M		
Channel	40065	40640	41215	40090	40640	41190	40115	40640	41165
	(Low)	(Mid)	(High)	(Low)	(Mid)	(High)	(Low)	(Mid)	(High)
Frequency	2537.5	2595	2652.5	2540	2595	2650	2542.5	2595	2647.5
(MHz)									
Conducted Power (dBm)	22.95	23.01	23.03	23.05	23.08	23.12	23.11	23.08	23.05
Conducted Power (Watts)	0.1972	0.2000	0.2009	0.2018	0.2032	0.2051	0.2046	0.2032	0.2018
EIRP(dBm)	20.05	20.11	20.13	20.15	20.18	20.22	20.21	20.18	20.15
EIRP(Watts)	0.1012	0.1026	0.1030	0.1035	0.1042	0.1052	0.1050	0.1042	0.1035

LTE Band 41 (G <sub>T</sub> - L <sub>C</sub> = -2.9dB) QPSK			
Bandwidth	20M		
Channel	40140	40640	41140
	(Low)	(Mid)	(High)
Frequency	2545	2595	2645
(MHz)			
Conducted Power (dBm)	23.04	23.03	23.01
Conducted Power (Watts)	0.2014	0.2009	0.2000
EIRP(dBm)	20.14	20.13	20.11
EIRP(Watts)	0.1033	0.1030	0.1026



LTE Band 41 (G <sub>T</sub> - L <sub>C</sub> = -2.9dB) 16QAM									
Bandwidth	5M			10M			15M		
Channel	40065	40640	41215	40090	40640	41190	40115	40640	41165
	(Low)	(Mid)	(High)	(Low)	(Mid)	(High)	(Low)	(Mid)	(High)
Frequency (MHz)	2537.5	2595	2652.5	2540	2595	2650	2542.5	2595	2647.5
Conducted Power (dBm)	22.21	22.34	22.36	22.46	22.43	22.45	22.35	22.33	22.36
Conducted Power (Watts)	0.1663	0.1714	0.1722	0.1762	0.1750	0.1758	0.1718	0.1710	0.1722
EIRP(dBm)	19.31	19.44	19.46	19.56	19.53	19.55	19.45	19.43	19.46
EIRP(Watts)	0.0853	0.0879	0.0883	0.0904	0.0897	0.0902	0.0881	0.0877	0.0883

LTE Band 41 (G <sub>T</sub> - L <sub>C</sub> = -2.9dB) 16QAM			
Bandwidth	20M		
Channel	40140	40640	41140
	(Low)	(Mid)	(High)
Frequency (MHz)	2545	2595	2645
Conducted Power (dBm)	22.40	22.38	22.36
Conducted Power (Watts)	0.1738	0.1730	0.1722
EIRP(dBm)	19.50	19.48	19.46
EIRP(Watts)	0.0891	0.0887	0.0883



LTE Band 41 (G <sub>T</sub> - L <sub>C</sub> = -2.9dB) 64QAM									
Bandwidth	5M			10M			15M		
Channel	40065	40640	41215	40090	40640	41190	40115	40640	41165
	(Low)	(Mid)	(High)	(Low)	(Mid)	(High)	(Low)	(Mid)	(High)
Frequency	2537.5	2595	2652.5	2540	2595	2650	2542.5	2595	2647.5
(MHz)									
Conducted Power (dBm)	21.16	21.17	21.24	21.33	21.25	21.31	21.18	21.03	21.11
Conducted Power (Watts)	0.1306	0.1309	0.1330	0.1358	0.1334	0.1352	0.1312	0.1268	0.1291
EIRP(dBm)	18.26	18.27	18.34	18.43	18.35	18.41	18.28	18.13	18.21
EIRP(Watts)	0.0670	0.0671	0.0682	0.0697	0.0684	0.0693	0.0673	0.0650	0.0662

LTE Band 41 (G <sub>T</sub> - L <sub>C</sub> = -2.9dB) 64QAM			
Bandwidth	20M		
Channel	40140	40640	41140
	(Low)	(Mid)	(High)
Frequency	2545	2595	2645
(MHz)			
Conducted Power (dBm)	21.18	21.19	21.17
Conducted Power (Watts)	0.1312	0.1315	0.1309
EIRP(dBm)	18.28	18.29	18.27
EIRP(Watts)	0.0673	0.0675	0.0671



# LTE Band 41

## Peak-to-Average Ratio

Mode	LTE Band 41 / 20MHz				
Mod.	QPSK		16QAM		Limit: 13dB
RB Size	1RB	Full RB	1RB	Full RB	Result
Lowest CH	6.43	6.61	6.81	6.49	PASS
Middle CH	6.70	6.87	7.33	6.75	
Highest CH	6.32	5.97	7.28	7.22	
Mode	LTE Band 41 / 20MHz				
Mod.	64QAM				Limit: 13dB
RB Size	1RB	Full RB			Result
Lowest CH	6.61	7.04	-	-	PASS
Middle CH	6.96	7.42	-	-	
Highest CH	6.61	6.90	-	-	



LTE Band 41 / 20MHz / QPSK

Lowest Channel / 1RB

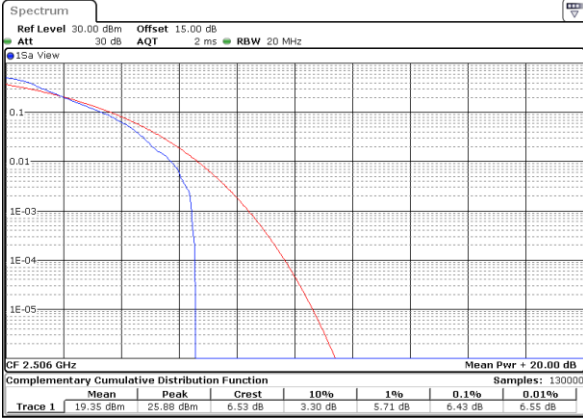

Date: 3,MAR,2022 21:14:24

Lowest Channel / Full RB



Date: 3,MAR,2022 19:50:14

Middle Channel / 1RB

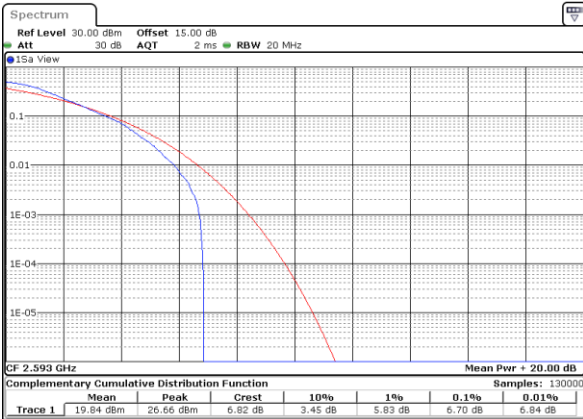

Date: 4,MAR,2022 08:31:29

Middle Channel / Full RB

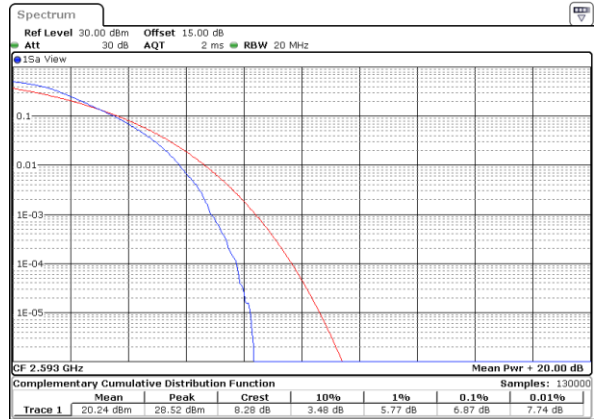

Date: 4,MAR,2022 08:32:03

Highest Channel / 1RB

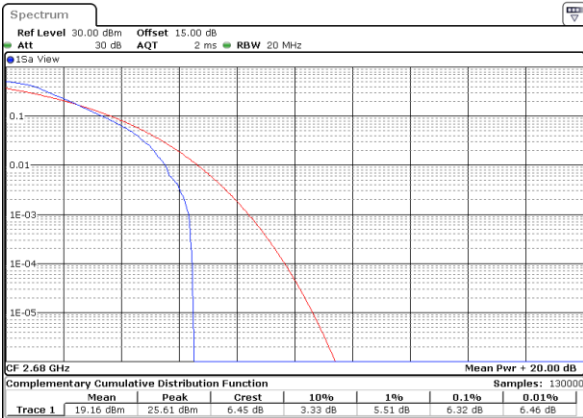

Date: 4,MAR,2022 08:34:06

Highest Channel / Full RB

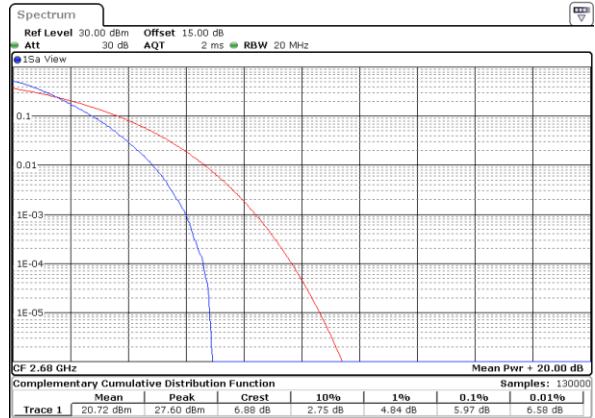

Date: 4,MAR,2022 08:35:20



LTE Band 41 / 20MHz / 16QAM

Lowest Channel / 1RB



Date: 3,MAR,2022 19:47:16

Lowest Channel / Full RB

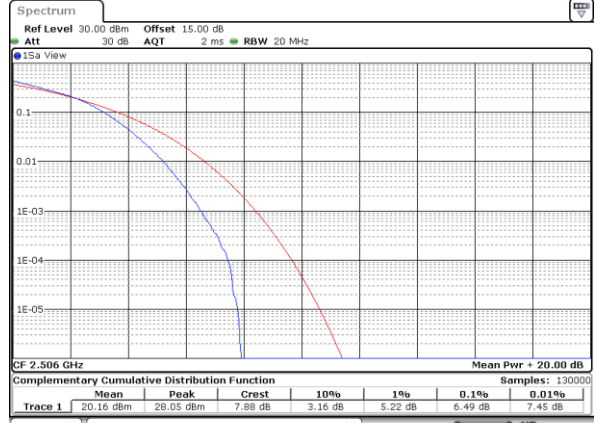

Date: 3,MAR,2022 19:47:42

Middle Channel / 1RB



Date: 3,MAR,2022 19:48:07

Middle Channel / Full RB



Date: 3,MAR,2022 19:48:32

Highest Channel / 1RB

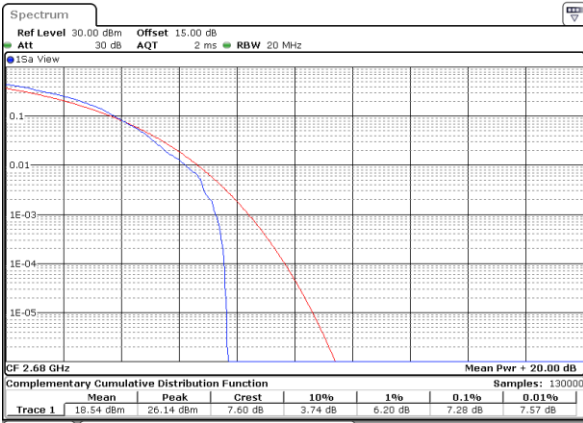

Date: 4,MAR,2022 08:32:58

Highest Channel / Full RB

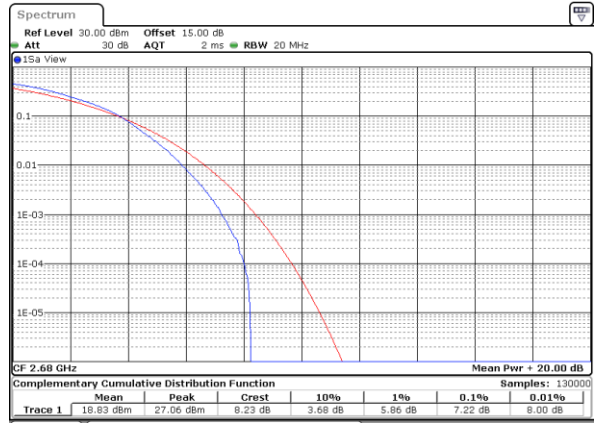

Date: 3,MAR,2022 19:49:23





LTE Band 41 / 20MHz / 64QAM

Lowest Channel / 1RB

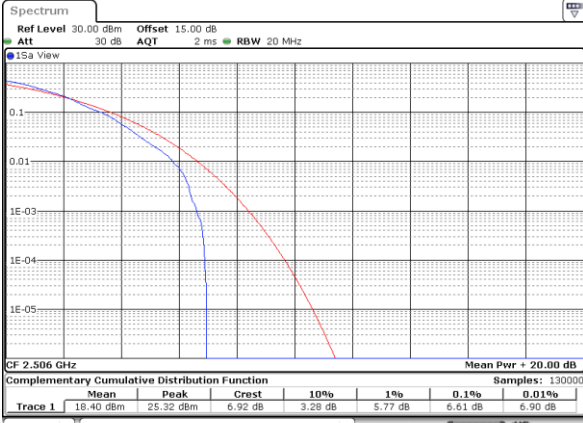

Date: 3,MAR,2022 21:15:18

Lowest Channel / Full RB

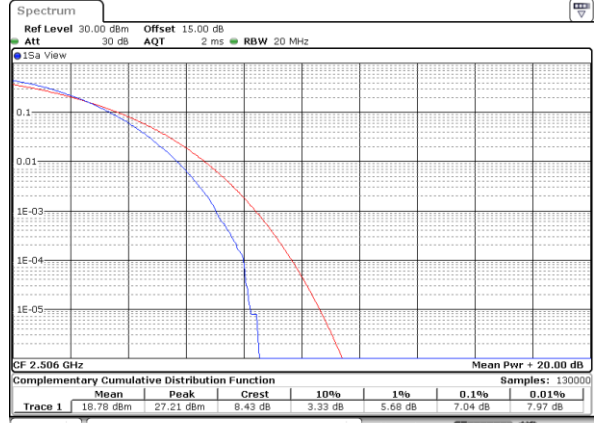

Date: 3,MAR,2022 21:16:04

Middle Channel / 1RB

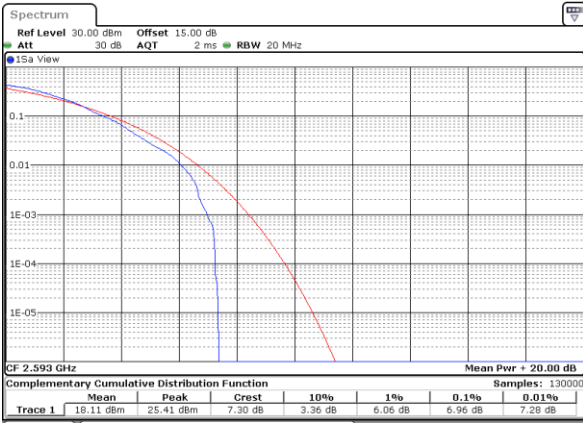

Date: 3,MAR,2022 19:45:35

Middle Channel / Full RB

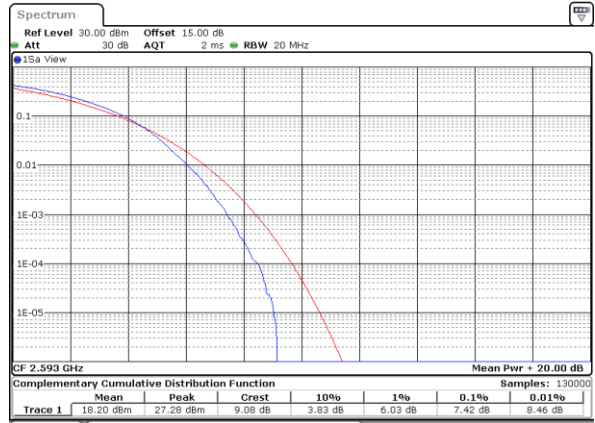

Date: 3,MAR,2022 19:46:00

Highest Channel / 1RB

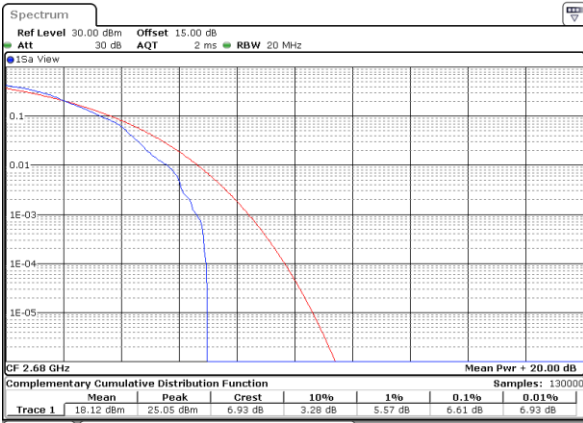

Date: 4,MAR,2022 08:33:39

Highest Channel / Full RB

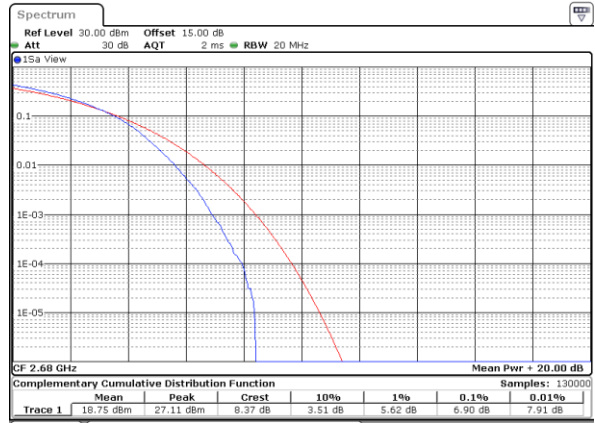

Date: 4,MAR,2022 08:34:51



26dB Bandwidth

Mode	LTE Band 41 : 26dB BW(MHz)											
BW	1.4MHz		3MHz		5MHz		10MHz		15MHz		20MHz	
Mod.	QPSK	16QAM	QPSK	16QAM	QPSK	16QAM	QPSK	16QAM	QPSK	16QAM	QPSK	16QAM
Lowest CH	-	-	-	-	4.78	4.81	9.71	9.69	14.18	14.12	18.74	18.82
Middle CH	-	-	-	-	4.76	4.85	9.59	9.73	14.12	14.18	18.74	18.66
Highest CH	-	-	-	-	4.87	4.84	9.67	9.69	14.21	14.18	18.70	18.78
Mode	LTE Band 41 : 26dB BW(MHz)											
BW	1.4MHz		3MHz		5MHz		10MHz		15MHz		20MHz	
Mod.	64QAM		64QAM		64QAM		64QAM		64QAM		64QAM	
Lowest CH	-	-	-	-	4.95	-	9.79	-	14.42	-	18.78	-
Middle CH	-	-	-	-	4.78	-	9.63	-	14.18	-	18.66	-
Highest CH	-	-	-	-	4.78	-	9.65	-	14.24	-	18.66	-



LTE Band 41

Lowest Channel / 5MHz / QPSK

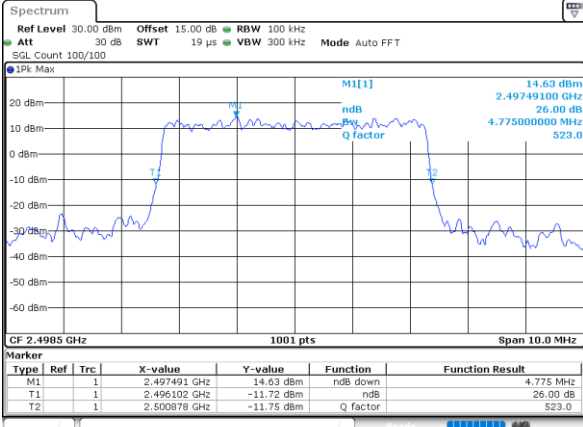

Date: 3,MAR,2022 19:18:41

Lowest Channel / 5MHz / 16QAM

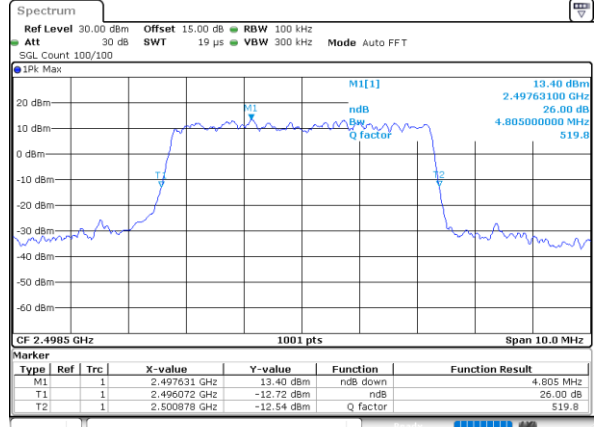

Date: 3,MAR,2022 19:19:05

Middle Channel / 5MHz / QPSK

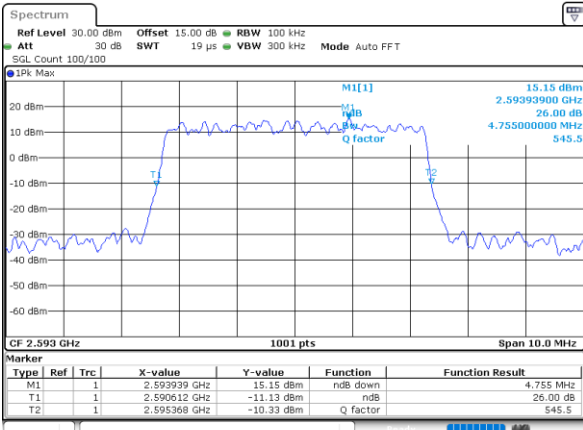

Date: 3,MAR,2022 19:20:16

Middle Channel / 5MHz / 16QAM

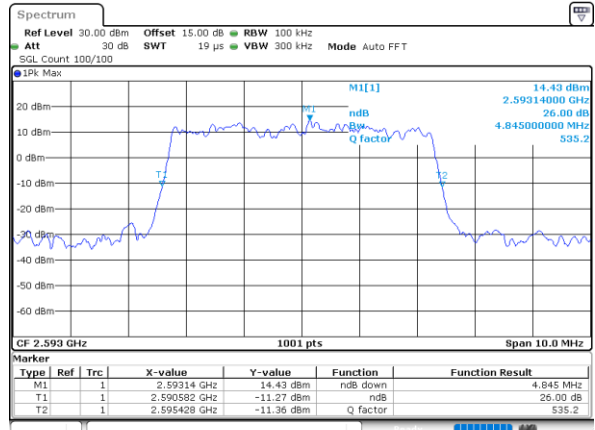

Date: 3,MAR,2022 19:20:39

Highest Channel / 5MHz / QPSK

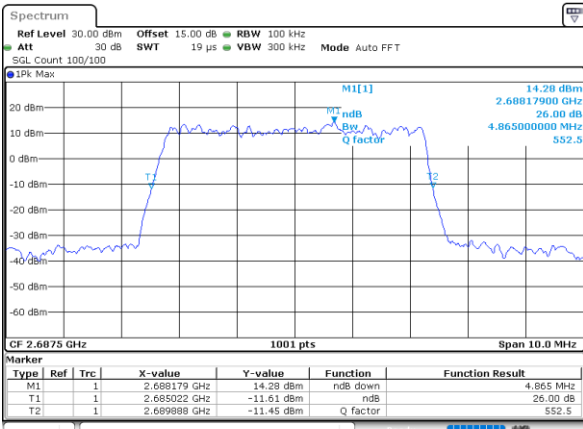

Date: 3,MAR,2022 19:21:51

Highest Channel / 5MHz / 16QAM

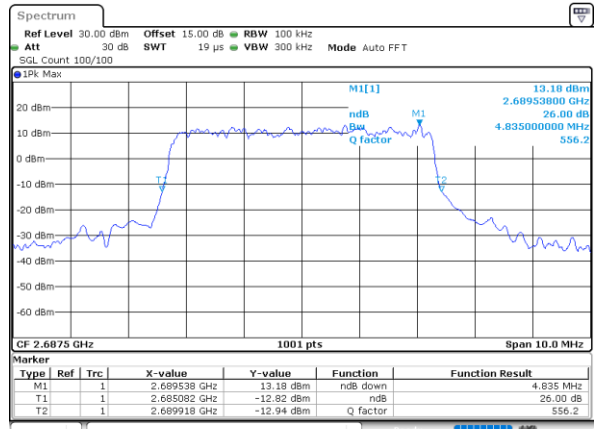

Date: 3,MAR,2022 19:22:14



LTE Band 41

Lowest Channel / 10MHz / QPSK

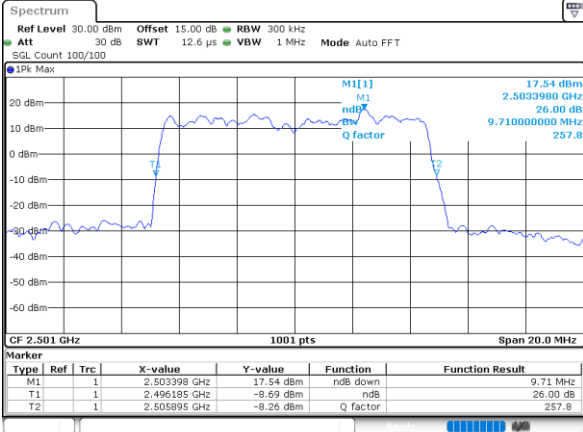

Date: 3,MAR,2022 19:23:28

Lowest Channel / 10MHz / 16QAM

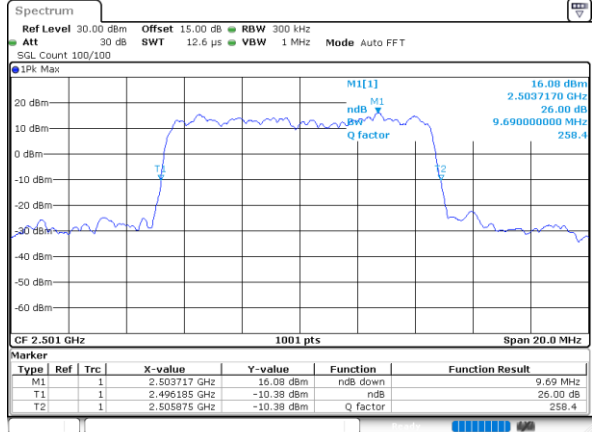

Date: 3,MAR,2022 19:23:52

Middle Channel / 10MHz / QPSK

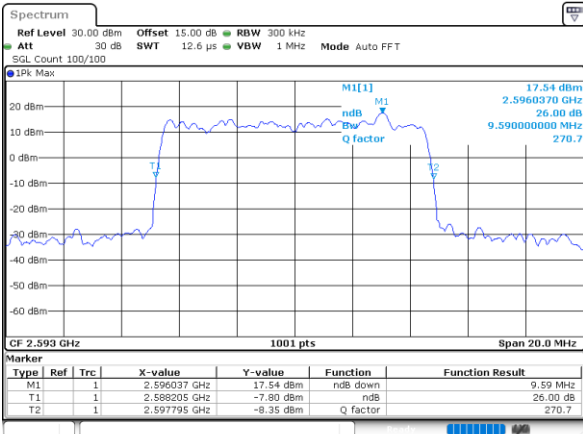

Date: 3,MAR,2022 19:25:04

Middle Channel / 10MHz / 16QAM

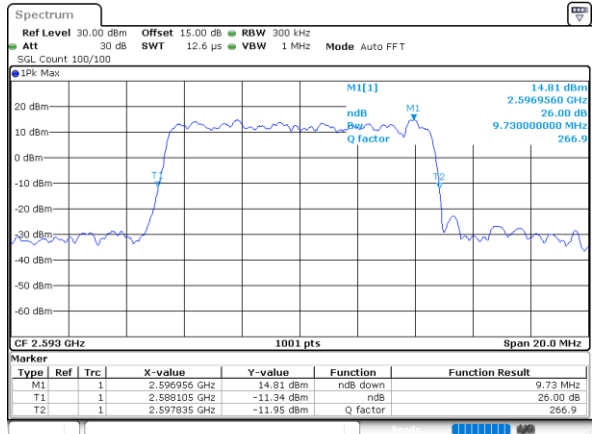

Date: 3,MAR,2022 19:25:28

Highest Channel / 10MHz / QPSK

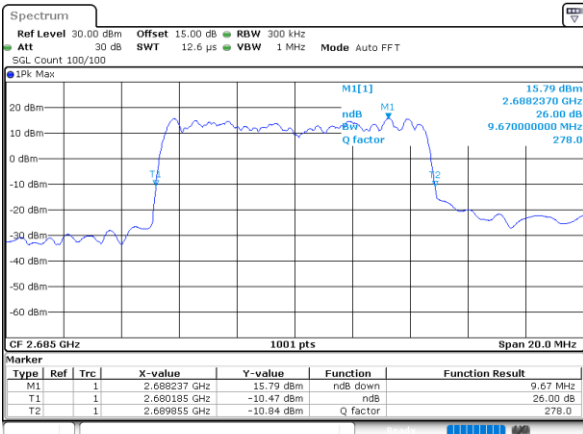

Date: 3,MAR,2022 19:26:40

Highest Channel / 10MHz / 16QAM

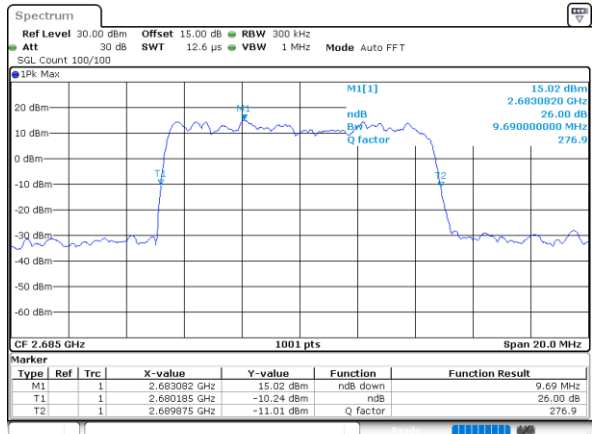

Date: 3,MAR,2022 19:27:04



LTE Band 41

Lowest Channel / 15MHz / QPSK

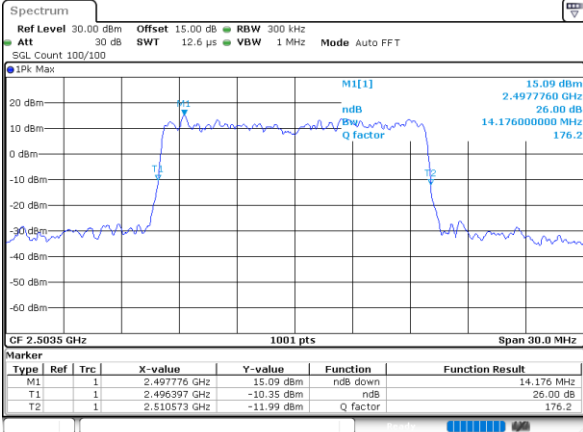

Date: 3,MAR,2022 19:28:16

Lowest Channel / 15MHz / 16QAM

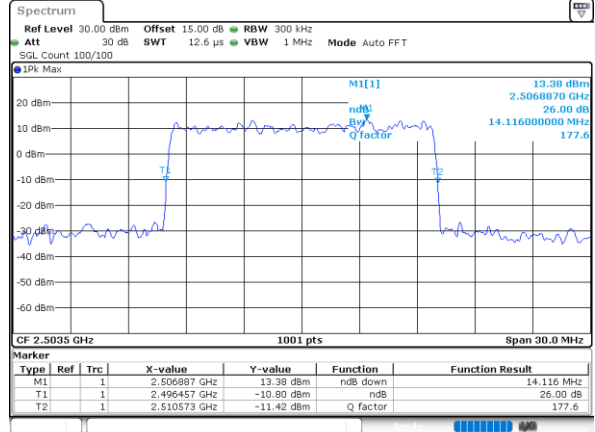

Date: 3,MAR,2022 19:28:40

Middle Channel / 15MHz / QPSK

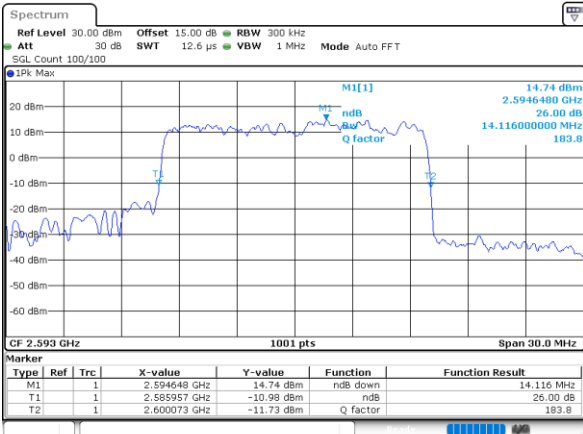

Date: 3,MAR,2022 19:29:50

Middle Channel / 15MHz / 16QAM

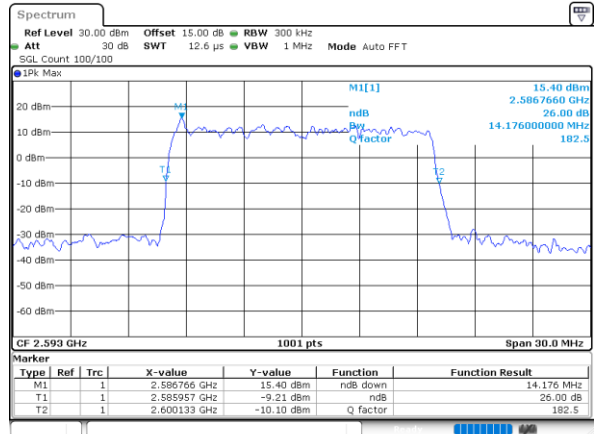

Date: 3,MAR,2022 19:30:14

Highest Channel / 15MHz / QPSK

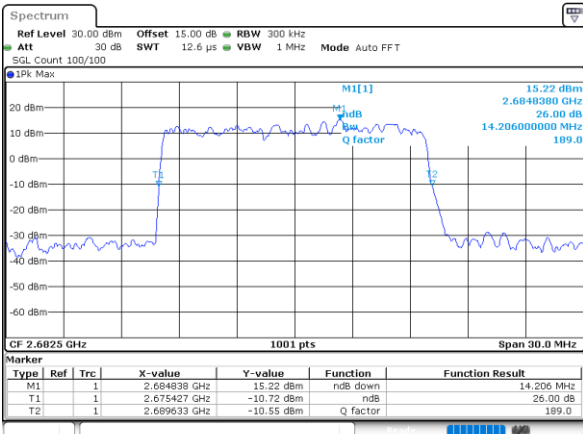

Date: 3,MAR,2022 19:31:25

Highest Channel / 15MHz / 16QAM

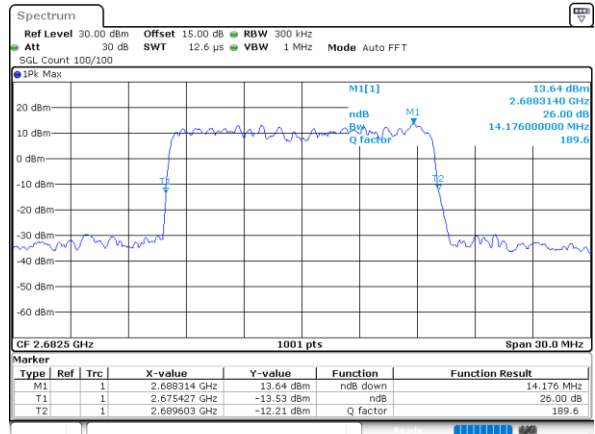

Date: 3,MAR,2022 19:31:49



LTE Band 41

Lowest Channel / 20MHz / QPSK

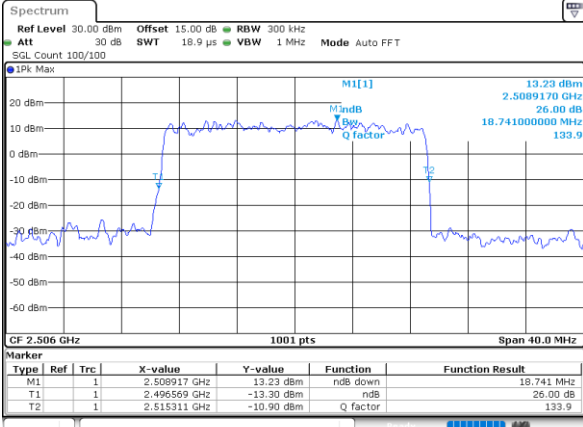

Date: 3,MAR,2022 19:33:02

Lowest Channel / 20MHz / 16QAM

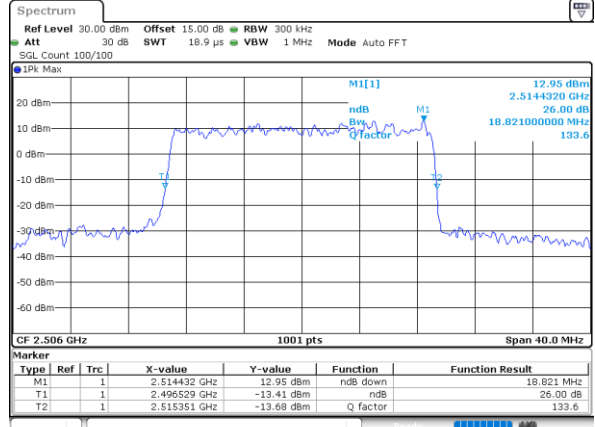

Date: 3,MAR,2022 19:33:26

Middle Channel / 20MHz / QPSK

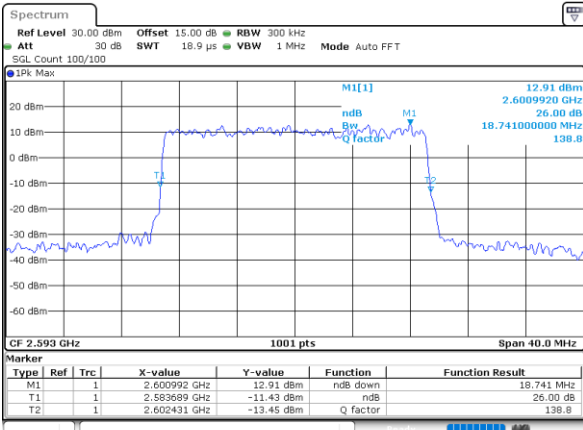

Date: 3,MAR,2022 19:34:36

Middle Channel / 20MHz / 16QAM

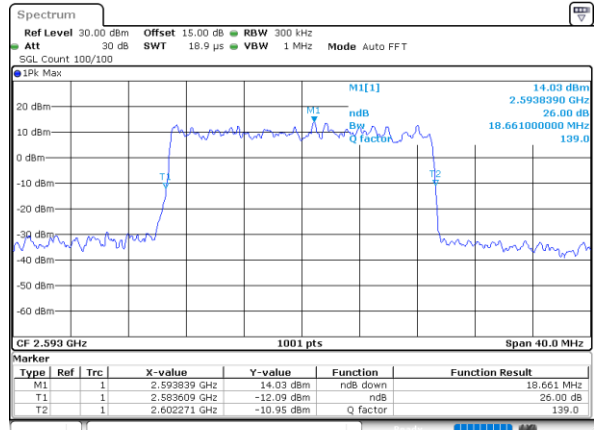

Date: 3,MAR,2022 19:35:00

Highest Channel / 20MHz / QPSK

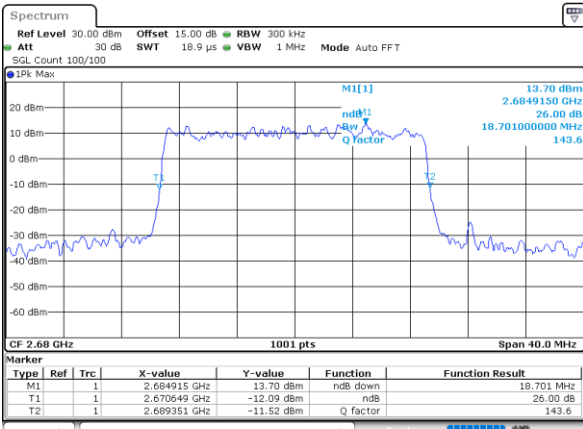

Date: 3,MAR,2022 19:36:11

Highest Channel / 20MHz / 16QAM

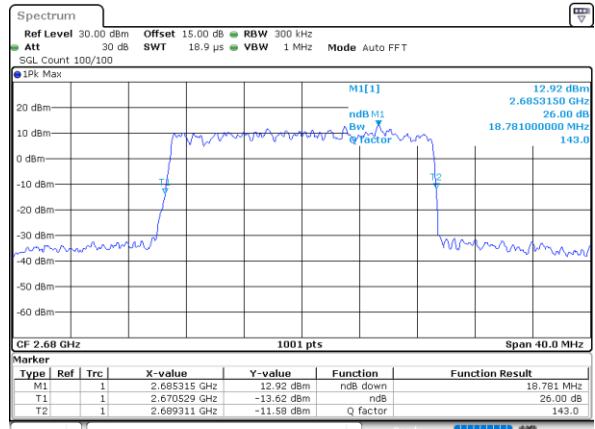

Date: 3,MAR,2022 19:36:36



LTE Band 41

Lowest Channel / 5MHz / 64QAM

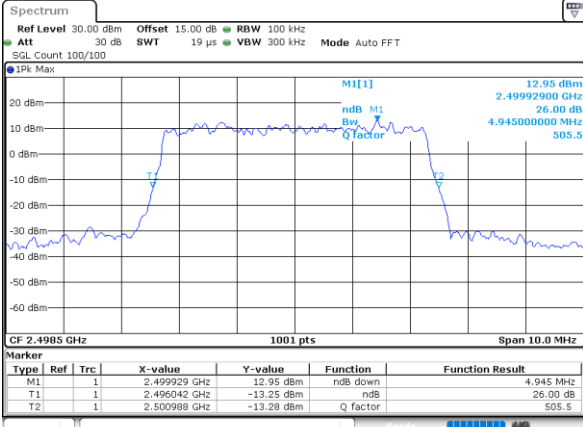

Date: 3,MAR,2022 19:37:15

Lowest Channel / 10MHz / 64QAM

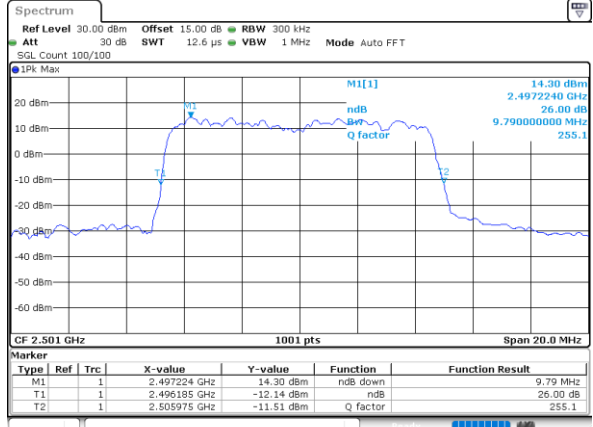

Date: 3,MAR,2022 19:39:10

Middle Channel / 5MHz / 64QAM

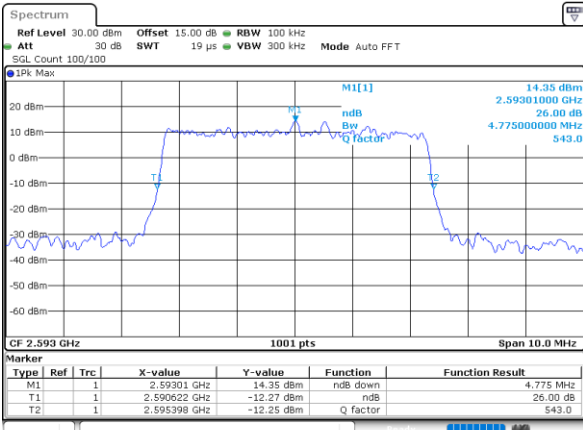

Date: 3,MAR,2022 19:37:53

Middle Channel / 10MHz / 64QAM

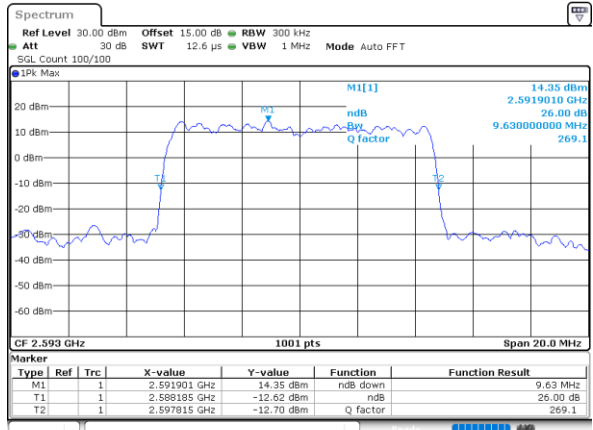

Date: 3,MAR,2022 19:39:48

Highest Channel / 5MHz / 64QAM

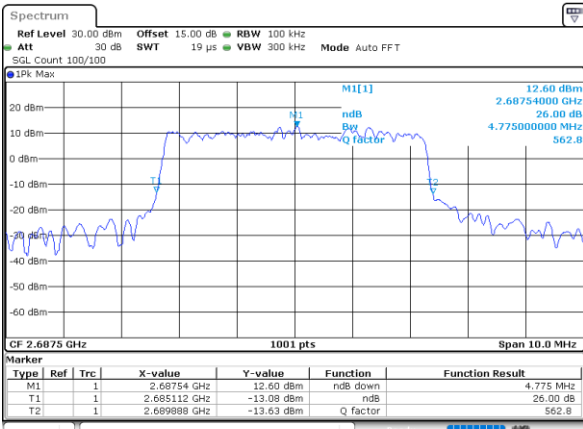

Date: 3,MAR,2022 19:38:31

Highest Channel / 10MHz / 64QAM

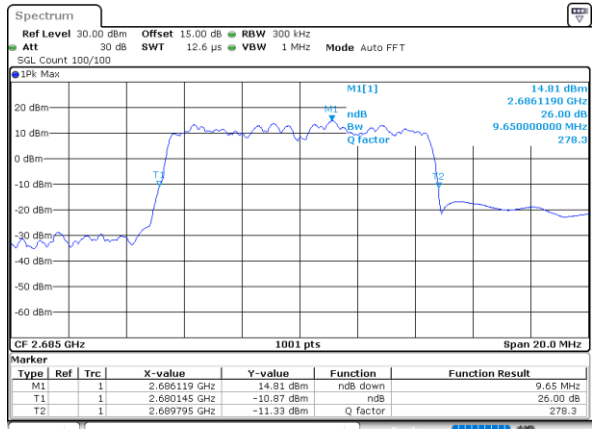

Date: 3,MAR,2022 19:40:27



LTE Band 41

Lowest Channel / 15MHz / 64QAM

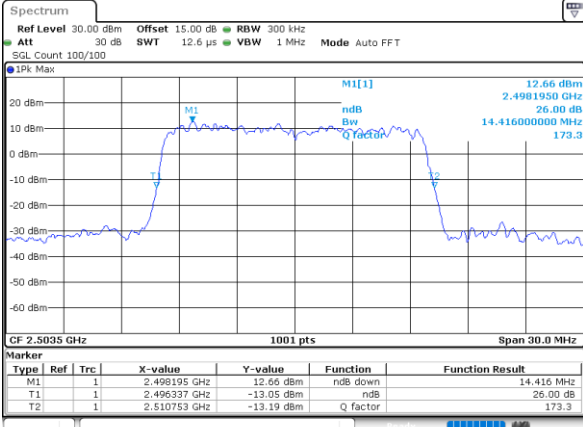

Date: 3,MAR,2022 19:41:06

Lowest Channel / 20MHz / 64QAM

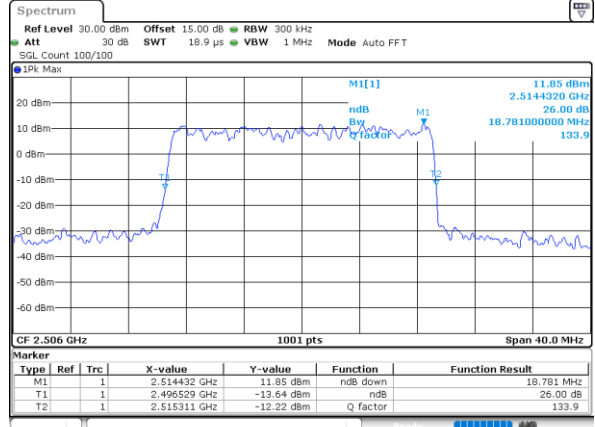

Date: 3,MAR,2022 19:43:01

Middle Channel / 15MHz / 64QAM

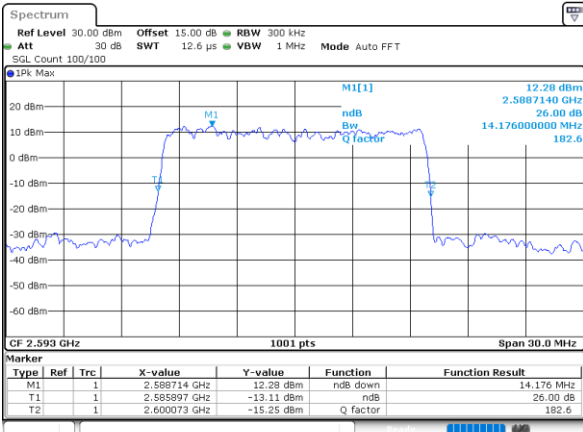

Date: 3,MAR,2022 19:41:44

Middle Channel / 20MHz / 64QAM

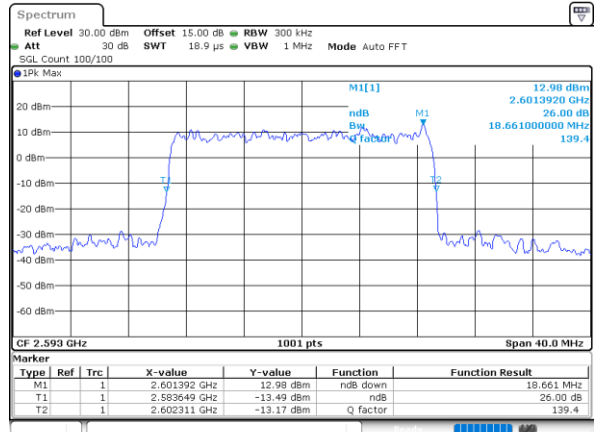

Date: 3,MAR,2022 19:43:39

Highest Channel / 15MHz / 64QAM

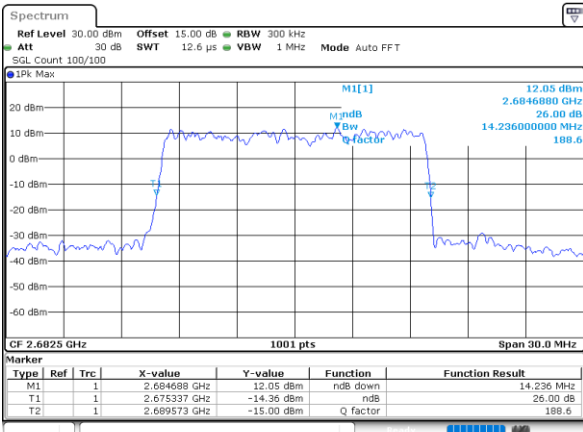

Date: 3,MAR,2022 19:42:22

Highest Channel / 20MHz / 64QAM

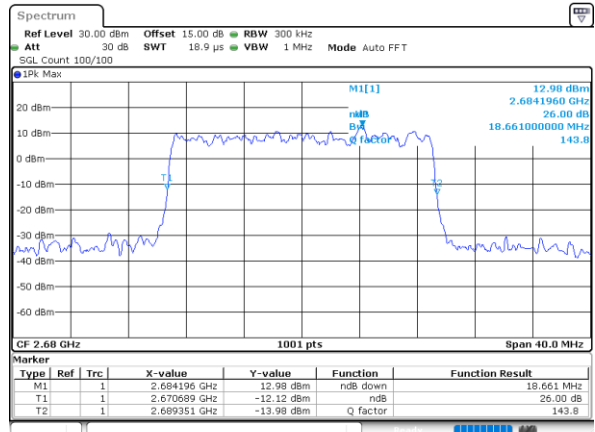

Date: 3,MAR,2022 19:44:18





**Occupied Bandwidth**

Mode	LTE Band 41 : 99%OBW(MHz)											
BW	1.4MHz		3MHz		5MHz		10MHz		15MHz		20MHz	
Mod.	QPSK	16QAM	QPSK	16QAM	QPSK	16QAM	QPSK	16QAM	QPSK	16QAM	QPSK	16QAM
Lowest CH	-	-	-	-	4.47	4.51	9.03	9.03	13.40	13.55	17.86	17.86
Middle CH	-	-	-	-	4.50	4.50	9.01	9.07	13.49	13.46	17.86	17.90
Highest CH	-	-	-	-	4.49	4.51	9.07	9.05	13.46	13.46	17.90	17.90
Mode	LTE Band 41 : 99%OBW(MHz)											
BW	1.4MHz		3MHz		5MHz		10MHz		15MHz		20MHz	
Mod.	64QAM		64QAM		64QAM		64QAM		64QAM		64QAM	
Lowest CH	-	-	-	-	4.49	-	9.03	-	13.43	-	17.86	-
Middle CH	-	-	-	-	4.49	-	9.07	-	13.43	-	17.90	-
Highest CH	-	-	-	-	4.48	-	9.01	-	13.43	-	17.86	-



LTE Band 41

Lowest Channel / 5MHz / QPSK

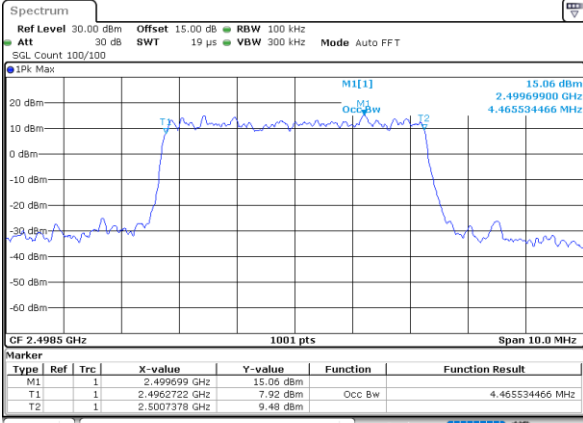

Date: 3,MAR,2022 19:17:53

Lowest Channel / 5MHz / 16QAM

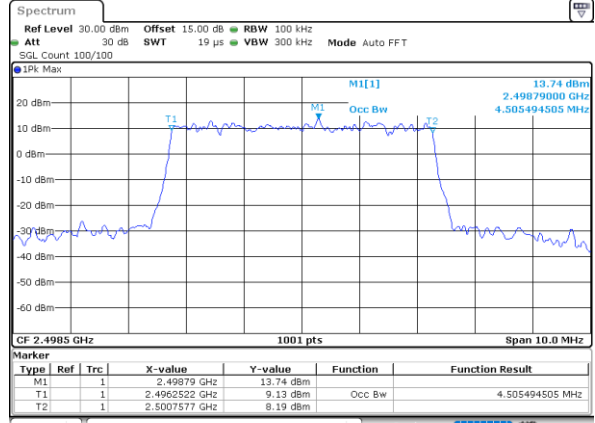

Date: 3,MAR,2022 19:18:17

Middle Channel / 5MHz / QPSK

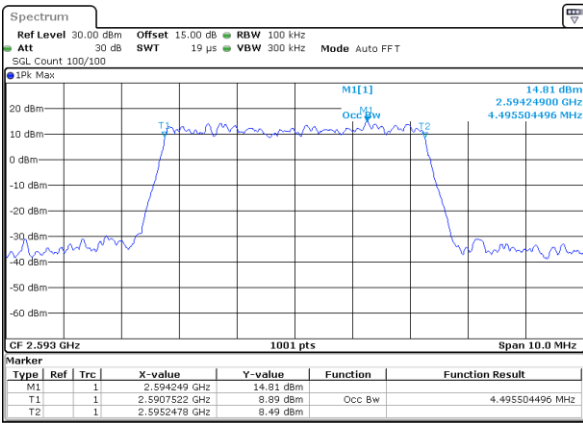

Date: 3,MAR,2022 19:19:29

Middle Channel / 5MHz / 16QAM

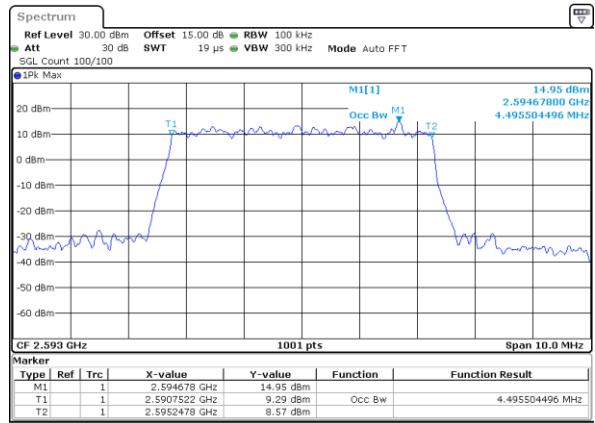

Date: 3,MAR,2022 19:19:52

Highest Channel / 5MHz / QPSK

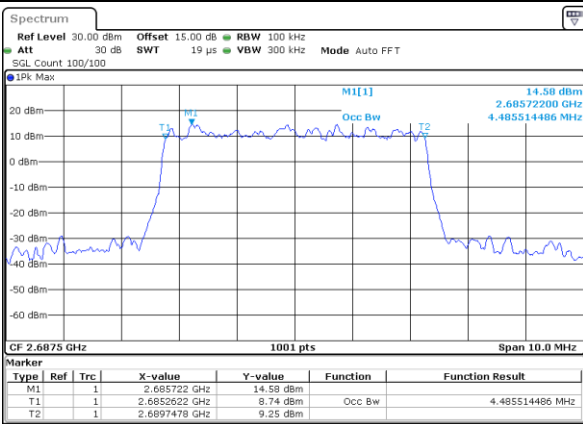

Date: 3,MAR,2022 19:21:03

Highest Channel / 5MHz / 16QAM

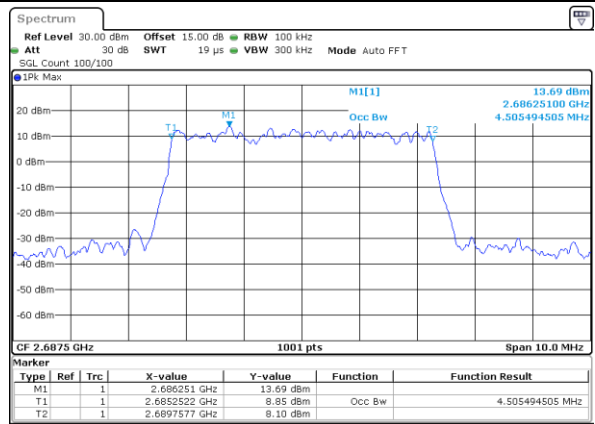

Date: 3,MAR,2022 19:21:27



LTE Band 41

Lowest Channel / 10MHz / QPSK

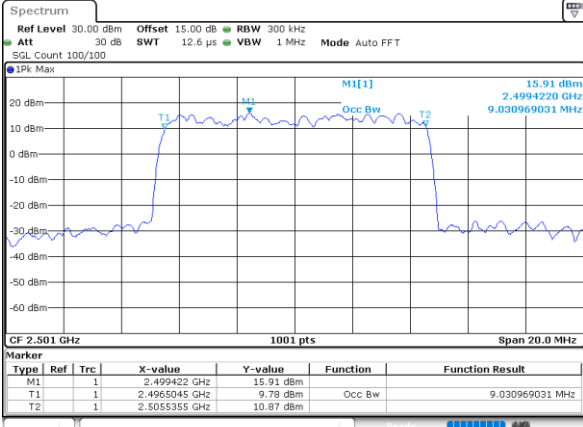

Date: 3,MAR,2022 19:22:19

Lowest Channel / 10MHz / 16QAM

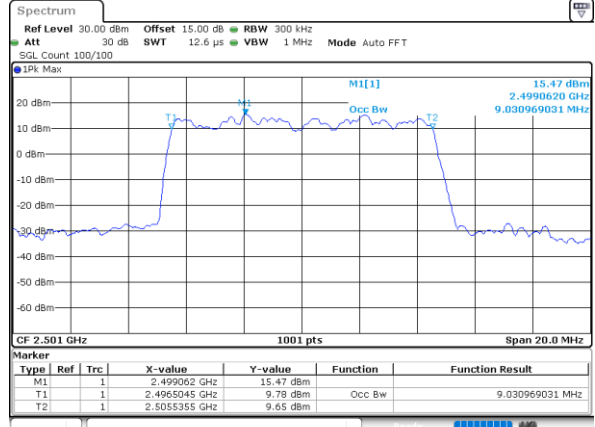

Date: 3,MAR,2022 19:23:04

Middle Channel / 10MHz / QPSK

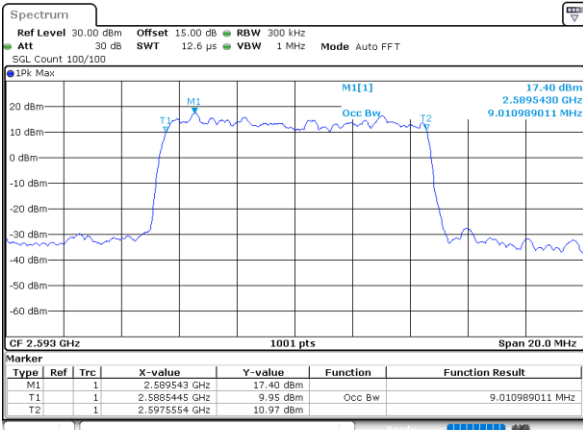

Date: 3,MAR,2022 19:24:17

Middle Channel / 10MHz / 16QAM

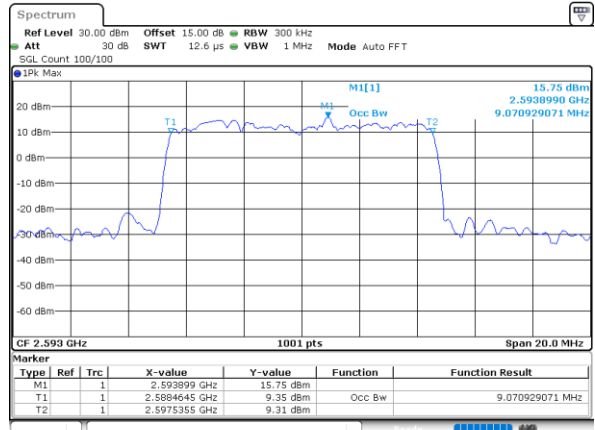

Date: 3,MAR,2022 19:24:40

Highest Channel / 10MHz / QPSK

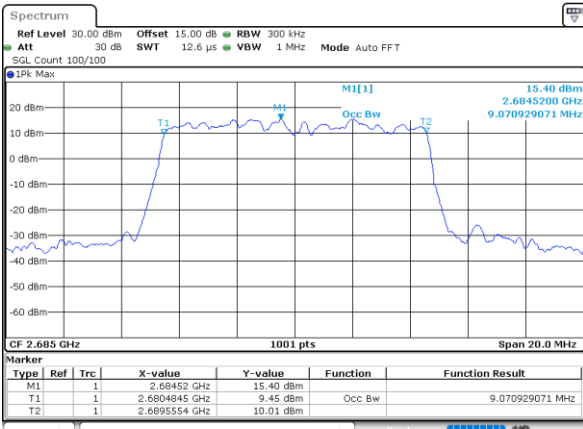

Date: 3,MAR,2022 19:25:11

Highest Channel / 10MHz / 16QAM

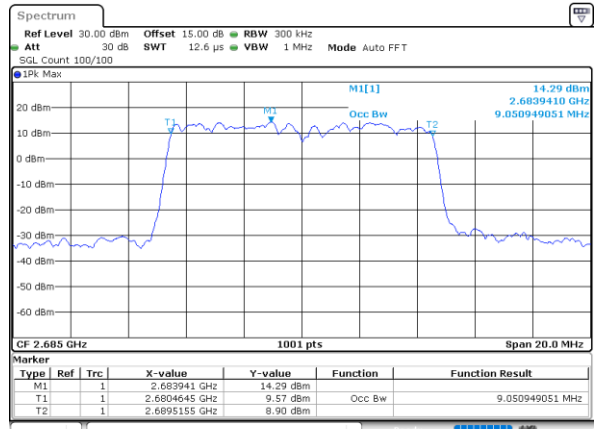

Date: 3,MAR,2022 19:26:15



LTE Band 41

Lowest Channel / 15MHz / QPSK

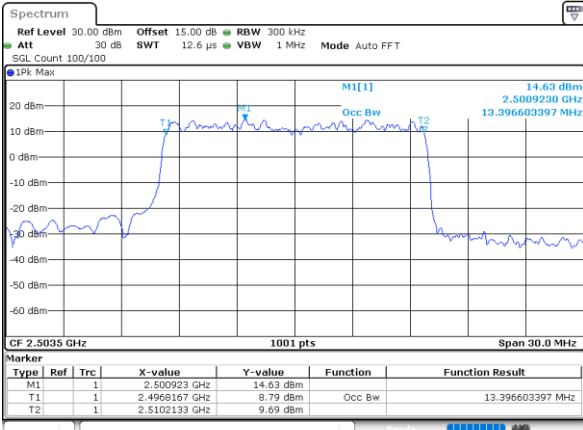

Date: 3,MAR,2022 19:27:28

Lowest Channel / 15MHz / 16QAM

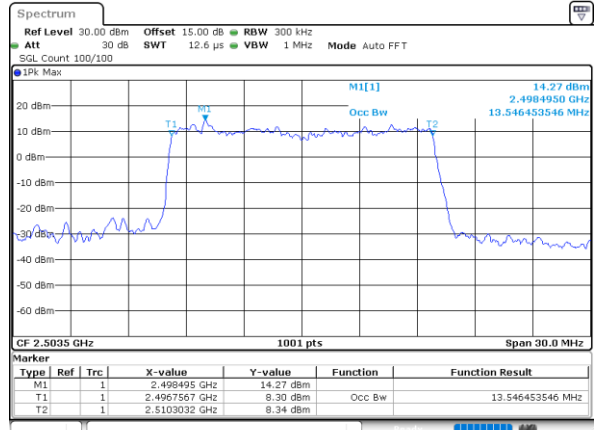

Date: 3,MAR,2022 19:27:52

Middle Channel / 15MHz / QPSK

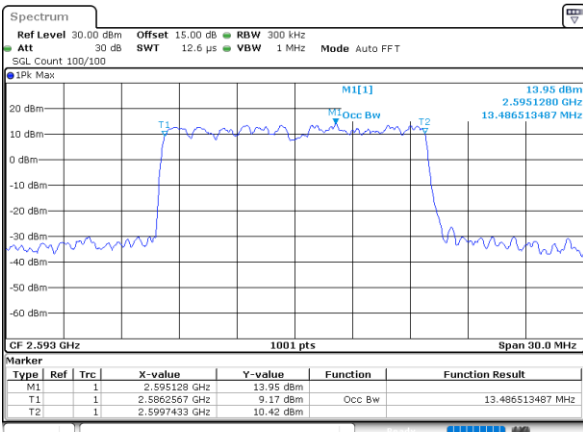

Date: 3,MAR,2022 19:29:03

Middle Channel / 15MHz / 16QAM

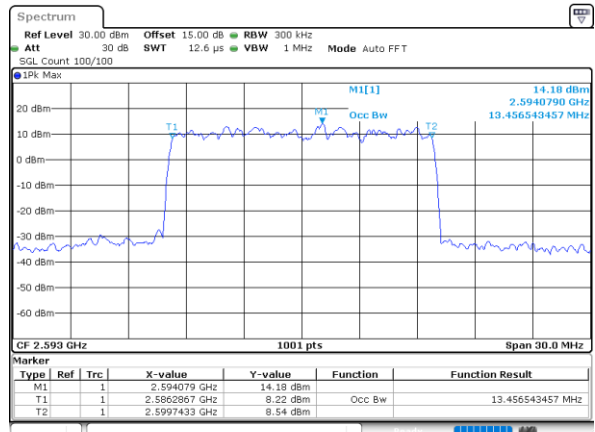

Date: 3,MAR,2022 19:29:27

Highest Channel / 15MHz / QPSK

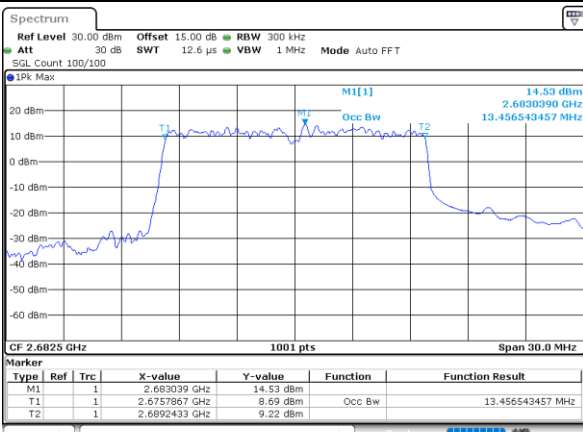

Date: 3,MAR,2022 19:30:37

Highest Channel / 15MHz / 16QAM

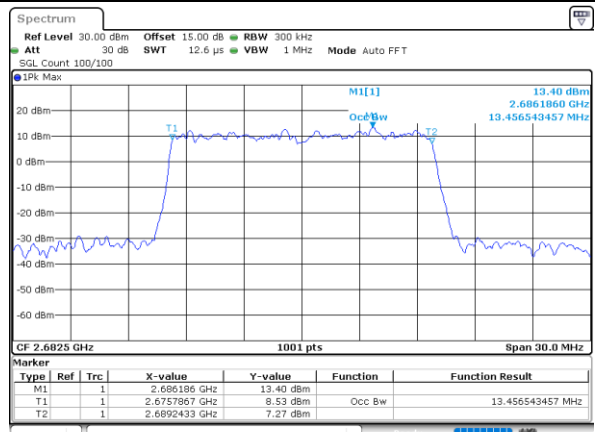

Date: 3,MAR,2022 19:31:02



LTE Band 41

Lowest Channel / 20MHz / QPSK

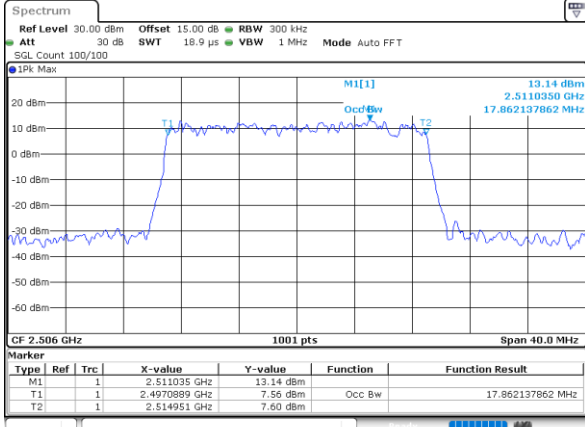

Date: 3,MAR,2022 19:32:14

Lowest Channel / 20MHz / 16QAM

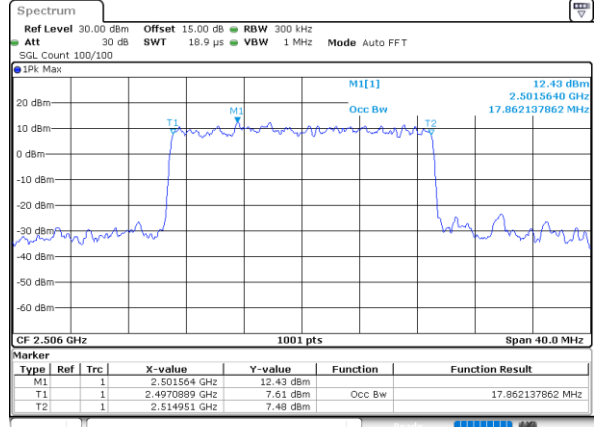

Date: 3,MAR,2022 19:32:38

Middle Channel / 20MHz / QPSK

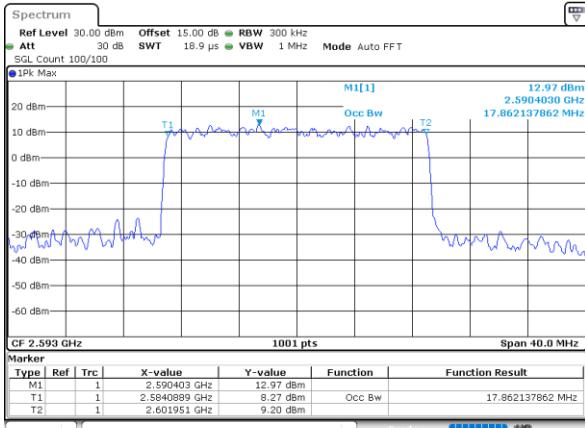

Date: 3,MAR,2022 19:33:49

Middle Channel / 20MHz / 16QAM

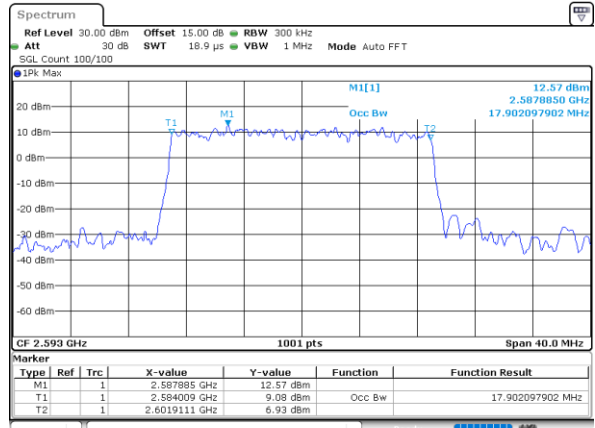

Date: 3,MAR,2022 19:34:13

Highest Channel / 20MHz / QPSK

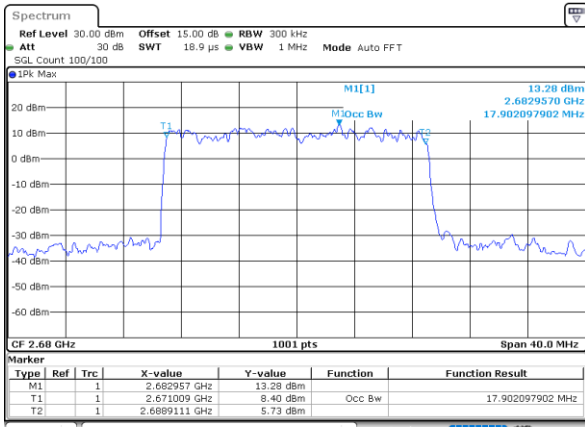

Date: 3,MAR,2022 19:35:24

Highest Channel / 20MHz / 16QAM

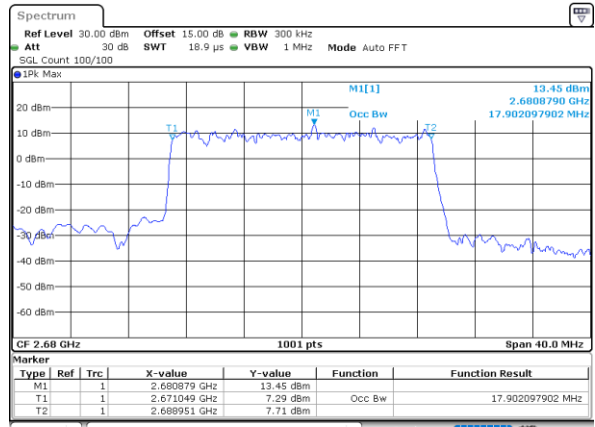

Date: 3,MAR,2022 19:35:47



LTE Band 41

Lowest Channel / 5MHz / 64QAM

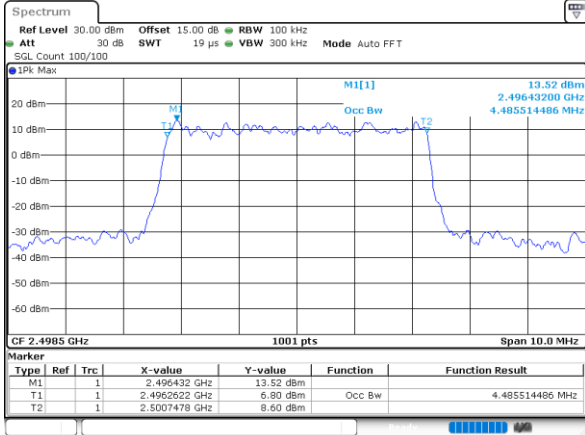

Date: 3,MAR,2022 19:37:00

Lowest Channel / 10MHz / 64QAM

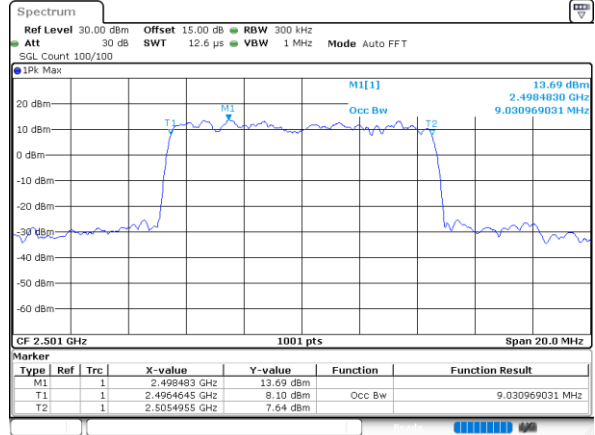

Date: 3,MAR,2022 19:38:55

Middle Channel / 5MHz / 64QAM

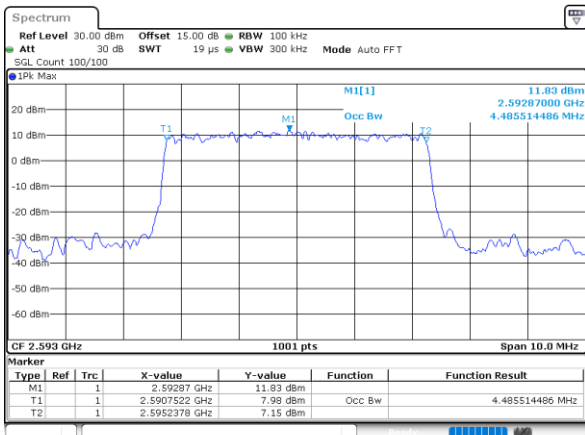

Date: 3,MAR,2022 19:37:38

Middle Channel / 10MHz / 64QAM

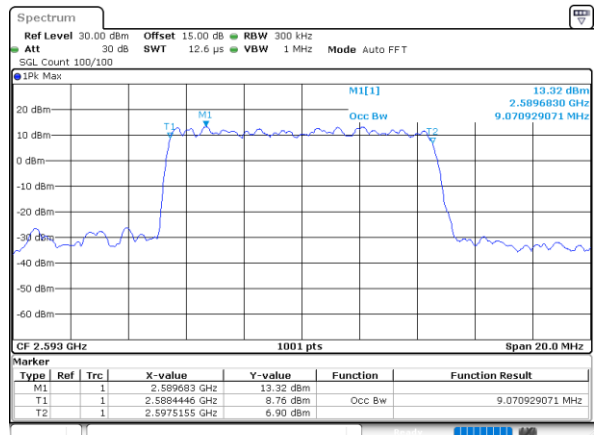

Date: 3,MAR,2022 19:38:34

Highest Channel / 5MHz / 64QAM

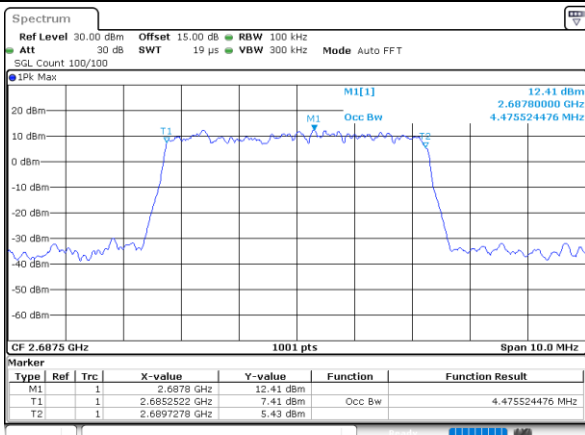

Date: 3,MAR,2022 19:38:16

Highest Channel / 10MHz / 64QAM

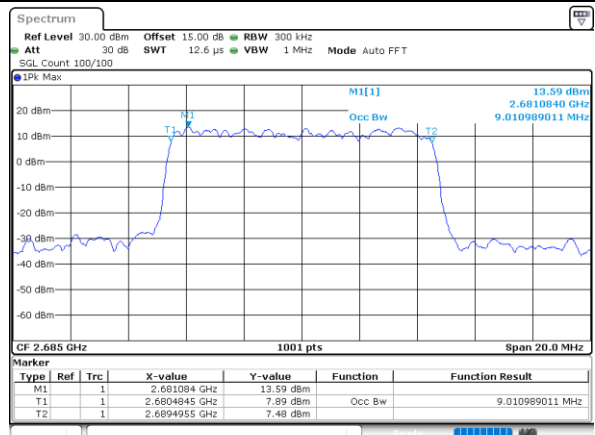

Date: 3,MAR,2022 19:40:12



LTE Band 41

Lowest Channel / 15MHz / 64QAM

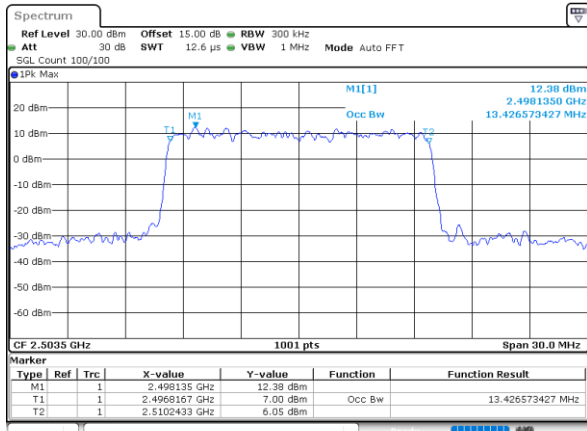

Date: 3,MAR,2022 19:40:51

Lowest Channel / 20MHz / 64QAM

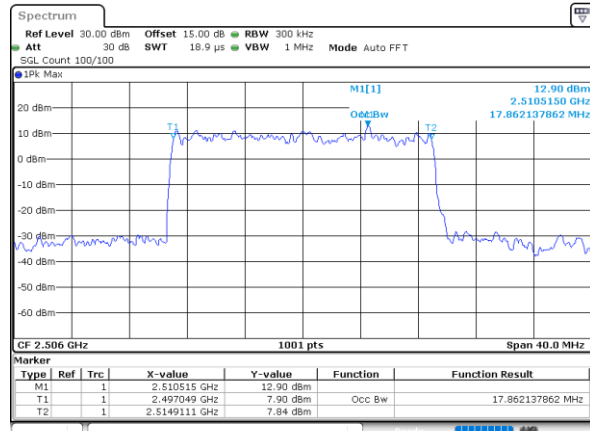

Date: 3,MAR,2022 19:42:46

Middle Channel / 15MHz / 64QAM

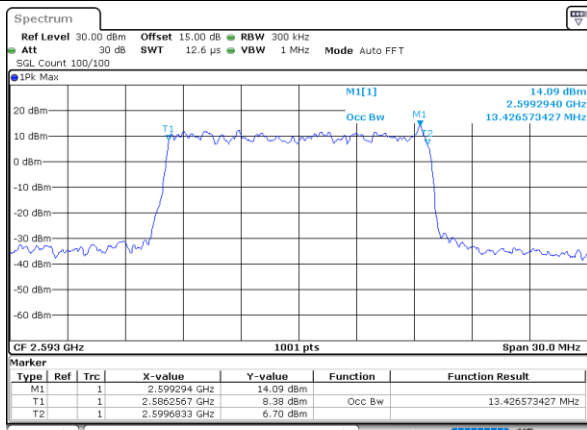

Date: 3,MAR,2022 19:41:29

Middle Channel / 20MHz / 64QAM

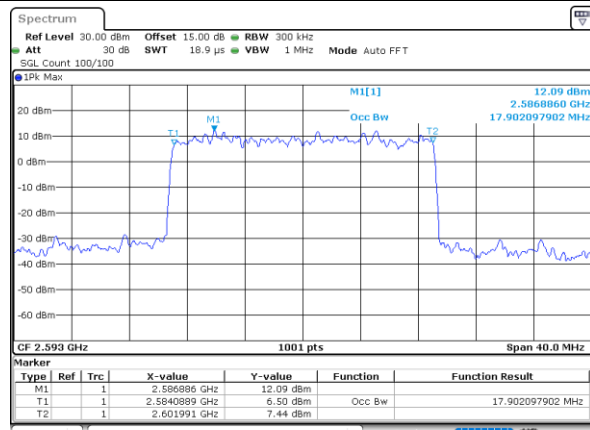

Date: 3,MAR,2022 19:43:24

Highest Channel / 15MHz / 64QAM

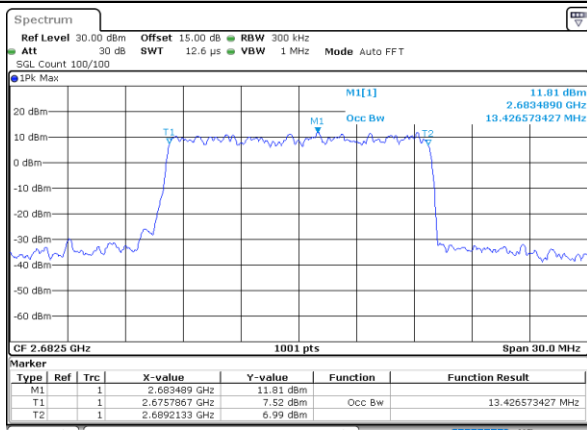

Date: 3,MAR,2022 19:42:07

Highest Channel / 20MHz / 64QAM

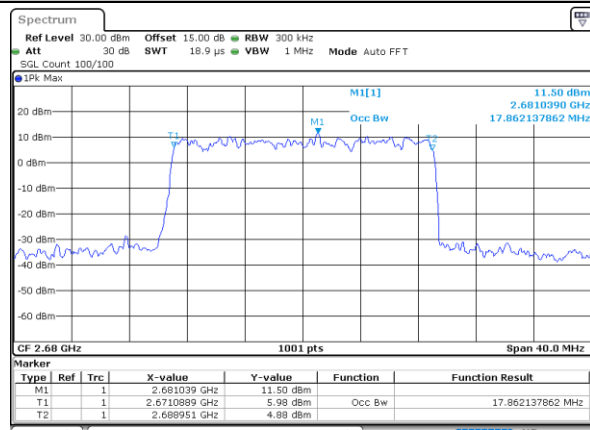

Date: 3,MAR,2022 19:44:03



# Conducted Band Edge

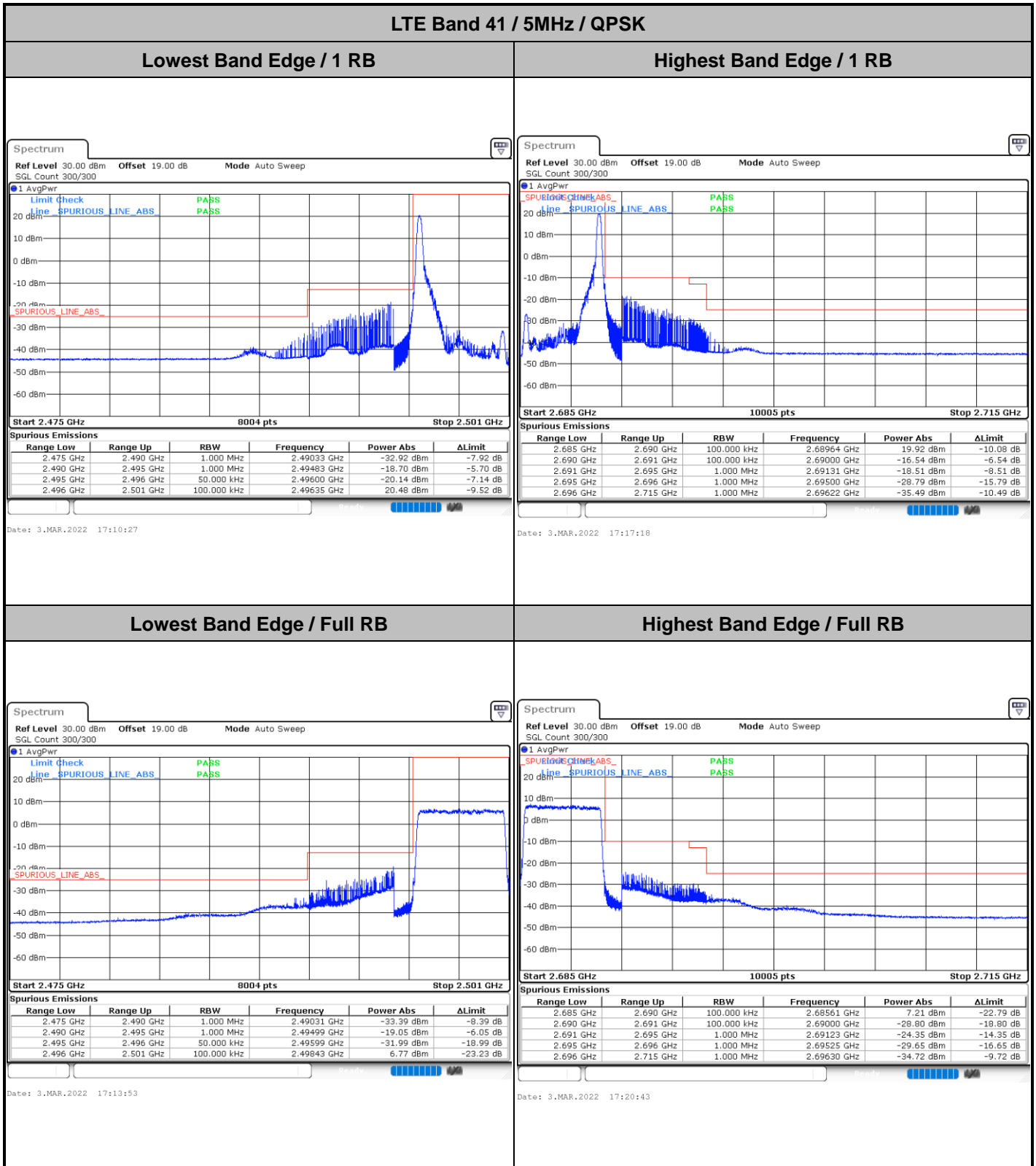





LTE Band 41 / 5MHz / 16QAM

Lowest Band Edge / 1RB

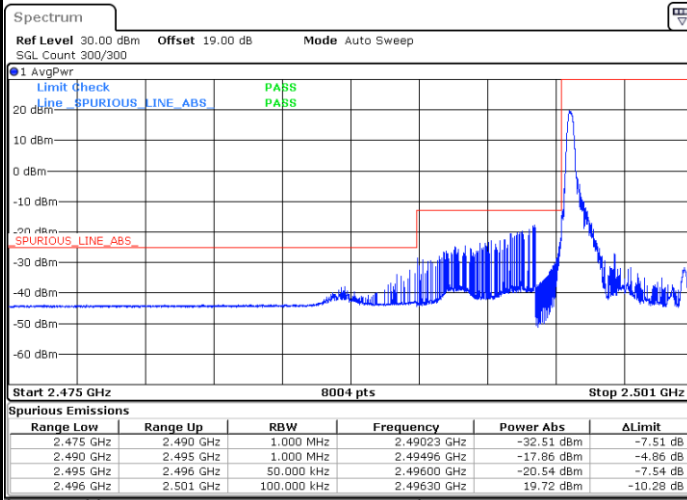

Date: 3.MAR.2022 17:12:10

Highest Band Edge / 1 RB

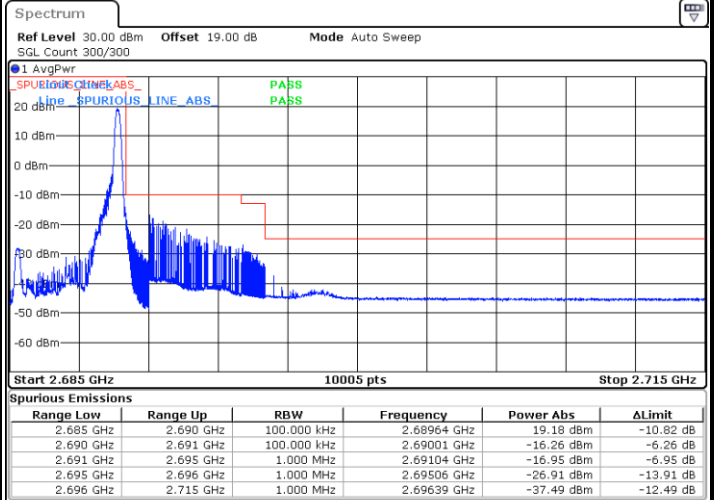

Date: 3.MAR.2022 17:19:00

Lowest Band Edge / Full RB

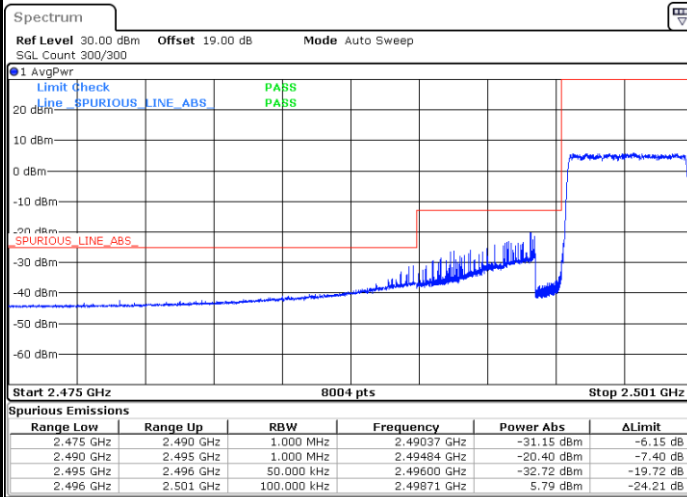

Date: 3.MAR.2022 17:15:35

Highest Band Edge / Full RB

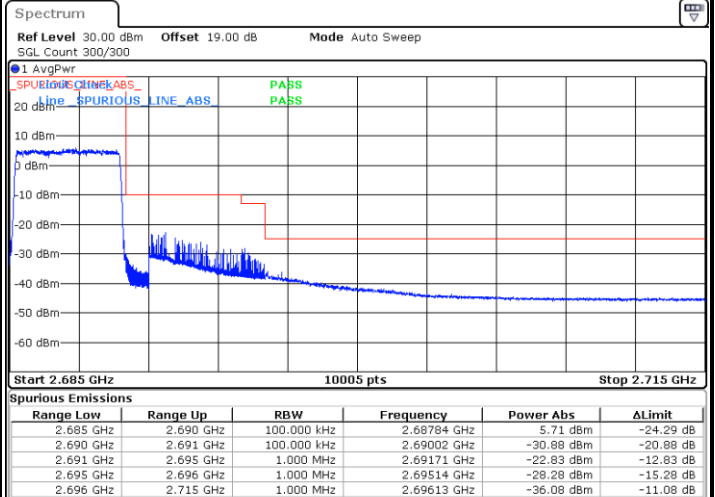

Date: 3.MAR.2022 17:22:25



LTE Band 41 / 5MHz / 64QAM

Lowest Band Edge / 1RB

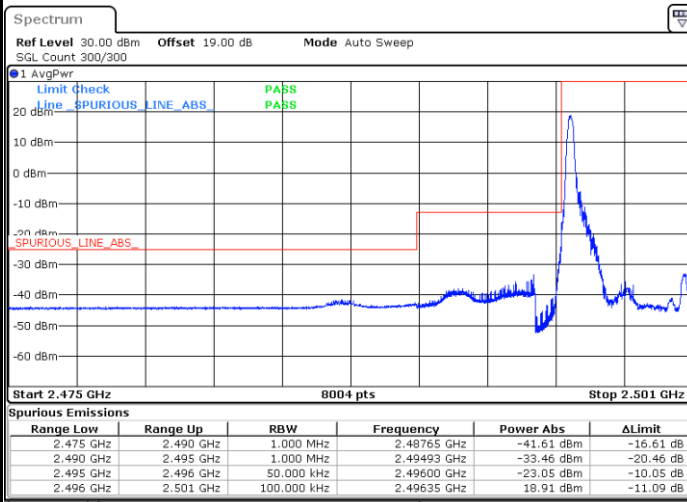

Date: 3.MAR.2022 18:36:17

Highest Band Edge / 1 RB

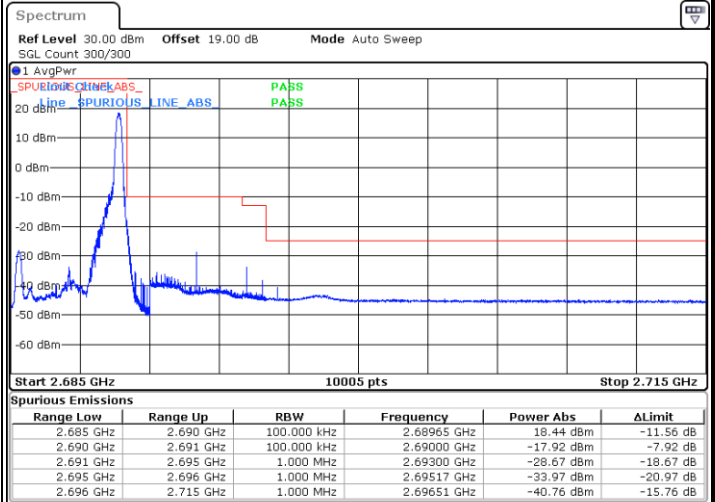

Date: 3.MAR.2022 18:39:42

Lowest Band Edge / Full RB

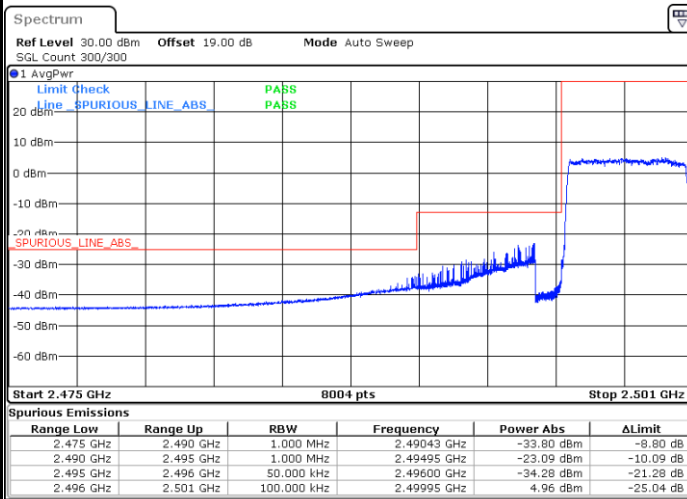

Date: 3.MAR.2022 18:38:00

Highest Band Edge / Full RB

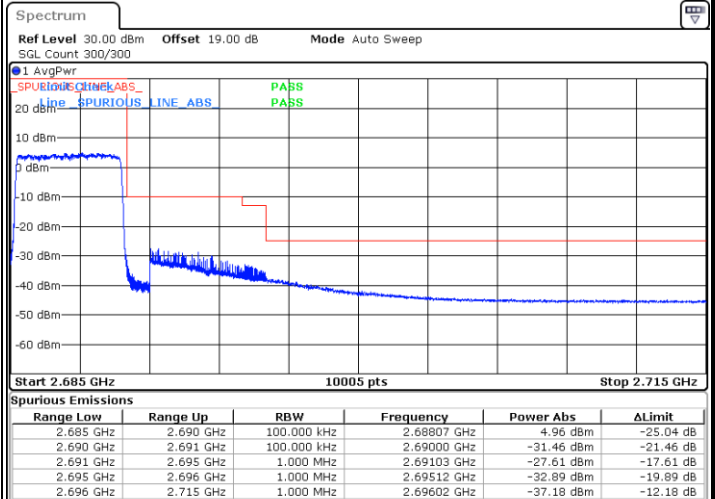

Date: 3.MAR.2022 18:41:25



LTE Band 41 / 10MHz / QPSK

Lowest Band Edge / 1 RB

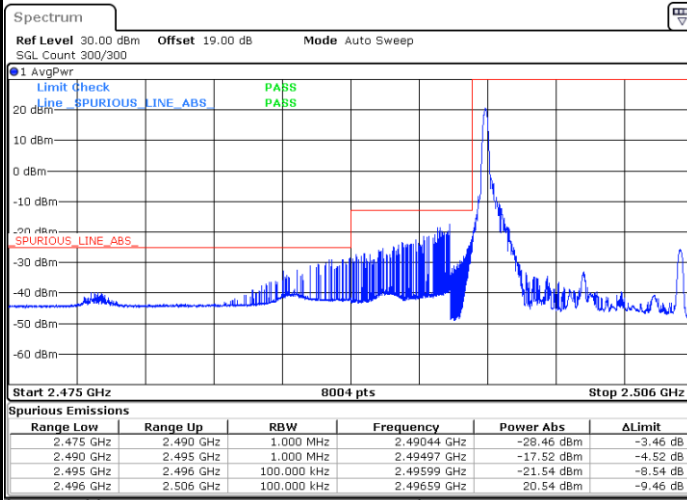

Date: 3.MAR.2022 17:24:09

Highest Band Edge / 1 RB

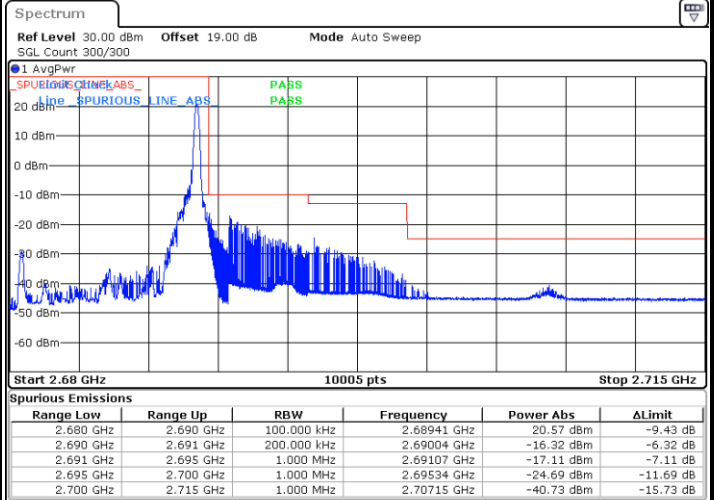

Date: 3.MAR.2022 17:31:00

Lowest Band Edge / Full RB

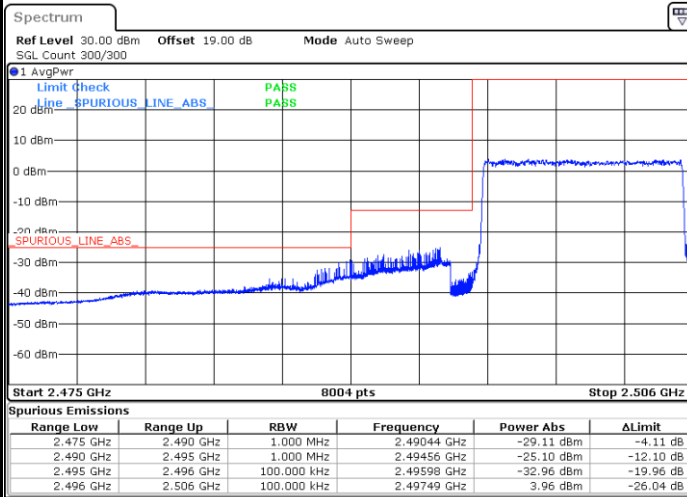

Date: 3.MAR.2022 17:27:35

Highest Band Edge / Full RB

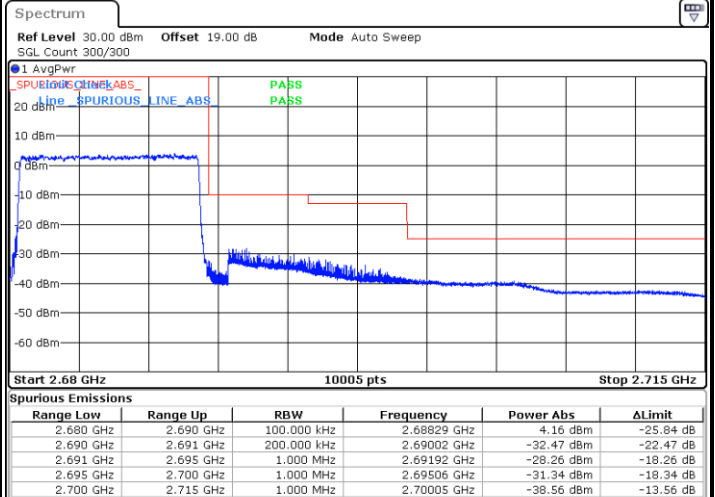

Date: 3.MAR.2022 17:34:25



LTE Band 41 / 10MHz / 16QAM

Lowest Band Edge / 1 RB

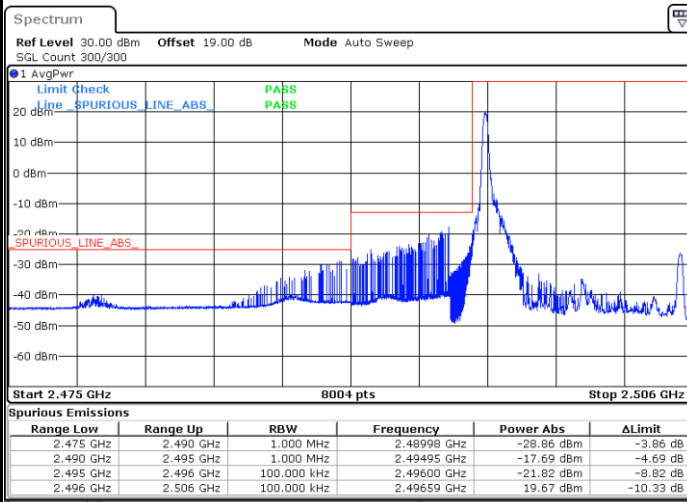

Date: 3.MAR.2022 17:25:52

Highest Band Edge / 1 RB

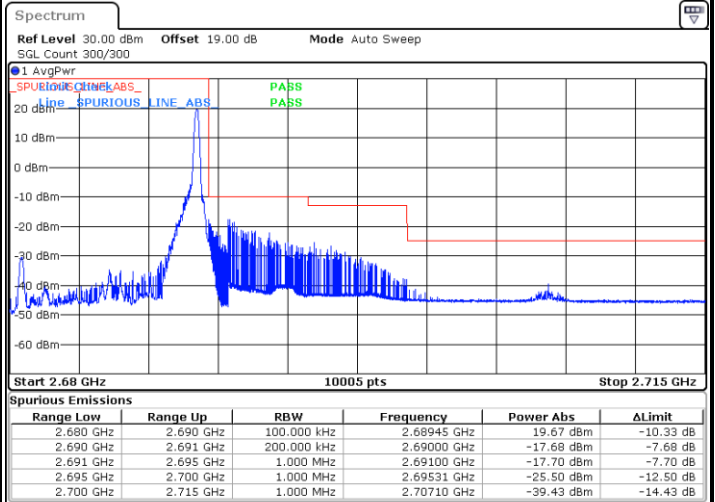

Date: 3.MAR.2022 17:32:42

Lowest Band Edge / Full RB

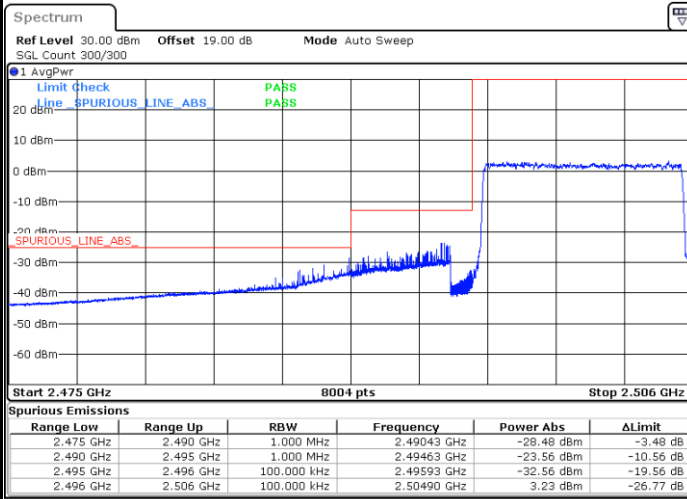

Date: 3.MAR.2022 17:29:18

Highest Band Edge / Full RB

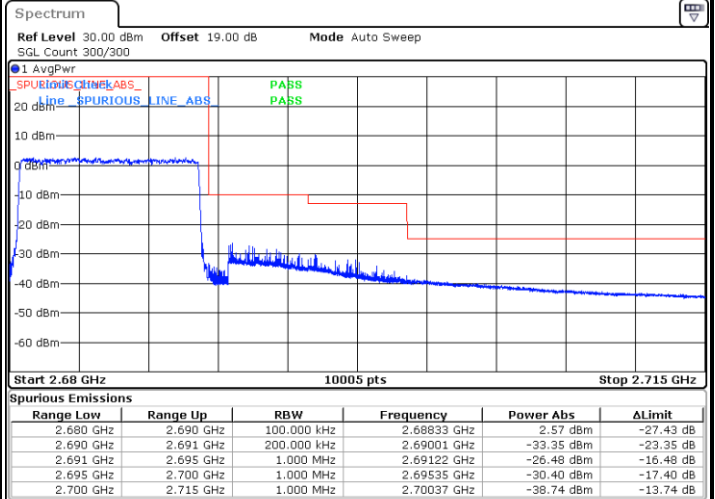

Date: 3.MAR.2022 17:36:08