



FCC RF Test Report

APPLICANT : Motorola Mobility LLC
EQUIPMENT : Mobile Cellular Phone
BRAND NAME : Motorola
MODEL NAME : XT2201-3, XT2201-5
FCC ID : IHDT56AB2
STANDARD : 47 CFR Part 2, and 90(S)
CLASSIFICATION : PCS Licensed Transmitter Held to Ear (PCE)
TEST DATE(S) : Nov. 23, 2021 ~ Jan. 01, 2022

We, Sporton International (Kunshan) Inc., would like to declare that the tested sample has been evaluated in accordance with the procedures given in ANSI C63.26-2015 and shown compliance with the applicable technical standards.

The test results in this report apply exclusively to the tested model / sample. Without written approval of Sporton International (Kunshan) Inc., the test report shall not be reproduced except in full.

Reviewed by: Jason Jia / Supervisor

Approved by: Alex Wang / Manager



Sporton International (Kunshan) Inc.

**No. 1098, Pengxi North Road, Kunshan Economic Development Zone Jiangsu Province 215300
People's Republic of China**



TABLE OF CONTENTS

REVISION HISTORY..... 3

SUMMARY OF TEST RESULT 4

1 GENERAL DESCRIPTION 5

1.1 Applicant..... 5

1.2 Manufacturer 5

1.3 Feature of Equipment Under Test..... 5

1.4 Product Specification of Equipment Under Test 5

1.5 Modification of EUT 6

1.6 Specification of Accessory 6

1.7 Maximum Conducted Power and Emission Designator 6

1.8 Testing Site..... 7

1.9 Test Software 7

1.10 Applied Standards 7

2 TEST CONFIGURATION OF EQUIPMENT UNDER TEST 8

2.1 Test Mode..... 8

2.2 Connection Diagram of Test System 9

2.3 Support Unit used in test configuration and system..... 9

2.4 Measurement Results Explanation Example 9

2.5 Frequency List of Low/Middle/High Channels..... 10

3 TEST RESULT..... 11

3.1 Conducted Output Power Measurement..... 11

3.2 99% Occupied Bandwidth and 26dB Bandwidth Measurement..... 12

3.3 Emissions Mask Measurement 13

3.4 Emissions Mask – Out Of Band Emissions Measurement..... 15

3.5 Field Strength of Spurious Radiation Measurement 16

3.6 Frequency Stability Measurement..... 19

4 LIST OF MEASURING EQUIPMENT 21

5 UNCERTAINTY OF EVALUATION..... 22

APPENDIX A. TEST RESULTS OF CONDUCTED TEST

APPENDIX B. TEST RESULTS OF RADIATED TEST

APPENDIX C. TEST SETUP PHOTOGRAPHS



SUMMARY OF TEST RESULT

| Report Section | FCC Rule | Description | Limit | Result | Remark |
|----------------|--------------------|--|-------------------------------------|-------------|--|
| 3.1 | §2.1046 | Conducted Output Power | — | Report only | - |
| 3.2 | §2.1049 §90.209 | Occupied Bandwidth and 26dB Bandwidth | — | Report only | - |
| 3.3 | §2.1051 §90.691 | Emission masks – In-band emissions | $< 50+10\log_{10}(P[\text{Watts}])$ | PASS | - |
| 3.4 | §2.1051 §90.691 | Emission masks – Out of band emissions | $< 43+10\log_{10}(P[\text{Watts}])$ | PASS | - |
| 3.5 | §2.1053 §90.691 | Field Strength of Spurious Radiation | $< 43+10\log_{10}(P[\text{Watts}])$ | PASS | Under limit 45.76 dB at 2518.000 MHz |
| 3.6 | §2.1055 §90.213 | Frequency Stability for Temperature & Voltage | $< 2.5 \text{ ppm}$ | PASS | - |

Declaration of Conformity:

The test results with all measurement uncertainty excluded are presented in accordance with the regulation limits or requirements declared by manufacturers.

Comments and Explanations:

The declared of product specification for EUT presented in the report are provided by the manufacturer, and the manufacturer takes all the responsibilities for the accuracy of product specification.



1 General Description

1.1 Applicant

Motorola Mobility LLC
222 W,Merchandise Mart Plaza, Chicago IL 60654 USA

1.2 Manufacturer

Motorola Mobility LLC
222 W,Merchandise Mart Plaza, Chicago IL 60654 USA

1.3 Feature of Equipment Under Test

| Product Feature | |
|-----------------|--|
| Equipment | Mobile Cellular Phone |
| Brand Name | Motorola |
| Model Name | XT2201-3, XT2201-5 |
| FCC ID | IHDT56AB2 |
| IMEI Code | Conducted: 355386390008310/355386390008301 Radiation: 355386390007494 |
| HW Version | DVT2 |
| SW Version | SSH32.76 |
| EUT Stage | Identical Prototype |

Remark: The above EUT's information was declared by manufacturer. Please refer to the specifications or user's manual for more detailed description.

1.4 Product Specification of Equipment Under Test

| Product Specification subjective to this standard | |
|---|--|
| Tx Frequency | 814 ~ 824 MHz |
| Rx Frequency | 859 ~ 869 MHz |
| Bandwidth | 1.4MHz / 3MHz / 5MHz / 10MHz / 15MHz |
| Maximum Output Power to Antenna | Ant. 0: 23.08 dBm Ant. 1: 23.05 dBm |
| Type of Modulation | QPSK / 16QAM / 64QAM / 256QAM |

Note: Only the maximum output power of Ant.0 is shown in the report.

1.5 Modification of EUT

No modifications are made to the EUT during all test items.

1.6 Specification of Accessory

| Specification of Accessory | | | | |
|-----------------------------------|------------|-----------------------|------------|-----------------------|
| AC Adapter 1 | Brand Name | Motorola(Salom) | Model Name | MC-301 |
| AC Adapter 2 | Brand Name | Motorola(Acbel) | Model Name | MC-301 |
| Battery | Brand Name | Motorola(ATL) | Model Name | NA50 |
| Earphone | Brand Name | Motorola (Lyand) | Model Name | MD211(SH38D20195) |
| USB Cable 1 | Brand Name | Motorola(Saibao) | Model Name | SC18D13215 |
| USB Cable 2 | Brand Name | Motorola(Cabletech) | Model Name | SC18D13216 |
| USB Cable 3 | Brand Name | Motorola(Luxshare) | Model Name | SC18D13217 |
| Type C to HDMI Cable /USB-C Cable | Brand Name | Motorola(Linxee) | Model Name | SC18D02146 |
| Stylus | Brand Name | Motorola smart stylus | Model Name | XT2201-S |
| Smart Folio | Brand Name | Motorola(Techson) | Model Name | SS68D36907,SS68D36906 |
| Wireless Dongle | Brand Name | Motorola | Model Name | MD-02 |
| HDMI Cable | Brand Name | Motorola | Model Name | HC-01 |
| USB Cable(Type A/C) | Brand Name | Motorola | Model Name | SC18C24367 |

1.7 Maximum Conducted Power and Emission Designator

| LTE Band 26 | | QPSK | | 16QAM/64QAM/256QAM | |
|-------------|-----------------------|-----------------------------|------------------------------|-----------------------------|------------------------------|
| BW (MHz) | Frequency Range (MHz) | Maximum Conducted power (W) | Emission Designator (99%OBW) | Maximum Conducted power (W) | Emission Designator (99%OBW) |
| 10 | 819.0 | 0.2000 | 9M05G7D | 0.1941 | 9M05W7D |
| 15 | 821.5 | 0.2032 | 13M5G7D | 0.2004 | 13M5W7D |



1.8 Testing Site

Sporton International (Kunshan) Inc. is accredited to ISO/IEC 17025:2017 by American Association for Laboratory Accreditation with Certificate Number 5145.02.

| | | | |
|---------------------------|--|----------------------------|---------------------------------------|
| Test Firm | Sporton International (Kunshan) Inc. | | |
| Test Site Location | No. 1098, Pengxi North Road, Kunshan Economic Development Zone Jiangsu Province 215300 People's Republic of China TEL : +86-512-57900158 FAX : +86-512-57900958 | | |
| Test Site No. | Sporton Site No. | FCC Designation No. | FCC Test Firm Registration No. |
| | 03CH04-KS TH01-KS | CN1257 | 314309 |

1.9 Test Software

| Item | Site | Manufacturer | Name | Version |
|------|-----------|--------------|------|--------------|
| 1. | 03CH04-KS | AUDIX | E3 | 6.2009-8-24a |

1.10 Applied Standards

According to the specifications of the manufacturer, the EUT must comply with the requirements of the following standards:

- 47 CFR Part 2, 90(S)
- ANSI C63.26-2015
- FCC KDB 971168 D01 Power Meas. License Digital Systems v03r01
- FCC KDB 971168 D02 Misc Rev Approv License Devices v02r01

Remark:

1. All test items were verified and recorded according to the standards and without any deviation during the test.
2. This EUT has also been tested and complied with the requirements of FCC Part 15, Subpart B, recorded in a separate test report.



2 Test Configuration of Equipment Under Test

2.1 Test Mode

During all testing, EUT is in link mode with base station emulator at maximum power level. The spurious emission measurements were carried out in semi-anechoic chamber with 3-meter test range, and EUT is rotated on three test planes to find out the worst emission.

Frequency range investigated for radiated emission is 30 MHz to 9000 MHz.

| Test Items | Band | Bandwidth (MHz) | | | | | | Modulation | | | | RB # | | | Test Channel | | | |
|--|--|-----------------|---|---|----|----|----|------------|-------|-------|--------|------|------|------|--------------|---|---|---|
| | | 1.4 | 3 | 5 | 10 | 15 | 20 | QPSK | 16QAM | 64QAM | 256QAM | 1 | Half | Full | L | M | H | |
| Max. Output Power | 26 | v | v | v | v | v | - | v | v | v | v | v | v | v | v | v | v | v |
| 26dB and 99% Bandwidth | 26 | | | | v | v | - | v | v | | | | | v | | v | | |
| Emission masks In-band emissions | 26 | v | v | v | v | v | - | v | v | v | v | v | | v | v | | v | |
| Emission masks - Out of band emissions | 26 | v | v | v | v | v | - | v | | | | | v | | | v | v | v |
| Frequency Stability | 26 | | | | v | | - | v | | | | | v | | | | v | |
| Radiated Spurious Emission | 26 | | | | v | | - | v | | | | | v | | | | v | |
| Note | <ol style="list-style-type: none"> The mark "v " means that this configuration is chosen for testing The mark "- " means that this bandwidth is not supported. LTE Band26 transmit frequency for part22 rule is 824MHz-849MHz, for part90 rule is 814MHz-824MHz. ERP over 15MHz bandwidth complies the ERP limit line of part22 rule, therefore ERP of the partial frequency spectrum which falls within part 22 also complies. | | | | | | | | | | | | | | | | | |

2.2 Connection Diagram of Test System

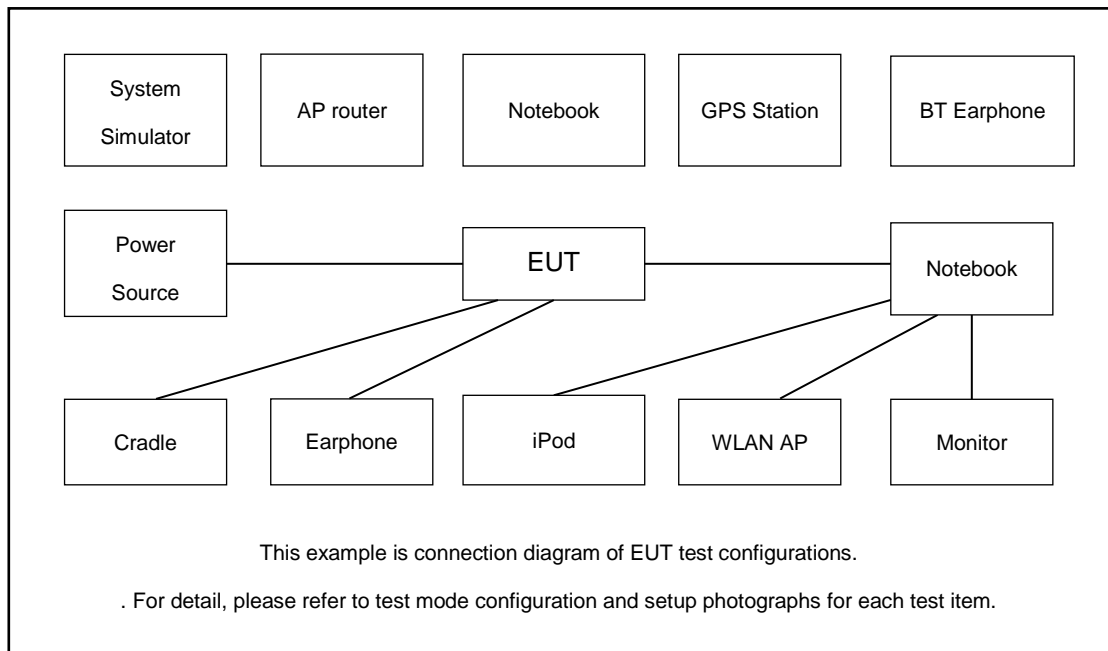

2.3 Support Unit used in test configuration and system

| Item | Equipment | Trade Name | Model No. | FCC ID | Data Cable | Power Cord |
|------|------------------|------------|-----------|--------|------------|-------------------|
| 1. | System Simulator | Anritsu | MT8820C | N/A | N/A | Unshielded, 1.8 m |

2.4 Measurement Results Explanation Example

For all conducted test items:

The offset level is set in the spectrum analyzer to compensate the RF cable loss between EUT conducted output port and spectrum analyzer. With the offset compensation, the spectrum analyzer reading level is exactly the EUT RF output level.

The spectrum analyzer offset is derived from RF cable loss.

Offset = RF cable loss.

Following shows an offset computation example with cable loss 4.80 dB.

Example :

$$\begin{aligned} \text{Offset(dB)} &= \text{RF cable loss(dB)}. \\ &= 4.80 \text{ (dB)} \end{aligned}$$



2.5 Frequency List of Low/Middle/High Channels

| LTE Band 26 Channel and Frequency List | | | | |
|--|------------------------|--------|--------|---------|
| BW [MHz] | Channel/Frequency(MHz) | Lowest | Middle | Highest |
| 15 | Channel | 26765 | - | - |
| | Frequency | 821.5 | - | - |
| 10 | Channel | - | 26740 | - |
| | Frequency | - | 819 | - |
| 5 | Channel | 26715 | 26740 | 26765 |
| | Frequency | 816.5 | 819 | 821.5 |
| 3 | Channel | 26705 | 26740 | 26775 |
| | Frequency | 815.5 | 819 | 822.5 |
| 1.4 | Channel | 26697 | 26740 | 26783 |
| | Frequency | 814.7 | 819 | 823.3 |

3 Test Result

3.1 Conducted Output Power Measurement

3.1.1 Description of the Conducted Output Power Measurement

A system simulator was used to establish communication with the EUT. Its parameters were set to enforce EUT transmitting at the maximum power. The measured power in the radio frequency on the transmitter output terminals shall be reported.

3.1.2 Measuring Instruments

The measuring equipment is listed in the section 4 of this test report.

3.1.3 Test Procedures

1. The transmitter output port was connected to the system simulator.
2. Set EUT at maximum power through the system simulator.
3. Select lowest, middle, and highest channels for each band and different modulation.
4. Measure and record the power level from the system simulator.

3.1.4 Test Setup



3.1.5 Test Result of Conducted Output Power

Please refer to Appendix A.

3.2 99% Occupied Bandwidth and 26dB Bandwidth Measurement

3.2.1 Description of (Occupied) Bandwidth Limitations Measurement

The 99% occupied bandwidth is the width of a frequency band such that, below the lower and above the upper frequency limits, the mean powers emitted are each equal to a specified percentage 0.5% of the total mean transmitted power.

The emission bandwidth is defined as the width of the signal between two points, located at the 2 sides of the carrier frequency, outside of which all emissions are attenuated at least 26 dB below the transmitter power.

3.2.2 Measuring Instruments

The measuring equipment is listed in the section 4 of this test report.

3.2.3 Test Procedures

1. The EUT was connected to spectrum analyzer and system simulator via a power divider.
2. The 26dB and 99% occupied bandwidth (BW) of the middle channel for the highest RF power with full RB sizes were measured.

3.2.4 Test Setup



3.2.5 Test Result of 99% Occupied Bandwidth and 26dB Bandwidth

Please refer to Appendix A.



3.3 Emissions Mask Measurement

3.3.1 Description of Emissions Mask Measurement

Equipment used in this licensed to EA or non-EA systems shall comply with the emission mask provisions of FCC Part 90.691.(a):

(a) Out-of-band emission requirement shall apply only to the “outer” channels included in an EA license and to spectrum adjacent to interior channels used by incumbent licensees. The emission limits are as follows:

(1) For any frequency removed from the EA licensee's frequency block by up to and including 37.5 kHz, the power of any emission shall be attenuated below the transmitter power (P) in watts by at least $116 \text{Log}_{10}(f/6.1)$ decibels or $50 + 10 \text{Log}_{10}(P)$ decibels or 80 decibels, whichever is the lesser attenuation, where f is the frequency removed from the center of the outer channel in the block in kilohertz and where f is greater than 12.5 kHz.

(2) For any frequency removed from the EA licensee's frequency block greater than 37.5 kHz, the power of any emission shall be attenuated below the transmitter power (P) in watts by at least $43 + 10\text{Log}_{10}(P)$ decibels or 80 decibels, whichever is the lesser attenuation, where f is the frequency removed from the center of the outer channel in the block in kilohertz and where f is greater than 37.5 kHz.

3.3.2 Measuring Instruments

The measuring equipment is listed in the section 4 of this test report.

3.3.3 Test Procedures

1. The EUT was connected to spectrum analyzer and base station via power divider.
2. The emissions mask of low and high channels for the highest RF powers were measured.
3. The measured RBW and the VBW set 3 times of RBW are then set in spectrum analyzer, and the RBW correction factor $10\log(1\% \text{ of OBW/measured RBW})(\text{dB})$ was compensated, if required.
4. The test results were shown below plots with a correction offset factor including cable loss, insertion loss of power divider.

3.3.4 Test Setup

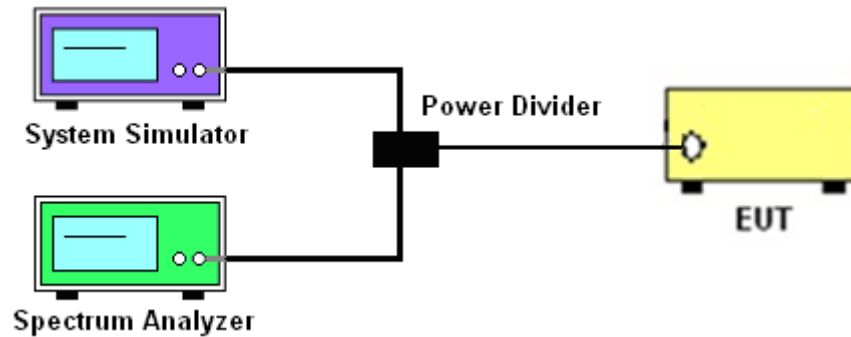

3.3.5 Test Result (Plots) of Conducted Emissions Mask

Please refer to Appendix A.

3.4 Emissions Mask – Out Of Band Emissions Measurement

3.4.1 Description of Conducted Emissions Out of band emissions measurement

The power of any emission FCC Part 90.691 (a)(2) on any frequency removed from the assigned frequency by out of the authorized bandwidth at least $43 + 10 \log (P)$ dB. It is measured by means of a calibrated spectrum analyzer and scanned from 30 MHz up to a frequency including its 10th harmonic.

3.4.2 Measuring Instruments

The measuring equipment is listed in the section 4 of this test report.

3.4.3 Test Procedures

1. The EUT was connected to spectrum analyzer and system simulator via a power divider.
2. The RF output of EUT was connected to the spectrum analyzer by RF cable and attenuator. The path loss was compensated to the results for each measurement.
3. The middle channel for the highest RF power within the transmitting frequency was measured.
4. The conducted spurious emission for the whole frequency range was taken.
5. Make the measurement with the spectrum analyzer's RBW = 1MHz, VBW = 3MHz, taking the record of maximum spurious emission.
6. The RF fundamental frequency should be excluded against the limit line in the operating frequency band.
7. The limit line is derived from $43 + 10\log(P)$ dB below the transmitter power P(Watts)

3.4.4 Test Setup

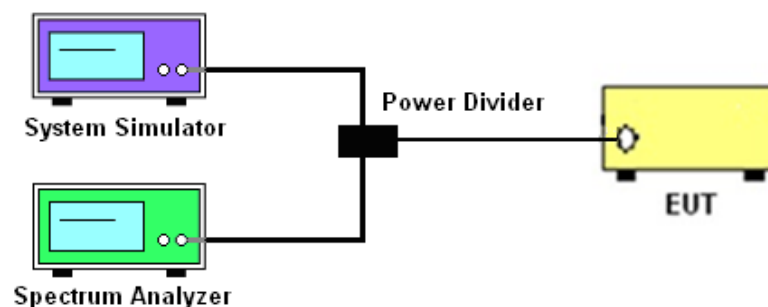

3.4.5 Test Result (Plots) of Conducted Emission

Please refer to Appendix A.



3.5 Field Strength of Spurious Radiation Measurement

3.5.1 Description of Field Strength of Spurious Radiated Measurement

The radiated spurious emission was measured by substitution method according to ANSI/TIA-603-E. The power of any emission FCC Part 90.691 on any frequency removed from the assigned frequency by more than 250 percent of the authorized bandwidth at least $43 + 10 \log (P)$ dB. The spectrum is scanned from 30 MHz up to a frequency including its 10th harmonic.

The power of any emission outside of the authorized operating frequency ranges must be attenuated below the transmitter power (P) by a factor of at least $43 + 10 \log_{10}(P[\text{Watts}])$ dB. The spectrum is scanned from 30 MHz up to a frequency including its 10th harmonic.

3.5.2 Measuring Instruments

The measuring equipment is listed in the section 4 of this test report.

3.5.3 Test Procedures

1. The EUT was placed on a turntable with 0.8 meter for frequency below 1GHz and 1.5 meter for frequency above 1GHz respectively above ground.
2. The EUT was set 3 meters from the receiving antenna, which was mounted on the antenna tower.
3. The table was rotated 360 degrees to determine the position of the highest spurious emission.
4. The height of the receiving antenna is varied between one meter and four meters to search the maximum spurious emission for both horizontal and vertical polarizations.
5. Make the measurement with the spectrum analyzer's RBW = 1MHz, VBW = 3MHz, Sweep = 500ms, Taking the record of maximum spurious emission.
6. A horn antenna was substituted in place of the EUT and was driven by a signal generator.
7. Tune the output power of signal generator to the same emission level with EUT maximum spurious emission.
8. Taking the record of output power at antenna port.
9. Repeat step 7 to step 8 for another polarization.
10. $\text{EIRP (dBm)} = \text{S.G. Power} - \text{Tx Cable Loss} + \text{Tx Antenna Gain}$
11. $\text{ERP (dBm)} = \text{EIRP} - 2.15$
12. The RF fundamental frequency should be excluded against the limit line in the operating frequency band.
13. The limit line is derived from $43 + 10 \log(P)$ dB below the transmitter power P(Watts)

3.5.4 Test Setup

For radiated test from 30MHz

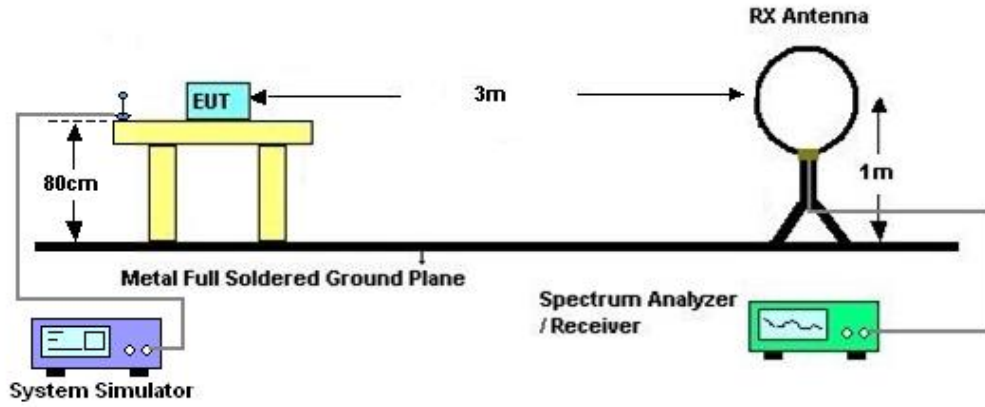

For radiated test from 30MHz to 1GHz

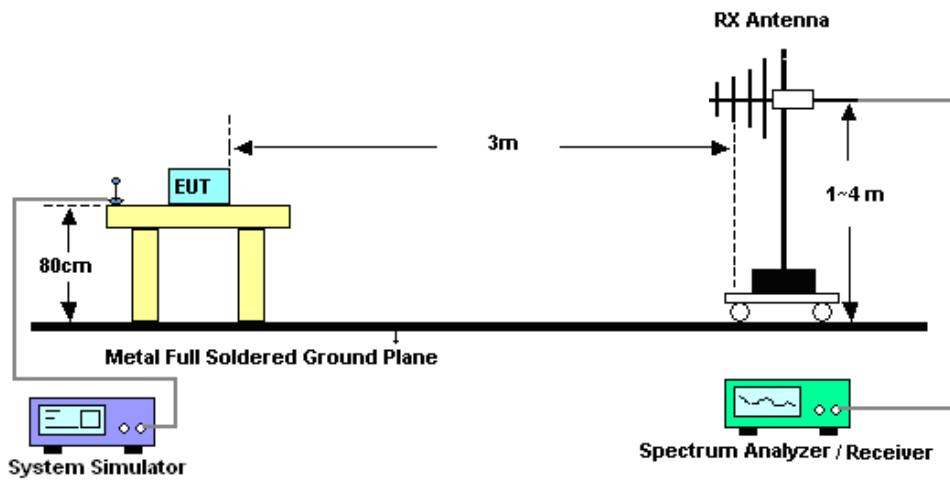

For radiated test above 1GHz



3.5.5 Test Result of Field Strength of Spurious Radiated

The low frequency, which started from 9 kHz to 30MHz, was pre-scanned and the result which was 20dB lower than the limit line was not reported.

Please refer to Appendix B.

3.6 Frequency Stability Measurement

3.6.1 Description of Frequency Stability Measurement

The frequency stability shall be measured by variation of ambient temperature and variation of primary supply voltage to ensure that the fundamental emission stays within the authorized frequency block. The frequency stability of the transmitter shall be maintained within $\pm 0.00025\%$ ($\pm 2.5\text{ppm}$) of the center frequency according to FCC Part 90.213.

3.6.2 Measuring Instruments

The measuring equipment is listed in the section 4 of this test report.

3.6.3 Test Procedures for Temperature Variation

1. The EUT was set up in the thermal chamber and connected with the base station.
2. With power OFF, the temperature was decreased to -30°C and the EUT was stabilized for three hours. Power was applied and the maximum change in frequency was recorded within one minute.
3. With power OFF, the temperature was raised in 10°C step up to 50°C . The EUT was stabilized at each step for at least half an hour. Power was applied and the maximum frequency change was recorded within one minute.

3.6.4 Test Procedures for Voltage Variation

1. The EUT was placed in a temperature chamber at $20\pm 5^{\circ}\text{C}$ and connected with the system simulator.
2. The power supply voltage to the EUT was varied from 85% to 115% of the nominal value for other than hand carried battery equipment.
3. For hand carried, battery powered equipment, reduce the primary ac or dc supply voltage to the battery operating end point, which shall be specified by the manufacturer.
4. The variation in frequency was measured for the worst case.

3.6.5 Test Setup



3.6.6 Test Result of Temperature Variation

Please refer to Appendix A.



4 List of Measuring Equipment

| Instrument | Manufacturer | Model No. | Serial No. | Characteristics | Calibration Date | Test Date | Due Date | Remark |
|--------------------------------|--------------|--------------------------------|-------------|-------------------------|------------------|---------------------------------|---------------|--------------------------|
| Spectrum Analyzer | R&S | FSV40 | 101040 | 10Hz~40GHz | Oct. 14, 2021 | Nov. 23, 2021~ Nov. 28, 2021 | Oct. 13, 2022 | Conducted (TH01-KS) |
| Power divider | STI | STI08-0055 | - | 0.5~40GHz | Aug. 26, 2021 | Nov. 23, 2021~ Nov. 28, 2021 | Aug. 25, 2022 | Conducted (TH01-KS) |
| Temperature & humidity chamber | Hongzhan | LP-150U | H2014011440 | -40~+150°C 20%~95%RH | Jul. 12, 2021 | Nov. 23, 2021~ Nov. 28, 2021 | Jul. 11, 2022 | Conducted (TH01-KS) |
| EXA Spectrum Analyzer | Keysight | N9010A | MY55150244 | 10Hz-44G,MAX 30dB | Apr. 13, 2021 | Jan. 01, 2022 | Apr. 12, 2022 | Radiation (03CH04-KS) |
| Loop Antenna | R&S | HFH2-Z2 | 100321 | 9kHz~30MHz | Oct. 30, 2021 | Jan. 01, 2022 | Oct. 29, 2022 | Radiation (03CH04-KS) |
| Bilog Antenna | TeseQ | CBL6111D | 49922 | 30MHz-1GHz | May 30, 2021 | Jan. 01, 2022 | May 29, 2022 | Radiation (03CH04-KS) |
| Horn Antenna | Schwarzbeck | BBHA9120D | 1356 | 1GHz~18GHz | Apr. 18, 2021 | Jan. 01, 2022 | Apr. 17, 2022 | Radiation (03CH04-KS) |
| SHF-EHF Horn | Com-power | AH-840 | 101070 | 18GHz~40GHz | Jan. 06, 2021 | Jan. 01, 2022 | Jan. 05, 2022 | Radiation (03CH04-KS) |
| Amplifier | SONOMA | 310N | 187289 | 9KHz-1GHz | Jan. 06, 2021 | Jan. 01, 2022 | Jan. 05, 2022 | Radiation (03CH04-KS) |
| Amplifier | MITEQ | EM18G40G GA | 060728 | 18~40GHz | Jan. 06, 2021 | Jan. 01, 2022 | Jan. 05, 2022 | Radiation (03CH04-KS) |
| high gain Amplifier | MITEQ | AMF-7D-00 101800-30-1 0P | 2025788 | 1Ghz-18Ghz | Jan. 06, 2021 | Jan. 01, 2022 | Jan. 05, 2022 | Radiation (03CH04-KS) |
| Amplifier | Keysight | 83017A | MY57280106 | 500MHz~26.5GHz | Oct. 13, 2021 | Jan. 01, 2022 | Oct. 12, 2022 | Radiation (03CH04-KS) |
| AC Power Source | Chroma | 61601 | F104090004 | N/A | NCR | Jan. 01, 2022 | NCR | Radiation (03CH04-KS) |
| Turn Table | ChamPro | EM 1000-T | 060762-T | 0~360 degree | NCR | Jan. 01, 2022 | NCR | Radiation (03CH04-KS) |
| Antenna Mast | ChamPro | EM 1000-A | 060762-A | 1 m~4 m | NCR | Jan. 01, 2022 | NCR | Radiation (03CH04-KS) |

NCR: No Calibration Required



5 Uncertainty of Evaluation

The measurement uncertainties shown below were calculated in accordance with the requirements of ANSI 63.26-2015. All the measurement uncertainty value were shown with a coverage K=2 to indicate 95% level of confidence. The measurement data show herein meets or exceeds the CISPR measurement uncertainty values specified in CISPR 16-4-2 and can be compared directly to specified limit to determine compliance.

Uncertainty of Radiated Emission Measurement (30 MHz ~ 1000 MHz)

| | |
|---|-------|
| Measuring Uncertainty For A Level of Confidence Of 95% (U = 2uc(Y)) | 3.3dB |
|---|-------|

Uncertainty of Radiated Emission Measurement (1 GHz ~ 18 GHz)

| | |
|---|-------|
| Measuring Uncertainty For A Level of Confidence Of 95% (U = 2uc(Y)) | 2.8dB |
|---|-------|

Uncertainty of Radiated Emission Measurement (18 GHz ~ 40 GHz)

| | |
|---|-------|
| Measuring Uncertainty For A Level of Confidence Of 95% (U = 2uc(Y)) | 2.8dB |
|---|-------|

----- THE END -----



Appendix A. Test Results of Conducted Test

Conducted Output Power (Average power)

| BW [MHz] | Modulation | RB Size | RB Offset | Power Low Ch. / Freq. | Power Middle Ch. / Freq. | Power High Ch. / Freq. |
|-----------------|------------|---------|-----------|-----------------------|--------------------------|------------------------|
| Channel | | | | 26765 | | |
| Frequency (MHz) | | | | 821.5 | | |
| 15 | QPSK | 1 | 0 | 22.88 | | |
| 15 | QPSK | 1 | 37 | 23.02 | | |
| 15 | QPSK | 1 | 74 | 22.79 | | |
| 15 | QPSK | 36 | 0 | 22.90 | | |
| 15 | QPSK | 36 | 20 | 23.03 | | |
| 15 | QPSK | 36 | 39 | 22.95 | | |
| 15 | QPSK | 75 | 0 | 23.08 | | |
| 15 | 16QAM | 1 | 0 | 22.75 | | |
| 15 | 16QAM | 1 | 37 | 22.82 | | |
| 15 | 16QAM | 1 | 74 | 22.78 | | |
| 15 | 16QAM | 36 | 0 | 22.06 | | |
| 15 | 16QAM | 36 | 20 | 22.14 | | |
| 15 | 16QAM | 36 | 39 | 22.05 | | |
| 15 | 16QAM | 75 | 0 | 22.16 | | |
| 15 | 16QAM | 1 | 0 | 22.79 | | |
| 15 | 16QAM | 1 | 37 | 22.96 | | |
| 15 | 16QAM | 1 | 74 | 23.02 | | |
| 15 | 16QAM | 36 | 0 | 22.26 | | |
| 15 | 16QAM | 36 | 20 | 22.34 | | |
| 15 | 16QAM | 36 | 39 | 22.25 | | |
| 15 | 16QAM | 75 | 0 | 22.34 | | |
| 15 | 16QAM | 1 | 0 | 19.44 | | |
| 15 | 16QAM | 1 | 37 | 19.58 | | |
| 15 | 16QAM | 1 | 74 | 19.35 | | |
| 15 | 16QAM | 36 | 0 | 19.44 | | |
| 15 | 16QAM | 36 | 20 | 19.63 | | |
| 15 | 16QAM | 36 | 39 | 19.68 | | |
| 15 | 16QAM | 75 | 0 | 19.55 | | |
| Channel | | | | | 26740 | |
| Frequency (MHz) | | | | | 819 | |
| 10 | QPSK | 1 | 0 | | 23.01 | |
| 10 | QPSK | 1 | 25 | | 22.74 | |
| 10 | QPSK | 1 | 49 | | 22.75 | |
| 10 | QPSK | 25 | 0 | | 22.62 | |
| 10 | QPSK | 25 | 12 | | 22.74 | |
| 10 | QPSK | 25 | 25 | | 22.85 | |
| 10 | QPSK | 50 | 0 | | 22.86 | |



| | | | | | | |
|-----------------|-------|----|----|-------|-------|-------|
| 10 | 16QAM | 1 | 0 | | 22.52 | |
| 10 | 16QAM | 1 | 25 | | 22.64 | |
| 10 | 16QAM | 1 | 49 | | 22.56 | |
| 10 | 16QAM | 25 | 0 | | 22.62 | |
| 10 | 16QAM | 25 | 12 | | 22.64 | |
| 10 | 16QAM | 25 | 25 | | 22.52 | |
| 10 | 16QAM | 50 | 0 | | 22.63 | |
| 10 | 16QAM | 1 | 0 | | 22.61 | |
| 10 | 16QAM | 1 | 25 | | 22.80 | |
| 10 | 16QAM | 1 | 49 | | 22.88 | |
| 10 | 16QAM | 25 | 0 | | 22.20 | |
| 10 | 16QAM | 25 | 12 | | 22.15 | |
| 10 | 16QAM | 25 | 25 | | 22.11 | |
| 10 | 16QAM | 50 | 0 | | 22.06 | |
| 10 | 16QAM | 1 | 0 | | 19.62 | |
| 10 | 16QAM | 1 | 25 | | 19.45 | |
| 10 | 16QAM | 1 | 49 | | 19.35 | |
| 10 | 16QAM | 25 | 0 | | 19.40 | |
| 10 | 16QAM | 25 | 12 | | 19.36 | |
| 10 | 16QAM | 25 | 25 | | 19.36 | |
| 10 | 16QAM | 50 | 0 | | 19.45 | |
| Channel | | | | 26715 | 26740 | 26765 |
| Frequency (MHz) | | | | 816.5 | 819 | 821.5 |
| 5 | QPSK | 1 | 0 | 22.65 | 22.93 | 22.75 |
| 5 | QPSK | 1 | 12 | 22.72 | 22.77 | 22.98 |
| 5 | QPSK | 1 | 24 | 22.71 | 22.69 | 22.78 |
| 5 | QPSK | 12 | 0 | 22.60 | 22.59 | 22.74 |
| 5 | QPSK | 12 | 7 | 22.92 | 22.72 | 22.84 |
| 5 | QPSK | 12 | 13 | 22.78 | 22.85 | 23.00 |
| 5 | QPSK | 25 | 0 | 22.98 | 22.82 | 23.05 |
| 5 | 16QAM | 1 | 0 | 22.53 | 22.59 | 22.64 |
| 5 | 16QAM | 1 | 12 | 22.63 | 22.63 | 22.83 |
| 5 | 16QAM | 1 | 24 | 22.62 | 22.59 | 22.69 |
| 5 | 16QAM | 12 | 0 | 22.59 | 22.60 | 22.86 |
| 5 | 16QAM | 12 | 7 | 22.46 | 22.60 | 22.47 |
| 5 | 16QAM | 12 | 13 | 22.55 | 22.42 | 22.51 |
| 5 | 16QAM | 25 | 0 | 22.41 | 22.50 | 22.51 |
| 5 | 16QAM | 1 | 0 | 22.54 | 22.59 | 22.68 |
| 5 | 16QAM | 1 | 12 | 22.66 | 22.74 | 22.97 |
| 5 | 16QAM | 1 | 24 | 22.85 | 22.80 | 22.96 |
| 5 | 16QAM | 12 | 0 | 22.18 | 22.10 | 22.09 |
| 5 | 16QAM | 12 | 7 | 22.46 | 22.46 | 22.48 |
| 5 | 16QAM | 12 | 13 | 22.11 | 22.07 | 22.23 |
| 5 | 16QAM | 25 | 0 | 22.04 | 22.15 | 22.20 |
| 5 | 16QAM | 1 | 0 | 19.29 | 19.45 | 19.25 |
| 5 | 16QAM | 1 | 12 | 19.29 | 19.26 | 19.41 |
| 5 | 16QAM | 1 | 24 | 19.17 | 19.33 | 19.42 |



| | | | | | | |
|-----------------|-------|----|----|-------|-------|-------|
| 5 | 16QAM | 12 | 0 | 19.27 | 19.58 | 19.41 |
| 5 | 16QAM | 12 | 7 | 19.51 | 19.50 | 19.40 |
| 5 | 16QAM | 12 | 13 | 19.40 | 19.38 | 19.49 |
| 5 | 16QAM | 25 | 0 | 19.46 | 19.65 | 19.44 |
| Channel | | | | 26705 | 26740 | 26775 |
| Frequency (MHz) | | | | 815.5 | 819 | 822.5 |
| 3 | QPSK | 1 | 0 | 22.61 | 23.01 | 22.79 |
| 3 | QPSK | 1 | 8 | 22.74 | 22.76 | 22.99 |
| 3 | QPSK | 1 | 14 | 22.68 | 22.76 | 22.74 |
| 3 | QPSK | 8 | 0 | 22.61 | 22.62 | 22.83 |
| 3 | QPSK | 8 | 4 | 22.90 | 22.71 | 22.88 |
| 3 | QPSK | 8 | 7 | 22.73 | 22.80 | 22.96 |
| 3 | QPSK | 15 | 0 | 22.87 | 22.84 | 22.99 |
| 3 | 16QAM | 1 | 0 | 22.51 | 22.57 | 22.67 |
| 3 | 16QAM | 1 | 8 | 22.66 | 22.62 | 22.91 |
| 3 | 16QAM | 1 | 14 | 22.70 | 22.58 | 22.76 |
| 3 | 16QAM | 8 | 0 | 22.56 | 22.63 | 22.79 |
| 3 | 16QAM | 8 | 4 | 22.42 | 22.57 | 22.53 |
| 3 | 16QAM | 8 | 7 | 22.41 | 22.37 | 22.52 |
| 3 | 16QAM | 15 | 0 | 22.42 | 22.38 | 22.56 |
| 3 | 16QAM | 1 | 0 | 22.60 | 22.71 | 22.66 |
| 3 | 16QAM | 1 | 8 | 22.72 | 22.78 | 22.94 |
| 3 | 16QAM | 1 | 14 | 22.77 | 22.79 | 22.95 |
| 3 | 16QAM | 8 | 0 | 22.10 | 22.09 | 22.13 |
| 3 | 16QAM | 8 | 4 | 22.45 | 22.53 | 22.50 |
| 3 | 16QAM | 8 | 7 | 22.16 | 22.04 | 22.21 |
| 3 | 16QAM | 15 | 0 | 22.09 | 22.11 | 22.20 |
| 3 | 16QAM | 1 | 0 | 19.20 | 19.53 | 19.25 |
| 3 | 16QAM | 1 | 8 | 19.33 | 19.33 | 19.54 |
| 3 | 16QAM | 1 | 14 | 19.33 | 19.38 | 19.50 |
| 3 | 16QAM | 8 | 0 | 19.34 | 19.49 | 19.51 |
| 3 | 16QAM | 8 | 4 | 19.42 | 19.37 | 19.28 |
| 3 | 16QAM | 8 | 7 | 19.36 | 19.39 | 19.39 |
| 3 | 16QAM | 15 | 0 | 19.41 | 19.57 | 19.41 |
| Channel | | | | 26697 | 26740 | 26783 |
| Frequency (MHz) | | | | 814.7 | 819 | 823.3 |
| 1.4 | QPSK | 1 | 0 | 22.66 | 23.00 | 22.79 |
| 1.4 | QPSK | 1 | 3 | 22.76 | 22.74 | 22.89 |
| 1.4 | QPSK | 1 | 5 | 22.61 | 22.80 | 22.79 |
| 1.4 | QPSK | 3 | 0 | 22.55 | 22.59 | 22.85 |
| 1.4 | QPSK | 3 | 1 | 22.92 | 22.67 | 22.92 |
| 1.4 | QPSK | 3 | 3 | 22.80 | 22.86 | 22.93 |
| 1.4 | QPSK | 6 | 0 | 22.98 | 22.80 | 23.06 |
| 1.4 | 16QAM | 1 | 0 | 22.51 | 22.58 | 22.65 |
| 1.4 | 16QAM | 1 | 3 | 22.60 | 22.67 | 22.90 |
| 1.4 | 16QAM | 1 | 5 | 22.68 | 22.58 | 22.77 |
| 1.4 | 16QAM | 3 | 0 | 22.60 | 22.55 | 22.87 |



| | | | | | | |
|-----|-------|---|---|-------|-------|-------|
| 1.4 | 16QAM | 3 | 1 | 22.56 | 22.60 | 22.55 |
| 1.4 | 16QAM | 3 | 3 | 22.42 | 22.40 | 22.55 |
| 1.4 | 16QAM | 6 | 0 | 22.44 | 22.52 | 22.46 |
| 1.4 | 16QAM | 1 | 0 | 22.63 | 22.68 | 22.59 |
| 1.4 | 16QAM | 1 | 3 | 22.71 | 22.81 | 22.98 |
| 1.4 | 16QAM | 1 | 5 | 22.81 | 22.78 | 22.86 |
| 1.4 | 16QAM | 3 | 0 | 22.13 | 22.54 | 22.52 |
| 1.4 | 16QAM | 3 | 1 | 22.39 | 22.58 | 22.54 |
| 1.4 | 16QAM | 3 | 3 | 22.13 | 22.50 | 22.28 |
| 1.4 | 16QAM | 6 | 0 | 22.12 | 22.15 | 22.12 |
| 1.4 | 16QAM | 1 | 0 | 19.25 | 19.45 | 19.34 |
| 1.4 | 16QAM | 1 | 3 | 19.46 | 19.43 | 19.48 |
| 1.4 | 16QAM | 1 | 5 | 19.18 | 19.46 | 19.44 |
| 1.4 | 16QAM | 3 | 0 | 19.41 | 19.40 | 19.36 |
| 1.4 | 16QAM | 3 | 1 | 19.32 | 19.39 | 19.33 |
| 1.4 | 16QAM | 3 | 3 | 19.48 | 19.32 | 19.51 |
| 1.4 | 16QAM | 6 | 0 | 19.46 | 19.61 | 19.46 |



LTE Band 26_Part 90S

Peak-to-Average Ratio

| Mode | LTE Band 26 / 15MHz | | | | |
|---------|---------------------|---------|---------|---------|-------------|
| Mod. | QPSK | 16QAM | 64QAM | 256QAM | Limit: 13dB |
| RB Size | Full RB | Full RB | Full RB | Full RB | Result |
| Low CH | 4.93 | 5.68 | 6.23 | 4.87 | PASS |

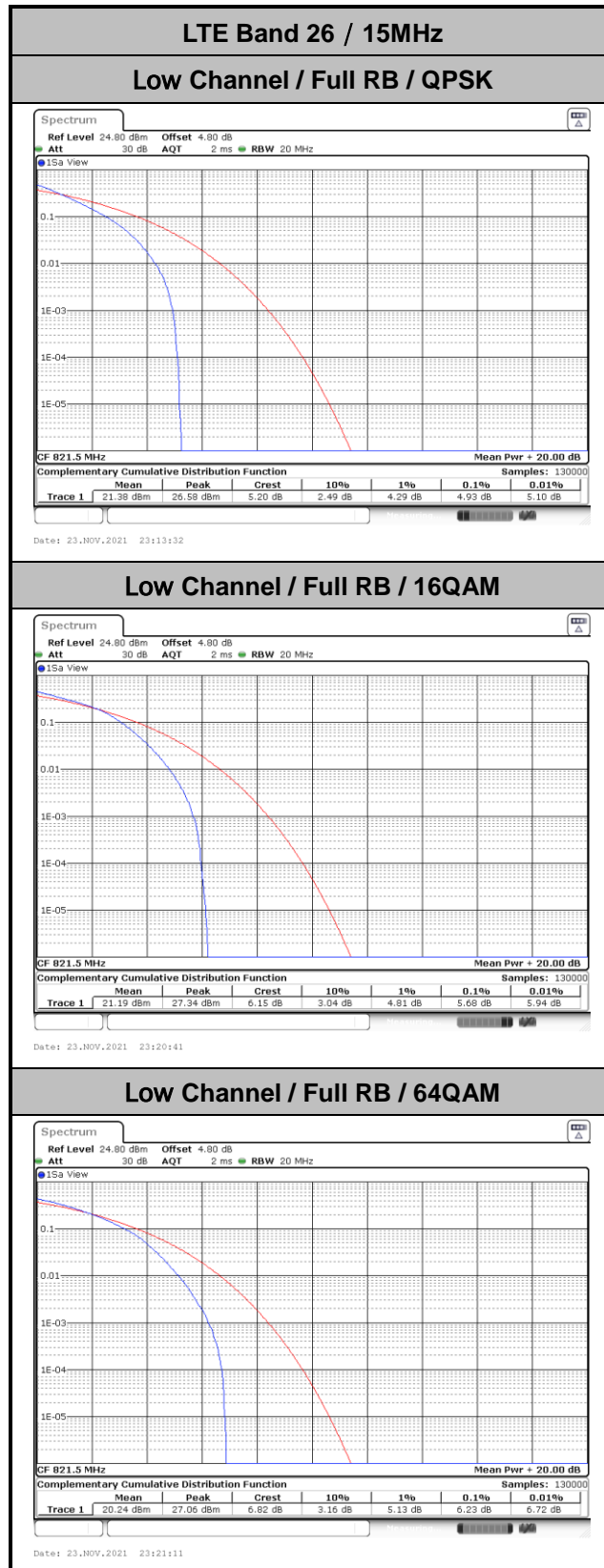

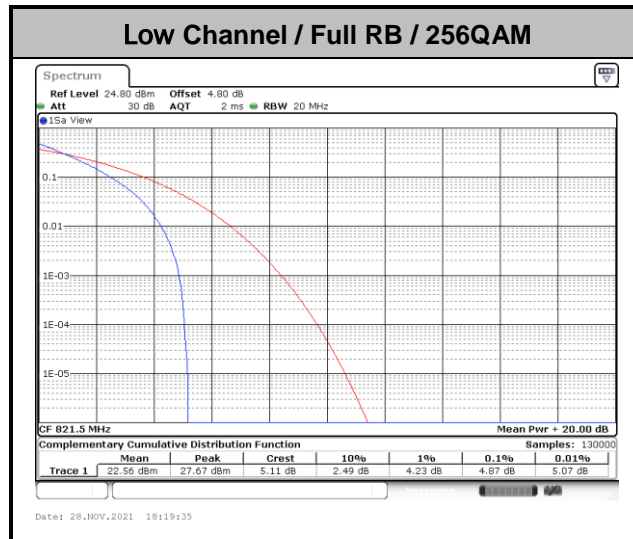



26dB Bandwidth

| | | |
|--------|----------------------------|-------|
| Mode | LTE Band 26 : 26dB BW(MHz) | |
| BW | 15MHz | |
| Mod. | QPSK | 16QAM |
| Low CH | 14.60 | 14.21 |

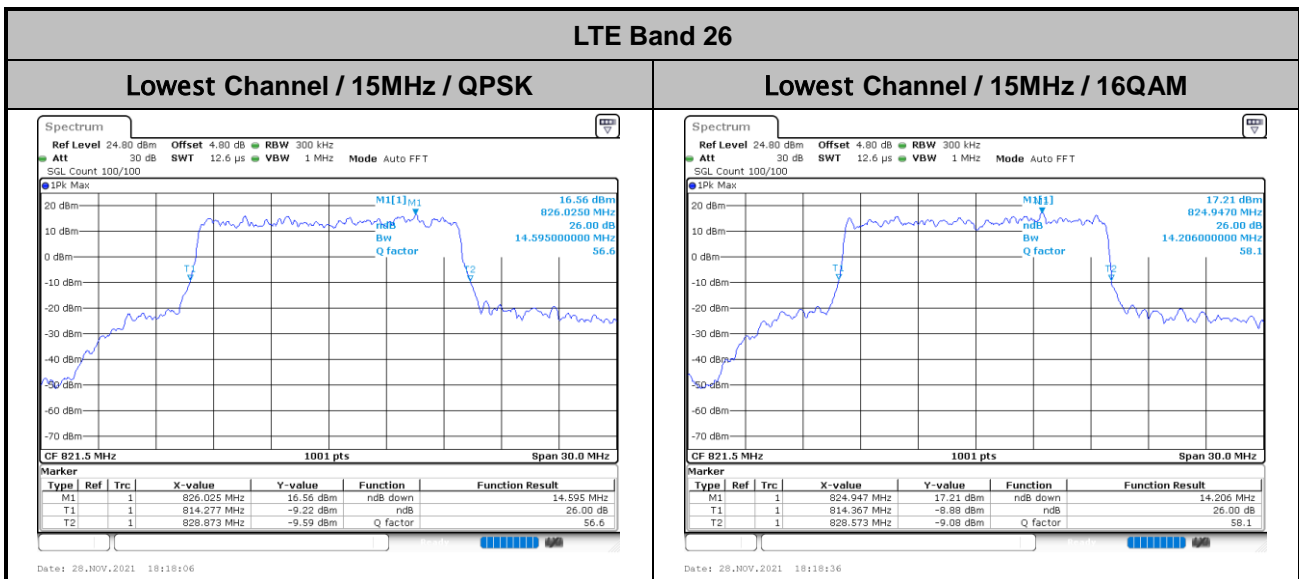



| | | |
|--------|----------------------------|-------|
| Mode | LTE Band 26 : 26dB BW(MHz) | |
| BW | 10MHz | |
| Mod. | QPSK | 16QAM |
| Low CH | 9.89 | 9.91 |

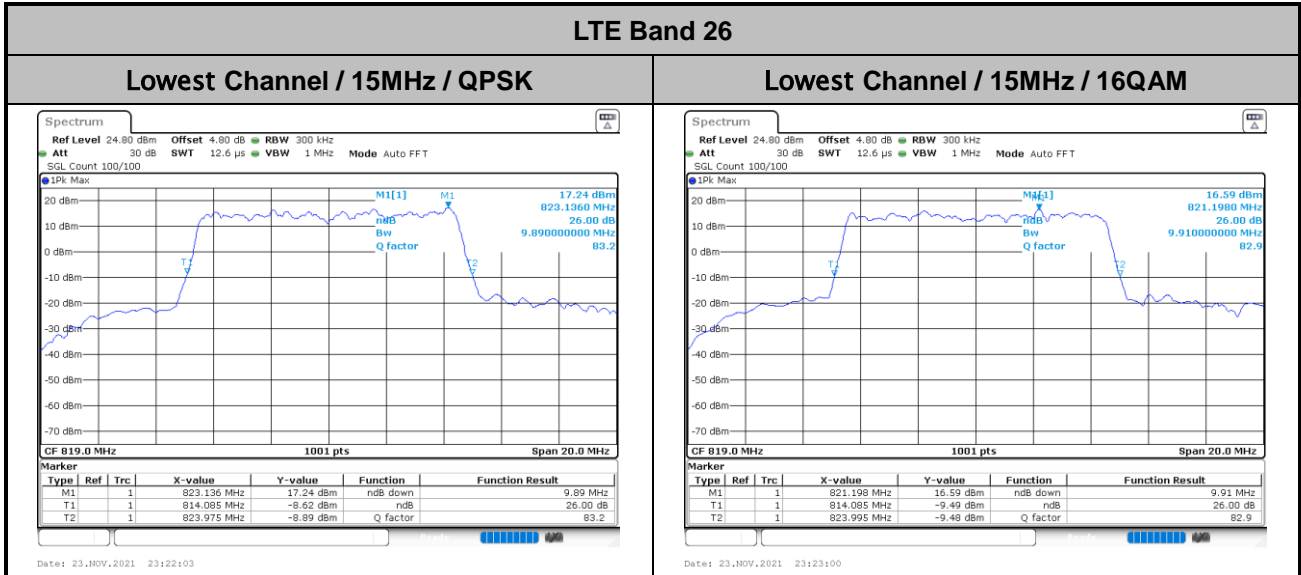



Occupied Bandwidth

| | | |
|---------------|----------------------------------|--------------|
| Mode | LTE Band 26 : 99%OBW(MHz) | |
| BW | 15MHz | |
| Mod. | QPSK | 16QAM |
| Low CH | 13.46 | 13.46 |

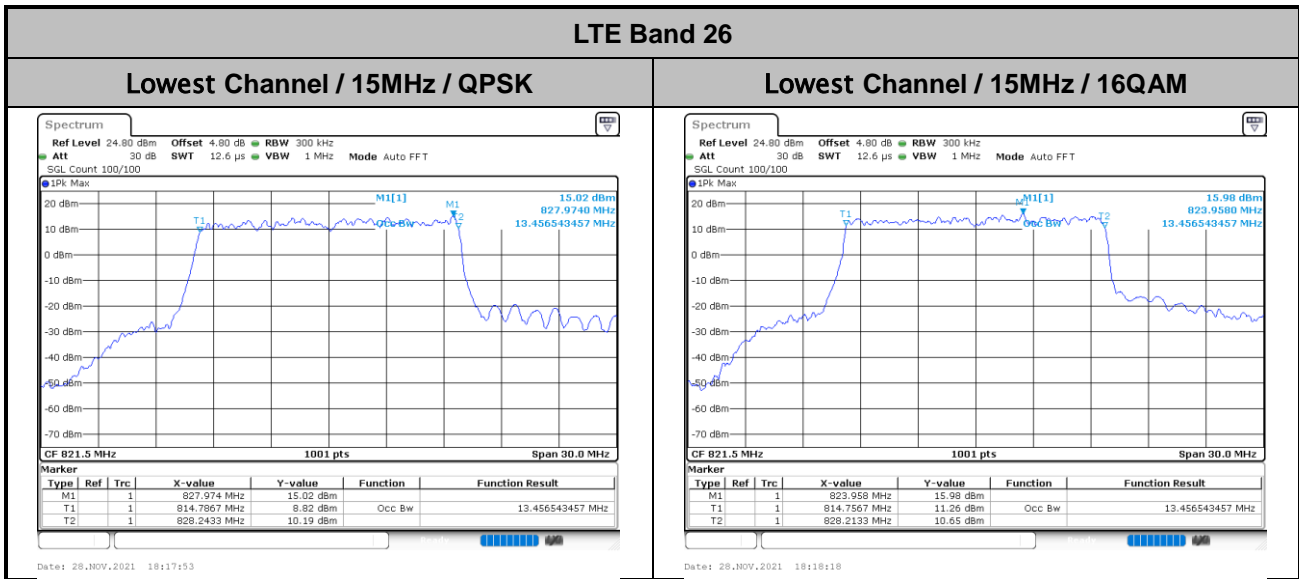



| | | |
|--------|---------------------------|-------|
| Mode | LTE Band 26 : 99%OBW(MHz) | |
| BW | 10MHz | |
| Mod. | QPSK | 16QAM |
| Low CH | 9.05 | 9.05 |

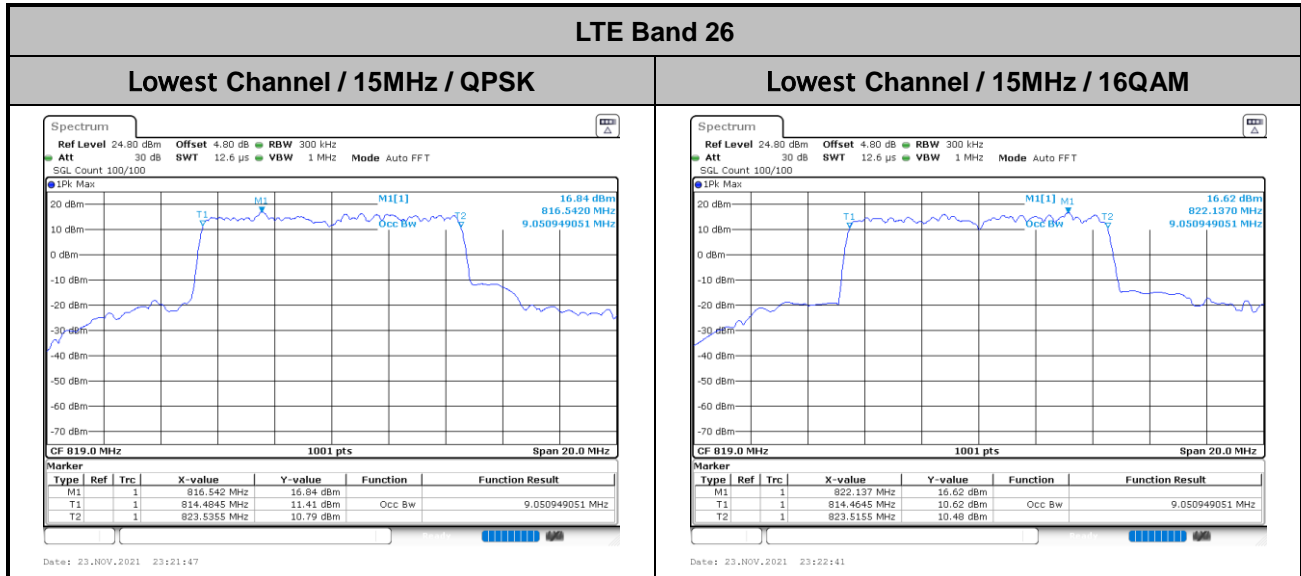



Conducted Band Edge

LTE Band 26 / 1.4MHz / QPSK

Lowest Band Edge / 1RB

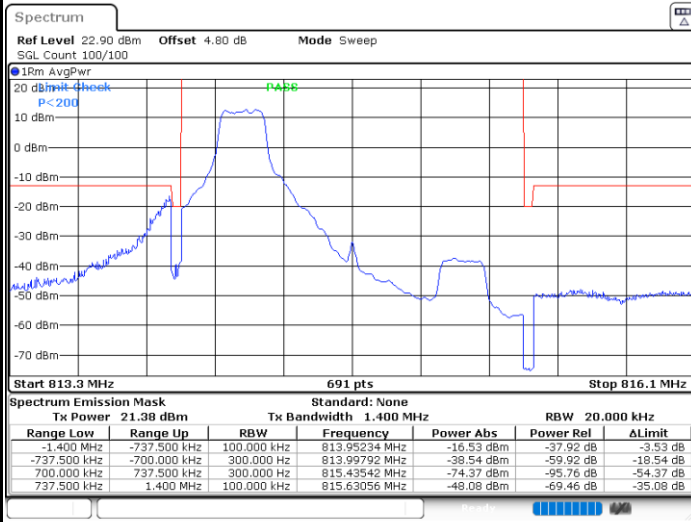

Highest Band Edge / 1RB

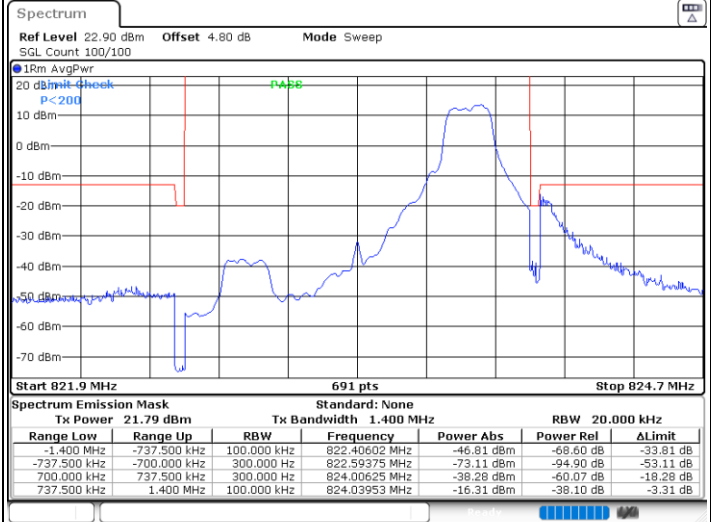

Lowest Band Edge / Full RB

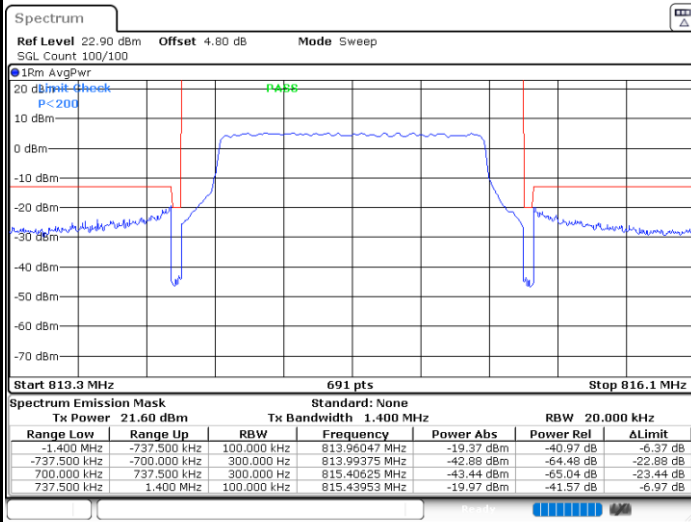

Highest Band Edge / Full RB

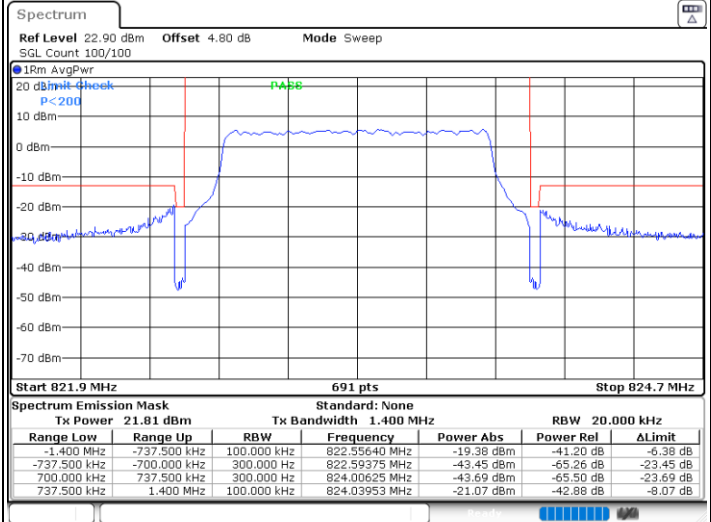



LTE Band 26 / 1.4MHz / 16QAM

Lowest Band Edge / 1 RB

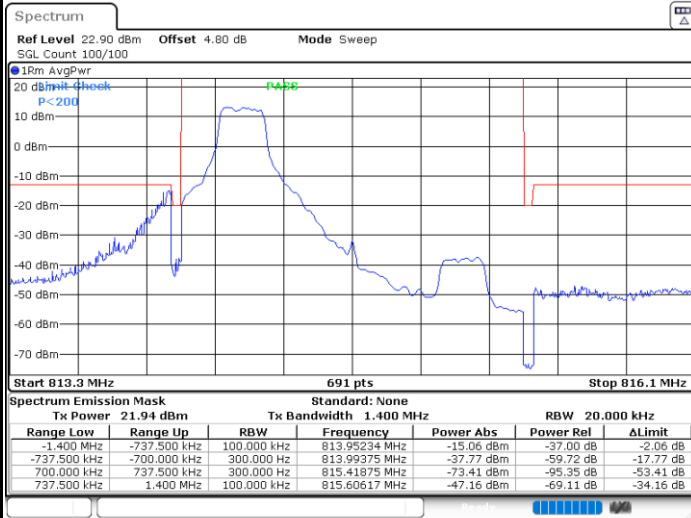

Date: 23.NOV.2021 21:54:10

Highest Band Edge / 1 RB

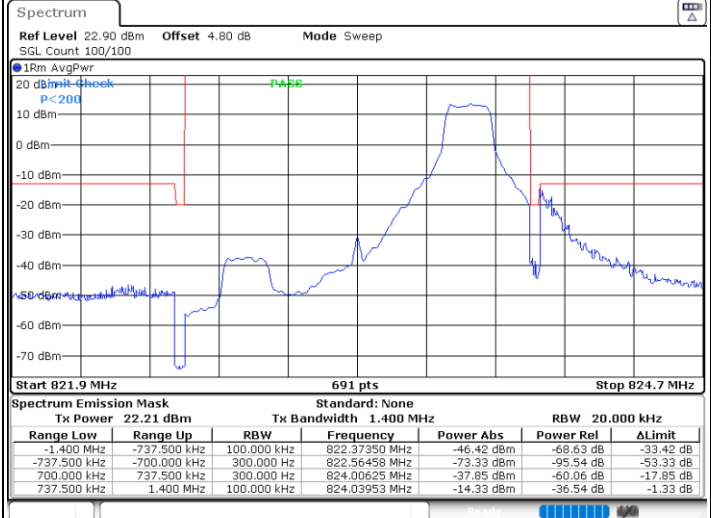

Date: 23.NOV.2021 21:59:47

Lowest Band Edge / Full RB

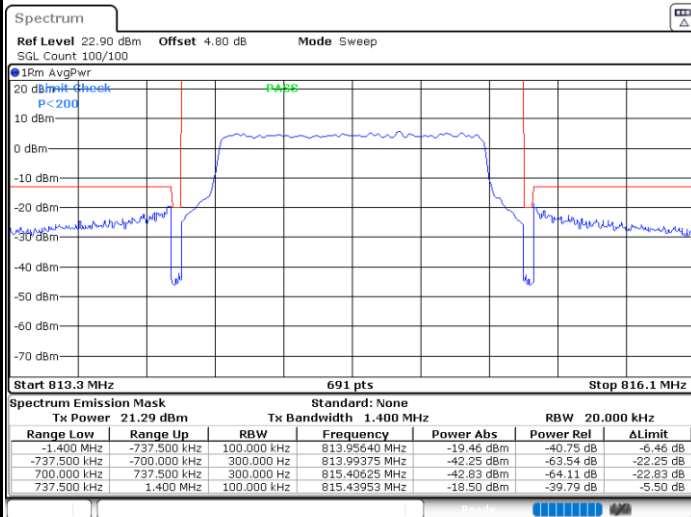

Date: 23.NOV.2021 21:56:58

Highest Band Edge / Full RB

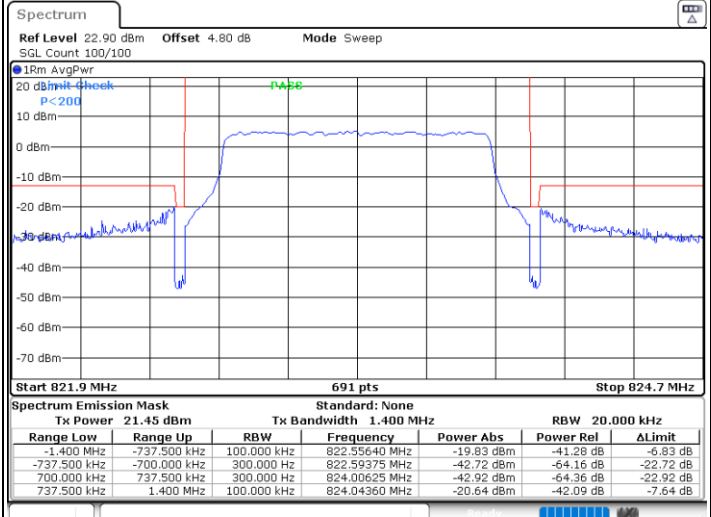

Date: 23.NOV.2021 22:02:35



LTE Band 26 / 1.4MHz / 64QAM

Lowest Band Edge / 1 RB

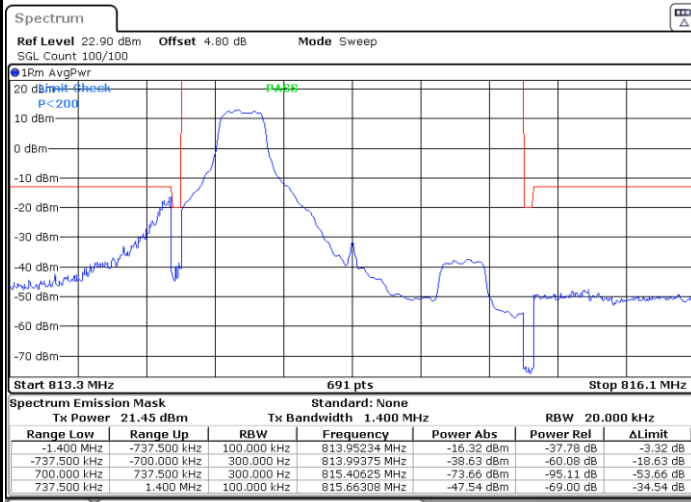

Date: 23.NOV.2021 22:03:59

Highest Band Edge / 1 RB

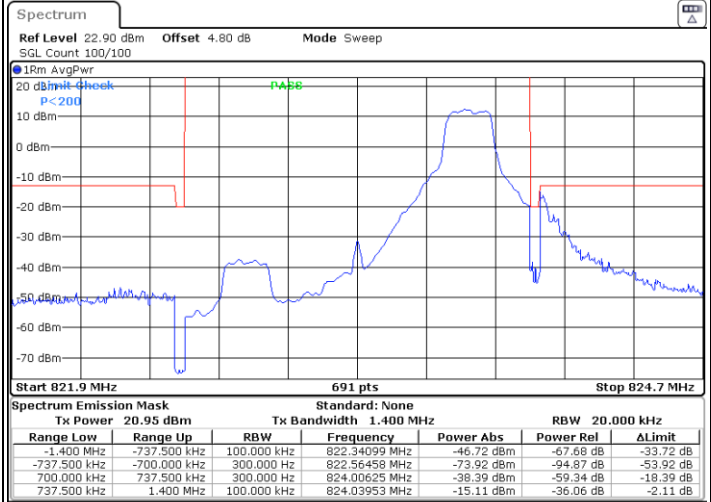

Date: 23.NOV.2021 22:06:48

Lowest Band Edge / Full RB

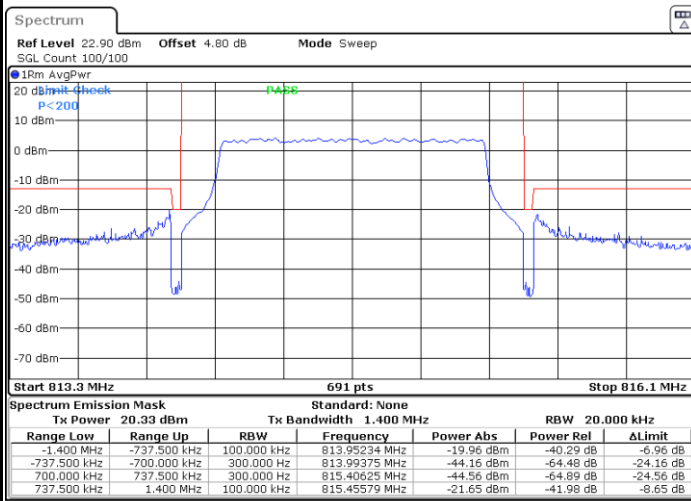

Date: 23.NOV.2021 22:05:23

Highest Band Edge / Full RB

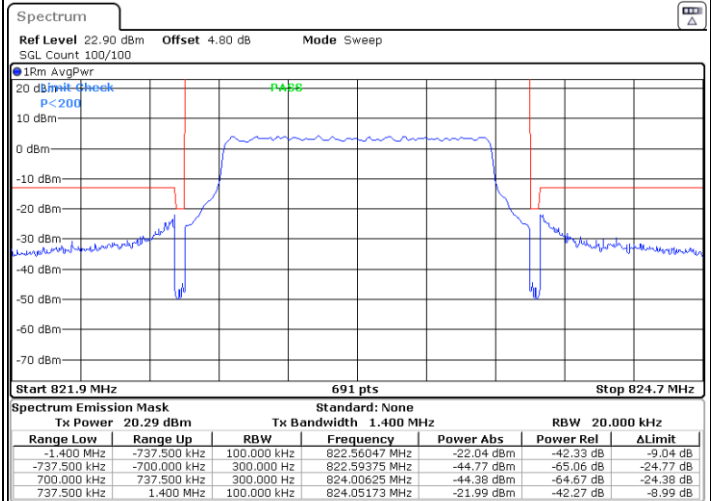

Date: 23.NOV.2021 22:08:12



LTE Band 26 / 1.4MHz / 256QAM

Lowest Band Edge / 1 RB

Highest Band Edge / 1 RB

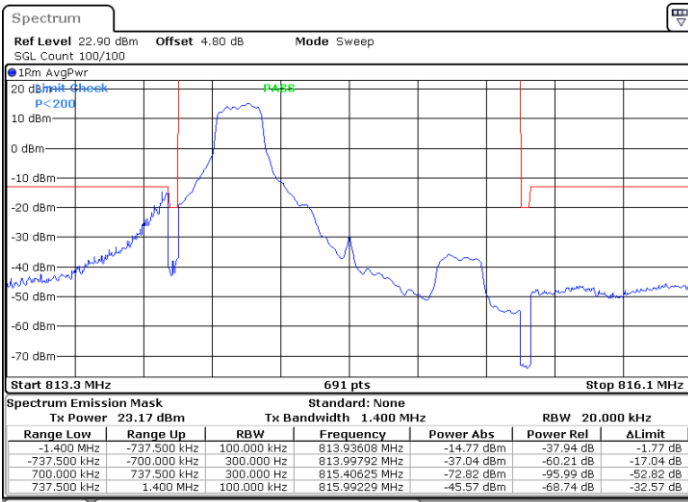

Date: 28.NOV.2021 15:03:20

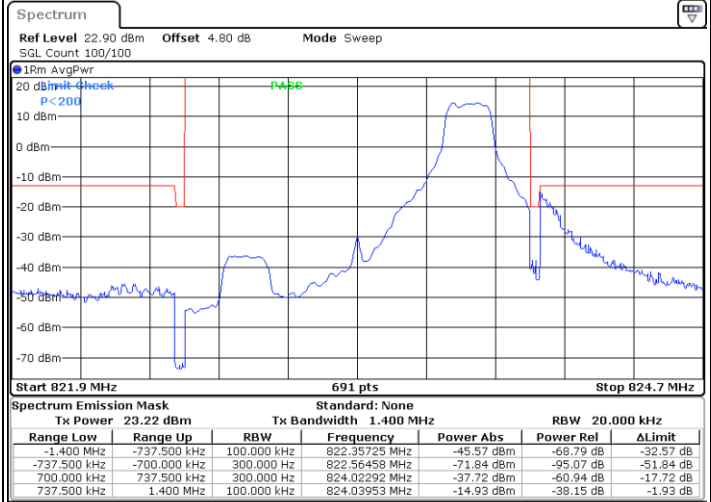

Date: 28.NOV.2021 15:11:22

Lowest Band Edge / Full RB

Highest Band Edge / Full RB

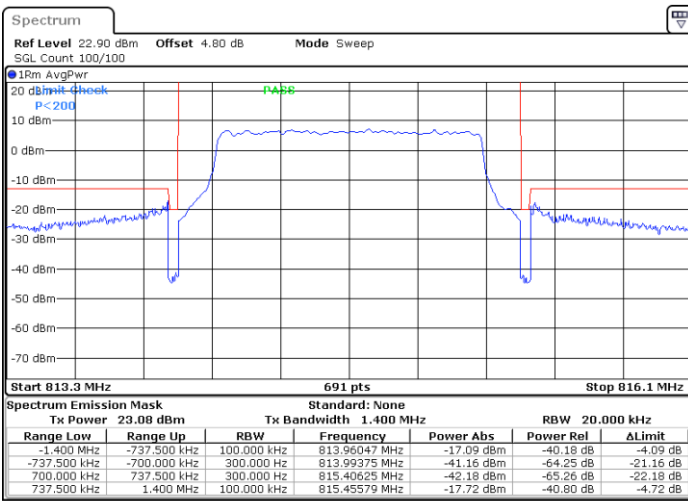

Date: 28.NOV.2021 15:00:45

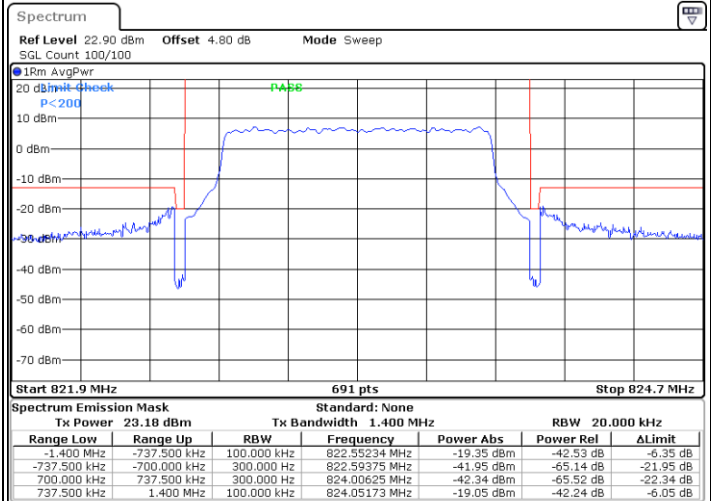

Date: 28.NOV.2021 15:14:44



LTE Band 26 / 3MHz / QPSK

Lowest Band Edge / 1RB

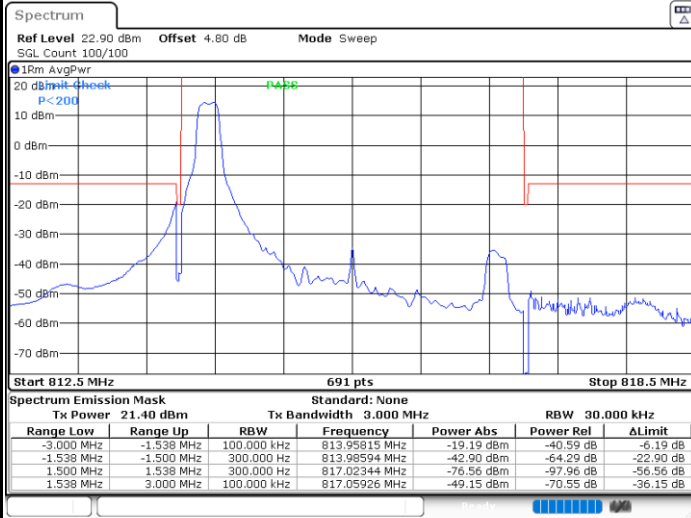

Highest Band Edge / 1 RB

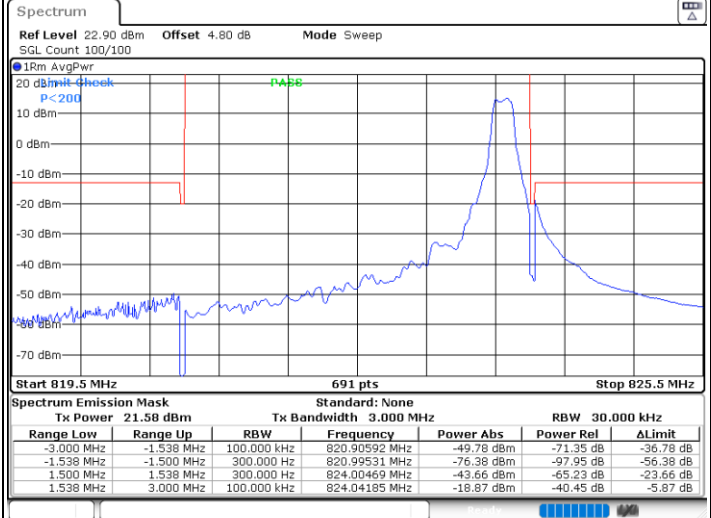

Lowest Band Edge / Full RB

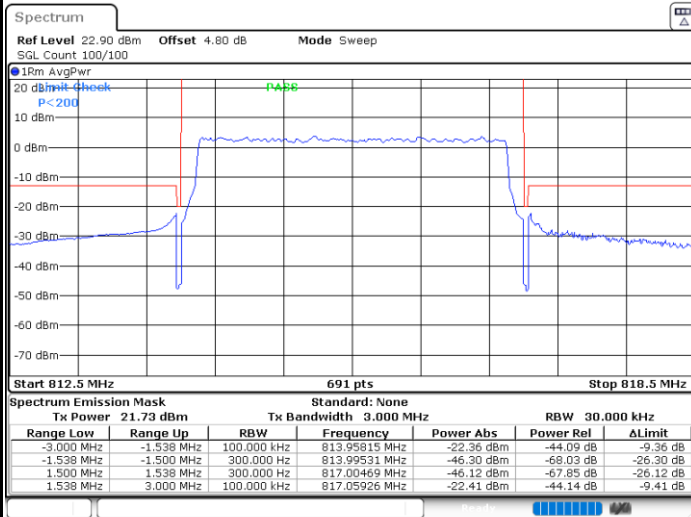

Highest Band Edge / Full RB

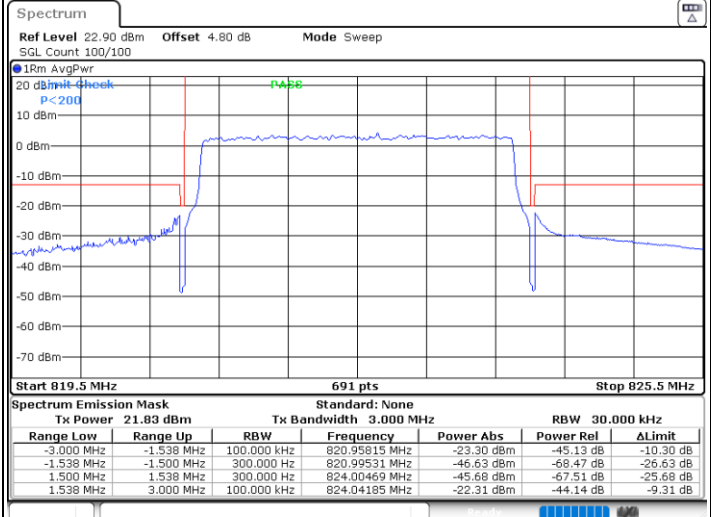



LTE Band 26 / 3MHz / 16QAM

Lowest Band Edge / 1 RB

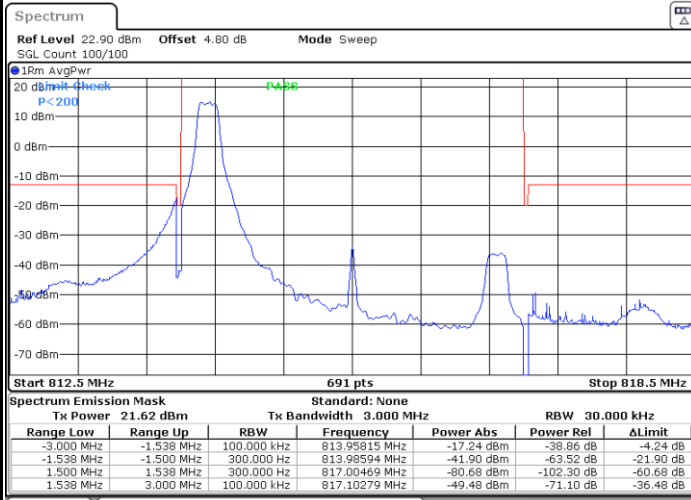

Date: 23.NOV.2021 22:11:02

Highest Band Edge / 1 RB

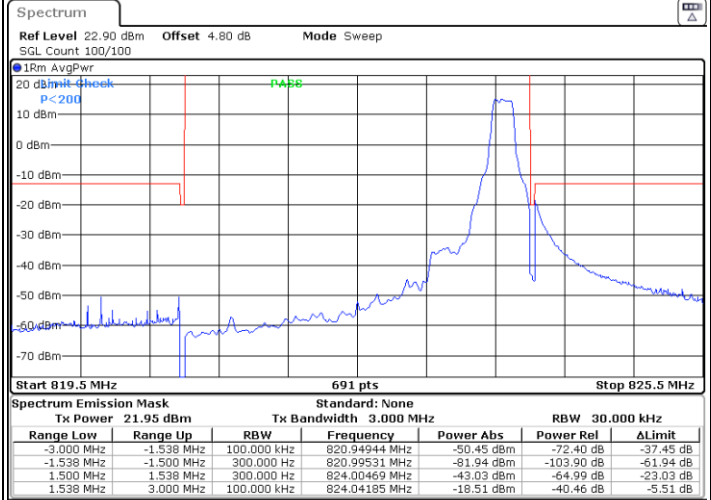

Date: 23.NOV.2021 22:16:39

Lowest Band Edge / Full RB

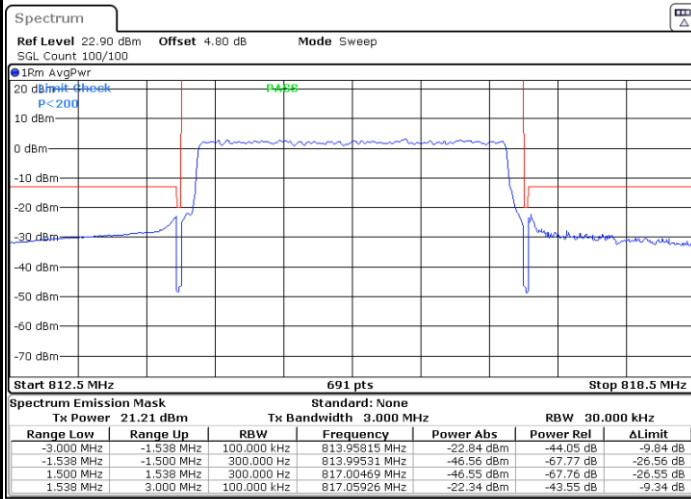

Date: 23.NOV.2021 22:13:50

Highest Band Edge / Full RB

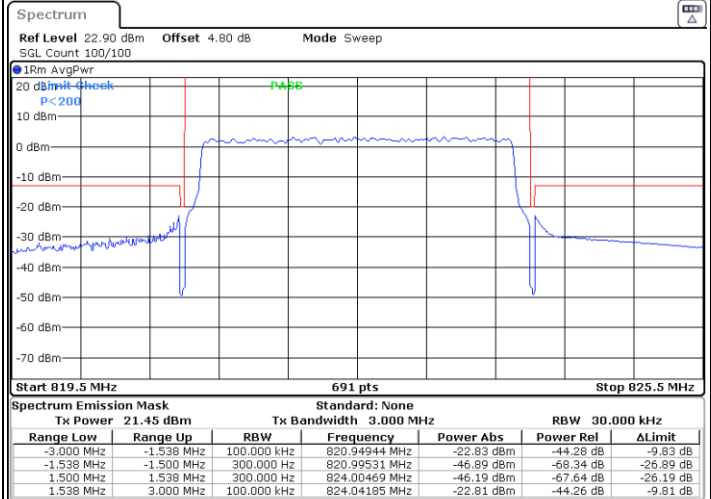

Date: 23.NOV.2021 22:19:29



LTE Band 26 / 3MHz / 64QAM

Lowest Band Edge / 1 RB

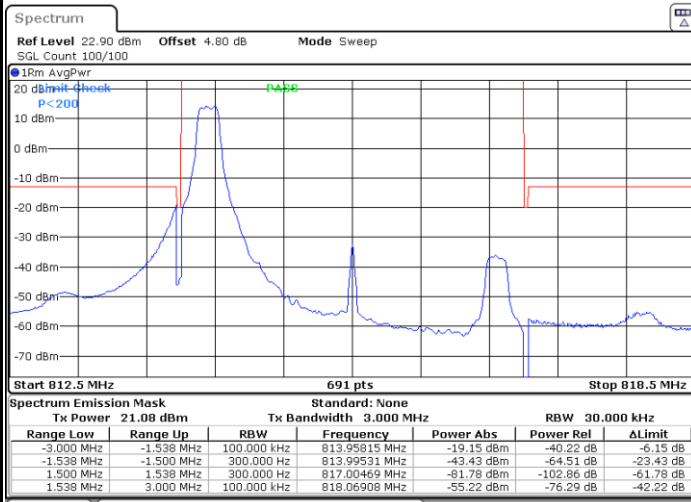

Date: 23.NOV.2021 22:20:53

Highest Band Edge / 1 RB

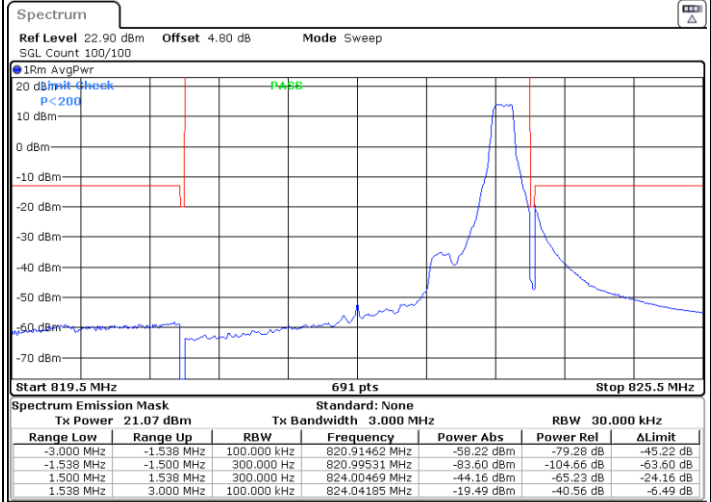

Date: 23.NOV.2021 22:23:42

Lowest Band Edge / Full RB

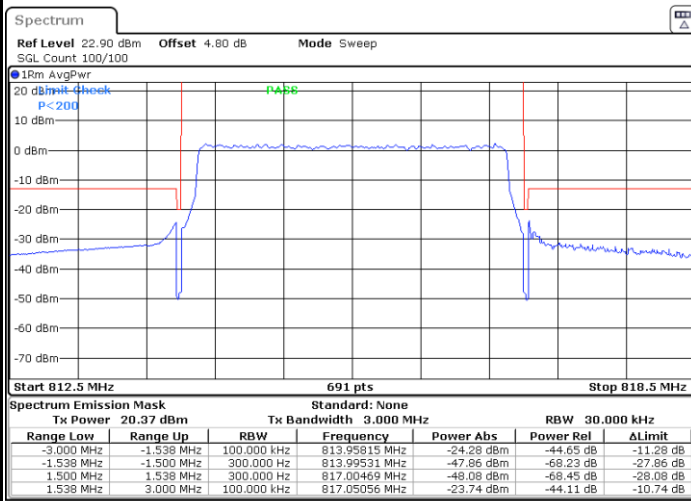

Date: 23.NOV.2021 22:22:18

Highest Band Edge / Full RB

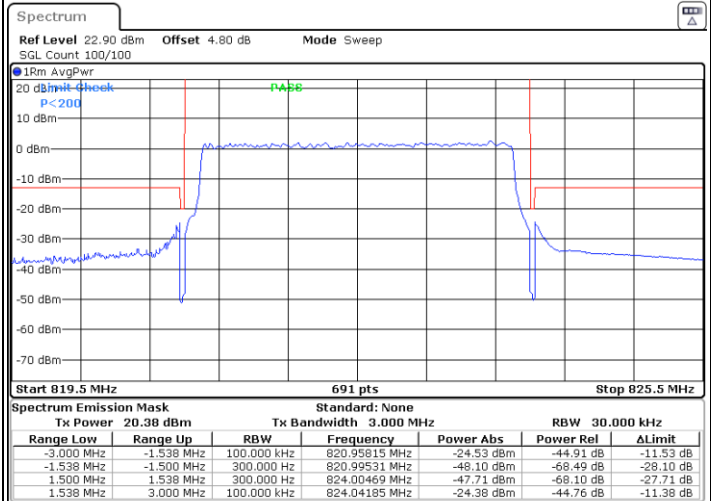

Date: 23.NOV.2021 22:25:07



LTE Band 26 / 3MHz / 256QAM

Lowest Band Edge / 1 RB

Highest Band Edge / 1 RB

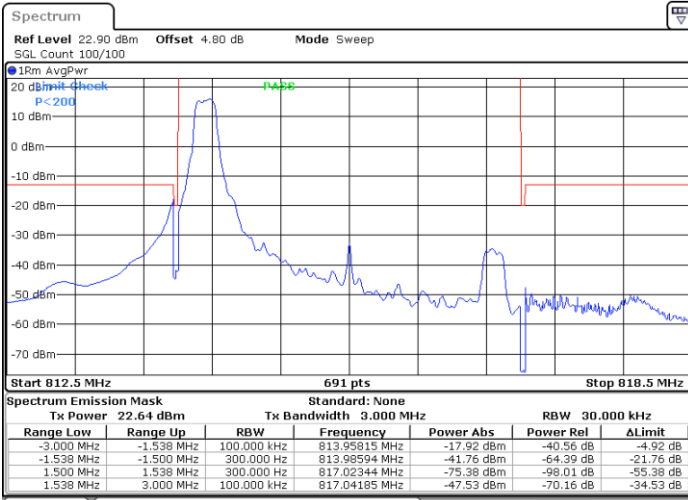

Date: 28.NOV.2021 15:21:08

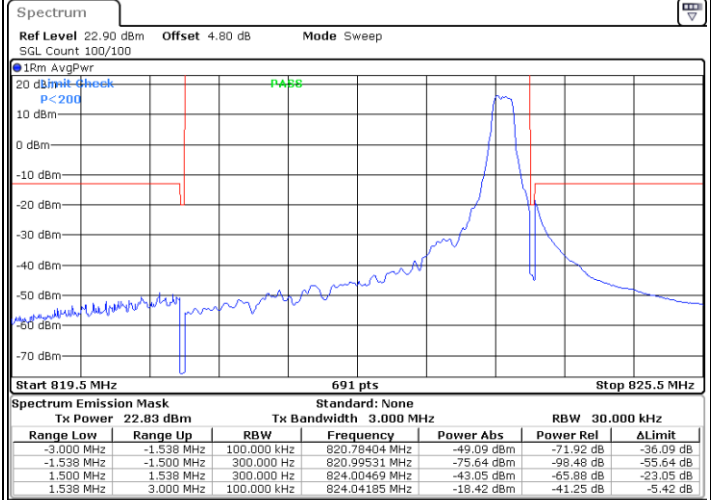

Date: 28.NOV.2021 15:22:10

Lowest Band Edge / Full RB

Highest Band Edge / Full RB

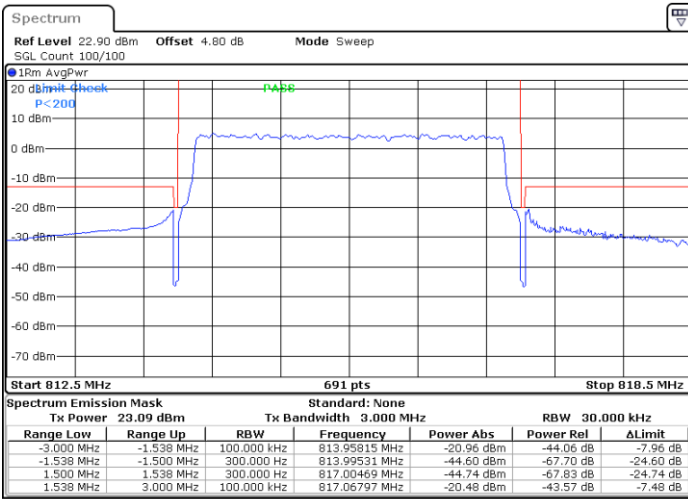

Date: 28.NOV.2021 15:19:43

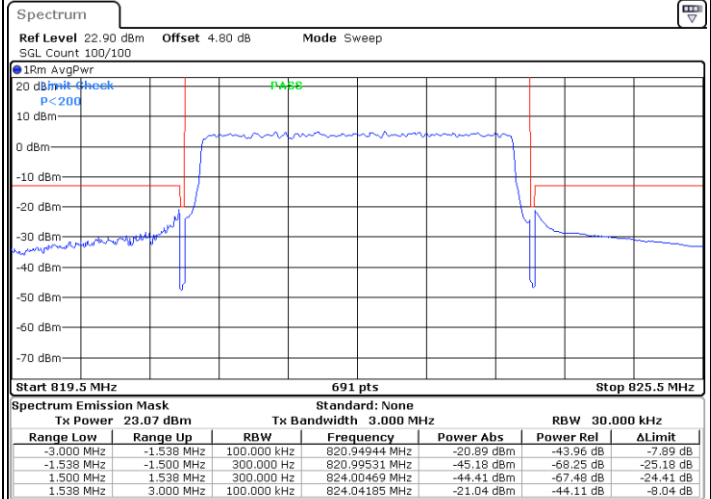

Date: 28.NOV.2021 15:23:13



LTE Band 26 / 5MHz / QPSK

Lowest Band Edge / 1 RB

Highest Band Edge / 1 RB

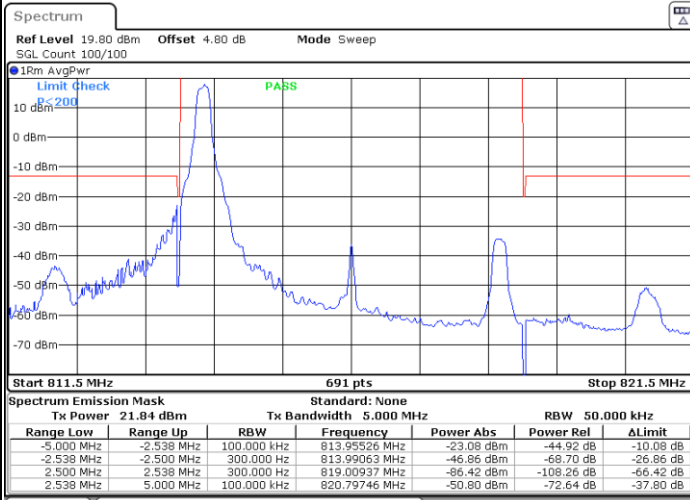

Date: 23.NOV.2021 22:32:09

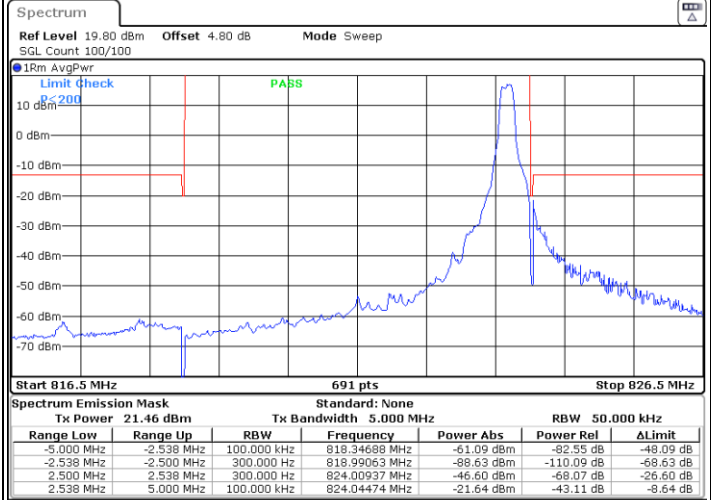

Date: 23.NOV.2021 22:37:46

Lowest Band Edge / Full RB

Highest Band Edge / Full RB

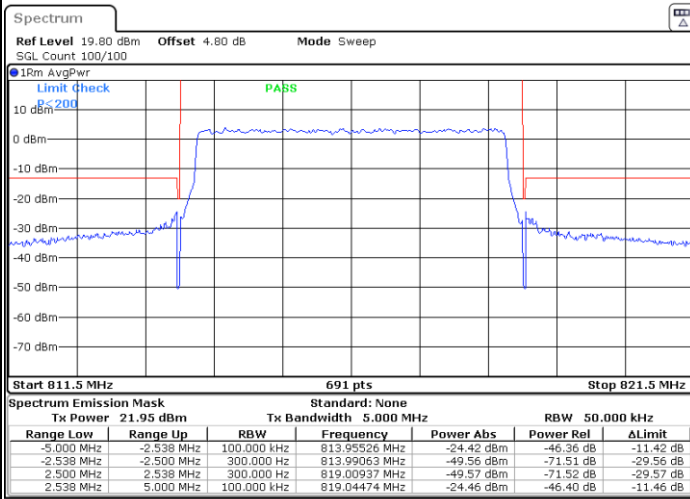

Date: 23.NOV.2021 22:34:57

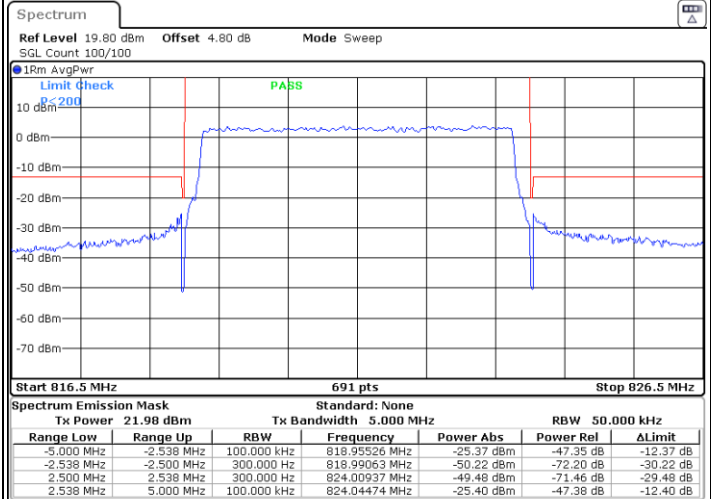

Date: 23.NOV.2021 22:40:35



LTE Band 26 / 5MHz / 16QAM

Lowest Band Edge / 1RB

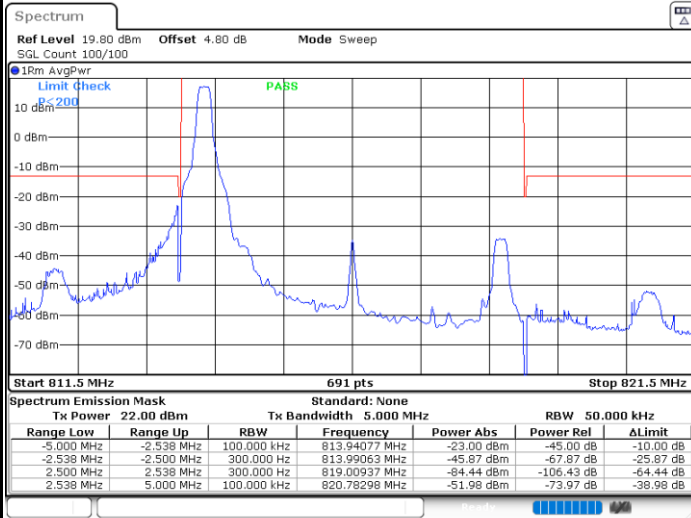

Date: 23.NOV.2021 22:33:33

Highest Band Edge / 1 RB

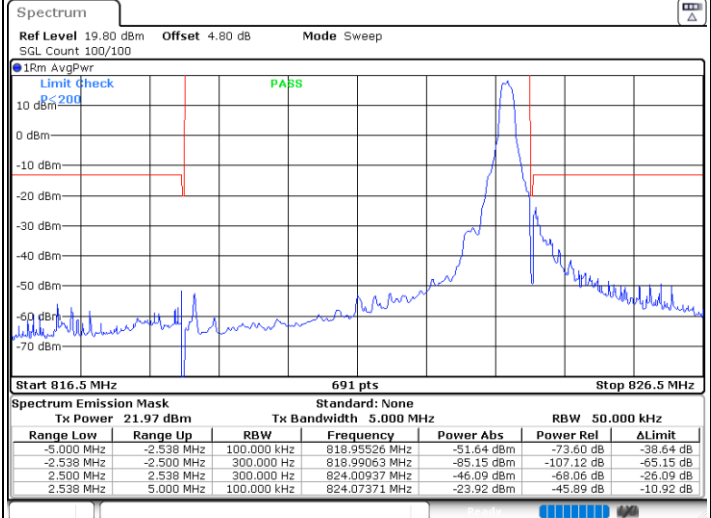

Date: 23.NOV.2021 22:39:10

Lowest Band Edge / Full RB

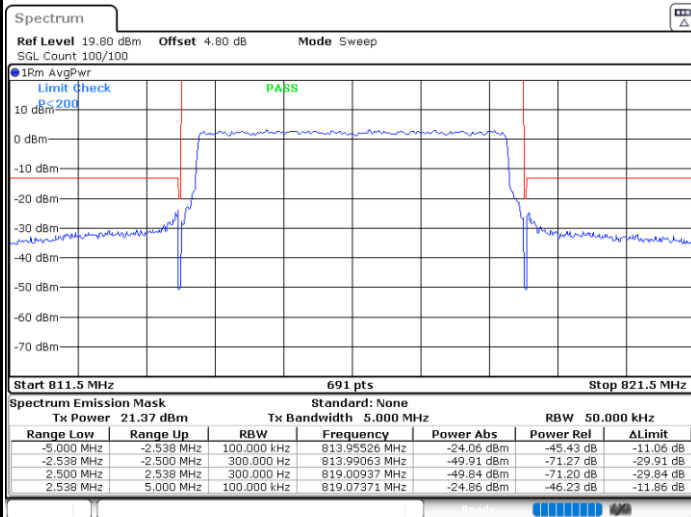

Date: 23.NOV.2021 22:36:22

Highest Band Edge / Full RB

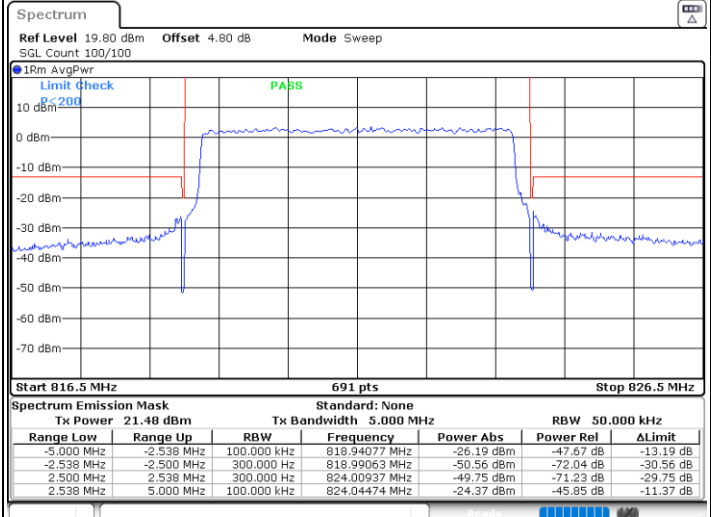

Date: 23.NOV.2021 22:41:59



LTE Band 26 / 5MHz / 64QAM

Lowest Band Edge / 1RB

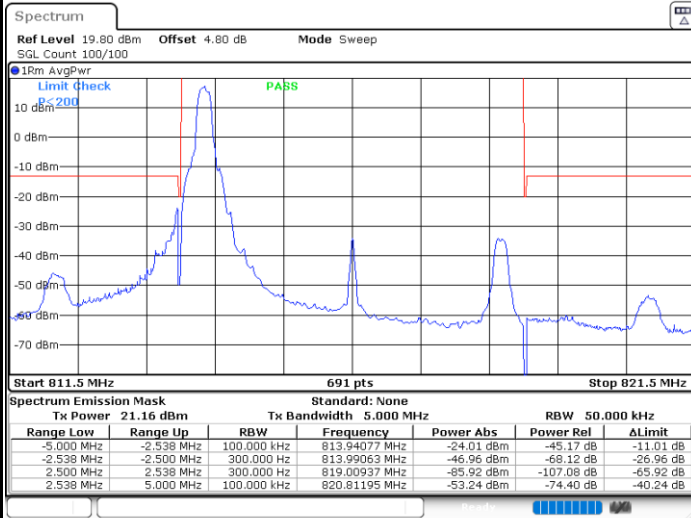

Date: 23.NOV.2021 22:26:32

Highest Band Edge / 1 RB

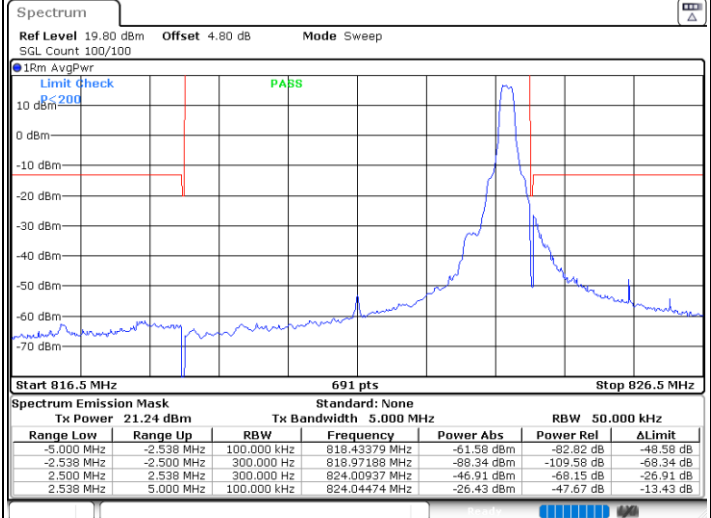

Date: 23.NOV.2021 22:29:20

Lowest Band Edge / Full RB

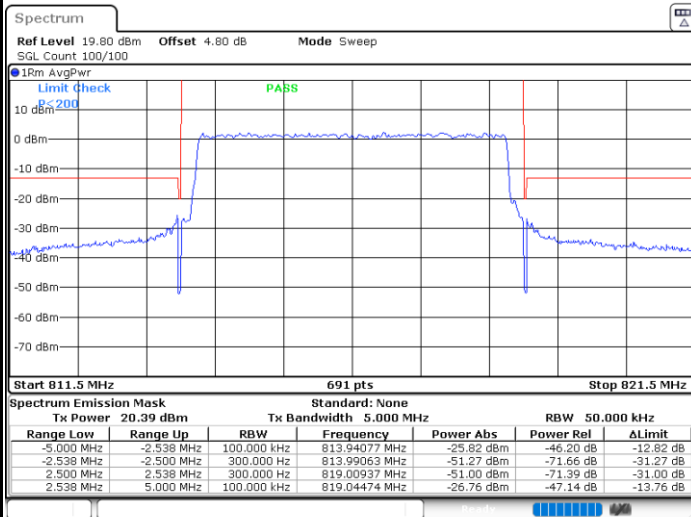

Date: 23.NOV.2021 22:27:56

Highest Band Edge / Full RB

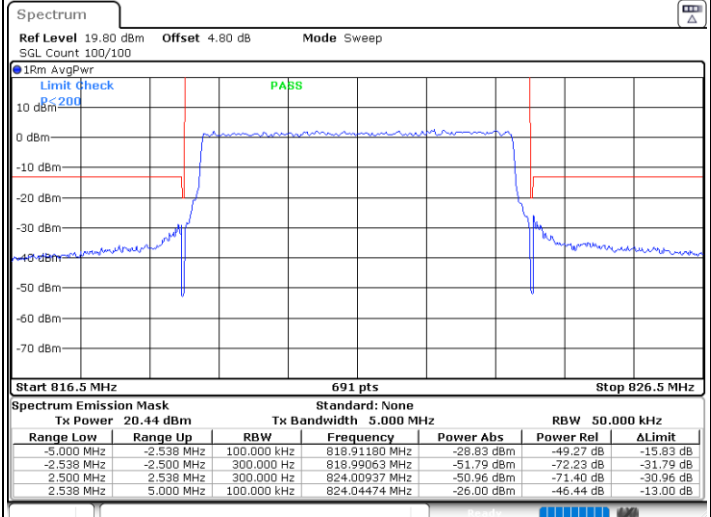

Date: 23.NOV.2021 22:30:44



LTE Band 26 / 5MHz / 256QAM

Lowest Band Edge / 1RB

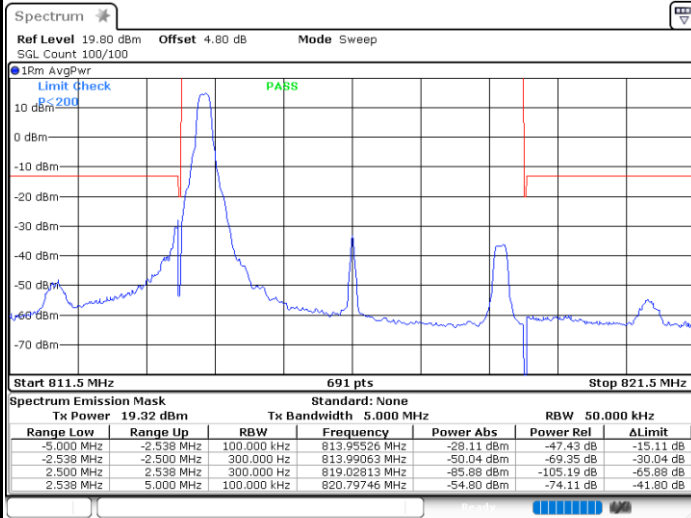

Date: 28.NOV.2021 15:25:36

Highest Band Edge / 1 RB

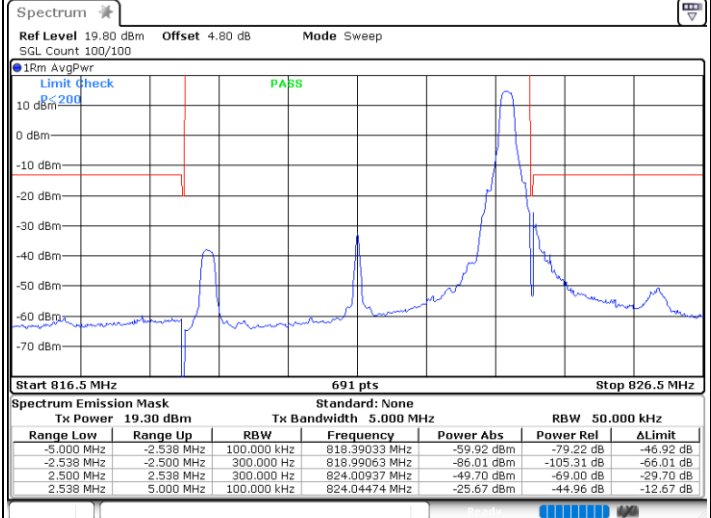

Date: 28.NOV.2021 15:27:11

Lowest Band Edge / Full RB

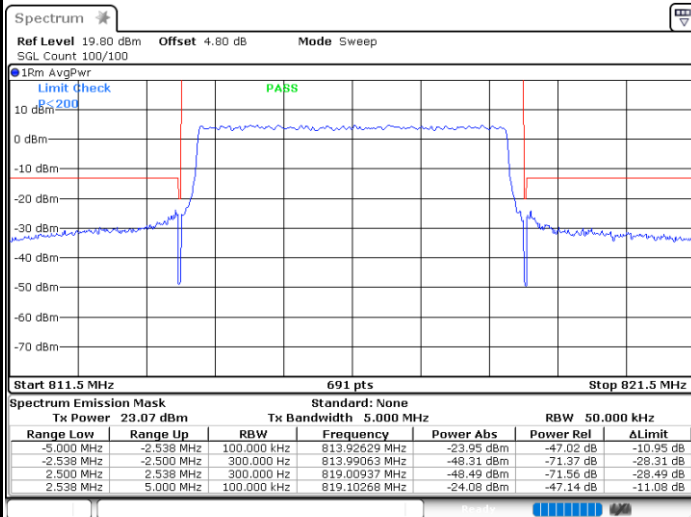

Date: 28.NOV.2021 15:24:22

Highest Band Edge / Full RB

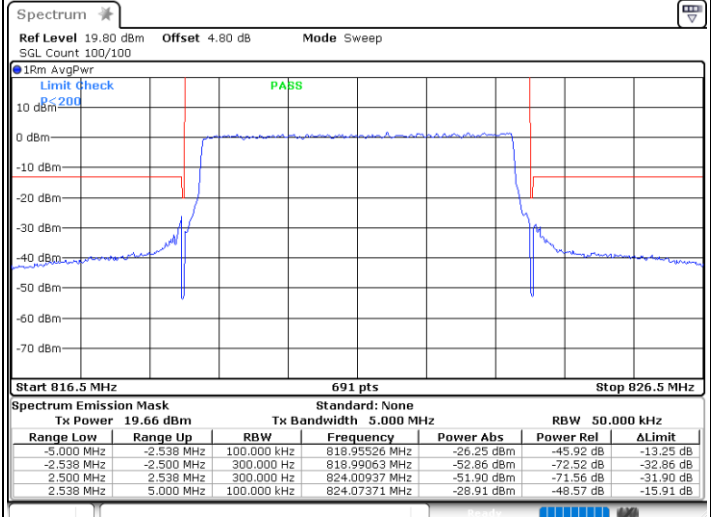

Date: 28.NOV.2021 15:27:57



LTE Band 26 / 10MHz / QPSK

Middle Band Edge / 1 RB

Middle Band Edge / 1 RB max

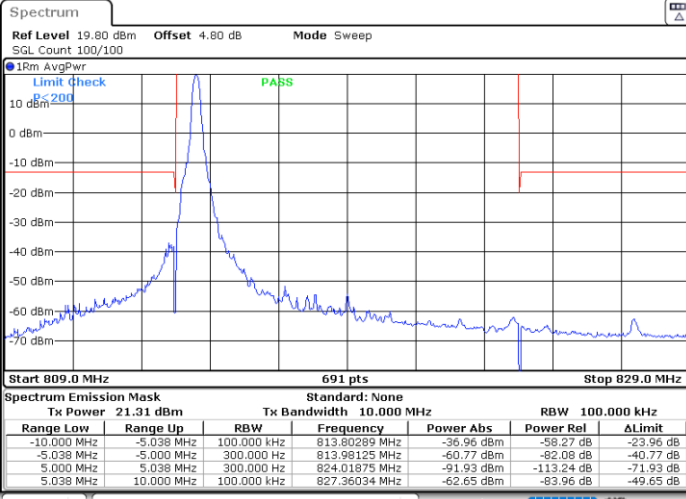

Date: 23.NOV.2021 22:43:24

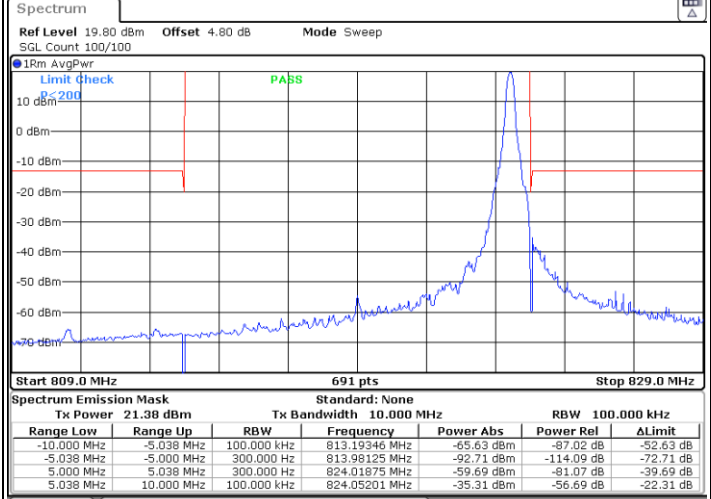

Date: 23.NOV.2021 22:46:13

Band Edge / Full RB

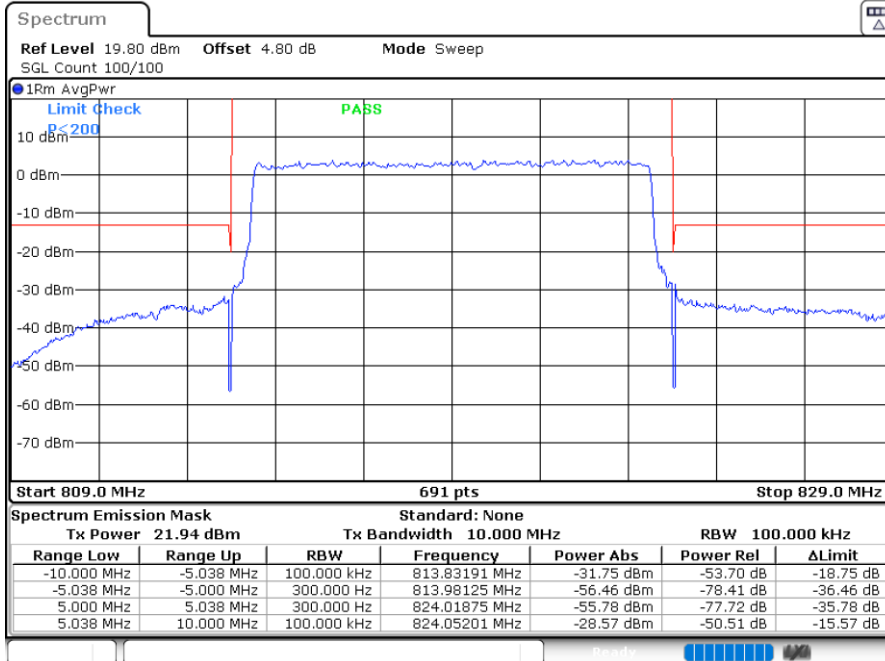

Date: 23.NOV.2021 22:49:01



LTE Band 26 / 10MHz / 16QAM

Middle Band Edge / 1 RB

Middle Band Edge / 1 RB max

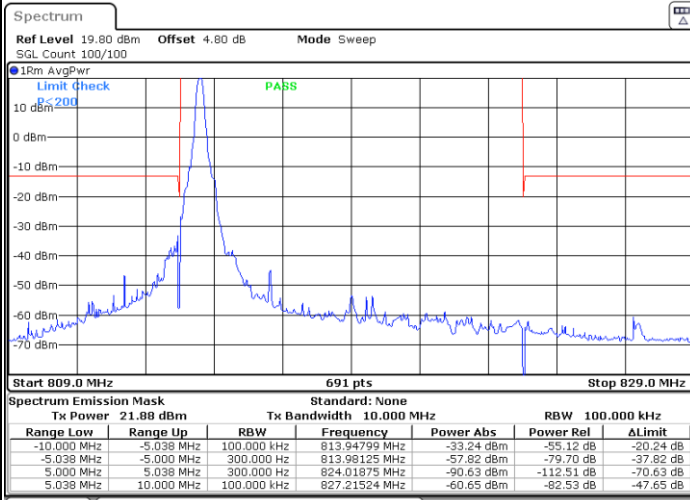

Date: 23.NOV.2021 22:44:48

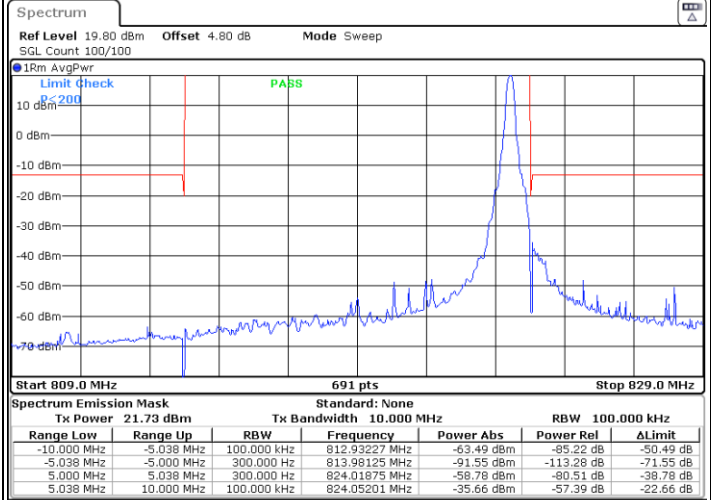

Date: 23.NOV.2021 22:47:37

Band Edge / Full RB

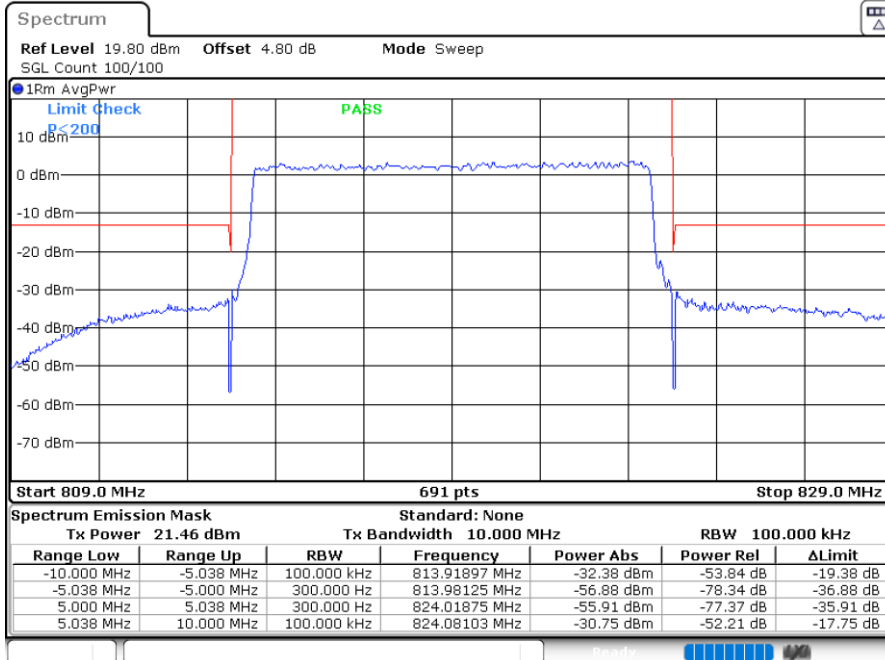

Date: 23.NOV.2021 22:50:26



LTE Band 26 / 10MHz / 64QAM

Middle Band Edge / 1 RB

Middle Band Edge / 1 RB max

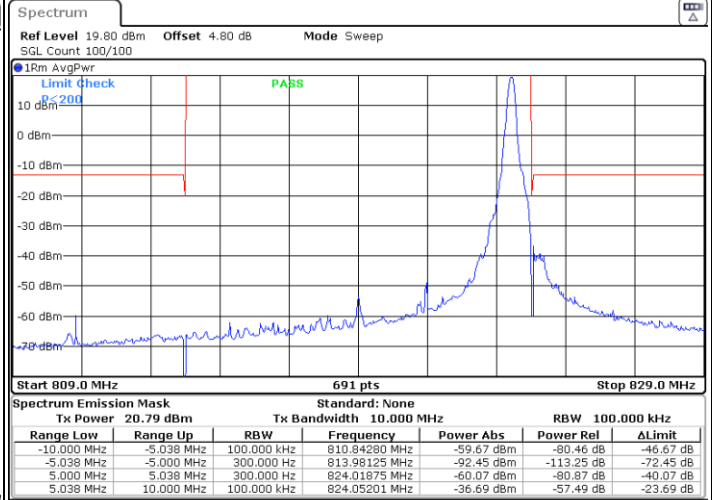
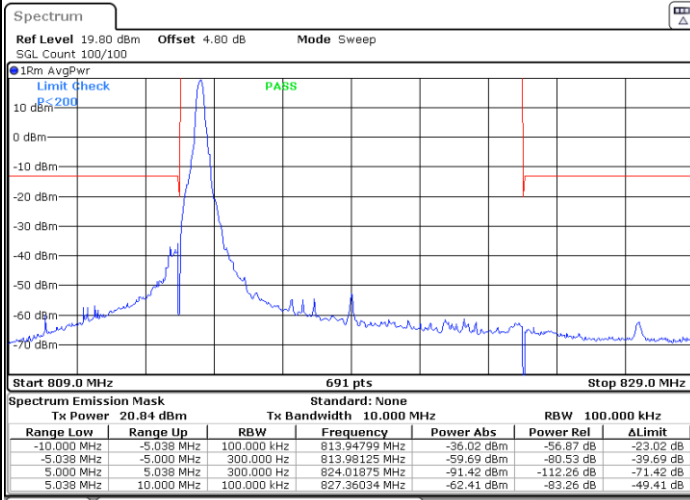

Date: 23.NOV.2021 22:51:50

Date: 23.NOV.2021 22:53:14

Band Edge / Full RB

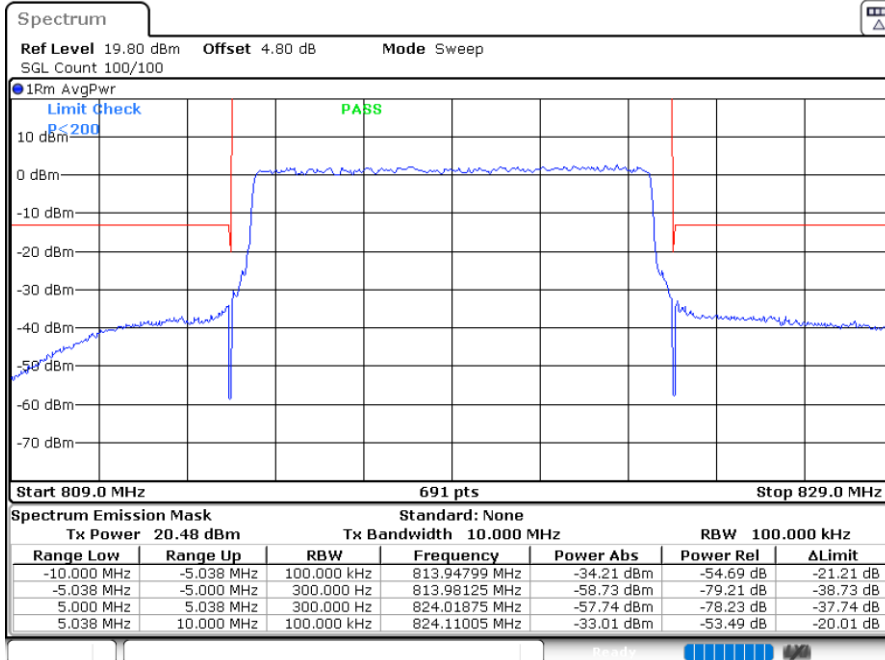

Date: 23.NOV.2021 22:54:38



LTE Band 26 / 10MHz / 256QAM

Middle Band Edge / 1 RB

Middle Band Edge / 1 RB max

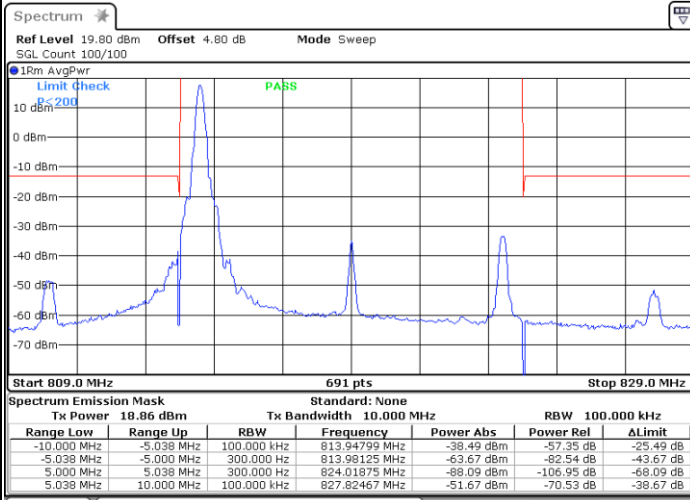

Date: 28.NOV.2021 15:33:10

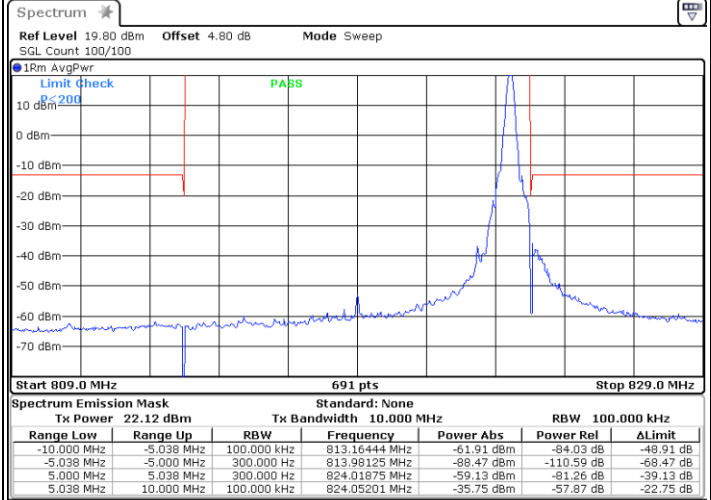

Date: 28.NOV.2021 15:40:08

Band Edge / Full RB

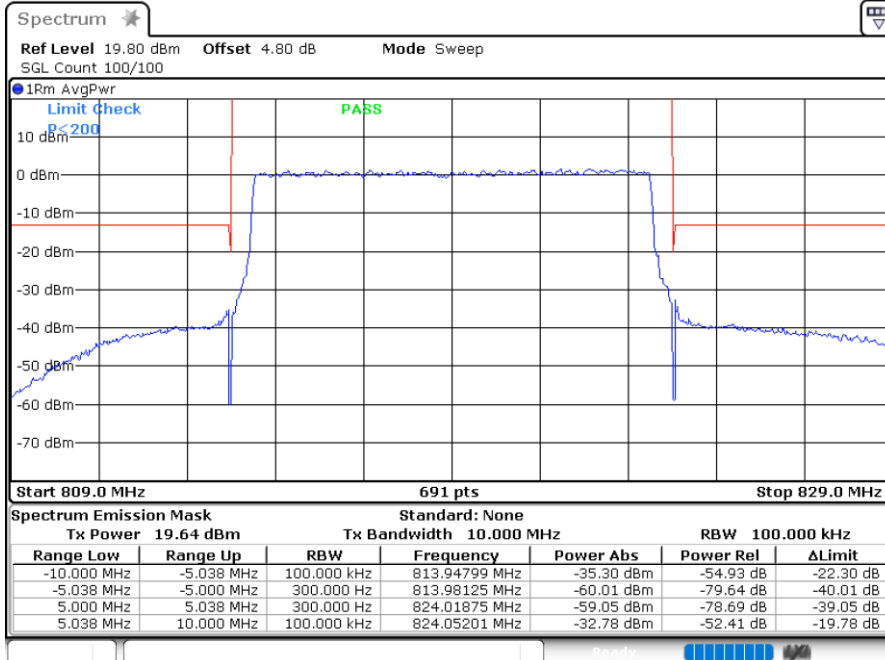

Date: 28.NOV.2021 15:29:36



LTE Band 26 / 15MHz / QPSK

Lowest Band Edge / 1 RB

Lowest Band Edge / 1 RB max

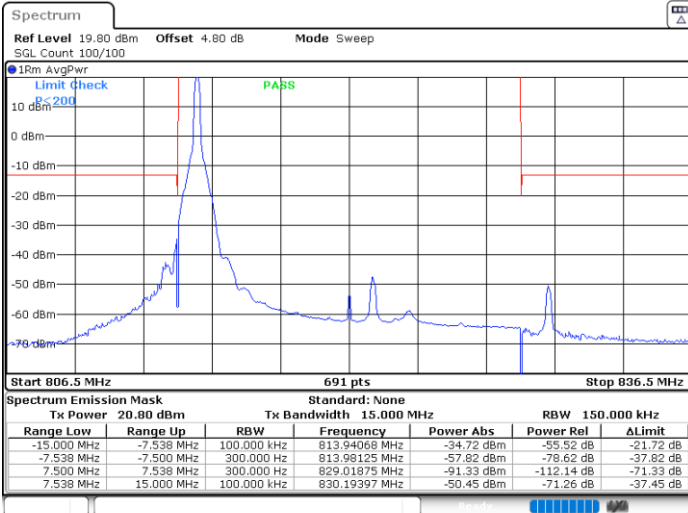

Date: 23.NOV.2021 22:56:03

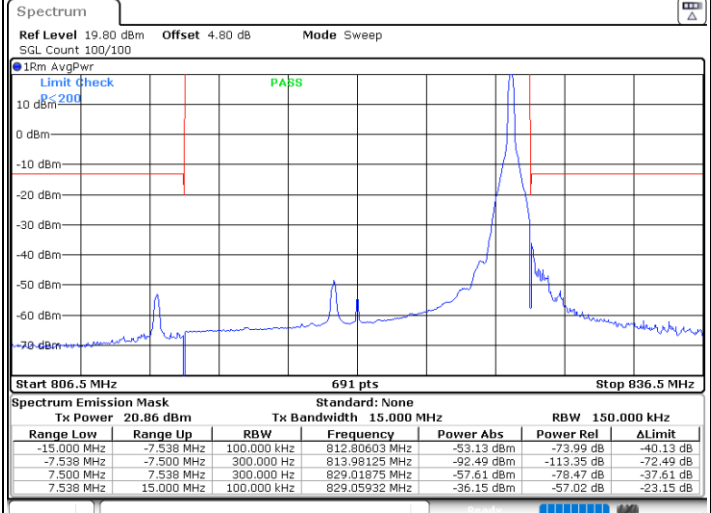

Date: 23.NOV.2021 22:58:52

Band Edge / Full RB

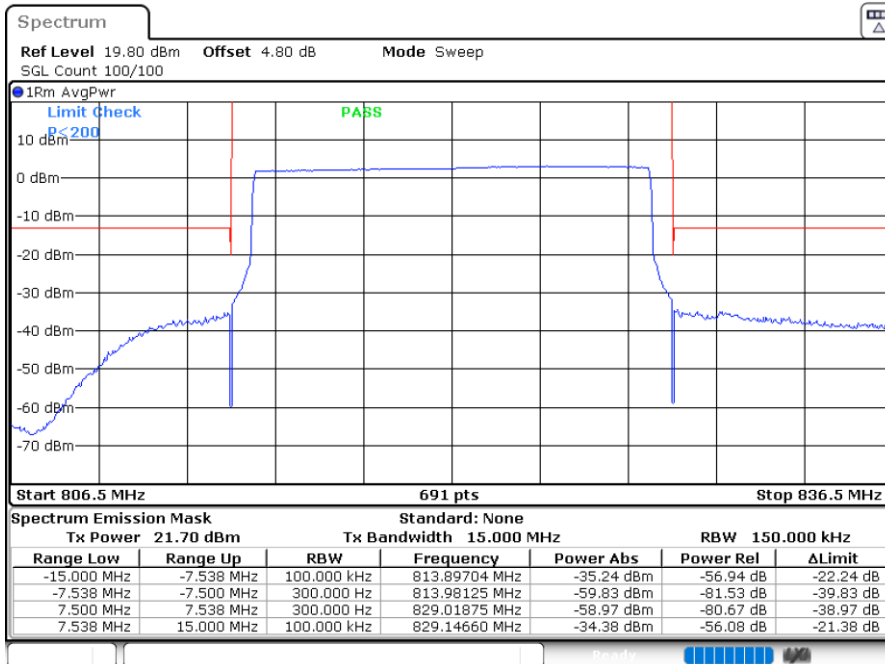

Date: 23.NOV.2021 23:01:41



LTE Band 26 / 15MHz / 16QAM

Lowest Band Edge / 1 RB

Lowest Band Edge / 1 RB max

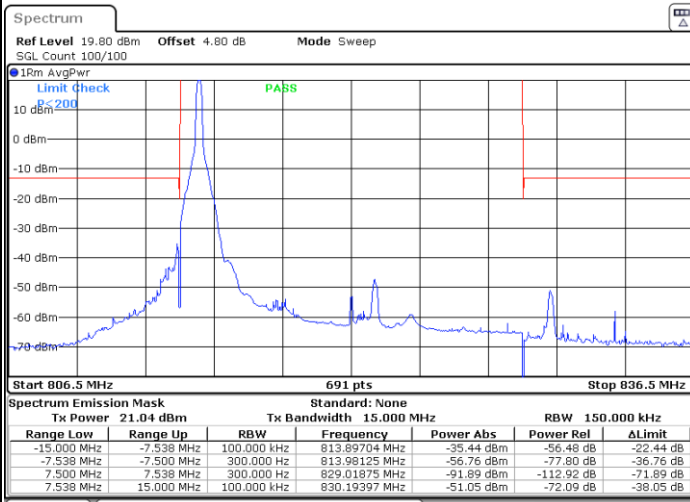

Date: 23.NOV.2021 22:57:27

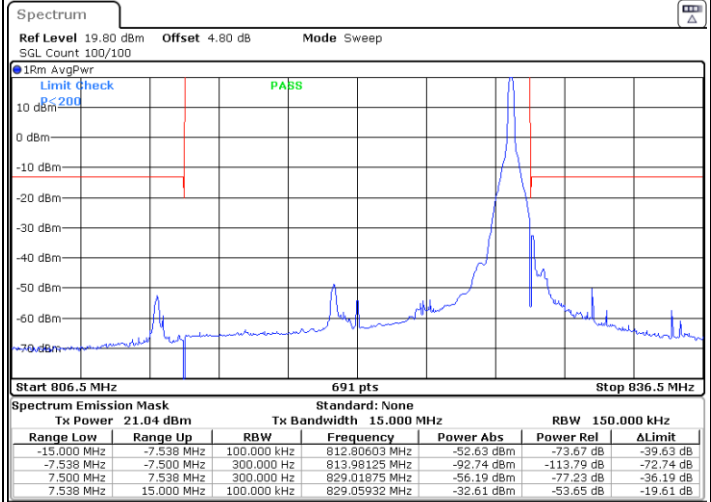

Date: 23.NOV.2021 23:00:16

Band Edge / Full RB

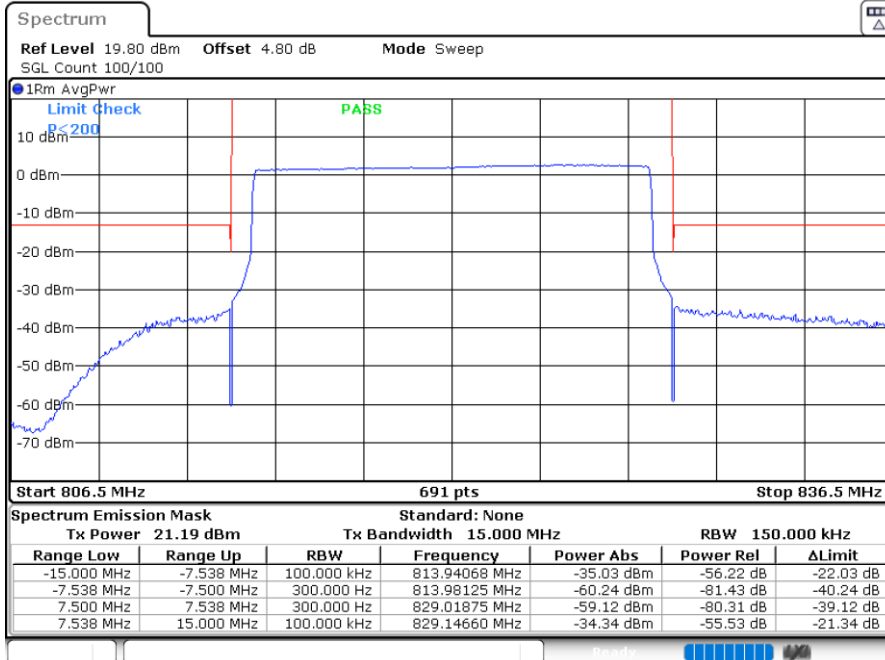

Date: 23.NOV.2021 23:03:05



LTE Band 26 / 15MHz / 64QAM

Lowest Band Edge / 1 RB

Lowest Band Edge / 1 RB max

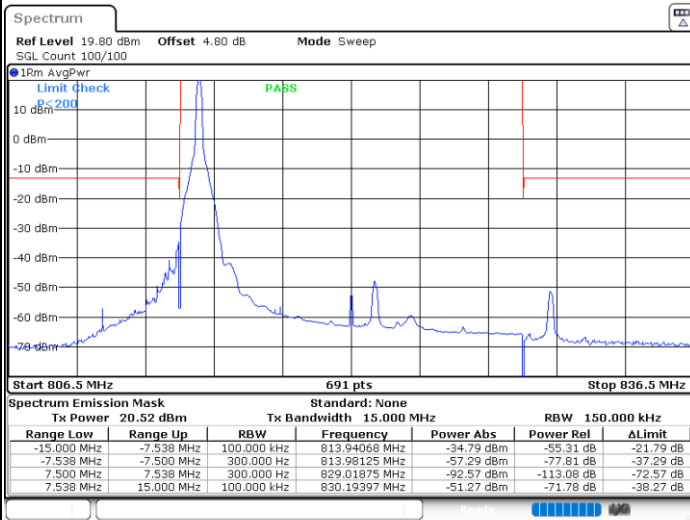

Date: 23.NOV.2021 23:04:29

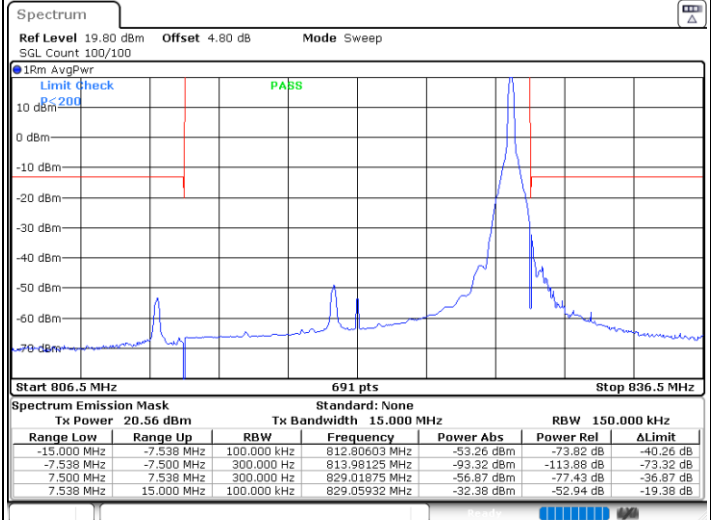

Date: 23.NOV.2021 23:05:54

Band Edge / Full RB

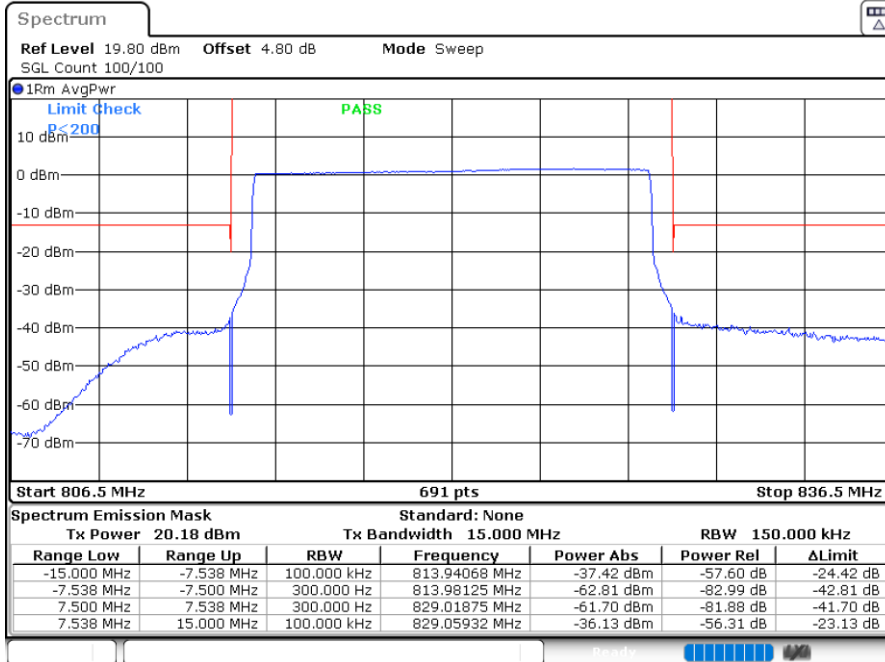

Date: 23.NOV.2021 23:07:18