



FCC RF Test Report

APPLICANT : Motorola Mobility LLC
EQUIPMENT : Mobile Cellular Phone
BRAND NAME : Motorola
MODEL NAME : XT2201-4
FCC ID : IHDT56AB3
STANDARD : 47 CFR Part 2, 22(H), 24(E), 27(L), 27(F), 27(H), 27(M)
CLASSIFICATION : PCS Licensed Transmitter Held to Ear (PCE)
TEST DATE(S) : Nov. 24, 2021 ~ Dec. 25, 2021

We, Sporton International (Kunshan) Inc., would like to declare that the tested sample has been evaluated in accordance with the procedures given in ANSI C63.26-2015 and shown compliance with the applicable technical standards.

The test results in this report apply exclusively to the tested model / sample. Without written approval of Sporton International (Kunshan) Inc., the test report shall not be reproduced except in full.

Jason Jia

Reviewed by: Jason Jia / Supervisor

Alex Wang

Approved by: Alex Wang / Manager



Sporton International (Kunshan) Inc.

**No. 1098, Pengxi North Road, Kunshan Economic Development Zone Jiangsu Province 215300
People's Republic of China**



TABLE OF CONTENTS

REVISION HISTORY 3
SUMMARY OF TEST RESULT 4
1 GENERAL DESCRIPTION 6
1.1 Applicant 6
1.2 Manufacturer 6
1.3 Product Feature of Equipment Under Test 6
1.4 Product Specification of Equipment Under Test 6
1.5 Modification of EUT 7
1.6 Maximum ERP/EIRP and Emission Designator 8
1.7 Testing Location 9
1.8 Test Software 10
1.9 Applicable Standards 10
1.10 Specification of Accessory 10
2 TEST CONFIGURATION OF EQUIPMENT UNDER TEST 11
2.1 Test Mode 11
2.2 Connection Diagram of Test System 14
2.3 Support Unit used in test configuration and system 15
2.4 Measurement Results Explanation Example 15
2.5 Frequency List of Low/Middle/High Channels 16
3 CONDUCTED TEST ITEMS 22
3.1 Measuring Instruments 22
3.2 Test Setup 22
3.3 Test Result of Conducted Test 22
3.4 Conducted Output Power and ERP/EIRP 23
3.5 Peak-to-Average Ratio 24
3.6 Occupied Bandwidth 25
3.7 Conducted Band Edge 26
3.8 Conducted Spurious Emission 28
3.9 Frequency Stability 29
4 RADIATED TEST ITEMS 30
4.1 Measuring Instruments 30
4.2 Test Setup 30
4.3 Test Result of Radiated Test 31
4.4 Radiated Spurious Emission 32
5 LIST OF MEASURING EQUIPMENT 33
6 UNCERTAINTY OF EVALUATION 34
APPENDIX A. TEST RESULTS OF CONDUCTED TEST
APPENDIX B. TEST RESULTS OF RADIATED TEST
APPENDIX C. TEST SETUP PHOTOGRAPHS



REVISION HISTORY

REPORT NO.	VERSION	DESCRIPTION	ISSUED DATE
FG192317-02B	Rev. 01	Initial issue of report	Jan. 05, 2022



SUMMARY OF TEST RESULT

Report Section	FCC Rule	Description	Limit	Result	Remark
3.4	§2.1046	Conducted Output Power	-	Report Only	-
	§22.913(a)(5)	Effective Radiated Power (Band 5)	ERP < 7 Watt	PASS	-
	§27.50(b)(10) §27.50(c)(10)	Effective Radiated Power (Band 12) (Band 13)	ERP < 3 Watt		-
	§24.232(c) §27.50(h)(2)	Equivalent Isotropic Radiated Power (Band 2) (Band 7)	EIRP < 2Watt		-
	§27.50(d)(4)	Equivalent Isotropic Radiated Power (Band 4) (Band 66)	EIRP < 1Watt		-
3.5	§24.232(d)	Peak-to-Average Ratio	<13 dB	PASS	-
3.6	§2.1049	Occupied Bandwidth	-	Report Only	-
3.7	§2.1051 §22.917(a) §24.238(a) §27.53(c)(2)(4) §27.53(g) §27.53(h)	Conducted Band Edge Measurement (Band 2) (Band 4) (Band 5) (Band 12) (Band 13) (Band 66)	< 43+10log ₁₀ (P[Watts])	PASS	-
	§27.53(m)(4)	Conducted Band Edge Measurement (Band 7)	§27.53(m)(4)		
3.8	§2.1051 §22.917(a) §24.238(a) §27.53(c)(2) §27.53(g) §27.53(h)	Conducted Spurious Emission (Band 2) (Band 4) (Band 5) (Band 12) (Band 13) (Band 66)	< 43+10log ₁₀ (P[Watts])	PASS	-
	§2.1051 §27.53(m)(4)	Conducted Spurious Emission (Band 7)	< 55+10log ₁₀ (P[Watts])		
3.9	§2.1055 §22.355	Frequency Stability Temperature & Voltage	< 2.5 ppm for Part 22	PASS	-
	§2.1055 §24.235 §27.54		Within Authorized Band		



Report Section	FCC Rule	Description	Limit	Result	Remark
4.4	§2.1053 §22.917(a) §24.238(a) §27.53(c)(2) §27.53(f) §27.53(g) §27.53(h)	Radiated Spurious Emission (Band 2) (Band 4) (Band 5) (Band 12) (Band 13) (Band 66)	$< 43+10\log_{10}(P[\text{Watts}])$	PASS	Under limit 15.41 dB at 1560.000 MHz
	§2.1053 §27.53(m)(4)	Radiated Spurious Emission (Band 7)	$< 55+10\log_{10}(P[\text{Watts}])$		

Declaration of Conformity:

The test results with all measurement uncertainty excluded are presented in accordance with the regulation limits or requirements declared by manufacturers.

Comments and Explanations:

The declared of product specification for EUT presented in the report are provided by the manufacturer, and the manufacturer takes all the responsibilities for the accuracy of product specification.



1 General Description

1.1 Applicant

Motorola Mobility LLC
222 W,Merchandise Mart Plaza, Chicago IL 60654 USA

1.2 Manufacturer

Motorola Mobility LLC
222 W,Merchandise Mart Plaza, Chicago IL 60654 USA

1.3 Product Feature of Equipment Under Test

Product Feature	
Equipment	Mobile Cellular Phone
Brand Name	Motorola
Model Name	XT2201-4
FCC ID	IHDT56AB3
IMEI Code	Conducted: 357193870007566/357193870007501 Radiation: 355871980014315/355871980014323
HW Version	DVT2
SW Version	S1SH32.10
EUT Stage	Identical Prototype

1.4 Product Specification of Equipment Under Test

Standards-related Product Specification	
Tx Frequency	LTE Band 2 : 1850 MHz ~ 1910 MHz LTE Band 4 : 1710 MHz ~ 1755 MHz LTE Band 5 : 824 MHz ~ 849 MHz LTE Band 7 : 2500 MHz ~ 2570 MHz LTE Band 12 : 699 MHz ~ 716 MHz LTE Band 13 : 777 MHz ~ 787 MHz LTE Band 66 : 1710 MHz ~ 1780 MHz
Rx Frequency	LTE Band 2 : 1930 MHz ~ 1990 MHz LTE Band 4 : 2110 MHz ~ 2155 MHz LTE Band 5 : 869 MHz ~ 894 MHz LTE Band 7 : 2620 MHz ~ 2690 MHz LTE Band 12 : 729 MHz ~ 746 MHz LTE Band 13 : 746 MHz ~ 756 MHz LTE Band 66 : 2110 MHz~ 2200 MHz
Bandwidth	LTE Band 2 : 1.4MHz / 3MHz / 5MHz / 10MHz / 15MHz / 20MHz LTE Band 4 : 1.4MHz / 3MHz / 5MHz / 10MHz / 15MHz / 20MHz LTE Band 5 : 1.4MHz / 3MHz / 5MHz / 10MHz LTE Band 7 : 5MHz/ 10MHz / 15MHz / 20MHz LTE Band 12 : 1.4MHz / 3MHz / 5MHz / 10MHz LTE Band 13 : 5MHz / 10MHz



	LTE Band 66 : 1.4MHz / 3MHz / 5MHz / 10MHz / 15MHz / 20MHz
Maximum Output Power to Antenna	<Ant. 0> LTE Band 2 : 23.15 dBm LTE Band 4 : 22.98 dBm LTE Band 5 : 22.91 dBm LTE Band 5B : 22.83 dBm LTE Band 7 : 23.53 dBm LTE Band 12 : 22.76 dBm LTE Band 13 : 22.97 dBm LTE Band 66 : 23.16 dBm LTE Band 66B : 22.03 dBm LTE Band 66C : 22.13 dBm <Ant. 1> LTE Band 2 : 21.97 dBm LTE Band 4 : 22.58 dBm LTE Band 5 : 22.66 dBm LTE Band 5B : 22.62 dBm LTE Band 7 : 22.89 dBm LTE Band 12 : 24.38 dBm LTE Band 13 : 24.33 dBm LTE Band 66 : 22.69 dBm LTE Band 66B : 22.52 dBm LTE Band 66C : 22.53 dBm
Antenna Gain	<Ant.0> LTE Band 2 : -0.8 dBi LTE Band 4 : -1.1 dBi LTE Band 5 : -3.6 dBi LTE Band 7 : 0.2 dBi LTE Band 12 : -3.0 dBi LTE Band 13 : -3.3 dBi LTE Band 66 : -1.1 dBi <Ant.1> LTE Band 2 : -1.5 dBi LTE Band 4 : -1.5 dBi LTE Band 5 : -4.8 dBi LTE Band 7 : -0.9 dBi LTE Band 12 : -4.5 dBi LTE Band 13 : -4.4 dBi LTE Band 66 : -1.5 dBi
Type of Modulation	QPSK / 16QAM / 64QAM / 256QAM

Remark: The maximum ERP/EIRP is calculated from max output power and max antenna gain, so only the maximum ERP/EIRP (Antenna 0) for LTE Band2/4/5/5b/7/66/66C and Antenna 1 for LTE Band 12/13/66B is shown in the report.

1.5 Modification of EUT

No modifications are made to the EUT during all test items.



1.6 Maximum ERP/EIRP and Emission Designator

LTE Band 2		QPSK		16QAM/64QAM/256QAM	
BW (MHz)	Frequency Range (MHz)	Maximum EIRP(W)	Emission Designator (99%OBW)	Maximum EIRP(W)	Emission Designator (99%OBW)
20	1860.0 ~ 1900.0	0.1718	18M4G7D	0.1714	18M4W7D
LTE Band 4		QPSK		16QAM/64QAM/256QAM	
BW (MHz)	Frequency Range (MHz)	Maximum EIRP(W)	Emission Designator (99%OBW)	Maximum EIRP(W)	Emission Designator (99%OBW)
20	1720.0 ~ 1745.0	0.1607	18M5G7D	0.1570	18M5W7D
LTE Band 5		QPSK		16QAM/64QAM/256QAM	
BW (MHz)	Frequency Range (MHz)	Maximum ERP(W)	Emission Designator (99%OBW)	Maximum ERP(W)	Emission Designator (99%OBW)
10	829.0 ~ 844.0	0.0520	9M03G7D	0.0515	9M01W7D
LTE Band 7		QPSK		16QAM/64QAM/256QAM	
BW (MHz)	Frequency Range (MHz)	Maximum EIRP(W)	Emission Designator (99%OBW)	Maximum EIRP(W)	Emission Designator (99%OBW)
20	2510.0 ~ 2560.0	0.2360	18M4G7D	0.2344	18M4W7D
LTE Band 12		QPSK		16QAM/64QAM/256QAM	
BW (MHz)	Frequency Range (MHz)	Maximum ERP(W)	Emission Designator (99%OBW)	Maximum ERP(W)	Emission Designator (99%OBW)
10	704.0 ~ 711.0	0.0593	9M03G7D	0.0491	9M03W7D
LTE Band 13		QPSK		16QAM/64QAM/256QAM	
BW (MHz)	Frequency Range (MHz)	Maximum ERP(W)	Emission Designator (99%OBW)	Maximum ERP(W)	Emission Designator (99%OBW)
10	782.0	0.0600	9M01G7D	0.0515	9M03W7D
LTE Band 66		QPSK		16QAM/64QAM/256QAM	
BW (MHz)	Frequency Range (MHz)	Maximum EIRP(W)	Emission Designator (99%OBW)	Maximum EIRP(W)	Emission Designator (99%OBW)
20	1720.0 ~ 1770.0	0.1607	18M5G7D	0.1570	18M5W7D



LTE Band 5B	QPSK		16QAM/64QAM/256QAM	
BW (MHz)	Maximum ERP(W)	Emission Designator (99%OBW)	Maximum ERP(W)	Emission Designator (99%OBW)
10MHz+10MHz	0.0511	18M8G7D	0.0493	18M9W7D
LTE Band 66B	QPSK		16QAM/64QAM/256QAM	
BW (MHz)	Maximum EIRP(W)	Emission Designator (99%OBW)	Maximum EIRP(W)	Emission Designator (99%OBW)
10MHz+10MHz	0.1265	18M8G7D	0.1253	18M6W7D
LTE Band 66C	QPSK		16QAM/64QAM/256QAM	
BW (MHz)	Maximum EIRP(W)	Emission Designator (99%OBW)	Maximum EIRP(W)	Emission Designator (99%OBW)
20MHz+20MHz	0.1268	37M6G7D	0.1256	37M6W7D

Note:

1. LTE Band 66 overlaps the entire frequency range of LTE Band 4. Therefore, the test results provided in this report covers Band 66 as well as Band 4.
2. According to engineering evaluation and verify the test, only the maximum bandwidth and the worst test results of PSK & QAM are shown in the report.

1.7 Testing Location

Sporton International (Kunshan) Inc. is accredited to ISO/IEC 17025:2017 by American Association for Laboratory Accreditation with Certificate Number 5145.02.

Test Firm	Sporton International (Kunshan) Inc.		
Test Site Location	No. 1098, Pengxi North Road, Kunshan Economic Development Zone Jiangsu Province 215300 People's Republic of China TEL : +86-512-57900158 FAX : +86-512-57900958		
Test Site No.	Sporton Site No.	FCC Designation No.	FCC Test Firm Registration No.
	03CH04-KS TH01-KS	CN1257	314309



1.8 Test Software

Item	Site	Manufacture	Name	Version
1.	03CH04-KS	AUDIX	E3	6.2009-8-24a

1.9 Applicable Standards

According to the specifications of the manufacturer, the EUT must comply with the requirements of the following standards:

- ♦ 47 CFR Part 2, 22(H), 24(E), 27(L), 27(F), 27(H), 27(M)
- ♦ ANSI C63.26-2015
- ♦ FCC KDB 971168 D01 Power Meas License Digital Systems v03r01
- ♦ FCC KDB 412172 D01 Determining ERP and EIRP v01r01

Remark:

1. All test items were verified and recorded according to the standards and without any deviation during the test.
2. This EUT has also been tested and complied with the requirements of FCC Part 15, Subpart B, recorded in a separate test report.

1.10 Specification of Accessory

Specification of Accessory				
AC Adapter 1	Brand Name	Motorola(Salom)	Model Name	MC-301
AC Adapter 2	Brand Name	Motorola(Acbel)	Model Name	MC-301
Battery	Brand Name	Motorola(ATL)	Model Name	NA50
Earphone	Brand Name	Motorola (Lyand)	Model Name	MD211(SH38D20195)
USB Cable 1	Brand Name	Motorola(Saibao)	Model Name	SC18D13215
USB Cable 2	Brand Name	Motorola(Cabletech)	Model Name	SC18D13216
USB Cable 3	Brand Name	Motorola(Luxshare)	Model Name	SC18D13217
Type C to HDMI Cable /USBC Cable	Brand Name	Motorola(Linxee)	Model Name	SC18D02146
Stylus	Brand Name	Motorola smart stylus	Model Name	XT2201-S
Smart Folio	Brand Name	Motorola(Techson)	Model Name	SS68D36907,SS68D36906
Wireless Dongle	Brand Name	Motorola	Model Name	MD-02
HDMI Cable	Brand Name	Motorola	Model Name	HC-01
USB Cable(Type A/C)	Brand Name	Motorola	Model Name	SC18C24367



2 Test Configuration of Equipment Under Test

2.1 Test Mode

Antenna port conducted and radiated test items listed below are performed according to KDB 971168 D01 Power Meas License Digital Systems v03r01 with maximum output power.

Radiated measurements are performed by rotating the EUT in three different orthogonal test planes to find the maximum emission.

Test Items	Band	Bandwidth (MHz)						Modulation				RB #			Test Channel		
		1.4	3	5	10	15	20	QPSK	16QAM	64QAM	256QAM	1	Half	Full	L	M	H
Max. Output Power	2	v	v	v	v	v	v	v	v	v	v	v	v	v	v	v	v
	4	v	v	v	v	v	v	v	v	v	v	v	v	v	v	v	v
	5	v	v	v	v	-	-	v	v	v	v	v	v	v	v	v	v
	7	-	-	v	v	v	v	v	v	v	v	v	v	v	v	v	v
	12	v	v	v	v	-	-	v	v	v	v	v	v	v	v	v	v
	13	-	-	v	v	-	-	v	v	v	v	v	v	v	v	v	v
	66	v	v	v	v	v	v	v	v	v	v	v	v	v	v	v	v
Peak-to-Ave rage Ratio	2						v	v	v	v	v			v		v	
	5				v	-	-	v	v	v	v			v		v	
	7	-	-				v	v	v	v	v			v		v	
	12				v	-	-	v	v	v	v			v		v	
	13	-	-		v	-	-	v	v	v	v			v		v	
	66						v	v	v	v	v			v		v	
26dB and 99% Bandwidth	2						v	v	v					v		v	
	5				v	-	-	v	v					v		v	
	7	-	-				v	v	v					v		v	
	12				v	-	-	v	v					v		v	
	13	-	-		v	-	-	v	v					v		v	
	66						v	v	v					v		v	
Conducted Band Edge	2	v	v	v	v	v	v	v	v	v	v	v		v	v		v
	5	v	v	v	v	-	-	v	v	v	v	v		v	v		v
	7	-	-	v	v	v	v	v	v	v	v	v		v	v		v
	12	v	v	v	v	-	-	v	v	v	v	v		v	v		v
	13	-	-	v	v	-	-	v	v	v	v	v		v	v		v
	66	v	v	v	v	v	v	v	v	v	v	v		v	v		v



Test Items	Band	Bandwidth (MHz)						Modulation				RB #			Test Channel		
		1.4	3	5	10	15	20	QPSK	16QAM	64QAM	256QAM	1	Half	Full	L	M	H
Conducted Spurious Emission	2	v	v	v	v	v	v	v				v			v	v	v
	5	v	v	v	v	-	-	v				v			v	v	v
	7	-	-	v	v	v	v	v				v			v	v	v
	12	v	v	v	v	-	-	v				v			v	v	v
	13	-	-	v	v	-	-	v				v			v	v	v
	66	v	v	v	v	v	v	v	v				v			v	v
Frequency Stability	2				v			v						v		v	
	5				v	-	-	v						v		v	
	7	-	-		v			v						v		v	
	12				v	-	-	v						v		v	
	13	-	-		v	-	-	v						v		v	
	66				v			v						v		v	
E.R.P / E.I.R.P	2	v	v	v	v	v	v	v	v	v	v	v	v	v	v	v	v
	4	v	v	v	v	v	v	v	v	v	v	v	v	v	v	v	v
	5	v	v	v	v	-	-	v	v	v	v	v	v	v	v	v	v
	7	-	-	v	v	v	v	v	v	v	v	v	v	v	v	v	v
	12	v	v	v	v	-	-	v	v	v	v	v	v	v	v	v	v
	13	-	-	v	v	-	-	v	v	v	v	v	v	v	v	v	v
	66	v	v	v	v	v	v	v	v	v	v	v	v	v	v	v	v
Radiated Spurious Emission	2	Worst Case														v	
	5	Worst Case														v	
	7	Worst Case														v	
	12	Worst Case														v	
	13	Worst Case														v	
	66	Worst Case														v	
Note	<ol style="list-style-type: none"> The mark "v " means that this configuration is chosen for testing The mark "- " means that this bandwidth is not supported. The device is investigated from 30MHz to 10 times of fundamental signal for radiated spurious emission test under different RB size/offset and modulations in exploratory test. Subsequently, only the worst case emissions are reported. LTE Band 66 overlaps the entire frequency range of LTE Band 4. Therefore, the test results provided in this report covers Band 66 as well as Band 4. 																



Test Items	Band	Bandwidth (MHz)								Modulation				RB #			Test Channel			
		10+10	15+5	5+15	10+5	5+10	5+5	5+3	3+5	QPSK	16QAM	64QAM	256QAM	1	Half	Full	L	M	H	
Max. Output Power	5B_CA	v	-	-	v	v	-	v	v	v	v	v	v	v	v			v	v	v
	66B_CA	v	v	v	v	v	v	-	-	v	v	v	v	v	v			v	v	v
26dB and 99% Bandwidth	5B_CA	v	-	-			-			v	v						v		v	
	66B_CA	v						-	-	v	v						v		v	
Conducted Band Edge	5B_CA	v	-	-	v	v	-	v	v	v	v	v	v	v	v		v	v	v	
	66B_CA	v	v	v	v	v	v	-	-	v	v	v	v	v	v		v	v	v	
Conducted Spurious Emission	5B_CA	v	-	-	v	v	-	v	v	v					v			v	v	v
	66B_CA	v	v	v	v	v	v	-	-	v					v			v	v	v
E.I.R.P.	5B_CA	v	-	-	v	v	-	v	v	v	v	v	v	v	v			v	v	v
	66B_CA	v	v	v	v	v	v	-	-	v	v	v	v	v	v			v	v	v
Radiated Spurious Emission	5B_CA	Worst Case																	v	
	66B_CA	Worst Case																	v	
Note	<ol style="list-style-type: none"> The mark "v" means that this configuration is chosen for testing The mark "-" means that this bandwidth is not supported. The device is investigated from 30MHz to 10 times of fundamental signal for radiated spurious emission test under different RB size/offset and modulations in exploratory test. Subsequently, only the worst case emissions are reported. All test items are based on engineering evaluation. 																			

Test Items	Band	Bandwidth (MHz)										Modulation				RB #			Test Channel				
		20+20	20+15	20+10	20+5	15+20	15+15	15+10	10+20	10+15	5+20	QPSK	16QAM	64QAM	256QAM	1	Half	Full	L	M	H		
Max. Output Power	66C_CA	v	v	v	v	v	v	v	v	v	v	v	v	v	v	v	v			v	v	v	
26dB and 99% Bandwidth	66C_CA	v												v	v							v	
Conducted Band Edge	66C_CA	v	v	v	v	v	v	v	v	v	v	v	v	v	v	v		v	v		v		
Conducted Spurious Emission	66C_CA	v	v	v	v	v	v	v	v	v	v	v	v					v			v	v	v
E.I.R.P.	66C_CA	v	v	v	v	v	v	v	v	v	v	v	v	v	v	v				v	v	v	
Radiated Spurious Emission	66C_CA	Worst Case																		v			
Note	<ol style="list-style-type: none"> The mark "v" means that this configuration is chosen for testing The mark "-" means that this bandwidth is not supported. The device is investigated from 30MHz to 10 times of fundamental signal for radiated spurious emission test under different RB size/offset and modulations in exploratory test. Subsequently, only the worst case emissions are reported. All test items are based on engineering evaluation. 																						

2.2 Connection Diagram of Test System

Adapter mode:

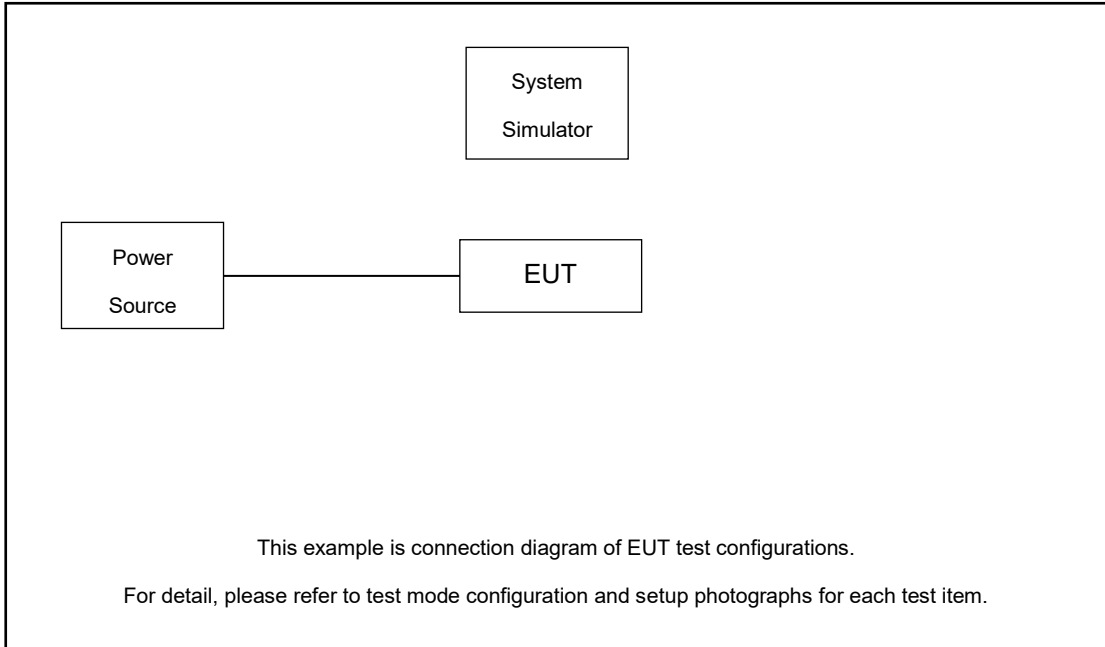

Earphone mode:

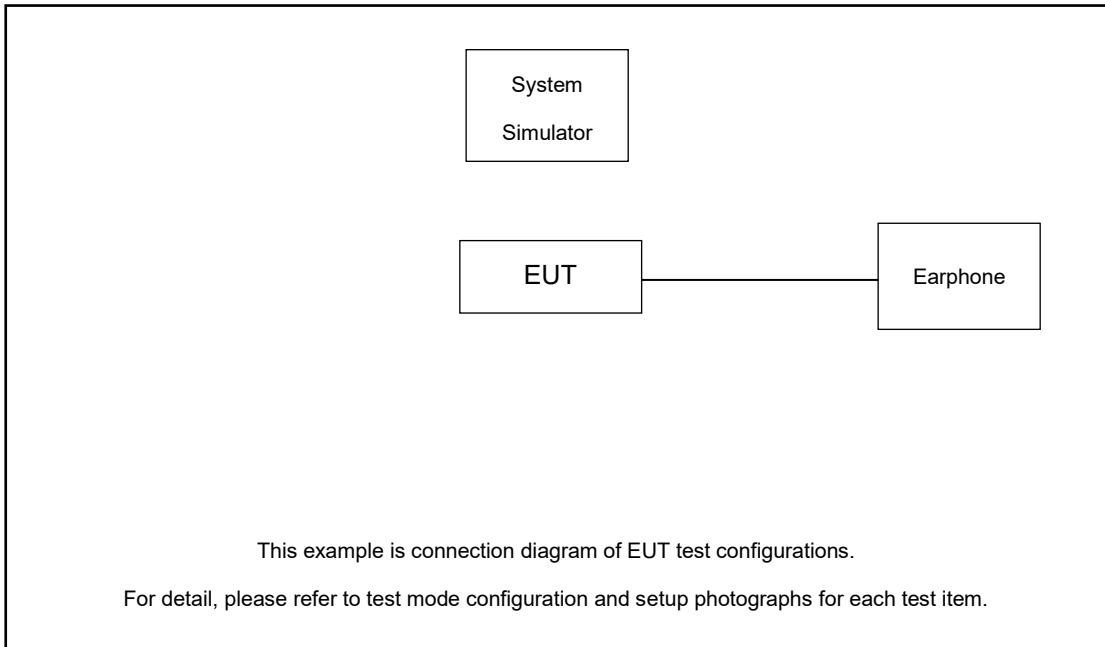

Wireless Charging mode:

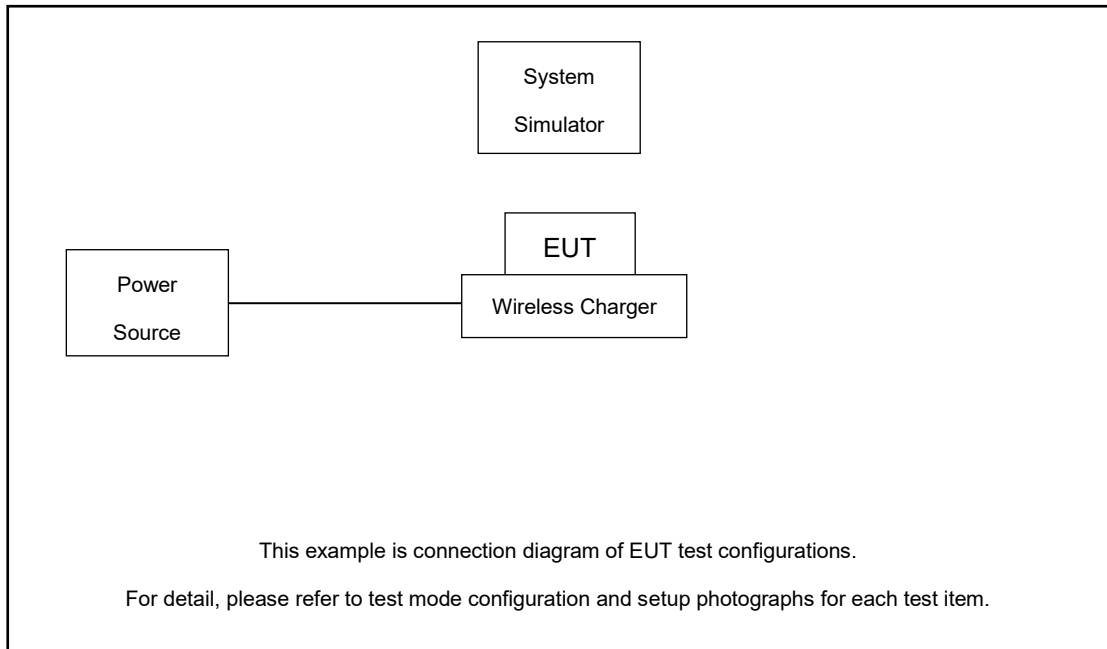

2.3 Support Unit used in test configuration and system

Item	Equipment	Trade Name	Model No.	FCC ID	Data Cable	Power Cord
1.	Power Supply	GWINSTEK	PSS-2002	N/A	N/A	Unshielded, 1.8 m
2.	LTE Base Station	Anritsu	MT8820C	N/A	N/A	Unshielded, 1.8 m
3.	Wireless Charger	N/A	N/A	N/A	N/A	N/A

2.4 Measurement Results Explanation Example

For all conducted test items:

The offset level is set in the spectrum analyzer to compensate the RF cable loss and attenuator factor between EUT conducted output port and spectrum analyzer. With the offset compensation, the spectrum analyzer reading level is exactly the EUT RF output level.

The spectrum analyzer offset is derived from RF cable loss.

Offset = RF cable loss.

Following shows an offset computation example with cable loss 4.8 dB.

Example :

$$\begin{aligned} \text{Offset(dB)} &= \text{RF cable loss(dB)}. \\ &= 4.8 \text{ (dB)} \end{aligned}$$



2.5 Frequency List of Low/Middle/High Channels

LTE Band 2 Channel and Frequency List				
BW [MHz]	Channel/Frequency(MHz)	Lowest	Middle	Highest
20	Channel	18700	18900	19100
	Frequency	1860	1880	1900
15	Channel	18675	18900	19125
	Frequency	1857.5	1880	1902.5
10	Channel	18650	18900	19150
	Frequency	1855	1880	1905
5	Channel	18625	18900	19175
	Frequency	1852.5	1880	1907.5
3	Channel	18615	18900	19185
	Frequency	1851.5	1880	1908.5
1.4	Channel	18607	18900	19193
	Frequency	1850.7	1880	1909.3

LTE Band 4 Channel and Frequency List				
BW [MHz]	Channel/Frequency(MHz)	Lowest	Middle	Highest
20	Channel	20050	20175	20300
	Frequency	1720	1732.5	1745
15	Channel	20025	20175	20325
	Frequency	1717.5	1732.5	1747.5
10	Channel	20000	20175	20350
	Frequency	1715	1732.5	1750
5	Channel	19975	20175	20375
	Frequency	1712.5	1732.5	1752.5
3	Channel	19965	20175	20385
	Frequency	1711.5	1732.5	1753.5
1.4	Channel	19957	20175	20393
	Frequency	1710.7	1732.5	1754.3



LTE Band 5 Channel and Frequency List				
BW [MHz]	Channel/Frequency(MHz)	Lowest	Middle	Highest
10	Channel	20450	20525	20600
	Frequency	829	836.5	844
5	Channel	20425	20525	20625
	Frequency	826.5	836.5	846.5
3	Channel	20415	20525	20635
	Frequency	825.5	836.5	847.5
1.4	Channel	20407	20525	20643
	Frequency	824.7	836.5	848.3

LTE Band 7 Channel and Frequency List				
BW [MHz]	Channel/Frequency(MHz)	Lowest	Middle	Highest
20	Channel	20850	21100	21350
	Frequency	2510	2535	2560
15	Channel	20825	21100	21375
	Frequency	2507.5	2535	2562.5
10	Channel	20800	21100	21400
	Frequency	2505	2535	2565
5	Channel	20775	21100	21425
	Frequency	2502.5	2535	2567.5

LTE Band 12 Channel and Frequency List				
BW [MHz]	Channel/Frequency(MHz)	Lowest	Middle	Highest
10	Channel	23060	23095	23130
	Frequency	704	707.5	711
5	Channel	23035	23095	23155
	Frequency	701.5	707.5	713.5
3	Channel	23025	23095	23165
	Frequency	700.5	707.5	714.5
1.4	Channel	23017	23095	23173
	Frequency	699.7	707.5	715.3



LTE Band 13 Channel and Frequency List				
BW [MHz]	Channel/Frequency(MHz)	Lowest	Middle	Highest
10	Channel	-	23230	-
	Frequency	-	782	-
5	Channel	23205	23230	23255
	Frequency	779.5	782	784.5

LTE Band 66 Channel and Frequency List				
BW [MHz]	Channel/Frequency(MHz)	Lowest	Middle	Highest
20	Channel	132072	132322	132572
	Frequency	1720	1745	1770
15	Channel	132047	132322	132597
	Frequency	1717.5	1745	1772.5
10	Channel	132022	132322	132622
	Frequency	1715	1745	1775
5	Channel	131997	132322	132647
	Frequency	1712.5	1745	1777.5
3	Channel	131987	132322	132657
	Frequency	1711.5	1745	1778.5
1.4	Channel	131979	132322	132665
	Frequency	1710.7	1745	1779.3



LTE Band 5B_CA Channel and Frequency List					
BW [MHz]	Channel/Frequency(MHz)		Lowest	Middle	Highest
3 + 5	PCC	Channel	20416	20501	20586
		Frequency	825.6	834.1	842.6
	SCC	Channel	20455	20540	20625
		Frequency	829.5	838.0	846.5
5 + 3	PCC	Channel	20425	20510	20595
		Frequency	826.5	835.0	843.5
	SCC	Channel	20464	20549	20634
		Frequency	830.4	838.9	847.4
5 + 10	PCC	Channel	20428	20478	20528
		Frequency	826.8	831.8	836.8
	SCC	Channel	20500	20550	20600
		Frequency	834	839	844
10 + 5	PCC	Channel	20450	20500	20550
		Frequency	829	834	839
	SCC	Channel	20522	20572	20622
		Frequency	836.2	841.2	846.2
10 + 10	PCC	Channel	20450	20476	20501
		Frequency	829	831.6	834.1
	SCC	Channel	20549	20575	20600
		Frequency	838.9	841.5	844



LTE Band 66C_CA Channel and Frequency List					
BW [MHz]	Channel/Frequency(MHz)		Lowest	Middle	Highest
10 + 15	PCC	Channel	132025	132351	132477
		Frequency	1715.3	1747.9	1760.5
	SCC	Channel	132145	132471	132597
		Frequency	1727.3	1759.9	1772.5
15 + 10	PCC	Channel	132047	132373	132499
		Frequency	1717.5	1750.1	1762.7
	SCC	Channel	132167	132493	132619
		Frequency	1729.5	1762.1	1774.7
10 + 20	PCC	Channel	132027	132328	132428
		Frequency	1715.5	1745.6	1755.6
	SCC	Channel	132171	132472	132572
		Frequency	1729.9	1760	1770
20 + 10	PCC	Channel	132072	132373	132473
		Frequency	1720	1750.1	1760.1
	SCC	Channel	132216	132517	132617
		Frequency	1734.4	1764.5	1774.5
15 + 15	PCC	Channel	132047	132347	132447
		Frequency	1717.5	1747.5	1757.5
	SCC	Channel	132197	132497	132597
		Frequency	1732.5	1762.5	1772.5
15 + 20	PCC	Channel	132050	132325	132401
		Frequency	1717.8	1745.3	1752.9
	SCC	Channel	132221	132496	132572
		Frequency	1734.9	1762.4	1770
20 + 15	PCC	Channel	132072	132348	132423
		Frequency	1720	1747.6	1755.1
	SCC	Channel	132243	132519	132594
		Frequency	1737.1	1764.7	1772.2
20 + 5	PCC	Channel	132072	132397	132522
		Frequency	1720	1752.5	1765
	SCC	Channel	132189	132514	132639
		Frequency	1731.7	1764.2	1776.7
5 + 20	PCC	Channel	132005	132330	132455



	SCC	Frequency	1713.3	1745.8	1758.3
		Channel	132122	132447	132572
20 + 20	PCC	Frequency	1725	1757.5	1770
		Channel	132072	132323	132374
	SCC	Frequency	1720	1745.1	1750.2
		Channel	132270	132521	132572
	SCC	Frequency	1739.8	1764.9	1770
		Channel			

LTE Band 66B_CA Channel and Frequency List					
BW [MHz]	Channel/Frequency(MHz)		Lowest	Middle	Highest
5 + 5	PCC	Channel	131997	132398	132599
		Frequency	1712.5	1752.6	1772.7
	SCC	Channel	132045	132446	132647
		Frequency	1717.3	1757.4	1777.5
5 + 10	PCC	Channel	132000	132375	132550
		Frequency	1712.8	1750.3	1767.8
	SCC	Channel	132072	132447	132622
		Frequency	1720	1757.5	1775
10 + 5	PCC	Channel	132022	132397	132572
		Frequency	1715	1752.5	1770
	SCC	Channel	132094	132469	132644
		Frequency	1722.2	1759.7	1777.2
5 + 15	PCC	Channel	132002	132353	132504
		Frequency	1713	1748.1	1763.2
	SCC	Channel	132095	132446	132597
		Frequency	1722.3	1757.4	1772.5
15 + 5	PCC	Channel	132047	132398	132549
		Frequency	1717.5	1752.6	1767.7
	SCC	Channel	132140	132491	132642
		Frequency	1726.8	1761.9	1777
10 + 10	PCC	Channel	132022	132373	132523
		Frequency	1715	1750.1	1765.1
	SCC	Channel	132121	132472	132622
		Frequency	1724.9	1760	1775

3 Conducted Test Items

3.1 Measuring Instruments

See list of measuring instruments of this test report.

3.2 Test Setup

3.2.1 Conducted Output Power

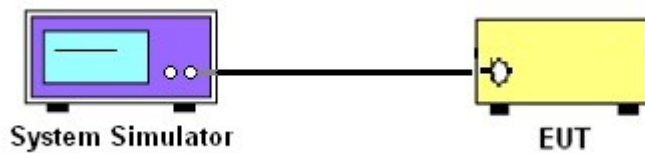

3.2.2 Peak-to-Average Ratio, Occupied Bandwidth ,Conducted Band-Edge and Conducted Spurious Emission

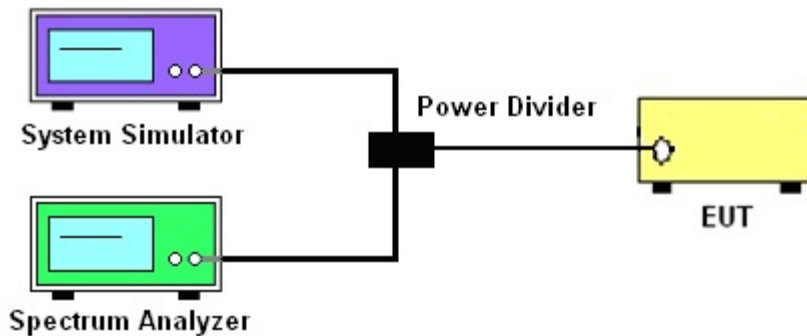

3.2.3 Frequency Stability

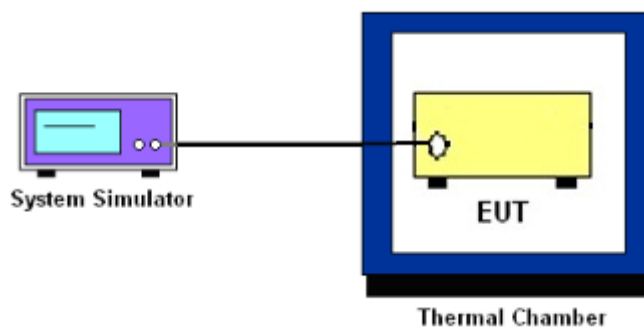

3.3 Test Result of Conducted Test

Please refer to Appendix A.



3.4 Conducted Output Power and ERP/EIRP

3.4.1 Description of the Conducted Output Power Measurement and ERP/EIRP Measurement

A system simulator was used to establish communication with the EUT. Its parameters were set to force the EUT transmitting at maximum output power. The measured power in the radio frequency on the transmitter output terminals shall be reported.

The ERP of mobile transmitters must not exceed 7 Watts for LTE Band 5.

The ERP of mobile transmitters must not exceed 3 Watts for LTE Band 12, Band 13.

The EIRP of mobile transmitters must not exceed 2 Watts for LTE Band 2 and Band 7.

The EIRP of mobile transmitters must not exceed 1 Watts for LTE Band 4 and Band 66.

According to KDB 412172 D01 Power Approach,

$EIRP = P_T + G_T - L_C$, $ERP = EIRP - 2.15$, where

P_T = transmitter output power in dBm

G_T = gain of the transmitting antenna in dBi

L_C = signal attenuation in the connecting cable between the transmitter and antenna in dB

3.4.2 Test Procedures

1. The testing follows ANSI C63.26 Section 5.2
2. The transmitter output port was connected to the system simulator.
3. Set EUT at maximum power through the system simulator.
4. Select lowest, middle, and highest channels for each band and different modulation.
5. Measure and record the power level from the system simulator.



3.5 Peak-to-Average Ratio

3.5.1 Description of the PAR Measurement

Power Complementary Cumulative Distribution Function (CCDF) curves provide a means for characterizing the power peaks of a digitally modulated signal on a statistical basis. A CCDF curve depicts the probability of the peak signal amplitude exceeding the average power level. Most contemporary measurement instrumentation include the capability to produce CCDF curves for an input signal provided that the instrument's resolution bandwidth can be set wide enough to accommodate the entire input signal bandwidth. In measuring transmissions in this band using an average power technique, the peak-to-average ratio (PAR) of the transmission may not exceed 13 dB.

3.5.2 Test Procedures

1. The testing follows ANSI C63.26 Section 5.2.3.4 (CCDF).
2. The EUT was connected to spectrum and system simulator via a power divider.
3. Set the CCDF (Complementary Cumulative Distribution Function) option in spectrum analyzer.
4. The highest RF powers were measured and recorded the maximum PAPR level associated with a probability of 0.1 %.
5. Record the deviation as Peak to Average Ratio.



3.6 Occupied Bandwidth

3.6.1 Description of Occupied Bandwidth Measurement

The occupied bandwidth is the width of a frequency band such that, below the lower and above the upper frequency limits, the mean powers emitted are each equal to a specified percentage 0.5% of the total mean transmitted power.

The 26 dB emission bandwidth is defined as the frequency range between two points, one above and one below the carrier frequency, at which the spectral density of the emission is attenuated 26 dB below the maximum in-band spectral density of the modulated signal. Spectral density (power per unit bandwidth) is to be measured with a detector of resolution bandwidth equal to approximately 1.0% of the emission bandwidth.

3.6.2 Test Procedures

1. The testing follows ANSI C63.26 Section 5.4
2. The EUT was connected to spectrum analyzer and system simulator via a power divider.
3. The spectrum analyzer center frequency is set to the nominal EUT channel center frequency. The span range for the spectrum analyzer shall be between two and five times the anticipated OBW.
4. The nominal resolution bandwidth (RBW) shall be in the range of 1 to 5 % of the anticipated OBW, and the VBW shall be at least 3 times the RBW.
5. Set the detection mode to peak, and the trace mode to max hold.
6. Determine the reference value: Set the EUT to transmit a modulated signal. Allow the trace to stabilize. Set the spectrum analyzer marker to the highest level of the displayed trace.
(this is the reference value)
7. Determine the “-26 dB down amplitude” as equal to (Reference Value – X).
8. Place two markers, one at the lowest and the other at the highest frequency of the envelope of the spectral display such that each marker is at or slightly below the “-X dB down amplitude” determined in step 6. If a marker is below this “-X dB down amplitude” value it shall be placed as close as possible to this value. The OBW is the positive frequency difference between the two markers.
9. Use the 99 % power bandwidth function of the spectrum analyzer and report the measured bandwidth.



3.7 Conducted Band Edge

3.7.1 Description of Conducted Band Edge Measurement

22.917(a)

For operations in the 824 – 849 MHz band, the FCC limit is $43 + 10\log_{10}(P[\text{Watts}])$ dB below the transmitter power P(Watts) in a 100kHz bandwidth. However, in the 1MHz bands immediately outside and adjacent to the licensee's frequency block, a resolution bandwidth of at least one percent of the emission bandwidth of the fundamental emission of the transmitter may be employed.

24.238 (a)

For operations in the 1850-1910 and 1930-1990 MHz band, the FCC limit is $43 + 10\log_{10}(P[\text{Watts}])$ dB below the transmitter power P(Watts) in a 1MHz bandwidth. However, in the 1 MHz bands immediately outside and adjacent to the frequency block a resolution bandwidth of at least one percent of the emission bandwidth of the fundamental emission of the transmitter may be employed.

27.53 (c)

For operations in the 776-788 MHz band, the FCC limit is $43 + 10\log_{10}(P[\text{Watts}])$ dB below the transmitter power P(Watts) in a 100 kHz bandwidth. However, in the 100 kHz bands immediately outside and adjacent to the frequency block, a resolution bandwidth of at least 30 kHz may be employed. In addition, the power of any unwanted emissions in any 6.25 kHz bandwidth for all frequencies between 763-775 MHz and 793-806 MHz shall be attenuated below the transmitter power, P (dBW), by at least $65 + 10 \log_{10} p(\text{watts})$, dB, for mobile and portable equipment.

27.53 (g)

For operations in the 600MHz band and 698 -746 MHz band, the FCC limit is $43 + 10\log_{10}(P[\text{Watts}])$ dB below the transmitter power P(Watts) in a 100 kHz bandwidth. However, in the 100 kilohertz bands immediately outside and adjacent to a licensee's frequency block, a resolution bandwidth of at least 30 kHz may be employed.

27.53 (h)

For operations in the 1710 – 1755 MHz band, the FCC limit is $43 + 10\log_{10}(P[\text{Watts}])$ dB below the transmitter power P(Watts) in a 1 MHz bandwidth. However, in the 1MHz bands immediately outside and adjacent to the licensee's frequency block, a resolution bandwidth of at least one percent of the emission bandwidth of the fundamental emission of the transmitter may be employed.



27.53(m)(4)

For mobile digital stations, the attenuation factor shall be not less than $40 + 10 \log (P)$ dB on all frequencies between the channel edge and 5 megahertz from the channel edge, $43 + 10 \log (P)$ dB on all frequencies between 5 megahertz and X megahertz from the channel edge, and $55 + 10 \log (P)$ dB on all frequencies more than X megahertz from the channel edge, where X is the greater of 6 megahertz or the actual emission bandwidth as defined in paragraph (m)(6) of this section. In addition, the attenuation factor shall not be less that $43 + 10 \log (P)$ dB on all frequencies between 2490.5 MHz and 2496 MHz and $55 + 10 \log (P)$ dB at or below 2490.5 MHz. Mobile Satellite Service licensees operating on frequencies below 2495 MHz may also submit a documented interference complaint against BRS licensees operating on channel BRS Channel 1 on the same terms and conditions as adjacent channel BRS or EBS licensees.

3.7.2 Test Procedures

1. The testing follows ANSI C63.26 section 5.7
2. The EUT was connected to spectrum analyzer and system simulator via a power divider.
3. The band edges of low and high channels for the highest RF powers were measured.
4. Set RBW \geq 1% EBW in the 1MHz band immediately outside and adjacent to the band edge.
5. Beyond the 1 MHz band from the band edge, RBW=1MHz was used
6. Set spectrum analyzer with RMS detector.
7. The RF fundamental frequency should be excluded against the limit line in the operating frequency band.
8. Checked that all the results comply with the emission limit line.

Example:

The limit line is derived from $43 + 10\log(P)$ dB below the transmitter power P(Watts)
 $= P(W) - [43 + 10\log(P)]$ (dB)
 $= [30 + 10\log(P)]$ (dBm) - $[43 + 10\log(P)]$ (dB) = -13dBm.

9. For LTE Band 7, the other 40 dB, and 55 dB have additionally applied same calculation above.
10. When using the integration method, the starting frequency of the integration shall be centered at one-half of the RBW away from the band edge.



3.8 Conducted Spurious Emission

3.8.1 Description of Conducted Spurious Emission Measurement

The power of any emission outside of the authorized operating frequency ranges must be lower than the transmitter power (P) by a factor of at least $43 + 10 \log (P)$ dB.

For Band 7:

The power of any emission outside of the authorized operating frequency ranges must be lower than the transmitter power (P) by a factor of at least $55 + 10 \log (P)$ dB.

It is measured by means of a calibrated spectrum analyzer and scanned from 30 MHz up to a frequency including its 10th harmonic.

3.8.2 Test Procedures

1. The testing follows ANSI C63.26 section 5.7
2. The EUT was connected to spectrum analyzer and system simulator via a power divider.
3. The RF output of EUT was connected to the spectrum analyzer by RF cable and attenuator. The path loss was compensated to the results for each measurement.
4. The middle channel for the highest RF power within the transmitting frequency was measured.
5. The conducted spurious emission for the whole frequency range was taken.
6. Make the measurement with the spectrum analyzer's RBW = 1MHz, VBW = 3MHz.
7. Set spectrum analyzer with RMS detector.
8. Taking the record of maximum spurious emission.
9. The RF fundamental frequency should be excluded against the limit line in the operating frequency band.
10. The limit line is derived from $43 + 10\log(P)$ dB below the transmitter power P(Watts)
= $P(W) - [43 + 10\log(P)]$ (dB)
= $[30 + 10\log(P)]$ (dBm) - $[43 + 10\log(P)]$ (dB)
= -13dBm.
11. For Band 7
The limit line is derived from $55 + 10\log(P)$ dB below the transmitter power P(Watts)
= $P(W) - [55 + 10\log(P)]$ (dB)
= $[30 + 10\log(P)]$ (dBm) - $[55 + 10\log(P)]$ (dB)
= -25dBm.



3.9 Frequency Stability

3.9.1 Description of Frequency Stability Measurement

The frequency stability shall be measured by variation of ambient temperature and variation of primary supply voltage to ensure that the fundamental emission stays within the authorized frequency block. The frequency stability of the transmitter shall be maintained within $\pm 0.00025\%$ ($\pm 2.5\text{ppm}$) of the center frequency.

3.9.2 Test Procedures for Temperature Variation

1. The testing follows ANSI C63.26 section 5.6.4
2. The EUT was set up in the thermal chamber and connected with the system simulator.
3. With power OFF, the temperature was decreased to -30°C and the EUT was stabilized before testing. Power was applied and the maximum change in frequency was recorded within one minute.
4. With power OFF, the temperature was raised in 10°C step up to 50°C . The EUT was stabilized at each step for at least half an hour. Power was applied and the maximum frequency change was recorded within one minute.

3.9.3 Test Procedures for Voltage Variation

1. The testing follows ANSI C63.26 section 5.6.5
2. The EUT was placed in a temperature chamber at $20\pm 5^{\circ}\text{C}$ and connected with the system simulator.
3. The power supply voltage to the EUT was varied from 85% to 115% of the nominal value for other than hand carried battery equipment.
4. For hand carried, battery powered equipment, reduce the primary ac or dc supply voltage to the battery operating end point, which shall be specified by the manufacturer.
5. The variation in frequency was measured for the worst case.

4 Radiated Test Items

4.1 Measuring Instruments

See list of measuring instruments of this test report.

4.2 Test Setup

4.2.1 For radiated test below 30MHz

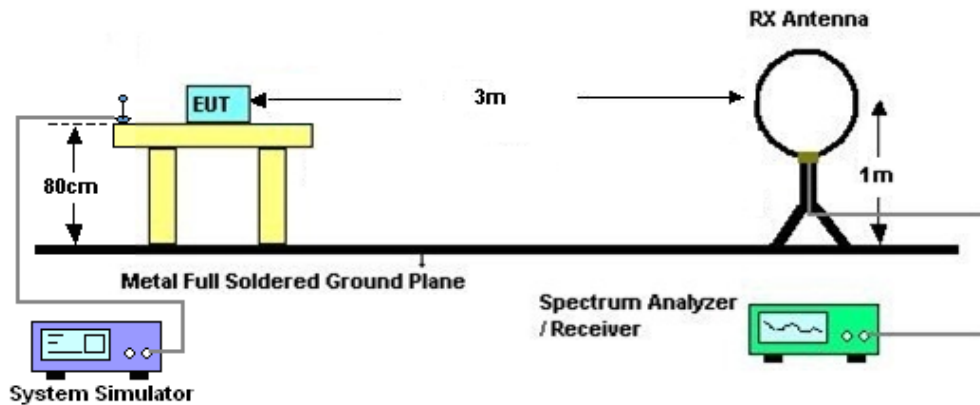

4.2.2 For radiated test from 30MHz to 1GHz

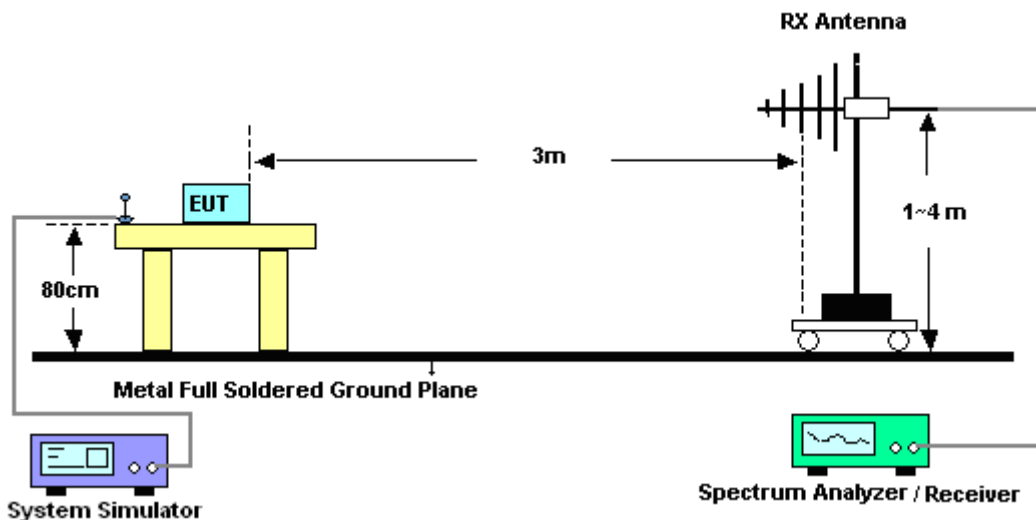

4.2.3 For radiated test above 1GHz

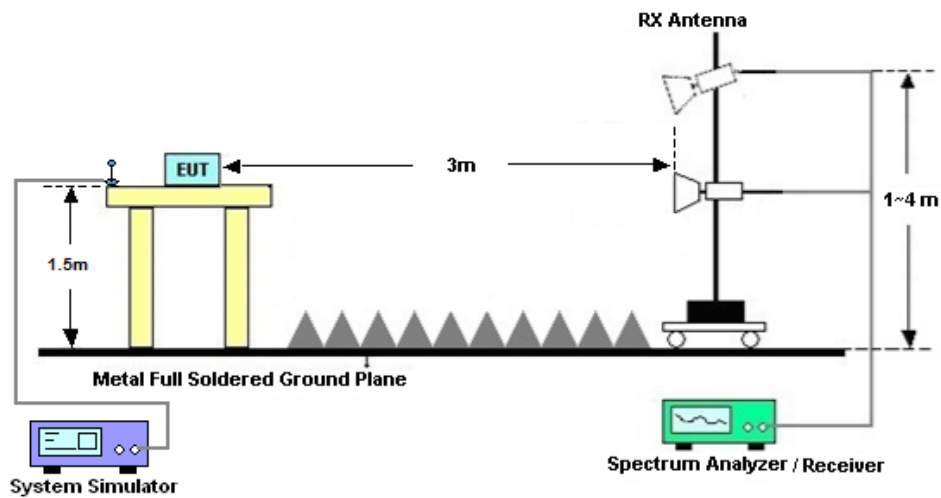

4.3 Test Result of Radiated Test

The low frequency, which started from 9 kHz to 30MHz, was pre-scanned and the result which was 20dB lower than the limit line was not reported.

Please refer to Appendix B.



4.4 Radiated Spurious Emission

4.4.1 Description of Radiated Spurious Emission

The radiated spurious emission was measured by substitution method according to ANSI C63.26. The power of any emission outside of the authorized operating frequency ranges must be attenuated below the transmitter power (P) by a factor of at least $43 + 10 \log (P)$ dB.

For Band 7

The power of any emission outside of the authorized operating frequency ranges must be attenuated below the transmitter power (P) by a factor of at least $55 + 10 \log (P)$ dB.

For LTE Band 13

For operations in the 746-758 MHz, 775-788 MHz, and 805-806 MHz bands, emissions in the band 1559-1610 MHz shall be limited to -70 dBW/MHz equivalent isotropically radiated power (EIRP) for wideband signals, and -80 dBW EIRP for discrete emissions of less than 700 Hz bandwidth.

The spectrum is scanned from 30 MHz up to a frequency including its 10th harmonic.

4.4.2 Test Procedures

1. The testing follows ANSI C63.26 Section 5.5
2. The EUT was placed on a turntable with 0.8 meter height for frequency below 1GHz and 1.5 meter height for frequency above 1GHz respectively above ground.
3. The EUT was set 3 meters from the receiving antenna mounted on the antenna tower.
4. The table was rotated 360 degrees to determine the position of the highest spurious emission.
5. The height of the receiving antenna is varied between 1m to 4m to search the maximum spurious emission for both horizontal and vertical polarizations.
6. During the measurement, the system simulator parameters were set to force the EUT transmitting at maximum output power.
7. Make the measurement with the spectrum analyzer's RBW = 1MHz, VBW = 3MHz, taking the record of maximum spurious emission.
8. A horn antenna was substituted in place of the EUT and was driven by a signal generator.
9. Tune the output power of signal generator to the same emission level with EUT maximum spurious emission.
10. $EIRP (dBm) = S.G. Power - Tx Cable Loss + Tx Antenna Gain$
11. $ERP (dBm) = EIRP - 2.15$
12. The RF fundamental frequency should be excluded against the limit line in the operating frequency band.

The limit line is derived from $43 + 10\log(P)$ dB below the transmitter power P(Watts)
 $= P(W) - [43 + 10\log(P)] (dB)$
 $= [30 + 10\log(P)] (dBm) - [43 + 10\log(P)] (dB)$
 $= -13dBm.$

13. For Band 7:

The limit line is derived from $55 + 10\log(P)$ dB below the transmitter power P(Watts)



5 List of Measuring Equipment

Instrument	Manufacturer	Model No.	Serial No.	Characteristics	Calibration Date	Test Date	Due Date	Remark
Spectrum Analyzer	R&S	FSV40	101040	10Hz~40GHz	Oct. 14, 2021	Nov. 24, 2021~ Dec. 08, 2021	Oct. 13, 2022	Conducted (TH01-KS)
Power divider	STI	STI08-0055	-	0.5~40GHz	Aug. 26, 2021	Nov. 24, 2021~ Dec. 08, 2021	Aug. 25, 2022	Conducted (TH01-KS)
Temperature & humidity chamber	Hongzhan	LP-150U	H2014011440	-40~+150°C 20%~95%RH	Jul. 12, 2021	Nov. 24, 2021~ Dec. 08, 2021	Jul. 11, 2022	Conducted (TH01-KS)
EXA Spectrum Analyzer	Keysight	N9010A	MY55150244	10Hz-44G,MAX 30dB	Apr. 13, 2021	Dec. 25, 2021	Apr. 12, 2022	Radiation (03CH04-KS)
Loop Antenna	R&S	HFH2-Z2	100321	9kHz~30MHz	Oct. 30, 2021	Dec. 25, 2021	Oct. 29, 2022	Radiation (03CH04-KS)
Bilog Antenna	TeseQ	CBL6111D	49922	30MHz-1GHz	May 30, 2021	Dec. 25, 2021	May 29, 2022	Radiation (03CH04-KS)
Horn Antenna	Schwarzbeck	BBHA9120D	1356	1GHz~18GHz	Apr. 18, 2021	Dec. 25, 2021	Apr. 17, 2022	Radiation (03CH04-KS)
SHF-EHF Horn	Com-power	AH-840	101070	18GHz~40GHz	Jan. 06, 2021	Dec. 25, 2021	Jan. 05, 2022	Radiation (03CH04-KS)
Amplifier	SONOMA	310N	187289	9KHz-1GHz	Jan. 06, 2021	Dec. 25, 2021	Jan. 05, 2022	Radiation (03CH04-KS)
Amplifier	MITEQ	EM18G40G GA	060728	18~40GHz	Jan. 07, 2021	Dec. 25, 2021	Jan. 06, 2022	Radiation (03CH04-KS)
high gain Amplifier	MITEQ	AMF-7D-00 101800-30-1 OP	2025788	1Ghz-18Ghz	Jan. 06, 2021	Dec. 25, 2021	Jan. 05, 2022	Radiation (03CH04-KS)
Amplifier	Keysight	83017A	MY57280106	500MHz~26.5GHz	Oct. 13, 2021	Dec. 25, 2021	Oct. 12, 2022	Radiation (03CH04-KS)
AC Power Source	Chroma	61601	F104090004	N/A	NCR	Dec. 25, 2021	NCR	Radiation (03CH04-KS)
Turn Table	ChamPro	EM 1000-T	060762-T	0~360 degree	NCR	Dec. 25, 2021	NCR	Radiation (03CH04-KS)
Antenna Mast	ChamPro	EM 1000-A	060762-A	1 m~4 m	NCR	Dec. 25, 2021	NCR	Radiation (03CH04-KS)

NCR: No Calibration Required



6 Uncertainty of Evaluation

The measurement uncertainties shown below were calculated in accordance with the requirements of ANSI 63.26-2015. All the measurement uncertainty value were shown with a coverage K=2 to indicate 95% level of confidence. The measurement data show herein meets or exceeds the CISPR measurement uncertainty values specified in CISPR 16-4-2 and can be compared directly to specified limit to determine compliance.

Uncertainty of Radiated Emission Measurement (30 MHz ~ 1000 MHz)

Measuring Uncertainty for a Level of Confidence of 95% (U = 2Uc(y))	3.3dB
---	-------

Uncertainty of Radiated Emission Measurement (1 GHz ~ 40 GHz)

Measuring Uncertainty for a Level of Confidence of 95% (U = 2Uc(y))	2.8dB
---	-------



Appendix A. Test Results of Conducted Test

Test Engineer :	Simle Wang	Temperature :	22~23°C
		Relative Humidity :	40~42%

Conducted Output Power(Average power) and ERP/EIRP

Ant.0

LTE Band 2

BW [MHz]	Modulation	RB Size	RB Offset	Power Low Ch. / Freq.	Power Middle Ch. / Freq.	Power High Ch. / Freq.	EIRP(W)		
Channel				18700	18900	19100			
Frequency (MHz)				1860	1880	1900	L	M	H
20	QPSK	1	0	22.78	23.15	22.89	0.1578	0.1718	0.1618
20	QPSK	1	99	22.79	22.74	22.68	0.1581	0.1563	0.1542
20	QPSK	100	0	22.83	22.85	22.82	0.1596	0.1603	0.1592
20	16QAM	1	0	23.05	23.14	23.13	0.1679	0.1714	0.1710
20	64QAM	1	0	23.03	22.94	22.89	0.1671	0.1637	0.1618
20	256QAM	1	0	19.07	19.15	19.13	0.0671	0.0684	0.0681
Channel				18675	18900	19125	EIRP(W)		
Frequency (MHz)				1857.5	1880	1902.5	L	M	H
15	QPSK	1	0	22.72	22.66	22.65	0.1556	0.1535	0.1531
15	16QAM	1	0	22.86	22.81	22.82	0.1607	0.1589	0.1592
Channel				18650	18900	19150	EIRP(W)		
Frequency (MHz)				1855	1880	1905	L	M	H
10	QPSK	1	0	22.86	22.80	22.76	0.1607	0.1585	0.1570
10	16QAM	1	0	23.02	23.08	23.11	0.1667	0.1690	0.1702
Channel				18625	18900	19175	EIRP(W)		
Frequency (MHz)				1852.5	1880	1907.5	L	M	H
5	QPSK	1	0	22.86	22.75	22.78	0.1607	0.1567	0.1578
5	16QAM	1	0	23.14	23.06	23.09	0.1714	0.1683	0.1694
Channel				18615	18900	19185	EIRP(W)		
Frequency (MHz)				1851.5	1880	1908.5	L	M	H
3	QPSK	1	0	22.72	22.90	22.74	0.1556	0.1622	0.1563
3	16QAM	1	0	23.14	23.14	23.13	0.1714	0.1714	0.1710
Channel				18607	18900	19193	EIRP(W)		
Frequency (MHz)				1850.7	1880	1909.3	L	M	H
1.4	QPSK	1	0	22.79	22.74	22.79	0.1581	0.1563	0.1581
1.4	16QAM	1	0	23.09	23.08	23.13	0.1694	0.1690	0.1710



LTE Band 4

BW [MHz]	Modulation	RB Size	RB Offset	Power Low Ch. / Freq.	Power Middle Ch. / Freq.	Power High Ch. / Freq.	EIRP(W)		
Channel				20050	20175	20300	EIRP(W)		
Frequency (MHz)				1720	1732.5	1745	L	M	H
20	QPSK	1	0	22.93	22.98	22.91	0.1524	0.1542	0.1517
20	QPSK	1	99	22.82	22.79	22.81	0.1486	0.1476	0.1483
20	QPSK	100	0	22.74	22.87	22.80	0.1459	0.1503	0.1479
20	16QAM	1	0	22.87	22.73	22.92	0.1503	0.1455	0.1521
20	64QAM	1	0	22.75	22.73	22.91	0.1462	0.1455	0.1517
20	256QAM	1	0	19.23	19.32	19.38	0.0650	0.0664	0.0673
Channel				20025	20175	20325	EIRP(W)		
Frequency (MHz)				1717.5	1732.5	1747.5	L	M	H
15	QPSK	1	0	22.75	22.91	22.77	0.1462	0.1517	0.1469
15	16QAM	1	0	22.74	22.69	22.84	0.1459	0.1442	0.1493
Channel				20000	20175	20350	EIRP(W)		
Frequency (MHz)				1715	1732.5	1750	L	M	H
10	QPSK	1	0	22.76	22.81	22.89	0.1466	0.1483	0.1510
10	16QAM	1	0	22.85	22.63	22.84	0.1496	0.1422	0.1493
Channel				19975	20175	20375	EIRP(W)		
Frequency (MHz)				1712.5	1732.5	1752.5	L	M	H
5	QPSK	1	0	22.91	22.83	22.78	0.1517	0.1489	0.1472
5	16QAM	1	0	22.67	22.58	22.80	0.1435	0.1406	0.1479
Channel				19965	20175	20385	EIRP(W)		
Frequency (MHz)				1711.5	1732.5	1753.5	L	M	H
3	QPSK	1	0	22.77	22.94	22.75	0.1469	0.1528	0.1462
3	16QAM	1	0	22.85	22.63	22.83	0.1496	0.1422	0.1489
Channel				19950	20175	20393	EIRP(W)		
Frequency (MHz)				1710	1732.5	1754.3	L	M	H
1.4	QPSK	1	0	22.87	22.81	22.92	0.1503	0.1483	0.1521
1.4	16QAM	1	0	22.86	22.59	22.79	0.1500	0.1409	0.1476



LTE Band 5

BW [MHz]	Modulation	RB Size	RB Offset	Power Low Ch. / Freq.	Power Middle Ch. / Freq.	Power High Ch. / Freq.	ERP(W)		
Channel				20450	20525	20600	ERP(W)		
Frequency (MHz)				829	836.5	844	L	M	H
10	QPSK	1	0	22.84	22.91	22.85	0.0512	0.0520	0.0513
10	QPSK	1	49	22.71	22.68	22.69	0.0497	0.0493	0.0494
10	QPSK	50	0	22.66	22.76	22.73	0.0491	0.0502	0.0499
10	16QAM	1	0	22.87	22.84	22.80	0.0515	0.0512	0.0507
10	64QAM	1	0	22.63	22.79	22.85	0.0488	0.0506	0.0513
10	256QAM	1	0	18.64	18.95	18.91	0.0195	0.0209	0.0207
Channel				20425	20525	20625	ERP(W)		
Frequency (MHz)				826.5	836.5	846.5	L	M	H
5	QPSK	1	0	22.67	22.87	22.71	0.0492	0.0515	0.0497
5	16QAM	1	0	22.53	22.79	22.77	0.0476	0.0506	0.0504
Channel				20415	20525	20635	ERP(W)		
Frequency (MHz)				825.5	836.5	847.5	L	M	H
3	QPSK	1	0	22.73	22.84	22.80	0.0499	0.0512	0.0507
3	16QAM	1	0	22.83	22.78	22.67	0.0511	0.0505	0.0492
Channel				20407	20525	20643	ERP(W)		
Frequency (MHz)				824.7	836.5	848.3	L	M	H
1.4	QPSK	1	0	22.74	22.79	22.69	0.0500	0.0506	0.0494
1.4	16QAM	1	0	22.72	22.83	22.61	0.0498	0.0511	0.0485



LTE Band 7

BW [MHz]	Modulation	RB Size	RB Offset	Power Low Ch. / Freq.	Power Middle Ch. / Freq.	Power High Ch. / Freq.	EIRP(W)		
Channel				20850	20850	21350	EIRP(W)		
Frequency (MHz)				2510	2535	2560	L	M	H
20	QPSK	1	0	23.37	23.53	23.45	0.2275	0.2360	0.2317
20	QPSK	1	99	23.44	23.50	23.43	0.2312	0.2344	0.2307
20	QPSK	100	0	23.41	23.49	23.45	0.2296	0.2339	0.2317
20	16QAM	1	0	23.50	23.45	23.41	0.2344	0.2317	0.2296
20	64QAM	1	0	23.37	23.45	23.50	0.2275	0.2317	0.2344
20	256QAM	1	0	19.50	19.63	19.71	0.0933	0.0962	0.0979
Channel				20825	21100	21375	EIRP(W)		
Frequency (MHz)				2507.5	2535	2562.5	L	M	H
15	QPSK	1	0	23.21	23.48	23.30	0.2193	0.2333	0.2239
15	16QAM	1	0	23.40	23.41	23.34	0.2291	0.2296	0.2259
Channel				20800	21100	21400	EIRP(W)		
Frequency (MHz)				2505	2535	2565	L	M	H
10	QPSK	1	0	23.36	23.34	23.48	0.2270	0.2259	0.2333
10	16QAM	1	0	23.28	23.41	23.20	0.2228	0.2296	0.2188
Channel				20775	21100	21425	EIRP(W)		
Frequency (MHz)				2502.5	2535	2567.5	L	M	H
5	QPSK	1	0	23.35	23.45	23.35	0.2265	0.2317	0.2265
5	16QAM	1	0	23.43	23.29	23.32	0.2307	0.2234	0.2249



LTE Band 66

BW [MHz]	Modulation	RB Size	RB Offset	Power Low Ch. / Freq.	Power Middle Ch. / Freq.	Power High Ch. / Freq.	EIRP(W)		
Channel				132072	132322	132572	EIRP(W)		
Frequency (MHz)				1720	1745	1770	L	M	H
20	QPSK	1	0	23.06	23.16	22.98	0.1570	0.1607	0.1542
20	QPSK	1	99	22.94	22.91	22.86	0.1528	0.1517	0.1500
20	QPSK	100	0	23.02	23.05	22.84	0.1556	0.1567	0.1493
20	16QAM	1	0	22.95	22.96	23.06	0.1531	0.1535	0.1570
20	64QAM	1	0	23.02	22.96	22.92	0.1556	0.1535	0.1521
20	256QAM	1	0	19.20	19.37	19.18	0.0646	0.0671	0.0643
Channel				132047	132322	132597	EIRP(W)		
Frequency (MHz)				1717.5	1745	1772.5	L	M	H
15	QPSK	1	0	22.91	23.07	22.79	0.1517	0.1574	0.1476
15	16QAM	1	0	22.78	22.84	22.89	0.1472	0.1493	0.1510
Channel				132022	132322	132622	EIRP(W)		
Frequency (MHz)				1715	1745	1775	L	M	H
10	QPSK	1	0	23.03	23.15	22.83	0.1560	0.1603	0.1489
10	16QAM	1	0	22.83	22.89	23.01	0.1489	0.1510	0.1552
Channel				131997	132322	132647	EIRP(W)		
Frequency (MHz)				1712.5	1745	1777.5	L	M	H
5	QPSK	1	0	22.96	23.13	22.86	0.1535	0.1596	0.1500
5	16QAM	1	0	22.82	22.78	22.89	0.1486	0.1472	0.1510
Channel				131987	132322	132657	EIRP(W)		
Frequency (MHz)				1711.5	1745	1778.5	L	M	H
3	QPSK	1	0	22.91	23.14	22.79	0.1517	0.1600	0.1476
3	16QAM	1	0	22.84	22.82	22.96	0.1493	0.1486	0.1535
Channel				131979	132322	132665	EIRP(W)		
Frequency (MHz)				1710.7	1745	1779.3	L	M	H
1.4	QPSK	1	0	22.90	23.14	22.80	0.1514	0.1600	0.1479
1.4	16QAM	1	0	22.90	22.86	22.95	0.1514	0.1500	0.1531



< Ant.1 >

LTE Band 12

BW [MHz]	Modulation	RB Size	RB Offset	Power Low Ch. / Freq.	Power Middle Ch. / Freq.	Power High Ch. / Freq.	ERP(W)		
Channel				23060	23095	23130	ERP(W)		
Frequency (MHz)				704	707.5	711	L	M	H
10	QPSK	1	0	24.29	24.38	24.34	0.0581	0.0593	0.0587
10	QPSK	1	49	24.23	24.30	24.10	0.0573	0.0582	0.0556
10	QPSK	50	0	23.35	23.37	23.36	0.0468	0.0470	0.0469
10	16QAM	1	0	23.39	23.47	23.56	0.0472	0.0481	0.0491
10	64QAM	1	0	22.44	22.35	22.53	0.0379	0.0372	0.0387
10	256QAM	1	0	19.56	19.48	19.38	0.0195	0.0192	0.0187
Channel				23035	23095	23205	ERP(W)		
Frequency (MHz)				701.5	707.5	718.5	L	M	H
5	QPSK	1	0	24.29	24.28	24.35	0.0581	0.0579	0.0589
5	16QAM	1	0	23.49	23.47	23.53	0.0483	0.0481	0.0488
Channel				23025	23095	23195	ERP(W)		
Frequency (MHz)				700.5	707.5	717.5	L	M	H
3	QPSK	1	0	24.35	24.29	24.26	0.0589	0.0581	0.0577
3	16QAM	1	0	23.45	23.51	23.20	0.0479	0.0485	0.0452
Channel				23017	23095	23173	ERP(W)		
Frequency (MHz)				699.7	707.5	715.3	L	M	H
1.4	QPSK	1	0	24.19	24.19	24.34	0.0568	0.0568	0.0587
1.4	16QAM	1	0	23.29	23.31	23.51	0.0461	0.0463	0.0485

LTE Band 13

BW [MHz]	Modulation	RB Size	RB Offset	Power Low Ch. / Freq.	Power Middle Ch. / Freq.	Power High Ch. / Freq.	ERP(W)		
Channel				23230			ERP(W)		
Frequency (MHz)				782				M	
10	QPSK	1	0		24.33			0.0600	
10	QPSK	1	49		24.31			0.0597	
10	QPSK	50	0		23.27			0.0470	
10	16QAM	1	0		23.67			0.0515	
10	64QAM	1	0		22.54			0.0397	
10	256QAM	1	0		19.52			0.0198	
Channel				23205	23230	23255	ERP(W)		
Frequency (MHz)				779.5	782	784.5	L	M	H
5	QPSK	1	0	24.18	24.27	24.29	0.0579	0.0592	0.0594
5	16QAM	1	0	23.56	23.52	23.64	0.0502	0.0498	0.0512



CA Power

< Ant.0 >

CA_5B

Combination 10MHz+10MHz (50RB+50RB)								
Channel	Modulation	PCC		SCC		Measured Power	ERP(W)	EIRP(W)
		RB Size	RB offset	RB Size	RB offset			
L	QPSK	1	Max	1	0	22.78	0.0505	0.0828
M	QPSK	1	Max	1	0	22.83	0.0511	0.0838
H	QPSK	1	Max	1	0	22.72	0.0498	0.0817
L	16QAM	1	Max	1	0	22.62	0.0486	0.0798
M	16QAM	1	Max	1	0	22.68	0.0493	0.0809
H	16QAM	1	Max	1	0	22.59	0.0483	0.0793
L	64QAM	1	Max	1	0	22.48	0.0471	0.0773
M	64QAM	1	Max	1	0	22.53	0.0476	0.0782
H	64QAM	1	Max	1	0	22.41	0.0463	0.0760
L	256QAM	1	Max	1	0	21.05	0.0339	0.0556
M	256QAM	1	Max	1	0	21.11	0.0344	0.0564
H	256QAM	1	Max	1	0	21.01	0.0336	0.0551
Combination 10MHz+5MHz (50RB+25RB)								
Channel	Modulation	PCC		SCC		Measured Power	ERP(W)	EIRP(W)
		RB Size	RB offset	RB Size	RB offset			
M	QPSK	1	Max	1	0	22.75	0.0501	0.0822
M	16QAM	1	Max	1	0	22.59	0.0483	0.0793
Combination 5MHz+10MHz (25RB+50RB)								
Channel	Modulation	PCC		SCC		Measured Power	ERP(W)	EIRP(W)
		RB Size	RB offset	RB Size	RB offset			
M	QPSK	1	Max	1	0	22.78	0.0505	0.0828
M	16QAM	1	Max	1	0	22.63	0.0488	0.0800
Combination 5MHz+3MHz (25RB+15RB)								
Channel	Modulation	PCC		SCC		Measured Power	ERP(W)	EIRP(W)
		RB Size	RB offset	RB Size	RB offset			
M	QPSK	1	Max	1	0	22.45	0.0468	0.0767
M	16QAM	1	Max	1	0	22.32	0.0454	0.0745
Combination 3MHz+5MHz (15RB+25RB)								
Channel	Modulation	PCC		SCC		Measured Power	ERP(W)	EIRP(W)
		RB Size	RB offset	RB Size	RB offset			
M	QPSK	1	Max	1	0	22.48	0.0471	0.0773
M	16QAM	1	Max	1	0	22.41	0.0463	0.0760



CA_66C

Combination 20MHz+20MHz (100RB+100RB)							
Channel	Modulation	PCC		SCC		Measured Power	EIRP(W)
		RB Size	RB offset	RB Size	RB offset		
L	QPSK	1	Max	1	0	22.06	0.1247
M	QPSK	1	Max	1	0	22.13	0.1268
H	QPSK	1	Max	1	0	21.92	0.1208
L	16QAM	1	Max	1	0	22.01	0.1233
M	16QAM	1	Max	1	0	22.09	0.1256
H	16QAM	1	Max	1	0	21.85	0.1189
L	64QAM	1	Max	1	0	21.95	0.1216
M	64QAM	1	Max	1	0	22.03	0.1239
H	64QAM	1	Max	1	0	21.74	0.1159
L	256QAM	1	Max	1	0	21.11	0.1002
M	256QAM	1	Max	1	0	21.15	0.1012
H	256QAM	1	Max	1	0	21.03	0.0984
Combination 20MHz+15MHz (100RB+75RB)							
Channel	Modulation	PCC		SCC		Measured Power	EIRP(W)
		RB Size	RB offset	RB Size	RB offset		
M	QPSK	1	Max	1	0	21.95	0.1216
M	16QAM	1	Max	1	0	21.82	0.1180
Combination 15MHz+20MHz (75RB+100RB)							
Channel	Modulation	PCC		SCC		Measured Power	EIRP(W)
		RB Size	RB offset	RB Size	RB offset		
M	QPSK	1	Max	1	0	21.89	0.1199
M	16QAM	1	Max	1	0	21.83	0.1183
Combination 15MHz+15MHz (75RB+75RB)							
Channel	Modulation	PCC		SCC		Measured Power	EIRP(W)
		RB Size	RB offset	RB Size	RB offset		
M	QPSK	1	Max	1	0	21.86	0.1191
M	16QAM	1	Max	1	0	21.74	0.1159
Combination 20MHz+10MHz (100RB+50RB)							
Channel	Modulation	PCC		SCC		Measured Power	EIRP(W)
		RB Size	RB offset	RB Size	RB offset		
M	QPSK	1	Max	1	0	21.92	0.1208
M	16QAM	1	Max	1	0	21.84	0.1186
Combination 10MHz+20MHz (50RB+100RB)							
Channel	Modulation	PCC		SCC		Measured Power	EIRP(W)
		RB Size	RB offset	RB Size	RB offset		
M	QPSK	1	Max	1	0	21.97	0.1222
M	16QAM	1	Max	1	0	21.88	0.1197



Combination 15MHz+10MHz (75RB+50RB)							
Channel	Modulation	PCC		SCC		Measured Power	EIRP(W)
		RB Size	RB offset	RB Size	RB offset		
M	QPSK	1	Max	1	0	21.62	0.1127
M	16QAM	1	Max	1	0	21.55	0.1109
Combination 10MHz+15MHz (50RB+75RB)							
Channel	Modulation	PCC		SCC		Measured Power	EIRP(W)
		RB Size	RB offset	RB Size	RB offset		
M	QPSK	1	Max	1	0	21.69	0.1146
M	16QAM	1	Max	1	0	21.63	0.1130
Combination 20MHz+5MHz (100RB+25RB)							
Channel	Modulation	PCC		SCC		Measured Power	EIRP(W)
		RB Size	RB offset	RB Size	RB offset		
M	QPSK	1	Max	1	0	21.75	0.1161
M	16QAM	1	Max	1	0	21.62	0.1127
Combination 5MHz+20MHz (25RB+100RB)							
Channel	Modulation	PCC		SCC		Measured Power	EIRP(W)
		RB Size	RB offset	RB Size	RB offset		
M	QPSK	1	Max	1	0	21.87	0.1194
M	16QAM	1	Max	1	0	21.68	0.1143



< Ant. 1 >

CA_66B

Combination 10MHz+10MHz (50RB+50RB)							
Channel	Modulation	PCC		SCC		Measured Power	EIRP(W)
		RB Size	RB offset	RB Size	RB offset		
L	QPSK	1	Max	1	0	22.38	0.1225
M	QPSK	1	Max	1	0	22.52	0.1265
H	QPSK	1	Max	1	0	22.31	0.1205
L	16QAM	1	Max	1	0	22.33	0.1211
M	16QAM	1	Max	1	0	22.48	0.1253
H	16QAM	1	Max	1	0	22.29	0.1199
L	64QAM	1	Max	1	0	22.26	0.1191
M	64QAM	1	Max	1	0	22.35	0.1216
H	64QAM	1	Max	1	0	22.23	0.1183
L	256QAM	1	Max	1	0	21.28	0.0951
M	256QAM	1	Max	1	0	21.37	0.0971
H	256QAM	1	Max	1	0	21.23	0.0940
Combination 15MHz+5MHz (75RB+25RB)							
Channel	Modulation	PCC		SCC		Measured Power	EIRP(W)
		RB Size	RB offset	RB Size	RB offset		
M	QPSK	1	Max	1	0	22.36	0.1219
M	16QAM	1	Max	1	0	22.22	0.1180
Combination 5MHz+15MHz (25RB+75RB)							
Channel	Modulation	PCC		SCC		Measured Power	EIRP(W)
		RB Size	RB offset	RB Size	RB offset		
M	QPSK	1	Max	1	0	22.39	0.1227
M	16QAM	1	Max	1	0	22.28	0.1197
Combination 10MHz+5MHz (50RB+25RB)							
Channel	Modulation	PCC		SCC		Measured Power	EIRP(W)
		RB Size	RB offset	RB Size	RB offset		
M	QPSK	1	Max	1	0	22.38	0.1225
M	16QAM	1	Max	1	0	22.21	0.1178
Combination 5MHz+10MHz (25RB+50RB)							
Channel	Modulation	PCC		SCC		Measured Power	EIRP(W)
		RB Size	RB offset	RB Size	RB offset		
M	QPSK	1	Max	1	0	22.29	0.1199
M	16QAM	1	Max	1	0	22.14	0.1159
Combination 5MHz+5MHz (25RB+25RB)							
Channel	Modulation	PCC		SCC		Measured Power	EIRP(W)
		RB Size	RB offset	RB Size	RB offset		
M	QPSK	1	Max	1	0	22.37	0.1222
M	16QAM	1	Max	1	0	22.24	0.1186



LTE Band 2

Peak-to-Average Ratio

Mode	LTE Band 2 / 20MHz				
Mod.	QPSK	16QAM	64QAM	256QAM	Limit: 13dB
RB Size	Full RB	Full RB	Full RB	Full RB	Result
Middle CH	7.13	7.45	7.57	6.67	PASS

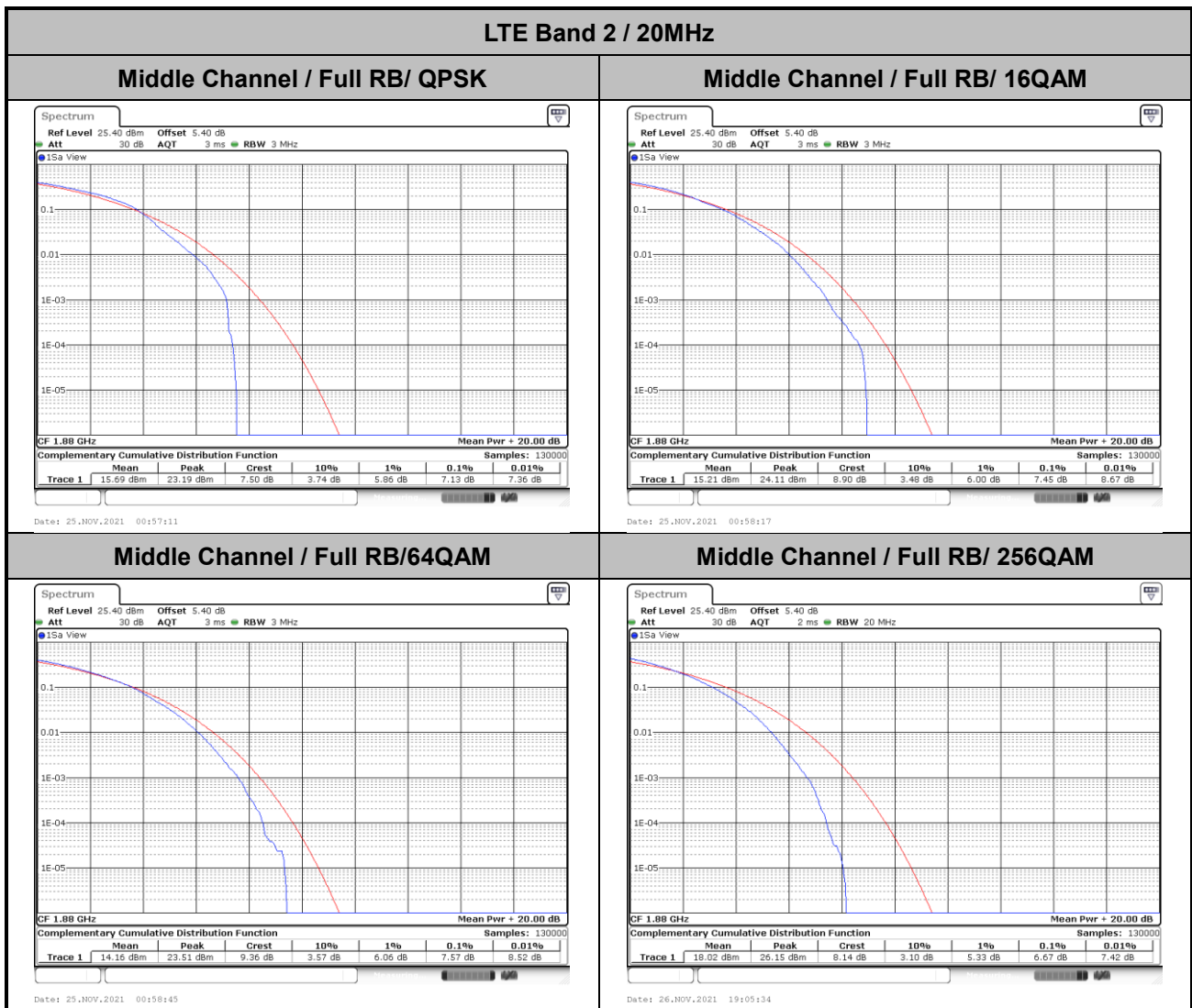



26dB Bandwidth

Mode	LTE Band 2 : 26dB BW(MHz)	
BW	20MHz	
Mod.	QPSK	16QAM
Middle CH	20.42	20.22

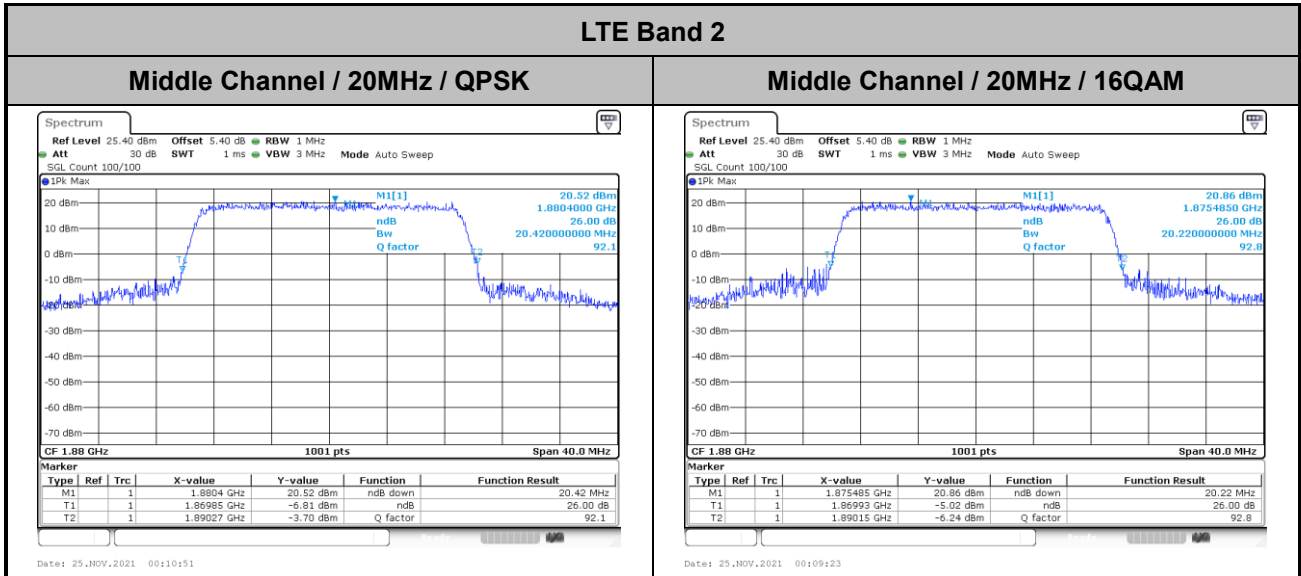



Occupied Bandwidth

Mode	LTE Band 2 : 99%OBW(MHz)	
BW	20MHz	
Mod.	QPSK	16QAM
Middle CH	18.42	18.42

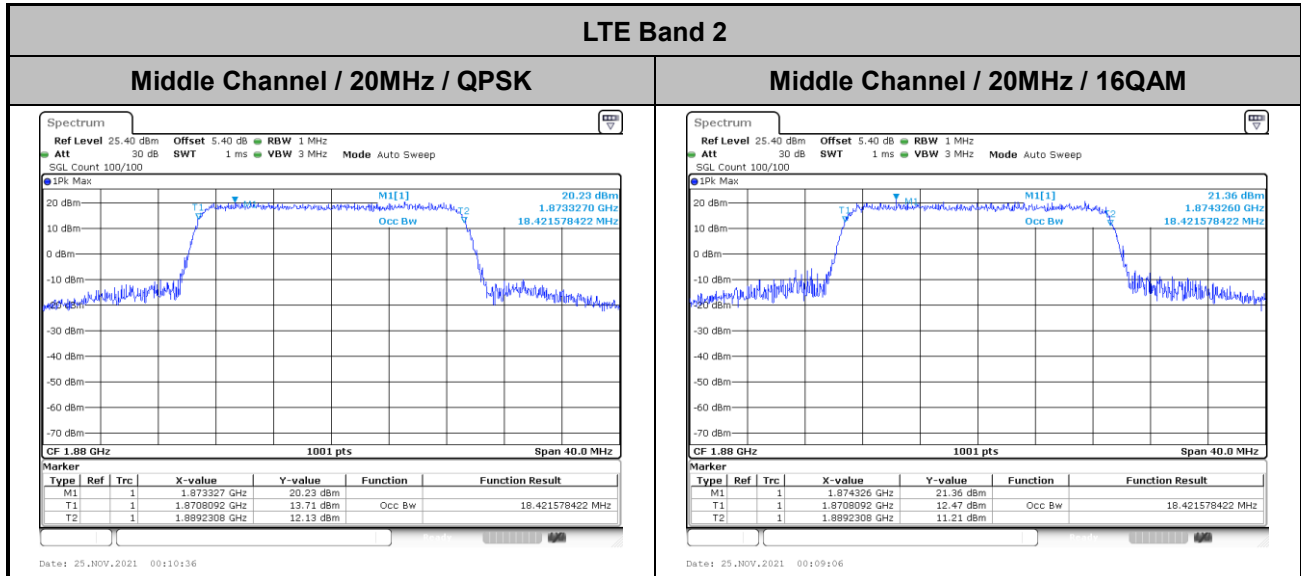



Conducted Band Edge

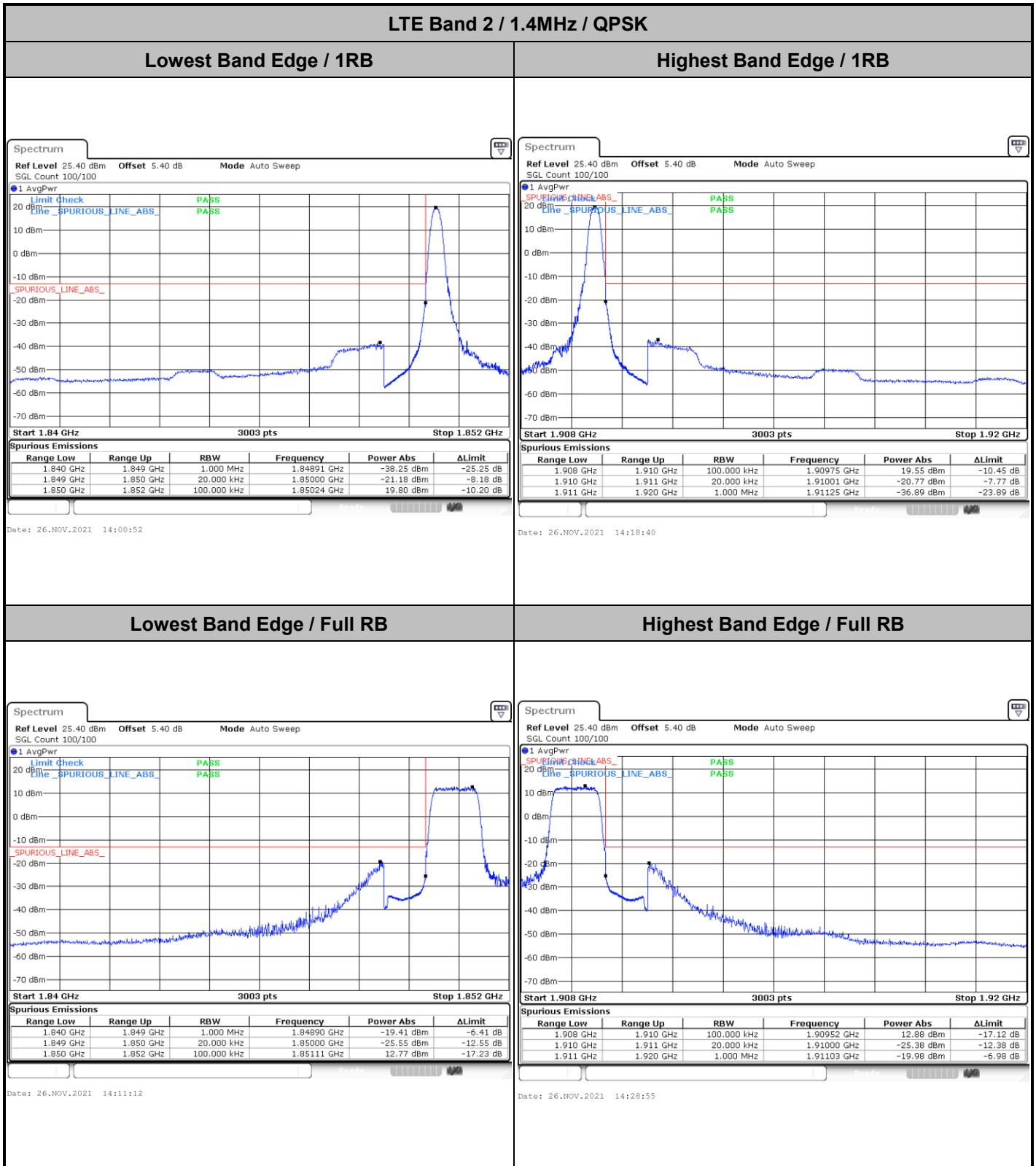



LTE Band 2 / 1.4MHz / 16QAM

Lowest Band Edge / 1 RB

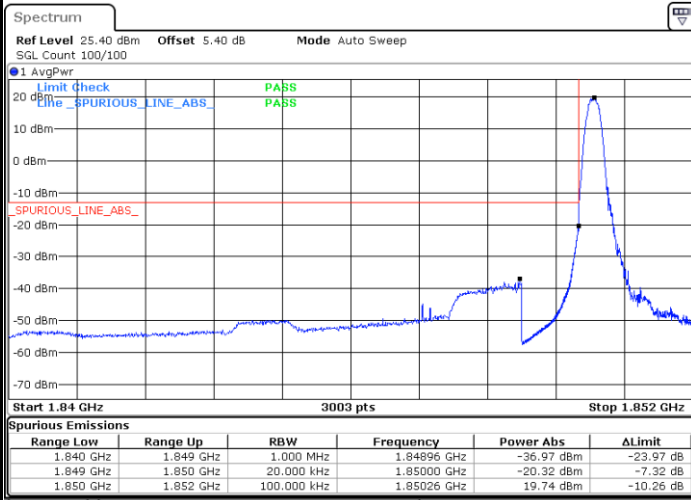

Date: 26.NOV.2021 14:02:21

Highest Band Edge / 1 RB

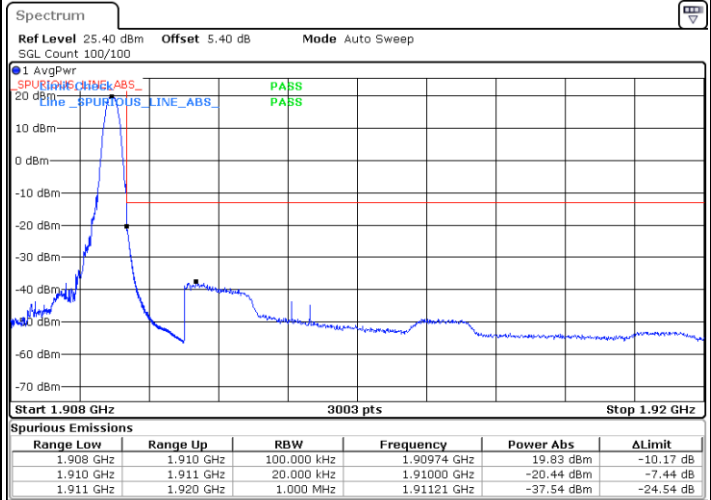

Date: 26.NOV.2021 14:20:08

Lowest Band Edge / Full RB

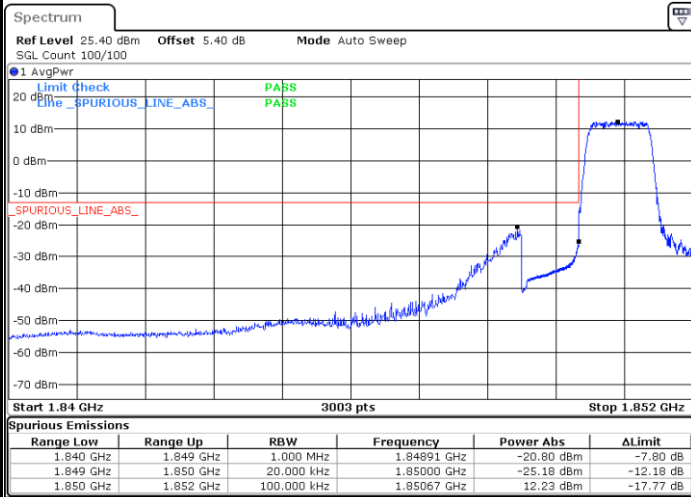

Date: 26.NOV.2021 14:09:44

Highest Band Edge / Full RB

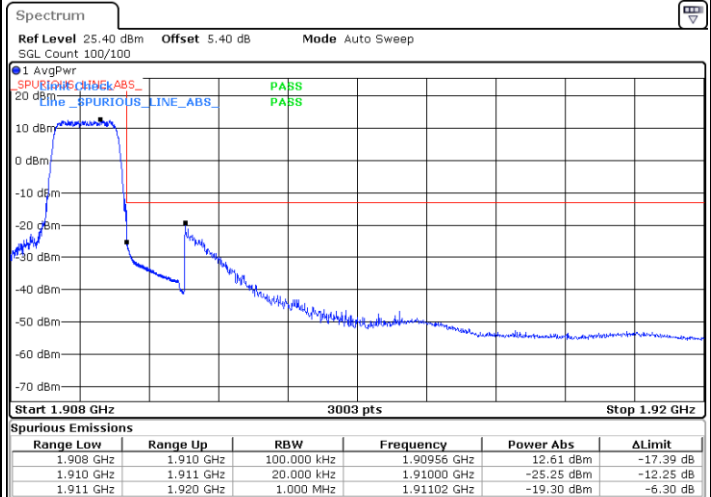

Date: 26.NOV.2021 14:27:27



LTE Band 2 / 1.4MHz / 64QAM

Lowest Band Edge / 1 RB

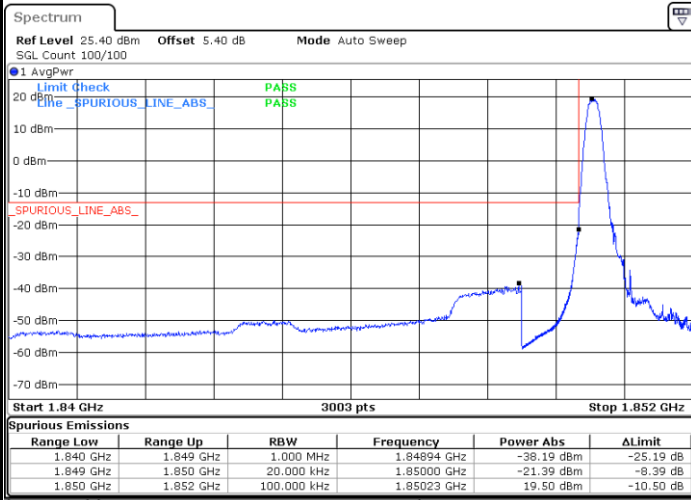

Date: 26.NOV.2021 14:03:50

Highest Band Edge / 1 RB

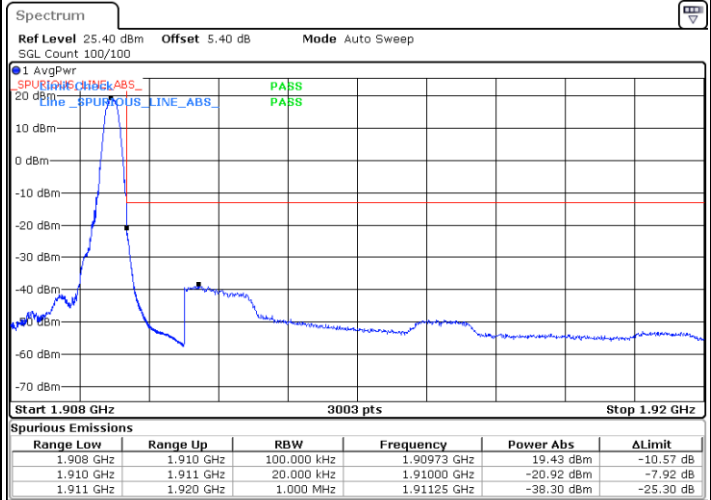

Date: 26.NOV.2021 14:21:36

Lowest Band Edge / Full RB

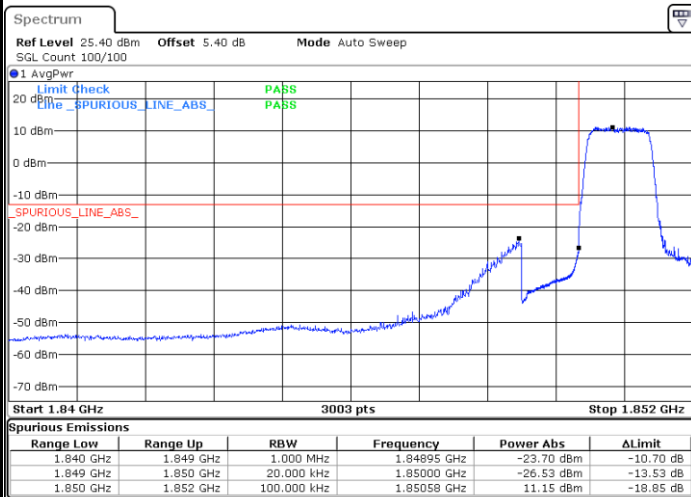

Date: 26.NOV.2021 14:08:15

Highest Band Edge / Full RB

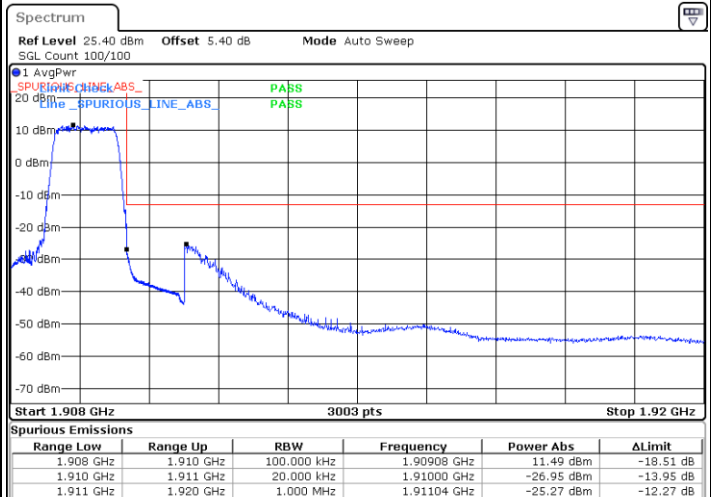

Date: 26.NOV.2021 14:26:00



LTE Band 2 / 1.4MHz / 256QAM

Lowest Band Edge / 1 RB

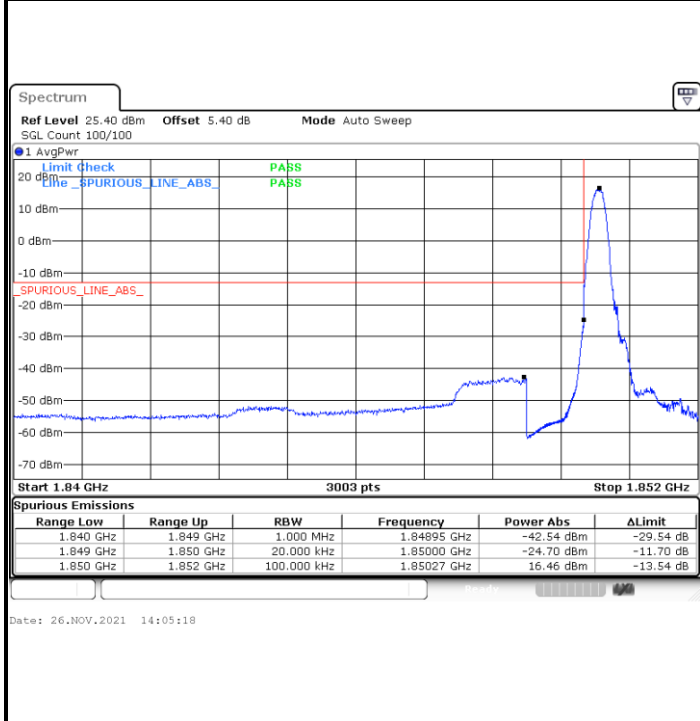

Highest Band Edge / 1 RB

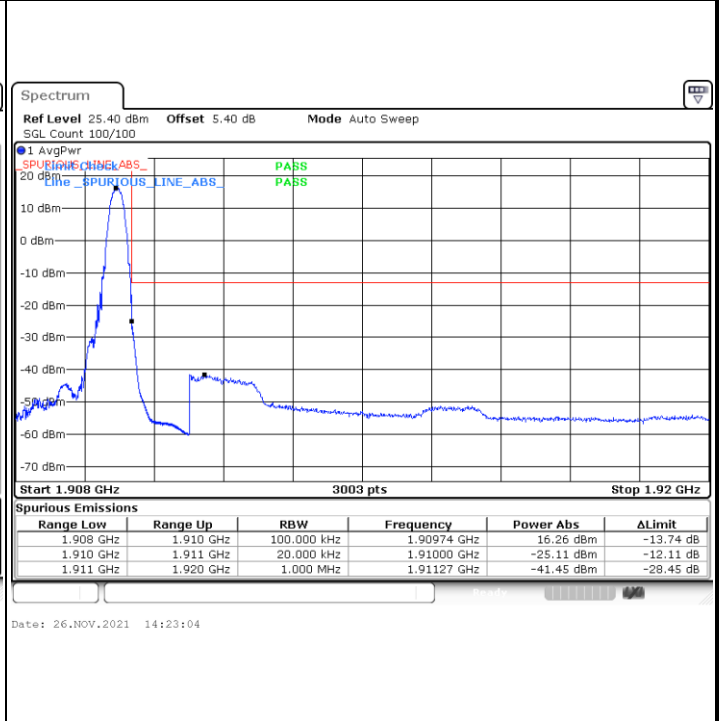

Lowest Band Edge / Full RB

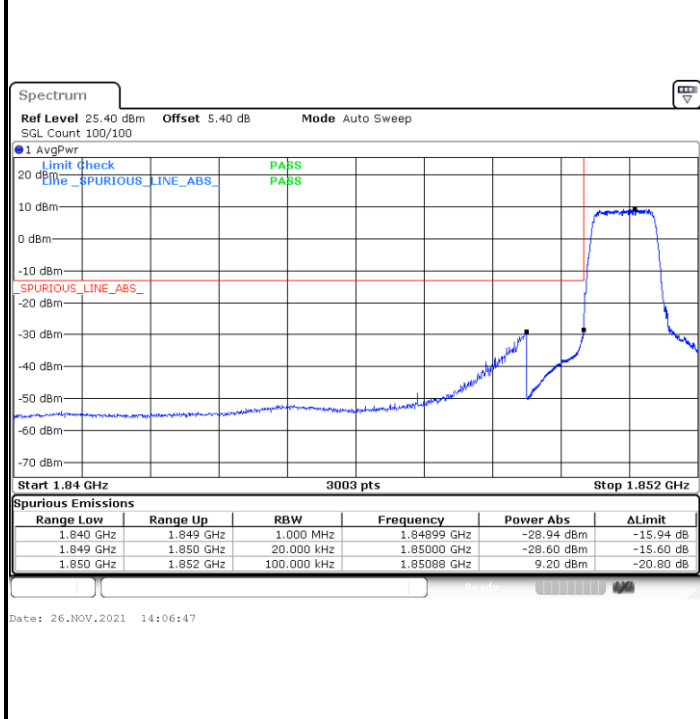

Highest Band Edge / Full RB

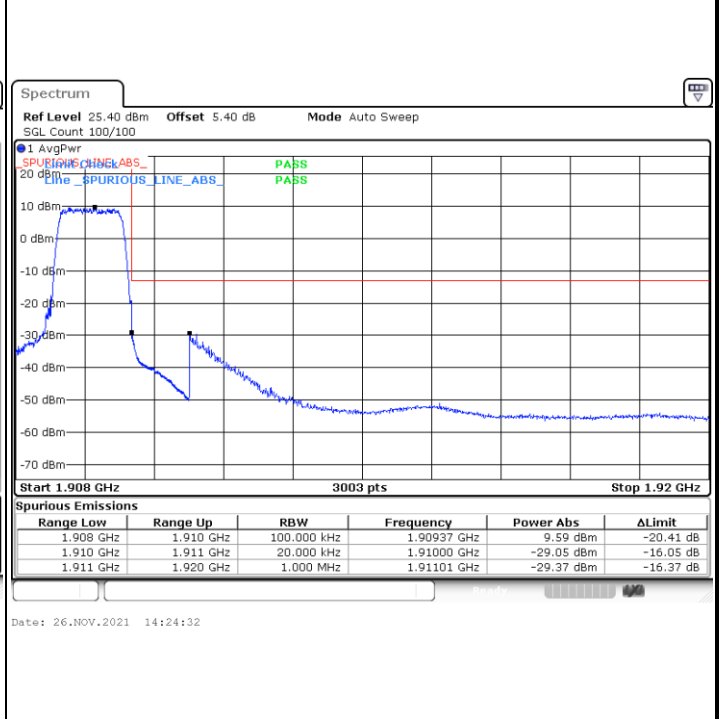



LTE Band 2 / 3MHz / QPSK

Lowest Band Edge / 1RB

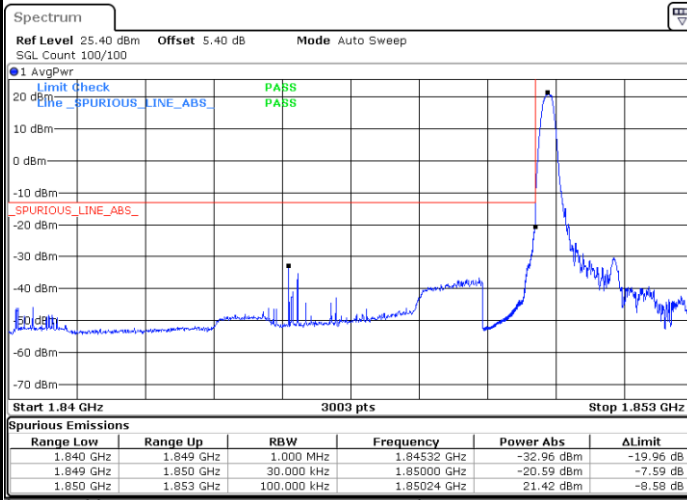

Date: 24.NOV.2021 22:07:20

Highest Band Edge / 1 RB

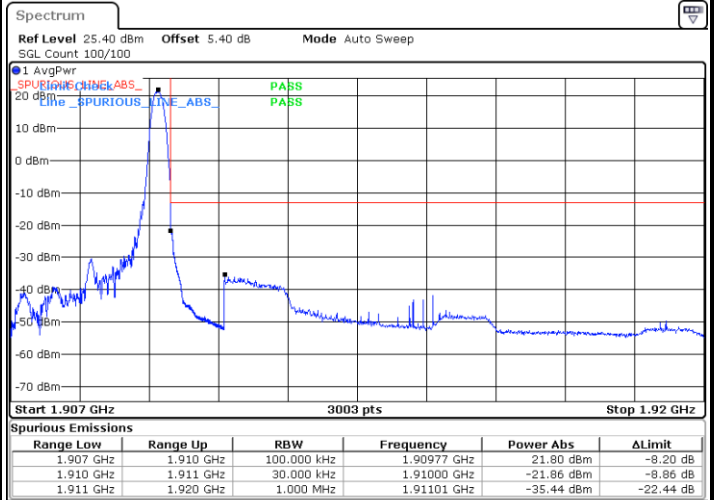

Date: 24.NOV.2021 22:12:57

Lowest Band Edge / Full RB

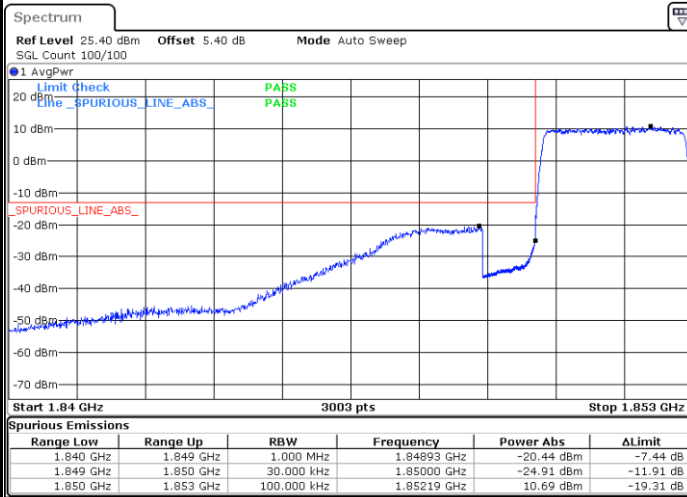

Date: 24.NOV.2021 22:10:08

Highest Band Edge / Full RB

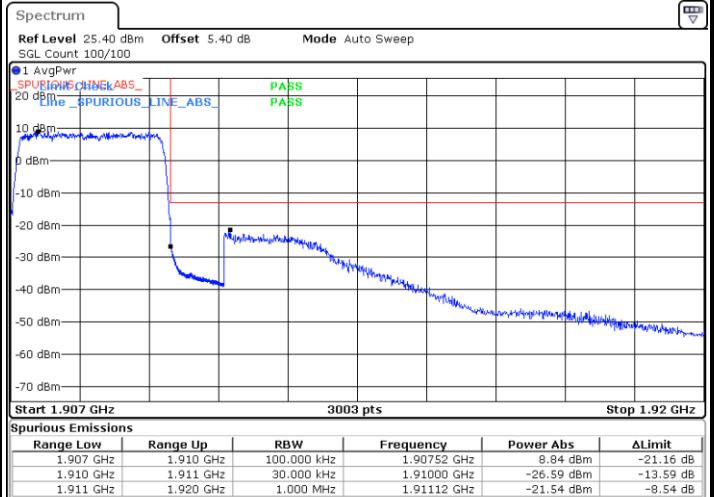

Date: 24.NOV.2021 22:17:29



LTE Band 2 / 3MHz / 16QAM

Lowest Band Edge / 1 RB

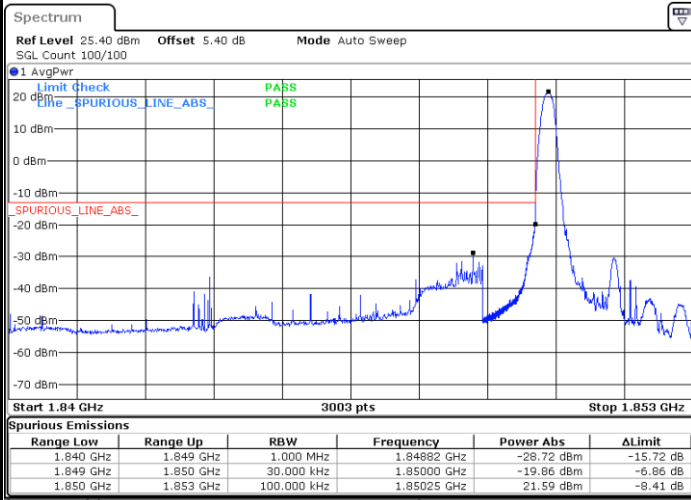

Date: 24.NOV.2021 22:08:44

Highest Band Edge / 1 RB

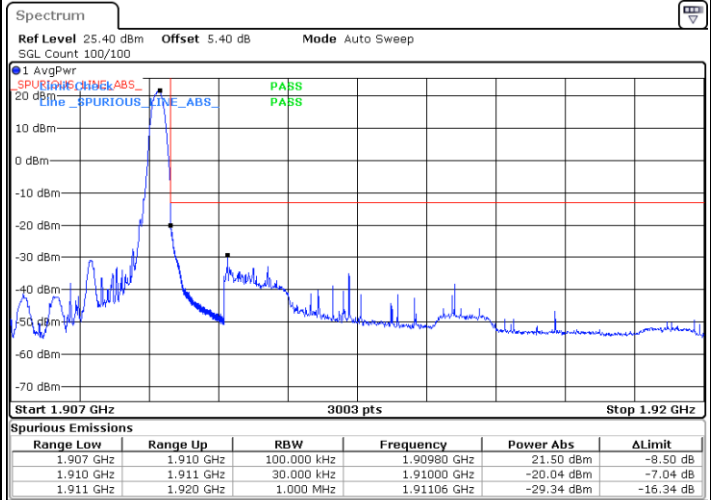

Date: 24.NOV.2021 22:14:21

Lowest Band Edge / Full RB

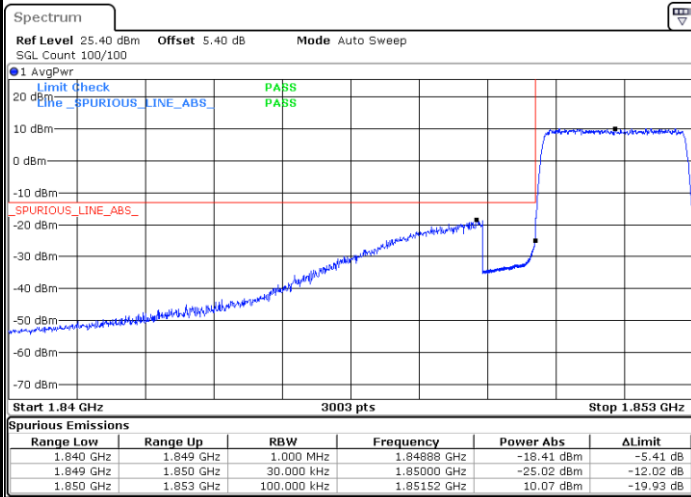

Date: 24.NOV.2021 22:11:32

Highest Band Edge / Full RB

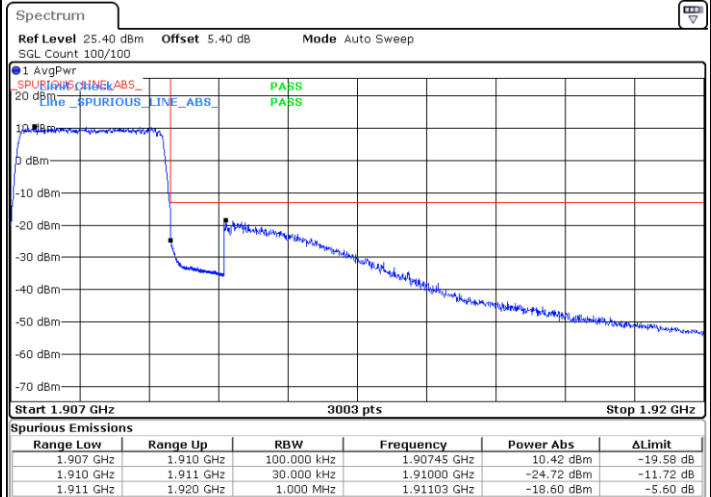

Date: 24.NOV.2021 22:19:33



LTE Band 2 / 3MHz / 64QAM

Lowest Band Edge / 1 RB

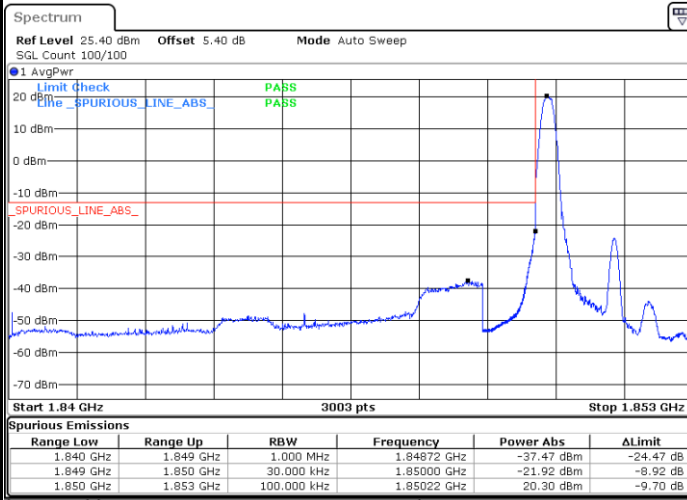

Date: 27.NOV.2021 14:22:44

Highest Band Edge / 1 RB

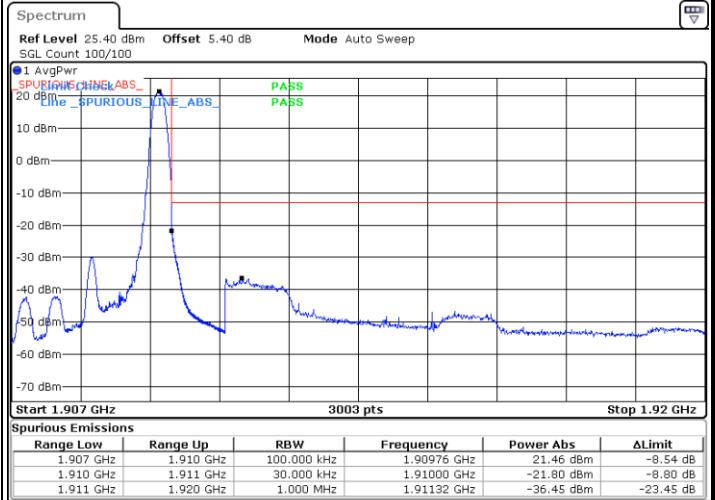

Date: 25.NOV.2021 00:54:15

Lowest Band Edge / Full RB

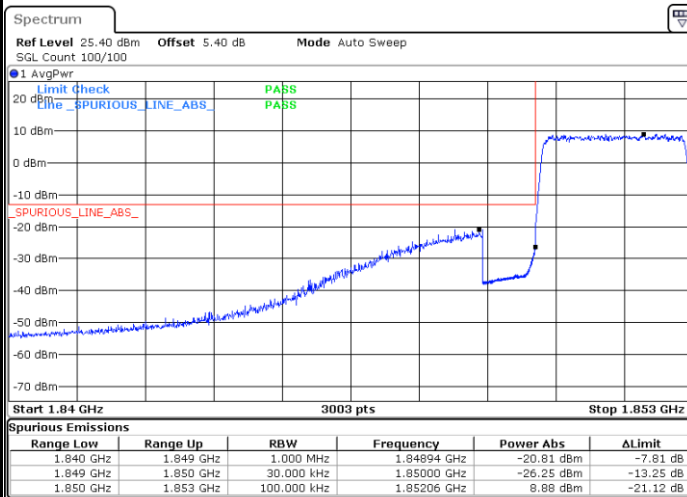

Date: 25.NOV.2021 00:17:39

Highest Band Edge / Full RB

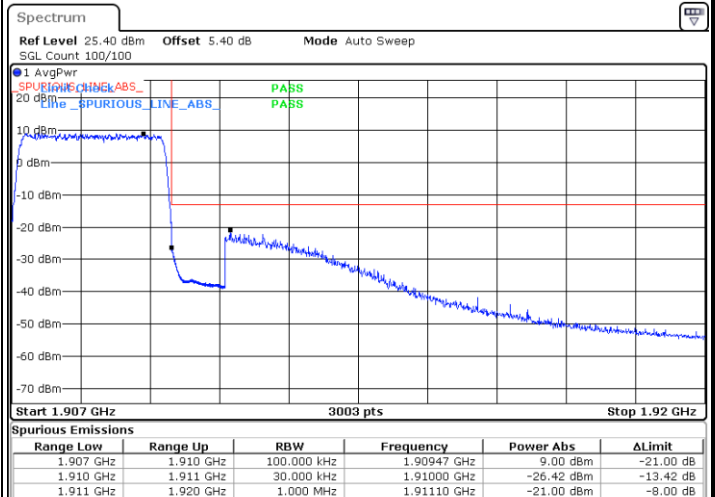

Date: 25.NOV.2021 00:20:27



LTE Band 2 / 3MHz / 256QAM

Lowest Band Edge / 1 RB

Highest Band Edge / 1 RB

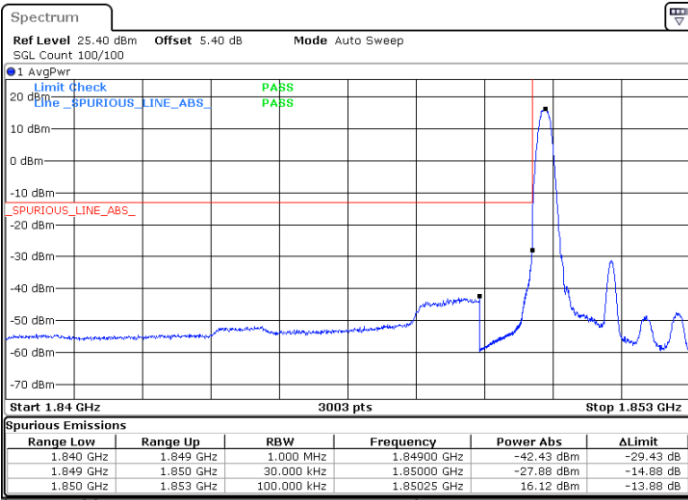

Date: 26.NOV.2021 16:04:21

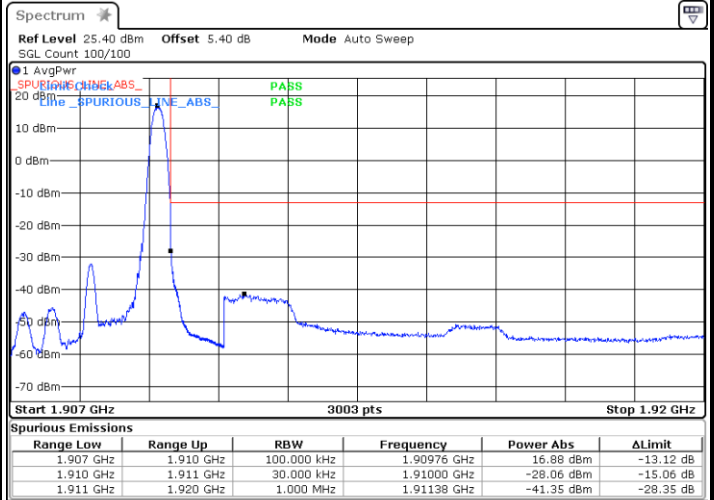

Date: 26.NOV.2021 16:24:09

Lowest Band Edge / Full RB

Highest Band Edge / Full RB

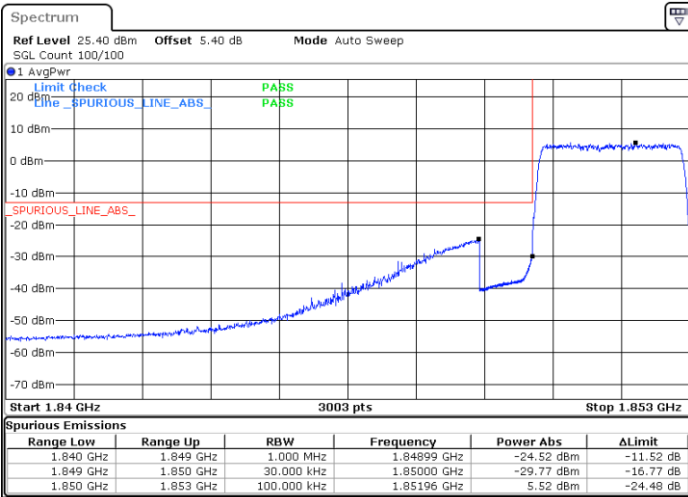

Date: 26.NOV.2021 16:05:19

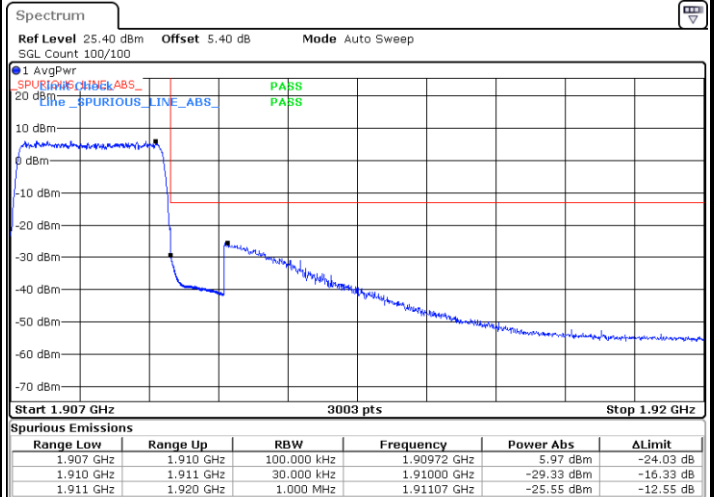

Date: 26.NOV.2021 16:21:39



LTE Band 2 / 5MHz / QPSK

Lowest Band Edge / 1 RB

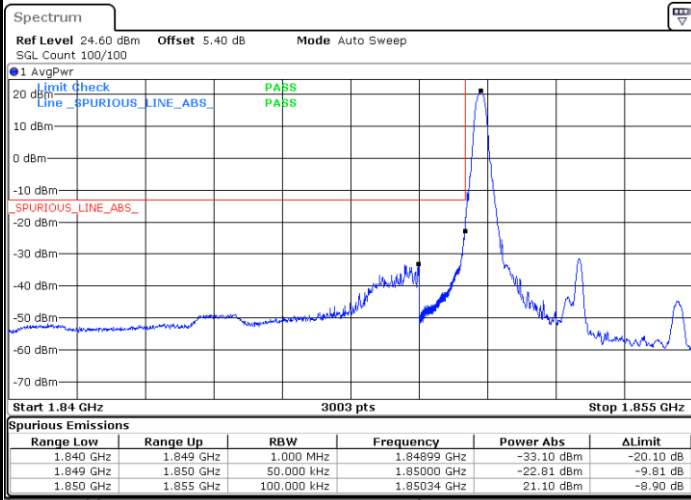

Date: 24.NOV.2021 22:20:58

Highest Band Edge / 1 RB

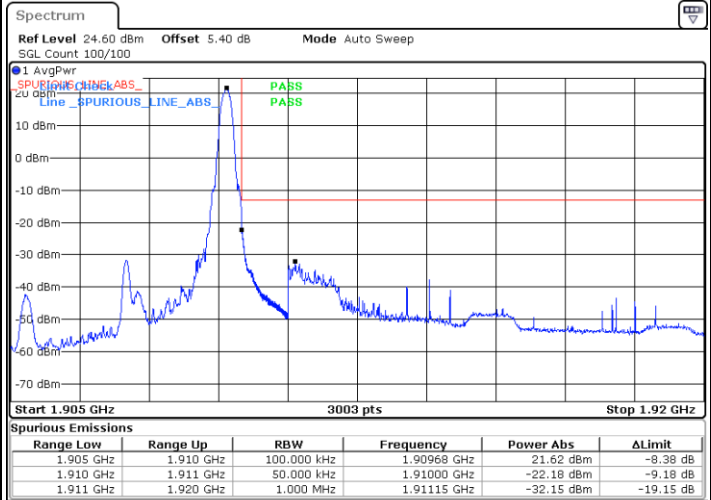

Date: 24.NOV.2021 22:26:37

Lowest Band Edge / Full RB

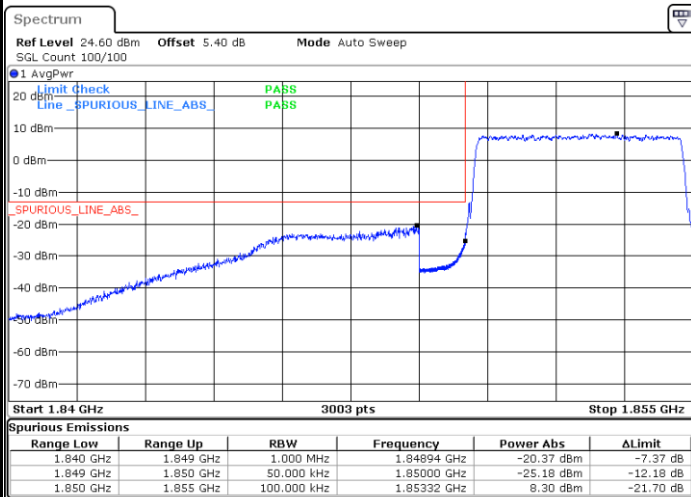

Date: 24.NOV.2021 22:23:48

Highest Band Edge / Full RB

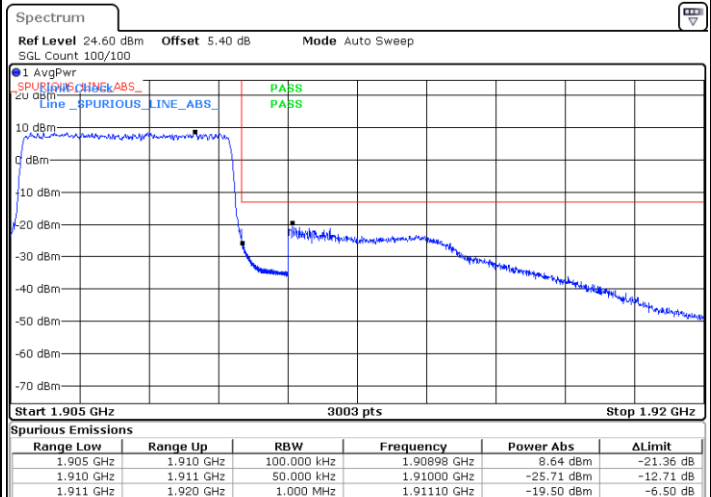

Date: 24.NOV.2021 22:29:25



LTE Band 2 / 5MHz / 16QAM

Lowest Band Edge / 1RB

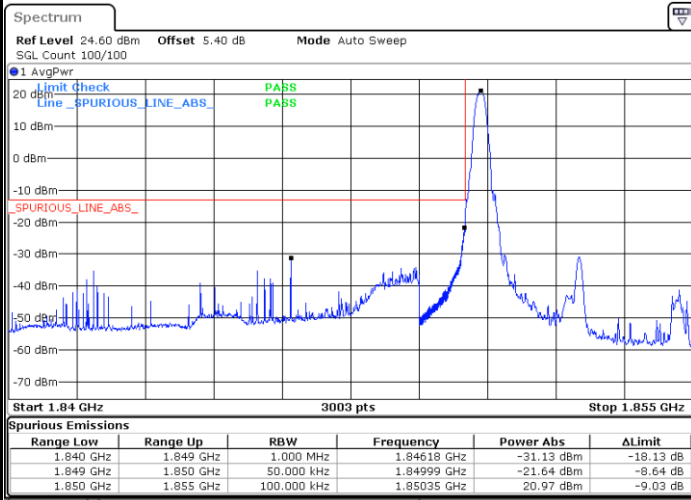

Date: 24.NOV.2021 22:22:23

Highest Band Edge / 1 RB

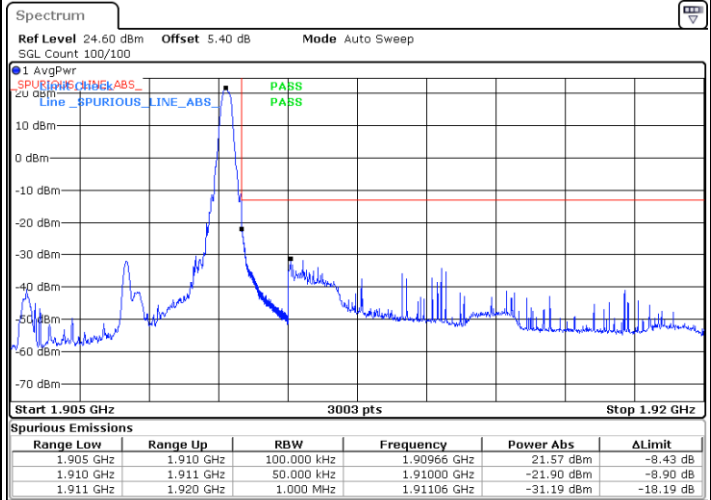

Date: 25.NOV.2021 00:55:56

Lowest Band Edge / Full RB

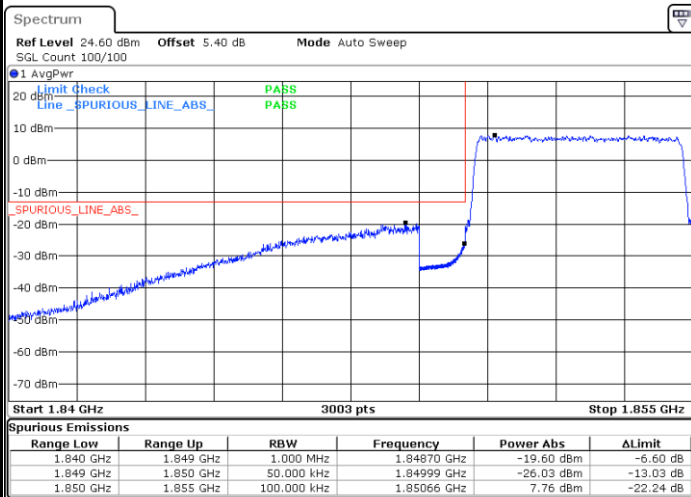

Date: 24.NOV.2021 22:25:12

Highest Band Edge / Full RB

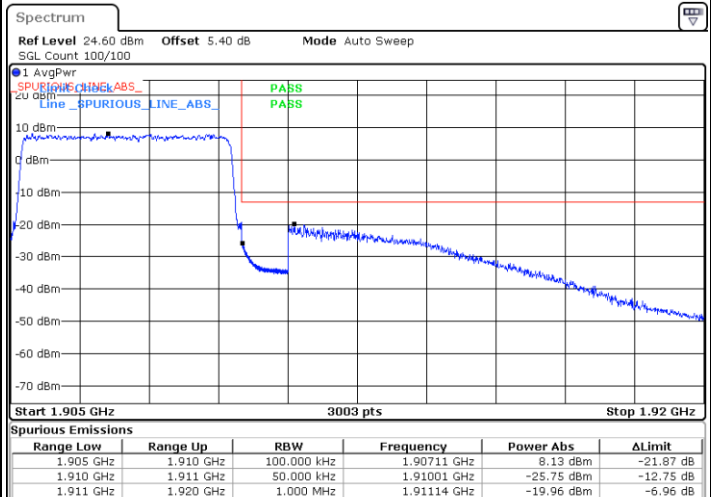

Date: 24.NOV.2021 22:30:50



LTE Band 2 / 5MHz / 64QAM

Lowest Band Edge / 1RB

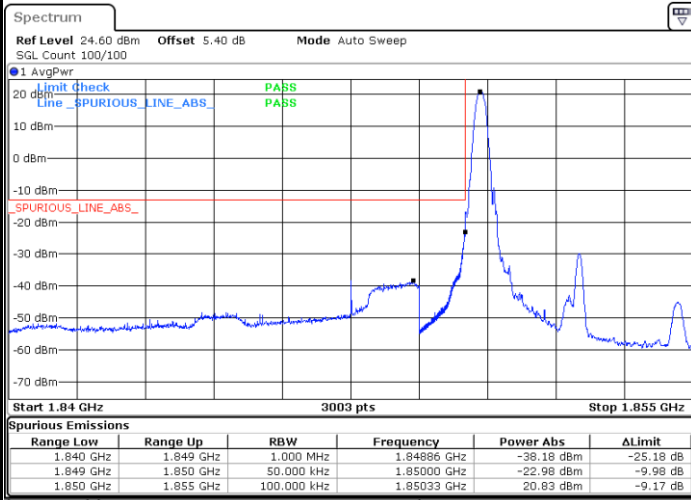

Date: 25.NOV.2021 00:21:51

Highest Band Edge / 1 RB

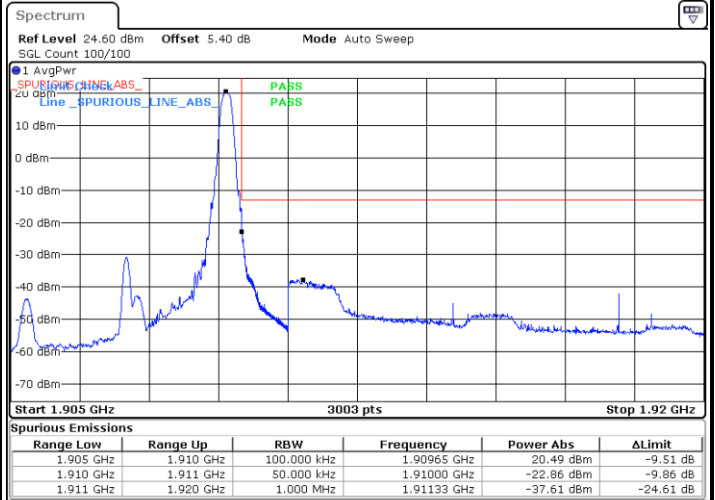

Date: 25.NOV.2021 00:24:39

Lowest Band Edge / Full RB

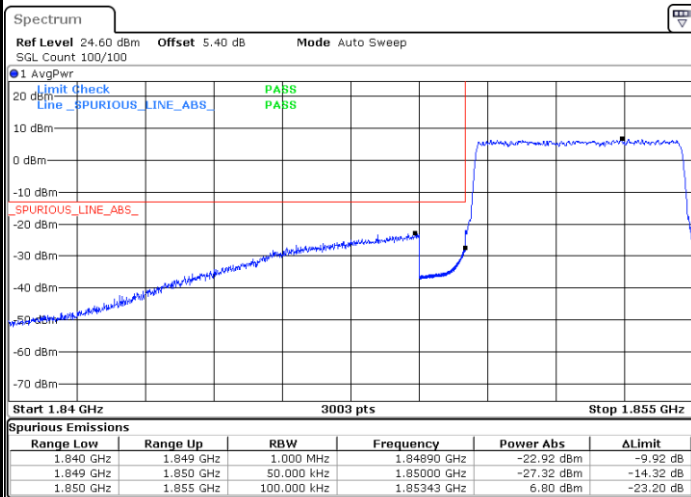

Date: 25.NOV.2021 00:23:15

Highest Band Edge / Full RB

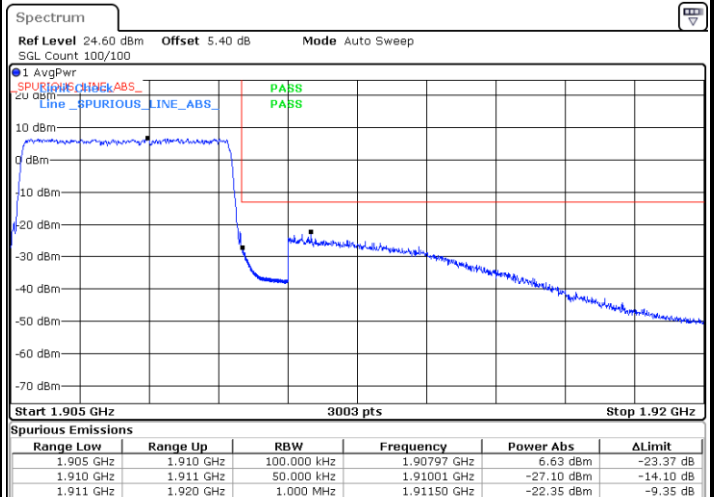

Date: 25.NOV.2021 00:26:03



LTE Band 2 / 5MHz / 256QAM

Lowest Band Edge / 1RB

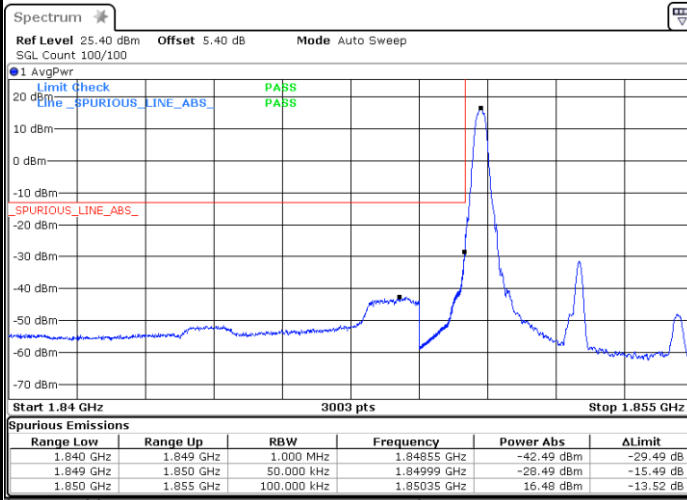

Date: 26.NOV.2021 16:25:34

Highest Band Edge / 1 RB

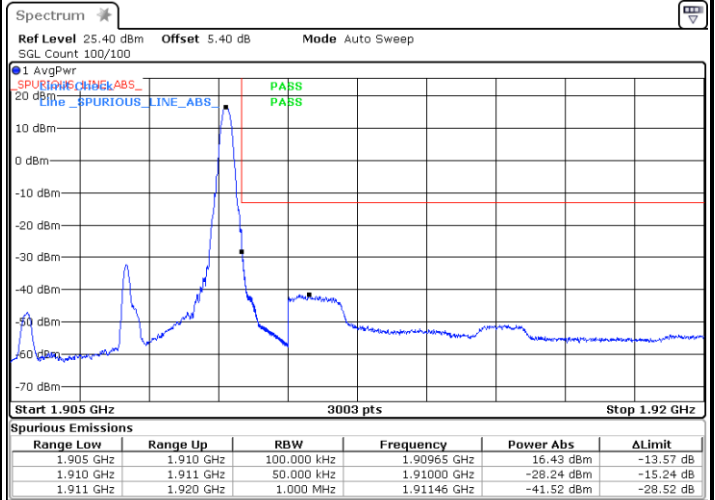

Date: 26.NOV.2021 16:29:29

Lowest Band Edge / Full RB

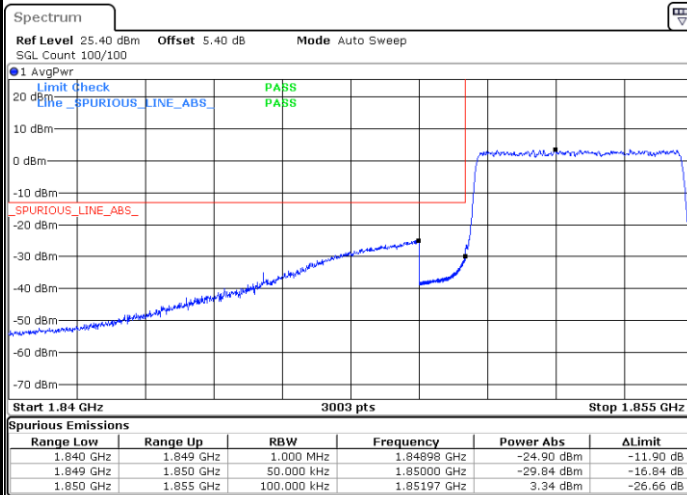

Date: 26.NOV.2021 16:26:16

Highest Band Edge / Full RB

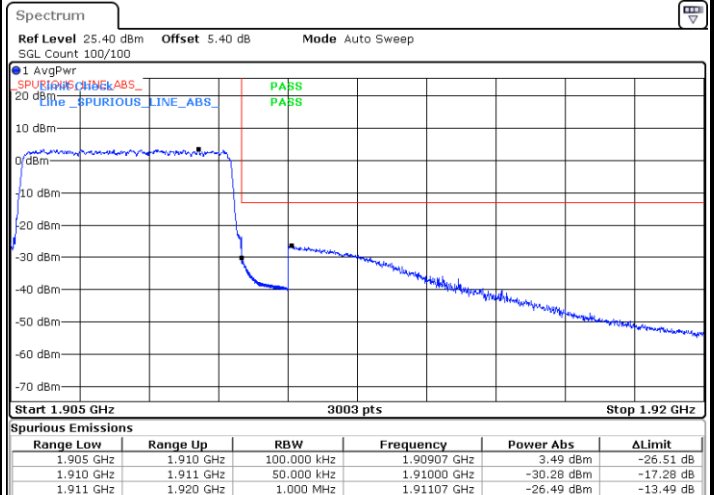

Date: 26.NOV.2021 16:28:03



LTE Band 2 / 10MHz / QPSK

Lowest Band Edge / 1 RB

Highest Band Edge / 1 RB

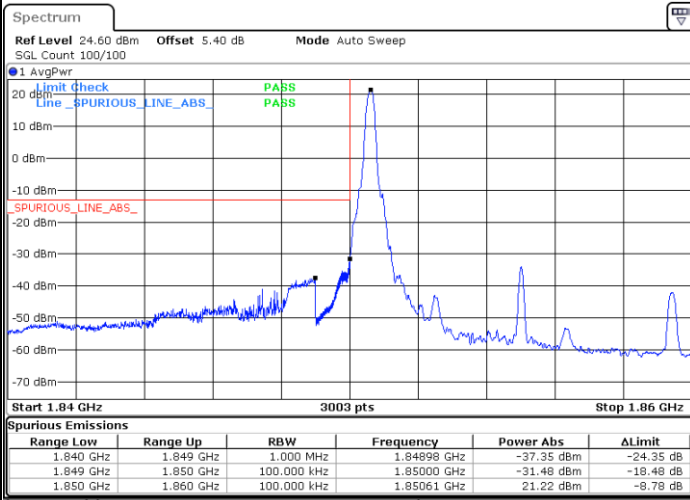

Date: 24.NOV.2021 22:32:15

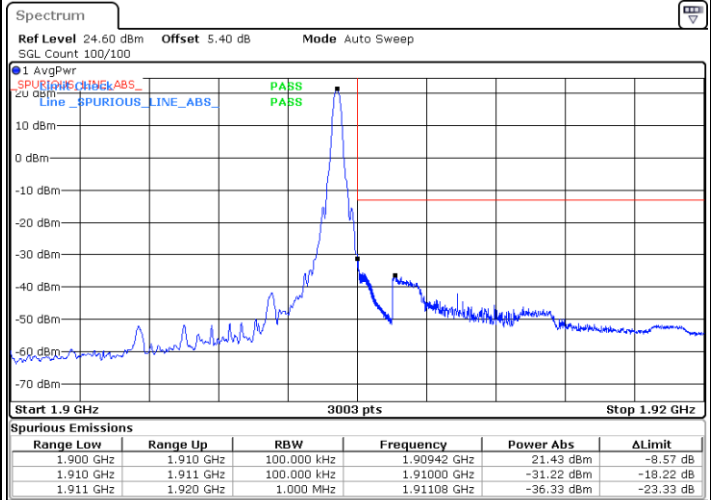

Date: 24.NOV.2021 22:37:53

Lowest Band Edge / Full RB

Highest Band Edge / Full RB

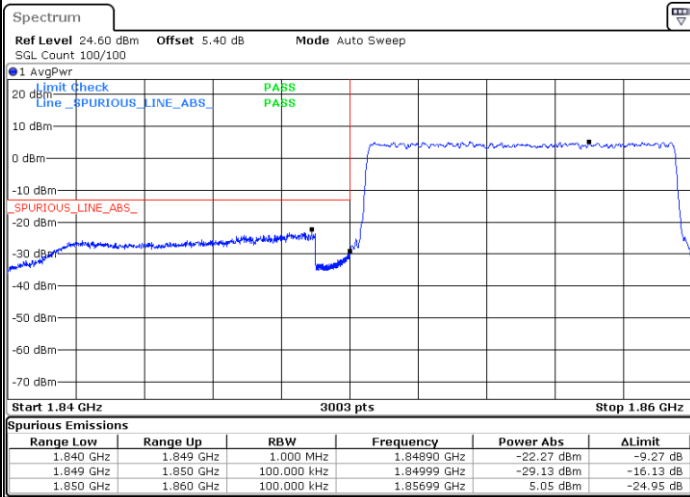

Date: 24.NOV.2021 22:35:04

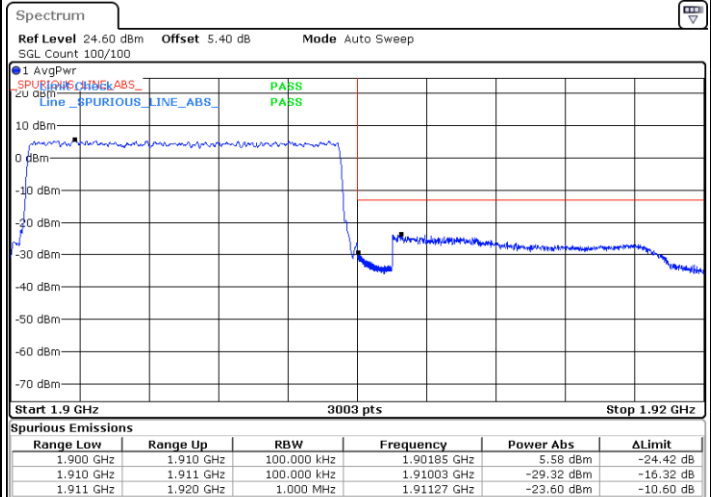

Date: 24.NOV.2021 22:40:43



LTE Band 2 / 10MHz / 16QAM

Lowest Band Edge / 1 RB

Highest Band Edge / 1 RB

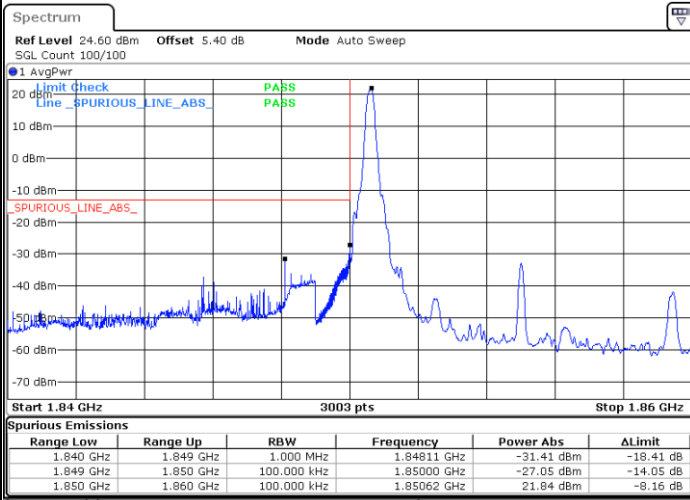

Date: 24.NOV.2021 22:33:39

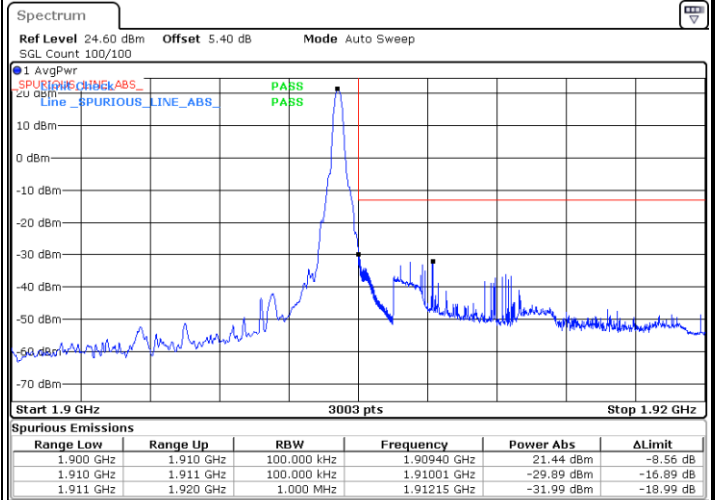

Date: 24.NOV.2021 22:39:18

Lowest Band Edge / Full RB

Highest Band Edge / Full RB

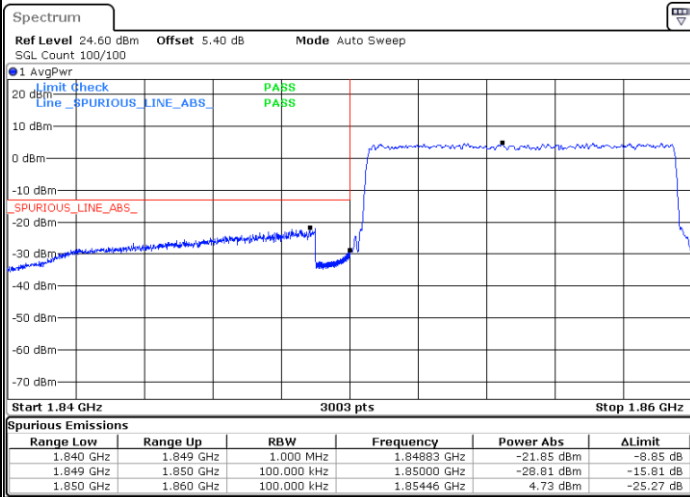

Date: 24.NOV.2021 22:36:28

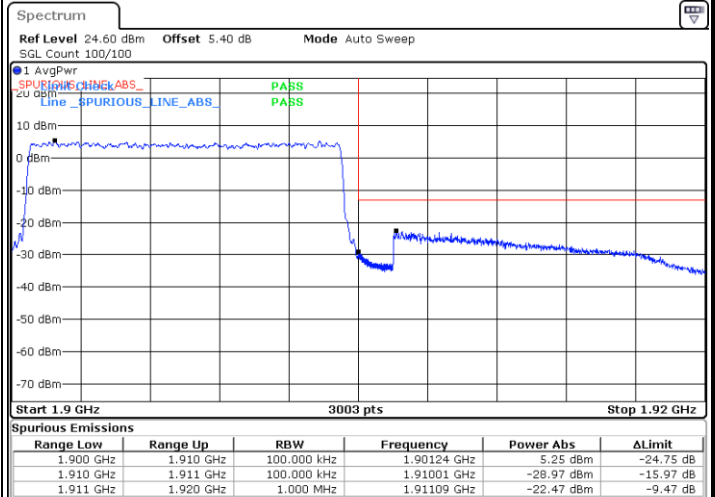

Date: 24.NOV.2021 22:42:07



LTE Band 2 / 10MHz / 64QAM

Lowest Band Edge / 1 RB

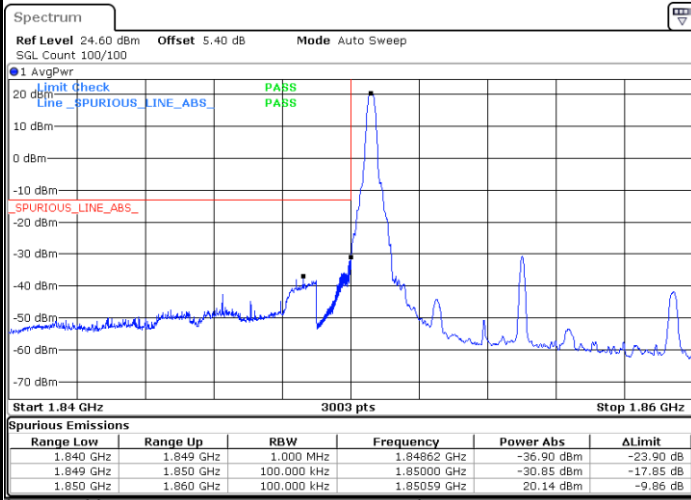

Date: 25.NOV.2021 00:27:27

Highest Band Edge / 1 RB

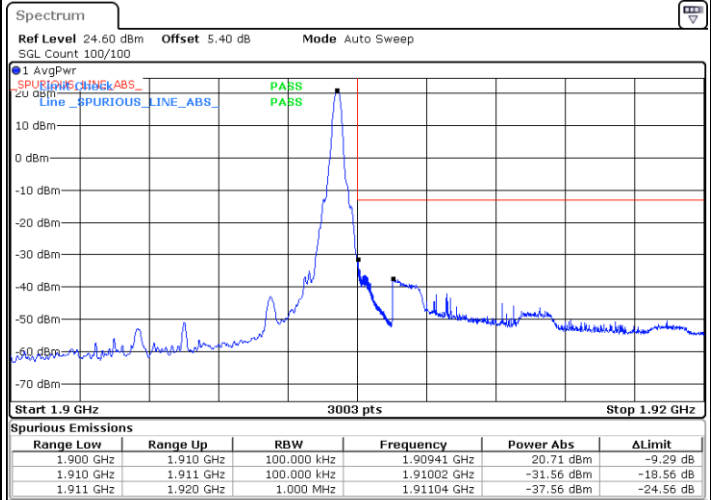

Date: 25.NOV.2021 00:30:15

Lowest Band Edge / Full RB

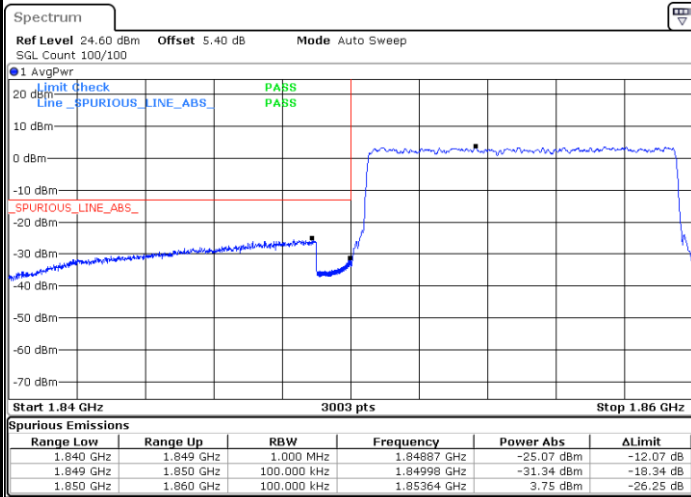

Date: 25.NOV.2021 00:28:52

Highest Band Edge / Full RB

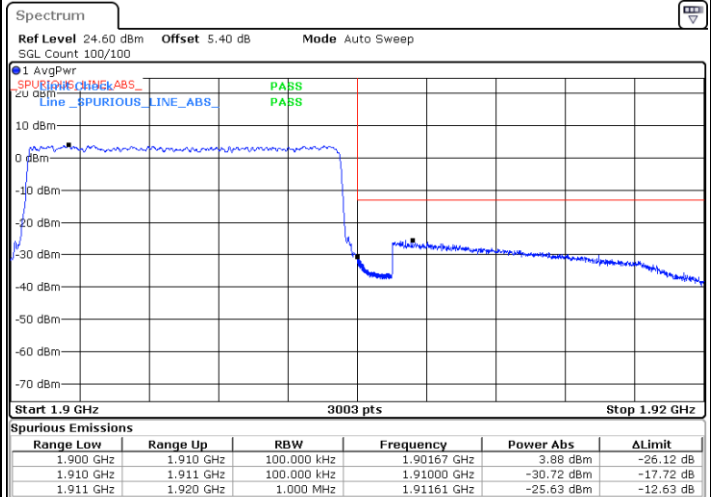

Date: 25.NOV.2021 00:31:39



LTE Band 2 / 10MHz / 256QAM

Lowest Band Edge / 1 RB

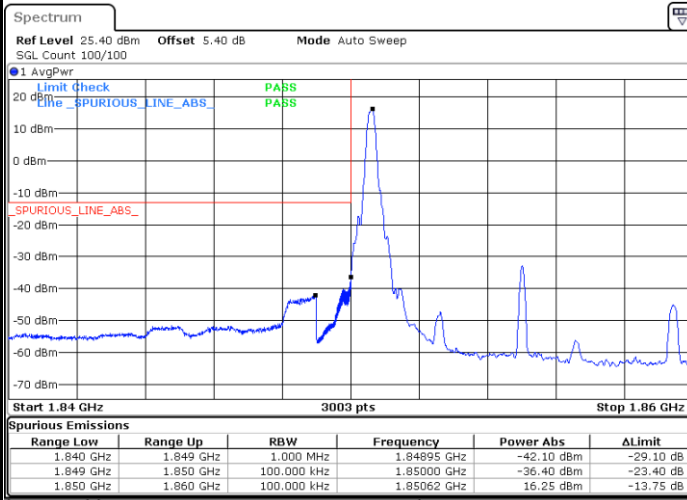

Date: 26.NOV.2021 16:31:30

Highest Band Edge / 1 RB

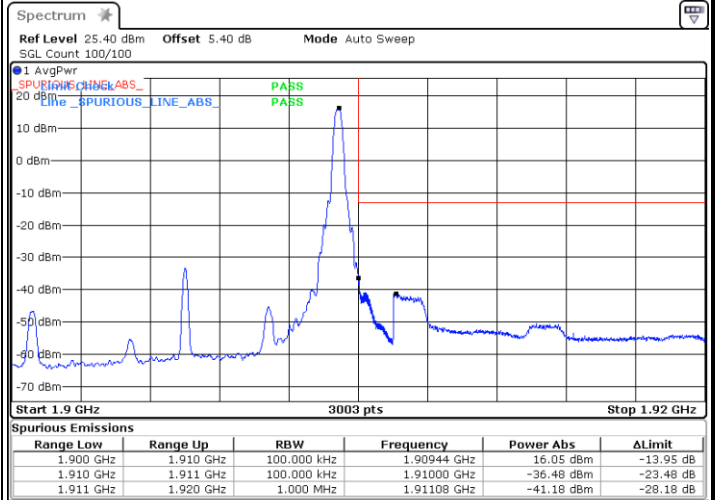

Date: 26.NOV.2021 16:35:32

Lowest Band Edge / Full RB

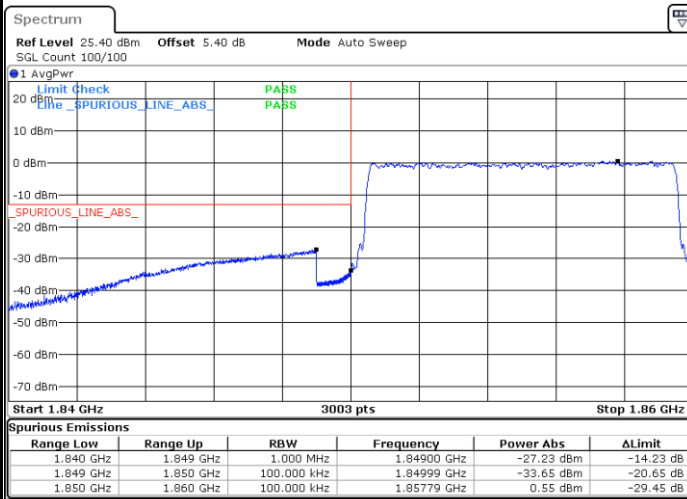

Date: 26.NOV.2021 16:32:42

Highest Band Edge / Full RB

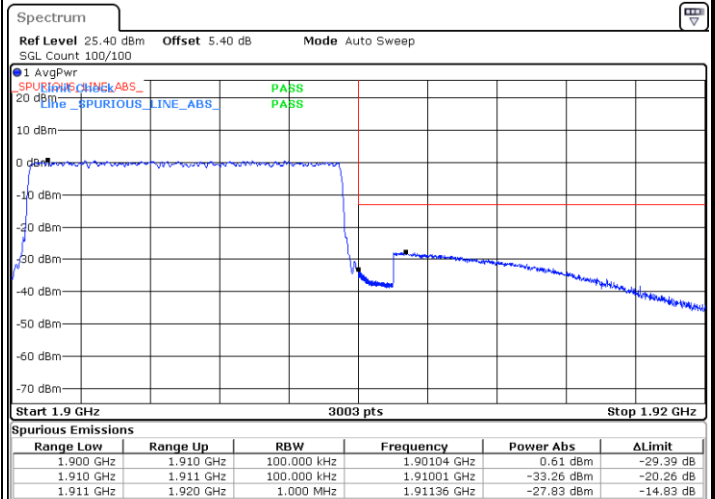

Date: 26.NOV.2021 16:33:23



LTE Band 2 / 15MHz / QPSK

Lowest Band Edge / 1 RB

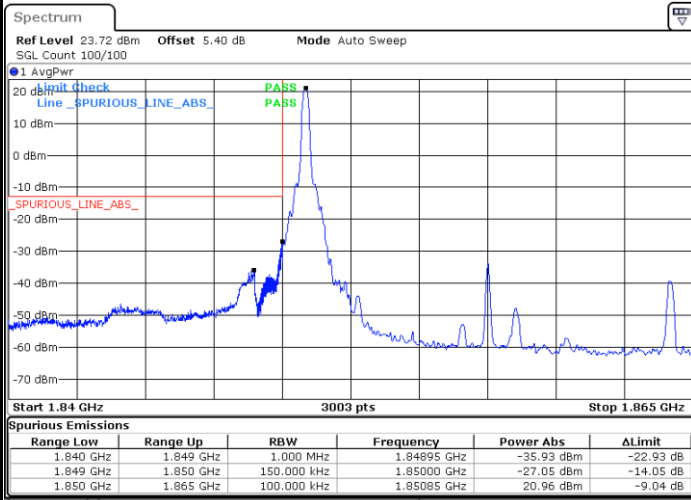

Date: 24.NOV.2021 22:43:32

Highest Band Edge / 1 RB

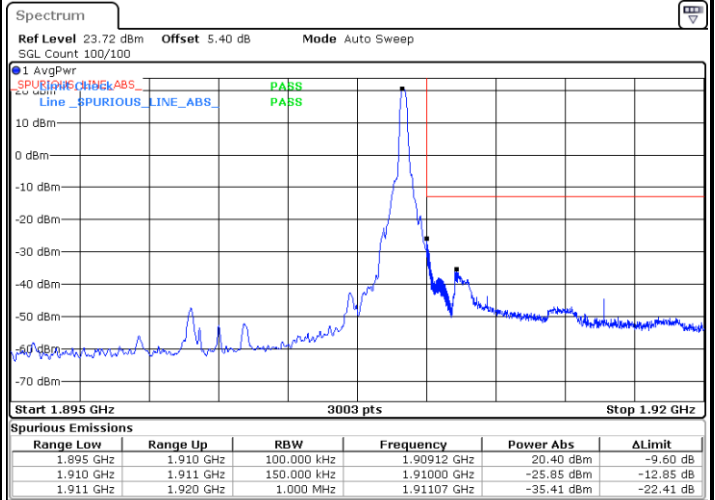

Date: 24.NOV.2021 22:49:10

Lowest Band Edge / Full RB

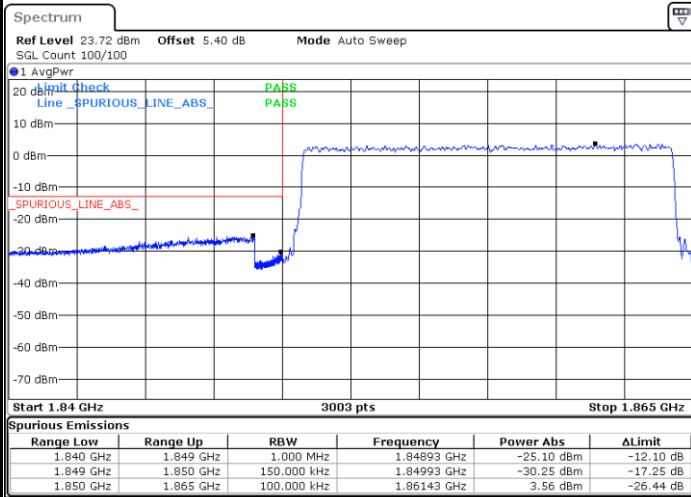

Date: 24.NOV.2021 22:46:21

Highest Band Edge / Full RB

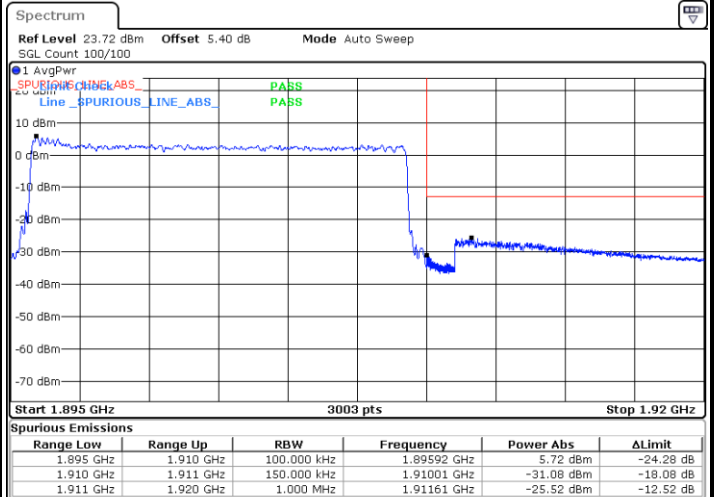

Date: 24.NOV.2021 22:51:59



LTE Band 2 / 15MHz / 16QAM

Lowest Band Edge / 1 RB

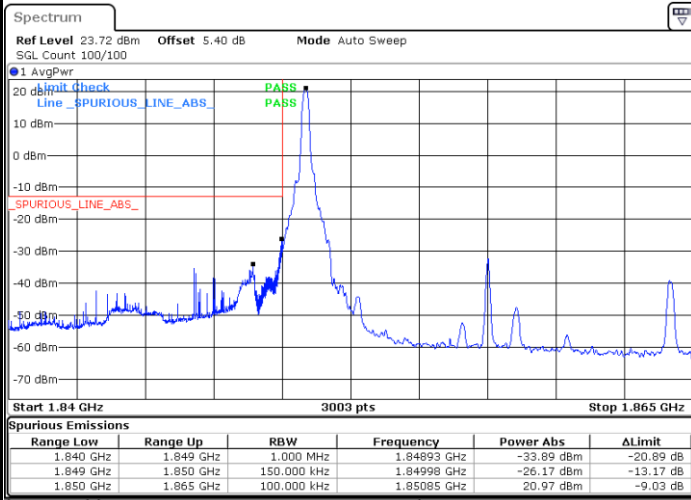

Date: 24.NOV.2021 22:44:56

Highest Band Edge / 1 RB

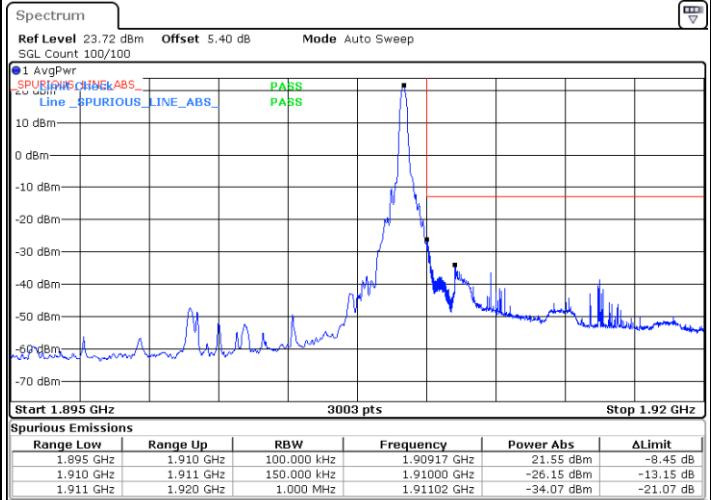

Date: 24.NOV.2021 22:50:34

Lowest Band Edge / Full RB

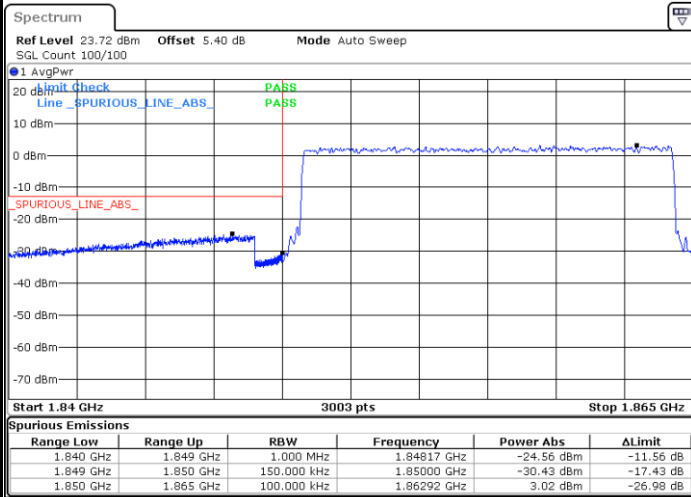

Date: 24.NOV.2021 22:47:45

Highest Band Edge / Full RB

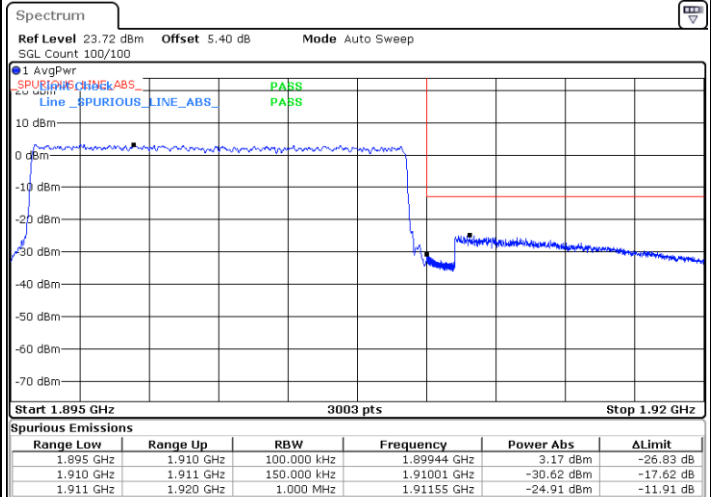

Date: 24.NOV.2021 22:53:23



LTE Band 2 / 15MHz / 64QAM

Lowest Band Edge / 1 RB

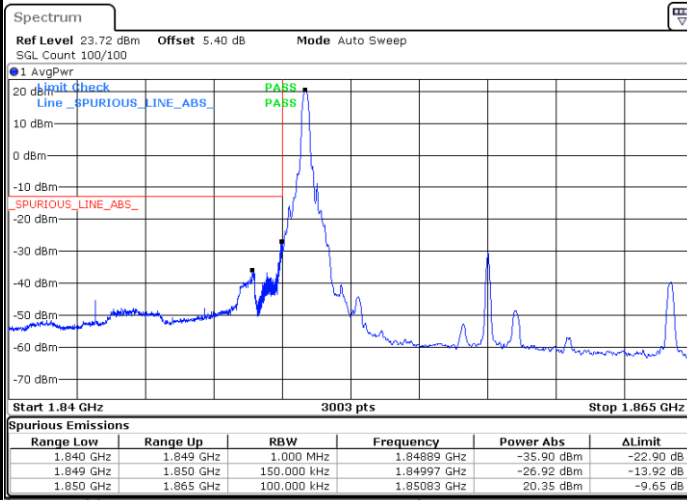

Date: 25.NOV.2021 00:33:04

Highest Band Edge / 1 RB

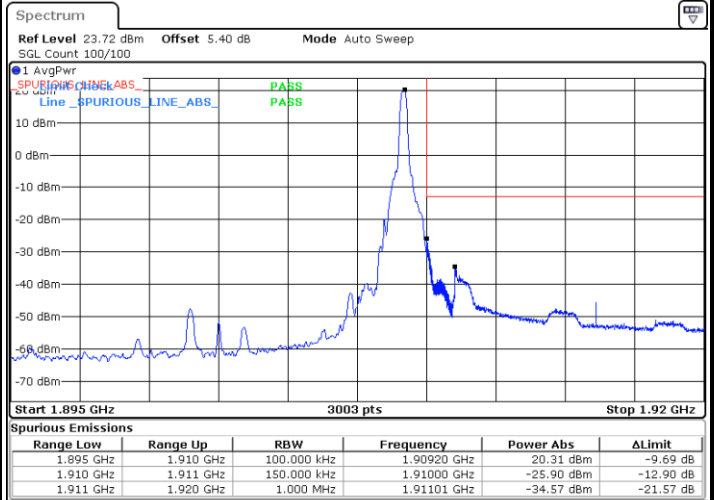

Date: 25.NOV.2021 00:35:52

Lowest Band Edge / Full RB

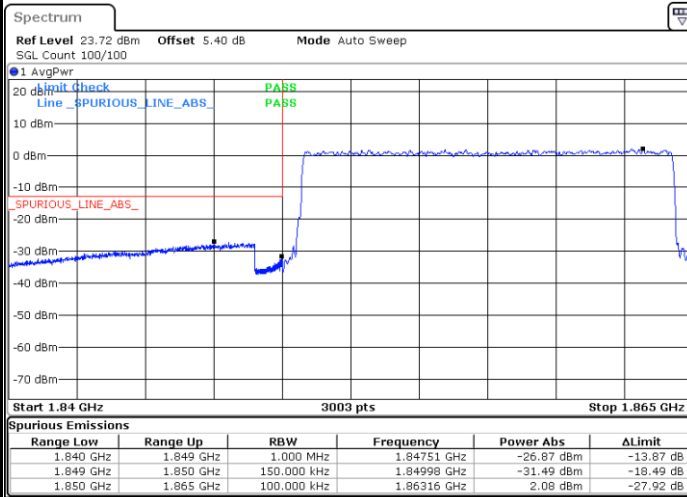

Date: 25.NOV.2021 00:34:29

Highest Band Edge / Full RB

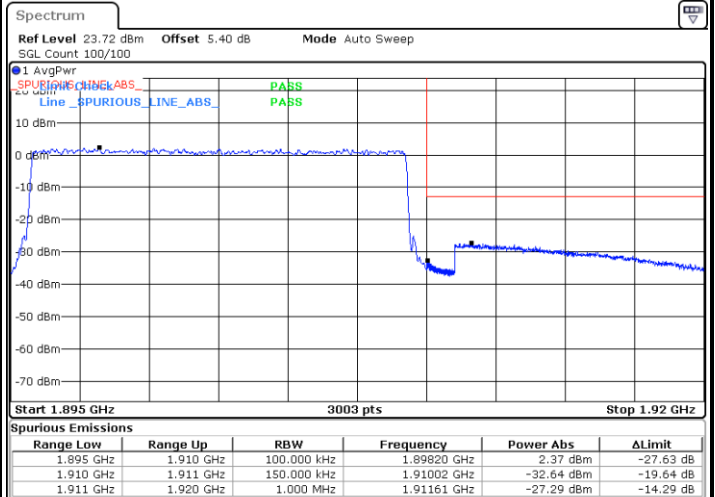

Date: 25.NOV.2021 00:37:16