



FCC RF Test Report

APPLICANT : Motorola Mobility LLC
EQUIPMENT : Mobile Cellular Phone
BRAND NAME : Motorola
MODEL NAME : XT2201-1
FCC ID : IHDT56AB1
STANDARD : 47 CFR Part 2, 22(H), 24(E), 27(L), 27(F), 27(H)
CLASSIFICATION : PCS Licensed Transmitter Held to Ear (PCE)
TEST DATE(S) : Oct. 29, 2021 ~ Nov. 15, 2021

We, Sporton International (Kunshan) Inc., would like to declare that the tested sample has been evaluated in accordance with the procedures given in ANSI C63.26-2015 and shown compliance with the applicable technical standards.

The test results in this report apply exclusively to the tested model / sample. Without written approval of Sporton International (Kunshan) Inc., the test report shall not be reproduced except in full.

Reviewed by: Jason Jia / Supervisor

Approved by: Alex Wang / Manager



Sporton International (Kunshan) Inc.

**No. 1098, Pengxi North Road, Kunshan Economic Development Zone Jiangsu Province 215300
People's Republic of China**



TABLE OF CONTENTS

REVISION HISTORY... 3
SUMMARY OF TEST RESULT ... 4
1 GENERAL DESCRIPTION ... 6
1.1 Applicant ... 6
1.2 Manufacturer ... 6
1.3 Product Feature of Equipment Under Test ... 6
1.4 Product Specification of Equipment Under Test ... 6
1.5 Specification of Accessory ... 8
1.6 Modification of EUT ... 8
1.7 Maximum ERP/EIRP Power and Emission Designator ... 8
1.8 Testing Location ... 10
1.9 Test Software ... 10
1.10 Applicable Standards ... 10
2 TEST CONFIGURATION OF EQUIPMENT UNDER TEST ... 11
2.1 Test Mode ... 11
2.2 Connection Diagram of Test System ... 13
2.3 Support Unit used in test configuration and system ... 14
2.4 Measurement Results Explanation Example ... 14
2.5 Frequency List of Low/Middle/High Channels ... 15
3 CONDUCTED TEST ITEMS ... 19
3.1 Measuring Instruments ... 19
3.2 Test Setup ... 19
3.3 Test Result of Conducted Test ... 19
3.4 Conducted Output Power and ERP/EIRP ... 20
3.5 Peak-to-Average Ratio ... 21
3.6 Occupied Bandwidth ... 22
3.7 Conducted Band Edge ... 23
3.8 Conducted Spurious Emission ... 25
3.9 Frequency Stability ... 26
4 RADIATED TEST ITEMS ... 27
4.1 Measuring Instruments ... 27
4.2 Test Setup ... 27
4.3 Test Result of Radiated Test ... 28
4.4 Radiated Spurious Emission ... 29
5 LIST OF MEASURING EQUIPMENT ... 30
6 UNCERTAINTY OF EVALUATION ... 31
APPENDIX A. TEST RESULTS OF CONDUCTED TEST
APPENDIX B. TEST RESULTS OF RADIATED TEST
APPENDIX C. TEST SETUP PHOTOGRAPHS



SUMMARY OF TEST RESULT

Report Section	FCC Rule	Description	Limit	Result	Remark
3.4	§2.1046	Conducted Output Power	-	Report Only	-
	§22.913(a)(5)	Effective Radiated Power (Band 5) (Band 26)	ERP < 7 Watt	PASS	-
	§27.50(b)(10) §27.50(c)(10)	Effective Radiated Power (Band 12) (Band 13) (Band 17)	ERP < 3 Watt		-
	§24.232(c)	Equivalent Isotropic Radiated Power (Band 2) (Band 25)	EIRP < 2Watt		-
	§27.50(d)(4)	Equivalent Isotropic Radiated Power (Band 4) (Band 66)	EIRP < 1Watt		-
3.5	§24.232(d)	Peak-to-Average Ratio	<13 dB	PASS	-
3.6	§2.1049	Occupied Bandwidth	-	Report Only	-
3.7	§2.1051 §22.917(a) §24.238(a) §27.53(c)(2)(4) §27.53(g) §27.53(h)	Conducted Band Edge Measurement (Band 2) (Band 4) (Band 5) (Band 12) (Band 13) (Band 17) (Band 25) (Band 26) (Band 66)	< 43+10log10(P[Watts])	PASS	-
3.8	§2.1051 §22.917(a) §24.238(a) §27.53(c)(2) §27.53(g) §27.53(h)	Conducted Spurious Emission (Band 2) (Band 4) (Band 5) (Band 12) (Band 13) (Band 17) (Band 25) (Band 26) (Band 66)	< 43+10log10(P[Watts])	PASS	-
3.9	§2.1055 §22.355	Frequency Stability Temperature & Voltage	< 2.5 ppm for Part 22	PASS	-
	§2.1055 §24.235 §27.54		Within Authorized Band		



Report Section	FCC Rule	Description	Limit	Result	Remark
4.4	§2.1053 §22.917(a) §24.238(a) §27.53(c)(2) §27.53(f) §27.53(g) §27.53(h)	Radiated Spurious Emission (Band 2) (Band 4) (Band 5) (Band 12) (Band 13) (Band 17) (Band 25) (Band 26) (Band 66)	$< 43+10\log_{10}(P[\text{Watts}])$	PASS	Under limit 20.08 dB at 1560.00 MHz

Declaration of Conformity:

The test results with all measurement uncertainty excluded are presented in accordance with the regulation limits or requirements declared by manufacturers.

Comments and Explanations:

The declared of product specification for EUT presented in the report are provided by the manufacturer, and the manufacturer takes all the responsibilities for the accuracy of product specification.



1 General Description

1.1 Applicant

Motorola Mobility LLC
222 W,Merchandise Mart Plaza, Chicago IL 60654 USA

1.2 Manufacturer

Motorola Mobility LLC
222 W,Merchandise Mart Plaza, Chicago IL 60654 USA

1.3 Product Feature of Equipment Under Test

Product Feature	
Equipment	Mobile Cellular Phone
Brand Name	Motorola
Model Name	XT2201-1
FCC ID	IHDT56AB1
IMEI Code	Conducted: 355871980013291/355871980013309 Radiation: 355871980014315/355871980014323
HW Version	DVT2
SW Version	SSH32.79
EUT Stage	Identical Prototype

1.4 Product Specification of Equipment Under Test

Standards-related Product Specification	
Tx Frequency	LTE Band 2 : 1850 MHz ~ 1910 MHz LTE Band 4 : 1710 MHz ~ 1755 MHz LTE Band 5 : 824 MHz ~ 849 MHz LTE Band 12 : 699 MHz ~ 716 MHz LTE Band 13 : 777 MHz ~ 787 MHz LTE Band 17 : 704 MHz ~ 716 MHz LTE Band 25 : 1850 MHz ~ 1915 MHz LTE Band 26 : 824 MHz ~ 849 MHz LTE Band 66 : 1710 MHz ~ 1780 MHz
Rx Frequency	LTE Band 2 : 1930 MHz ~ 1990 MHz LTE Band 4 : 2110 MHz ~ 2155 MHz LTE Band 5 : 869 MHz ~ 894 MHz LTE Band 12 : 729 MHz ~ 746 MHz LTE Band 13 : 746 MHz ~ 756 MHz LTE Band 17 : 734 MHz ~ 746 MHz LTE Band 25 : 1930 MHz ~ 1995 MHz LTE Band 26 : 869 MHz ~ 894 MHz LTE Band 66 : 2110 MHz~ 2200 MHz
Bandwidth	LTE Band 2 : 1.4MHz / 3MHz / 5MHz / 10MHz / 15MHz / 20MHz LTE Band 4 : 1.4MHz / 3MHz / 5MHz / 10MHz / 15MHz / 20MHz LTE Band 5 : 1.4MHz / 3MHz / 5MHz / 10MHz



	LTE Band 12 : 1.4MHz / 3MHz / 5MHz / 10MHz LTE Band 13 : 5MHz / 10MHz LTE Band 17 : 5MHz / 10MHz LTE Band 25 : 1.4MHz / 3MHz / 5MHz / 10MHz / 15MHz / 20MHz LTE Band 26 : 1.4MHz / 3MHz / 5MHz / 10MHz / 15MHz LTE Band 66 : 1.4MHz / 3MHz / 5MHz / 10MHz / 15MHz / 20MHz
Maximum Output Power to Antenna	Ant. 0: LTE Band 2 : 22.82 dBm LTE Band 4 : 23.12 dBm LTE Band 5 : 22.86 dBm LTE Band 12 : 22.93 dBm LTE Band 13 : 23.22 dBm LTE Band 17 : 22.88 dBm LTE Band 25 : 22.89 dBm LTE Band 26 : 22.61 dBm LTE Band 66 : 23.15 dBm Ant. 1: LTE Band 2 : 22.87 dBm LTE Band 4 : 22.02 dBm LTE Band 5 : 22.35 dBm LTE Band 12 : 22.67 dBm LTE Band 13 : 22.48 dBm LTE Band 17 : 22.59 dBm LTE Band 25 : 23.28 dBm LTE Band 26 : 22.41 dBm LTE Band 66 : 22.05 dBm
Antenna Gain	Ant. 0: LTE Band 2 : -0.5 dBi LTE Band 4 : -0.5 dBi LTE Band 5 : -3.5 dBi LTE Band 12 : -3.5 dBi LTE Band 13 : -3.8 dBi LTE Band 17 : -3.5 dBi LTE Band 25 : -0.5 dBi LTE Band 26 : -3.5 dBi LTE Band 66 : -0.5 dBi Ant. 1: LTE Band 2 : -1.5 dBi LTE Band 4 : -2.3 dBi LTE Band 5 : -4.8 dBi LTE Band 12 : -4.5 dBi LTE Band 13 : -4.4 dBi LTE Band 17 : -4.5 dBi LTE Band 25 : -1.5 dBi LTE Band 26 : -4.8 dBi LTE Band 66 : -2.3 dBi
Type of Modulation	QPSK / 16QAM / 64QAM / 256QAM

Note: The maximum ERP/EIRP is calculated from max output power and antenna gain, only the maximum ERP/EIRP is shown in the report for Ant.0.





1.5 Specification of Accessory

Specification of Accessory				
AC Adapter 1(US)	Brand Name	Motorola(Salom)	Model Name	MC-681
AC Adapter 1(EU)	Brand Name	Motorola(Salom)	Model Name	MC-682
AC Adapter 1(UK)	Brand Name	Motorola(Salom)	Model Name	MC-683
AC Adapter 1(AR)	Brand Name	Motorola(Salom)	Model Name	MC-686
AC Adapter 1(BR)	Brand Name	Motorola(Salom)	Model Name	MC-687
AC Adapter 1(Chile)	Brand Name	Motorola(Salom)	Model Name	MC-689
AC Adapter 2(AU)	Brand Name	Motorola(Salom)	Model Name	MC-305
AC Adapter 3(AU)	Brand Name	Motorola(Acbel)	Model Name	MC-305
Battery	Brand Name	Motorola(ATL)	Model Name	NA50
Earphone	Brand Name	Motorola (Lyand)	Model Name	MD211(SH38D20195)
USB Cable 1	Brand Name	Motorola(Saibao)	Model Name	SC18D13215
USB Cable 2	Brand Name	Motorola(Cabletech)	Model Name	SC18D13216
USB Cable 3	Brand Name	Motorola(Luxshare)	Model Name	SC18D13217
USB Cable 4	Brand Name	Motorola(Saibao)	Model Name	SC18D24968
Type C to HDMI Cable /USBC Cable	Brand Name	Motorola(Linxee)	Model Name	SC18D02146
Stylus	Brand Name	Motorola smart stylus	Model Name	XT2201-S
Smart Folio	Brand Name	Motorola(Techson)	Model Name	SS68D36907,SS68D36906
Wireless Dongle	Brand Name	Motorola	Model Name	MD-02
HDMI Cable	Brand Name	Motorola	Model Name	HC-01
USB Cable(Type A/C)	Brand Name	Motorola	Model Name	SC18C24367

1.6 Modification of EUT

No modifications are made to the EUT during all test items.

1.7 Maximum ERP/EIRP Power and Emission Designator

LTE Band 2		QPSK		16QAM/64QAM/256QAM	
BW (MHz)	Frequency Range (MHz)	Maximum EIRP(W)	Emission Designator (99%OBW)	Maximum EIRP(W)	Emission Designator (99%OBW)
20	1860.0 ~ 1900.0	0.1706	17M9G7D	0.1694	17M9W7D
LTE Band 25		QPSK		16QAM/64QAM/256QAM	
BW (MHz)	Frequency Range (MHz)	Maximum EIRP(W)	Emission Designator (99%OBW)	Maximum EIRP(W)	Emission Designator (99%OBW)
20	1860.0 ~ 1905.0	0.1734	17M9G7D	0.1722	17M9W7D
LTE Band 4		QPSK		16QAM/64QAM/256QAM	
BW (MHz)	Frequency Range (MHz)	Maximum EIRP(W)	Emission Designator (99%OBW)	Maximum EIRP(W)	Emission Designator (99%OBW)
20	1720.0 ~ 1745.0	0.1828	18M4G7D	0.1782	18M5W7D



LTE Band 5		QPSK		16QAM/64QAM/256QAM	
BW (MHz)	Frequency Range (MHz)	Maximum ERP(W)	Emission Designator (99%OBW)	Maximum ERP(W)	Emission Designator (99%OBW)
10	829.0 ~ 844.0	0.0526	9M01G7D	0.0521	9M09W7D
LTE Band 12		QPSK		16QAM/64QAM/256QAM	
BW (MHz)	Frequency Range (MHz)	Maximum ERP(W)	Emission Designator (99%OBW)	Maximum ERP(W)	Emission Designator (99%OBW)
10	704.0 ~ 711.0	0.0535	9M05G7D	0.0533	9M01W7D
LTE Band 13		QPSK		16QAM/64QAM/256QAM	
BW (MHz)	Frequency Range (MHz)	Maximum ERP(W)	Emission Designator (99%OBW)	Maximum ERP(W)	Emission Designator (99%OBW)
10	782.0	0.0533	9M07G7D	0.0532	8M99W7D
LTE Band 17		QPSK		16QAM/64QAM/256QAM	
BW (MHz)	Frequency Range (MHz)	Maximum ERP(W)	Emission Designator (99%OBW)	Maximum ERP(W)	Emission Designator (99%OBW)
10	709.0 ~ 711.0	0.0528	9M05G7D	0.0527	9M01W7D
LTE Band 26		QPSK		16QAM/64QAM/256QAM	
BW (MHz)	Frequency Range (MHz)	Maximum ERP(W)	Emission Designator (99%OBW)	Maximum ERP(W)	Emission Designator (99%OBW)
15	831.5 ~ 841.5	0.0497	13M5G7D	0.0492	13M5W7D
CH26765	821.5	0.0489	13M4G7D	0.0482	13M5W7D
LTE Band 66		QPSK		16QAM/64QAM/256QAM	
BW (MHz)	Frequency Range (MHz)	Maximum EIRP(W)	Emission Designator (99%OBW)	Maximum EIRP(W)	Emission Designator (99%OBW)
20	1720.0 ~ 1770.0	0.1841	18M4G7D	0.1611	18M5W7D

Note:

1. LTE Band 66 overlaps the entire frequency range of LTE Band 4. Therefore, the test results provided in this report covers Band 66 as well as Band 4.
2. LTE Band 25 overlaps the entire frequency range of LTE Band 2. Therefore, the test results provided in this report covers Band 25 as well as Band 2.
3. LTE Band 12 overlaps the entire frequency range of LTE Band 17. Therefore, the test results provided in this report covers Band 12 as well as Band 17.
4. All modulations have been tested, and only the maximum bandwidth and the worst test results of PSK & QAM are shown in the report.



1.8 Testing Location

Sporton International (Kunshan) Inc. is accredited to ISO/IEC 17025:2017 by American Association for Laboratory Accreditation with Certificate Number 5145.02.

Test Firm	Sporton International (Kunshan) Inc.		
Test Site Location	No. 1098, Pengxi North Road, Kunshan Economic Development Zone Jiangsu Province 215300 People's Republic of China TEL : +86-512-57900158 FAX : +86-512-57900958		
Test Site No.	Sporton Site No.	FCC Designation No.	FCC Test Firm Registration No.
	CO01-KS 03CH04-KS TH01-KS	CN1257	314309

1.9 Test Software

Item	Site	Manufacture	Name	Version
1.	03CH04-KS	AUDIX	E3	6.2009-8-24a

1.10 Applicable Standards

According to the specifications of the manufacturer, the EUT must comply with the requirements of the following standards:

- ♦ 47 CFR Part 2, 22(H), 24(E), 27(L), 27(F), 27(H)
- ♦ ANSI C63.26-2015
- ♦ FCC KDB 971168 D01 Power Meas License Digital Systems v03r01
- ♦ FCC KDB 412172 D01 Determining ERP and EIRP v01r01

Remark:

1. All test items were verified and recorded according to the standards and without any deviation during the test.
2. This EUT has also been tested and complied with the requirements of FCC Part 15, Subpart B, recorded in a separate test report.



2 Test Configuration of Equipment Under Test

2.1 Test Mode

Antenna port conducted and radiated test items listed below are performed according to KDB 971168 D01 Power Meas License Digital Systems v03r01 with maximum output power.

Radiated measurements are performed by rotating the EUT in three different orthogonal test planes to find the maximum emission.

Test Items	Band	Bandwidth (MHz)						Modulation				RB #			Test Channel		
		1.4	3	5	10	15	20	QPSK	16QAM	64QAM	256QAM	1	Half	Full	L	M	H
Max. Output Power	2	v	v	v	v	v	v	v	v	v	v	v	v	v	v	v	v
	4	v	v	v	v	v	v	v	v	v	v	v	v	v	v	v	v
	5	v	v	v	v	-	-	v	v	v	v	v	v	v	v	v	v
	12	v	v	v	v	-	-	v	v	v	v	v	v	v	v	v	v
	13	-	-	v	v	-	-	v	v	v	v	v	v	v	v	v	v
	17	-	-	v	v	-	-	v	v	v	v	v	v	v	v	v	v
	25	v	v	v	v	v	v	v	v	v	v	v	v	v	v	v	v
	26	v	v	v	v	v	-	v	v	v	v	v	v	v	v	v	v
	66	v	v	v	v	v	v	v	v	v	v	v	v	v	v	v	v
Peak-to-Average Ratio	12				v	-	-	v	v	v	v			v		v	
	13	-	-		v	-	-	v	v	v	v			v		v	
	25						v	v	v	v	v			v		v	
	26				v		-	v	v	v	v			v		v	
	66						v	v	v	v	v			v		v	
26dB and 99% Bandwidth	12				v	-	-	v	v					v		v	
	13	-	-		v	-	-	v	v					v		v	
	25						v	v	v					v		v	
	26				v	v	-	v	v					v		v	
	66						v	v	v					v		v	



Test Items	Band	Bandwidth (MHz)						Modulation				RB #			Test Channel			
		1.4	3	5	10	15	20	QPSK	16QAM	64QAM	256QAM	1	Half	Full	L	M	H	
Conducted BandEdge	12	v	v	v	v	-	-	v	v	v	v	v		v	v		v	
	13	-	-	v	v	-	-	v	v	v	v	v		v	v		v	
	25	v	v	v	v	v	v	v	v	v	v	v		v	v		v	
	26	v	v	v	v	v	-	v	v	v	v	v		v	v		v	
	66	v	v	v	v	v	v	v	v	v	v	v		v	v		v	
Conducted Spurious Emission	12	v	v	v	v	-	-	v					v			v	v	v
	13	-	-	v	v	-	-	v					v			v	v	v
	25	v	v	v	v	v	v	v					v			v	v	v
	26	v	v	v	v	v	-	v					v			v	v	v
	66	v	v	v	v	v	v	v					v			v	v	v
Frequency Stability	12				v	-	-	v					v				v	
	13	-	-		v	-	-	v					v				v	
	25						v	v					v				v	
	26				v		-	v					v				v	
	66						v	v					v				v	
E.R.P / E.I.R.P	12	v	v	v	v	-	-	v	v	v	v	v	v	v	v	v	v	v
	13	-	-	v	v	-	-	v	v	v	v	v	v	v	v	v	v	v
	25	v	v	v	v	v	v	v	v	v	v	v	v	v	v	v	v	v
	26	v	v	v	v	v	-	v	v	v	v	v	v	v	v	v	v	v
	66	v	v	v	v	v	v	v	v	v	v	v	v	v	v	v	v	v
Radiated Spurious Emission	12	Worst Case															v	
	13	Worst Case															v	
	25	Worst Case															v	
	26	Worst Case															v	
	66	Worst Case															v	
Note	<ol style="list-style-type: none"> The mark "v" means that this configuration is chosen for testing The mark "-" means that this bandwidth is not supported. The device is investigated from 30MHz to 10 times of fundamental signal for radiated spurious emission test under different RB size/offset and modulations in exploratory test. Subsequently, only the worst case emissions are reported. All test items are based on engineering evaluation. 																	

2.2 Connection Diagram of Test System

Adapter mode:

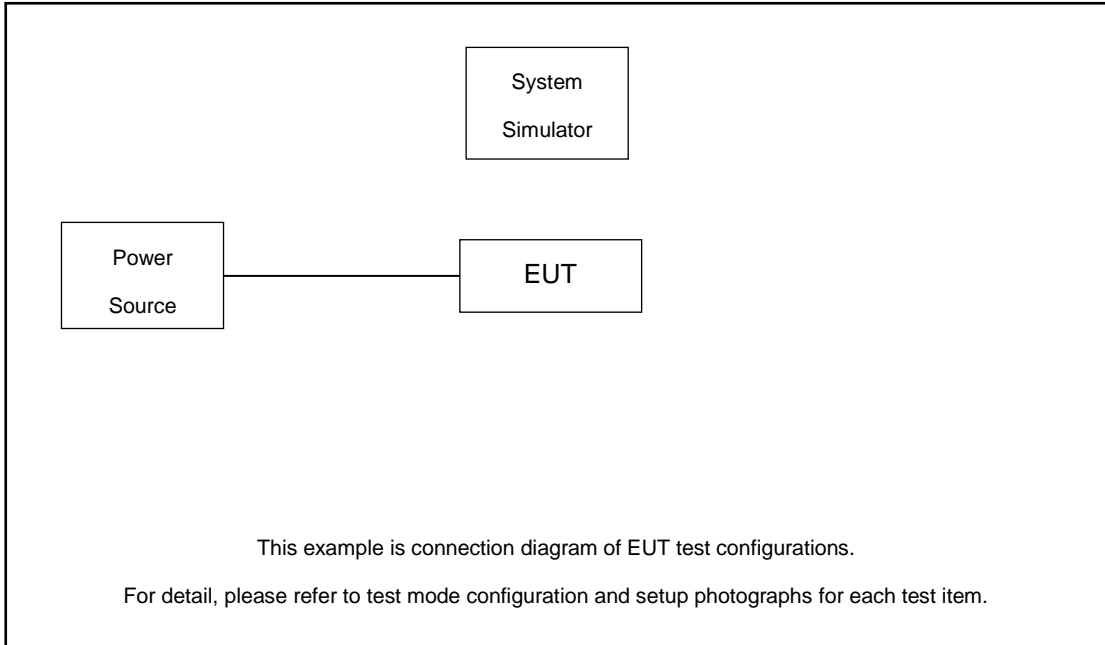

Earphone mode:

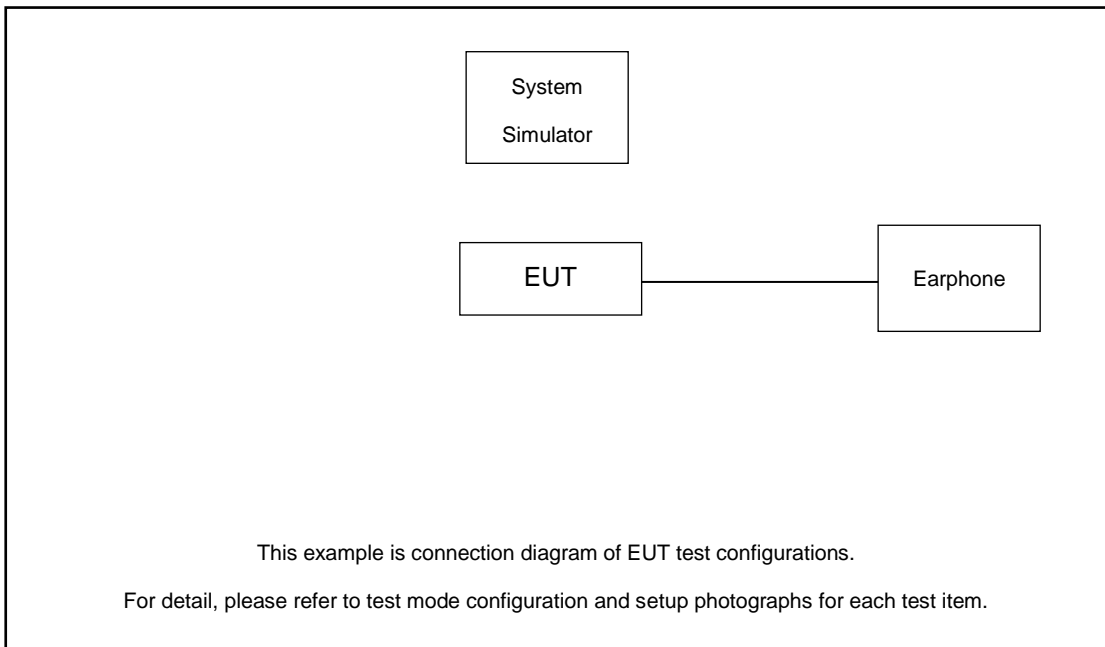

Wireless Charging mode:

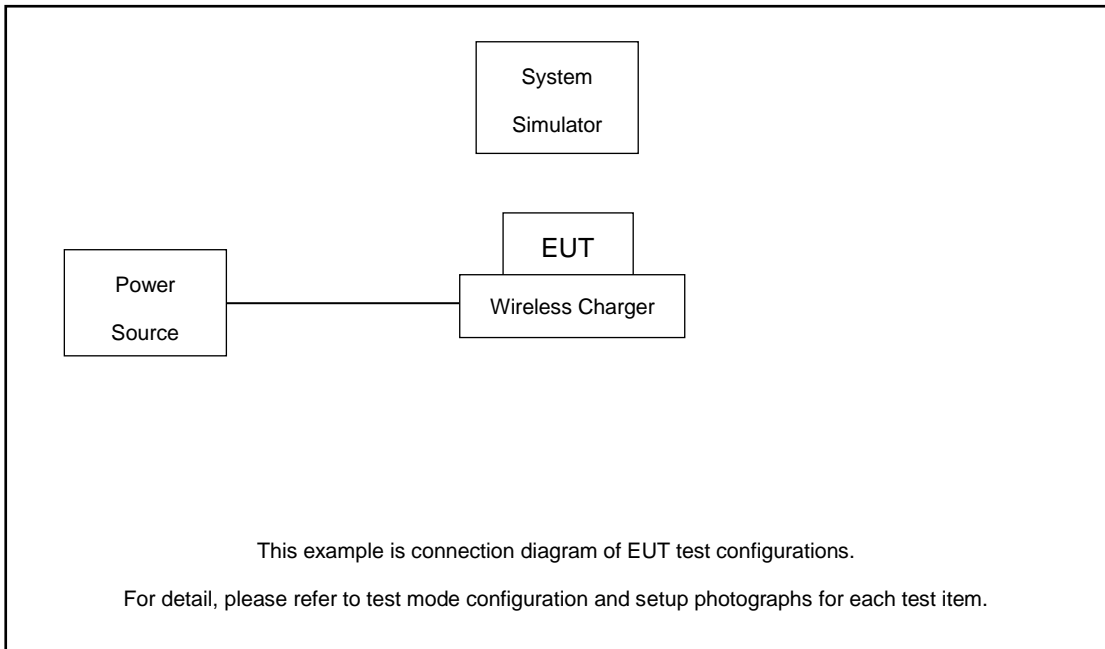

2.3 Support Unit used in test configuration and system

Item	Equipment	Trade Name	Model No.	FCC ID	Data Cable	Power Cord
1.	Power Supply	GWINSTEK	PSS-2002	N/A	N/A	Unshielded, 1.8 m
2.	LTE Base Station	Anritsu	MT8820C	N/A	N/A	Unshielded, 1.8 m
3.	Wireless Charger	N/A	N/A	N/A	N/A	N/A

2.4 Measurement Results Explanation Example

For all conducted test items:

The offset level is set in the spectrum analyzer to compensate the RF cable loss between EUT conducted output port and spectrum analyzer. With the offset compensation, the spectrum analyzer reading level is exactly the EUT RF output level.

The spectrum analyzer offset is derived from RF cable loss.

$$\text{Offset} = \text{RF cable loss.}$$

Following shows an offset computation example with cable loss 4.7 dB.

Example :

$$\begin{aligned} \text{Offset(dB)} &= \text{RF cable loss(dB)}. \\ &= 4.7 \text{ (dB)} \end{aligned}$$



2.5 Frequency List of Low/Middle/High Channels

LTE Band 2 Channel and Frequency List				
BW [MHz]	Channel/Frequency(MHz)	Lowest	Middle	Highest
20	Channel	18700	18900	19100
	Frequency	1860	1880	1900
15	Channel	18675	18900	19125
	Frequency	1857.5	1880	1902.5
10	Channel	18650	18900	19150
	Frequency	1855	1880	1905
5	Channel	18625	18900	19175
	Frequency	1852.5	1880	1907.5
3	Channel	18615	18900	19185
	Frequency	1851.5	1880	1908.5
1.4	Channel	18607	18900	19193
	Frequency	1850.7	1880	1909.3

LTE Band 4 Channel and Frequency List				
BW [MHz]	Channel/Frequency(MHz)	Lowest	Middle	Highest
20	Channel	20050	20175	20300
	Frequency	1720	1732.5	1745
15	Channel	20025	20175	20325
	Frequency	1717.5	1732.5	1747.5
10	Channel	20000	20175	20350
	Frequency	1715	1732.5	1750
5	Channel	19975	20175	20375
	Frequency	1712.5	1732.5	1752.5
3	Channel	19965	20175	20385
	Frequency	1711.5	1732.5	1753.5
1.4	Channel	19957	20175	20393
	Frequency	1710.7	1732.5	1754.3



LTE Band 5 Channel and Frequency List				
BW [MHz]	Channel/Frequency(MHz)	Lowest	Middle	Highest
10	Channel	20450	20525	20600
	Frequency	829	836.5	844
5	Channel	20425	20525	20625
	Frequency	826.5	836.5	846.5
3	Channel	20415	20525	20635
	Frequency	825.5	836.5	847.5
1.4	Channel	20407	20525	20643
	Frequency	824.7	836.5	848.3

LTE Band 12 Channel and Frequency List				
BW [MHz]	Channel/Frequency(MHz)	Lowest	Middle	Highest
10	Channel	23060	23095	23130
	Frequency	704	707.5	711
5	Channel	23035	23095	23155
	Frequency	701.5	707.5	713.5
3	Channel	23025	23095	23165
	Frequency	700.5	707.5	714.5
1.4	Channel	23017	23095	23173
	Frequency	699.7	707.5	715.3

LTE Band 13 Channel and Frequency List				
BW [MHz]	Channel/Frequency(MHz)	Lowest	Middle	Highest
10	Channel	-	23230	-
	Frequency	-	782	-
5	Channel	23205	23230	23255
	Frequency	779.5	782	784.5



LTE Band 17 Channel and Frequency List				
BW [MHz]	Channel/Frequency(MHz)	Lowest	Middle	Highest
10	Channel	23780	23790	23800
	Frequency	709	710	711
5	Channel	23755	23790	23825
	Frequency	706.5	710	713.5

LTE Band 25 Channel and Frequency List				
BW [MHz]	Channel/Frequency(MHz)	Lowest	Middle	Highest
20	Channel	26140	26340	26590
	Frequency	1860	1880	1905
15	Channel	26115	26340	26615
	Frequency	1857.5	1880	1907.5
10	Channel	26090	26340	26640
	Frequency	1855	1880	1910
5	Channel	26065	26340	26665
	Frequency	1852.5	1880	1912.5
3	Channel	26055	26340	26675
	Frequency	1851.5	1880	1913.5
1.4	Channel	26047	26340	26683
	Frequency	1850.7	1880	1914.3

LTE Band 26 Channel and Frequency List				
BW [MHz]	Channel/Frequency(MHz)	Lowest	Middle	Highest
15	Channel	26865	26915	26965
	Frequency	831.5	836.5	841.5
10	Channel	26840	26915	26990
	Frequency	829	836.5	844
5	Channel	26815	26915	27015
	Frequency	826.5	836.5	846.5
3	Channel	26805	26915	27025
	Frequency	825.5	836.5	847.5
1.4	Channel	26797	26915	27033
	Frequency	824.7	836.5	848.3



LTE Band 66 Channel and Frequency List				
BW [MHz]	Channel/Frequency(MHz)	Lowest	Middle	Highest
20	Channel	132072	132322	132572
	Frequency	1720	1745	1770
15	Channel	132047	132322	132597
	Frequency	1717.5	1745	1772.5
10	Channel	132022	132322	132622
	Frequency	1715	1745	1775
5	Channel	131997	132322	132647
	Frequency	1712.5	1745	1777.5
3	Channel	131987	132322	132657
	Frequency	1711.5	1745	1778.5
1.4	Channel	131979	132322	132665
	Frequency	1710.7	1745	1779.3

3 Conducted Test Items

3.1 Measuring Instruments

See list of measuring instruments of this test report.

3.2 Test Setup

3.2.1 Conducted Output Power



3.2.2 Peak-to-Average Ratio, Occupied Bandwidth, Conducted Band-Edge and Conducted Spurious Emission

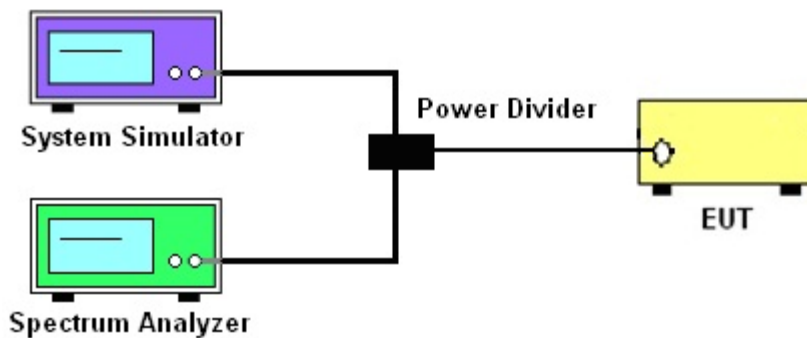

3.2.3 Frequency Stability

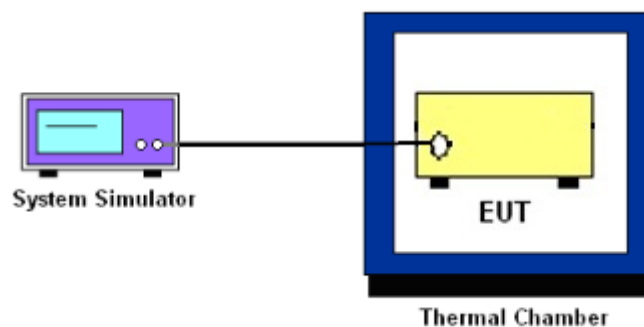

3.3 Test Result of Conducted Test

Please refer to Appendix A.



3.4 Conducted Output Power and ERP/EIRP

3.4.1 Description of the Conducted Output Power Measurement and ERP/EIRP Measurement

A system simulator was used to establish communication with the EUT. Its parameters were set to force the EUT transmitting at maximum output power. The measured power in the radio frequency on the transmitter output terminals shall be reported.

The ERP of mobile transmitters must not exceed 7 Watts for LTE Band 5 and Band 26.

The ERP of mobile transmitters must not exceed 3 Watts for LTE Band 12, Band 13 and Band 17.

The EIRP of mobile transmitters must not exceed 2 Watts for LTE Band 2 and Band 25.

The EIRP of mobile transmitters must not exceed 1 Watts for LTE Band 4 and Band 66.

According to KDB 412172 D01 Power Approach,

$EIRP = P_T + G_T - L_C$, $ERP = EIRP - 2.15$, where

P_T = transmitter output power in dBm

G_T = gain of the transmitting antenna in dBi

L_C = signal attenuation in the connecting cable between the transmitter and antenna in dB

3.4.2 Test Procedures

1. The testing follows ANSI C63.26 Section 5.2
2. The transmitter output port was connected to the system simulator.
3. Set EUT at maximum power through the system simulator.
4. Select lowest, middle, and highest channels for each band and different modulation.
5. Measure and record the power level from the system simulator.



3.5 Peak-to-Average Ratio

3.5.1 Description of the PAR Measurement

Power Complementary Cumulative Distribution Function (CCDF) curves provide a means for characterizing the power peaks of a digitally modulated signal on a statistical basis. A CCDF curve depicts the probability of the peak signal amplitude exceeding the average power level. Most contemporary measurement instrumentation include the capability to produce CCDF curves for an input signal provided that the instrument's resolution bandwidth can be set wide enough to accommodate the entire input signal bandwidth. In measuring transmissions in this band using an average power technique, the peak-to-average ratio (PAR) of the transmission may not exceed 13 dB.

3.5.2 Test Procedures

1. The testing follows ANSI C63.26 Section 5.2.3.4 (CCDF).
2. The EUT was connected to spectrum and system simulator via a power divider.
3. Set the CCDF (Complementary Cumulative Distribution Function) option in spectrum analyzer.
4. The highest RF powers were measured and recorded the maximum PAPR level associated with a probability of 0.1 %.
5. Record the deviation as Peak to Average Ratio.



3.6 Occupied Bandwidth

3.6.1 Description of Occupied Bandwidth Measurement

The occupied bandwidth is the width of a frequency band such that, below the lower and above the upper frequency limits, the mean powers emitted are each equal to a specified percentage 0.5% of the total mean transmitted power.

The 26 dB emission bandwidth is defined as the frequency range between two points, one above and one below the carrier frequency, at which the spectral density of the emission is attenuated 26 dB below the maximum in-band spectral density of the modulated signal. Spectral density (power per unit bandwidth) is to be measured with a detector of resolution bandwidth equal to approximately 1.0% of the emission bandwidth.

3.6.2 Test Procedures

1. The testing follows ANSI C63.26 Section 5.4
2. The EUT was connected to spectrum analyzer and system simulator via a power divider.
3. The spectrum analyzer center frequency is set to the nominal EUT channel center frequency. The span range for the spectrum analyzer shall be between two and five times the anticipated OBW.
4. The nominal resolution bandwidth (RBW) shall be in the range of 1 to 5 % of the anticipated OBW, and the VBW shall be at least 3 times the RBW.
5. Set the detection mode to peak, and the trace mode to max hold.
6. Determine the reference value: Set the EUT to transmit a modulated signal. Allow the trace to stabilize. Set the spectrum analyzer marker to the highest level of the displayed trace.
(this is the reference value)
7. Determine the “-26 dB down amplitude” as equal to (Reference Value – X).
8. Place two markers, one at the lowest and the other at the highest frequency of the envelope of the spectral display such that each marker is at or slightly below the “-X dB down amplitude” determined in step 6. If a marker is below this “-X dB down amplitude” value it shall be placed as close as possible to this value. The OBW is the positive frequency difference between the two markers.
9. Use the 99 % power bandwidth function of the spectrum analyzer and report the measured bandwidth.



3.7 Conducted Band Edge

3.7.1 Description of Conducted Band Edge Measurement

22.917(a)

For operations in the 824 – 849 MHz band, the FCC limit is $43 + 10\log_{10}(P[\text{Watts}])$ dB below the transmitter power $P(\text{Watts})$ in a 100kHz bandwidth. However, in the 1MHz bands immediately outside and adjacent to the licensee's frequency block, a resolution bandwidth of at least one percent of the emission bandwidth of the fundamental emission of the transmitter may be employed.

24.238 (a)

For operations in the 1850-1910 and 1930-1990 MHz band, the FCC limit is $43 + 10\log_{10}(P[\text{Watts}])$ dB below the transmitter power $P(\text{Watts})$ in a 1MHz bandwidth. However, in the 1 MHz bands immediately outside and adjacent to the frequency block a resolution bandwidth of at least one percent of the emission bandwidth of the fundamental emission of the transmitter may be employed.

27.53 (c)

For operations in the 776-788 MHz band, the FCC limit is $43 + 10\log_{10}(P[\text{Watts}])$ dB below the transmitter power $P(\text{Watts})$ in a 100 kHz bandwidth. However, in the 100 kHz bands immediately outside and adjacent to the frequency block, a resolution bandwidth of at least 30 kHz may be employed. In addition, the power of any unwanted emissions in any 6.25 kHz bandwidth for all frequencies between 763-775 MHz and 793-806 MHz shall be attenuated below the transmitter power, P (dBW), by at least $65 + 10 \log_{10} p(\text{watts})$, dB, for mobile and portable equipment.

27.53 (g)

For operations in the 600MHz band and 698 -746 MHz band, the FCC limit is $43 + 10\log_{10}(P[\text{Watts}])$ dB below the transmitter power $P(\text{Watts})$ in a 100 kHz bandwidth. However, in the 100 kilohertz bands immediately outside and adjacent to a licensee's frequency block, a resolution bandwidth of at least 30 kHz may be employed.

27.53 (h)

For operations in the 1710 – 1755 MHz band, the FCC limit is $43 + 10\log_{10}(P[\text{Watts}])$ dB below the transmitter power $P(\text{Watts})$ in a 1 MHz bandwidth. However, in the 1MHz bands immediately outside and adjacent to the licensee's frequency block, a resolution bandwidth of at least one percent of the emission bandwidth of the fundamental emission of the transmitter may be employed.



3.7.2 Test Procedures

1. The testing follows ANSI C63.26 section 5.7
2. The EUT was connected to spectrum analyzer and system simulator via a power divider.
3. The band edges of low and high channels for the highest RF powers were measured.
4. Set RBW \geq 1% EBW in the 1MHz band immediately outside and adjacent to the band edge.
5. Beyond the 1 MHz band from the band edge, RBW=1MHz was used.
6. Set spectrum analyzer with RMS detector.
7. The RF fundamental frequency should be excluded against the limit line in the operating frequency band.
8. Checked that all the results comply with the emission limit line.

Example:

The limit line is derived from $43 + 10\log(P)$ dB below the transmitter power P(Watts)
= P(W)- [43 + 10log(P)] (dB)
= [30 + 10log(P)] (dBm) - [43 + 10log(P)] (dB) = -13dBm.



3.8 Conducted Spurious Emission

3.8.1 Description of Conducted Spurious Emission Measurement

The power of any emission outside of the authorized operating frequency ranges must be lower than the transmitter power (P) by a factor of at least $43 + 10 \log (P)$ dB.

It is measured by means of a calibrated spectrum analyzer and scanned from 30 MHz up to a frequency including its 10th harmonic.

3.8.2 Test Procedures

1. The testing follows ANSI C63.26 section 5.7
2. The EUT was connected to spectrum analyzer and system simulator via a power divider.
3. The RF output of EUT was connected to the spectrum analyzer by RF cable and attenuator. The path loss was compensated to the results for each measurement.
4. The middle channel for the highest RF power within the transmitting frequency was measured.
5. The conducted spurious emission for the whole frequency range was taken.
6. Make the measurement with the spectrum analyzer's RBW = 1MHz, VBW = 3MHz.
7. Set spectrum analyzer with RMS detector.
8. Taking the record of maximum spurious emission.
9. The RF fundamental frequency should be excluded against the limit line in the operating frequency band.
10. The limit line is derived from $43 + 10\log(P)$ dB below the transmitter power P(Watts)
= P(W)- [43 + 10log(P)] (dB)
= [30 + 10log(P)] (dBm) - [43 + 10log(P)] (dB)
= -13dBm.



3.9 Frequency Stability

3.9.1 Description of Frequency Stability Measurement

The frequency stability shall be measured by variation of ambient temperature and variation of primary supply voltage to ensure that the fundamental emission stays within the authorized frequency block. The frequency stability of the transmitter shall be maintained within $\pm 0.00025\%$ ($\pm 2.5\text{ppm}$) of the center frequency.

3.9.2 Test Procedures for Temperature Variation

1. The testing follows ANSI C63.26 section 5.6.4
2. The EUT was set up in the thermal chamber and connected with the system simulator.
3. With power OFF, the temperature was decreased to -30°C and the EUT was stabilized before testing. Power was applied and the maximum change in frequency was recorded within one minute.
4. With power OFF, the temperature was raised in 10°C step up to 50°C . The EUT was stabilized at each step for at least half an hour. Power was applied and the maximum frequency change was recorded within one minute.

3.9.3 Test Procedures for Voltage Variation

1. The testing follows ANSI C63.26 section 5.6.5
2. The EUT was placed in a temperature chamber at $20\pm 5^{\circ}\text{C}$ and connected with the system simulator.
3. The power supply voltage to the EUT was varied from 85% to 115% of the nominal value for other than hand carried battery equipment.
4. For hand carried, battery powered equipment, reduce the primary ac or dc supply voltage to the battery operating end point, which shall be specified by the manufacturer.
5. The variation in frequency was measured for the worst case.

4 Radiated Test Items

4.1 Measuring Instruments

See list of measuring instruments of this test report.

4.2 Test Setup

4.2.1 For radiated test below 30MHz

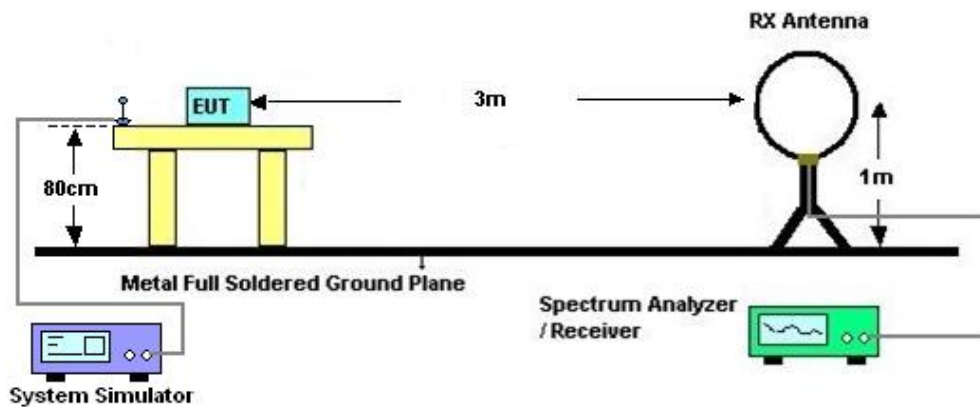

4.2.2 For radiated test from 30MHz to 1GHz

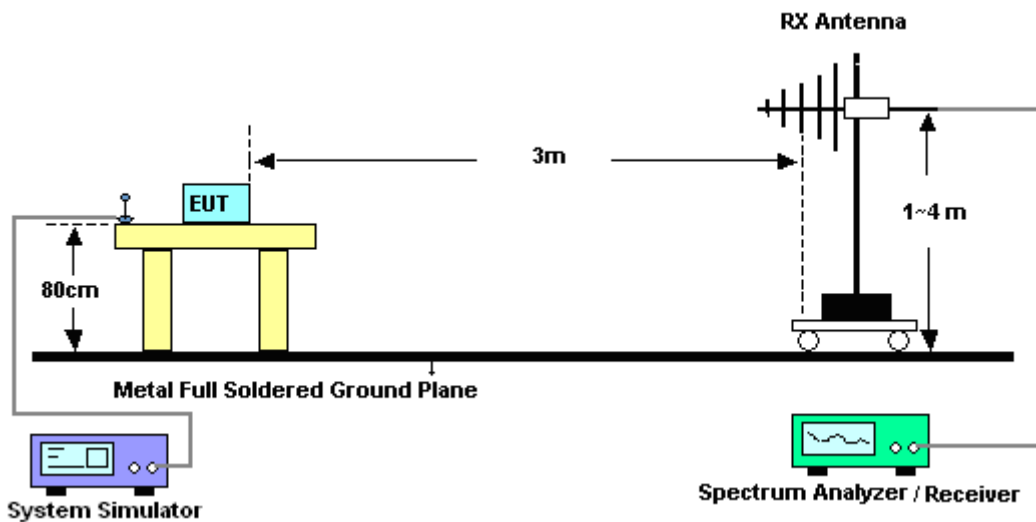

4.2.3 For radiated test above 1GHz

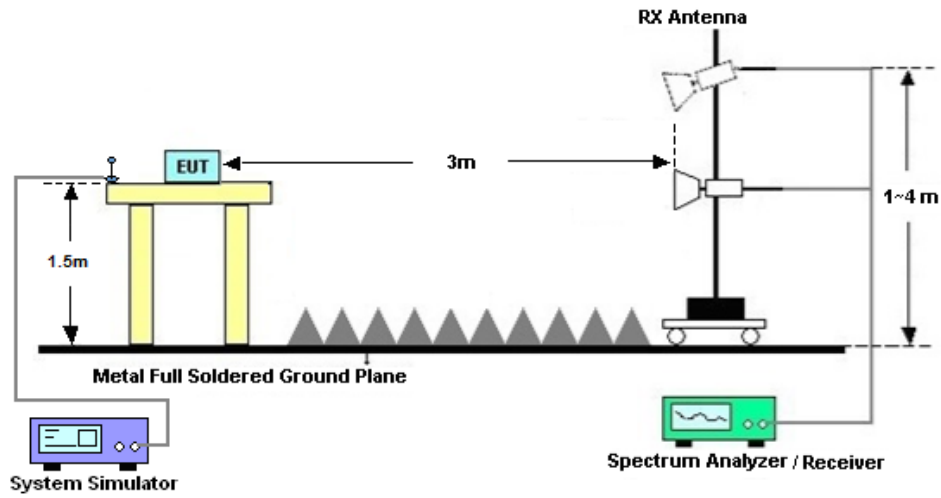

4.3 Test Result of Radiated Test

The low frequency, which started from 9 kHz to 30MHz, was pre-scanned and the result which was 20dB lower than the limit line was not reported.

Please refer to Appendix B.



4.4 Radiated Spurious Emission

4.4.1 Description of Radiated Spurious Emission

The radiated spurious emission was measured by substitution method according to ANSI C63.26. The power of any emission outside of the authorized operating frequency ranges must be attenuated below the transmitter power (P) by a factor of at least $43 + 10 \log (P)$ dB.

For LTE Band 13

For operations in the 746-758 MHz, 775-788 MHz, and 805-806 MHz bands, emissions in the band 1559-1610 MHz shall be limited to -70 dBW/MHz equivalent isotropically radiated power (EIRP) for wideband signals, and -80 dBW EIRP for discrete emissions of less than 700 Hz bandwidth.

The spectrum is scanned from 30 MHz up to a frequency including its 10th harmonic.

4.4.2 Test Procedures

1. The testing follows ANSI C63.26 Section 5.5
2. The EUT was placed on a turntable with 0.8 meter height for frequency below 1GHz and 1.5 meter height for frequency above 1GHz respectively above ground.
3. The EUT was set 3 meters from the receiving antenna mounted on the antenna tower.
4. The table was rotated 360 degrees to determine the position of the highest spurious emission.
5. The height of the receiving antenna is varied between 1m to 4m to search the maximum spurious emission for both horizontal and vertical polarizations.
6. During the measurement, the system simulator parameters were set to force the EUT transmitting at maximum output power.
7. Make the measurement with the spectrum analyzer's RBW = 1MHz, VBW = 3MHz, taking the record of maximum spurious emission.
8. A horn antenna was substituted in place of the EUT and was driven by a signal generator.
9. Tune the output power of signal generator to the same emission level with EUT maximum spurious emission.
10. $EIRP \text{ (dBm)} = S.G. \text{ Power} - Tx \text{ Cable Loss} + Tx \text{ Antenna Gain}$
11. $ERP \text{ (dBm)} = EIRP - 2.15$
12. The RF fundamental frequency should be excluded against the limit line in the operating frequency band.

The limit line is derived from $43 + 10\log(P)$ dB below the transmitter power P(Watts)
 $= P(W) - [43 + 10\log(P)] \text{ (dB)}$
 $= [30 + 10\log(P)] \text{ (dBm)} - [43 + 10\log(P)] \text{ (dB)}$
 $= -13\text{dBm}.$



5 List of Measuring Equipment

Instrument	Manufacturer	Model No.	Serial No.	Characteristics	Calibration Date	Test Date	Due Date	Remark
Spectrum Analyzer	R&S	FSV40	101040	10Hz~40GHz	Oct. 14, 2021	Oct. 29, 2021~Nov. 08, 2021	Oct. 13, 2022	Conducted (TH01-KS)
Power divider	STI	STI08-0055	-	0.5~40GHz	Aug. 26, 2021	Oct. 29, 2021~Nov. 08, 2021	Aug. 25, 2022	Conducted (TH01-KS)
Temperature & humidity chamber	Hongzhan	LP-150U	H2014011440	-40~+150°C 20%~95%RH	Jul. 12, 2021	Oct. 29, 2021~Nov. 08, 2021	Jul. 11, 2022	Conducted (TH01-KS)
EXA Spectrum Analyzer	Keysight	N9010A	MY55150244	10Hz~44G,MAX 30dB	Apr. 13, 2021	Nov. 15, 2021	Apr. 12, 2022	Radiation (03CH04-KS)
Loop Antenna	R&S	HFH2-Z2	100321	9kHz~30MHz	Oct. 30, 2021	Nov. 15, 2021	Oct. 29, 2022	Radiation (03CH04-KS)
Bilog Antenna	TeseQ	CBL6111D	49922	30MHz~1GHz	May 30, 2021	Nov. 15, 2021	May 29, 2022	Radiation (03CH04-KS)
Horn Antenna	Schwarzbeck	BBHA9120D	1356	1GHz~18GHz	Apr. 18, 2021	Nov. 15, 2021	Apr. 17, 2022	Radiation (03CH04-KS)
SHF-EHF Horn	Com-power	AH-840	101070	18GHz~40GHz	Jan. 06, 2021	Nov. 15, 2021	Jan. 05, 2022	Radiation (03CH04-KS)
Amplifier	SONOMA	310N	187289	9KHz~1GHz	Jan. 06, 2021	Nov. 15, 2021	Jan. 05, 2022	Radiation (03CH04-KS)
Amplifier	MITEQ	EM18G40G GA	060728	18~40GHz	Jan. 07, 2021	Nov. 15, 2021	Jan. 06, 2022	Radiation (03CH04-KS)
high gain Amplifier	MITEQ	AMF-7D-00 101800-30-1 0P	2025788	1Ghz~18Ghz	Jan. 06, 2021	Nov. 15, 2021	Jan. 05, 2022	Radiation (03CH04-KS)
Amplifier	Keysight	83017A	MY57280106	500MHz~26.5GHz	Oct. 13, 2021	Nov. 15, 2021	Oct. 12, 2022	Radiation (03CH04-KS)
AC Power Source	Chroma	61601	F104090004	N/A	NCR	Nov. 15, 2021	NCR	Radiation (03CH04-KS)
Turn Table	ChamPro	EM 1000-T	060762-T	0~360 degree	NCR	Nov. 15, 2021	NCR	Radiation (03CH04-KS)
Antenna Mast	ChamPro	EM 1000-A	060762-A	1 m~4 m	NCR	Nov. 15, 2021	NCR	Radiation (03CH04-KS)

NCR: No Calibration Required



6 Uncertainty of Evaluation

The measurement uncertainties shown below were calculated in accordance with the requirements of ANSI 63.26-2015. All the measurement uncertainty value were shown with a coverage K=2 to indicate 95% level of confidence. The measurement data show herein meets or exceeds the CISPR measurement uncertainty values specified in CISPR 16-4-2 and can be compared directly to specified limit to determine compliance.

Uncertainty of Radiated Emission Measurement (30 MHz ~ 1000 MHz)

Measuring Uncertainty for a Level of Confidence of 95% (U = 2Uc(y))	3.3dB
---	-------

Uncertainty of Radiated Emission Measurement (1 GHz ~ 18 GHz)

Measuring Uncertainty for a Level of Confidence of 95% (U = 2Uc(y))	2.8dB
---	-------

Uncertainty of Radiated Emission Measurement (18 GHz ~ 40 GHz)

Measuring Uncertainty for a Level of Confidence of 95% (U = 2Uc(y))	2.8dB
---	-------



Appendix A. Test Results of Conducted Test

Test Engineer :	Yong He	Temperature :	21~24°C
		Relative Humidity :	45~51%

Conducted Output Power(Average power) and ERP/EIRP

LTE Band 2:

BW [MHz]	Modulation	RB Size	RB Offset	Power Low Ch. / Freq.	Power Middle Ch. / Freq.	Power High Ch. / Freq.	EIRP(W)		
							L	M	H
Channel				18700	18900	19100	EIRP(W)		
Frequency (MHz)				1860	1880	1900	L	M	H
20	QPSK	1	0	22.74	22.82	22.73	0.1675	0.1706	0.1671
20	QPSK	1	99	22.62	22.69	22.69	0.1629	0.1656	0.1656
20	QPSK	100	0	22.79	22.81	22.77	0.1694	0.1702	0.1687
20	16QAM	1	0	22.71	22.79	22.70	0.1663	0.1694	0.1660
20	64QAM	1	0	22.66	22.75	22.60	0.1644	0.1679	0.1622
20	256QAM	1	0	19.58	19.58	19.60	0.0809	0.0809	0.0813
Channel				18675	18900	19125	EIRP(W)		
Frequency (MHz)				1857.5	1880	1902.5	L	M	H
15	QPSK	1	0	22.62	22.78	22.60	0.1629	0.1690	0.1622
15	16QAM	1	0	22.66	22.66	22.55	0.1644	0.1644	0.1603
Channel				18650	18900	19150	EIRP(W)		
Frequency (MHz)				1855	1880	1905	L	M	H
10	QPSK	1	0	22.77	22.67	22.73	0.1687	0.1648	0.1671
10	16QAM	1	0	22.60	22.66	22.59	0.1622	0.1644	0.1618
Channel				18625	18900	19175	EIRP(W)		
Frequency (MHz)				1852.5	1880	1907.5	L	M	H
5	QPSK	1	0	22.60	22.80	22.64	0.1622	0.1698	0.1637
5	16QAM	1	0	22.60	22.69	22.57	0.1622	0.1656	0.1611
Channel				18615	18900	19185	EIRP(W)		
Frequency (MHz)				1851.5	1880	1908.5	L	M	H
3	QPSK	1	0	22.66	22.76	22.68	0.1644	0.1683	0.1652
3	16QAM	1	0	22.65	22.69	22.64	0.1641	0.1656	0.1637
Channel				18607	18900	19193	EIRP(W)		
Frequency (MHz)				1850.7	1880	1909.3	L	M	H
1.4	QPSK	1	0	22.60	22.80	22.60	0.1622	0.1698	0.1622
1.4	16QAM	1	0	22.57	22.67	22.59	0.1611	0.1648	0.1618



LTE Band 4:

BW [MHz]	Modulation	RB Size	RB Offset	Power Low Ch. / Freq.	Power Middle Ch. / Freq.	Power High Ch. / Freq.	EIRP(W)		
Channel				20050	20175	20300	EIRP(W)		
Frequency (MHz)				1720	1732.5	1745	L	M	H
20	QPSK	1	0	23.02	23.12	22.91	0.1786	0.1828	0.1742
20	QPSK	1	99	22.73	22.73	22.66	0.1671	0.1671	0.1644
20	QPSK	100	0	23.00	23.05	22.90	0.1778	0.1799	0.1738
20	16QAM	1	0	22.88	23.01	22.76	0.1730	0.1782	0.1683
20	64QAM	1	0	22.95	22.97	22.76	0.1758	0.1766	0.1683
20	256QAM	1	0	19.19	19.24	19.22	0.0740	0.0748	0.0745
Channel				20025	20175	20325	EIRP(W)		
Frequency (MHz)				1717.5	1732.5	1747.5	L	M	H
15	QPSK	1	0	22.91	23.04	22.84	0.1742	0.1795	0.1714
15	16QAM	1	0	22.83	22.87	22.69	0.1710	0.1726	0.1656
Channel				20000	20175	20350	EIRP(W)		
Frequency (MHz)				1715	1732.5	1750	L	M	H
10	QPSK	1	0	22.92	23.09	22.85	0.1746	0.1816	0.1718
10	16QAM	1	0	22.87	22.92	22.76	0.1726	0.1746	0.1683
Channel				19975	20175	20375	EIRP(W)		
Frequency (MHz)				1712.5	1732.5	1752.5	L	M	H
5	QPSK	1	0	22.83	23.05	22.77	0.1710	0.1799	0.1687
5	16QAM	1	0	22.86	22.85	22.71	0.1722	0.1718	0.1663
Channel				19965	20175	20385	EIRP(W)		
Frequency (MHz)				1711.5	1732.5	1753.5	L	M	H
3	QPSK	1	0	22.81	23.00	22.73	0.1702	0.1778	0.1671
3	16QAM	1	0	22.83	22.78	22.65	0.1710	0.1690	0.1641
Channel				19950	20175	20393	EIRP(W)		
Frequency (MHz)				1710	1732.5	1754.3	L	M	H
1.4	QPSK	1	0	22.81	22.96	22.73	0.1702	0.1762	0.1671
1.4	16QAM	1	0	22.81	22.75	22.62	0.1702	0.1679	0.1629



LTE Band 5:

BW [MHz]	Modulation	RB Size	RB Offset	Power Low Ch. / Freq.	Power Middle Ch. / Freq.	Power High Ch. / Freq.	ERP(W)		
Channel				20450	20525	20600	ERP(W)		
Frequency (MHz)				829	836.5	844	L	M	H
10	QPSK	1	0	22.70	22.86	22.81	0.0507	0.0526	0.0520
10	QPSK	1	49	22.47	22.75	22.68	0.0481	0.0513	0.0505
10	QPSK	50	0	22.74	22.78	22.73	0.0512	0.0516	0.0511
10	16QAM	1	0	22.66	22.82	22.73	0.0502	0.0521	0.0511
10	64QAM	1	0	22.64	22.80	22.72	0.0500	0.0519	0.0509
10	256QAM	1	0	19.46	19.26	19.19	0.0240	0.0230	0.0226
Channel				20425	20525	20625	ERP(W)		
Frequency (MHz)				826.5	836.5	846.5	L	M	H
5	QPSK	1	0	22.64	22.79	22.72	0.0500	0.0518	0.0509
5	16QAM	1	0	22.62	22.72	22.65	0.0498	0.0509	0.0501
Channel				20415	20525	20635	ERP(W)		
Frequency (MHz)				825.5	836.5	847.5	L	M	H
3	QPSK	1	0	22.60	22.80	22.64	0.0495	0.0519	0.0500
3	16QAM	1	0	22.58	22.69	22.64	0.0493	0.0506	0.0500
Channel				20407	20525	20643	ERP(W)		
Frequency (MHz)				824.7	836.5	848.3	L	M	H
1.4	QPSK	1	0	22.55	22.77	22.55	0.0490	0.0515	0.0490
1.4	16QAM	1	0	22.50	22.66	22.55	0.0484	0.0502	0.0490

LTE Band 12:

BW [MHz]	Modulation	RB Size	RB Offset	Power Low Ch. / Freq.	Power Middle Ch. / Freq.	Power High Ch. / Freq.	ERP(W)		
Channel				23060	23095	23130	ERP(W)		
Frequency (MHz)				704	707.5	711	L	M	H
10	QPSK	1	0	22.68	22.93	22.76	0.0505	0.0535	0.0514
10	QPSK	1	49	22.85	22.79	22.84	0.0525	0.0518	0.0524
10	QPSK	50	0	22.79	22.91	22.76	0.0518	0.0532	0.0514
10	16QAM	1	0	22.83	22.70	22.92	0.0522	0.0507	0.0533
10	64QAM	1	0	22.67	22.89	22.68	0.0504	0.0530	0.0505
10	256QAM	1	0	19.67	19.50	19.40	0.0252	0.0243	0.0237
Channel				23035	23095	23205	ERP(W)		
Frequency (MHz)				701.5	707.5	718.5	L	M	H
5	QPSK	1	0	22.87	22.70	22.87	0.0527	0.0507	0.0527
5	16QAM	1	0	22.76	22.65	22.88	0.0514	0.0501	0.0528
Channel				23025	23095	23195	ERP(W)		
Frequency (MHz)				700.5	707.5	717.5	L	M	H
3	QPSK	1	0	22.82	22.90	22.79	0.0521	0.0531	0.0518
3	16QAM	1	0	22.78	22.69	22.90	0.0516	0.0506	0.0531
Channel				23017	23095	23173	ERP(W)		
Frequency (MHz)				699.7	707.5	715.3	L	M	H
1.4	QPSK	1	0	22.76	22.88	22.66	0.0514	0.0528	0.0502
1.4	16QAM	1	0	22.72	22.85	22.76	0.0509	0.0525	0.0514



LTE Band 13:

BW [MHz]	Modulation	RB Size	RB Offset	Power Low Ch. / Freq.	Power Middle Ch. / Freq.	Power High Ch. / Freq.	ERP(W)		
Channel				-	23230	-			
Frequency (MHz)				-	782	-	-	M	-
10	QPSK	1	0	-	23.22	-	-	0.0533	-
10	QPSK	1	49		22.88			0.0493	
10	QPSK	50	0		22.88			0.0493	
10	16QAM	1	0		23.21			0.0532	
10	64QAM	1	0		23.13			0.0522	
10	256QAM	1	0		19.79			0.0242	
Channel				23205	23230	23255	ERP(W)		
Frequency (MHz)				779.5	782	784.5	L	M	H
5	QPSK	1	0	22.83	22.74	22.91	0.0488	0.0478	0.0497
5	16QAM	1	0	23.21	23.07	23.20	0.0532	0.0515	0.0531

LTE Band 17:

BW [MHz]	Modulation	RB Size	RB Offset	Power Low Ch. / Freq.	Power Middle Ch. / Freq.	Power High Ch. / Freq.	ERP(W)		
Channel				23780	23790	23800			
Frequency (MHz)				709	710	711	L	M	H
10	QPSK	1	0	22.48	22.88	22.49	0.0482	0.0528	0.0483
10	QPSK	1	49	22.38	22.39	22.41	0.0471	0.0472	0.0474
10	QPSK	50	0	22.50	22.68	22.60	0.0484	0.0505	0.0495
10	16QAM	1	0	22.83	22.87	22.73	0.0522	0.0527	0.0511
10	64QAM	1	0	22.78	22.64	22.72	0.0516	0.0500	0.0509
10	256QAM	1	0	18.83	19.10	18.78	0.0208	0.0221	0.0206
Channel				23755	23790	23825	ERP(W)		
Frequency (MHz)				706.5	710	713.5	L	M	H
5	QPSK	1	0	22.63	22.68	22.58	0.0499	0.0505	0.0493
5	16QAM	1	0	22.83	22.82	22.83	0.0522	0.0521	0.0522



LTE Band 25:

BW [MHz]	Modulation	RB Size	RB Offset	Power Low Ch. / Freq.	Power Middle Ch. / Freq.	Power High Ch. / Freq.	EIRP(W)		
Channel				26140	26340	26590	EIRP(W)		
Frequency (MHz)				1860	1880	1905	L	M	H
20	QPSK	1	0	22.80	22.89	22.87	0.1698	0.1734	0.1726
20	QPSK	1	99	22.67	22.70	22.78	0.1648	0.1660	0.1690
20	QPSK	100	0	22.87	22.88	22.86	0.1726	0.1730	0.1722
20	16QAM	1	0	22.83	22.84	22.86	0.1710	0.1714	0.1722
20	64QAM	1	0	22.83	22.86	22.83	0.1710	0.1722	0.1710
20	256QAM	1	0	19.57	19.37	19.57	0.0807	0.0771	0.0807
Channel				26115	26340	26615	EIRP(W)		
Frequency (MHz)				1857.5	1880	1907.5	L	M	H
15	QPSK	1	0	22.82	22.86	22.80	0.1706	0.1722	0.1698
15	16QAM	1	0	22.80	22.80	22.82	0.1698	0.1698	0.1706
Channel				26090	26340	26640	EIRP(W)		
Frequency (MHz)				1855	1880	1910	L	M	H
10	QPSK	1	0	22.80	22.83	22.75	0.1698	0.1710	0.1679
10	16QAM	1	0	22.77	22.75	22.79	0.1687	0.1679	0.1694
Channel				26065	26340	26665	EIRP(W)		
Frequency (MHz)				1852.5	1880	1912.5	L	M	H
5	QPSK	1	0	22.77	22.78	22.69	0.1687	0.1690	0.1656
5	16QAM	1	0	22.73	22.70	22.76	0.1671	0.1660	0.1683
Channel				26055	26340	26675	EIRP(W)		
Frequency (MHz)				1851.5	1880	1913.5	L	M	H
3	QPSK	1	0	22.72	22.73	22.64	0.1667	0.1671	0.1637
3	16QAM	1	0	22.68	22.66	22.72	0.1652	0.1644	0.1667
Channel				26047	26340	26683	EIRP(W)		
Frequency (MHz)				1850.7	1880	1914.3	L	M	H
1.4	QPSK	1	0	22.68	22.71	22.59	0.1652	0.1663	0.1618
1.4	16QAM	1	0	22.63	22.64	22.69	0.1633	0.1637	0.1656



LTE Band 26:

BW [MHz]	Modulation	RB Size	RB Offset	Power Low Ch. / Freq.	Power Low Ch. / Freq.	Power Middle Ch. / Freq.	Power High Ch. / Freq.	ERP(W)			
Channel				26765	26865	26915	26965				
Frequency (MHz)				821.5	831.5	836.5	841.5	L	M	H	
15	QPSK	1	0	22.51	22.61	22.42	22.52	0.0485	0.0497	0.0475	0.0486
15	QPSK	1	74	22.45	22.59	22.53	22.56	0.0479	0.0494	0.0488	0.0491
15	QPSK	75	0	22.54	22.57	22.56	22.56	0.0489	0.0492	0.0491	0.0491
15	16QAM	1	0	22.48	22.57	22.57	22.46	0.0482	0.0492	0.0492	0.0480
15	64QAM	1	0	22.39	22.56	22.54	22.54	0.0472	0.0491	0.0489	0.0489
15	256QAM	1	0	19.16	19.25	19.25	19.17	0.0224	0.0229	0.0229	0.0225
Channel					26840	26915	26990	ERP(W)			
Frequency (MHz)					829	836.5	844	L	M	H	
10	QPSK	1	0	22.45	22.58	22.48		0.0479	0.0493	0.0482	
10	16QAM	1	0	22.48	22.52	22.49		0.0482	0.0486	0.0483	
Channel					26815	26915	27015	ERP(W)			
Frequency (MHz)					826.5	836.5	846.5	L	M	H	
5	QPSK	1	0	22.41	22.53	22.44		0.0474	0.0488	0.0478	
5	16QAM	1	0	22.44	22.49	22.44		0.0478	0.0483	0.0478	
Channel					26815	26915	27025	ERP(W)			
Frequency (MHz)					825.5	836.5	847.5	L	M	H	
3	QPSK	1	0	22.39	22.51	22.41		0.0472	0.0485	0.0474	
3	16QAM	1	0	22.42	22.45	22.42		0.0475	0.0479	0.0475	
Channel					26797	26915	27033	ERP(W)			
Frequency (MHz)					824.7	836.5	848.3	L	M	H	
1.4	QPSK	1	0	22.35	22.47	22.36		0.0468	0.0481	0.0469	
1.4	16QAM	1	0	22.37	22.41	22.38		0.0470	0.0474	0.0471	



LTE Band 66:

BW [MHz]	Modulation	RB Size	RB Offset	Power Low Ch. / Freq.	Power Middle Ch. / Freq.	Power High Ch. / Freq.	EIRP(W)		
Channel				132072	132322	132572	EIRP(W)		
Frequency (MHz)				1720	1745	1770	L	M	H
20	QPSK	1	0	22.97	23.15	22.89	0.1766	0.1841	0.1734
20	QPSK	1	99	22.93	22.85	22.66	0.1750	0.1718	0.1644
20	QPSK	100	0	21.98	22.00	21.89	0.1406	0.1413	0.1377
20	16QAM	1	0	22.57	22.38	22.24	0.1611	0.1542	0.1493
20	64QAM	1	0	22.23	22.32	22.10	0.1489	0.1521	0.1445
20	256QAM	1	0	18.65	18.65	18.52	0.0653	0.0653	0.0634
Channel				132047	132322	132597	EIRP(W)		
Frequency (MHz)				1717.5	1745	1772.5	L	M	H
15	QPSK	1	0	22.97	23.09	22.86	0.1766	0.1816	0.1722
15	16QAM	1	0	22.40	22.51	22.25	0.1549	0.1589	0.1496
Channel				132022	132322	132622	EIRP(W)		
Frequency (MHz)				1715	1745	1775	L	M	H
10	QPSK	1	0	23.06	23.10	22.96	0.1803	0.1820	0.1762
10	16QAM	1	0	22.48	22.54	22.26	0.1578	0.1600	0.1500
Channel				131997	132322	132647	EIRP(W)		
Frequency (MHz)				1712.5	1745	1777.5	L	M	H
5	QPSK	1	0	23.12	23.10	22.94	0.1828	0.1820	0.1754
5	16QAM	1	0	22.53	22.55	22.36	0.1596	0.1603	0.1535
Channel				131987	132322	132657	EIRP(W)		
Frequency (MHz)				1711.5	1745	1778.5	L	M	H
3	QPSK	1	0	23.03	23.11	22.85	0.1791	0.1824	0.1718
3	16QAM	1	0	22.45	22.57	22.31	0.1567	0.1611	0.1517
Channel				131979	132322	132665	EIRP(W)		
Frequency (MHz)				1710.7	1745	1779.3	L	M	H
1.4	QPSK	1	0	23.14	23.06	22.92	0.1837	0.1803	0.1746
1.4	16QAM	1	0	22.49	22.56	22.25	0.1581	0.1607	0.1496



LTE Band 12

Peak-to-Average Ratio

Mode	LTE Band 12 / 10MHz				
Mod.	QPSK	16QAM	64QAM	256 QAM	Limit: 13dB
RB Size	Full RB	Full RB	Full RB	Full RB	Result
Middle CH	4.78	5.48	6.06	6.58	PASS

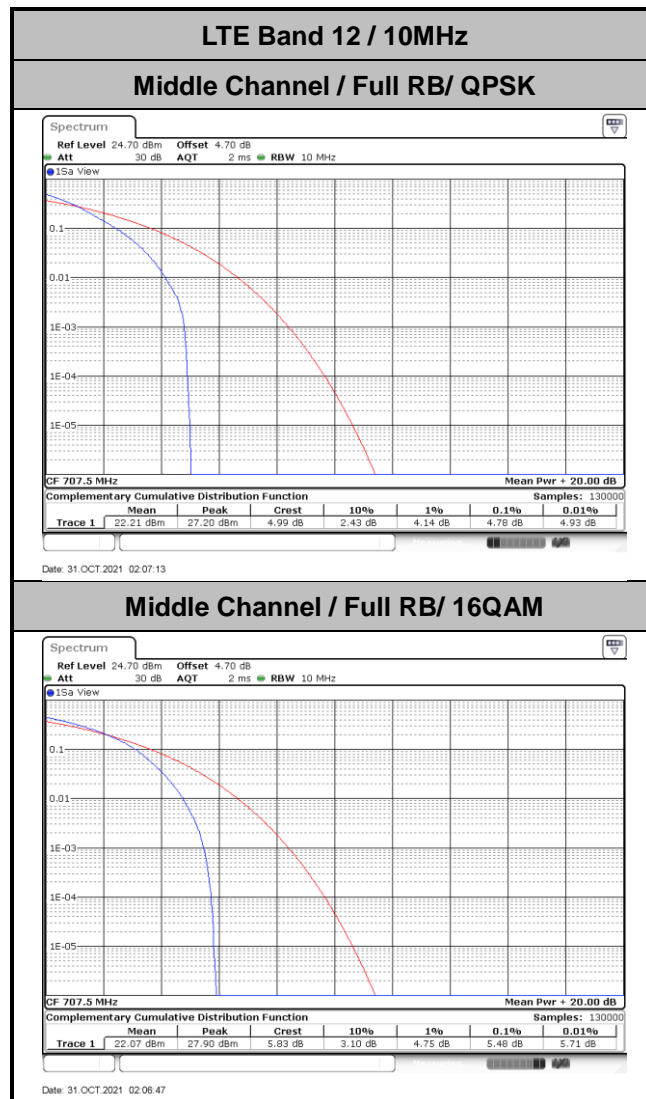

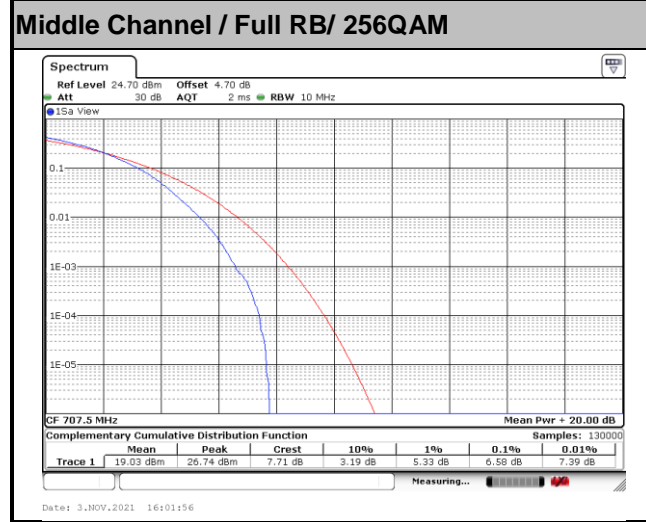
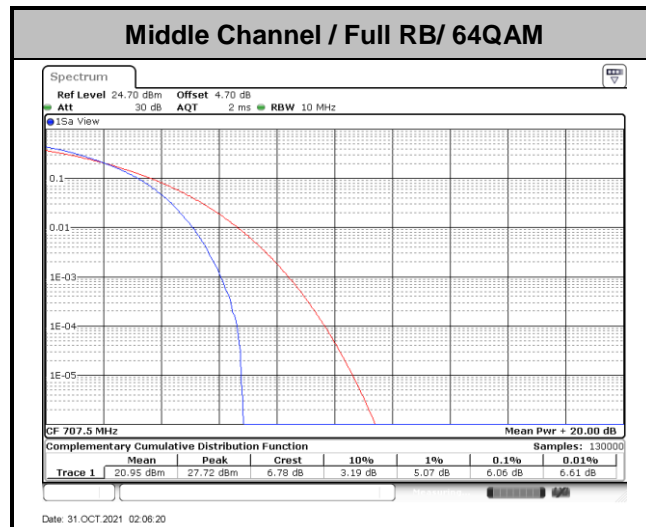



26dB Bandwidth

Mode	LTE Band 12 : 26dB BW(MHz)	
BW	10MHz	
Mod.	QPSK	16QAM
Middle CH	10.03	9.89

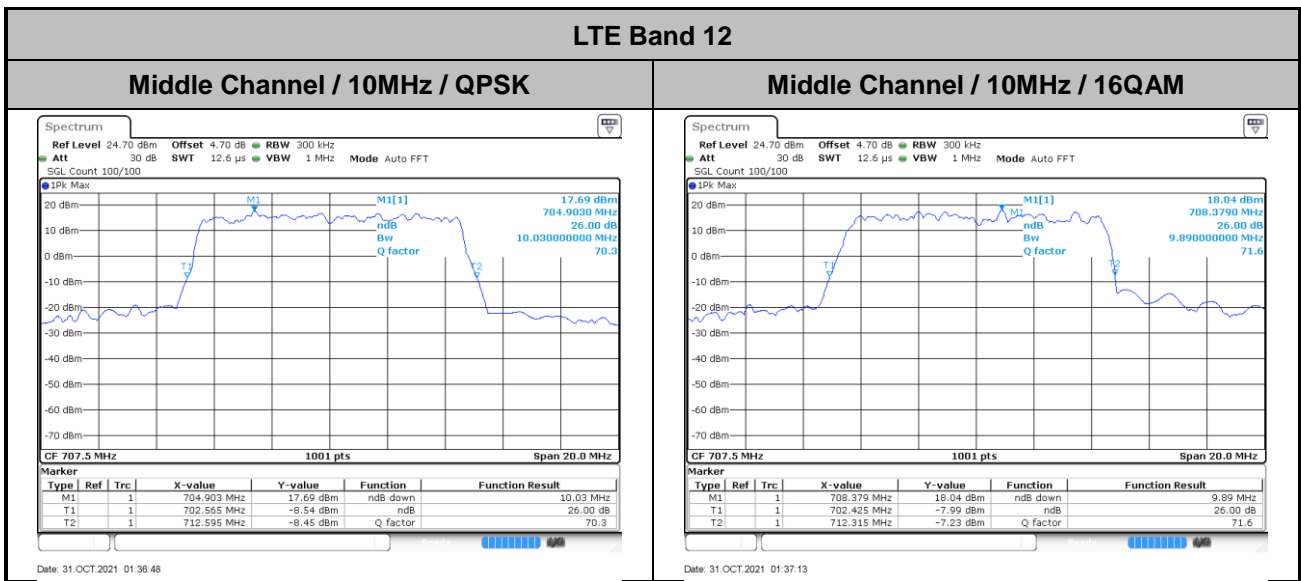



Occupied Bandwidth

Mode	LTE Band 12 : 99%OBW(MHz)	
BW	10MHz	
Mod.	QPSK	16QAM
Middle CH	9.05	9.01

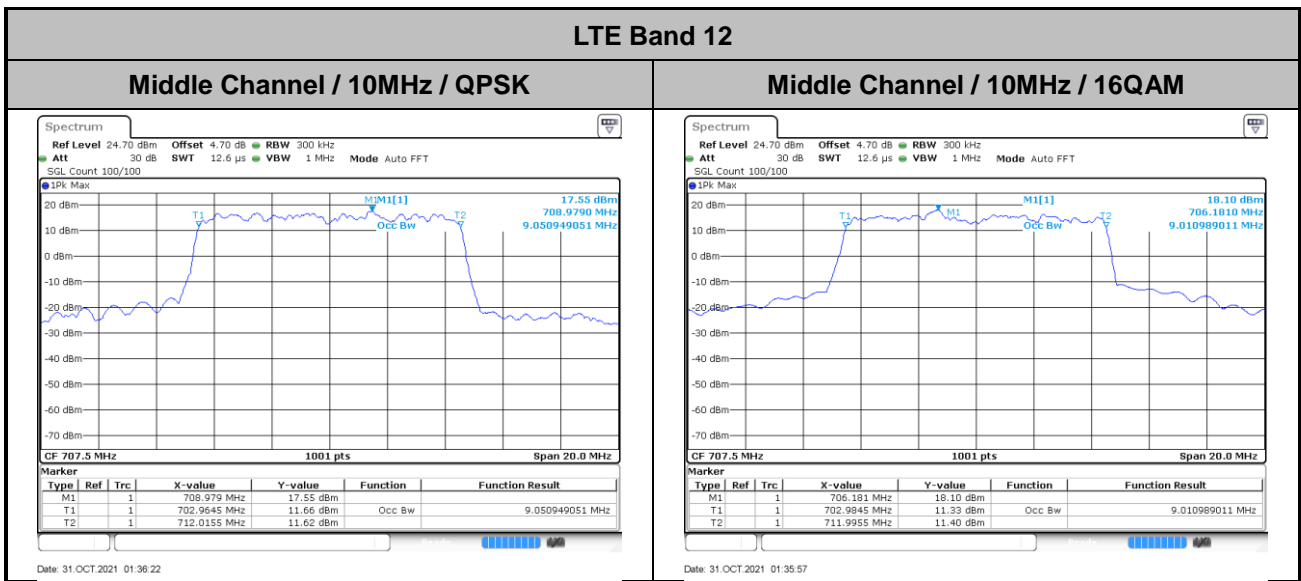



Conducted Band Edge

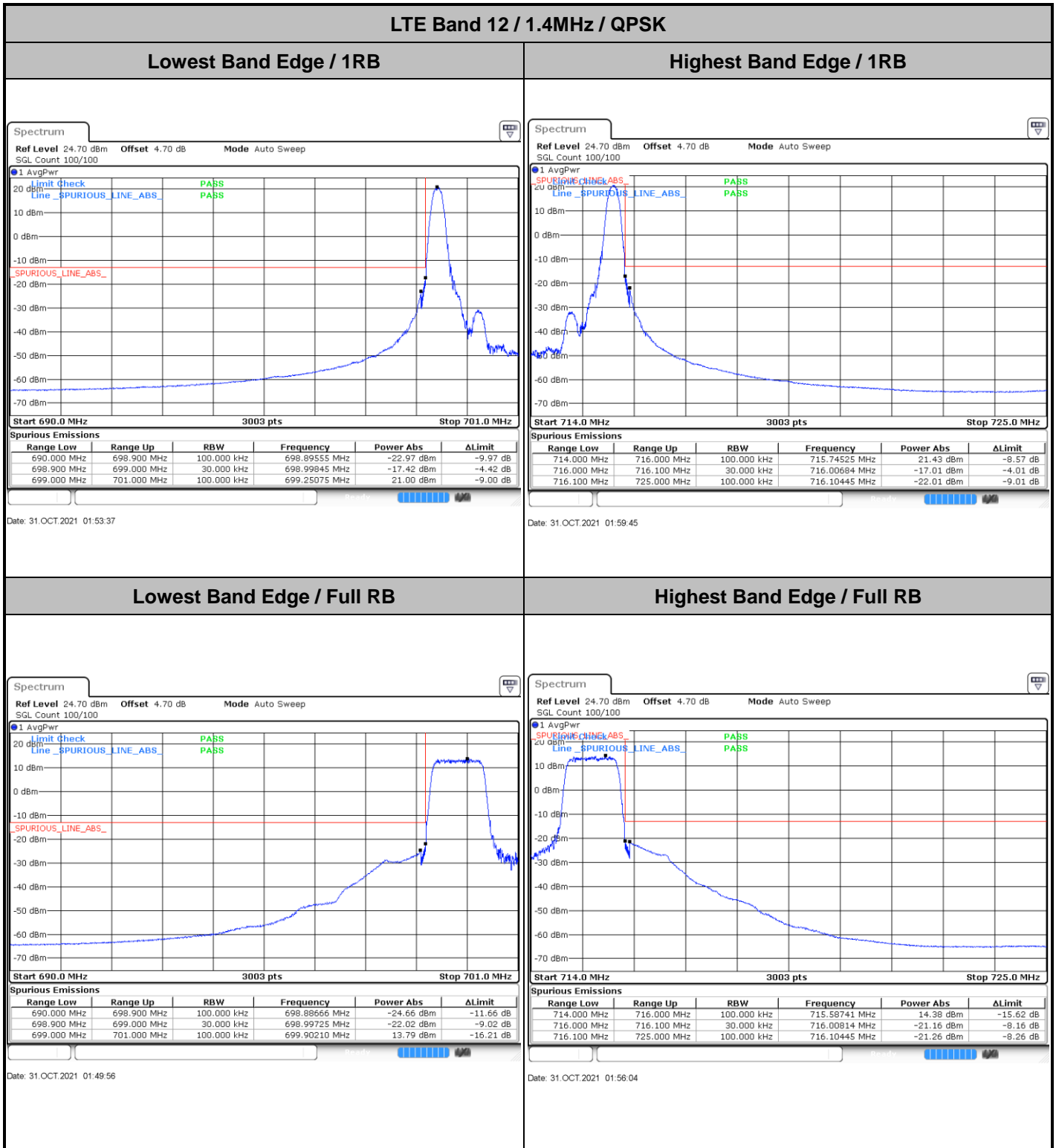



LTE Band 12 / 1.4MHz / 16QAM

Lowest Band Edge / 1 RB

Highest Band Edge / 1 RB

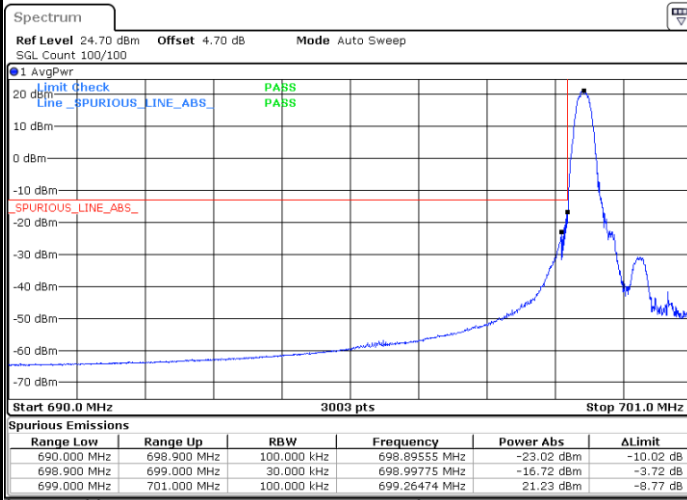

Date: 31.OCT.2021 01:52:23

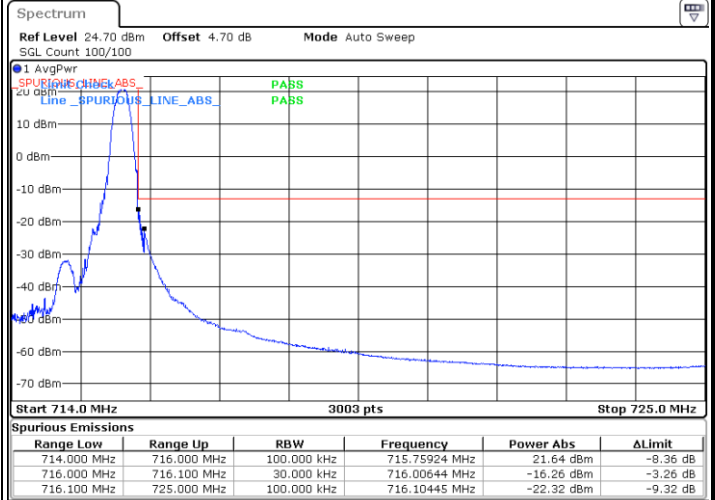

Date: 31.OCT.2021 01:58:31

Lowest Band Edge / Full RB

Highest Band Edge / Full RB

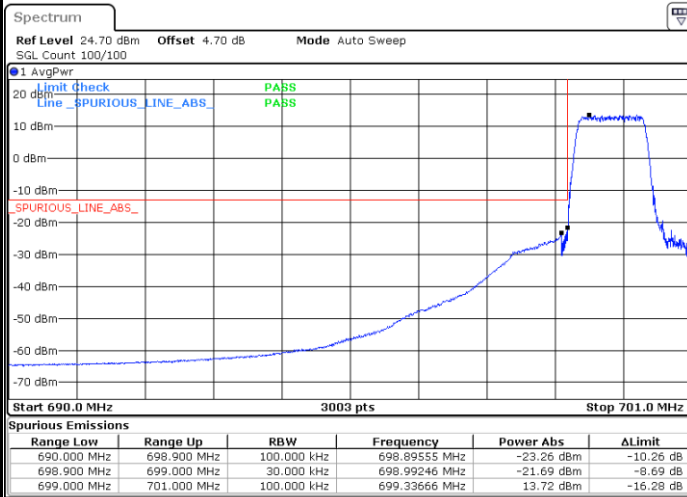

Date: 31.OCT.2021 01:51:10



Date: 31.OCT.2021 01:57:18



LTE Band 12 / 1.4MHz / 64QAM

Lowest Band Edge / 1 RB

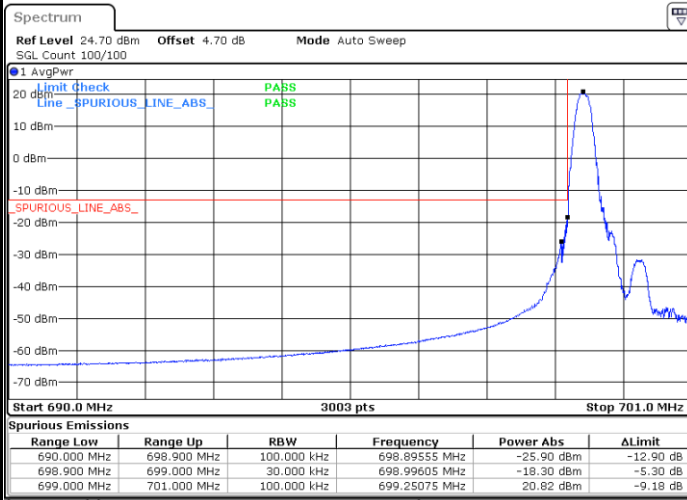

Date: 31.OCT.2021 02:02:50

Highest Band Edge / 1 RB

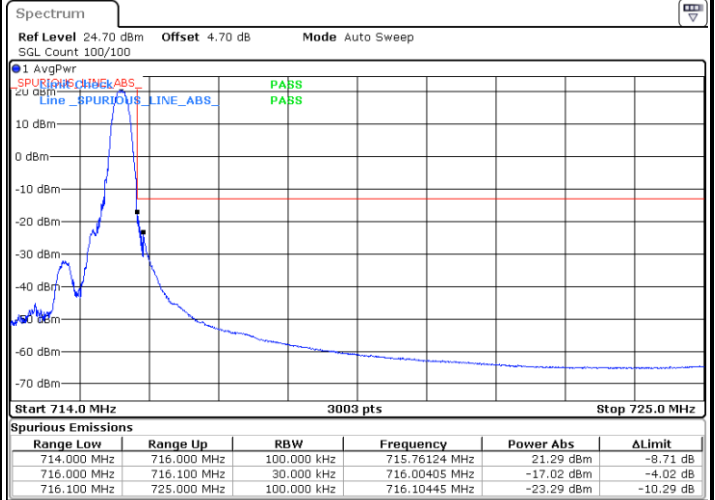

Date: 31.OCT.2021 02:05:54

Lowest Band Edge / Full RB

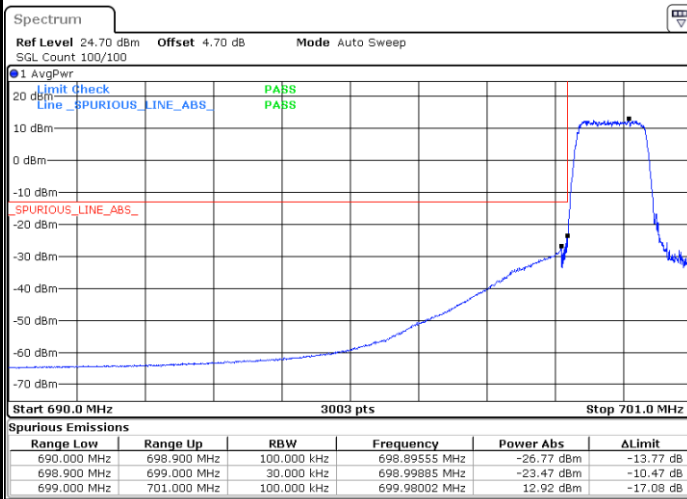

Date: 31.OCT.2021 02:01:36

Highest Band Edge / Full RB

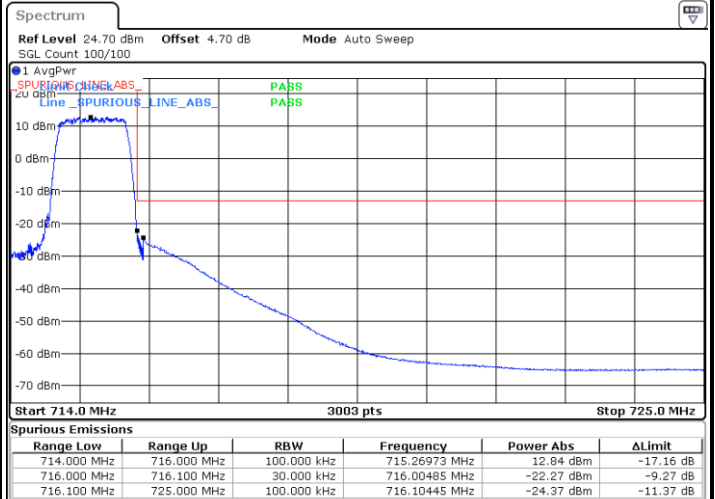

Date: 31.OCT.2021 02:04:40



LTE Band 12 / 1.4MHz /256QAM

Lowest Band Edge / 1 RB

Highest Band Edge / 1 RB

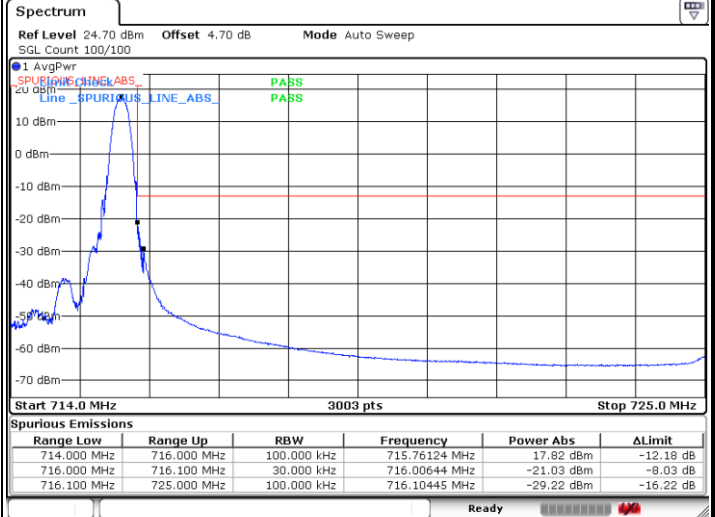
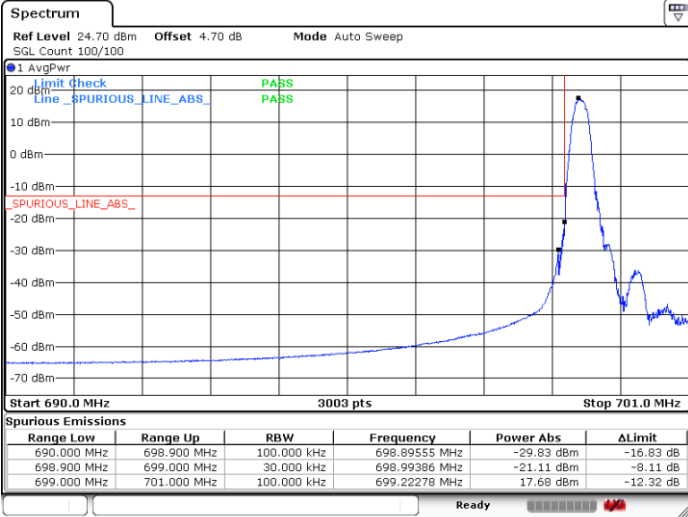

Date: 3.NOV.2021 15:15:41

Date: 3.NOV.2021 15:42:21

Lowest Band Edge / Full RB

Highest Band Edge / Full RB

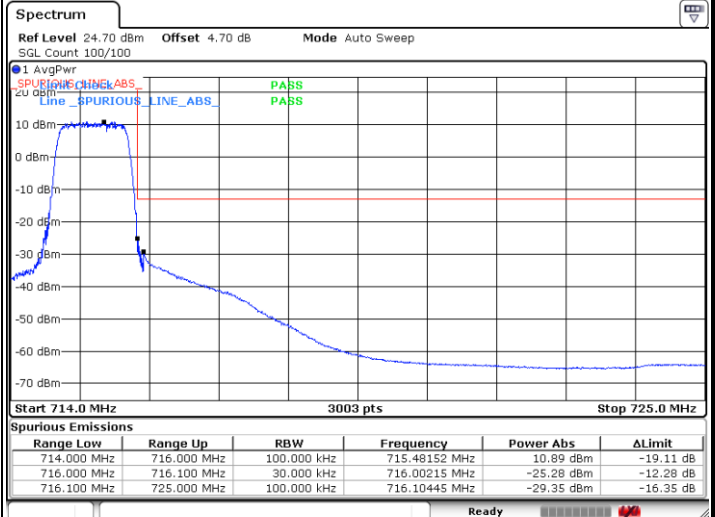
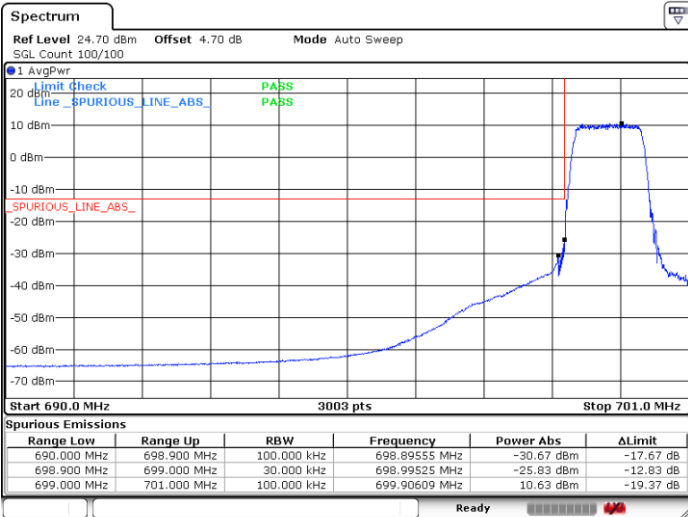

Date: 3.NOV.2021 15:17:05

Date: 3.NOV.2021 15:21:20



LTE Band 12 / 3MHz / QPSK

Lowest Band Edge / 1RB

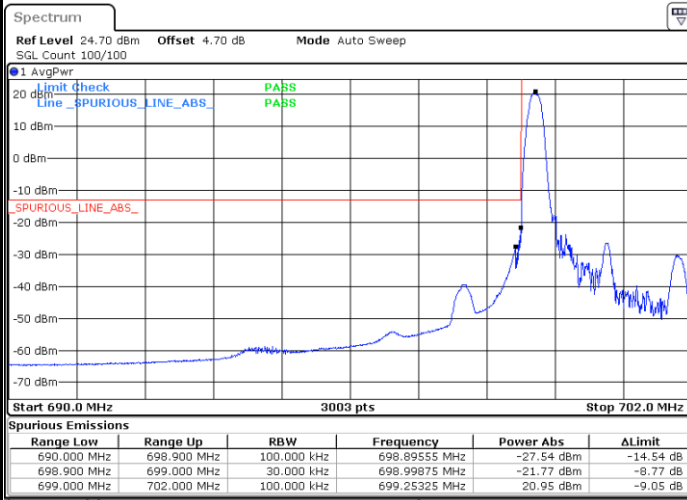

Date: 31.OCT.2021 01:01:43

Highest Band Edge / 1 RB

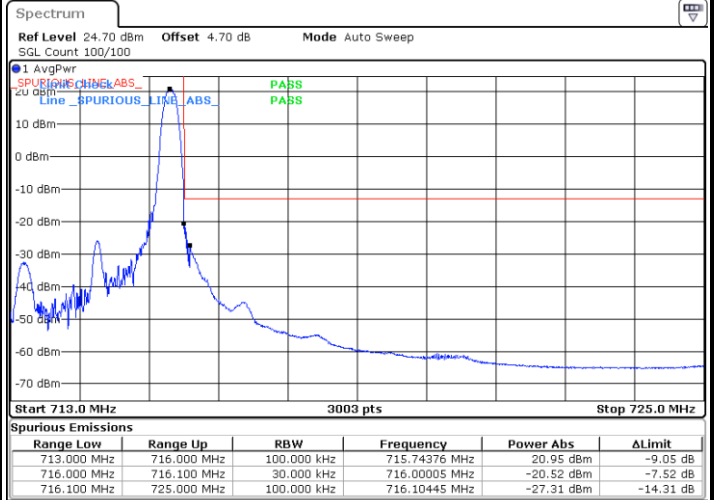

Date: 31.OCT.2021 01:07:51

Lowest Band Edge / Full RB

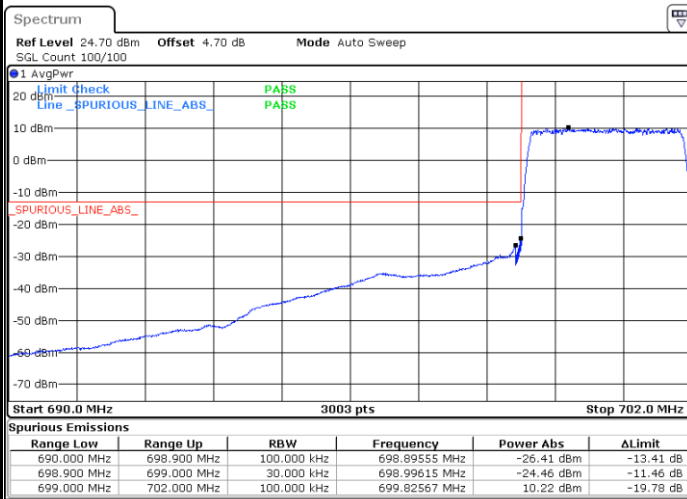

Date: 31.OCT.2021 00:58:02

Highest Band Edge / Full RB

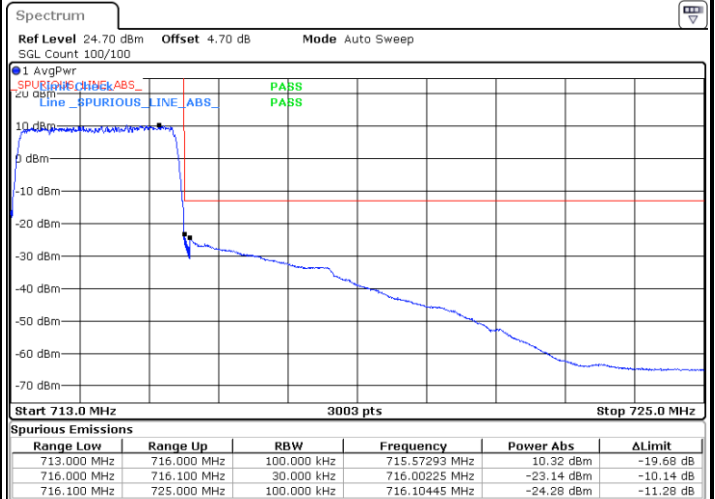

Date: 31.OCT.2021 01:04:10



LTE Band 12 / 3MHz / 16QAM

Lowest Band Edge / 1 RB

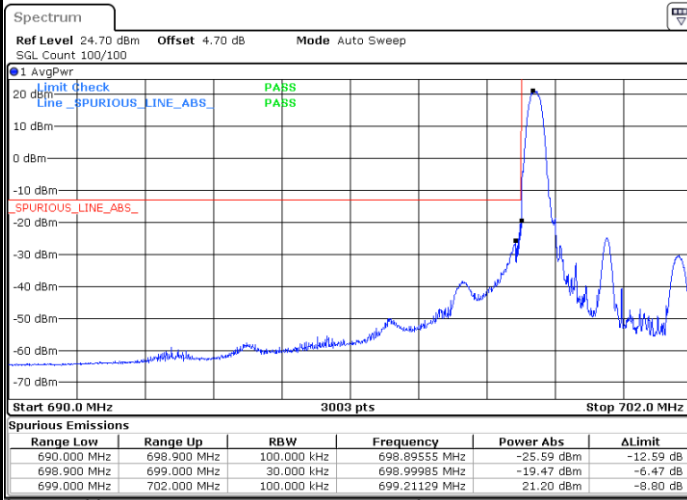

Date: 31.OCT.2021 01:00:29

Highest Band Edge / 1 RB



Date: 31.OCT.2021 01:06:37

Lowest Band Edge / Full RB

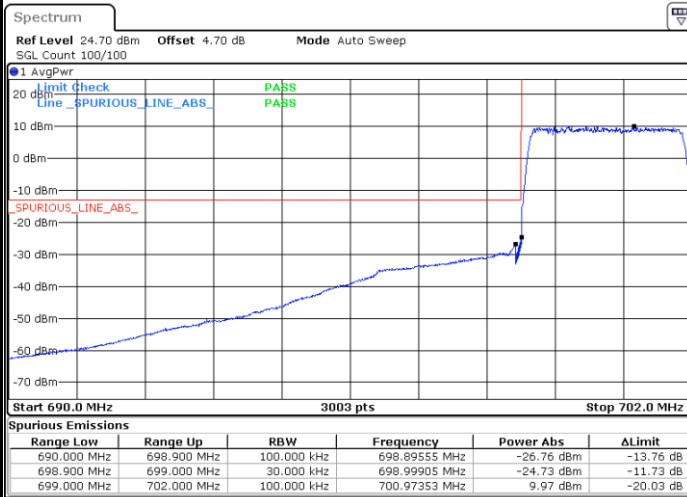

Date: 31.OCT.2021 00:59:16

Highest Band Edge / Full RB

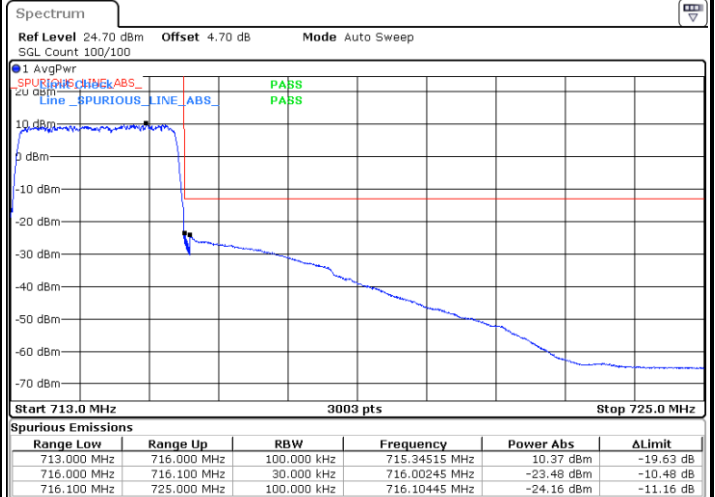

Date: 31.OCT.2021 01:05:23



LTE Band 12 / 3MHz / 64QAM

Lowest Band Edge / 1 RB

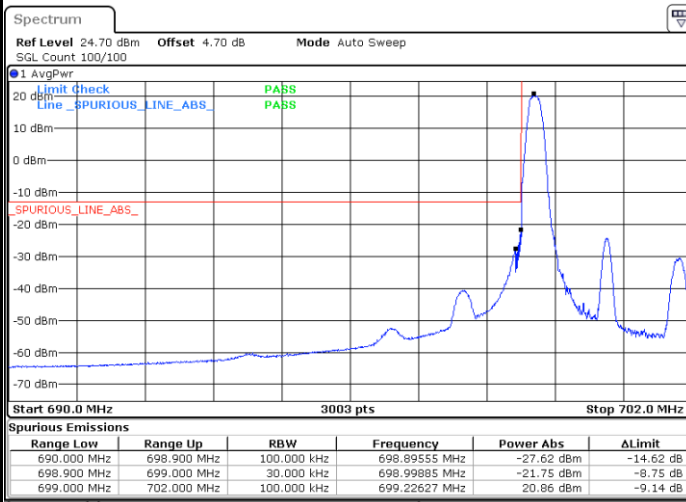

Date: 31.OCT.2021 01:10:56

Highest Band Edge / 1 RB

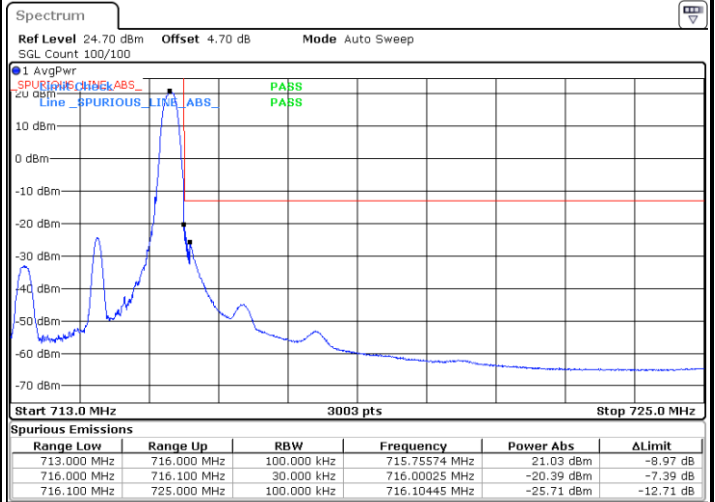

Date: 31.OCT.2021 01:13:23

Lowest Band Edge / Full RB

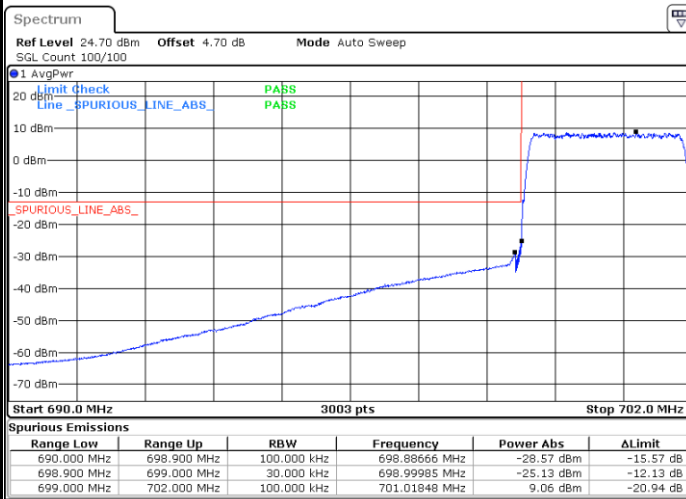

Date: 31.OCT.2021 01:09:42

Highest Band Edge / Full RB

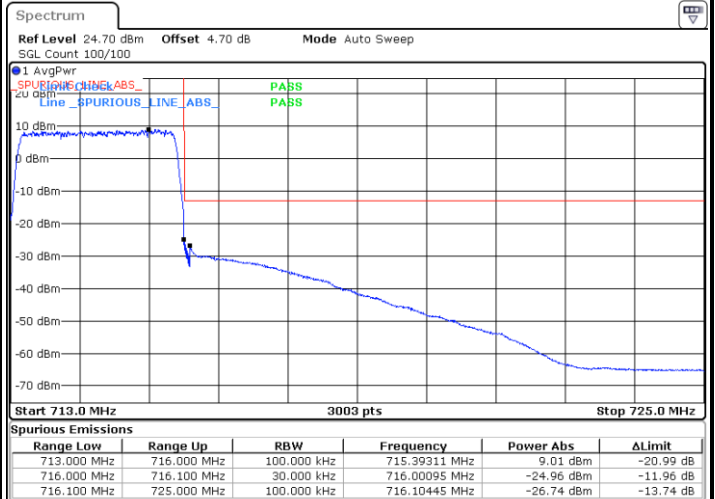

Date: 31.OCT.2021 01:12:10



LTE Band 12 / 3MHz / 256QAM

Lowest Band Edge / 1 RB

Highest Band Edge / 1 RB

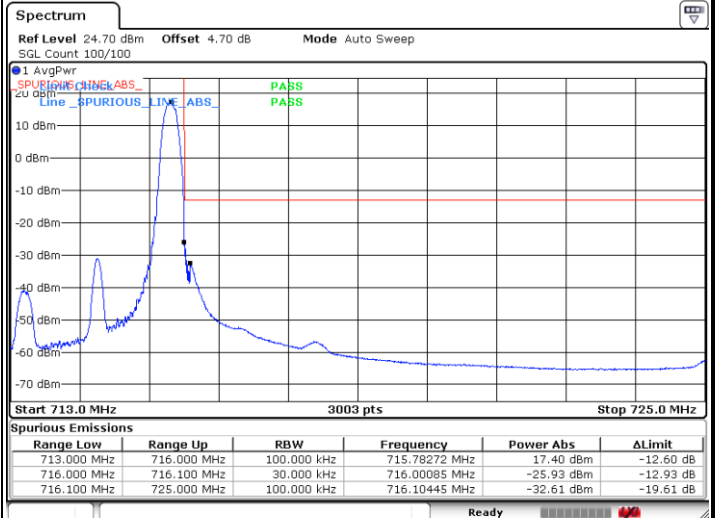
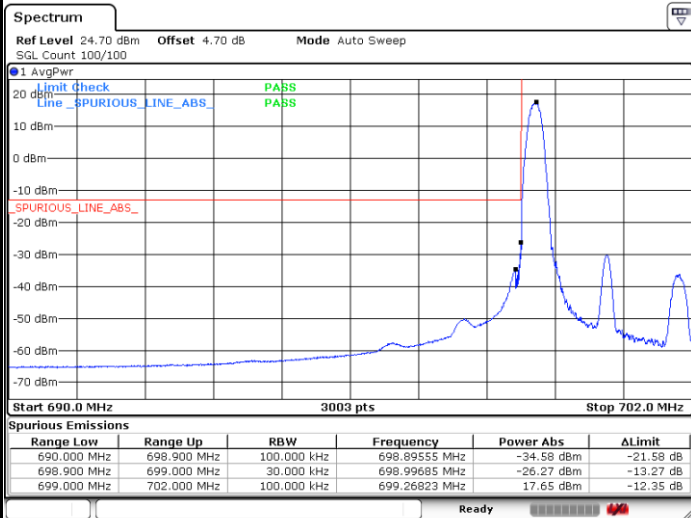

Date: 3.NOV.2021 15:39:59

Date: 3.NOV.2021 15:36:37

Lowest Band Edge / Full RB

Highest Band Edge / Full RB

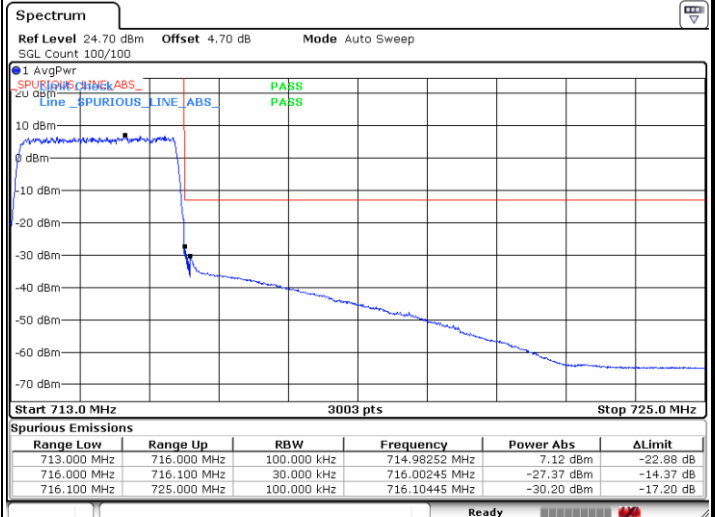
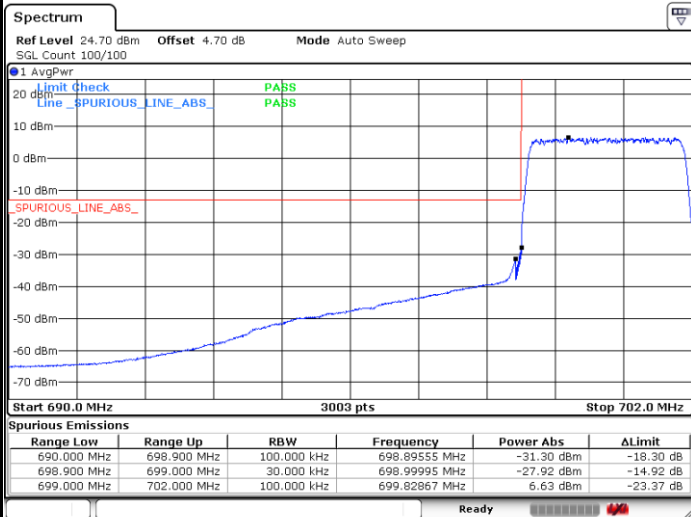

Date: 3.NOV.2021 15:38:36

Date: 3.NOV.2021 15:37:12



LTE Band 12 / 5MHz / QPSK

Lowest Band Edge / 1 RB

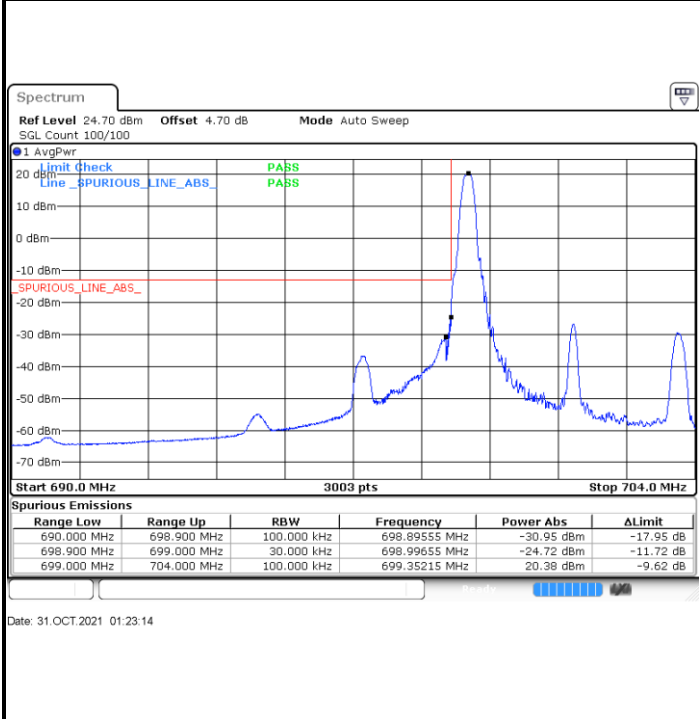

Highest Band Edge / 1 RB

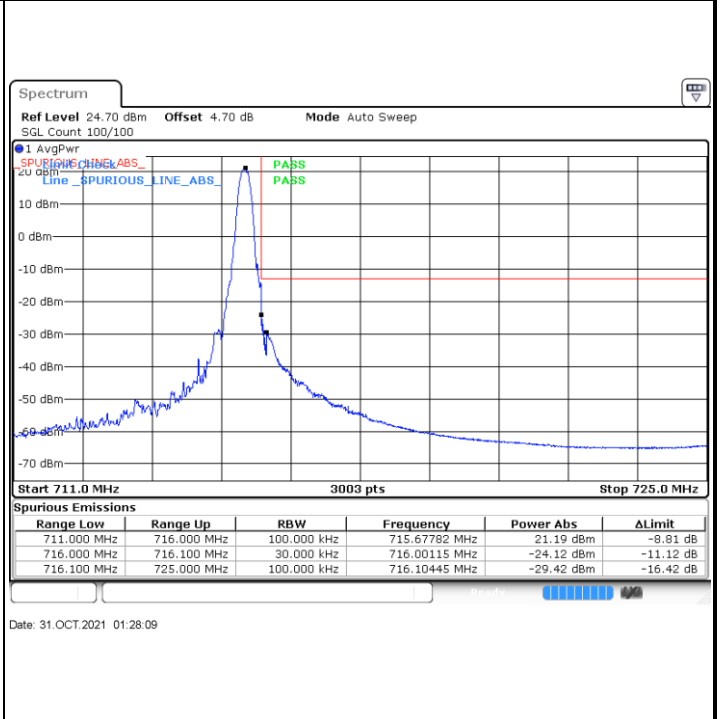

Lowest Band Edge / Full RB

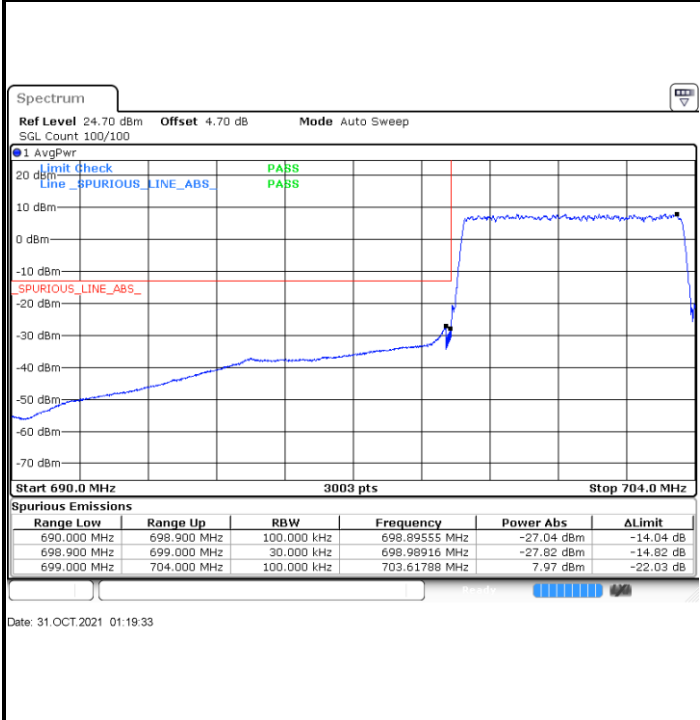

Highest Band Edge / Full RB

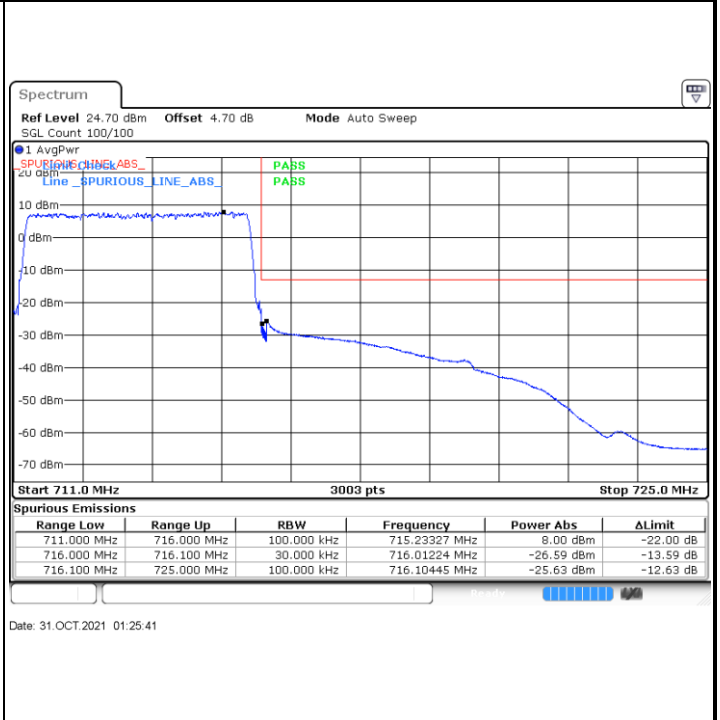



LTE Band 12 / 5MHz / 16QAM

Lowest Band Edge / 1RB

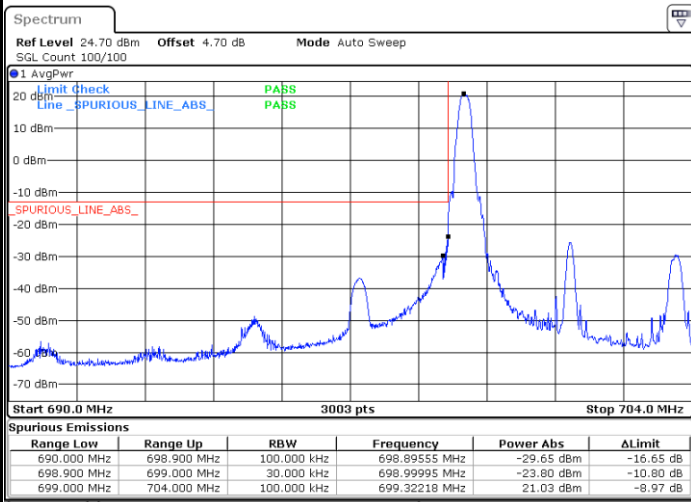

Date: 31.OCT.2021 01:22:00

Highest Band Edge / 1 RB

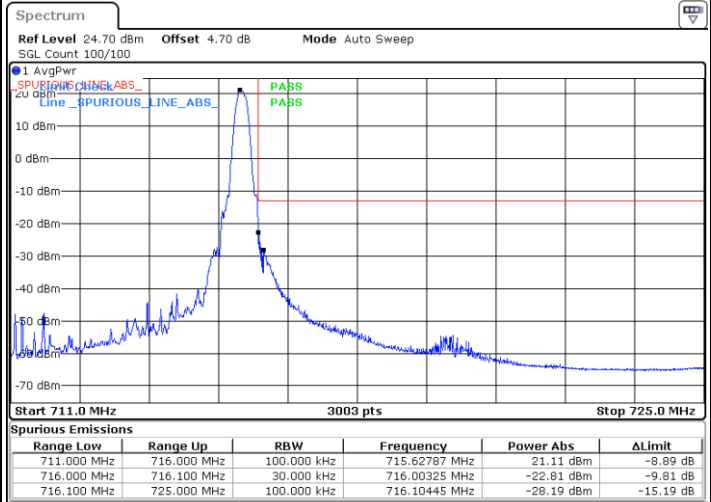

Date: 31.OCT.2021 01:29:23

Lowest Band Edge / Full RB

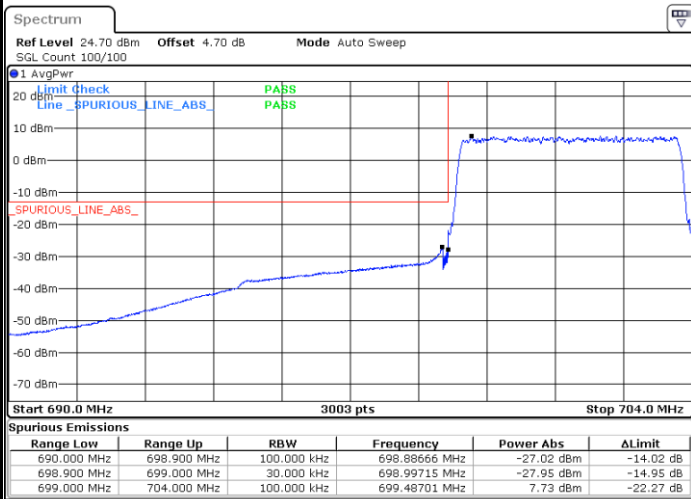

Date: 31.OCT.2021 01:20:47

Highest Band Edge / Full RB

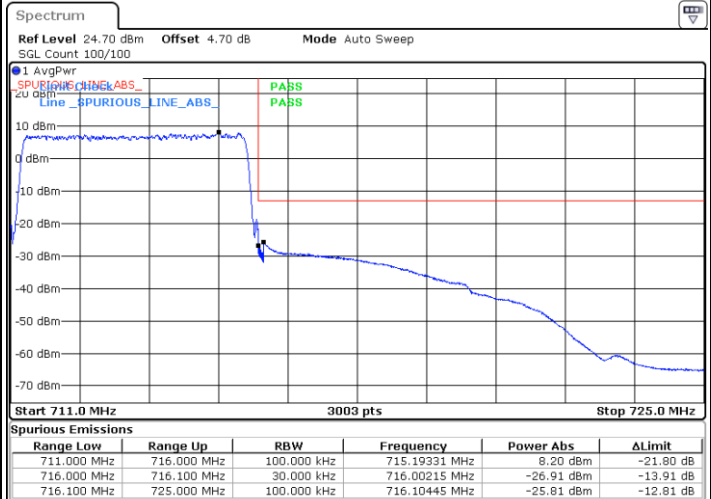

Date: 31.OCT.2021 01:26:55



LTE Band 12 / 5MHz / 64QAM

Lowest Band Edge / 1RB

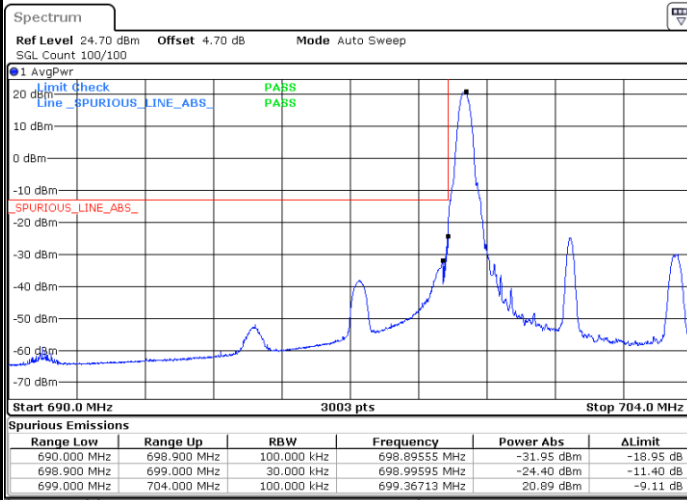

Date: 31.OCT.2021 01:15:51

Highest Band Edge / 1 RB

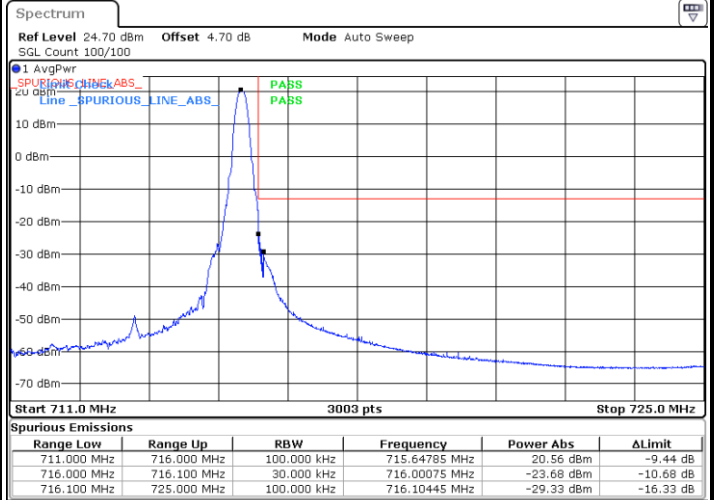

Date: 31.OCT.2021 01:18:19

Lowest Band Edge / Full RB

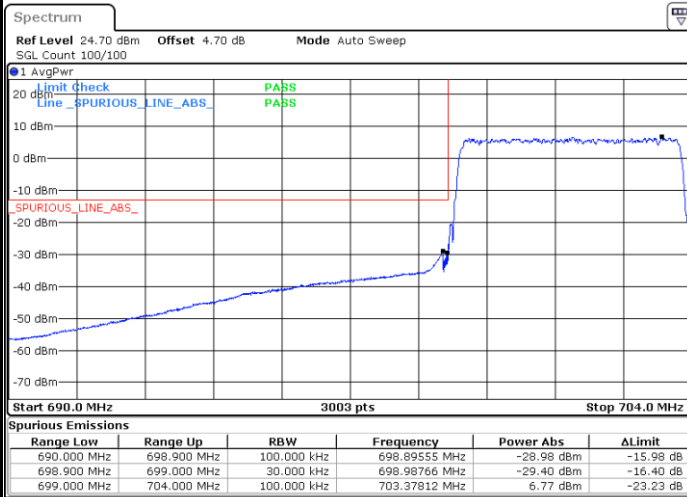

Date: 31.OCT.2021 01:14:38

Highest Band Edge / Full RB

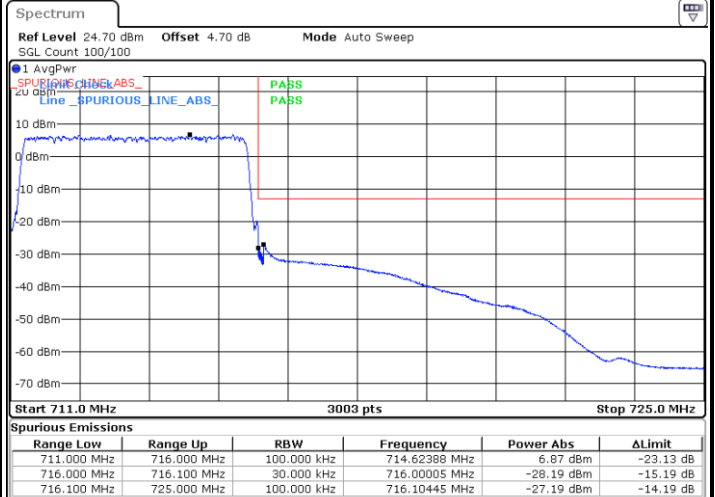

Date: 31.OCT.2021 01:17:05



LTE Band 12 / 5MHz / 256QAM

Lowest Band Edge / 1RB

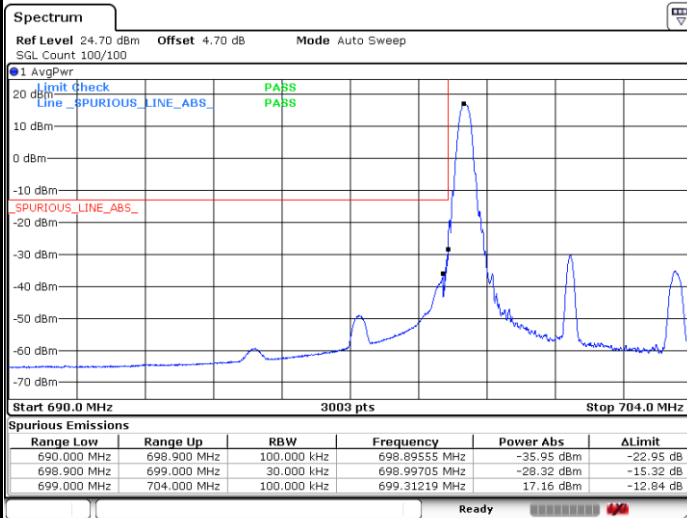

Date: 3.NOV.2021 15:48:01

Highest Band Edge / 1 RB

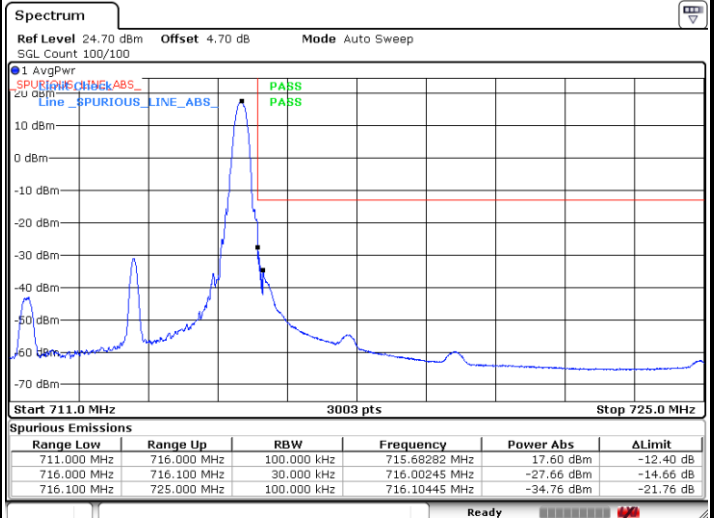

Date: 3.NOV.2021 15:51:24

Lowest Band Edge / Full RB

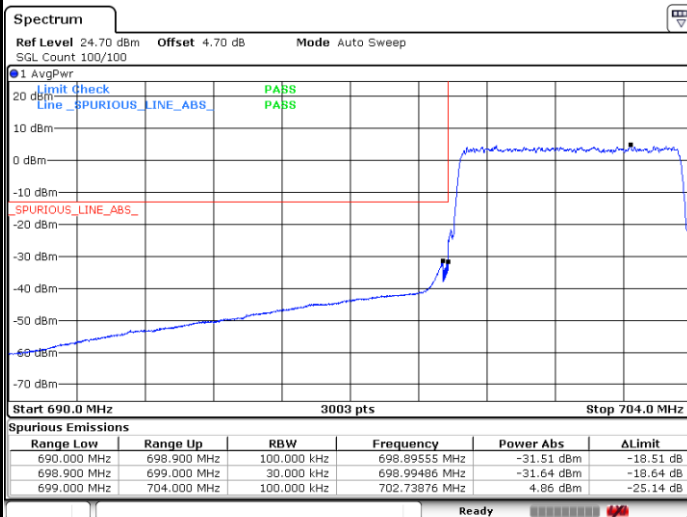

Date: 3.NOV.2021 15:46:46

Highest Band Edge / Full RB

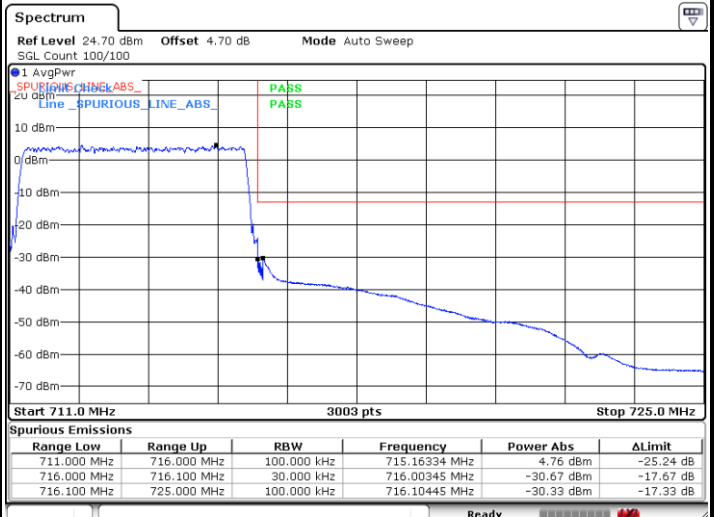

Date: 3.NOV.2021 15:50:04



LTE Band 12 / 10MHz / QPSK

Lowest Band Edge / 1 RB

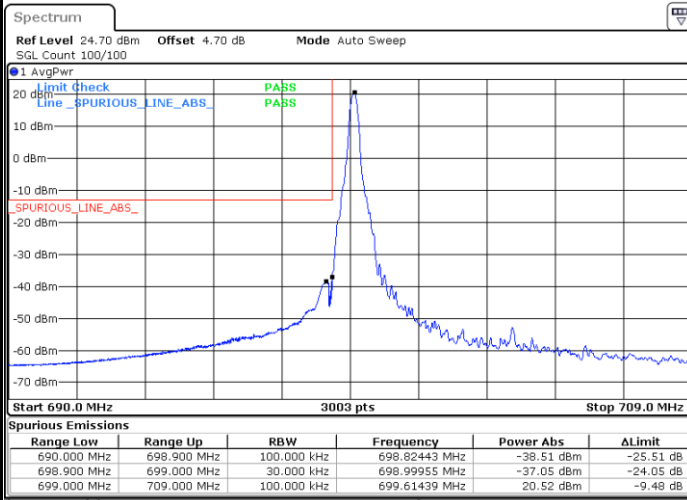

Date: 31.OCT.2021 01:34:55

Highest Band Edge / 1 RB

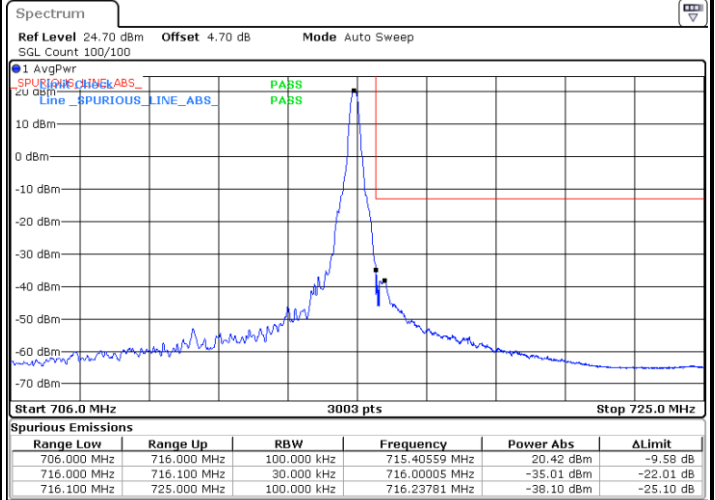

Date: 31.OCT.2021 01:42:45

Lowest Band Edge / Full RB

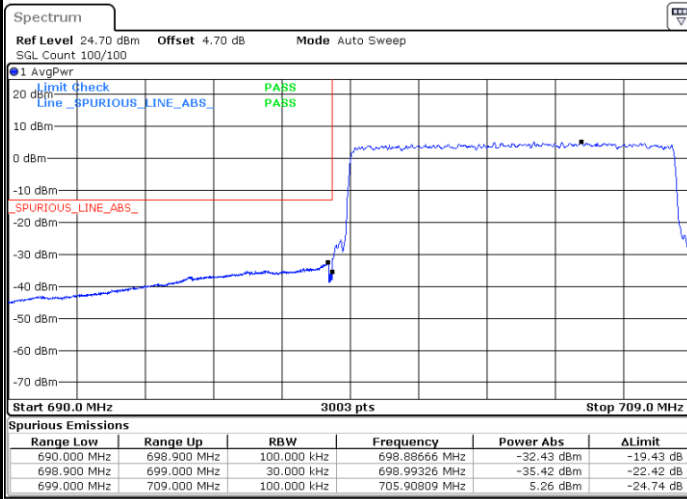

Date: 31.OCT.2021 01:31:14

Highest Band Edge / Full RB

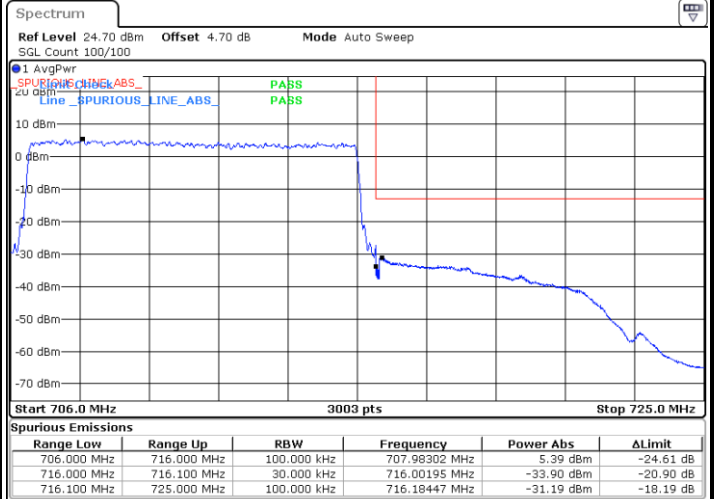

Date: 31.OCT.2021 01:39:03



LTE Band 12 / 10MHz / 16QAM

Lowest Band Edge / 1 RB

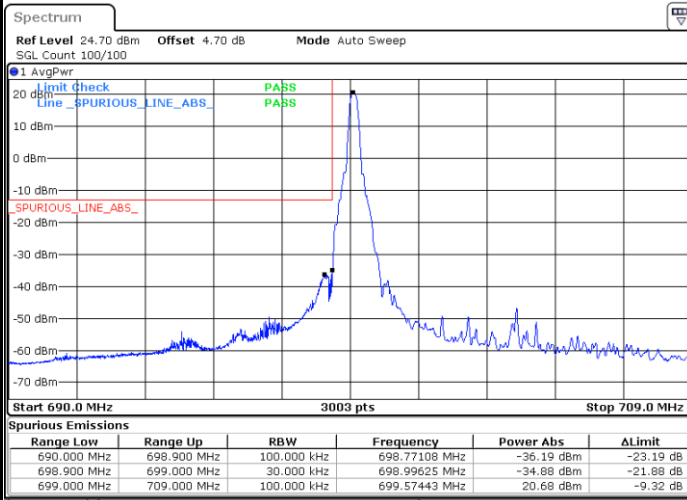

Date: 31.OCT.2021 01:33:41

Highest Band Edge / 1 RB

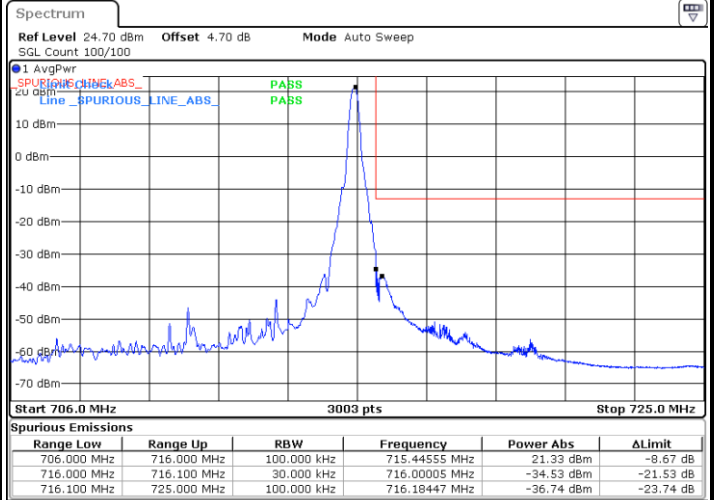

Date: 31.OCT.2021 01:41:31

Lowest Band Edge / Full RB

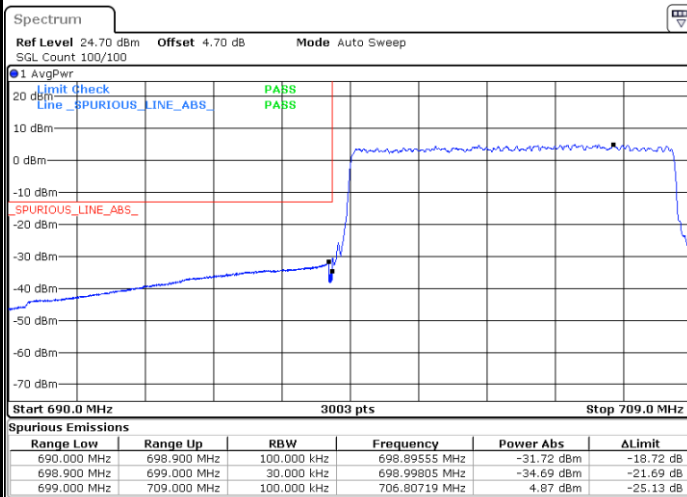

Date: 31.OCT.2021 01:32:27

Highest Band Edge / Full RB

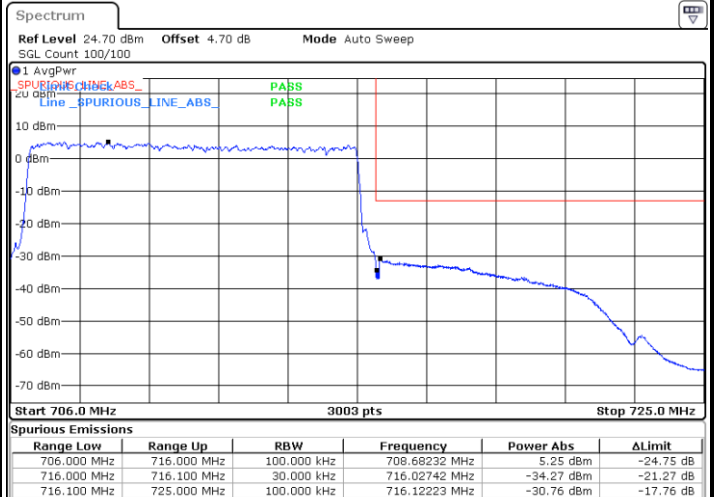

Date: 31.OCT.2021 01:40:17



LTE Band 12 / 10MHz / 64QAM

Lowest Band Edge / 1 RB

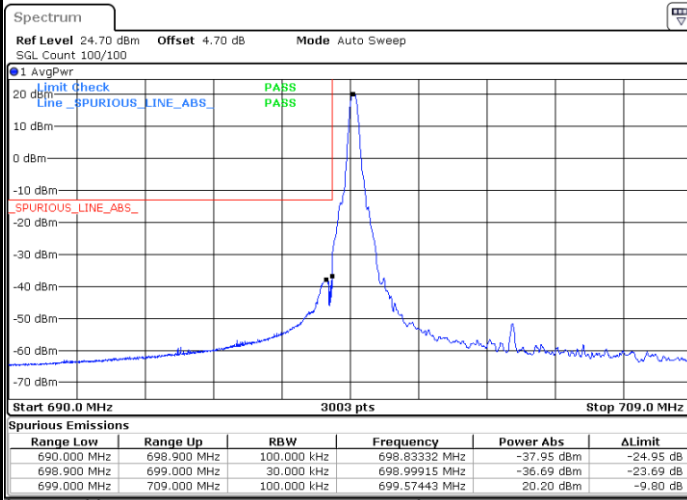

Date: 31.OCT.2021 01:45:49

Highest Band Edge / 1 RB

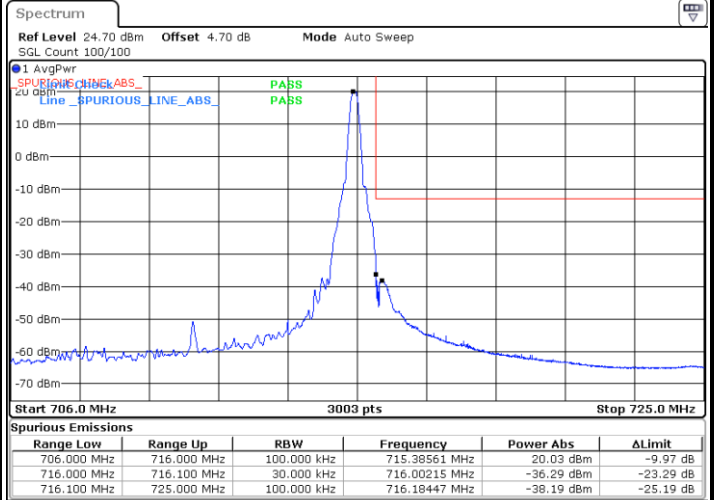

Date: 31.OCT.2021 01:48:17

Lowest Band Edge / Full RB

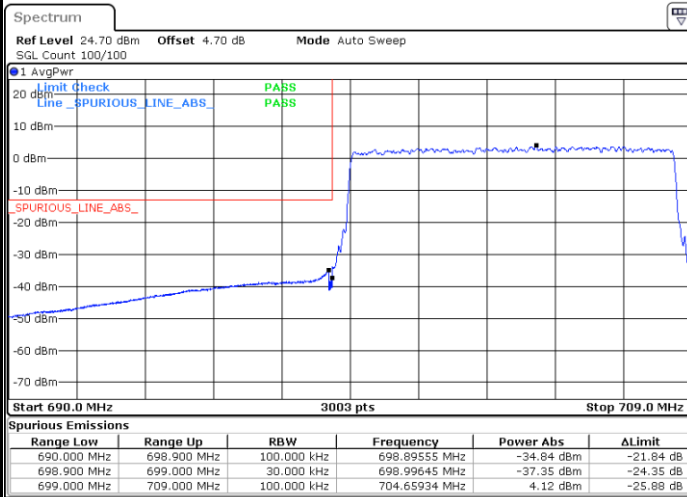

Date: 31.OCT.2021 01:44:36

Highest Band Edge / Full RB

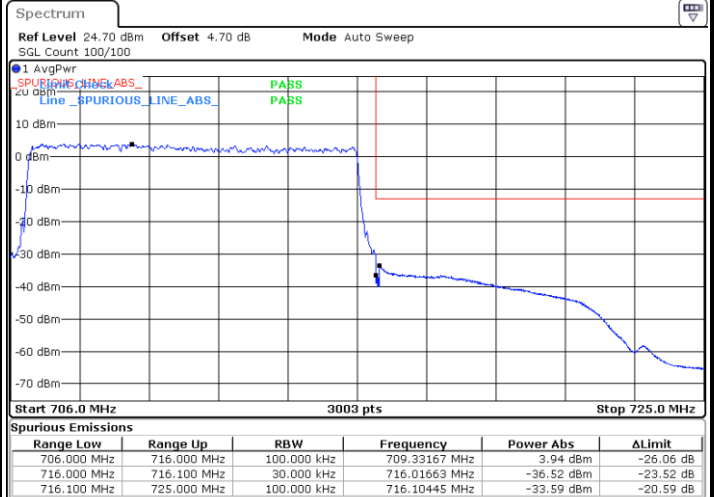

Date: 31.OCT.2021 01:47:03



LTE Band 12 / 10MHz / 256QAM

Lowest Band Edge / 1 RB

Highest Band Edge / 1 RB

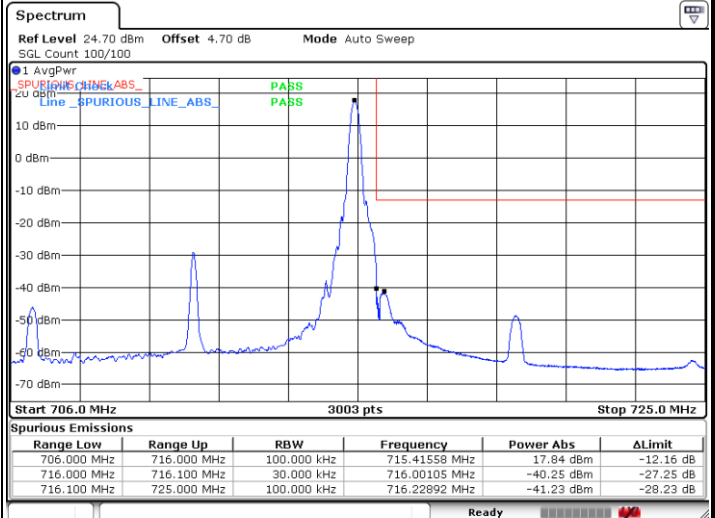
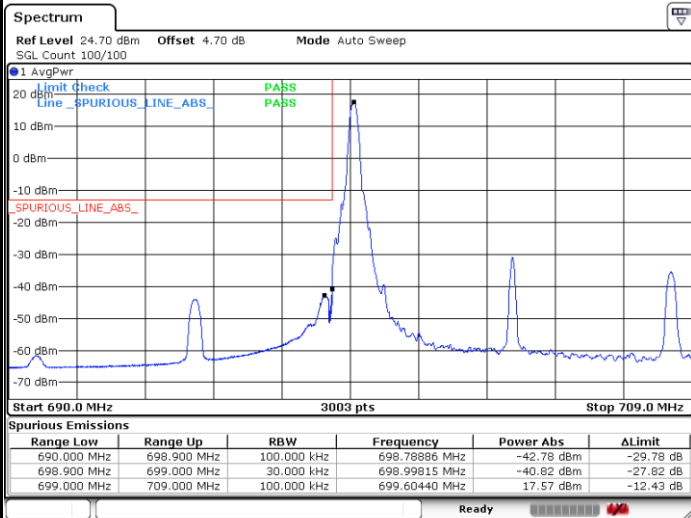

Lowest Band Edge / Full RB

Highest Band Edge / Full RB

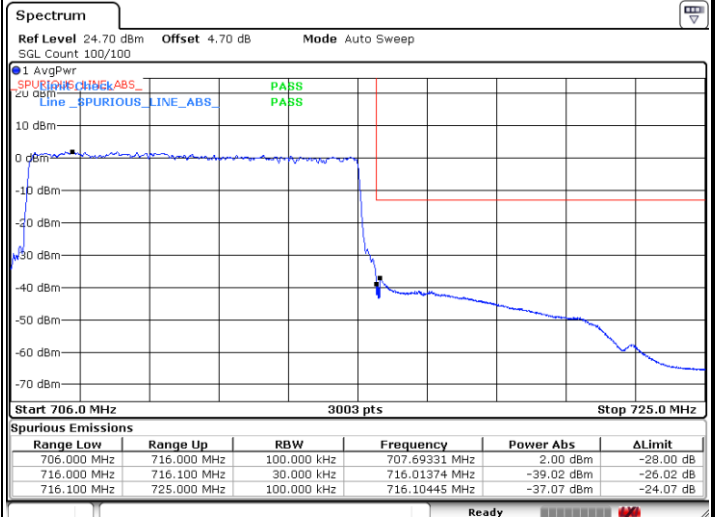
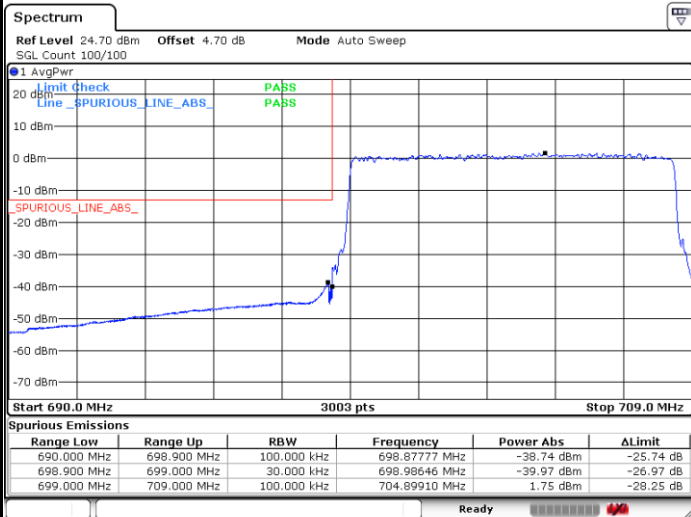



Conducted Spurious Emission

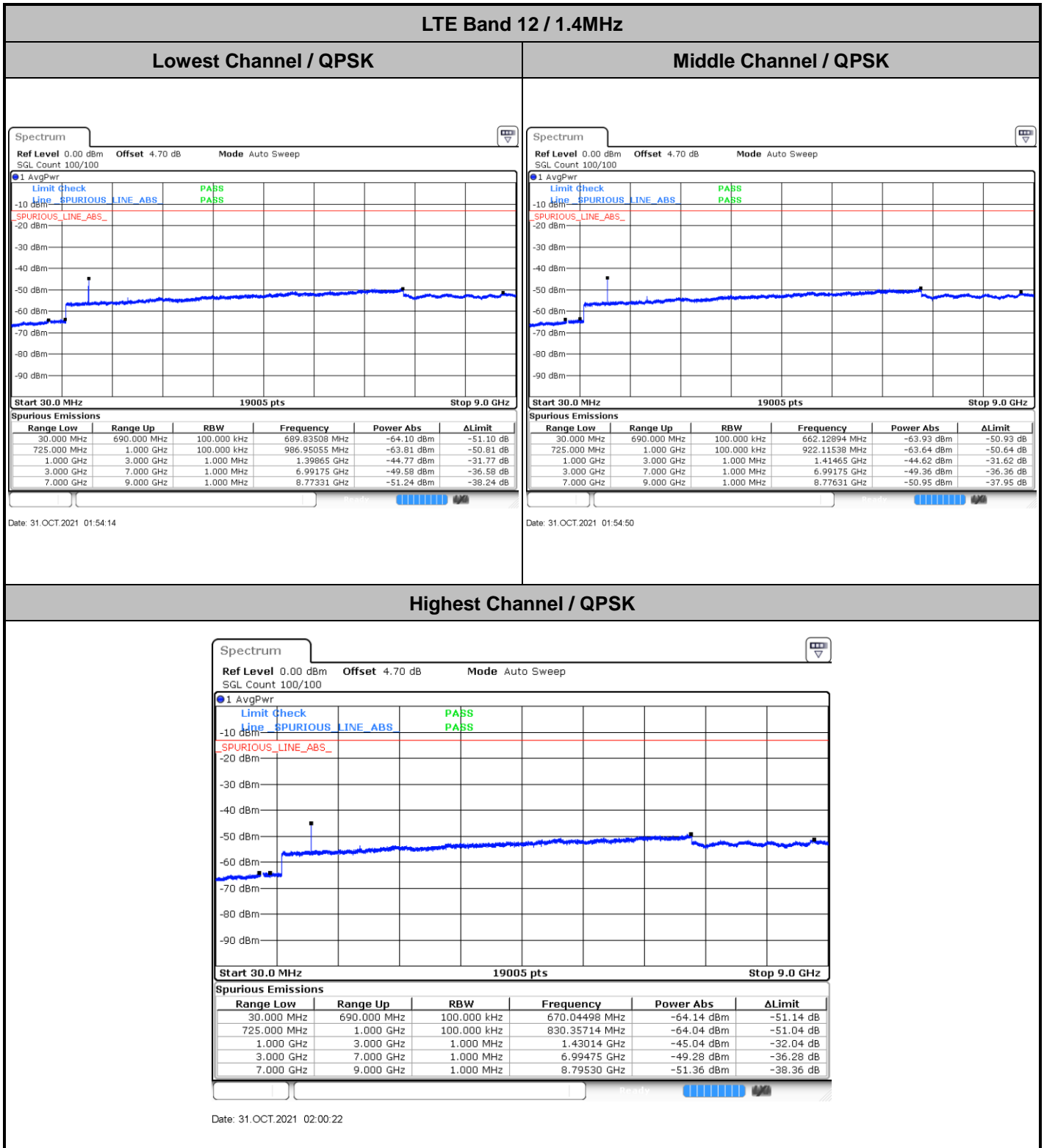



LTE Band 12 / 3MHz

Lowest Channel / QPSK

Middle Channel / QPSK

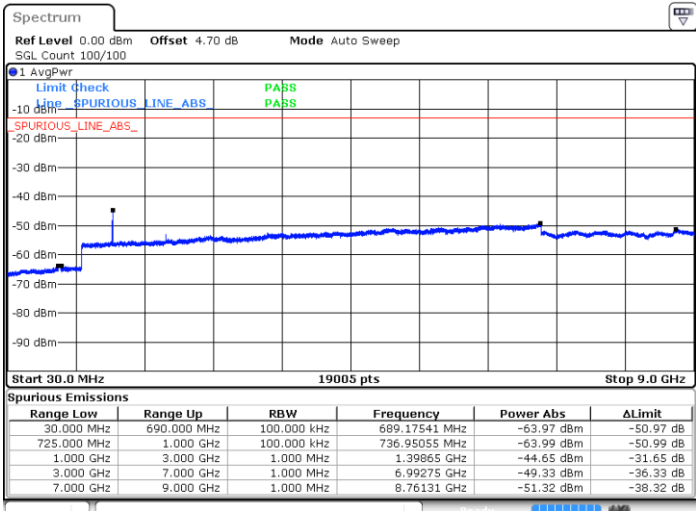

Date: 31.OCT.2021 01:02:20

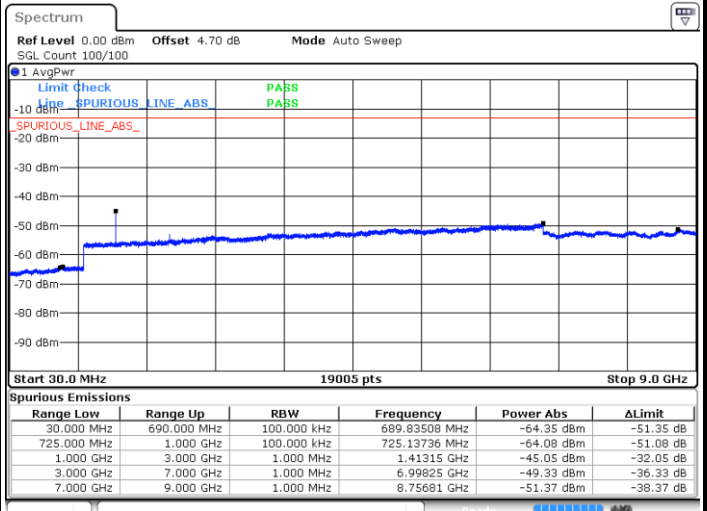

Date: 31.OCT.2021 01:02:56

Highest Channel / QPSK

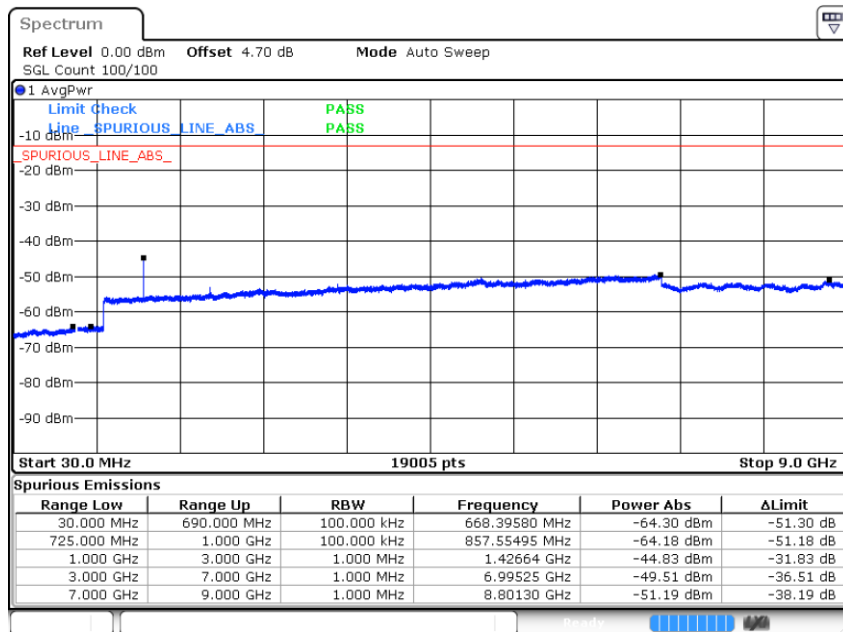

Date: 31.OCT.2021 01:08:28



LTE Band 12 / 5MHz

Lowest Channel / QPSK

Middle Channel / QPSK

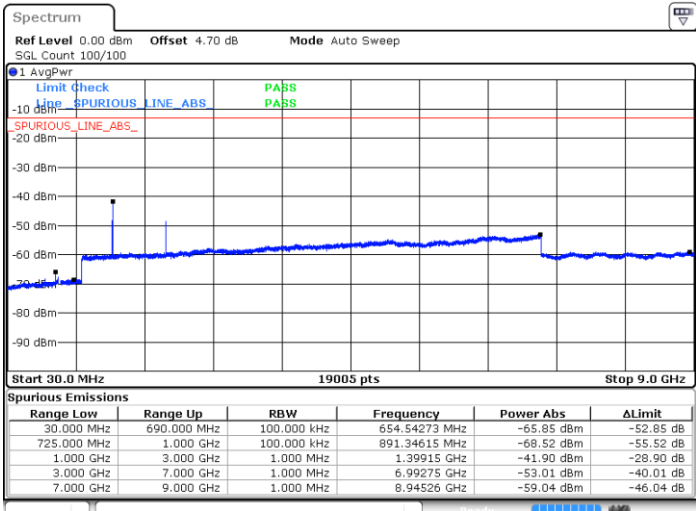

Date: 31.OCT.2021 01:23:51

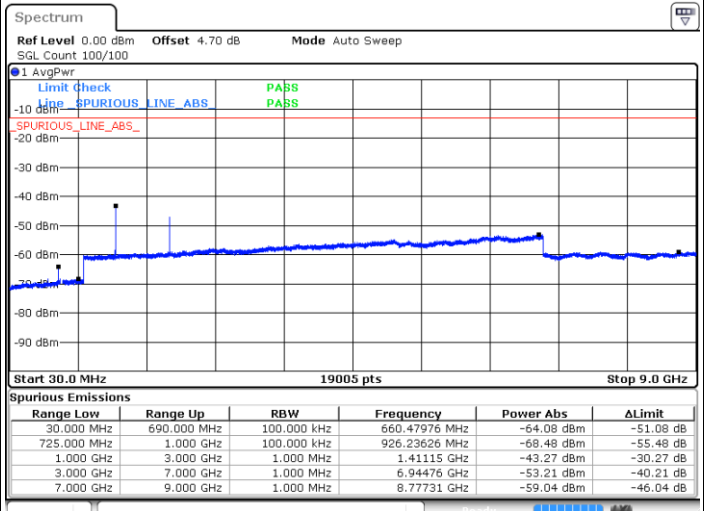

Date: 31.OCT.2021 01:24:27

Highest Channel / QPSK

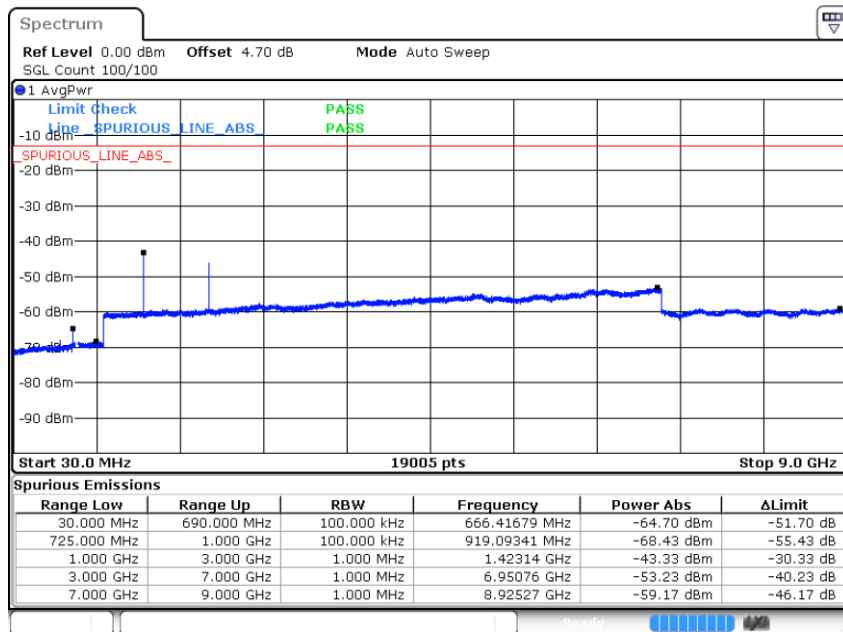

Date: 31.OCT.2021 01:29:59



LTE Band 12 / 10MHz

Lowest Channel / QPSK

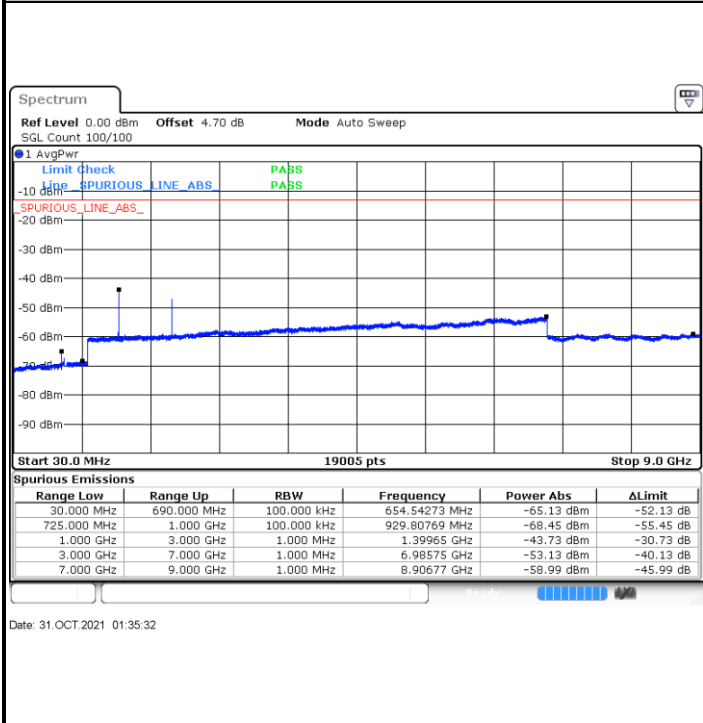

Middle Channel / QPSK

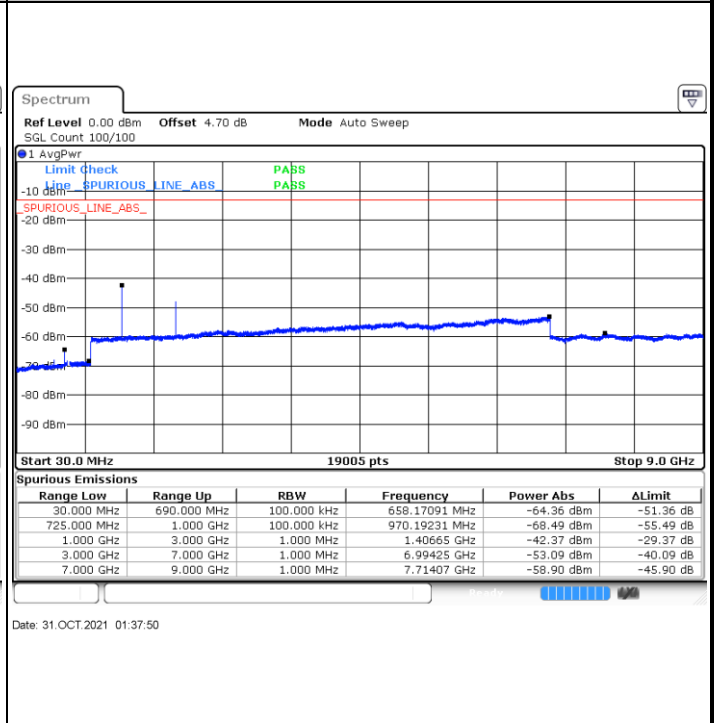

Highest Channel / QPSK

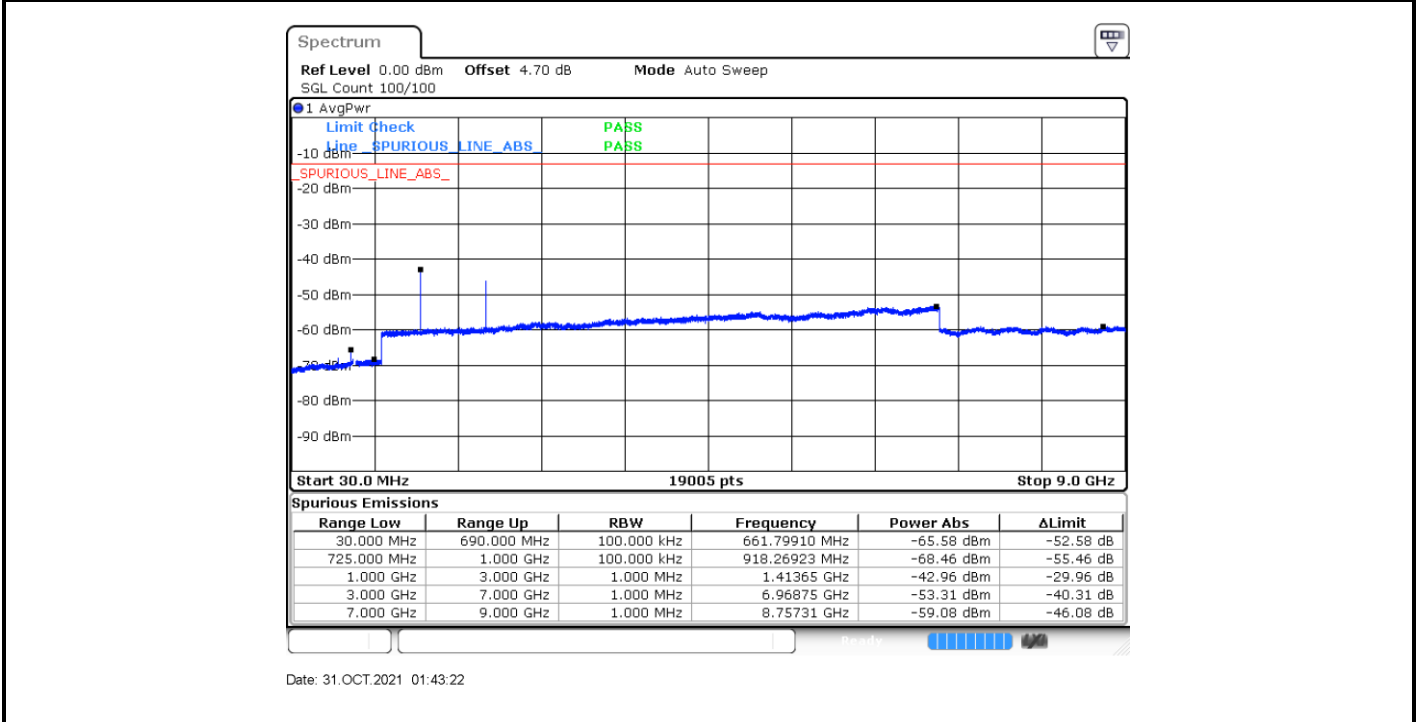



Frequency Stability

Test Conditions		LTE Band 12 (QPSK) / Middle Channel	Limit
Temperature (°C)	Voltage (Volt)	BW 10MHz	Note 2.
		Deviation (ppm)	Result
50	Normal Voltage	0.0010	PASS
40	Normal Voltage	0.0006	
30	Normal Voltage	0.0001	
20(Ref.)	Normal Voltage	0.0000	
10	Normal Voltage	0.0013	
0	Normal Voltage	0.0006	
-10	Normal Voltage	0.0004	
-20	Normal Voltage	0.0021	
-30	Normal Voltage	0.0001	
20	Maximum Voltage	0.0011	
20	Normal Voltage	0.0007	
20	Battery End Point	0.0006	

Note:

1. Normal Voltage =3.87 V. ; Battery End Point (BEP) =3.4 V. ; Maximum Voltage =4.45 V.
2. Note: The frequency fundamental emissions stay within the authorized frequency block.



LTE Band 13

Peak-to-Average Ratio

Mode	LTE Band 13 / 10MHz				
Mod.	QPSK	16QAM	64QAM	256QAM	Limit: 13dB
RB Size	Full RB	Full RB	Full RB	Full RB	Result
Middle CH	4.72	5.45	6.09	6.67	PASS

