



# FCC RADIO TEST REPORT

**FCC ID** : IHDT56AA6  
**Equipment** : Wearable Cellular Device  
**Brand Name** : Motorola  
**Model Name** : XT2209-1  
**Applicant** : Motorola Mobility, LLC  
222 W Merchandise Mart Plaza, Suite  
1800, Chicago, IL 60654, United States  
**Manufacturer** : Motorola Mobility, LLC  
222 W Merchandise Mart Plaza, Suite  
1800, Chicago, IL 60654, United States  
**Standard** : FCC 47 CFR Part 2, and 30

The product was received on Oct. 25, 2021 and testing was started from Oct. 29, 2021 and completed on Dec. 23, 2021. We, Sporton International Inc. Wensan Laboratory, would like to declare that the tested sample has been evaluated in accordance with the test procedures ANSI C63.26-2015 and has been in compliance with the applicable technical standards.

The test results in this report apply exclusively to the tested model / sample. Without written approval of Sporton International Inc. Wensan Laboratory, the test report shall not be reproduced except in full.

Approved by: Louis Wu

**Sporton International Inc. Wensan Laboratory**

No.58, Aly. 75, Ln. 564, Wenhua 3rd, Rd., Guishan Dist., Taoyuan City 333010, Taiwan



## Table of Contents

History of this test report.....	3
Summary of Test Result.....	4
<b>1 General Description .....</b>	<b>5</b>
1.1 Feature of Equipment Under Test.....	5
1.2 mmWave Antenna Modules .....	5
1.3 Product Specification of Equipment Under Test .....	6
1.4 Modification of EUT .....	6
1.5 Testing Location .....	7
1.6 Applied Standards .....	7
<b>2 Test Configuration of Equipment Under Test .....</b>	<b>8</b>
2.1 Test Mode.....	8
2.2 Connection Diagram of Test System .....	9
2.3 Support Unit used in test configuration .....	9
2.4 Measurement Results Explanation Example .....	9
2.5 Far Field Condition for Frequency above 18GHz.....	10
2.6 Frequency List of Low/Middle/High Channels.....	10
<b>3 Radiated Test Items .....</b>	<b>12</b>
3.1 Measuring Instruments.....	12
3.2 Test Setup .....	12
3.3 Test Result of Radiated Test.....	15
3.4 EIRP Measurement .....	16
3.5 Occupied Bandwidth .....	17
3.6 Radiated Spurious Emission Measurement .....	18
3.7 Frequency Stability Measurement.....	19
<b>4 List of Measuring Equipment.....</b>	<b>20</b>
<b>5 Uncertainty of Evaluation .....</b>	<b>22</b>
<b>Appendix A. Test Results of Conducted and Radiated Test</b>	
<b>Appendix B. R&amp;S Mixer and Horn Antenna Calibration Reports</b>	



### History of this test report

Report No.	Version	Description	Issued Date
FG1O2008F	01	Initial issue of report	Dec. 02, 2021
FG1O2008F	02	1. Revise Type of Modulation 2. Revise description in section 3.3 3. Revise List of Measuring Equipment	Dec. 08, 2021
FG1O2008F	03	1. Revise description 2. Add test data	Dec. 23, 2021



### Summary of Test Result

Report Clause	Ref Std. Clause	Test Items	Limit	Result (PASS/FAIL)	Remark
3.4	§2.1046 §30.202	EIRP Measurement	+43dBm	Pass	-
3.5	§2.1049	Occupied Bandwidth	Not Applicable	Reporting only	-
3.6	§2.1053 §30.203	Radiated Spurious Emission	-5dBm/MHz -13dBm/MHz	Pass	-
3.7	§2.1055	Frequency Stability for Temperature & Voltage	Within the band	Pass	-

**Declaration of Conformity:**

The test results with all measurement uncertainty excluded are presented in accordance with the regulation limits or requirements declared by manufacturers.

**Comments and Explanations:**

The declared of product specification for EUT presented in the report are provided by the manufacturer, and the manufacturer takes all the responsibilities for the accuracy of product specification.

**Reviewed by: Keven Cheng**

**Report Producer: Vivian Hsu**



# 1 General Description

## 1.1 Feature of Equipment Under Test

Product Feature	
Equipment	Wearable Cellular Device
Brand Name	Motorola
Model Name	XT2209-1
FCC ID	IHDT56AA6
IMEI Code	356636550004429
EUT supports Radios application	LTE/5G NR/GNSS WLAN 11a/b/g/n HT20/HT40 WLAN 11ac VHT20/VHT40/VHT80/VHT160 WLAN 11ax HE20/HE40/HE80/HE160 Bluetooth BR/EDR/LE
HW Version	EVT1
EUT Stage	Identical Prototype

**Remark:** The above EUT's information is declared by manufacturer. Please refer to Comments and Explanations in report summary.

Accessory List	
Battery	Brand Name : Motorola
	Model Name : NR70

## 1.2 mmWave Antenna Modules

Module 0 is placed in the front pod while Module 1 is placed in the rear pod where it is physically separated from the front pod. Both modules consist of 10 elements, which are divided into group of 5 elements separately for 2 polarizations that are orthogonal to each other, dual-polarization beams are generated by transmission of both groups (AG0 and AG1). The device does not support simultaneous transmission from both Module 0 and Module 1.



### 1.3 Product Specification of Equipment Under Test

Product Specification subjective to this standard	
Device Category in Part 30	Mobile station
Tx Frequency	NR band n260: 37GHz ~ 40GHz NR band n261: 27.5GHz ~ 28.35GHz
Rx Frequency	NR band n260: 37GHz ~ 40GHz NR band n261: 27.5GHz ~ 28.35GHz
Support Bandwidth	NR band n260: 50/100 MHz (1CC) and 200/300/400 MHz (2/3/4CC) NR band n261: 50/100 MHz (1CC) and 200/300/400 MHz (2/3/4CC)
Maximum Number of contiguous CC	4
Maximum Aggregated Bandwidth	400MHz
Maximum Output Power (EIRP)	NR band n260: Module 0: 30.08 dBm <b>Module 1: 31.54 dBm</b> NR band n261: <b>Module 0: 30.94 dBm</b> Module 1: 30.67 dBm
Type of Modulation	CP-OFDM: QPSK / 16QAM / 64QAM DFT-s-OFDM: Pi/2 BPSK / QPSK / 16QAM / 64QAM

Note 1: Highest EIRP was measured on Module 0, dual beam case for n261 band.

Note 2: Highest EIRP was measured on Module 1, dual beam case for n260 band.

Note 3: The above EUT's information was declared by manufacturer. Please refer to Comments and Explanations in report summary.

### 1.4 Modification of EUT

No modifications are made to the EUT during all test items.



### 1.5 Testing Location

<b>Test Site</b>	Sporton International Inc. Wensan Laboratory			
<b>Test Site Location</b>	No.58, Aly. 75, Ln. 564, Wenhua 3rd, Rd., Guishan Dist., Taoyuan City 333010, Taiwan TEL: +886-3-327-3456 FAX: +886-3-328-4978			
<b>Test Site Information</b>	<b>Site No.</b>	<b>Engineer</b>	<b>Temperature</b>	<b>Humidity</b>
	03CH18-HY	Steven Wu and Eric Jeng	22~24°C	46~47%
	03CH19-HY	Steven Wu, Yu Wang and Eric Jeng	23~25°C	47~50%

Note 1: FCC Designation No.: TW3786

Note 2: The highest accredited frequency is 280GHz and the ISO 17025 accreditation letter can be found on TAF (Taiwan Accreditation Foundation) Website ([Website link](#)).

### 1.6 Applied Standards

According to the specifications of the manufacturer, the EUT must comply with the requirements of the following standards:

- ♦ FCC 47 CFR Part 2, 30
- ♦ ANSI C63.26-2015
- ♦ FCC KDB 971168 D01 Power Meas. License Digital Systems v03r01
- ♦ FCC KDB 414788 D01 Radiated Test Site v01r01.
- ♦ FCC KDB 842590 D01 Upper Microwave Flexible Use Service v01r02

**Remark:**

1. All test items were verified and recorded according to the standards and without any deviation during the test.
2. The TAF code is not including all the FCC KDB listed without accreditation.



## 2 Test Configuration of Equipment Under Test

EUT has total 2 millimeter wave antenna modules and up to 2 beams operation for each module.

Any antenna module cannot transmit simultaneously with the other antenna modules.

Preliminary EIRP test was performed for all beam configurations in the anechoic chamber at the manufacturer’s facility so the EIRP worst case beam-pair were identified.

EIRP was investigated that the dual beam rated maximum EIRP is higher than single beam.

The NR radio operation is controlled via software tool QRCT FTM mode (Factory mode).

The EUT is forced to operate continuously (100% duty cycle) with maximum output power during the test.

### 2.1 Test Mode

For radiated measurement, the pre-scan is performed to find the worst cases EUT position.

Test Items	Band	Bandwidth (MHz)					Modulation			RB #			Test Channel		
		50	100	200	300	400	QPSK	16QA M	64QA M	1	Inner Full	Outer Full	L	M	H
EIRP	n260 n261	v	v	v	v	v	v	v	v	v	v	v	v	v	v
99% Occupied Bandwidth	n260 n261	v	v	-	-	v	v	v	v	-	-	v	v	v	v
Out of Band Emission	n260 n261	v	v	-	-	v	v	v	v	v	-	v	v	-	v
Spurious Emission	n260 n261	v	v	-	-	v	v	-	-	v	-	-	v	v	v
Frequency Stability	n260 n261	CW tone											-	v	-
Remark	<ol style="list-style-type: none"> <li>The mark “v “ means that this configuration is chosen for testing.</li> <li>The device is investigated from 9kHz to 200GHz of fundamental signal for radiated spurious emission test under different RB size and modulations in exploratory test. Subsequently, only the worst case emissions are reported.</li> <li>Both modulation type DFT-s OFDM and CP-OFDM are evaluated and reported.</li> <li>The out of band emission were measured radiated EIRP. The TRP method is applied when EIRP exceeds limit.</li> <li>The bandwidths were investigated among different component carrier (CC), 100MHz (1CC), 200MHz (2CC), 300MHz (3CC) and 400MHz (4CC). The test configuration associated with the highest power: 1CC, and the maximum bandwidth: 4CC, were selected to perform the testing.</li> </ol>														



## 2.2 Connection Diagram of Test System

<For radiated emissions from 30MHz to 200GHz>

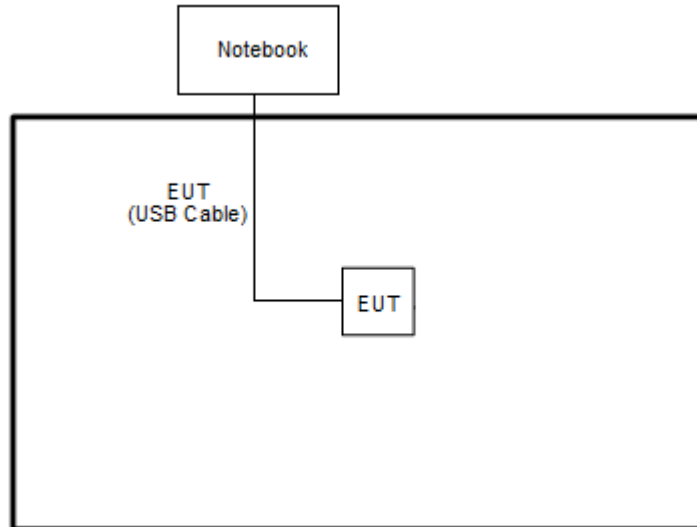

## 2.3 Support Unit used in test configuration

Item	Equipment	Brand Name	Model No.	FCC ID	Data Cable	Power Cord
1.	Notebook	Dell	Latitude 3400	FCC DoC	N/A	AC I/P : Unshielded, 1.2m DC O/P : Shielded, 1.8m

## 2.4 Measurement Results Explanation Example

According to ANSI C63.26-2015 Section 5.2.7

$$\text{EIRP (dBm)} = E(\text{dBuV/m}) + 20\log(D) - 104.8.$$

- where D is the measurement distance (in the far field region) in m.
- $E(\text{dBuV/m}) = \text{Spectrum Reading Level (dBm)} + \text{Antenna Factor (dB/m)} + \text{Cable Loss (dB)} + 107$

Hence, the spectrum analyzer *Offset* is derived including RF cable loss and antenna factor.

$$\text{Offset} = \text{Antenna Factor (dB/m)} + \text{Cable Loss (dB)} + 107 + 20\log(D) - 104.8$$

The conversion loss of RF mixer is also included by the mixer table of spectrum analyzer when measurement frequency is above 40GHz.

Example :

$$\begin{aligned} \text{Offset} &= \text{Antenna Factor (dB/m)} + \text{Cable Loss (dB)} + 107 + 20\log(D) - 104.8 \\ &= 42.3 + 3.0 + 107 + 20\log(1) - 104.8 \\ &= 47.5 \text{ (dB)} \end{aligned}$$



### 2.5 Far Field Condition for Frequency above 18GHz

Horn Antenna	Frequency (GHz)	Antenna Dimension A (mm)	Wavelength (λ) (m)	Far field R (m) $\geq 2A^2 / \lambda$	Measurement Distance (D) (m)	Distance Factor $20\log(D)$ (dB)
BBHA 9170	18	60	0.0167	0.43	1	0.00
	40	60	0.0075	0.96		
QWH-UPRR00	40	48	0.0075	0.61	1	0.00
	60	48	0.0050	0.92		
QWH-EPRR00	60	31	0.0050	0.38	1	0.00
	90	31	0.0033	0.58		
QWH-FPRR00	90	21	0.0033	0.26	1	0.00
	140	21	0.0021	0.41		
QWH-GPRR00	140	15	0.0021	0.21	0.5	-6.02
	220	15	0.0014	0.33		

### 2.6 Frequency List of Low/Middle/High Channels

NR Band n260 Channel and Frequency List				
BW [MHz]	Channel/Frequency(MHz)	Lowest	Middle	Highest
50	Frequency	37025	38500	39975
100	Frequency	37050	38500	39950
200	Frequency 1	37050	38450	39850
	Frequency 2	37150	38550	39950
300	Frequency 1	37050	38400	39750
	Frequency 2	37150	38500	39850
	Frequency 3	37250	38600	39950
400	Frequency 1	37050	38350	39650
	Frequency 2	37150	38450	39750
	Frequency 3	37250	38550	39850
	Frequency 4	37350	38650	39950



<b>NR Band n261 Channel and Frequency List</b>				
<b>BW [MHz]</b>	<b>Channel/Frequency(MHz)</b>	<b>Lowest</b>	<b>Middle</b>	<b>Highest</b>
50	Frequency	27525	27925	28325
100	Frequency	27550	27925	28300
200	Frequency 1	27550	27875	28200
	Frequency 2	27650	27975	28300
300	Frequency 1	27550	27825	28100
	Frequency 2	27650	27925	28200
	Frequency 3	27750	28025	28300
400	Frequency 1	27550	27775	28000
	Frequency 2	27650	27875	28100
	Frequency 3	27750	27975	28200
	Frequency 4	27850	28075	28300

### 3 Radiated Test Items

#### 3.1 Measuring Instruments

Please refer to the measuring equipment list in this test report.

#### 3.2 Test Setup

For radiated emissions from 9kHz to 30MHz

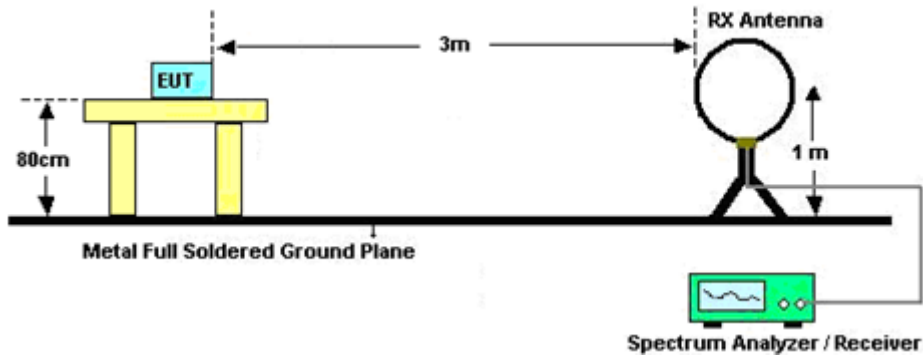

For radiated emissions from 30MHz to 1GHz

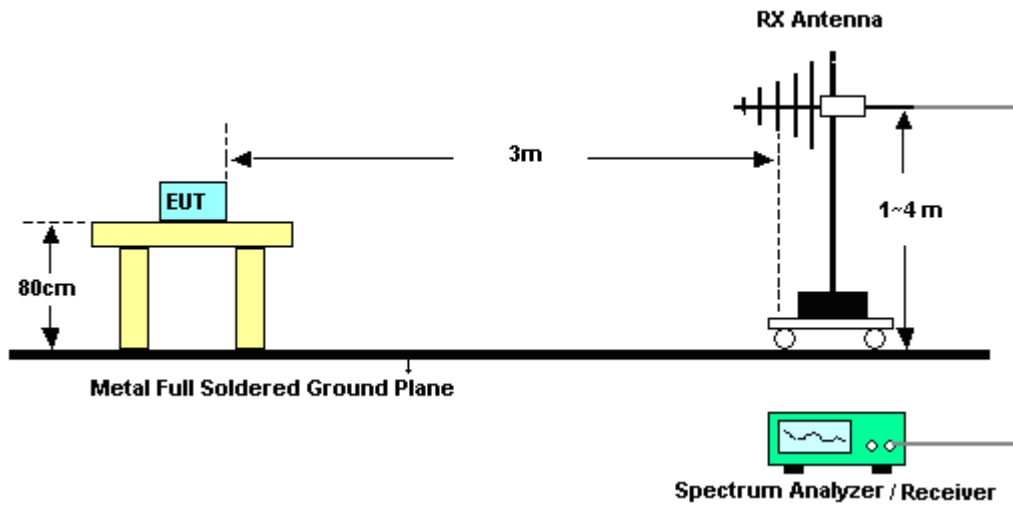

For radiated emissions 1GHz to 18GHz

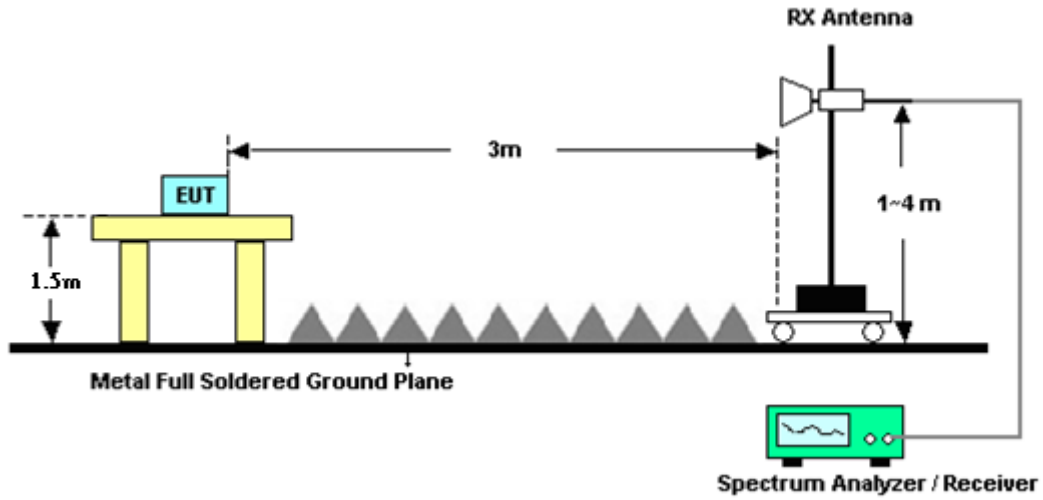

For radiated emissions above 18GHz up to 40GHz

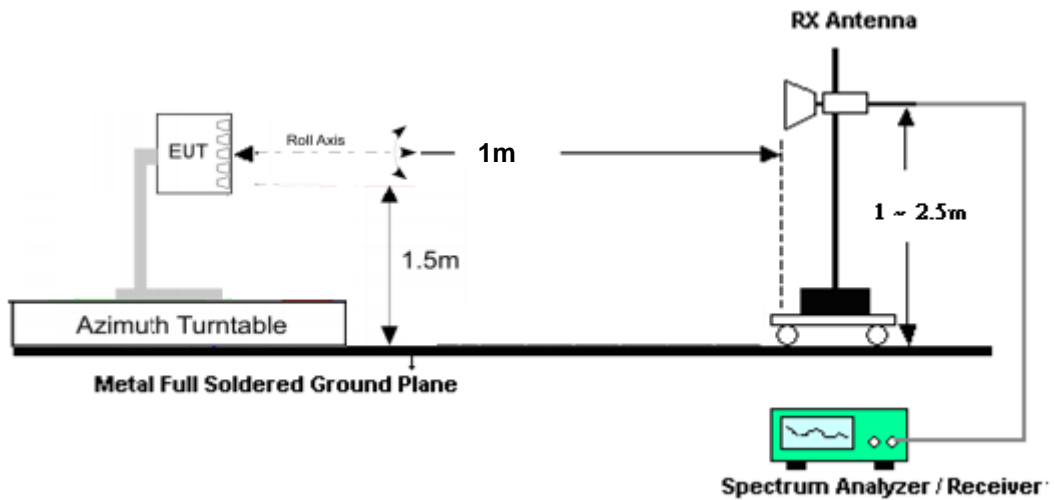

For radiated emissions above 40GHz up to 140GHz

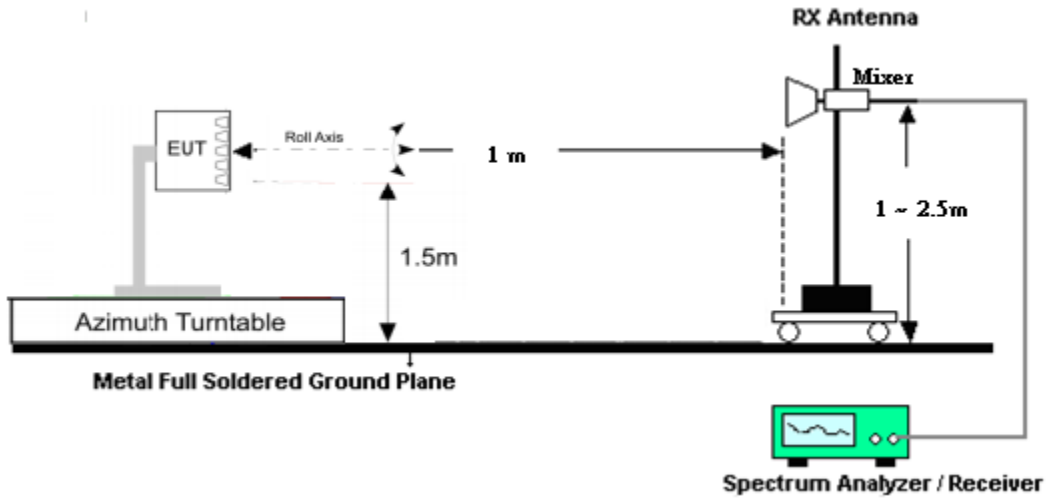

For radiated emissions above 140GHz up to 200GHz

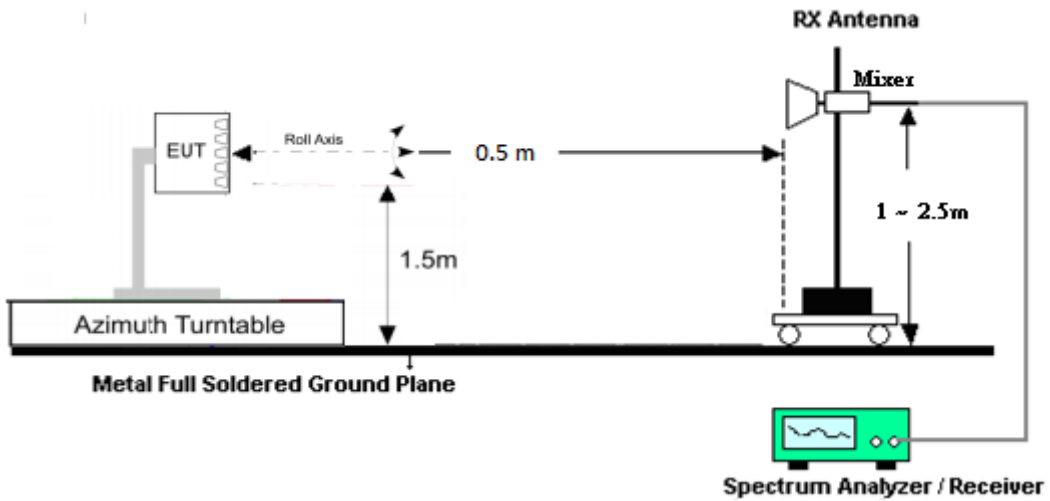

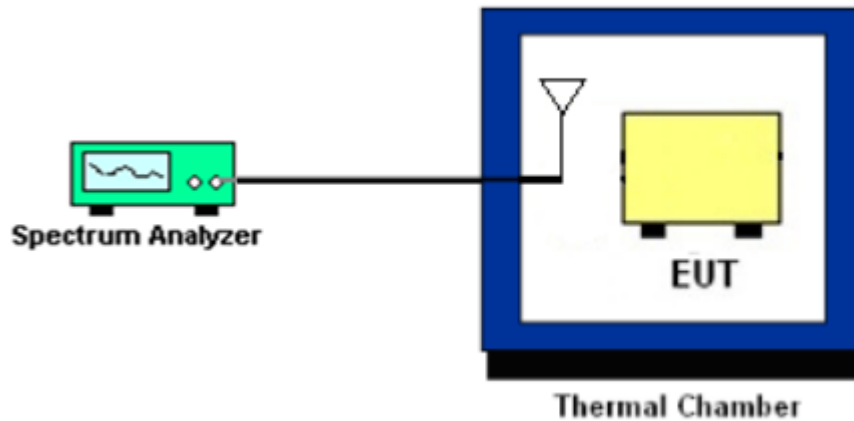
**Frequency stability Setup****3.3 Test Result of Radiated Test**

Please refer to Appendix A.

Note:

The low frequency, which started from 9 kHz to 30MHz, was pre-scanned and the result which was 20dB lower than the limit line was not reported.

There is adequate comparison measurement of both open-field test site and alternative test site - semi-Anechoic chamber according to 414788 D01 Radiated Test Site v01r01, and the result came out very similar.



## 3.4 EIRP Measurement

### 3.4.1 Description of EIRP Measurement

For mobile stations, the average power of the sum of all antenna elements is limited to a maximum EIRP of +43 dBm.

### 3.4.2 Test Procedures

1. Set EUT at maximum output power.
2. Select lowest, middle, and highest channels for each band and different modulation.
3. Enable channel power function of spectrum analyzer
4. Set frequency would like to be investigated.
5. Set Detector = RMS
6. Set Trace mode = trace average
7. Set Sweep time = auto couple
8. Set sweep points  $\geq 2 \times \text{Span/RBW}$
9. Set sweep count 100 and wait until the trace to be stabilized
10. Make the measurement with the spectrum analyzer's RBW = 1MHz, VBW = 3MHz, taking the record of maximum spurious emission.
11. Measure and record the power level from the spectrum analyzer.
12. The test result is calculated according to

ANSI C63.26-2015 Section 5.2.7

$$\text{EIRP (dBm)} = \text{E(dBuV/m)} + 20\log(D) - 104.8.$$

where D is the measurement distance (in the far field region) in m.

$$\text{E (dBuV/m)} = \text{Spectrum Level (dBm)} + \text{Antenna Factor (dB/m)} + \text{Cable Loss (dB)} + 107$$

That is, set the spectrum offset including sum of

$$\text{Antenna Factor (dB/m)} + \text{Cable Loss (dB)} + 107 + 20\log(D) - 104.8$$





## **3.5 Occupied Bandwidth**

### **3.5.1 Description of Occupied Bandwidth Measurement**

This is for reporting only.

The occupied bandwidth is the width of a frequency band such that, below the lower and above the upper frequency limits, the mean powers emitted are each equal to a specified percentage 0.5% of the total mean transmitted power.

### **3.5.2 Test Procedures**

The testing follows ANSI C63.26-2015 Section 5.4.4

1. The spectrum analyzer center frequency is set to the nominal EUT channel center frequency. The span range for the spectrum analyzer shall be at least 1.5 times the anticipated OBW.
2. The nominal resolution bandwidth (RBW) shall be in the range of 1 to 5 % of the anticipated OBW, and the VBW shall be at least 3 times the RBW.
3. Set the detection mode to peak, and the trace mode to max hold.
4. Use the 99 % power bandwidth function of the spectrum analyzer and report the measured bandwidth.



## 3.6 Radiated Spurious Emission Measurement

### 3.6.1 Description of Radiated Spurious Emission Measurement

The spectrum is scanned from 30 MHz up to 200GHz.

The conductive power or the total radiated power of any emission outside a licensee's frequency block shall be -13 dBm/MHz or lower. However, in the bands immediately outside and adjacent to the licensee's frequency block, having a bandwidth equal to 10 percent of the channel bandwidth, the conductive power or the total radiated power of any emission shall be -5 dBm/MHz or lower.

### 3.6.2 Test Procedures

1. Set EUT at maximum output power..
2. Select lowest, middle, and highest channels for each band and different modulation.
3. Measure and record the power level from the spectrum analyzer.
4. Set frequency would like to be investigated.
5. Set Detector = RMS, Trace mode = trace average, sweep time = auto couple
6. Set sweep points  $\geq 2 \times \text{Span/RBW}$ , sweep count 100 and wait until the trace to be stabilized.
7. Make the measurement with the spectrum analyzer's RBW = 1MHz, VBW = 3MHz, taking the record of maximum spurious emission.
8. For measurement frequency from 30MHz to 18GHz,  
An antenna was substituted in place of the EUT and was driven by a signal generator.  
Tune the output power of signal generator to the same emission level with EUT maximum spurious emission. Take record of output power and repeat for another polarization.
9. For measurement frequency above 18GHz, the test result is calculated according to ANSI C63.26-2015 Section 5.2.7 and 5.7.3 and 5.7.4  
$$\text{EIRP (dBm)} = \text{E(dBuV/m)} + 20\log(D) - 104.8.$$
where D is the measurement distance (in the far field region) in m.  
$$\text{E (dBuV/m)} = \text{Spectrum Level (dBm)} + \text{Antenna Factor (dB/m)} + \text{Cable Loss (dB)} + 107$$
That is, set the spectrum offset including sum of  
$$\text{Antenna Factor (dB/m)} + \text{Cable Loss (dB)} + 107 + 20\log(D) - 104.8$$
10. The conversion loss of RF mixer is also included in conversion loss table of the spectrum analyzer when measurement frequency is above 40GHz.
11. The TRP method refers to the clause 4.4.2.2 of FCC KDB 842590 D01 v01r02.  
If EIRP measurement results exceed the emission limit, then TRP measurement will be used as an alternative method. Test results of TRP measurement are marked as "TRP Measurement".



## **3.7 Frequency Stability Measurement**

### **3.7.1 Description of Frequency Stability Measurement**

The frequency stability shall be measured by variation of ambient temperature and variation of primary supply voltage to ensure that the fundamental emission stays within the authorized frequency block.

### **3.7.2 Test Procedures for Temperature Variation**

The testing follows FCC KDB 971168 D01 v03r01 Section 9.

1. The EUT was set up in the thermal chamber.
2. With power OFF, the temperature was decreased to -30°C and the EUT was stabilized before testing. Power was applied and the maximum change in frequency was recorded within one minute.
3. With power OFF, the temperature was raised in 10°C step up to 50°C. The EUT was stabilized at each step for at least half an hour. Power was applied and the maximum frequency change was recorded within one minute.

### **3.7.3 Test Procedures for Voltage Variation**

The testing follows FCC KDB 971168 D01 v03r01 Section 9.

1. The EUT was placed in a temperature chamber at 20° C.
2. The power supply voltage to the EUT was varied from 85% to 115% of the nominal value measured at the input to the EUT.
3. The variation in frequency was measured for the worst case.



## 4 List of Measuring Equipment

Instrument	Brand Name	Model No.	Serial No.	Characteristics	Calibration Date	Test Date	Due Date	Remark
Loop Antenna	Rohde & Schwarz	HFH2-Z2	100315	9 kHz~30 MHz	Jan. 04, 2021	Nov. 19, 2021~ Nov. 20, 2021	Jan. 03, 2022	Radiation (03CH19-HY)
Amplifier	SONOMA	310N	187311	9kHz~1GHz	Oct. 20, 2021	Nov. 19, 2021~ Nov. 20, 2021	Oct. 21, 2022	Radiation (03CH19-HY)
Preamplifier	COM-POWER	PAM-103	18020199	1MHz-1000MHz	Jan. 04, 2021	Nov. 19, 2021~ Nov. 20, 2021	Jan. 03, 2022	Radiation (03CH19-HY)
Bilog Antenna	TESEQ	CBL 6111D & 00800N1D01N -06	55608 & 09	30MHz~1GHz	Oct. 17, 2021	Nov. 19, 2021~ Nov. 20, 2021	Oct. 16, 2022	Radiation (03CH19-HY)
Horn Antenna	SCHWARZBE CK	BBHA 9120 D	002360	1GHz~18GHz	Nov. 02, 2021	Nov. 19, 2021~ Nov. 20, 2021	Nov. 01, 2022	Radiation (03CH19-HY)
Amplifier	EMCI	EMC118A45S E	980792	1GHz-18GHz	Nov. 15, 2021	Nov. 19, 2021~ Nov. 20, 2021	Nov. 14, 2022	Radiation (03CH19-HY)
Spectrum Analyzer	Rohde & Schwarz	FSV30	103738	9kHz~30GHz	May 19, 2021	Nov. 19, 2021~ Nov. 20, 2021	May 18, 2022	Radiation (03CH19-HY)
Controller	E MEC	EM 1000	N/A	Control Turn table & Ant Mast	N/A	Nov. 19, 2021~ Nov. 20, 2021	N/A	Radiation (03CH19-HY)
Antenna Mast	E MEC	AM-BS-4500-B	N/A	1~4m	N/A	Nov. 19, 2021~ Nov. 20, 2021	N/A	Radiation (03CH19-HY)
Turn Table	E MEC	TT 2200	N/A	0~360 Degree	N/A	Nov. 19, 2021~ Nov. 20, 2021	N/A	Radiation (03CH19-HY)
Software	Audix	E3 6.2009-8-24	RK-002155	N/A	N/A	Nov. 19, 2021~ Nov. 20, 2021	N/A	Radiation (03CH19-HY)
RF Cable	HUBER + SUHNER	SUCOFLEX 102	519226/2,804 014/2,804026 /2	30MHz~40GHz	Jan. 20, 2021	Nov. 19, 2021~ Nov. 20, 2021	Jan. 19, 2022	Radiation (03CH19-HY)
SHF-EHF Horn Antenna	SCHWARZBE CK	BBHA 9170	BBHA917098 0	18GHz~40GHz	Jan. 11, 2021	Oct. 29, 2021~ Dec. 23, 2021	Jan. 10, 2022	Radiation (03CH18-HY)
Spectrum Analyzer	Rohde & Schwarz	FSV3044	101010	10Hz~44GHz	Nov. 25, 2020	Oct. 29, 2021~ Nov. 19, 2021	Nov. 24, 2021	Radiation (03CH18-HY)
Spectrum Analyzer	Rohde & Schwarz	FSV3044	101009	10Hz~44GHz	Nov. 12, 2021	Dec. 21, 2021~ Dec. 23, 2021	Nov. 11, 2022	Radiation (03CH18-HY)
RF Cable	HUBER + SUHNER	SUCOFLEX 102	801607/2	9kHz~40GHz	Dec. 22, 2020	Oct. 29, 2021~ Nov. 19, 2021	Dec. 21, 2021	Radiation (03CH18-HY)
RF Cable	HUBER + SUHNER	SUCOFLEX 102	801606/2	9kHz~40GHz	Nov. 30, 2021	Dec. 21, 2021~ Dec. 23, 2021	Nov. 29, 2022	Radiation (03CH18-HY)
Turn Table	E MEC	N/A	N/A	Phi/Theta 0~360 Degree	N/A	Oct. 29, 2021~ Dec. 23, 2021	N/A	Radiation (03CH18-HY)
Controller	E MEC	EM 1000	N/A	Control Turn table	N/A	Oct. 29, 2021~ Dec. 23, 2021	N/A	Radiation (03CH18-HY)
Spectrum Analyzer	Rohde & Schwarz	FSV30	103738	9kHz to 30GHz	May 19, 2021	Nov. 22, 2021	May 18, 2022	Radiation (03CH18-HY)
RF Cable	HUBER + SUHNER	SUCOFLEX 102	801607/2	9kHz~40GHz	Dec. 22, 2020	Nov. 22, 2021	Dec. 21, 2021	Radiation (03CH18-HY)
RF Cable	HUBER + SUHNER	SUCOFLEX 102	801589/2	9kHz~40GHz	Dec. 22, 2020	Nov. 22, 2021	Dec. 21, 2021	Radiation (03CH18-HY)



Instrument	Brand Name	Model No.	Serial No.	Characteristics	Calibration Date	Test Date	Due Date	Remark
*Harmonic Mixer	Rohde & Schwarz	RPG FS-Z60	101033	40GHz to 60GHz	Mar. 17, 2020	Nov. 22, 2021	Mar. 16, 2023	Radiation (03CH18-HY)
*Harmonic Mixer	Rohde & Schwarz	FSZ-90	101867	60GHz to 90GHz	Jan. 10, 2019	Nov. 22, 2021	Jan. 09, 2022	Radiation (03CH18-HY)
*Harmonic Mixer	Rohde & Schwarz	RPG FS-Z140	101128	90GHz to 140GHz	Oct. 26, 2020	Nov. 22, 2021	Oct. 25, 2023	Radiation (03CH18-HY)
*Harmonic Mixer	Rohde & Schwarz	RPG FS-Z220	101042	140GHz to 220GHz	Sep. 15, 2020	Nov. 22, 2021	Sep. 14, 2023	Radiation (03CH18-HY)
Antenna	Quinstar	QWH-UPRR00	1410300003	40-60 GHz	Jun. 07, 2021	Nov. 22, 2021	N/A (Note 3)	Radiation (03CH18-HY)
Antenna	Quinstar	QWH-EPRR00	1372000000	60-90 GHz	Jun. 07, 2021	Nov. 22, 2021	N/A (Note 3)	Radiation (03CH18-HY)
Antenna	Quinstar	QWH-FPRR00	1011500008	90-140 GHz	Jun. 07, 2021	Nov. 22, 2021	N/A (Note 3)	Radiation (03CH18-HY)
Antenna	Quinstar	QWH-GPRR00	QWH-GPRR00-01	140-220 GHz	Jun. 07, 2021	Nov. 22, 2021	N/A (Note 3)	Radiation (03CH18-HY)
Temperature & Humidity Cabinet Chamber	ESPEC	SU-641	92013721	-30°C ~70°C	Oct. 21, 2021	Nov. 22, 2021	Oct. 20, 2022	Radiation (03CH18-HY)

**Note 1:** (\*) Equipment manufacturer's Calibration Certificate.

**Note 2:** The Standard Gain Horn Antennas are calibrated by the ISO 17025 accredited test lab MWM Lab

(<http://en.mwmlab.com/about>), a sub unit of Belarussian State University of Informatics and Radio electronics which is accredited by the Belarusian State Centre for Accreditation (BSCA). BSCA is the National accreditation body of the Republic of Belarus and an associated member of the International Laboratory Accreditation Cooperation (ILAC).

**Note 3:** The standard gain horn's critical dimensions is verified on an annual basis within the equipment specification according to KDB 842590 D01 v01r02 clause 2)a)2)iii).



## 5 Uncertainty of Evaluation

### Uncertainty of Radiated Emission Measurement (30 MHz ~ 1000 MHz)

Measuring Uncertainty for a Level of Confidence of 95% ( $U = 2Uc(y)$ )	3.31
---	------

### Uncertainty of Radiated Emission Measurement (1 GHz ~ 18 GHz)

Measuring Uncertainty for a Level of Confidence of 95% ( $U = 2Uc(y)$ )	3.62
---	------

### Uncertainty of Radiated Emission Measurement (18 GHz ~ 40 GHz)

Measuring Uncertainty for a Level of Confidence of 95% ( $U = 2Uc(y)$ )	4.62
---	------

### Uncertainty of Radiated Emission Measurement (40 GHz ~ 140 GHz)

Measuring Uncertainty for a Level of Confidence of 95% ( $U = 2Uc(y)$ )	5.92
---	------

### Uncertainty of Radiated Emission Measurement (140 GHz ~ 200 GHz)

Measuring Uncertainty for a Level of Confidence of 95% ( $U = 2Uc(y)$ )	6.78
---	------



### Appendix A. Test Results of EIRP and Radiated Test

#### EIRP Power (Average power)

<Module 0>

NR Band n260 Module 0 AG0 (Beam ID:39 )					
Maximum Average EIRP [dBm]					
Lowest	BW [MHz]	Waveform	Modulation	Inner 1RB	Inner Full
	50	DFT-S	QPSK	26.53	26.75
	50	DFT-S	16QAM	24.29	24.63
	50	DFT-S	64QAM	22.63	22.66
	50	CP	QPSK	23.65	22.53
	100	DFT-S	QPSK	27.40	27.47
	100	DFT-S	16QAM	25.26	25.32
	100	DFT-S	64QAM	23.35	23.50
	100	CP	QPSK	24.34	24.4
	400	DFT-S	QPSK	20.41	22.67
	400	DFT-S	16QAM	20.38	20.89
	400	DFT-S	64QAM	19.08	19.32
	400	CP	QPSK	20.28	20.85
NR Band n260 Module 0 AG0 (Beam ID:39 )					
Maximum Average EIRP [dBm]					
Middle	BW [MHz]	Waveform	Modulation	Inner 1RB	Inner Full
	50	DFT-S	QPSK	26.16	25.98
	50	DFT-S	16QAM	23.63	23.96
	50	DFT-S	64QAM	21.92	21.89
	50	CP	QPSK	23.02	22.05
	100	DFT-S	QPSK	26.07	26.00
	100	DFT-S	16QAM	23.65	23.88
	100	DFT-S	64QAM	22.06	21.86
	100	CP	QPSK	23.10	22.97
	400	DFT-S	QPSK	19.57	21.72
	400	DFT-S	16QAM	19.33	20.05
	400	DFT-S	64QAM	18.35	18.27
	400	CP	QPSK	19.71	20.02



NR Band n260 Module 0 AG0 (Beam ID:39 )					
Maximum Average EIRP [dBm]					
	BW [MHz]	Waveform	Modulation	Inner 1RB	Inner Full
<b>Highest</b>	50	DFT-S	QPSK	24.99	25.08
	50	DFT-S	16QAM	22.81	23.02
	50	DFT-S	64QAM	20.85	20.99
	50	CP	QPSK	21.81	20.90
	100	DFT-S	QPSK	24.86	25.02
	100	DFT-S	16QAM	22.39	22.86
	100	DFT-S	64QAM	20.70	20.93
	100	CP	QPSK	21.96	21.89
	400	DFT-S	QPSK	17.53	19.76
	400	DFT-S	16QAM	17.33	18.01
	400	DFT-S	64QAM	16.23	16.32
	400	CP	QPSK	17.51	18.12

Note : The 400MHz Bandwidth is carrier aggregation by 4CC of 100MHz.

NR Band n260 Module 0 AG1 (Beam ID:167 )					
Maximum Average EIRP [dBm]					
	BW [MHz]	Waveform	Modulation	Inner 1RB	Inner Full
<b>Lowest</b>	50	DFT-S	QPSK	26.72	26.68
	50	DFT-S	16QAM	24.07	24.42
	50	DFT-S	64QAM	22.46	22.54
	50	CP	QPSK	23.51	22.56
	100	DFT-S	QPSK	27.35	27.33
	100	DFT-S	16QAM	24.87	25.30
	100	DFT-S	64QAM	23.33	23.3
	100	CP	QPSK	24.35	24.32
	400	DFT-S	QPSK	20.21	22.67
	400	DFT-S	16QAM	20.02	20.72
	400	DFT-S	64QAM	18.89	18.99
	400	CP	QPSK	20.36	20.84





NR Band n260 Module 0 AG1 (Beam ID:167 )					
Maximum Average EIRP [dBm]					
Middle	BW [MHz]	Waveform	Modulation	Inner 1RB	Inner Full
	50	DFT-S	QPSK	25.92	25.87
	50	DFT-S	16QAM	23.40	23.83
	50	DFT-S	64QAM	21.84	21.83
	50	CP	QPSK	22.81	21.81
	100	DFT-S	QPSK	25.75	25.35
	100	DFT-S	16QAM	23.07	23.22
	100	DFT-S	64QAM	21.50	21.29
	100	CP	QPSK	22.19	22.17
	400	DFT-S	QPSK	19.55	21.44
	400	DFT-S	16QAM	19.30	19.85
	400	DFT-S	64QAM	18.28	18.33
	400	CP	QPSK	19.61	19.92
NR Band n260 Module 0 AG1 (Beam ID:167 )					
Maximum Average EIRP [dBm]					
Highest	BW [MHz]	Waveform	Modulation	Inner 1RB	Inner Full
	50	DFT-S	QPSK	24.20	24.21
	50	DFT-S	16QAM	21.81	22.04
	50	DFT-S	64QAM	20.07	20.00
	50	CP	QPSK	21.09	20.02
	100	DFT-S	QPSK	24.11	24.02
	100	DFT-S	16QAM	21.62	21.99
	100	DFT-S	64QAM	19.98	19.84
	100	CP	QPSK	20.78	20.93
	400	DFT-S	QPSK	16.35	18.54
	400	DFT-S	16QAM	15.99	16.89
	400	DFT-S	64QAM	15.08	15.07
	400	CP	QPSK	16.42	16.99

Note : The 400MHz Bandwidth is carrier aggregation by 4CC of 100MHz.



NR Band n260 Module 0 AG0+1 (Beam ID:39+167 )					
Maximum Average EIRP [dBm]					
	BW [MHz]	Waveform	Modulation	Inner 1RB	Inner Full
Lowest	50	DFT-S	QPSK	29.13	29.42
	50	DFT-S	16QAM	27.04	27.33
	50	DFT-S	64QAM	24.83	25.20
	50	CP	QPSK	26.00	25.20
	100	DFT-S	QPSK	29.52	<b>30.08</b>
	100	DFT-S	16QAM	27.21	28.08
	100	DFT-S	64QAM	25.44	25.94
	100	CP	QPSK	26.60	27.03
	200	DFT-S	QPSK	24.62	<b>26.70</b>
	200	DFT-S	16QAM	24.51	25.03
	200	DFT-S	64QAM	23.21	23.28
	200	CP	QPSK	24.56	25.04
	300	DFT-S	QPSK	25.46	<b>27.45</b>
	300	DFT-S	16QAM	25.25	25.87
	300	DFT-S	64QAM	24.07	23.99
	300	CP	QPSK	25.33	25.82
	400	DFT-S	QPSK	23.33	<b>25.54</b>
	400	DFT-S	16QAM	23.04	23.80
400	DFT-S	64QAM	22.07	22.17	
400	CP	QPSK	23.37	23.84	



NR Band n260 Module 0 AG0+1 (Beam ID:39+167 )					
Maximum Average EIRP [dBm]					
	BW [MHz]	Waveform	Modulation	Inner 1RB	Inner Full
Middle	50	DFT-S	QPSK	29.42	29.47
	50	DFT-S	16QAM	27.24	27.42
	50	DFT-S	64QAM	25.15	25.29
	50	CP	QPSK	26.31	25.51
	100	DFT-S	QPSK	29.19	29.35
	100	DFT-S	16QAM	27.20	27.68
	100	DFT-S	64QAM	25.48	25.62
	100	CP	QPSK	26.48	26.78
	200	DFT-S	QPSK	23.07	25.33
	200	DFT-S	16QAM	22.78	23.61
	200	DFT-S	64QAM	21.68	21.86
	200	CP	QPSK	23.01	23.65
	300	DFT-S	QPSK	24.84	26.94
	300	DFT-S	16QAM	24.74	25.24
	300	DFT-S	64QAM	23.26	23.52
	300	CP	QPSK	23.07	25.33
	400	DFT-S	QPSK	23.28	25.36
	400	DFT-S	16QAM	23.26	23.78
400	DFT-S	64QAM	21.94	22.05	
400	CP	QPSK	23.10	23.65	



NR Band n260 Module 0 AG0+1 (Beam ID:39+167 )					
Maximum Average EIRP [dBm]					
	BW [MHz]	Waveform	Modulation	Inner 1RB	Inner Full
Highest	50	DFT-S	QPSK	27.44	27.85
	50	DFT-S	16QAM	25.04	25.81
	50	DFT-S	64QAM	23.46	23.37
	50	CP	QPSK	24.43	23.36
	100	DFT-S	QPSK	27.41	27.42
	100	DFT-S	16QAM	24.92	25.41
	100	DFT-S	64QAM	23.35	23.42
	100	CP	QPSK	24.17	24.33
	200	DFT-S	QPSK	21.96	24.29
	200	DFT-S	16QAM	21.92	22.46
	200	DFT-S	64QAM	20.43	20.73
	200	CP	QPSK	21.81	22.56
	300	DFT-S	QPSK	21.91	24.39
	300	DFT-S	16QAM	21.85	22.74
	300	DFT-S	64QAM	20.68	20.86
	300	CP	QPSK	21.92	22.55
	400	DFT-S	QPSK	20.17	22.26
	400	DFT-S	16QAM	19.96	20.45
400	DFT-S	64QAM	19.18	18.71	
400	CP	QPSK	20.49	21.02	

Note : The 200/300/400MHz Bandwidth is carrier aggregation by 2/3/4CC of 100MHz.

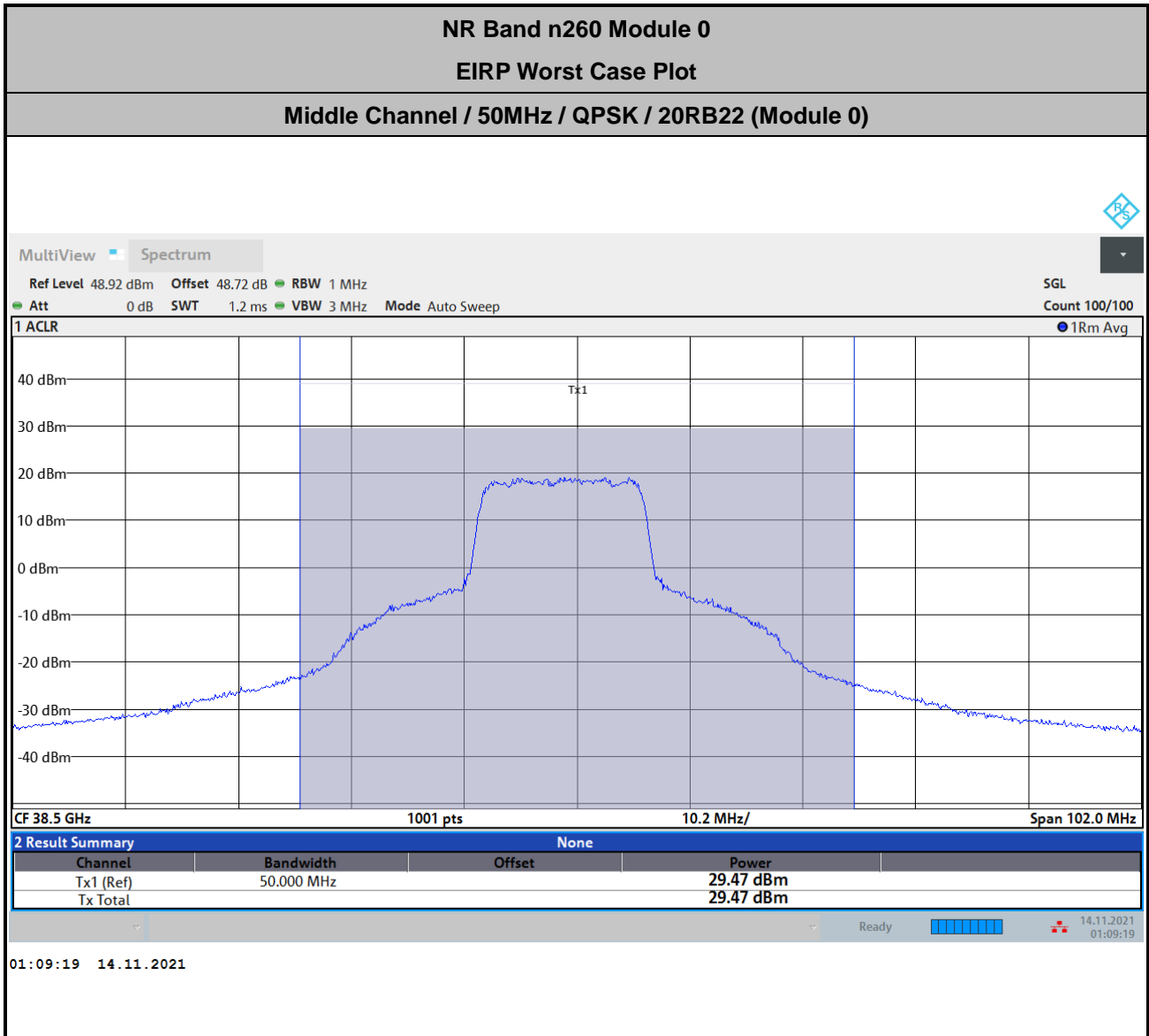

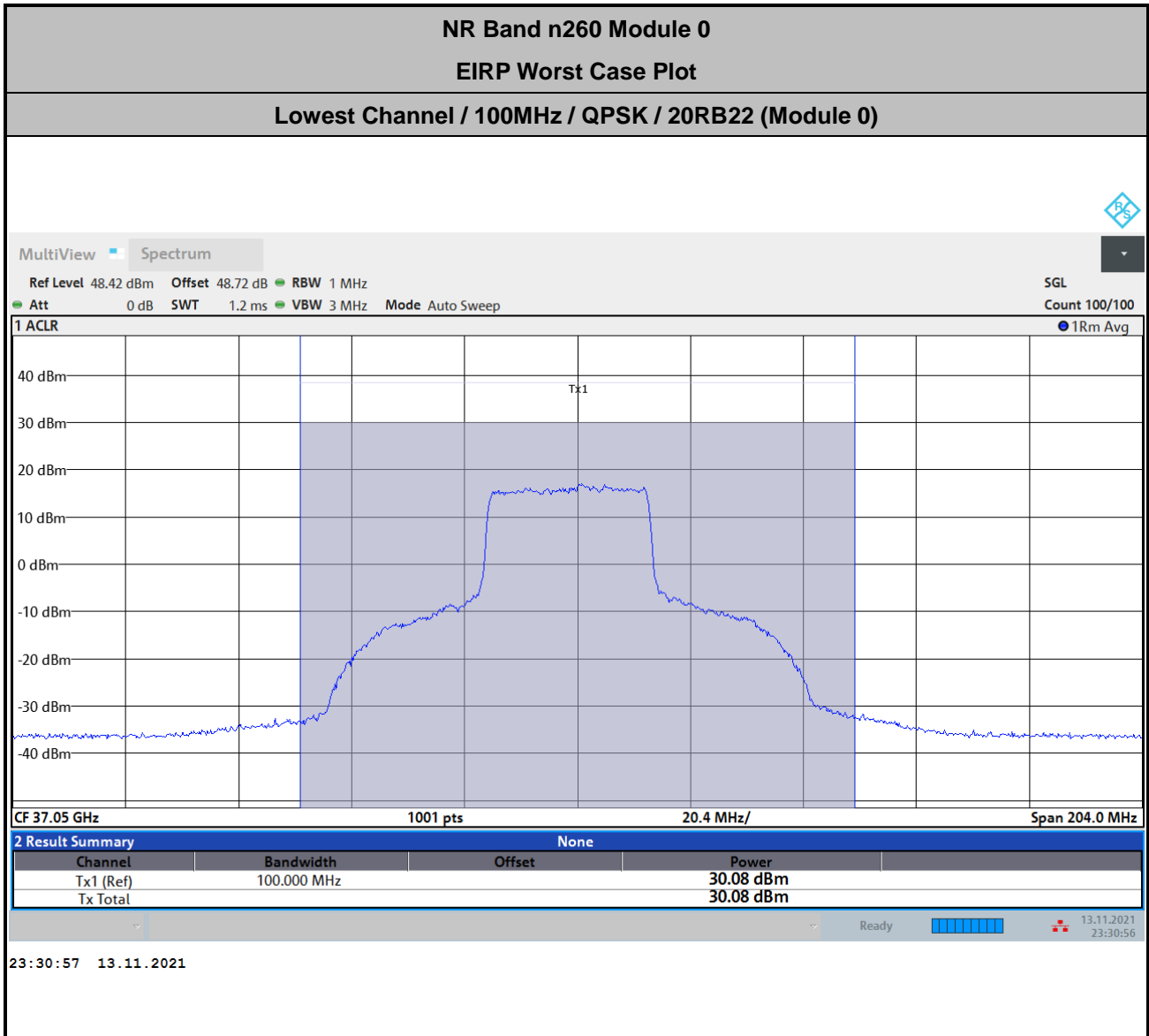

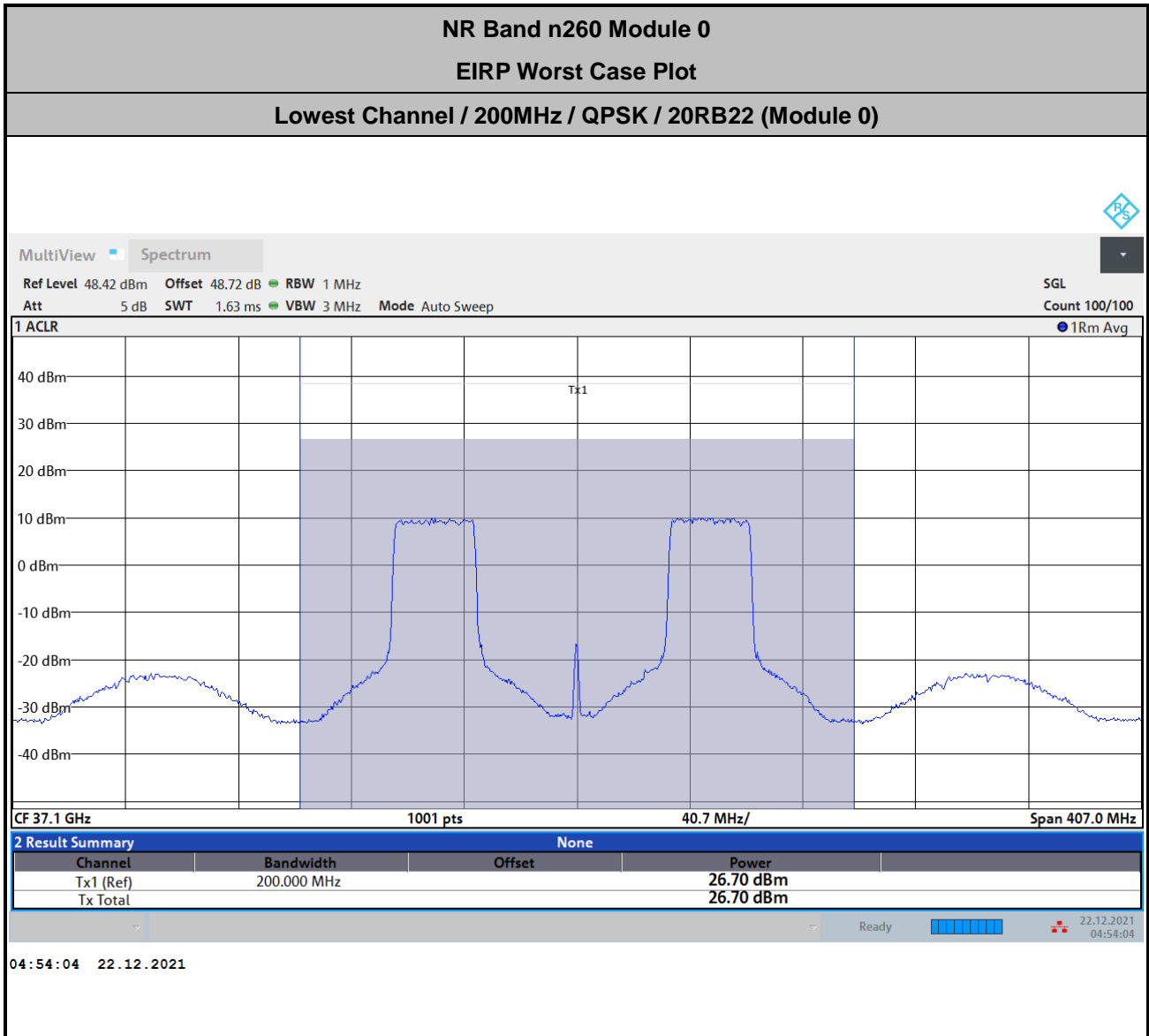

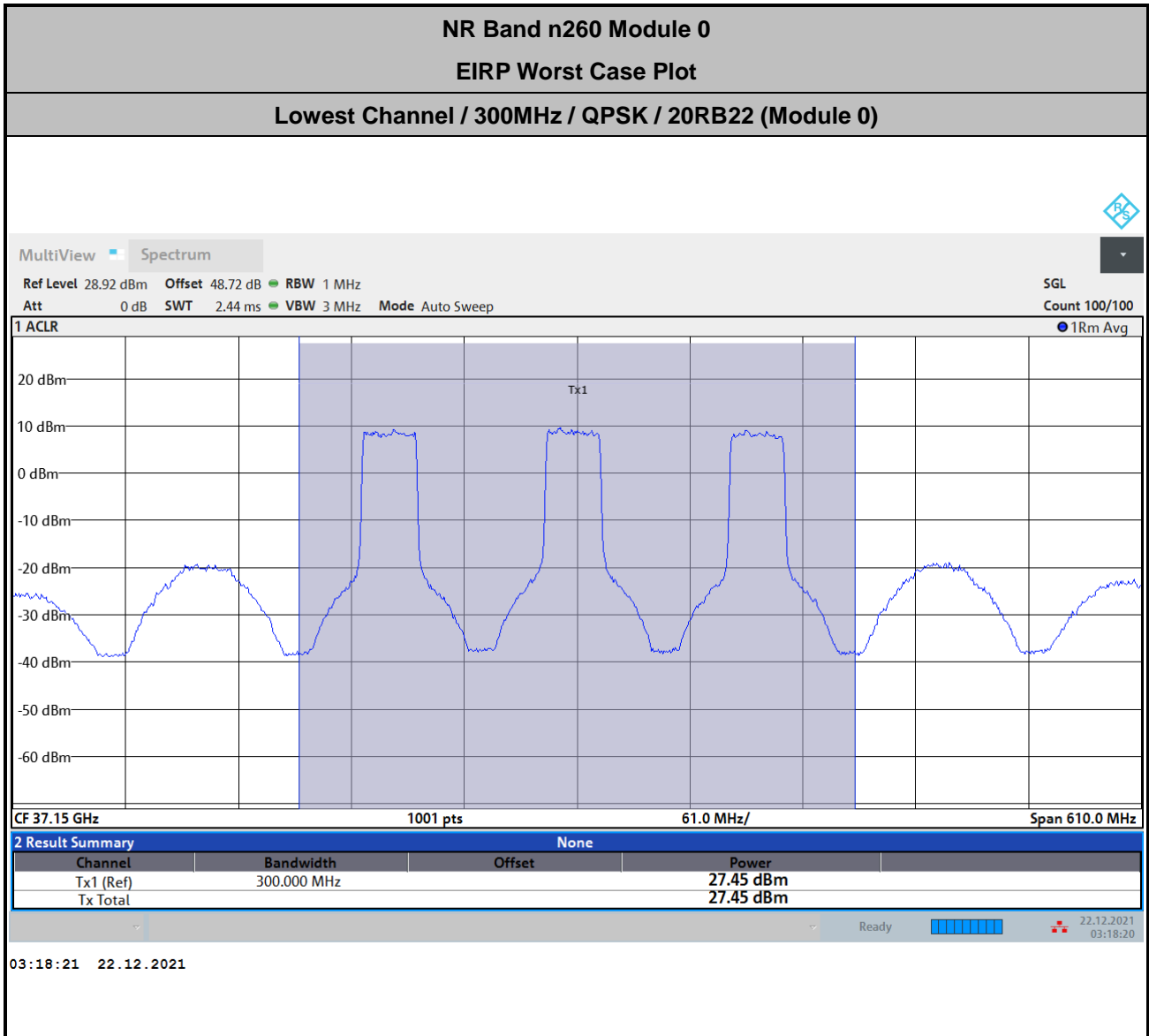



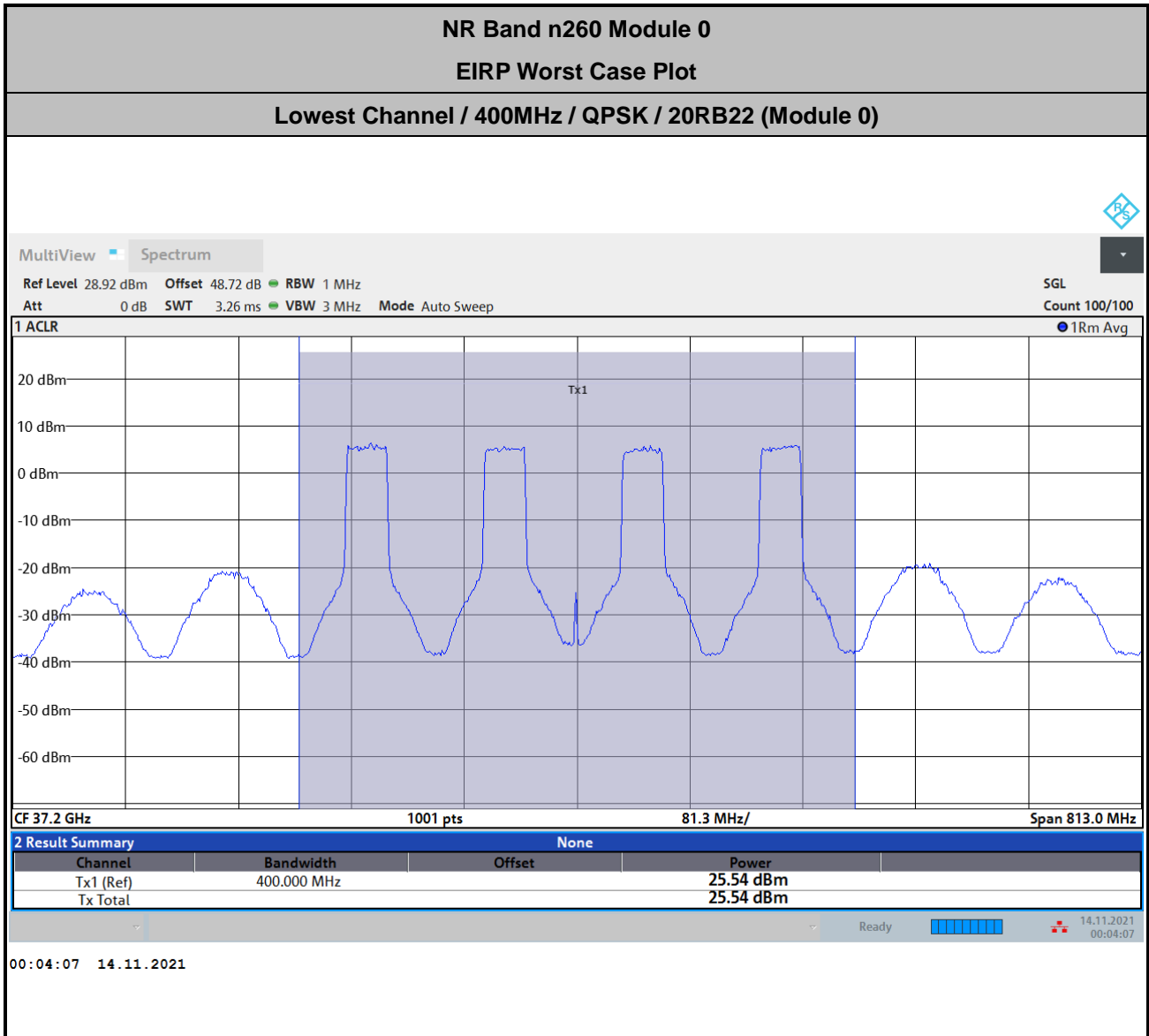

$$\text{Offset} = \text{Antenna Factor (dB/m)} + \text{Cable Loss (dB)} + 107 + 20\log(D) - 104.8$$

$$= 43.8 + 2.72 + 107 + 20\log(1) - 104.8 = 48.72 \text{ (dB)}$$



NR Band n261 Module 0 AG0 (Beam ID:39 )					
Maximum Average EIRP [dBm]					
Lowest	BW [MHz]	Waveform	Modulation	Inner 1RB	Inner Full
	50	DFT-S	QPSK	28.42	28.36
	50	DFT-S	16QAM	26.29	26.45
	50	DFT-S	64QAM	24.25	24.42
	50	CP	QPSK	25.53	24.48
	100	DFT-S	QPSK	28.63	28.5
	100	DFT-S	16QAM	26.16	26.44
	100	DFT-S	64QAM	24.53	24.18
	100	CP	QPSK	25.49	25.25
	400	DFT-S	QPSK	21.26	23.89
	400	DFT-S	16QAM	21.28	21.92
	400	DFT-S	64QAM	20.15	19.99
	400	CP	QPSK	20.43	21.17
NR Band n261 Module 0 AG0 (Beam ID:39 )					
Maximum Average EIRP [dBm]					
Middle	BW [MHz]	Waveform	Modulation	Inner 1RB	Inner Full
	50	DFT-S	QPSK	27.29	27.32
	50	DFT-S	16QAM	24.63	25.33
	50	DFT-S	64QAM	23.18	23.28
	50	CP	QPSK	23.68	22.98
	100	DFT-S	QPSK	26.73	27.13
	100	DFT-S	16QAM	24.33	25.09
	100	DFT-S	64QAM	22.69	22.98
	100	CP	QPSK	23.69	23.84
	400	DFT-S	QPSK	20.14	22.67
	400	DFT-S	16QAM	20.03	20.7
	400	DFT-S	64QAM	19.03	18.94
	400	CP	QPSK	19.95	20.02



NR Band n261 Module 0 AG0 (Beam ID:39 )					
Maximum Average EIRP [dBm]					
	BW [MHz]	Waveform	Modulation	Inner 1RB	Inner Full
<b>Highest</b>	50	DFT-S	QPSK	26.31	26.24
	50	DFT-S	16QAM	24.24	24.33
	50	DFT-S	64QAM	22.09	22.24
	50	CP	QPSK	23.17	22.21
	100	DFT-S	QPSK	26.85	26.66
	100	DFT-S	16QAM	24.24	24.62
	100	DFT-S	64QAM	23.02	22.61
	100	CP	QPSK	23.82	23.65
	400	DFT-S	QPSK	20.47	23.08
	400	DFT-S	16QAM	20.09	21.19
	400	DFT-S	64QAM	19.34	19.28
	400	CP	QPSK	20.32	21

Note : The 400MHz Bandwidth is carrier aggregation by 4CC of 100MHz.

NR Band n261 Module 0 AG1 (Beam ID:167 )					
Maximum Average EIRP [dBm]					
	BW [MHz]	Waveform	Modulation	Inner 1RB	Inner Full
<b>Lowest</b>	50	DFT-S	QPSK	28.57	28.72
	50	DFT-S	16QAM	26.76	26.65
	50	DFT-S	64QAM	24.63	24.59
	50	CP	QPSK	25.46	24.51
	100	DFT-S	QPSK	28.96	28.28
	100	DFT-S	16QAM	26.39	26.27
	100	DFT-S	64QAM	24.64	24.15
	100	CP	QPSK	25.85	25.83
	400	DFT-S	QPSK	21.35	23.89
	400	DFT-S	16QAM	21.27	22.03
	400	DFT-S	64QAM	20.26	19.96
	400	CP	QPSK	21.09	21.84



NR Band n261 Module 0 AG1 (Beam ID:167 )					
Maximum Average EIRP [dBm]					
	BW [MHz]	Waveform	Modulation	Inner 1RB	Inner Full
<b>Middle</b>	50	DFT-S	QPSK	27.83	28.02
	50	DFT-S	16QAM	25.36	25.91
	50	DFT-S	64QAM	23.84	23.87
	50	CP	QPSK	24.65	23.88
	100	DFT-S	QPSK	26.87	27.22
	100	DFT-S	16QAM	24.64	25.19
	100	DFT-S	64QAM	23.16	23.27
	100	CP	QPSK	23.66	24.05
	400	DFT-S	QPSK	20.98	23.6
	400	DFT-S	16QAM	20.7	21.67
	400	DFT-S	64QAM	19.87	19.71
	400	CP	QPSK	20.89	21.47
NR Band n261 Module 0 AG1 (Beam ID:167 )					
Maximum Average EIRP [dBm]					
	BW [MHz]	Waveform	Modulation	Inner 1RB	Inner Full
<b>Highest</b>	50	DFT-S	QPSK	27.38	27.43
	50	DFT-S	16QAM	25.09	25.27
	50	DFT-S	64QAM	23.49	23.21
	50	CP	QPSK	24.33	23.23
	100	DFT-S	QPSK	27.41	27.46
	100	DFT-S	16QAM	25.03	25.3
	100	DFT-S	64QAM	23.34	23.33
	100	CP	QPSK	24.3	24.15
	400	DFT-S	QPSK	21.14	23.82
	400	DFT-S	16QAM	20.95	21.99
	400	DFT-S	64QAM	20.09	20.02
	400	CP	QPSK	21.06	21.8

Note : The 400MHz Bandwidth is carrier aggregation by 4CC of 100MHz.



NR Band n261 Module 0 AG0+1 (Beam ID:39+167 )					
Maximum Average EIRP [dBm]					
	BW [MHz]	Waveform	Modulation	Inner 1RB	Inner Full
Lowest	50	DFT-S	QPSK	30.58	<b>30.94</b>
	50	DFT-S	16QAM	28.28	28.85
	50	DFT-S	64QAM	26.58	26.84
	50	CP	QPSK	27.66	27.04
	100	DFT-S	QPSK	30.34	<b>30.78</b>
	100	DFT-S	16QAM	28.31	28.71
	100	DFT-S	64QAM	26.18	26.86
	100	CP	QPSK	26.66	27.75
	200	DFT-S	QPSK	23.4	26.42
	200	DFT-S	16QAM	23.09	24.47
	200	DFT-S	64QAM	22.09	22.48
	200	CP	QPSK	23.61	24.64
	300	DFT-S	QPSK	23.96	26.82
	300	DFT-S	16QAM	23.89	24.88
	300	DFT-S	64QAM	22.73	22.91
	300	CP	QPSK	24.04	24.85
	400	DFT-S	QPSK	23.92	26.5
	400	DFT-S	16QAM	23.49	24.41
400	DFT-S	64QAM	22.64	22.4	
400	CP	QPSK	23.87	24.43	



NR Band n261 Module 0 AG0+1 (Beam ID:39+167 )					
Maximum Average EIRP [dBm]					
	BW [MHz]	Waveform	Modulation	Inner 1RB	Inner Full
Middle	50	DFT-S	QPSK	29.27	29.78
	50	DFT-S	16QAM	26.88	27.74
	50	DFT-S	64QAM	25.27	25.79
	50	CP	QPSK	26.45	25.88
	100	DFT-S	QPSK	28.22	29.8
	100	DFT-S	16QAM	26.24	27.83
	100	DFT-S	64QAM	24.04	25.89
	100	CP	QPSK	25.34	26.91
	200	DFT-S	QPSK	23.4	26.46
	200	DFT-S	16QAM	23.52	24.56
	200	DFT-S	64QAM	21.97	22.53
	200	CP	QPSK	20.53	24.62
	300	DFT-S	QPSK	23.25	26.5
	300	DFT-S	16QAM	23.18	24.52
	300	DFT-S	64QAM	22.08	22.47
	300	CP	QPSK	23.23	24.34
	400	DFT-S	QPSK	23.75	26.43
	400	DFT-S	16QAM	23.62	24.46
400	DFT-S	64QAM	22.48	22.46	
400	CP	QPSK	23.47	24.4	



NR Band n261 Module 0 AG0+1 (Beam ID:39+167 )					
Maximum Average EIRP [dBm]					
	BW [MHz]	Waveform	Modulation	Inner 1RB	Inner Full
Highest	50	DFT-S	QPSK	30.02	30.34
	50	DFT-S	16QAM	27.9	28.31
	50	DFT-S	64QAM	25.8	26.29
	50	CP	QPSK	26.73	26.29
	100	DFT-S	QPSK	29.96	30.59
	100	DFT-S	16QAM	27.45	28.52
	100	DFT-S	64QAM	25.78	26.5
	100	CP	QPSK	26.65	27.6
	200	DFT-S	QPSK	23.72	<b>26.55</b>
	200	DFT-S	16QAM	23.7	24.63
	200	DFT-S	64QAM	22.2	22.65
	200	CP	QPSK	23.44	24.57
	300	DFT-S	QPSK	24.05	<b>27.09</b>
	300	DFT-S	16QAM	23.92	25.07
	300	DFT-S	64QAM	22.81	22.89
	300	CP	QPSK	22.27	25.04
	400	DFT-S	QPSK	23.97	<b>26.57</b>
	400	DFT-S	16QAM	23.89	24.68
400	DFT-S	64QAM	22.97	22.7	
400	CP	QPSK	23.69	24.71	

Note : The 200/300/400MHz Bandwidth is carrier aggregation by 2/3/4CC of 100MHz.

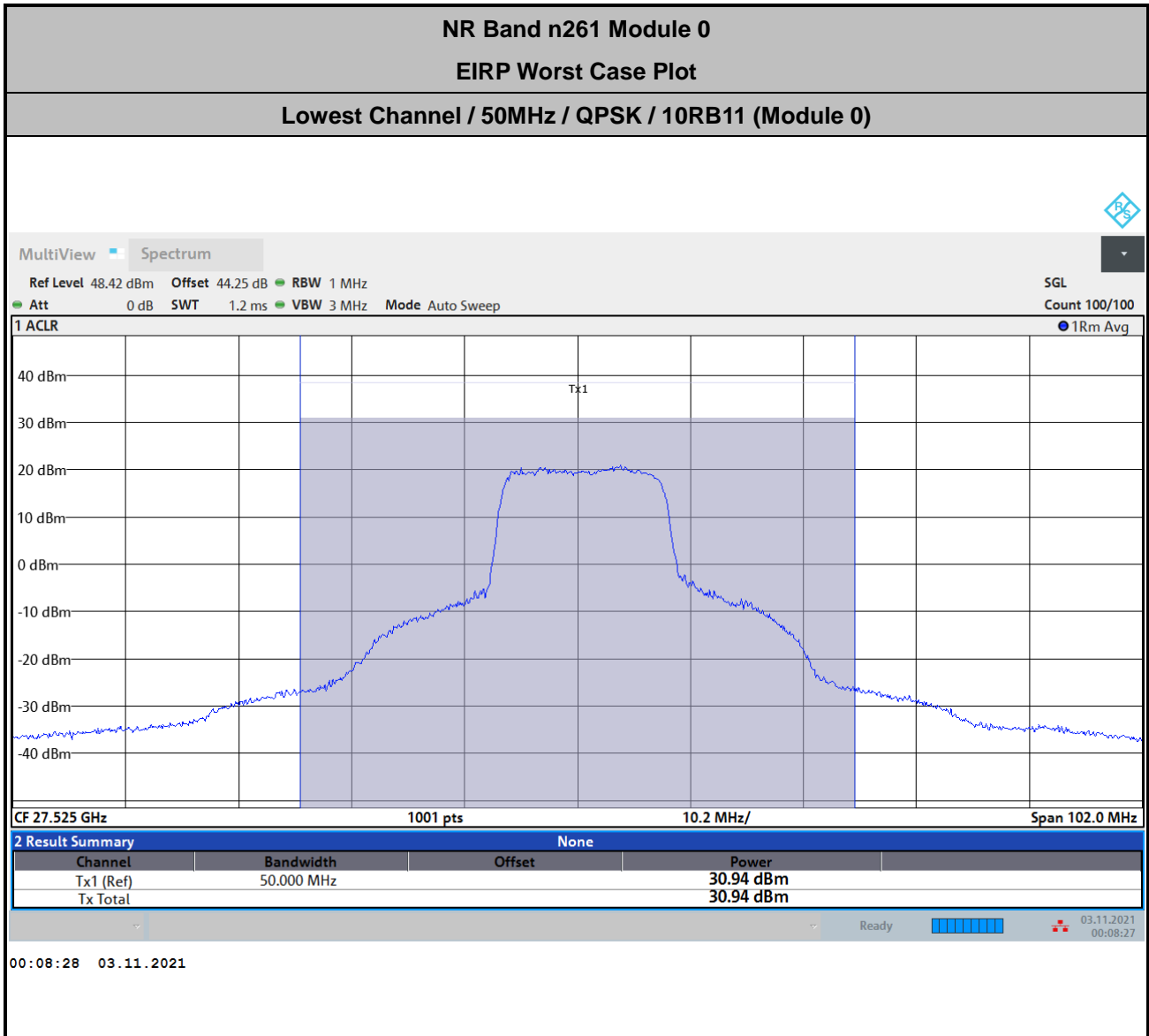



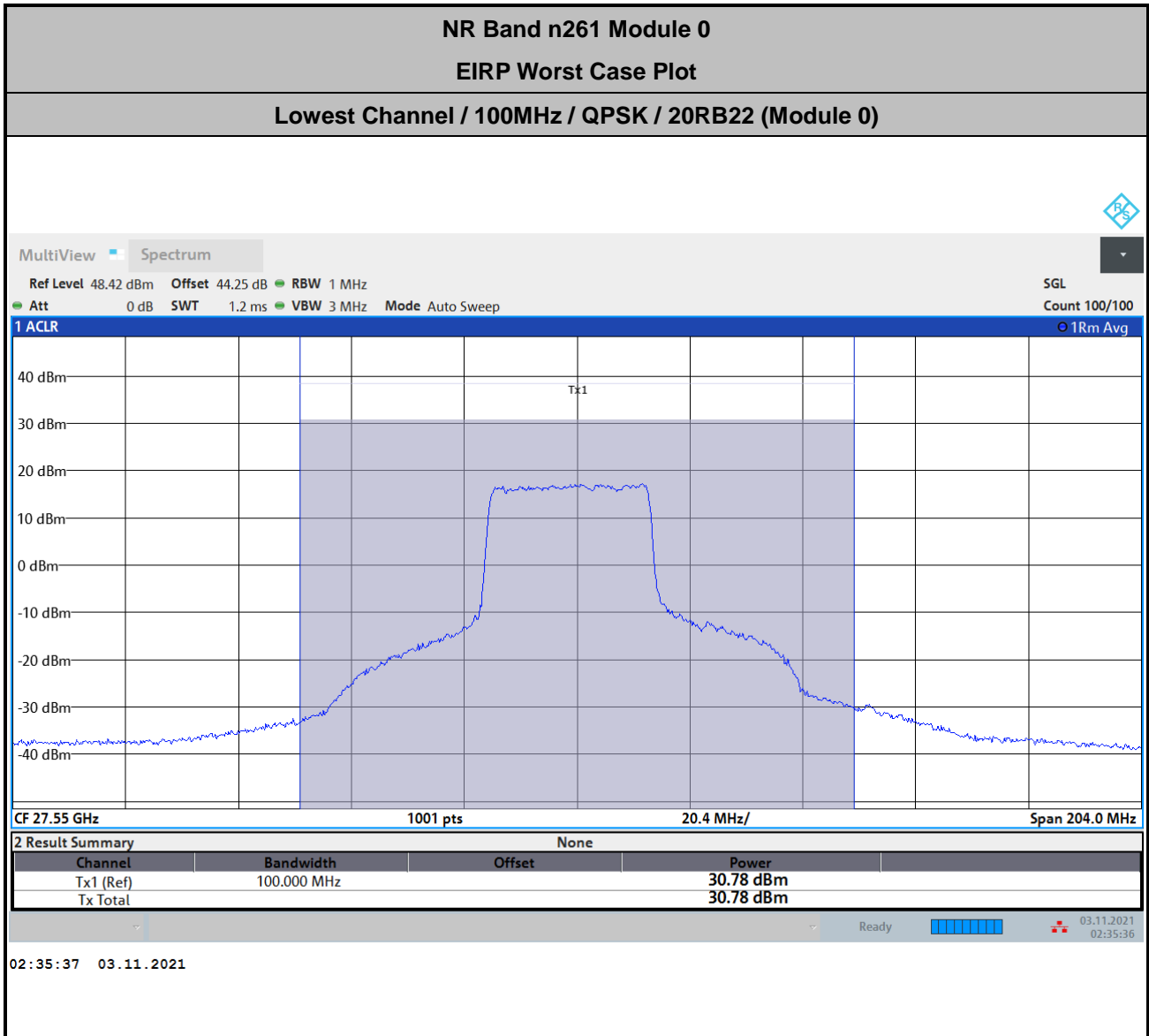

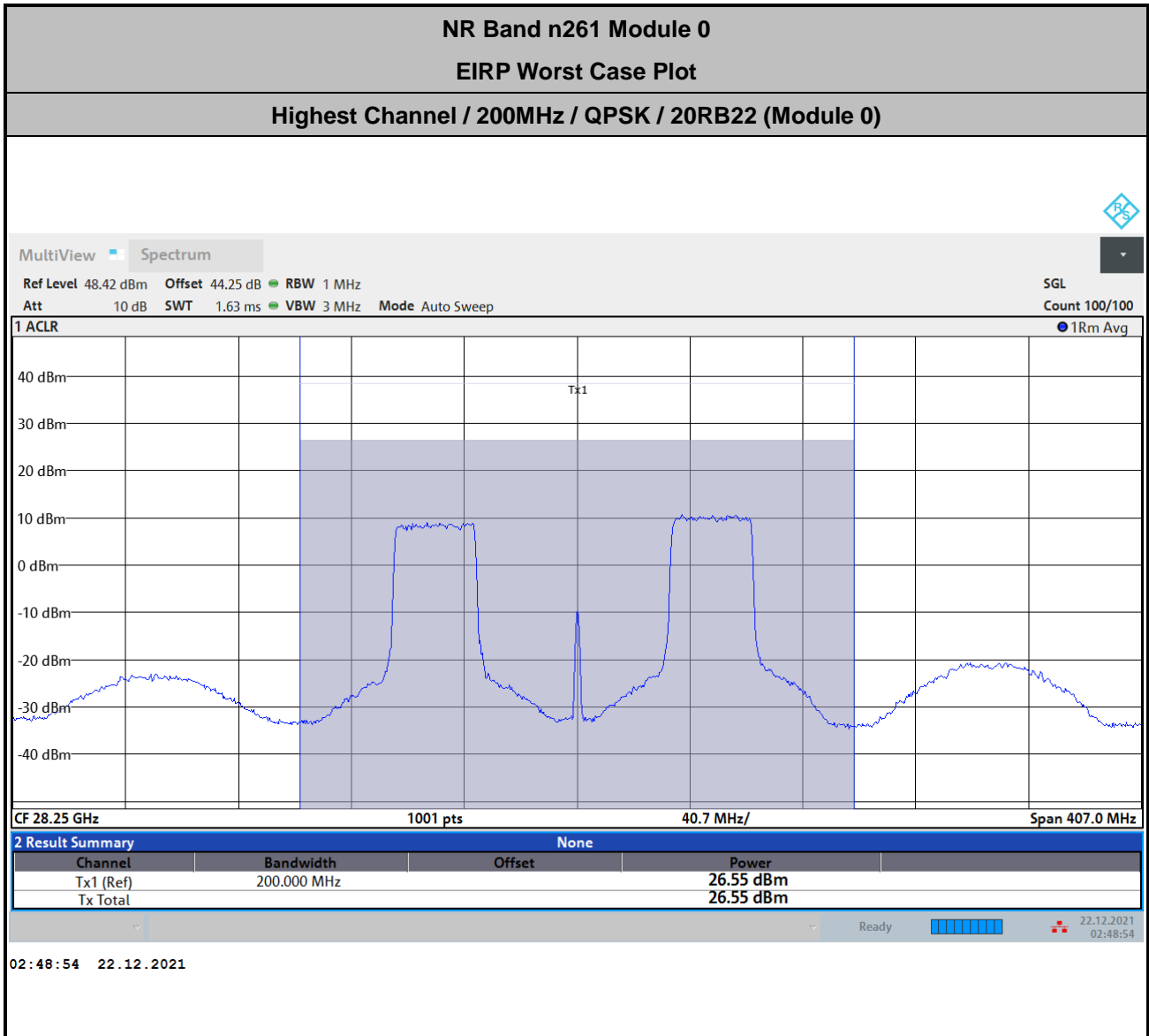

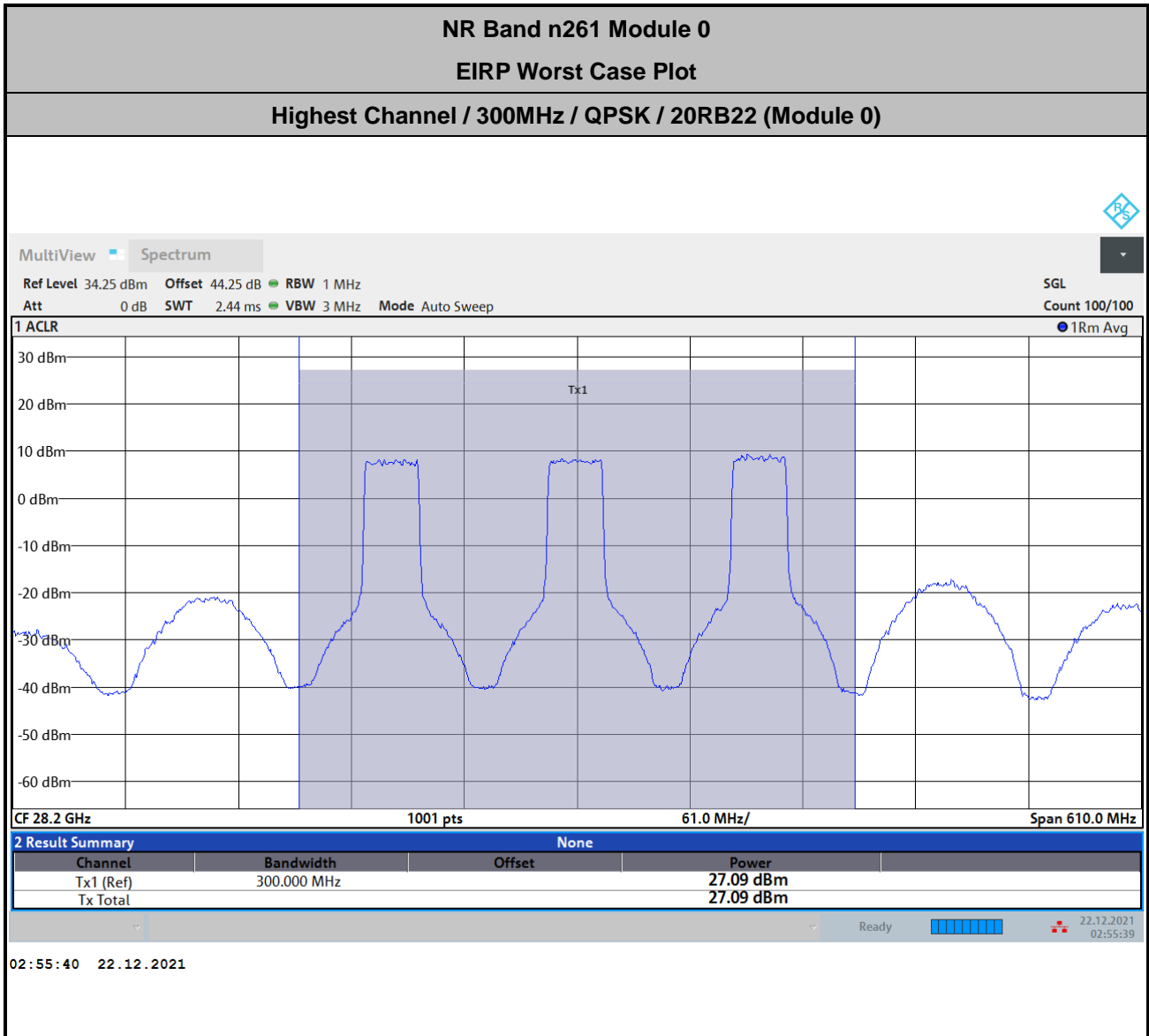

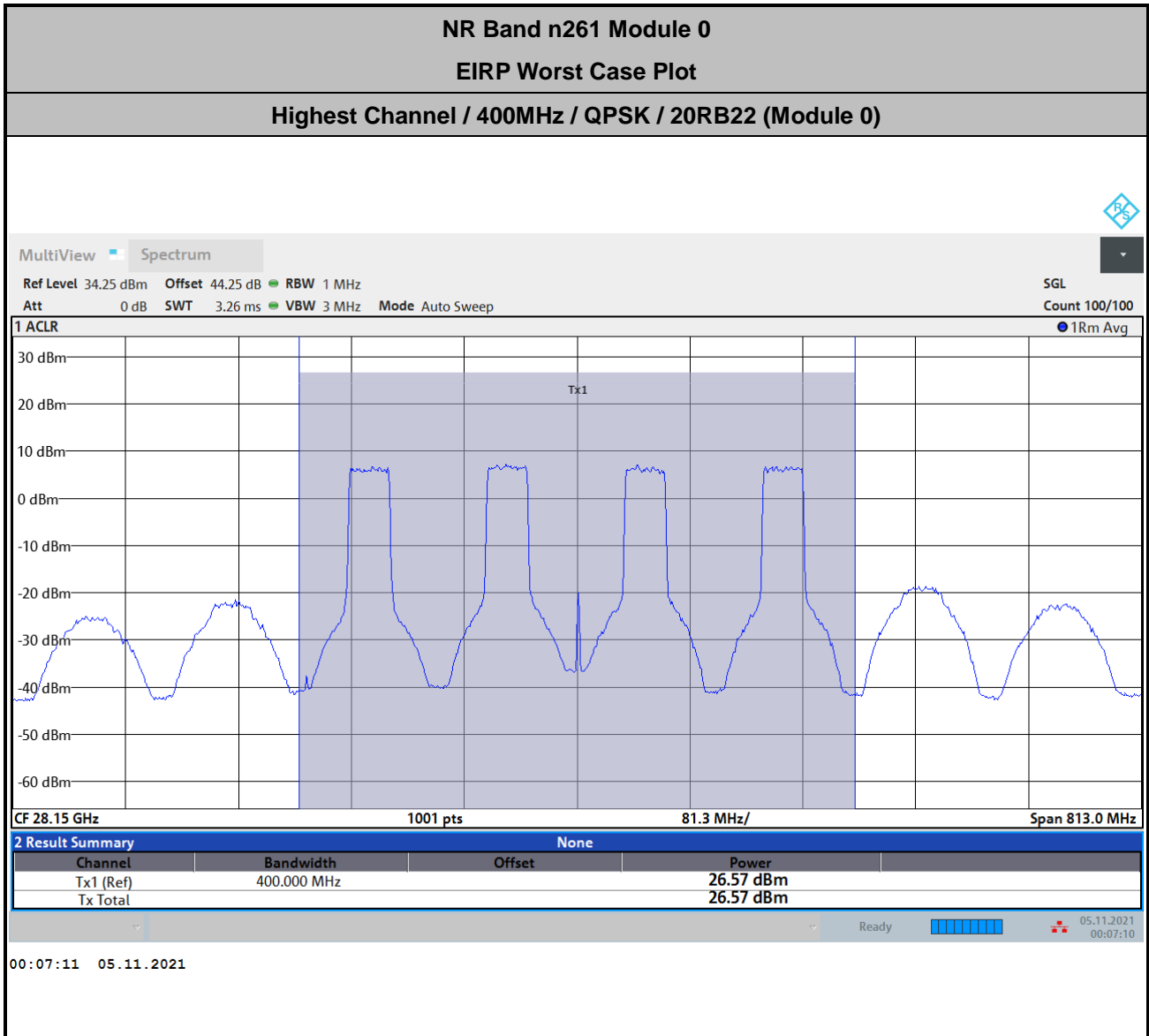

$$\text{Offset} = \text{Antenna Factor (dB/m)} + \text{Cable Loss (dB)} + 107 + 20\log(D) - 104.8$$

$$= 39.4 + 2.65 + 107 + 20\log(1) - 104.8 = 44.25 \text{ (dB)}$$



<Module 1>

NR Band n260 Module 1 AG0 (Beam ID:36 )					
Maximum Average EIRP [dBm]					
	BW [MHz]	Waveform	Modulation	Inner 1RB	Inner Full
Lowest	50	DFT-S	QPSK	28.21	28.17
	50	DFT-S	16QAM	26.15	26.03
	50	DFT-S	64QAM	24.06	23.98
	50	CP	QPSK	25.06	23.97
	100	DFT-S	QPSK	28.75	28.75
	100	DFT-S	16QAM	26.53	26.71
	100	DFT-S	64QAM	24.8	24.61
	100	CP	QPSK	25.61	25.6
	400	DFT-S	QPSK	21.99	23.97
	400	DFT-S	16QAM	21.82	22.32
	400	DFT-S	64QAM	20.75	20.51
	400	CP	QPSK	22.01	22.27
NR Band n260 Module 1 AG0 (Beam ID:36 )					
Maximum Average EIRP [dBm]					
	BW [MHz]	Waveform	Modulation	Inner 1RB	Inner Full
Middle	50	DFT-S	QPSK	27.16	26.87
	50	DFT-S	16QAM	24.54	24.91
	50	DFT-S	64QAM	22.86	22.83
	50	CP	QPSK	24.04	22.84
	100	DFT-S	QPSK	27.49	27.25
	100	DFT-S	16QAM	24.89	25.15
	100	DFT-S	64QAM	23.27	23.16
	100	CP	QPSK	24.36	24.13
	400	DFT-S	QPSK	20.3	22.54
	400	DFT-S	16QAM	20.09	20.91
	400	DFT-S	64QAM	19.07	19.15
	400	CP	QPSK	20.4	20.93



NR Band n260 Module 1 AG0 (Beam ID:36 )					
Maximum Average EIRP [dBm]					
	BW [MHz]	Waveform	Modulation	Inner 1RB	Inner Full
<b>Highest</b>	50	DFT-S	QPSK	24.76	24.58
	50	DFT-S	16QAM	22.38	22.51
	50	DFT-S	64QAM	20.73	20.57
	50	CP	QPSK	21.83	20.46
	100	DFT-S	QPSK	24.44	24.61
	100	DFT-S	16QAM	21.86	22.42
	100	DFT-S	64QAM	20.53	20.33
	100	CP	QPSK	21.48	21.4
	400	DFT-S	QPSK	17.47	19.36
	400	DFT-S	16QAM	17.25	17.75
	400	DFT-S	64QAM	16.1	15.99
	400	CP	QPSK	17.41	17.72

Note : The 400MHz Bandwidth is carrier aggregation by 4CC of 100MHz.

NR Band n260 Module 1 AG1 (Beam ID:164 )					
Maximum Average EIRP [dBm]					
	BW [MHz]	Waveform	Modulation	Inner 1RB	Inner Full
<b>Lowest</b>	50	DFT-S	QPSK	27.5	27.39
	50	DFT-S	16QAM	25.31	25.36
	50	DFT-S	64QAM	23.26	23.21
	50	CP	QPSK	24.28	23.25
	100	DFT-S	QPSK	27.75	27.8
	100	DFT-S	16QAM	25.42	25.84
	100	DFT-S	64QAM	23.85	23.74
	100	CP	QPSK	24.88	24.82
	400	DFT-S	QPSK	21.31	23.23
	400	DFT-S	16QAM	20.97	21.57
	400	DFT-S	64QAM	20.08	19.88
	400	CP	QPSK	21.27	21.62



NR Band n260 Module 1 AG1 (Beam ID:164 )					
Maximum Average EIRP [dBm]					
Middle	BW [MHz]	Waveform	Modulation	Inner 1RB	Inner Full
	50	DFT-S	QPSK	27.73	27.66
	50	DFT-S	16QAM	25.36	25.5
	50	DFT-S	64QAM	23.54	23.41
	50	CP	QPSK	24.65	23.51
	100	DFT-S	QPSK	28.14	27.9
	100	DFT-S	16QAM	25.59	25.75
	100	DFT-S	64QAM	24.09	23.71
	100	CP	QPSK	24.96	24.74
	400	DFT-S	QPSK	21.13	23.16
	400	DFT-S	16QAM	20.8	21.57
	400	DFT-S	64QAM	19.89	19.81
	400	CP	QPSK	21.16	21.61
NR Band n260 Module 1 AG1 (Beam ID:164 )					
Maximum Average EIRP [dBm]					
Highest	BW [MHz]	Waveform	Modulation	Inner 1RB	Inner Full
	50	DFT-S	QPSK	24.31	24.3
	50	DFT-S	16QAM	21.79	21.97
	50	DFT-S	64QAM	20.29	20.04
	50	CP	QPSK	21.13	20.07
	100	DFT-S	QPSK	23.71	23.96
	100	DFT-S	16QAM	21.06	21.72
	100	DFT-S	64QAM	19.44	19.72
	100	CP	QPSK	20.64	20.84
	400	DFT-S	QPSK	16.74	18.85
	400	DFT-S	16QAM	16.6	17.15
	400	DFT-S	64QAM	15.54	15.44
	400	CP	QPSK	16.72	17.1

Note : The 400MHz Bandwidth is carrier aggregation by 4CC of 100MHz.



NR Band n260 Module 1 AG0+1 (Beam ID:36+164 )					
Maximum Average EIRP [dBm]					
Lowest	BW [MHz]	Waveform	Modulation	Inner 1RB	Inner Full
	50	DFT-S	QPSK	<b>30.63</b>	30.20
	50	DFT-S	16QAM	28.53	28.07
	50	DFT-S	64QAM	26.32	26.09
	50	CP	QPSK	27.22	25.92
	100	DFT-S	QPSK	<b>31.54</b>	31.03
	100	DFT-S	16QAM	28.9	28.95
	100	DFT-S	64QAM	27.35	26.87
	100	CP	QPSK	28.27	27.84
	200	DFT-S	QPSK	25.32	<b>27.44</b>
	200	DFT-S	16QAM	25.26	25.79
	200	DFT-S	64QAM	23.89	23.96
	200	CP	QPSK	25.43	25.88
	300	DFT-S	QPSK	24.85	<b>27.20</b>
	300	DFT-S	16QAM	24.76	25.63
	300	DFT-S	64QAM	23.42	23.77
	300	CP	QPSK	24.60	25.71
	400	DFT-S	QPSK	23.99	<b>26.13</b>
	400	DFT-S	16QAM	23.86	24.34
	400	DFT-S	64QAM	22.77	22.58
400	CP	QPSK	23.91	24.17	





NR Band n260 Module 1 AG0+1 (Beam ID:36+164 )					
Maximum Average EIRP [dBm]					
	BW [MHz]	Waveform	Modulation	Inner 1RB	Inner Full
Middle	50	DFT-S	QPSK	29.53	29.12
	50	DFT-S	16QAM	26.93	26.88
	50	DFT-S	64QAM	25.42	24.98
	50	CP	QPSK	26.36	24.82
	100	DFT-S	QPSK	30.27	29.48
	100	DFT-S	16QAM	27.7	27.32
	100	DFT-S	64QAM	25.96	25.33
	100	CP	QPSK	27.12	26.29
	200	DFT-S	QPSK	24.39	26.79
	200	DFT-S	16QAM	23.99	25.01
	200	DFT-S	64QAM	23.11	23.14
	200	CP	QPSK	24.55	25.06
	300	DFT-S	QPSK	21.97	24.4
	300	DFT-S	16QAM	21.74	22.78
	300	DFT-S	64QAM	20.69	20.9
	300	CP	QPSK	21.79	22.71
	400	DFT-S	QPSK	22.5	24.56
	400	DFT-S	16QAM	22.2	22.8
400	DFT-S	64QAM	21.25	21.1	
400	CP	QPSK	22.54	23.13	



NR Band n260 Module 1 AG0+1 (Beam ID:36+164 )					
Maximum Average EIRP [dBm]					
	BW [MHz]	Waveform	Modulation	Inner 1RB	Inner Full
Highest	50	DFT-S	QPSK	28.47	28.08
	50	DFT-S	16QAM	25.86	25.9
	50	DFT-S	64QAM	24.28	23.88
	50	CP	QPSK	25.4	23.8
	100	DFT-S	QPSK	28.76	28.17
	100	DFT-S	16QAM	26.52	26.09
	100	DFT-S	64QAM	24.63	23.95
	100	CP	QPSK	25.77	24.97
	200	DFT-S	QPSK	22.83	24.78
	200	DFT-S	16QAM	22.52	23.1
	200	DFT-S	64QAM	21.49	21.3
	200	CP	QPSK	22.94	23.43
	300	DFT-S	QPSK	22.28	24.36
	300	DFT-S	16QAM	22.13	22.81
	300	DFT-S	64QAM	20.85	20.86
	300	CP	QPSK	22.25	22.75
	400	DFT-S	QPSK	20.72	22.57
	400	DFT-S	16QAM	20.52	20.9
400	DFT-S	64QAM	19.5	19.15	
400	CP	QPSK	20.95	21.15	

Note : The 200/300/400MHz Bandwidth is carrier aggregation by 2/3/4CC of 100MHz.

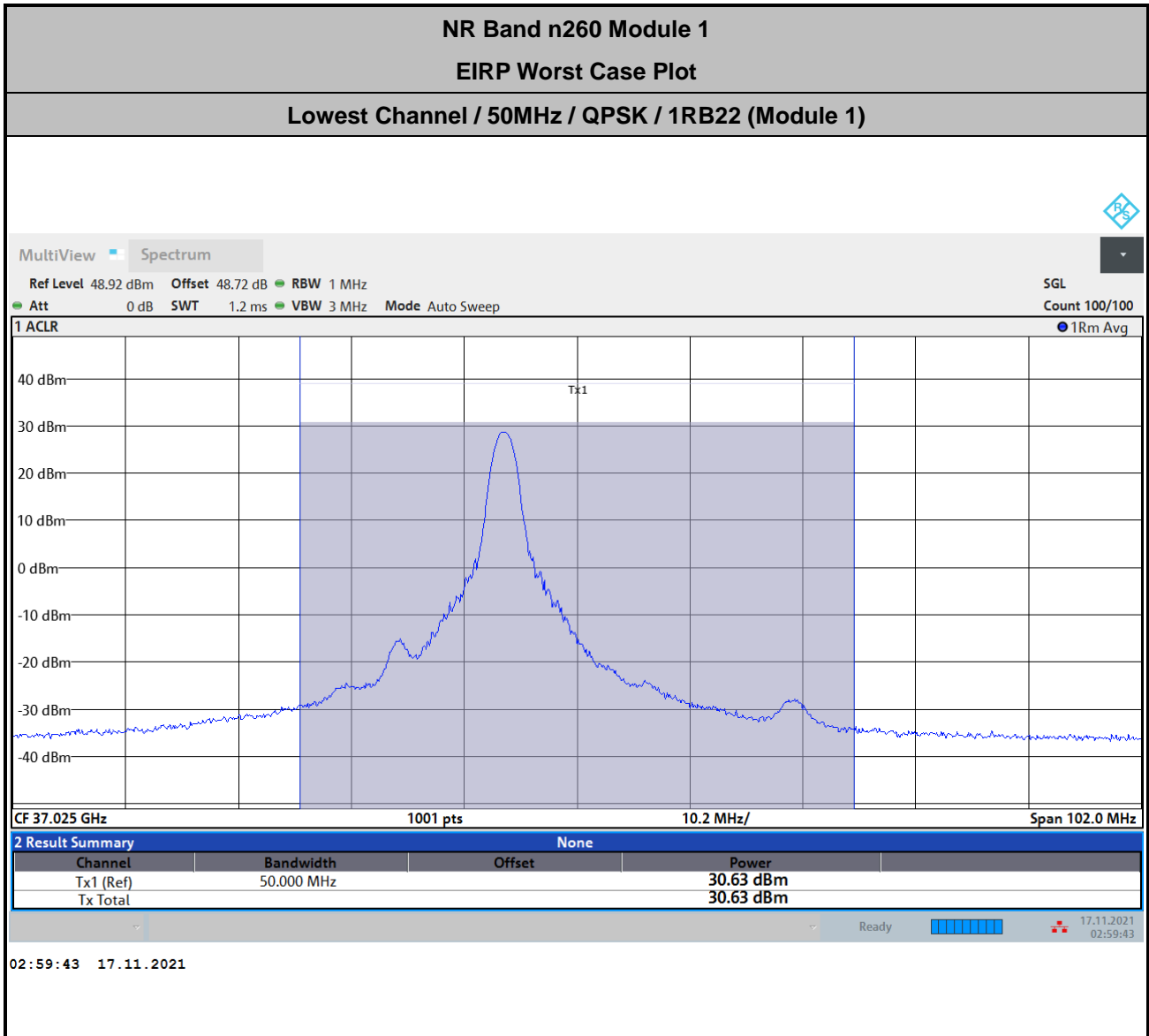

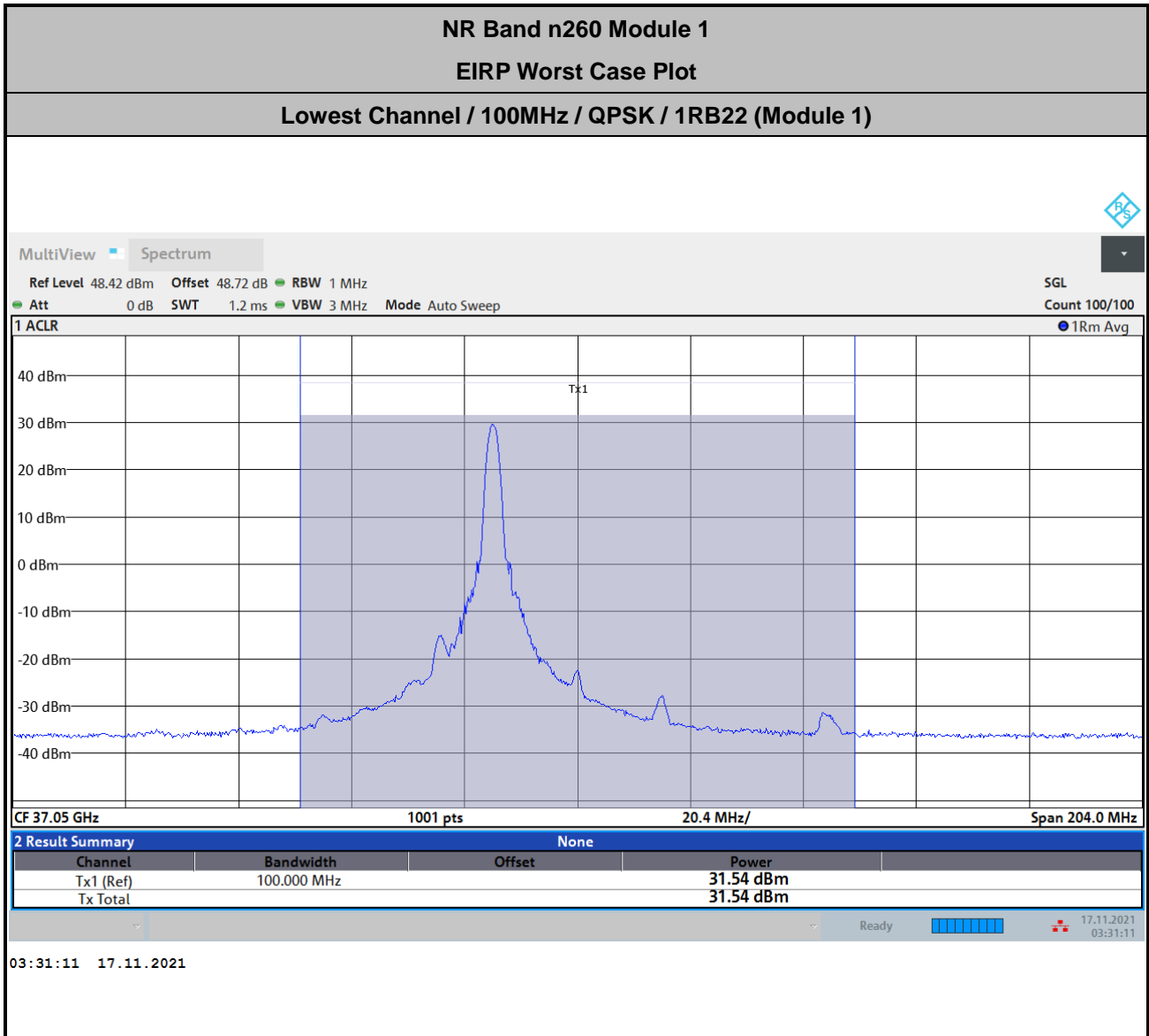

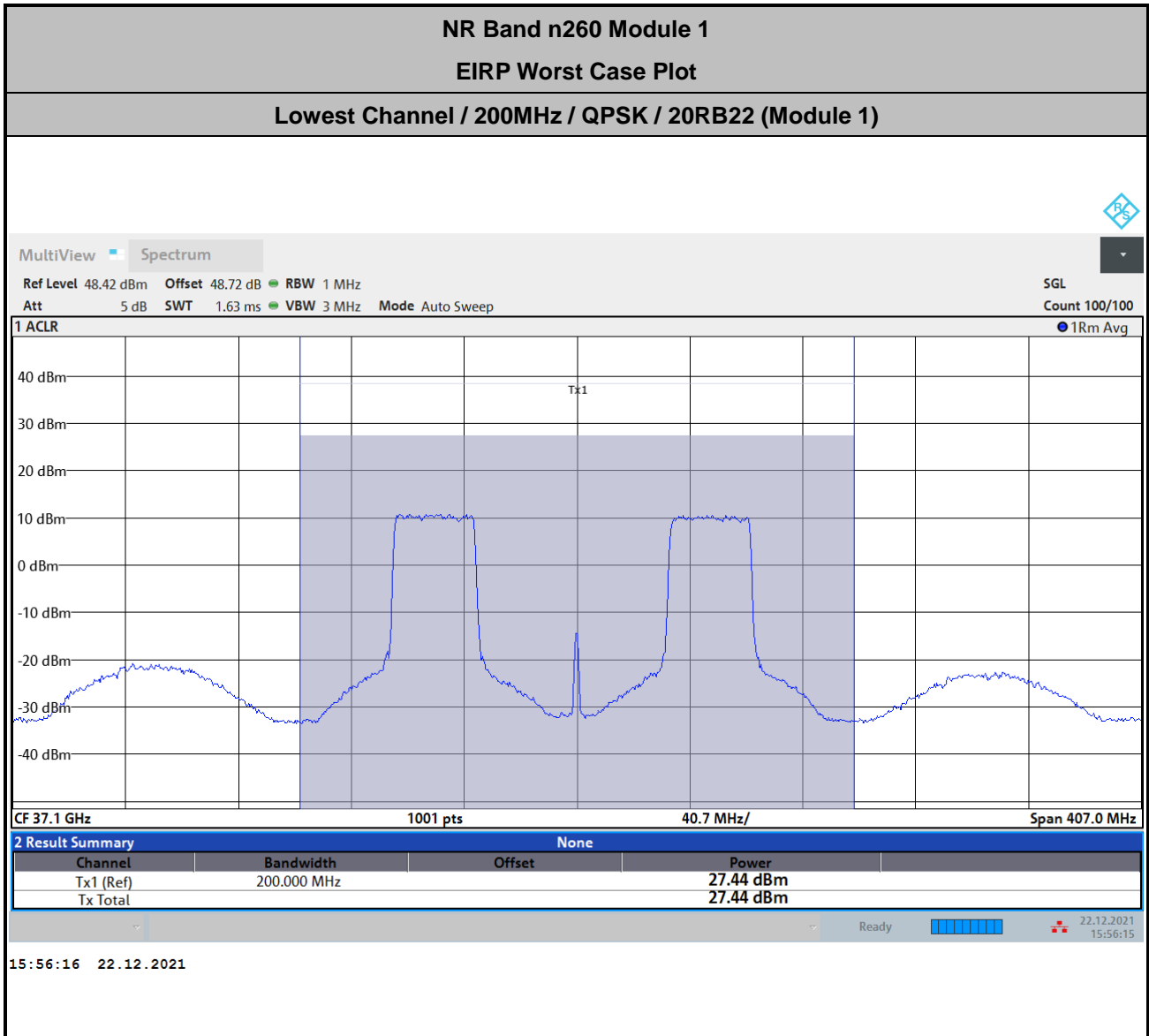

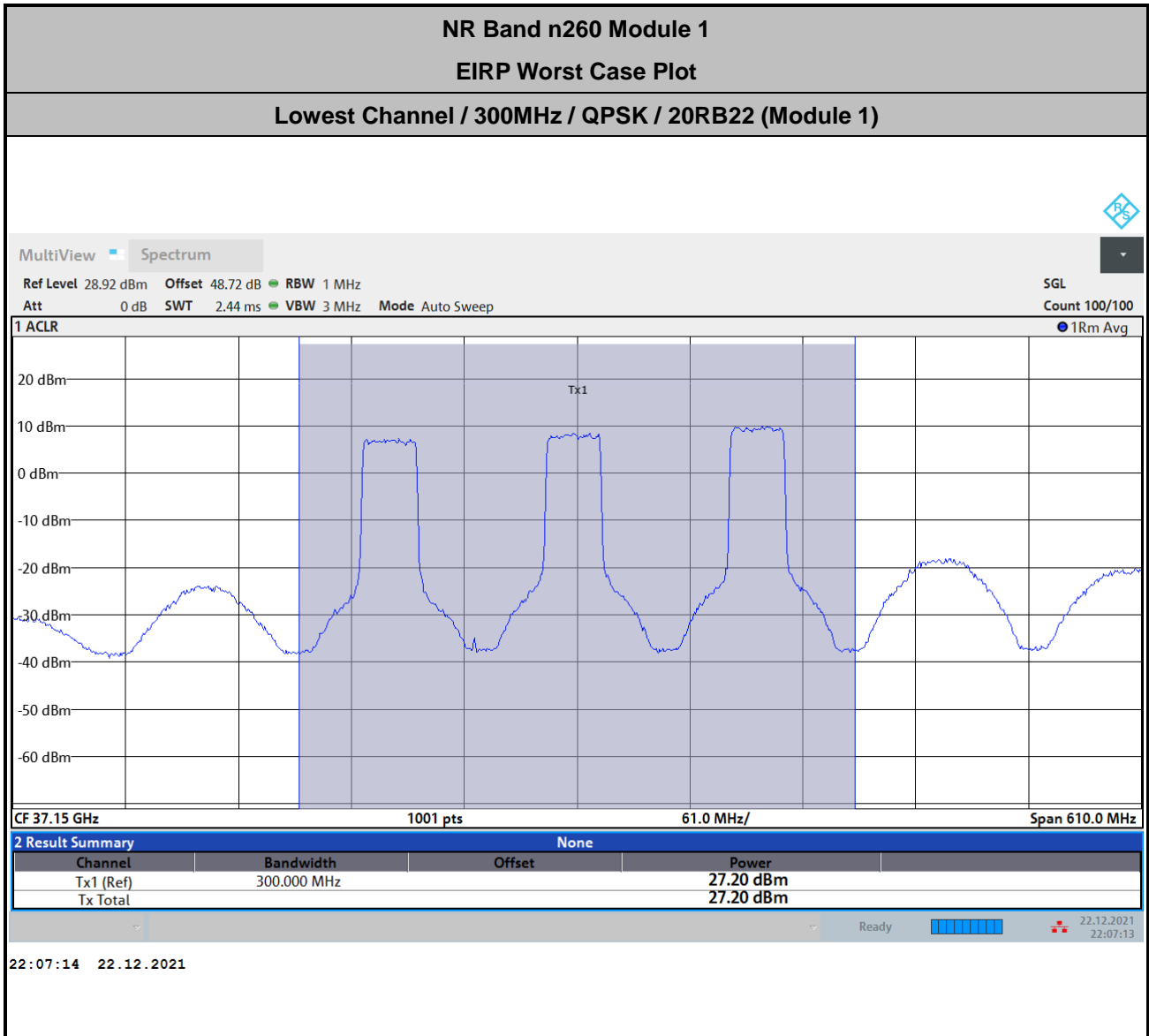

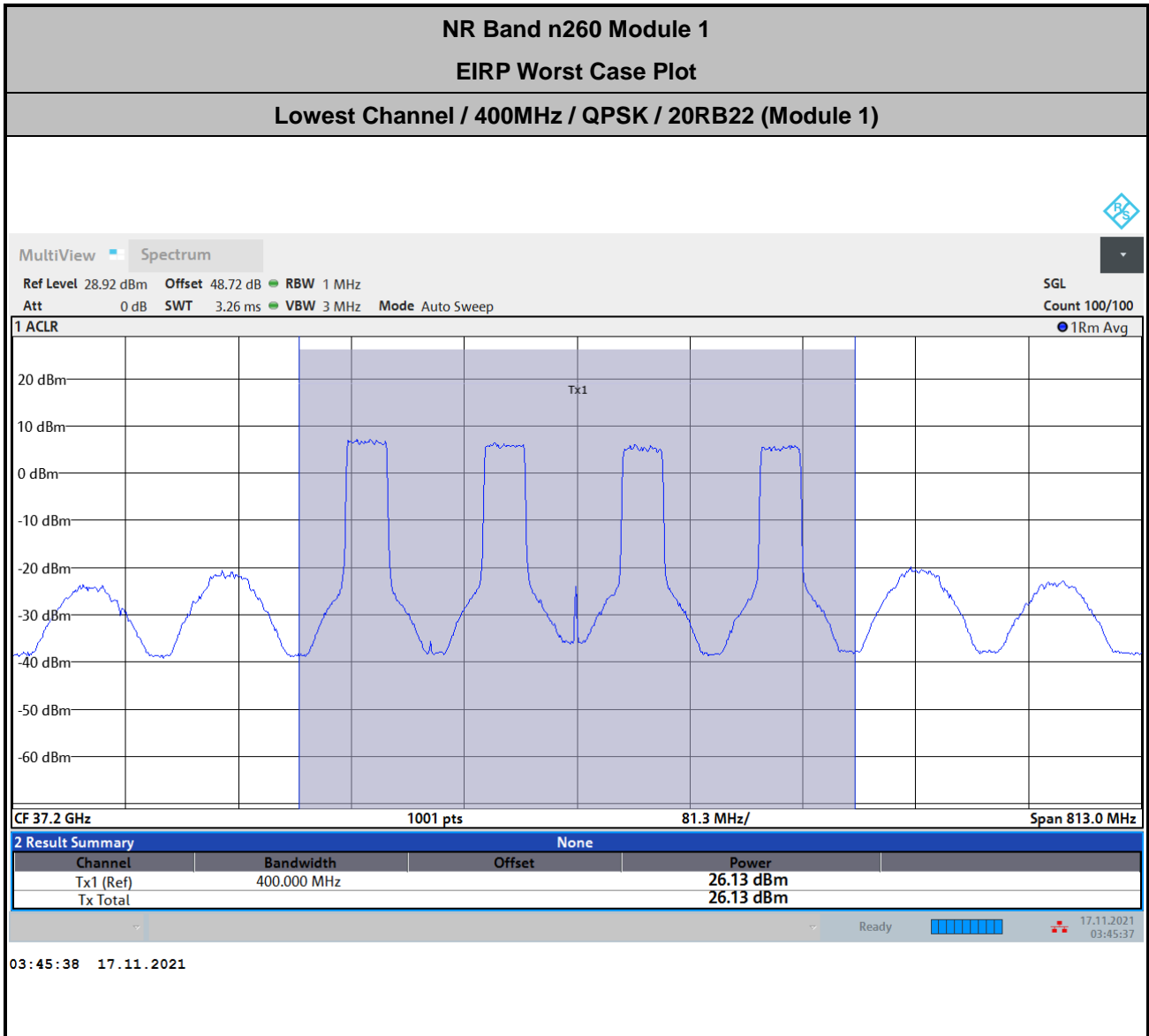

$$\text{Offset} = \text{Antenna Factor (dB/m)} + \text{Cable Loss (dB)} + 107 + 20\log(D) - 104.8$$

$$= 43.8 + 2.72 + 107 + 20\log(1) - 104.8 = 48.72 \text{ (dB)}$$



NR Band n261 Module 1 AG0 (Beam ID:36 )					
Maximum Average EIRP [dBm]					
Lowest	BW [MHz]	Waveform	Modulation	Inner 1RB	Inner Full
	50	DFT-S	QPSK	29.37	29.29
	50	DFT-S	16QAM	27.07	27.3
	50	DFT-S	64QAM	25.28	25.2
	50	CP	QPSK	25.92	25.08
	100	DFT-S	QPSK	28.84	28.76
	100	DFT-S	16QAM	26.28	26.62
	100	DFT-S	64QAM	24.85	24.58
	100	CP	QPSK	26.02	25.8
	400	DFT-S	QPSK	21.8	24.35
	400	DFT-S	16QAM	21.46	22.39
	400	DFT-S	64QAM	20.64	20.43
	400	CP	QPSK	21.8	22.48
NR Band n261 Module 1 AG0 (Beam ID:36 )					
Maximum Average EIRP [dBm]					
Middle	BW [MHz]	Waveform	Modulation	Inner 1RB	Inner Full
	50	DFT-S	QPSK	27.04	27.34
	50	DFT-S	16QAM	25.15	25.23
	50	DFT-S	64QAM	23.07	23.13
	50	CP	QPSK	24.15	23.18
	100	DFT-S	QPSK	27.34	27.45
	100	DFT-S	16QAM	24.92	25.61
	100	DFT-S	64QAM	23.46	23.57
	100	CP	QPSK	24.15	24.46
	400	DFT-S	QPSK	21.02	23.61
	400	DFT-S	16QAM	20.86	21.66
	400	DFT-S	64QAM	19.95	19.68
	400	CP	QPSK	21.1	21.64





NR Band n261 Module 1 AG0 (Beam ID:36 )					
Maximum Average EIRP [dBm]					
	BW [MHz]	Waveform	Modulation	Inner 1RB	Inner Full
Highest	50	DFT-S	QPSK	27.72	27.65
	50	DFT-S	16QAM	25.16	25.4
	50	DFT-S	64QAM	23.63	23.6
	50	CP	QPSK	24.64	23.62
	100	DFT-S	QPSK	27.88	27.73
	100	DFT-S	16QAM	25.47	25.71
	100	DFT-S	64QAM	23.73	23.69
	100	CP	QPSK	24.71	24.66
	400	DFT-S	QPSK	21.32	24.02
	400	DFT-S	16QAM	21.04	22.03
	400	DFT-S	64QAM	20.17	20.01
	400	CP	QPSK	21.14	21.96

Note : The 400MHz Bandwidth is carrier aggregation by 4CC of 100MHz.

NR Band n261 Module 1 AG1 (Beam ID:164 )					
Maximum Average EIRP [dBm]					
	BW [MHz]	Waveform	Modulation	Inner 1RB	Inner Full
Lowest	50	DFT-S	QPSK	28.73	28.32
	50	DFT-S	16QAM	26.53	26.35
	50	DFT-S	64QAM	24.33	24.3
	50	CP	QPSK	25.45	24.6
	100	DFT-S	QPSK	28.43	28.23
	100	DFT-S	16QAM	26.03	26.25
	100	DFT-S	64QAM	24.61	24.25
	100	CP	QPSK	25.73	25.43
	400	DFT-S	QPSK	21.68	24.26
	400	DFT-S	16QAM	21.52	22.26
	400	DFT-S	64QAM	20.57	20.37
	400	CP	QPSK	21.76	22.37



NR Band n261 Module 1 AG1 (Beam ID:164 )					
Maximum Average EIRP [dBm]					
Middle	BW [MHz]	Waveform	Modulation	Inner 1RB	Inner Full
	50	DFT-S	QPSK	27.77	27.85
	50	DFT-S	16QAM	24.94	25.88
	50	DFT-S	64QAM	23.71	23.65
	50	CP	QPSK	25	23.95
	100	DFT-S	QPSK	27.32	27.42
	100	DFT-S	16QAM	24.84	25.41
	100	DFT-S	64QAM	23.13	23.35
	100	CP	QPSK	24.09	24.27
	400	DFT-S	QPSK	21.02	23.49
	400	DFT-S	16QAM	20.84	21.51
	400	DFT-S	64QAM	19.9	19.53
	400	CP	QPSK	20.85	21.52
NR Band n261 Module 1 AG1 (Beam ID:164 )					
Maximum Average EIRP [dBm]					
Highest	BW [MHz]	Waveform	Modulation	Inner 1RB	Inner Full
	50	DFT-S	QPSK	27.04	26.95
	50	DFT-S	16QAM	24.63	24.94
	50	DFT-S	64QAM	23.11	22.97
	50	CP	QPSK	23.92	22.81
	100	DFT-S	QPSK	27.24	27.26
	100	DFT-S	16QAM	24.98	25.14
	100	DFT-S	64QAM	23.39	23.22
	100	CP	QPSK	24.17	24.12
	400	DFT-S	QPSK	20.83	23.6
	400	DFT-S	16QAM	20.73	21.61
	400	DFT-S	64QAM	19.81	19.62
	400	CP	QPSK	20.78	21.58

Note : The 400MHz Bandwidth is carrier aggregation by 4CC of 100MHz.



NR Band n261 Module 1 AG0+1 (Beam ID:36+164 )					
Maximum Average EIRP [dBm]					
	BW [MHz]	Waveform	Modulation	Inner 1RB	Inner Full
Lowest	50	DFT-S	QPSK	30.33	<b>30.67</b>
	50	DFT-S	16QAM	28.22	28.7
	50	DFT-S	64QAM	26.27	26.75
	50	CP	QPSK	26.87	26.63
	100	DFT-S	QPSK	28.84	<b>30.11</b>
	100	DFT-S	16QAM	26.39	28.02
	100	DFT-S	64QAM	24.8	25.98
	100	CP	QPSK	26.35	27.18
	200	DFT-S	QPSK	23.9	<b>26.76</b>
	200	DFT-S	16QAM	23.62	24.76
	200	DFT-S	64QAM	22.06	22.64
	200	CP	QPSK	23.69	24.73
	300	DFT-S	QPSK	23.72	<b>26.81</b>
	300	DFT-S	16QAM	23.3	24.75
	300	DFT-S	64QAM	22.53	22.62
	300	CP	QPSK	23.58	24.72
	400	DFT-S	QPSK	23.68	<b>26.45</b>
	400	DFT-S	16QAM	23.56	24.52
400	DFT-S	64QAM	22.48	22.39	
400	CP	QPSK	23.46	24.72	



NR Band n261 Module 1 AG0+1 (Beam ID:36+164 )					
Maximum Average EIRP [dBm]					
	BW [MHz]	Waveform	Modulation	Inner 1RB	Inner Full
Middle	50	DFT-S	QPSK	28.68	29.41
	50	DFT-S	16QAM	26.31	27.47
	50	DFT-S	64QAM	24.77	25.41
	50	CP	QPSK	25.95	25.53
	100	DFT-S	QPSK	28.43	29.68
	100	DFT-S	16QAM	26.05	27.62
	100	DFT-S	64QAM	23.98	25.58
	100	CP	QPSK	25.02	26.55
	200	DFT-S	QPSK	22.96	25.79
	200	DFT-S	16QAM	22.71	23.88
	200	DFT-S	64QAM	21.56	21.73
	200	CP	QPSK	22.74	23.89
	300	DFT-S	QPSK	22.47	25.9
	300	DFT-S	16QAM	22.32	23.89
	300	DFT-S	64QAM	21.25	21.85
	300	CP	QPSK	22.36	23.9
	400	DFT-S	QPSK	23.15	25.93
	400	DFT-S	16QAM	23.1	24.07
400	DFT-S	64QAM	21.85	22.02	
400	CP	QPSK	22.65	23.7	



NR Band n261 Module 1 AG0+1 (Beam ID:36+164 )					
Maximum Average EIRP [dBm]					
	BW [MHz]	Waveform	Modulation	Inner 1RB	Inner Full
Highest	50	DFT-S	QPSK	29.08	29.86
	50	DFT-S	16QAM	26.7	27.75
	50	DFT-S	64QAM	25.21	25.84
	50	CP	QPSK	26.08	25.75
	100	DFT-S	QPSK	27.74	29.51
	100	DFT-S	16QAM	25.54	27.6
	100	DFT-S	64QAM	24.79	25.44
	100	CP	QPSK	24.61	26.64
	200	DFT-S	QPSK	22.57	25.44
	200	DFT-S	16QAM	22.11	23.37
	200	DFT-S	64QAM	21.07	21.35
	200	CP	QPSK	22.4	23.41
	300	DFT-S	QPSK	22.66	25.82
	300	DFT-S	16QAM	22.62	23.68
	300	DFT-S	64QAM	21.49	21.6
	300	CP	QPSK	22.47	23.76
	400	DFT-S	QPSK	22.78	25.81
	400	DFT-S	16QAM	22.73	23.98
	400	DFT-S	64QAM	21.69	21.84
400	CP	QPSK	22.72	23.81	

Note : The 200/300/400MHz Bandwidth is carrier aggregation by 2/3/4CC of 100MHz.

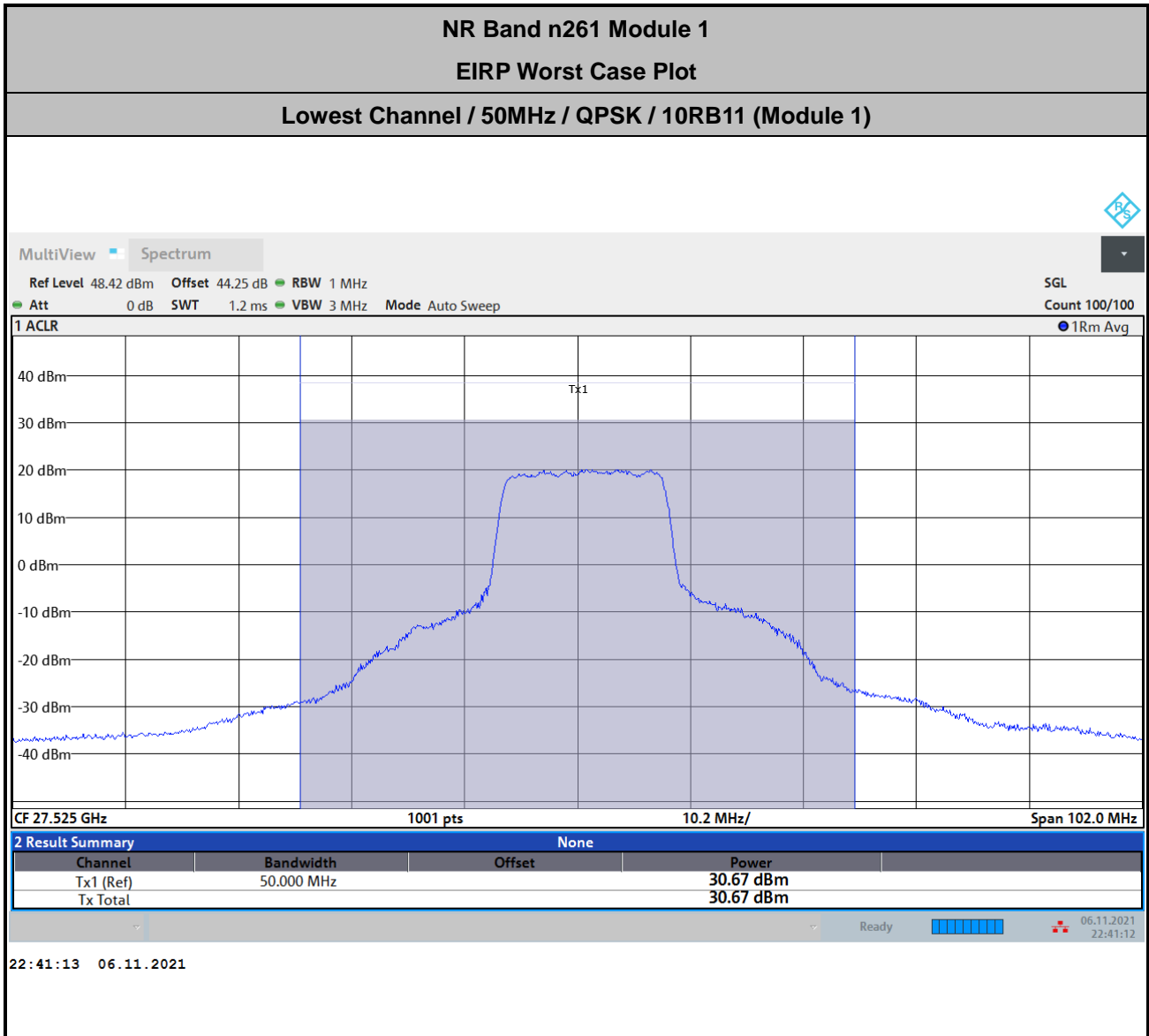

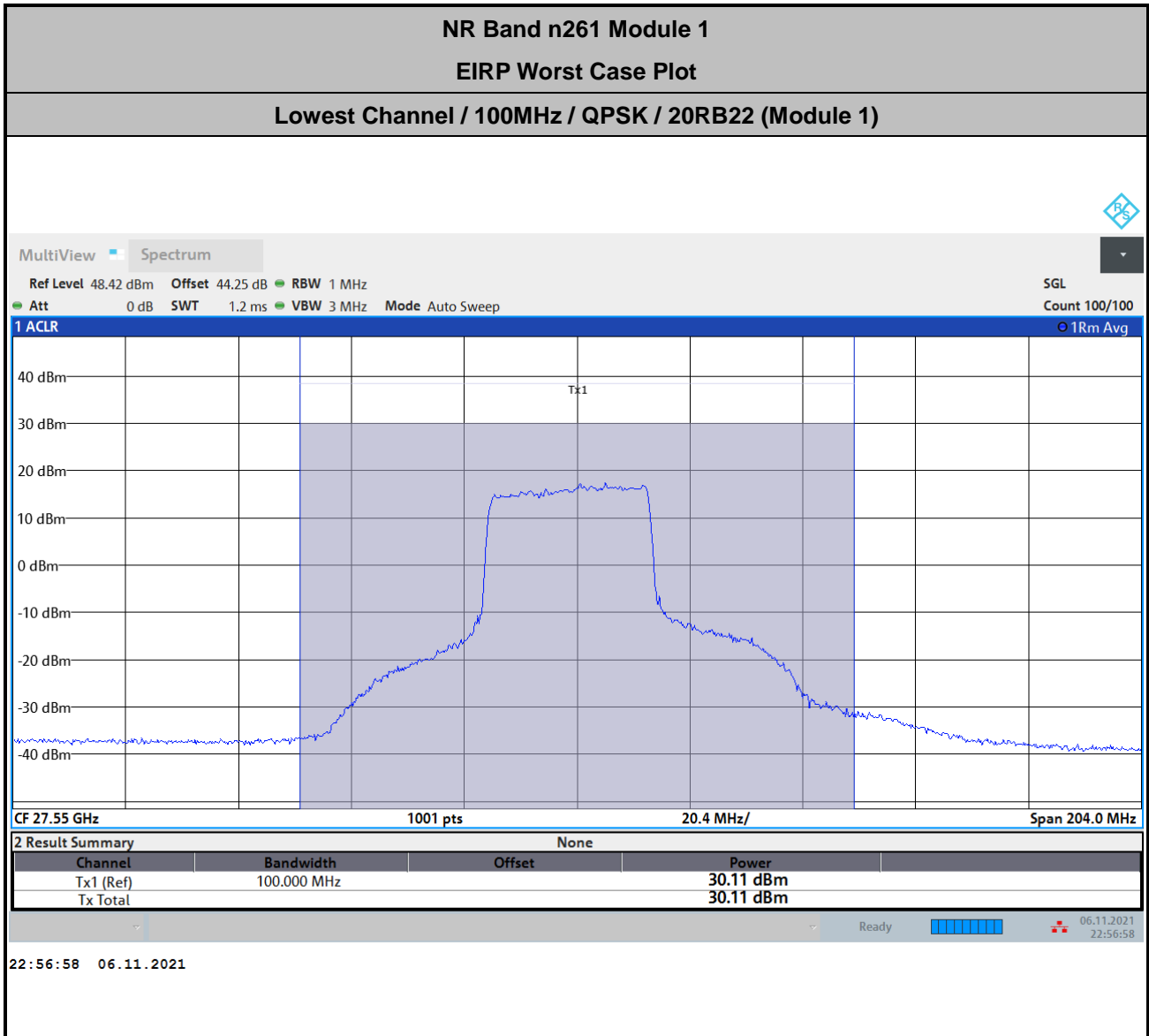

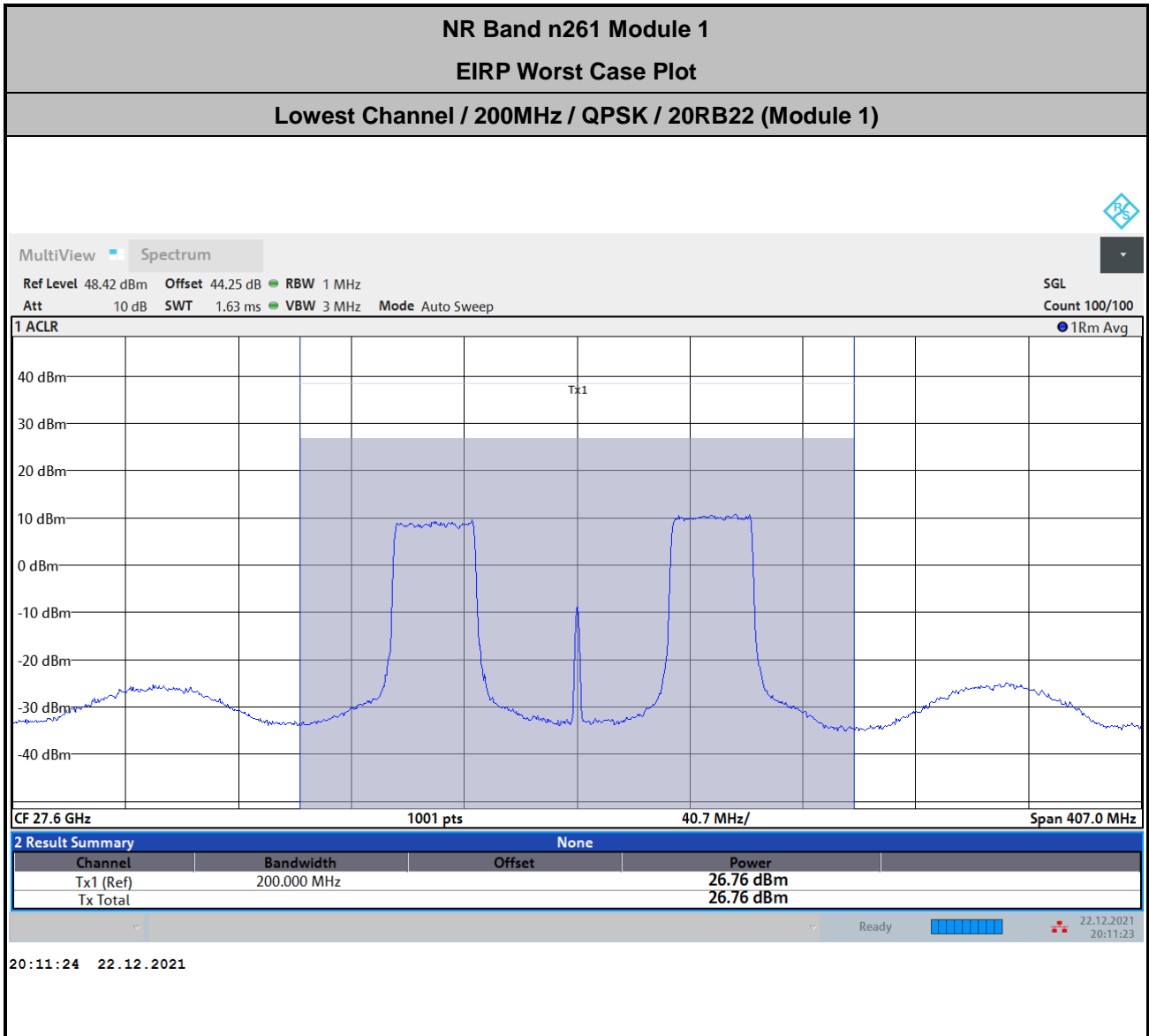



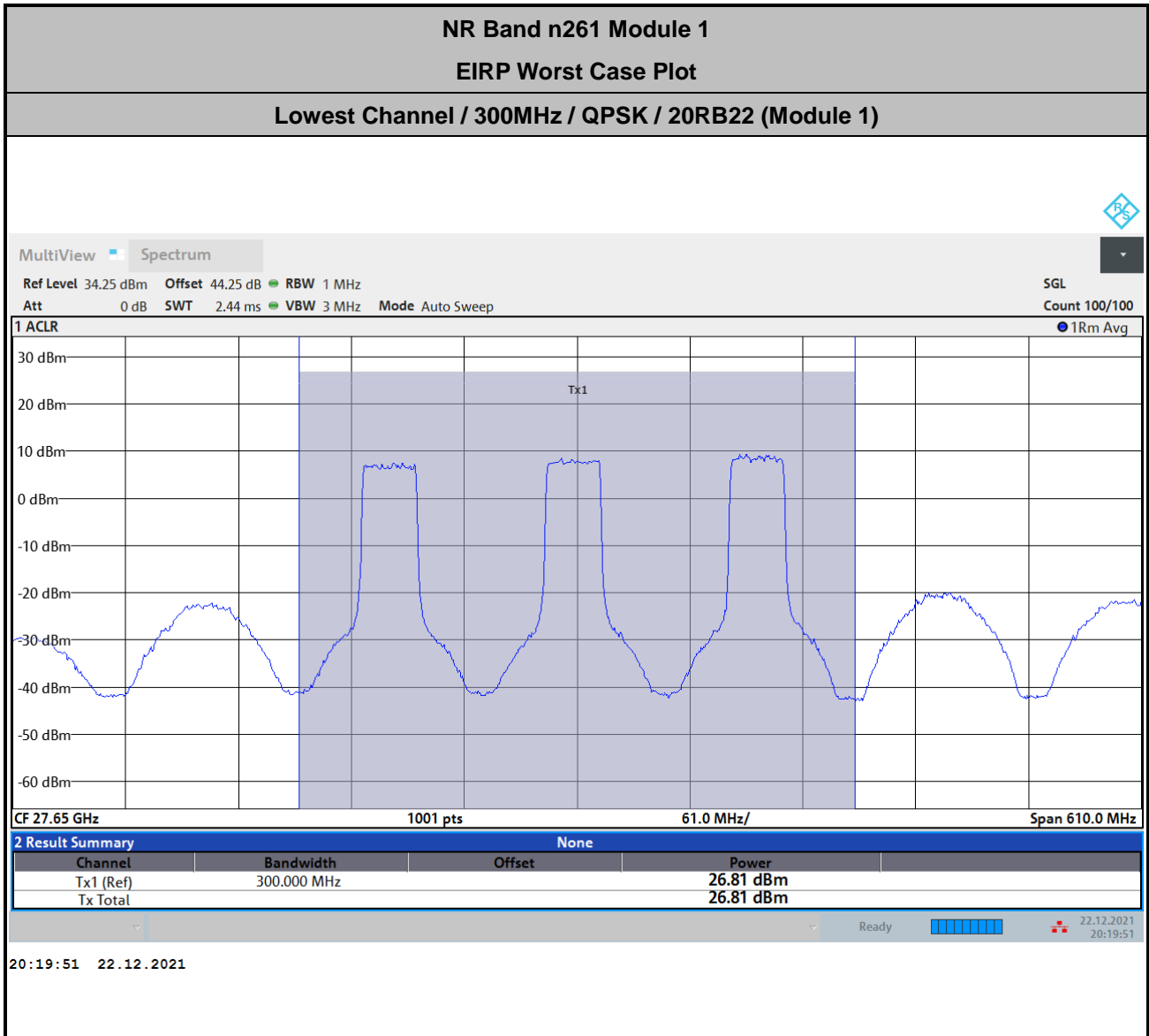

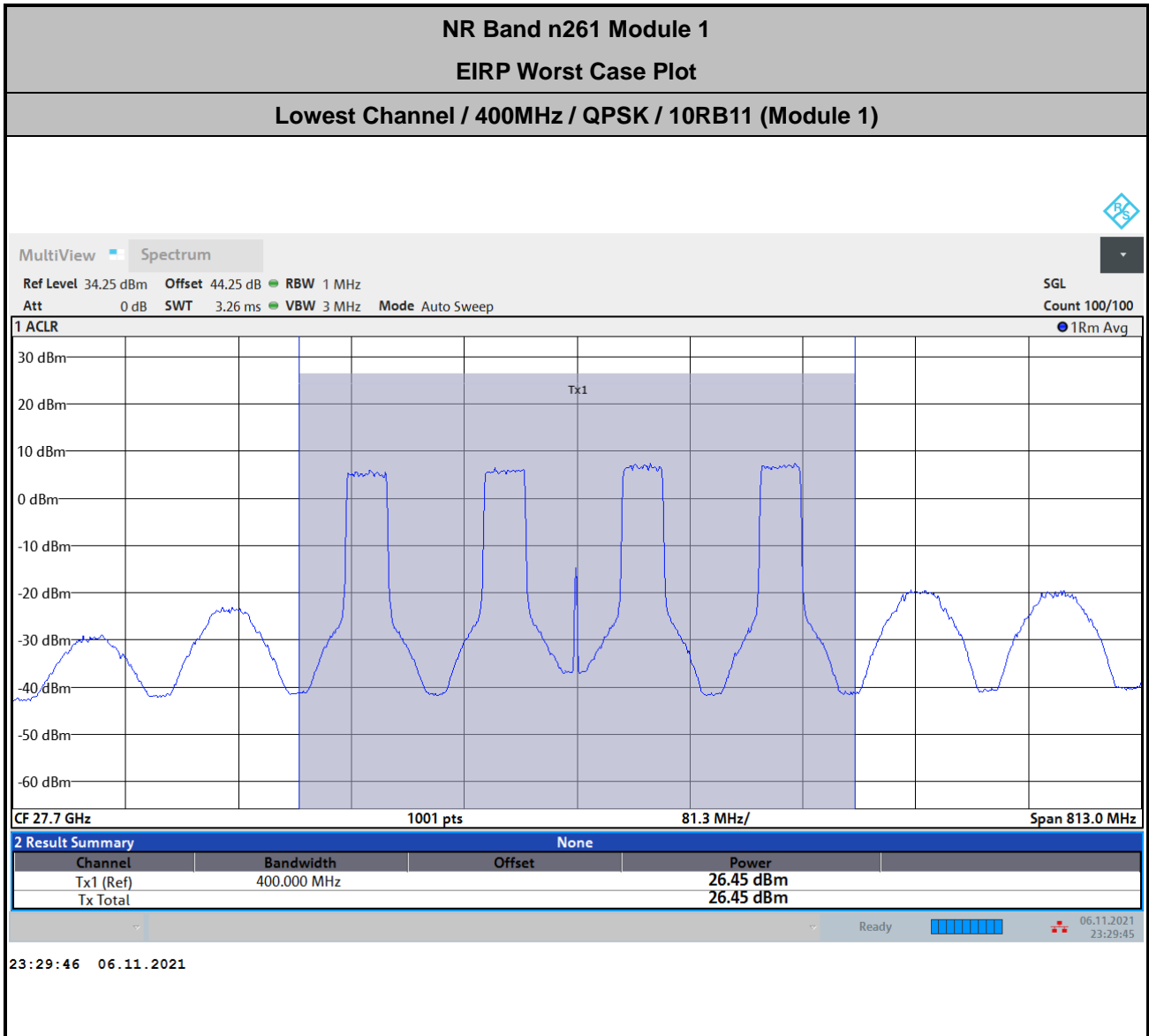

$$\text{Offset} = \text{Antenna Factor (dB/m)} + \text{Cable Loss (dB)} + 107 + 20\log(D) - 104.8$$

$$= 39.4 + 2.65 + 107 + 20\log(1) - 104.8 = 44.25 \text{ (dB)}$$



## NR Band n260 Module 0 AG0

### Occupied Bandwidth

Mode	DFT-s-OFDM Module 0 NR Band n260 : 99%OBW(MHz)					
BW	50MHz			100MHz		
Mod.	QPSK	16QAM	64QAM	QPSK	16QAM	64QAM
Lowest CH	46.04	45.86	45.92	91.34	91.34	91.49
Middle CH	45.90	45.66	46.13	91.22	90.98	91.33
Highest CH	45.91	45.99	46.08	91.46	91.21	91.49

Mode	DFT-s-OFDM Module 0 NR Band n260 : 99%OBW(MHz)					
BW	400MHz					
Mod.	QPSK	16QAM	64QAM			
Lowest CH	387.87	387.33	388.32			
Middle CH	386.89	386.54	387.39			
Highest CH	388.63	387.62	388.28			

Mode	CP-OFDM Module 0 NR Band n260 : 99%OBW(MHz)	
BW	50MHz	100MHz
Mod.	QPSK	QPSK
Lowest CH	46.14	94.43
Middle CH	45.93	93.91
Highest CH	45.89	94.11

Mode	CP-OFDM Module 0 NR Band n260 : 99%OBW(MHz)	
BW	400MHz	
Mod.	QPSK	
Lowest CH	390.37	
Middle CH	389.85	
Highest CH	390.30	



DFT-s-OFDM Module 0

NR Band n260

Lowest Channel / 50MHz / QPSK

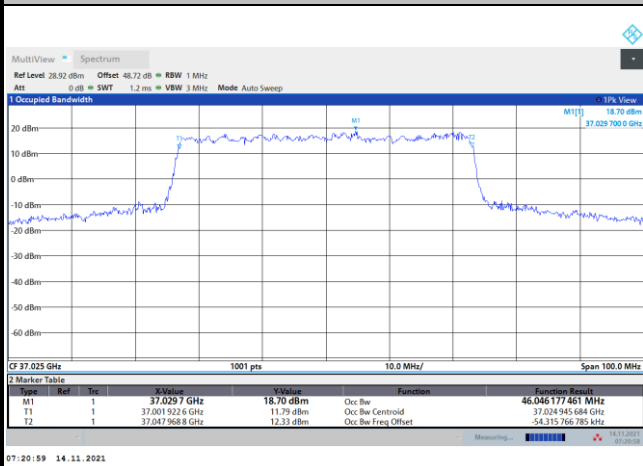

Lowest Channel / 50MHz / 16QAM

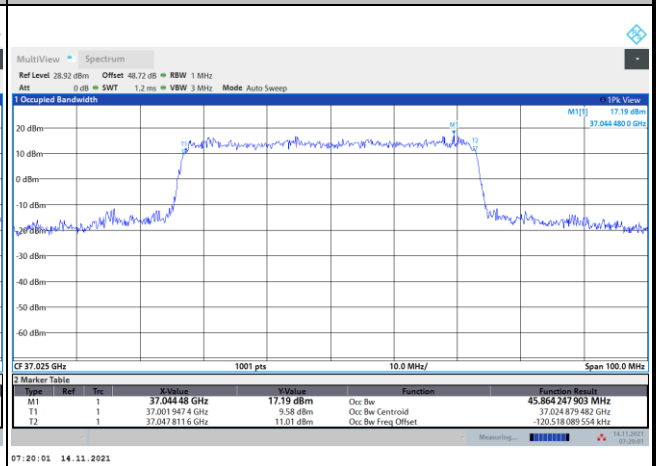

Middle Channel / 50MHz / QPSK

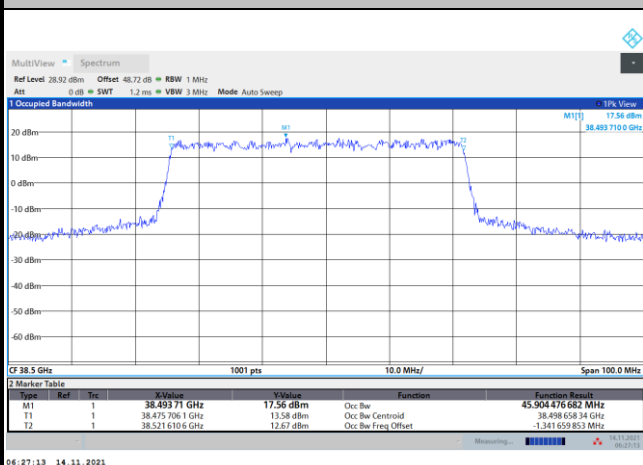

Middle Channel / 50MHz / 16QAM

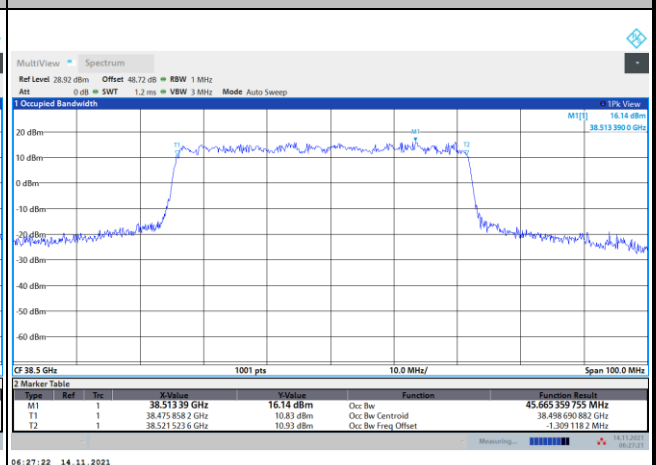

Highest Channel / 50MHz / QPSK

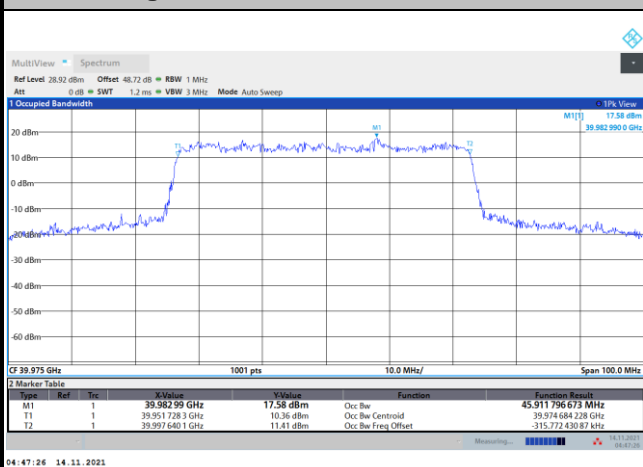

Highest Channel / 50MHz / 16QAM

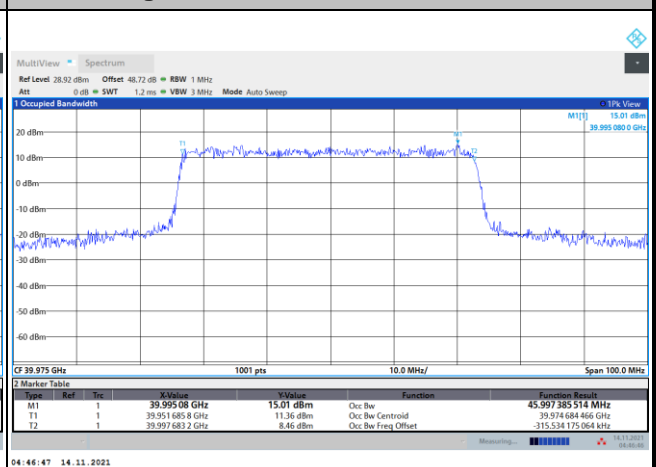



DFT-s-OFDM Module 0

NR Band n260

Lowest Channel / 50MHz / 64QAM

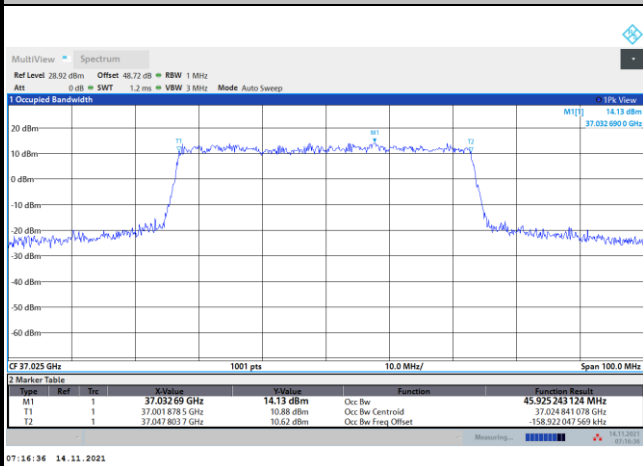

Lowest Channel / 100MHz / QPSK

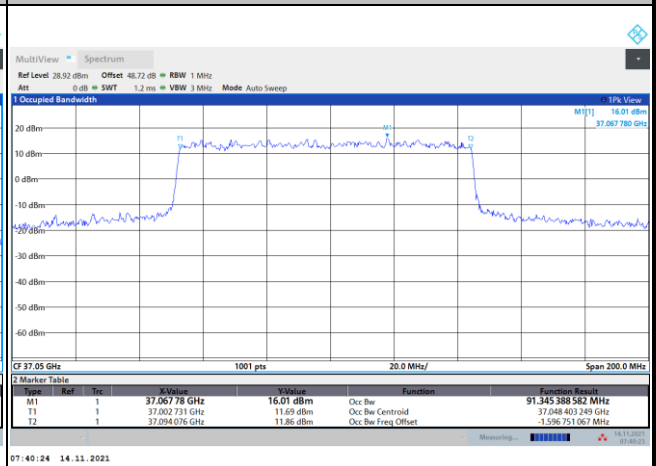

Middle Channel / 50MHz / 64QAM

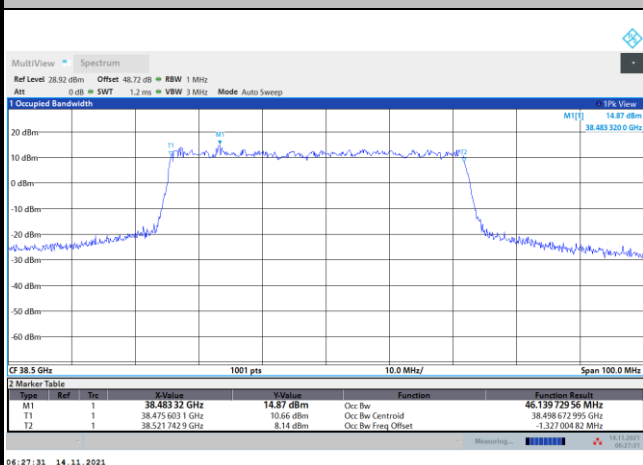

Middle Channel / 100MHz / QPSK

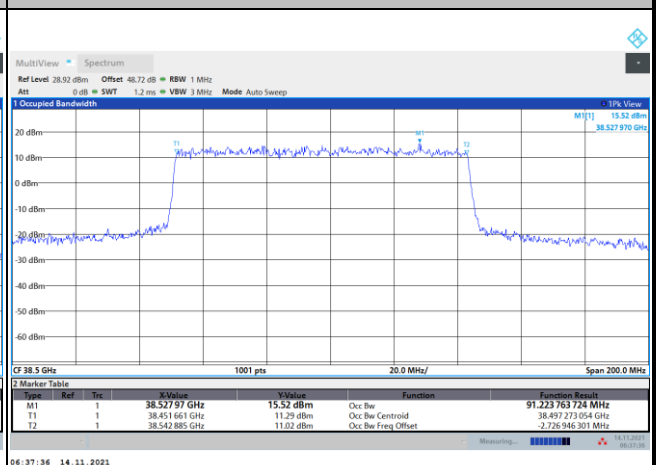

Highest Channel / 50MHz / 64QAM

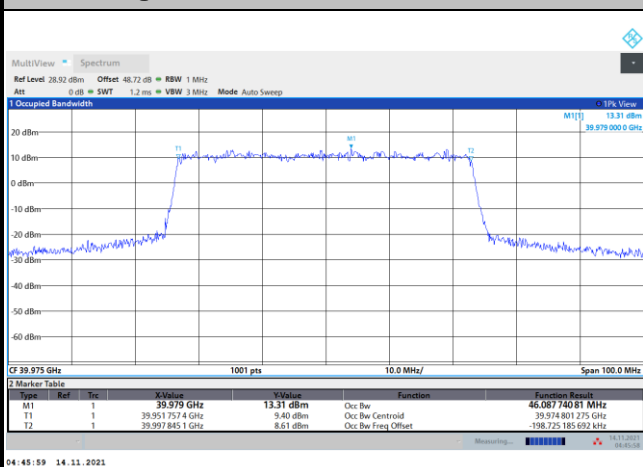

Highest Channel / 100MHz / QPSK

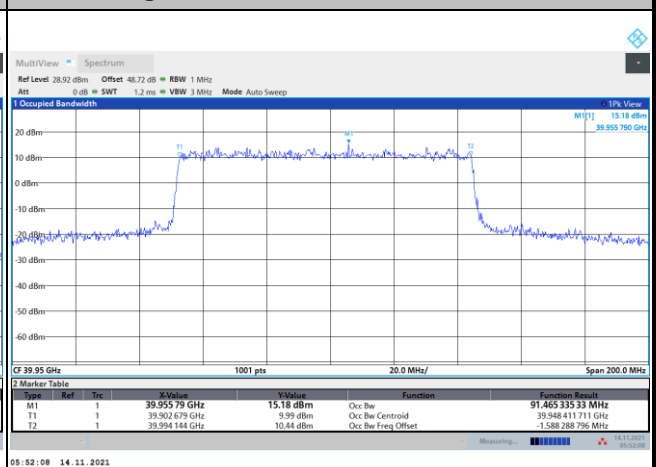



DFT-s-OFDM Module 0

NR Band n260

Lowest Channel / 100MHz / 16QAM

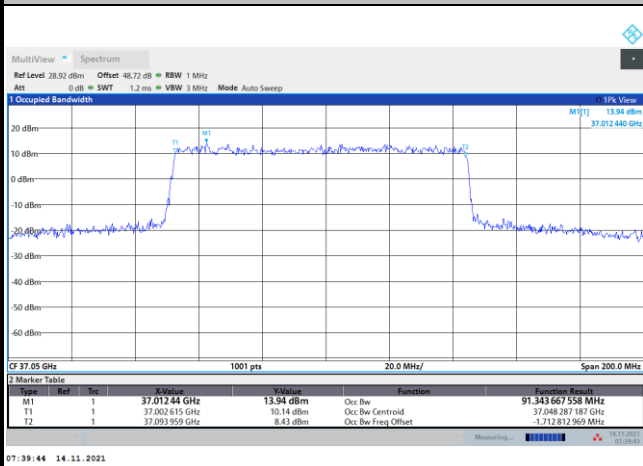

Lowest Channel / 100MHz / 64QAM

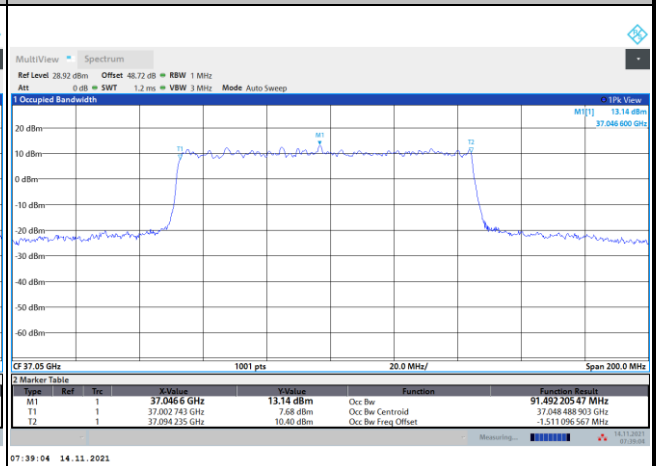

Middle Channel / 100MHz / 16QAM

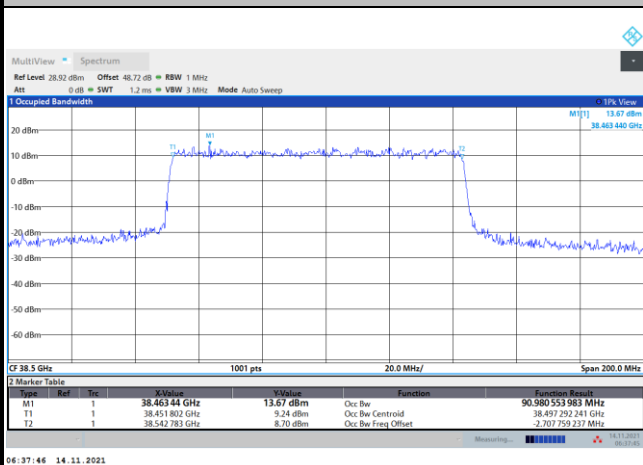

Middle Channel / 100MHz / 64QAM

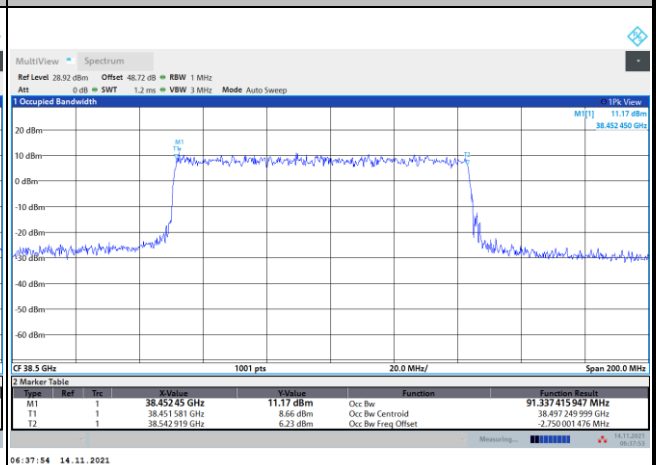

Highest Channel / 100MHz / 16QAM

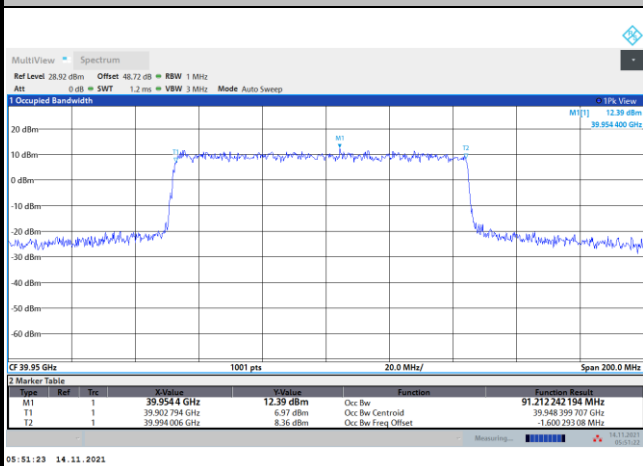

Highest Channel / 100MHz / 64QAM

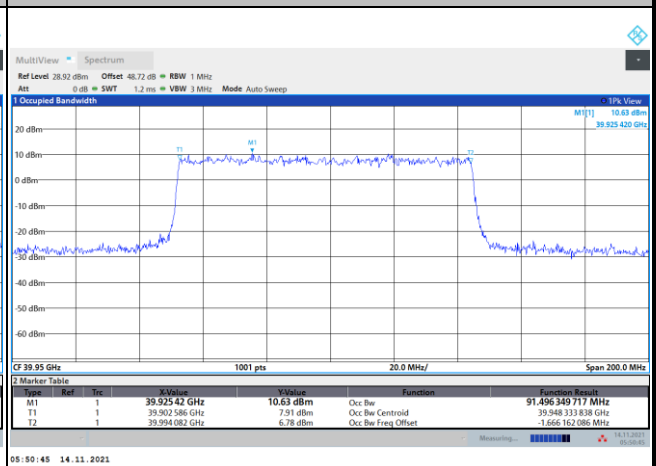



DFT-s-OFDM Module 0

NR Band n260

Lowest Channel / 400MHz / QPSK

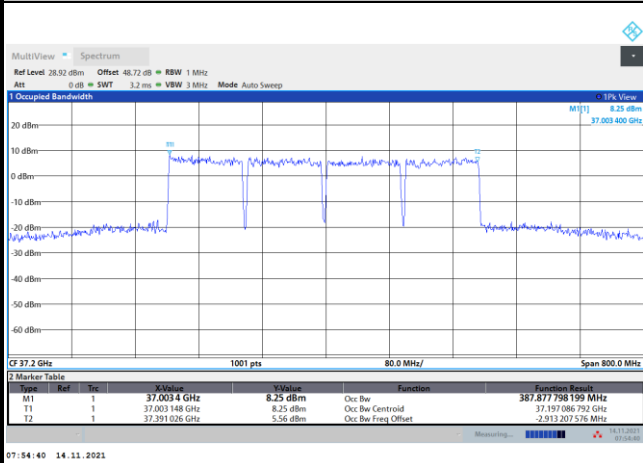

Lowest Channel / 400MHz / 16QAM



Middle Channel / 400MHz / QPSK

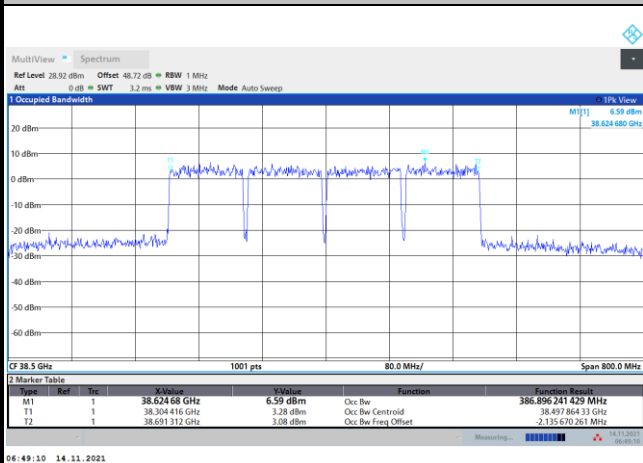

Middle Channel / 400MHz / 16QAM

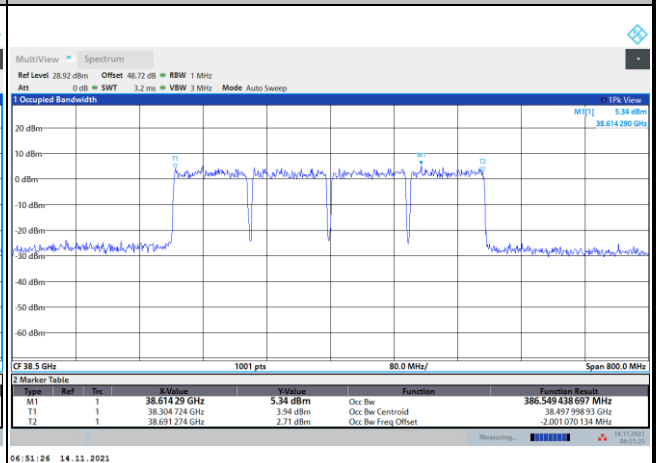

Highest Channel / 400MHz / QPSK

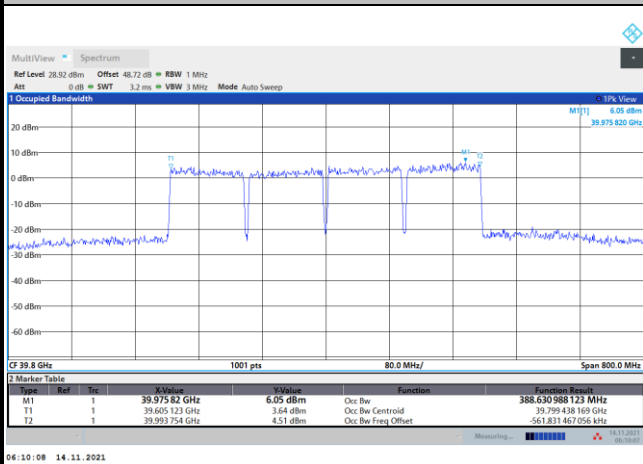

Highest Channel / 400MHz / 16QAM





DFT-s-OFDM Module 0

NR Band n260

Lowest Channel / 400MHz / 64QAM

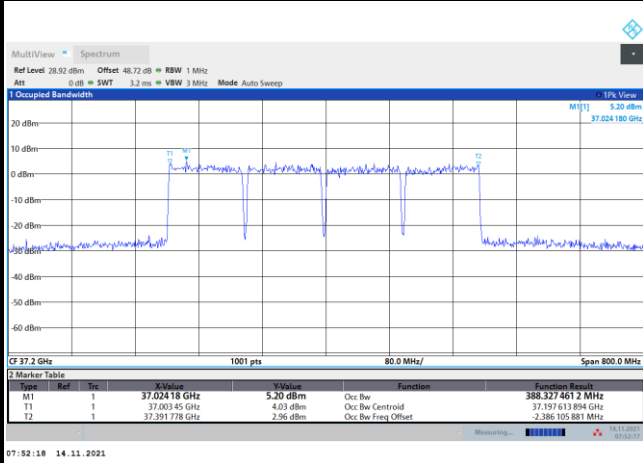

Middle Channel / 400MHz / 64QAM

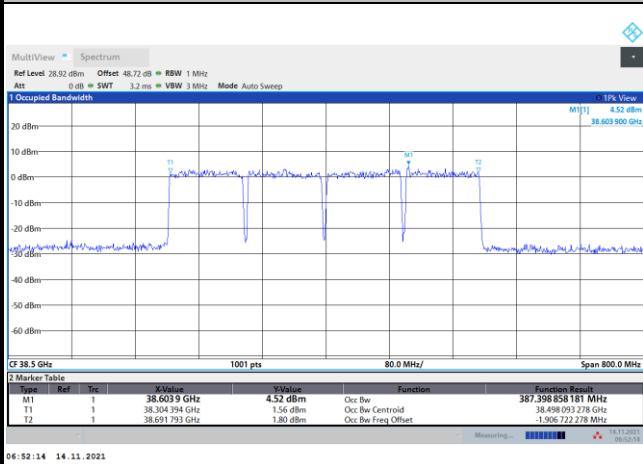

Highest Channel / 400MHz / 64QAM

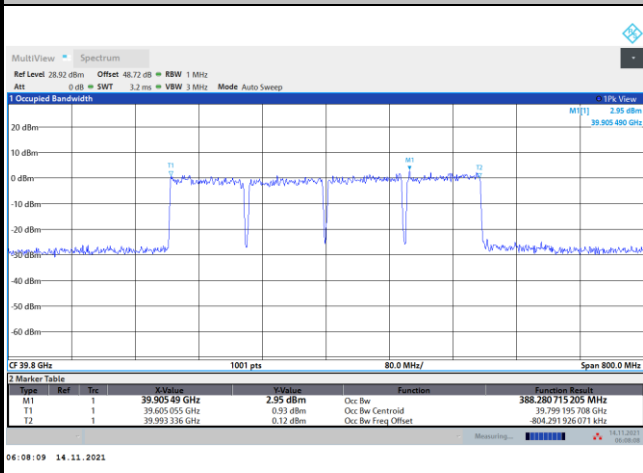





CP-OFDM Module 0

NR Band n260

Lowest Channel / 50MHz / QPSK

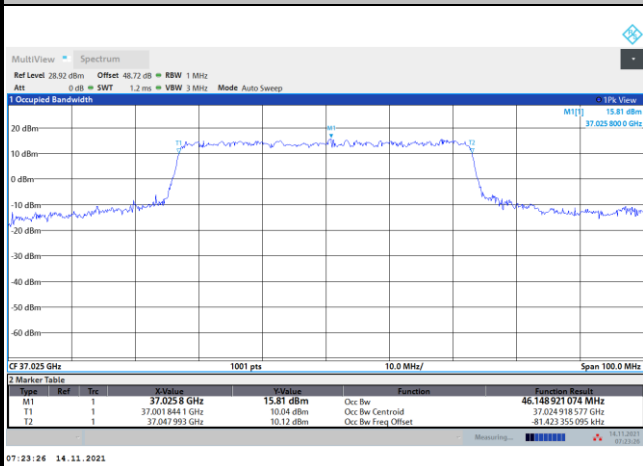

Lowest Channel / 100MHz / QPSK

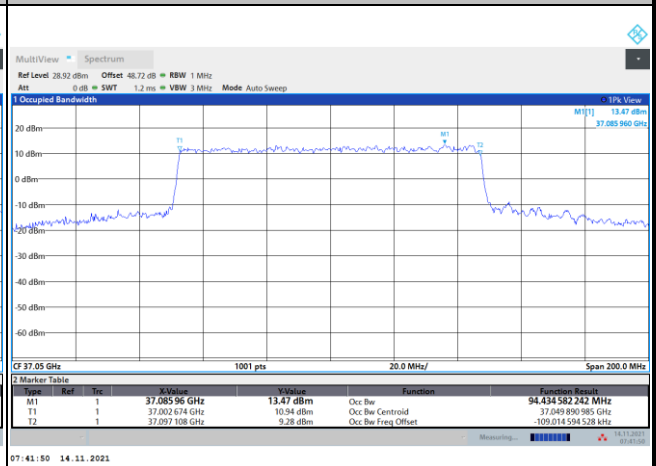

Middle Channel / 50MHz / QPSK

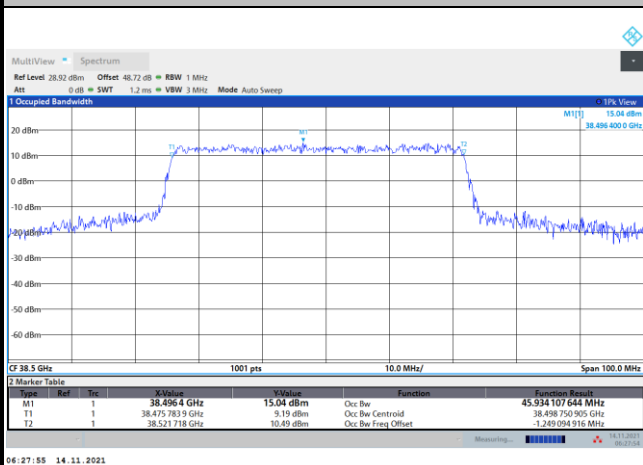

Middle Channel / 100MHz / QPSK



Highest Channel / 50MHz / QPSK

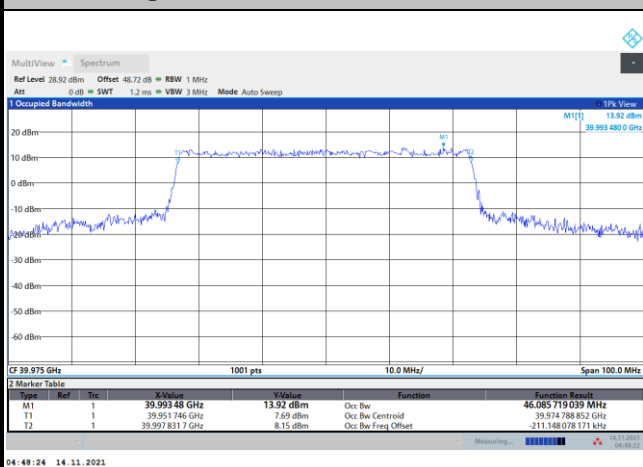

Highest Channel / 100MHz / QPSK

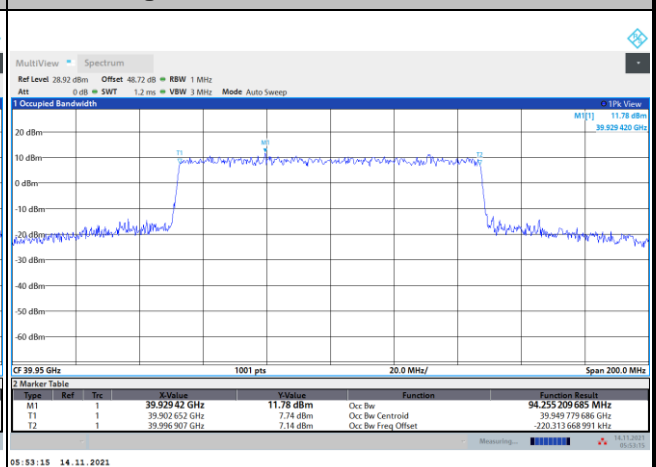



CP-OFDM Module 0

NR Band n260

Lowest Channel / 400MHz / QPSK



Middle Channel / 400MHz / QPSK



Highest Channel / 400MHz / QPSK

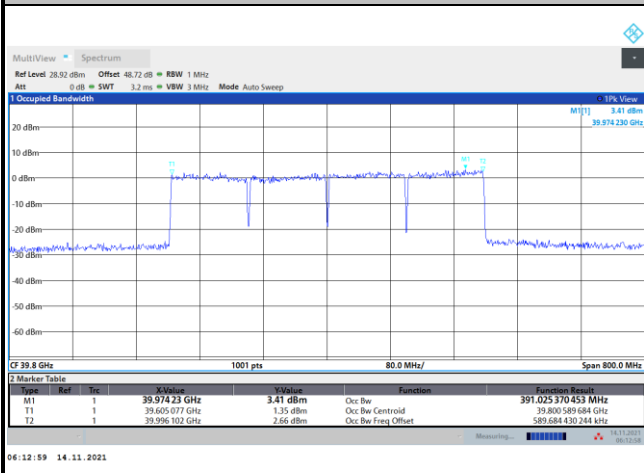



**Radiated Out of Band Emissions**

Mode			DFT-s-OFDM Module 0 NR Band n260 : BE (dBm) 1 RB					
BW			50MHz			100MHz		
Limit (dBm)			QPSK	16QAM	64QAM	QPSK	16QAM	64QAM
Low CH	0~10%OB	≤-5	-6.94	-9.90	-12.29	-8.09	-10.28	-13.50
	>10%OB	≤-13	-21.23	-22.54	-24.21	-26.92	-28.82	-29.71
High CH	0~10%OB	≤-5	-11.84	-14.13	-15.32	-13.07	-14.08	-16.32
	>10%OB	≤-13	-22.16	-24.03	-25.90	-26.99	-28.41	-29.61
Result			Compliance					

Mode			DFT-s-OFDM Module 0 NR Band n260 : BE (dBm) 1 RB					
BW			400MHz					
Limit (dBm)			QPSK	16QAM	64QAM			
Low CH	0~10%OB	≤-5	-20.05	-20.11	-22.32			
	>10%OB	≤-13	-16.48	-16.96	-19.09			
High CH	0~10%OB	≤-5	-22.66	-23.75	-25.49			
	>10%OB	≤-13	-19.65	-22.53	-25.63			
Result			Compliance					

Mode			CP-OFDM Module 0 NR Band n260 : BE (dBm) 1 RB					
BW			50MHz			100MHz		
Limit (dBm)			QPSK			QPSK		
Low CH	0~10%OB	≤-5	-9.80			-12.34		
	>10%OB	≤-13	-22.44			-28.12		
High CH	0~10%OB	≤-5	-13.28			-15.00		
	>10%OB	≤-13	-23.59			-28.46		
Result			Compliance					

Mode			CP-OFDM Module 0 NR Band n260 : BE (dBm) 1 RB					
BW			400MHz					
Limit (dBm)			QPSK					
Low CH	0~10%OB	≤-5	-21.34					
	>10%OB	≤-13	-15.25					
High CH	0~10%OB	≤-5	-22.83					
	>10%OB	≤-13	-21.61					
Result			Compliance					



Mode			DFT-s-OFDM Module 0 NR Band n260 : BE (dBm) Full RB					
BW			50MHz			100MHz		
Limit (dBm)			QPSK	16QAM	64QAM	QPSK	16QAM	64QAM
Low CH	0~10%OB	≤-5	-17.23	-19.70	-23.14	-19.55	-23.00	-26.53
	>10%OB	≤-13	-19.81	-23.29	-27.50	-23.05	-25.89	-30.46
High CH	0~10%OB	≤-5	-20.39	-23.90	-26.45	-24.22	-27.21	-31.51
	>10%OB	≤-13	-23.33	-27.68	-31.52	-26.31	-29.77	-32.44
Result			Compliance					
Mode			DFT-s-OFDM Module 0 NR Band n260 : BE (dBm) Full RB					
BW			400MHz					
Limit (dBm)			QPSK	16QAM	64QAM			
Low CH	0~10%OB	≤-5	-28.17	-31.76	-33.58			
	>10%OB	≤-13	-28.36	-32.00	-33.97			
High CH	0~10%OB	≤-5	-29.56	-32.48	-34.03			
	>10%OB	≤-13	-30.84	-34.08	-35.20			
Result			Compliance					

Mode			CP-OFDM Module 0 NR Band n260 : BE (dBm) Full RB					
BW			50MHz			100MHz		
Limit (dBm)			QPSK			QPSK		
Low CH	0~10%OB	≤-5	-17.65			-20.83		
	>10%OB	≤-13	-20.14			-23.23		
High CH	0~10%OB	≤-5	-20.64			-23.71		
	>10%OB	≤-13	-23.37			-26.11		
Result			Compliance					
Mode			CP-OFDM Module 0 NR Band n260 : BE (dBm) Full RB					
BW			400MHz					
Limit (dBm)			QPSK					
Low CH	0~10%OB	≤-5	-31.23					
	>10%OB	≤-13	-32.39					
High CH	0~10%OB	≤-5	-32.30					
	>10%OB	≤-13	-34.09					
Result			Compliance					



DFT-s-OFDM Module 0

NR Band n260 / 50MHz / QPSK

Lowest Band Edge / 1 RB

Highest Band Edge / 1 RB

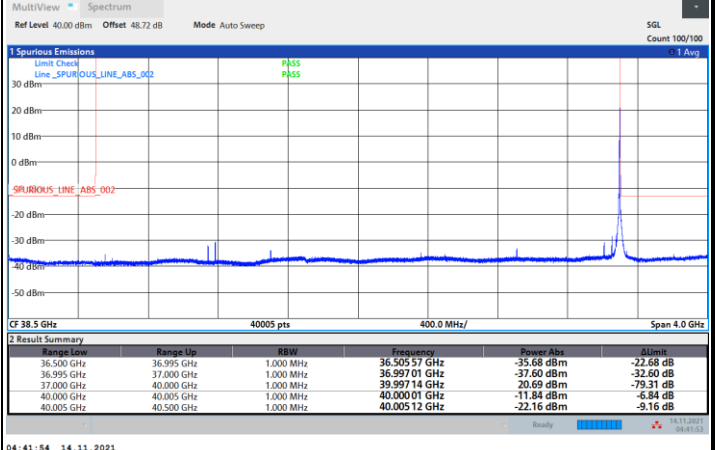
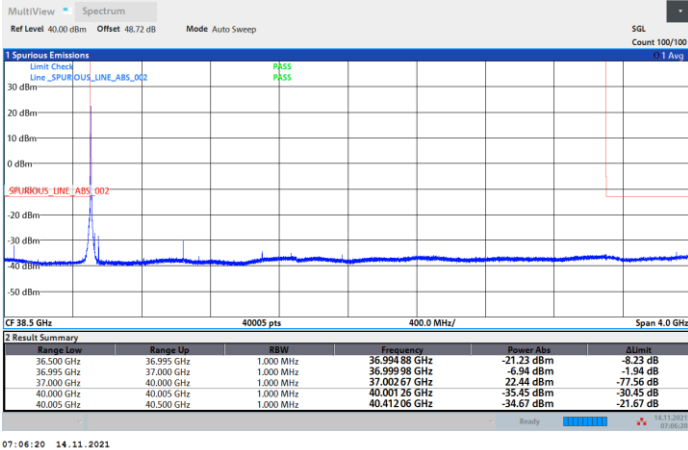

NR Band n260 / 50MHz / 16QAM

Lowest Band Edge / 1 RB

Highest Band Edge / 1 RB

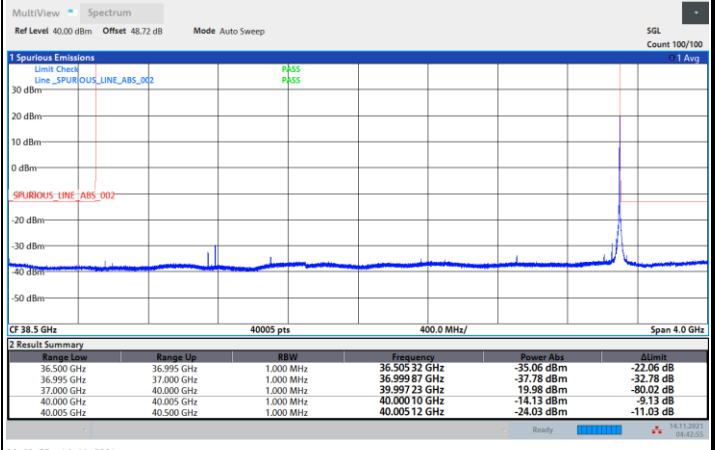
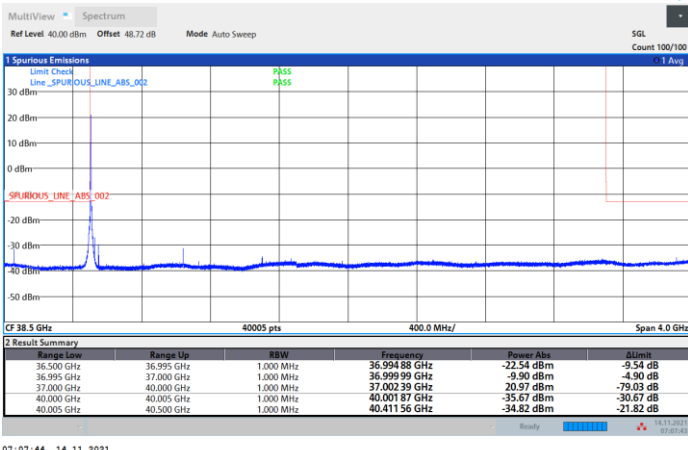



DFT-s-OFDM Module 0

NR Band n260 / 50MHz / 64QAM

Lowest Band Edge / 1 RB

Highest Band Edge / 1 RB

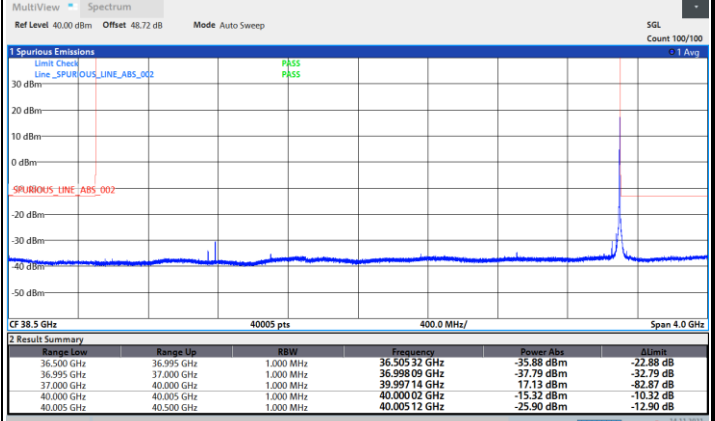
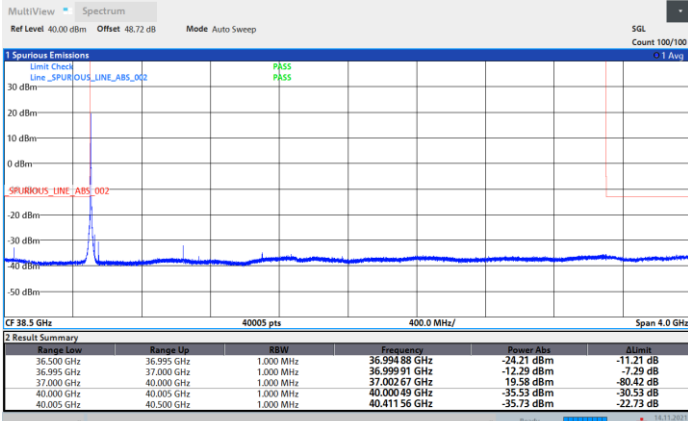

NR Band n260 / 100MHz / QPSK

Lowest Band Edge / 1 RB

Highest Band Edge / 1 RB

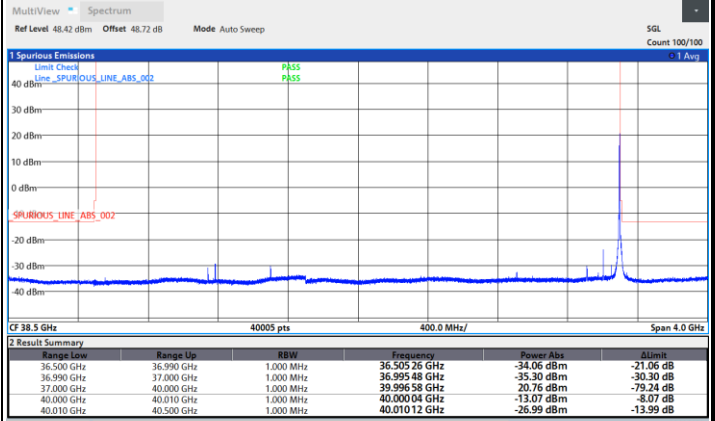
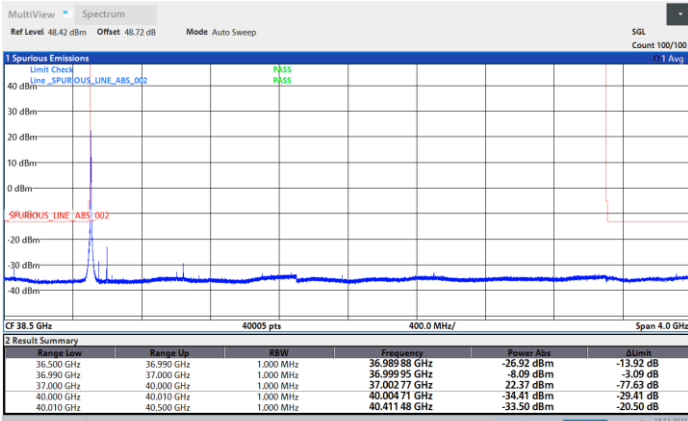



DFT-s-OFDM Module 0

NR Band n260 / 100MHz / 16QAM

Lowest Band Edge / 1 RB

Highest Band Edge / 1 RB

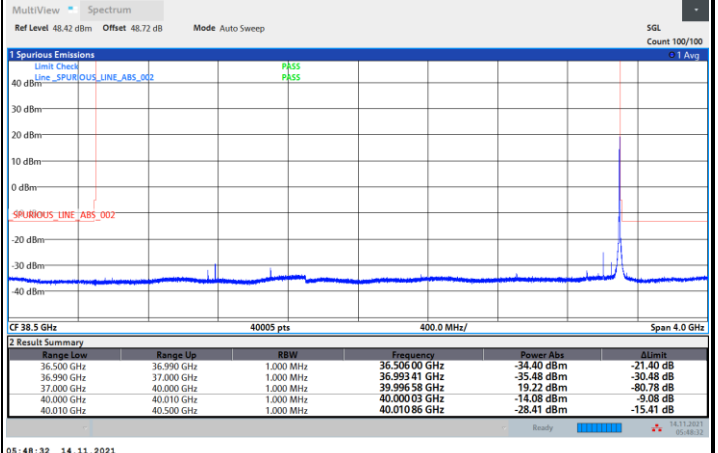
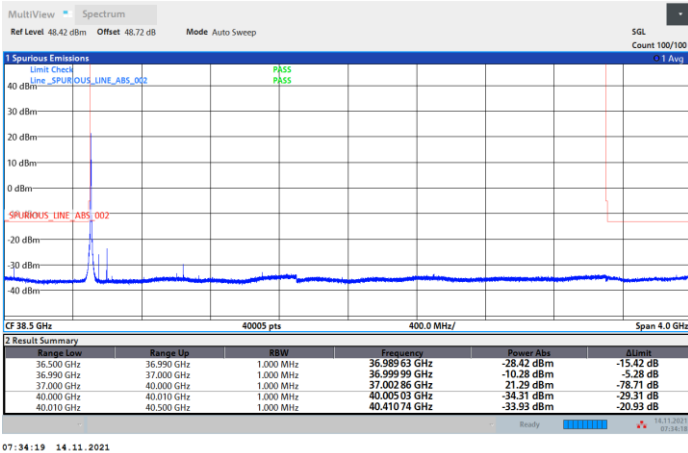

NR Band n260 / 100MHz / 64QAM

Lowest Band Edge / 1 RB

Highest Band Edge / 1 RB

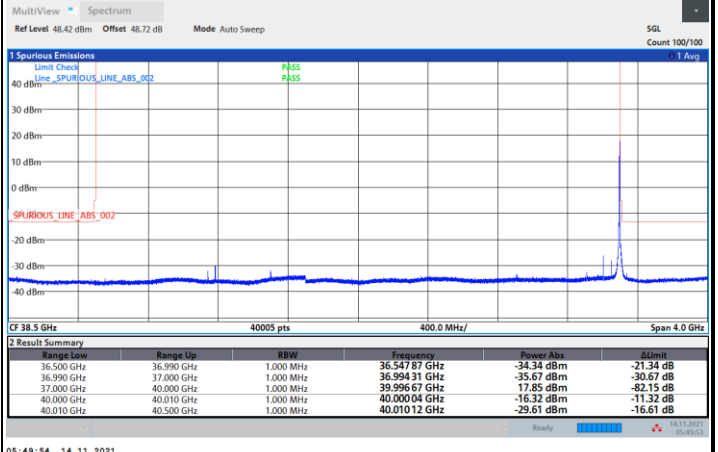
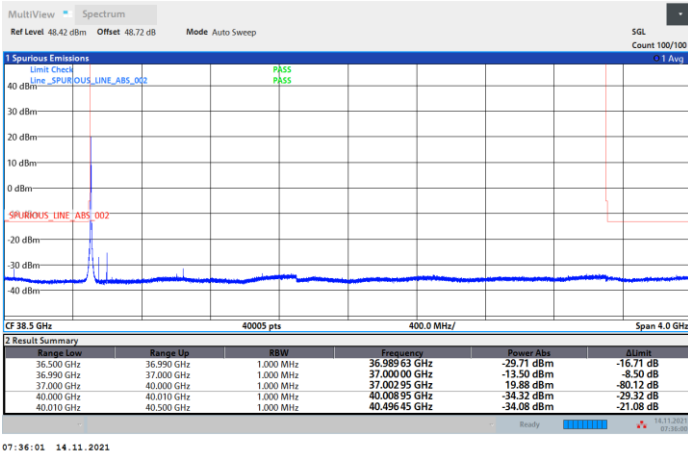



DFT-s-OFDM Module 0

NR Band n260 / 400MHz / QPSK

Lowest Band Edge / 1 RB

Highest Band Edge / 1 RB

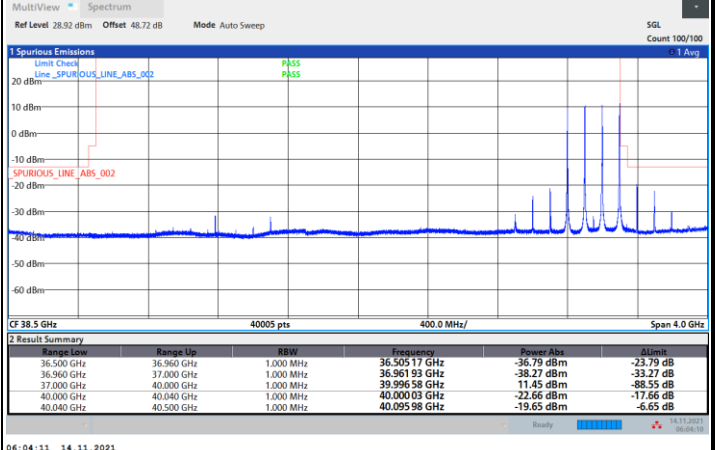
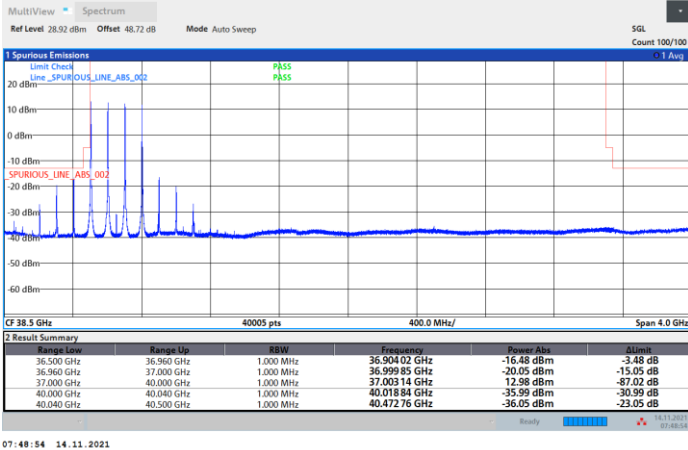

NR Band n260 / 400MHz / 16QAM

Lowest Band Edge / 1 RB

Highest Band Edge / 1 RB

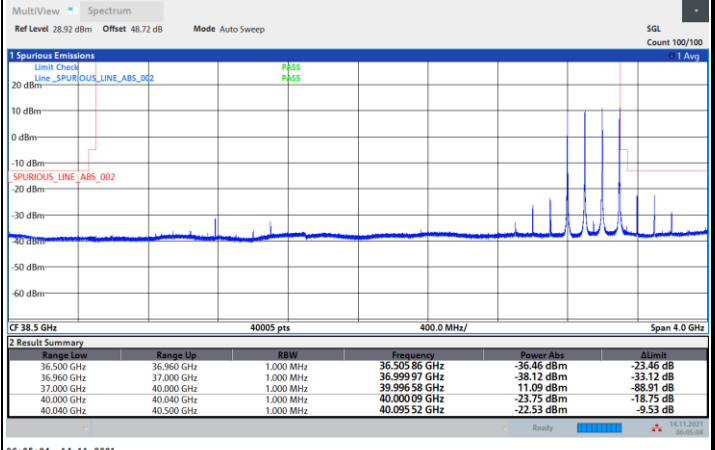
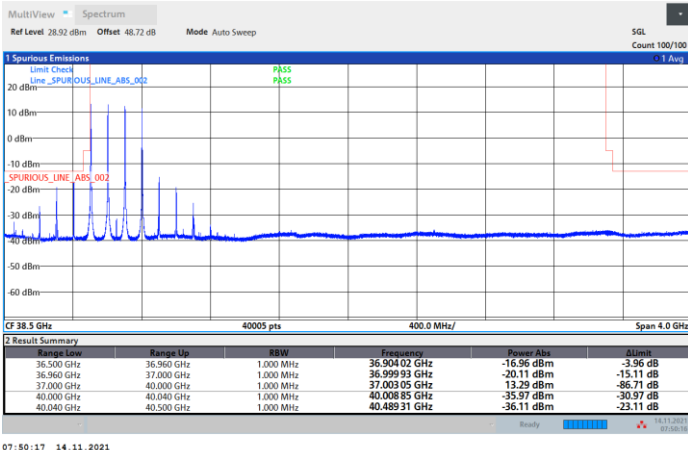





DFT-s-OFDM Module 0

NR Band n260 / 400MHz / 64QAM

Lowest Band Edge / 1 RB

Highest Band Edge / 1 RB

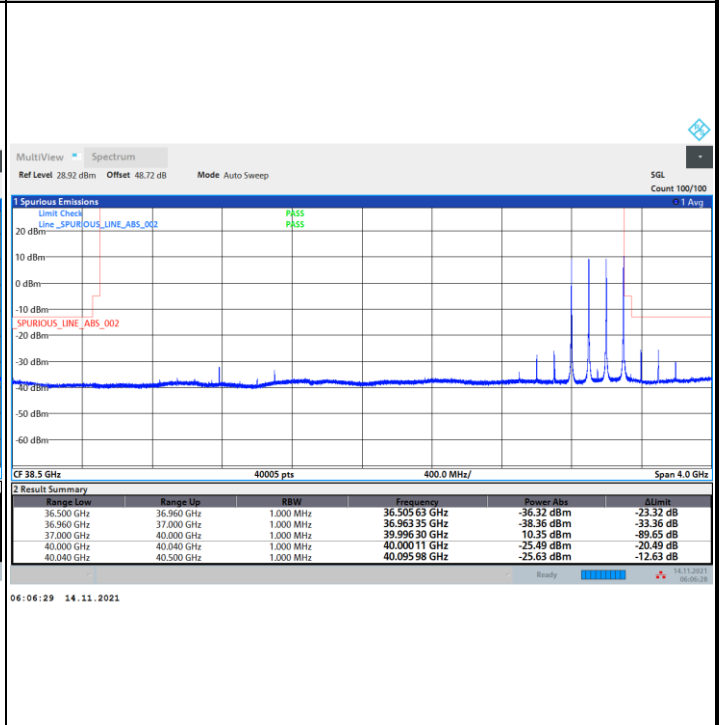
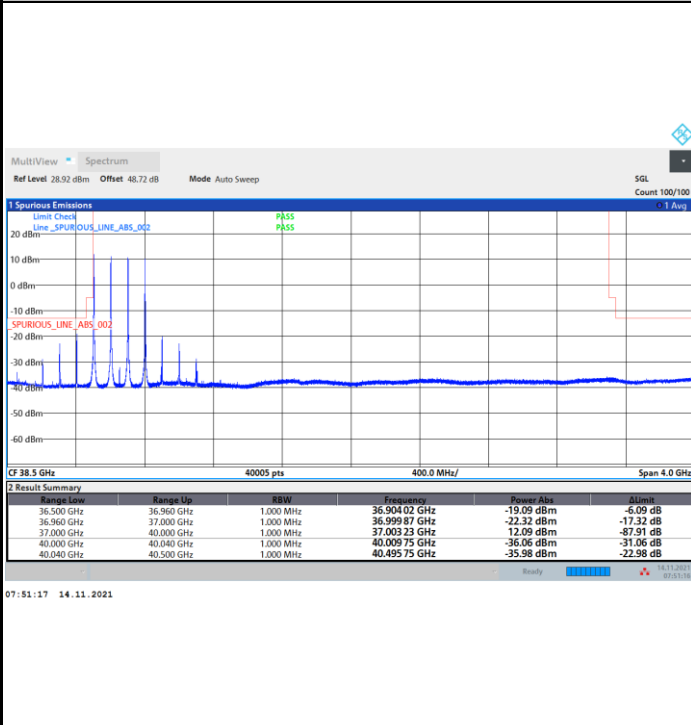



CP-OFDM Module 0

NR Band n260 / 50MHz / QPSK

Lowest Band Edge / 1 RB

Highest Band Edge / 1 RB

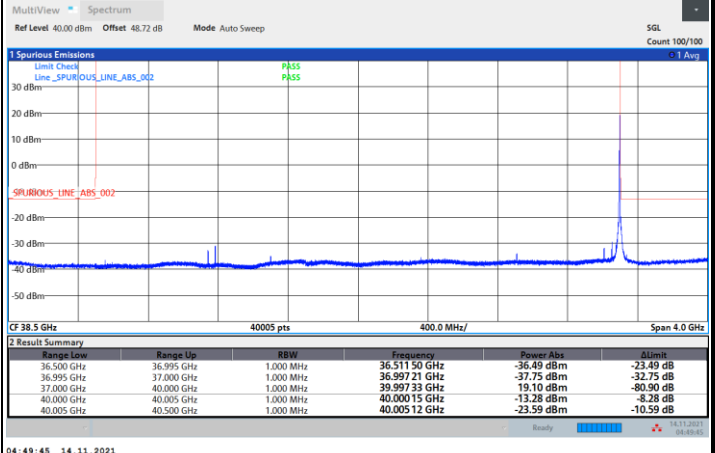
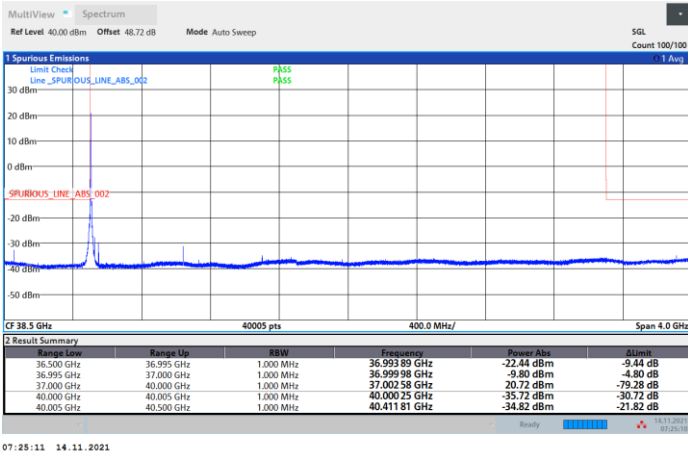

NR Band n260 / 100MHz / QPSK

Lowest Band Edge / 1 RB

Highest Band Edge / 1 RB

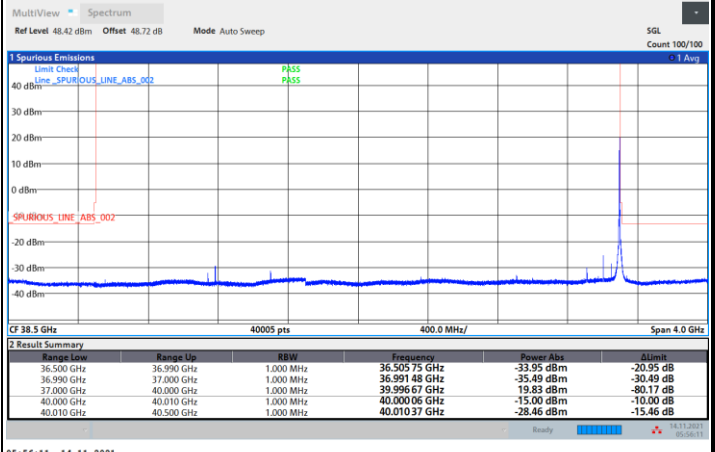
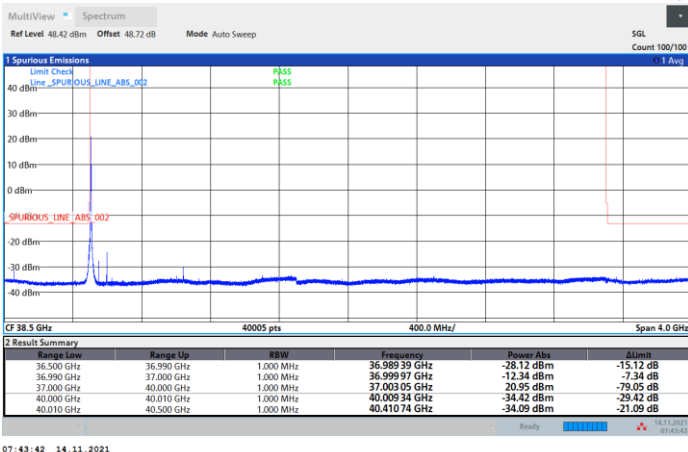



CP-OFDM Module 0

NR Band n260 / 400MHz / QPSK

Lowest Band Edge / 1 RB

Highest Band Edge / 1 RB

