



FCC RADIO TEST REPORT

FCC ID : IHDT56AA6
Equipment : Wearable Cellular Device
Brand Name : Motorola
Model Name : XT2209-1
Applicant : Motorola Mobility, LLC
222 W Merchandise Mart Plaza, Suite
1800, Chicago, IL 60654, United States
Manufacturer : Motorola Mobility, LLC
222 W Merchandise Mart Plaza, Suite
1800, Chicago, IL 60654, United States
Standard : FCC PART 15 Subpart C §15.247

The product was received on Oct. 19, 2021 and testing was performed from Oct. 21, 2021 to Nov. 30, 2021. We, Sporton International Inc. Wensan Laboratory, would like to declare that the tested sample has been evaluated in accordance with the test procedures and has been in compliance with the applicable technical standards.

The test results in this report apply exclusively to the tested model / sample. Without written approval from Sporton International Inc. Wensan Laboratory, the test report shall not be reproduced except in full.

Approved by: Louis Wu

Sporton International Inc. Wensan Laboratory

No.58, Aly. 75, Ln. 564, Wenhua 3rd, Rd., Guishan Dist., Taoyuan City 333010, Taiwan



Table of Contents

History of this test report..... 3

Summary of Test Result..... 4

1 General Description 5

 1.1 Product Feature of Equipment Under Test..... 5

 1.2 Product Specification of Equipment Under Test..... 6

 1.3 Modification of EUT 8

 1.4 Testing Location 8

 1.5 Applicable Standards..... 8

2 Test Configuration of Equipment Under Test 9

 2.1 Carrier Frequency and Channel 9

 2.2 Test Mode..... 10

 2.3 Connection Diagram of Test System..... 12

 2.4 Support Unit used in test configuration and system 13

 2.5 EUT Operation Test Setup 13

 2.6 Measurement Results Explanation Example..... 13

3 Test Result 14

 3.1 6dB and 99% Bandwidth Measurement 14

 3.2 Output Power Measurement..... 18

 3.3 Power Spectral Density Measurement 19

 3.4 Conducted Band Edges and Spurious Emission Measurement 22

 3.5 Radiated Band Edges and Spurious Emission Measurement 59

 3.6 AC Conducted Emission Measurement..... 65

 3.7 Antenna Requirements 67

4 List of Measuring Equipment..... 69

5 Uncertainty of Evaluation 71

Appendix A. Conducted Test Results

Appendix B. AC Conducted Emission Test Result

Appendix C. Radiated Spurious Emission

Appendix D. Radiated Spurious Emission Plots

Appendix E. Duty Cycle Plots



History of this test report

Report No.	Version	Description	Issue Date
FR1O2008C	01	Initial issue of report	Dec. 06, 2021
FR1O2008C	02	Revise Conducted test results, Power Spectral Density and description in section 2.2	Dec. 09, 2021



Summary of Test Result

Report Clause	Ref Std. Clause	Test Items	Result (PASS/FAIL)	Remark
3.1	15.247(a)(2)	6dB Bandwidth	Pass	-
3.1	2.1049	99% Occupied Bandwidth	Reporting only	-
3.2	15.247(b)	Power Output Measurement	Pass	-
3.3	15.247(e)	Power Spectral Density	Pass	-
3.4	15.247(d)	Conducted Band Edges	Pass	-
		Conducted Spurious Emission	Pass	-
3.5	15.247(d)	Radiated Band Edges and Radiated Spurious Emission	Pass	3.64 dB under the limit at 2483.530 MHz
3.6	15.207	AC Conducted Emission	Pass	18.65 dB under the limit at 0.940 MHz
3.7	15.203 & 15.247(b)	Antenna Requirement	Pass	-

Declaration of Conformity:

The test results with all measurement uncertainty excluded are presented in accordance with the regulation limits or requirements declared by manufacturers.

Comments and Explanations:

The product specifications of the EUT presented in the report are declared by the manufacturer who shall take full responsibility for the authenticity.

Reviewed by: Keven Cheng**Report Producer: Clio Lo**



1 General Description

1.1 Product Feature of Equipment Under Test

Product Feature	
Equipment	Wearable Cellular Device
Brand Name	Motorola
Model Name	XT2209-1
FCC ID	IHDT56AA6
IMEI Code	Conducted : 356636550004361 Conduction : 356636550004478 Radiation : 356636550004429
EUT supports Radios application	LTE/5G NR/GNSS WLAN 11a/b/g/n HT20/HT40 WLAN 11ac VHT20/VHT40/VHT80/VHT160 WLAN 11ax HE20/HE40/HE80/HE160 Bluetooth BR/EDR/LE
HW Version	EVT1
EUT Stage	Identical Prototype

Remark: The above EUT's information was declared by manufacturer.

Accessory List		
Battery	Brand Name :	Motorola
	Model Name :	NR70

1.2 Product Specification of Equipment Under Test

Product Specification is subject to this standard	
Tx/Rx Frequency Range	2412 MHz ~ 2462 MHz
Maximum Output Power to Antenna <CDD Modes>	MIMO <Ant. 4 + 5> 802.11b: 22.12 dBm / 0.1629 W 802.11g: 21.86 dBm / 0.1535 W 802.11n HT20: 21.71 dBm / 0.1483 W 802.11n HT40: 21.01 dBm / 0.1262 W 802.11ac VHT20: 21.61 dBm / 0.1449 W 802.11ac VHT40: 20.91 dBm / 0.1233 W 802.11ax HE20: 21.81 dBm / 0.1517 W 802.11ax HE40: 21.11 dBm / 0.1291 W
Maximum Output Power to Antenna <TXBF Modes>	MIMO <Ant. 4 + 5> 802.11ac VHT20: 19.66 dBm / 0.0925 W 802.11ac VHT40: 19.47 dBm / 0.0885 W 802.11ax HE20: 19.76 dBm / 0.0946 W 802.11ax HE40: 19.57 dBm / 0.0906 W
99% Occupied Bandwidth <CDD Modes>	MIMO <Ant. 4> 802.11b: 13.64 MHz 802.11g: 17.33 MHz 802.11ax HE20: 19.48 MHz 802.11ax HE40: 38.06 MHz MIMO <Ant. 5> 802.11b: 13.69 MHz 802.11g: 17.38 MHz 802.11ax HE20: 19.48 MHz 802.11ax HE40: 38.06 MHz
99% Occupied Bandwidth <TXBF Modes>	MIMO <Ant. 4> 802.11ax HE20: 19.83 MHz 802.11ax HE40: 38.56 MHz MIMO <Ant. 5> 802.11ax HE20: 19.88 MHz 802.11ax HE40: 38.46 MHz



Product Specification is subject to this standard			
Type of Modulation	802.11b: DSSS (DBPSK / DQPSK / CCK) 802.11g/n: OFDM (BPSK / QPSK / 16QAM / 64QAM) 802.11ac: OFDM (BPSK / QPSK / 16QAM / 64QAM / 256QAM) 802.11ax : OFDMA (BPSK / QPSK / 16QAM / 64QAM / 256QAM / 1024QAM)		
Antenna Type / Gain	<Ant. 4> : Printed ILA Antenna Type with gain -4.0 dBi <Ant. 5> : Printed ILA Antenna Type with gain -5.6 dBi		
Antenna Function Description		Ant. 4	Ant. 5
	802.11 b/g/n/ac/ax MIMO	V	V
	802.11 ac/ax TXBF	V	V

Note:

1. MIMO Ant. 4+5 is a calculated result from sum of the power MIMO Ant. 4 and MIMO Ant. 5
2. The above EUT's information was declared by manufacturer. Please refer to Comments and Explanations in report summary.



1.3 Modification of EUT

No modifications made to the EUT during the testing.

1.4 Testing Location

Test Site	Sporton International Inc. EMC & Wireless Communications Laboratory
Test Site Location	No.52, Huaya 1st Rd., Guishan Dist., Taoyuan City 333, Taiwan TEL: +886-3-327-3456 FAX: +886-3-328-4978
Test Site No.	Sporton Site No. CO05-HY (TAF Code: 1190)
Remark	The Conducted Emission test item subcontracted to Sporton International Inc. EMC & Wireless Communications Laboratory.

Test Site	Sporton International Inc. Wensan Laboratory
Test Site Location	No.58, Aly. 75, Ln. 564, Wenhua 3rd, Rd., Guishan Dist., Taoyuan City 333010, Taiwan TEL: +886-3-327-0868 FAX: +886-3-327-0855
Test Site No.	Sporton Site No. TH05-HY, 03CH15-HY

Note: The test site complies with ANSI C63.4 2014 requirement.

FCC designation No.: TW1190 and TW3786

1.5 Applicable Standards

According to the specifications declared by the manufacturer, the EUT must comply with the requirements of the following standards:

- ♦ FCC Part 15 Subpart C §15.247
- ♦ FCC KDB Publication No. 558074 D01 DTS Meas. Guidance v05r02
- ♦ FCC KDB 414788 D01 Radiated Test Site v01r01.
- ♦ FCC KDB 662911 D01 Multiple Transmitter Output v02r01.
- ♦ ANSI C63.10-2013

Remark:

1. All the test items were validated and recorded in accordance with the standards without any modification during the testing.
2. The TAF code is not including all the FCC KDB listed without accreditation.
3. This EUT has also been tested and complied with the requirements of FCC Part 15, Subpart B, recorded in a separate test report.



2 Test Configuration of Equipment Under Test

- a. The EUT has been associated with peripherals and configuration operated in a manner tended to maximize its emission characteristics in a typical application. Frequency range investigated: conduction emission (150 kHz to 30 MHz), radiation emission (9 kHz to the 10th harmonic of the highest fundamental frequency or to 40 GHz, whichever is lower). For radiated measurement, the measured emission level of the EUT was maximized by rotating the EUT on a turntable, adjusting the orientation of the EUT and EUT antenna in three orthogonal axis (X: flat, Y: portrait, Z: landscape), and adjusting the measurement antenna orientation, following C63.10 exploratory test procedures and find X plane as worst plane.

- b. AC power line Conducted Emission was tested under maximum output power.

2.1 Carrier Frequency and Channel

Frequency Band	Channel	Freq. (MHz)	Channel	Freq. (MHz)
2400-2483.5 MHz	1	2412	7	2442
	2	2417	8	2447
	3	2422	9	2452
	4	2427	10	2457
	5	2432	11	2462
	6	2437		



2.2 Test Mode

The final test modes consider the modulation and the worst data rates as shown in the table below.

MIMO Mode

Modulation	Data Rate
802.11b	1 Mbps
802.11g	6 Mbps
802.11n HT20 (Covered by HE20)	MCS0
802.11n HT40 (Covered by HE40)	MCS0
802.11ac VHT20 (Covered by HE20)	MCS0
802.11ac VHT40 (Covered by HE40)	MCS0
802.11ax HE20	MCS0
802.11ax HE40	MCS0

TXBF Mode

Modulation	Data Rate
802.11ac VHT20 (Covered by HE20)	MCS0
802.11ac VHT40 (Covered by HE40)	MCS0
802.11ax HE20	MCS0
802.11ax HE40	MCS0

Note:

1. Since the verify power, the smaller power can be covered by the higher power. The SISO Mode are covered by MIMO Mode.
2. The TXBF mode of device only support WLAN 2.4GHz in 802.11ac and ax mode.
3. For 802.11ax, since the verify power& PSD, the smaller power can be covered by the higher power. The Partial RU are covered by Full RU.



Test Cases	
AC Conducted Emission	Mode 1 :LTE Band 2 Link + Bluetooth Link + WLAN (2.4GHz) Link + Bottom USB Port (Charging from AC Adapter)

<CDD Mode>

Ch. #	2400-2483.5 MHz			
	802.11b	802.11g	802.11ax HE20	802.11ax HE40
Low	01	01	01	03
Middle	06	06	06	06
High	11	11	11	09

<TXBF Mode>

Ch. #	2400-2483.5 MHz	
	802.11ax HE20	802.11ax HE40
Low	01	03
Middle	06	06
High	11	09

Remark: For radiation spurious emission, the modulation and the data rate picked for testing are determined by the Max. RF conducted power.

2.3 Connection Diagram of Test System

<AC Conducted Emission Mode>

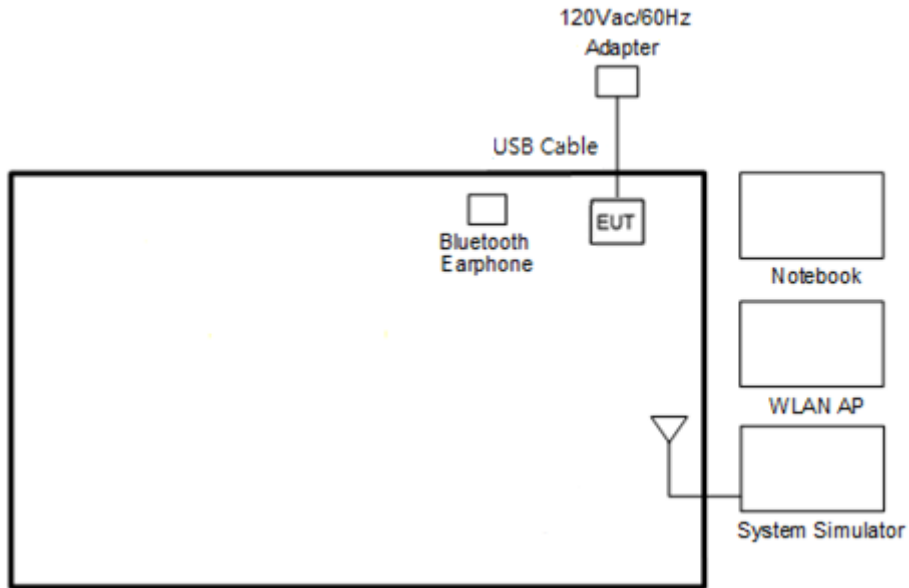

<WLAN Tx Mode>

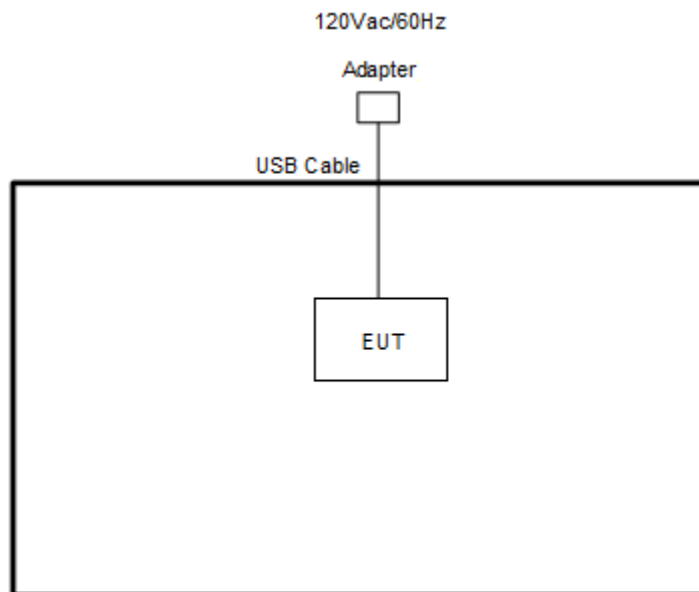



2.4 Support Unit used in test configuration and system

Item	Equipment	Brand Name	Model Name	FCC ID	Data Cable	Power Cord
1.	System Simulator	Anritsu	MT8820C	N/A	N/A	Unshielded, 1.8 m
2.	Bluetooth Earphone	Sony Ericsson	MW600	PY7DDA-2029	N/A	N/A
3.	WLAN AP	ASUS	RT-AC66U	MSQ-RTAC66U	N/A	Unshielded, 1.8 m
4.	Notebook	DELL	Latitude 3400	FCC DoC	N/A	AC I/P: Unshielded, 1.2 m DC O/P: Shielded, 1.8 m
5.	USB Cable	Samsung	N/A	N/A	Shielded,1.3m	N/A
6.	USB Cable	N/A	N/A	N/A	Unshielded, 0.8m	N/A
7.	AC Adapter	DVE	DSA-5PFM-05 FUS	FCC DoC	N/A	N/A
8.	AC Adapter	Samsung	GT-N7000	NA	N/A	N/A

2.5 EUT Operation Test Setup

The RF test items, utility “QRCT 4.0.00193.0” was installed in Notebook which was programmed in order to make the EUT get into the engineering modes to provide channel selection, power level, data rate and the application type and for continuous transmitting signals.

For TXBF mode, the modulation modes and data rates manipulated by the command lines in the engineering program made the EUT link to another EUT by power under the normal operation. The “Vysor-win-3.1.4” software tool was used to enable the EUT to transmit signals continuously.

2.6 Measurement Results Explanation Example

For all conducted test items:

The offset level is set in the spectrum analyzer to compensate the RF cable loss and attenuator factor between EUT conducted output port and spectrum analyzer. With the offset compensation, the spectrum analyzer reading level is exactly the EUT RF output level.

Example:

The spectrum analyzer offset is derived from RF cable loss and attenuator factor.

Offset = RF cable loss + attenuator factor.

Following shows an offset computation example with cable loss 4.2 dB and 10 dB attenuator.

$$\begin{aligned} \text{Offset(dB)} &= \text{RF cable loss(dB)} + \text{attenuator factor(dB)}. \\ &= 4.2 + 10 = 14.2 \text{ (dB)} \end{aligned}$$

3 Test Result

3.1 6dB and 99% Bandwidth Measurement

3.1.1 Limit of 6dB and 99% Bandwidth

The minimum 6 dB bandwidth shall be at least 500 kHz.

3.1.2 Measuring Instruments

Please refer to the measuring equipment list in this test report.

3.1.3 Test Procedures

1. The testing follows the ANSI C63.10 Section 6.9.3 (OBW) and 11.8.1 (6dB BW).
2. The RF output of EUT is connected to the spectrum analyzer by RF cable and attenuator. The path loss is compensated to the results for each measurement.
3. Set the maximum power setting and enable the EUT to transmit continuously.
4. Make the measurement with the spectrum analyzer's resolution bandwidth (RBW) = 100 kHz. Set the Video bandwidth (VBW) = 300 kHz. In order to make an accurate measurement. The 6 dB bandwidth must be greater than 500 kHz.
5. For 99% Bandwidth Measurement, the spectrum analyzer's resolution bandwidth (RBW) is set 1-5% of the emission bandwidth and set the Video bandwidth (VBW) $\geq 3 * RBW$.
6. Measure and record the results in the test report.

3.1.4 Test Setup





3.1.5 Test Result of 6dB and 99% Occupied Bandwidth

Please refer to Appendix A.

<CDD Mode>

<802.11b>

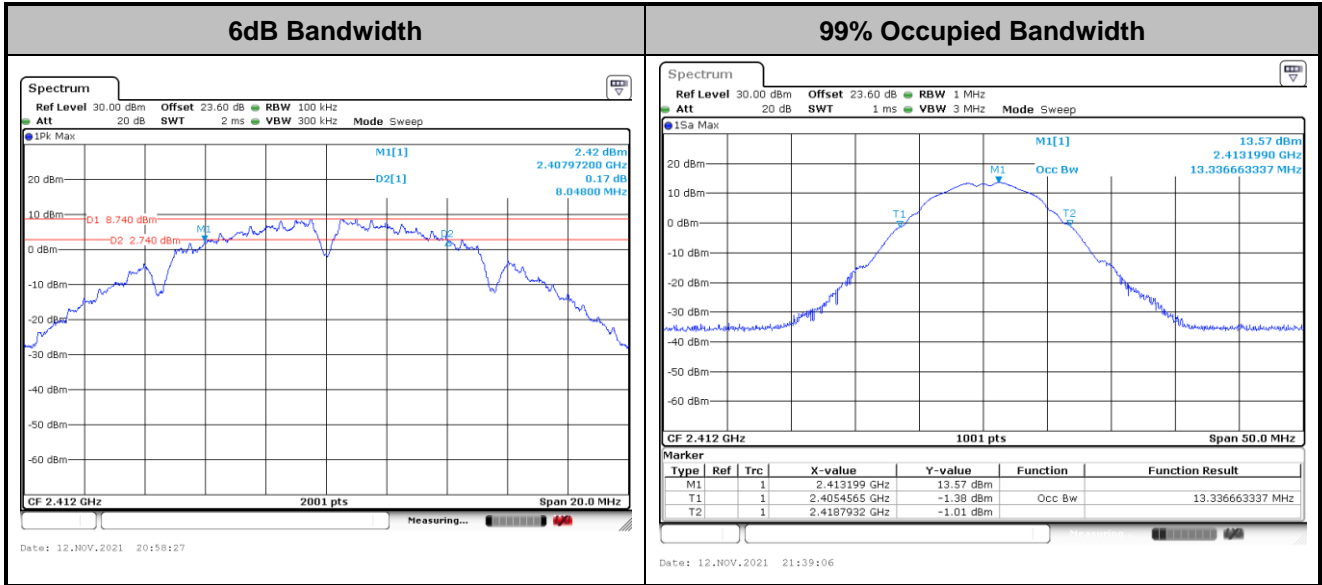

Note: The occupied channel bandwidth is maintained within the band of operation for all of the modulations.

<802.11g>

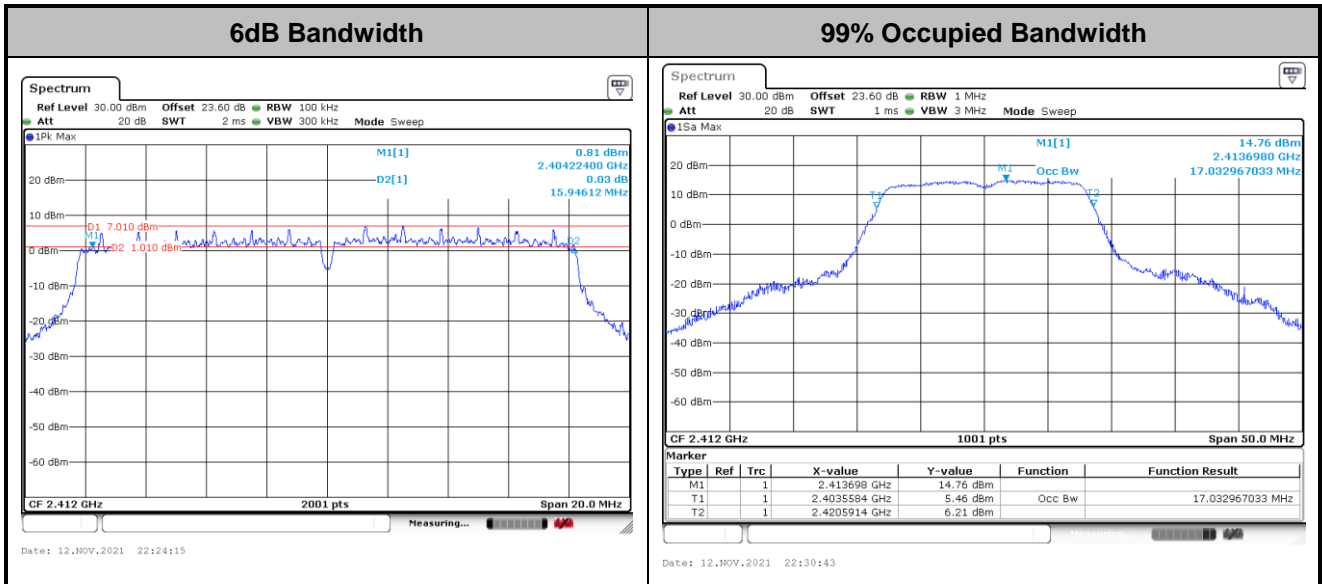

Note: The occupied channel bandwidth is maintained within the band of operation for all of the modulations.



<802.11ax HE20>

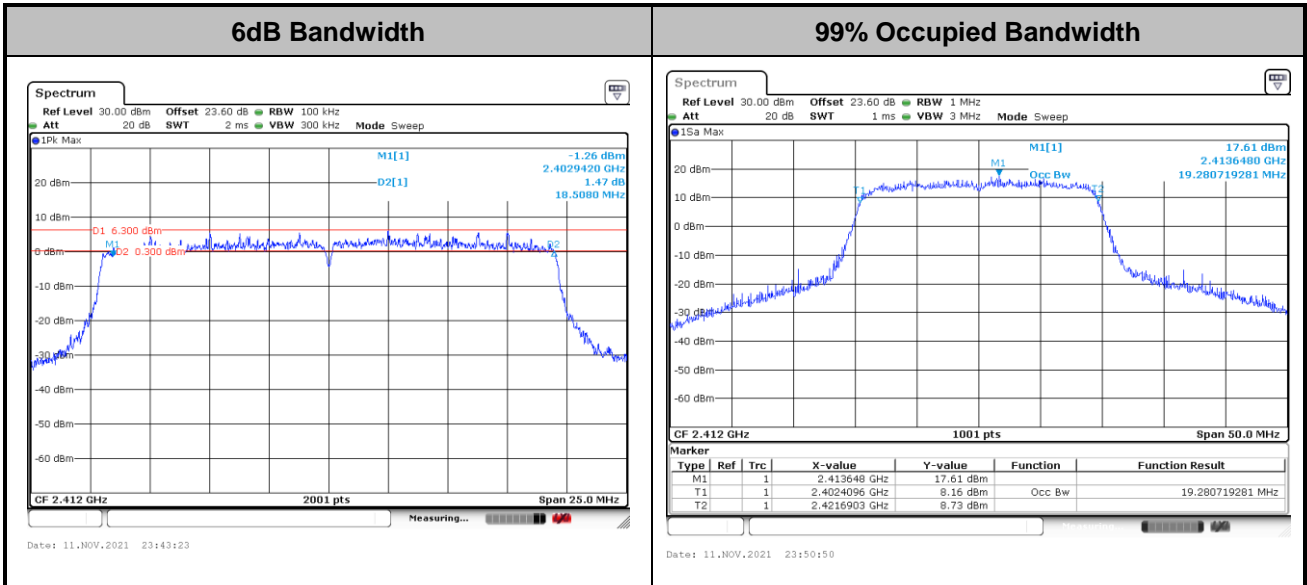

Note: The occupied channel bandwidth is maintained within the band of operation for all of the modulations.

<802.11ax HE40>

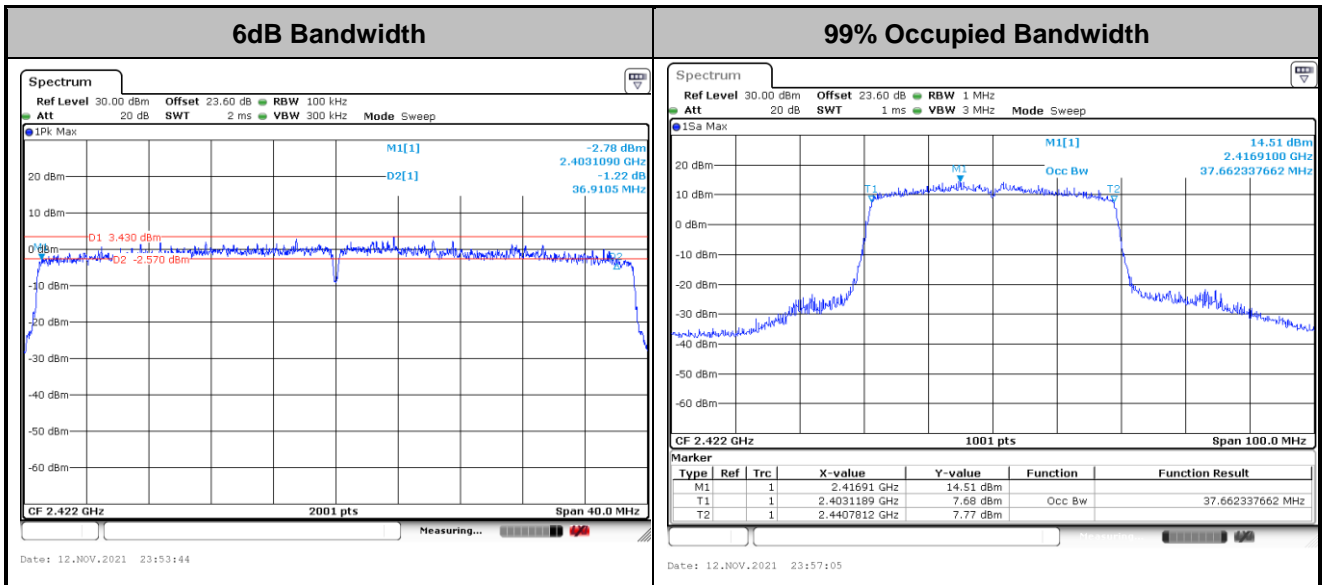

Note: The occupied channel bandwidth is maintained within the band of operation for all of the modulations.



<TXBF Modes>

<802.11ax HE20>

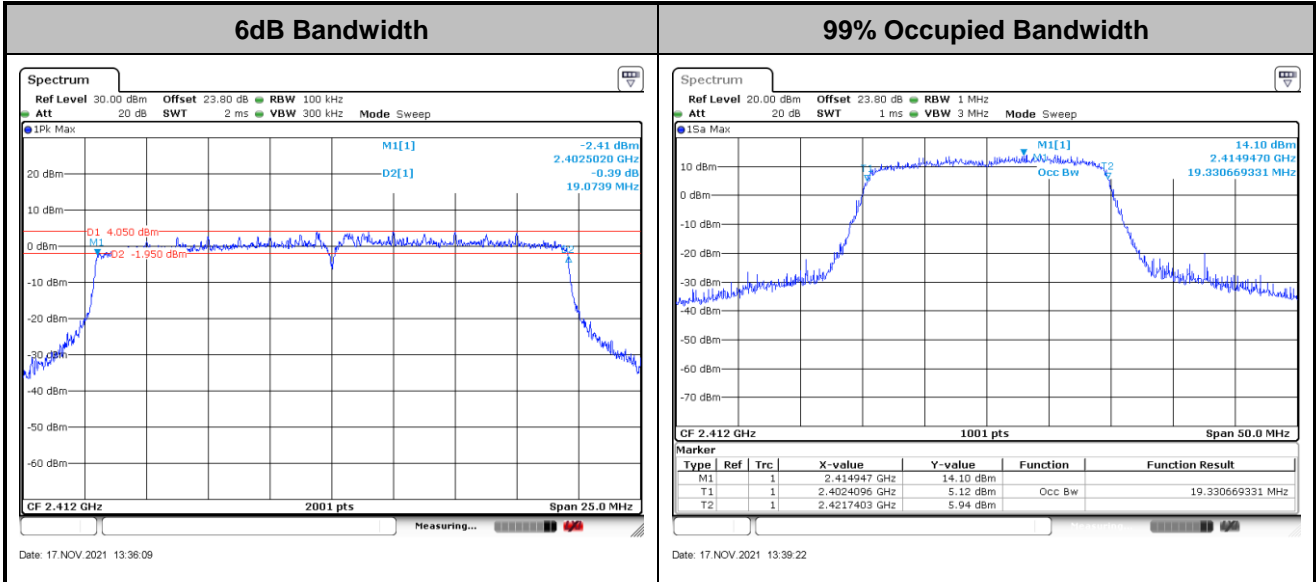

Note: The occupied channel bandwidth is maintained within the band of operation for all of the modulations.

<802.11ax HE40>

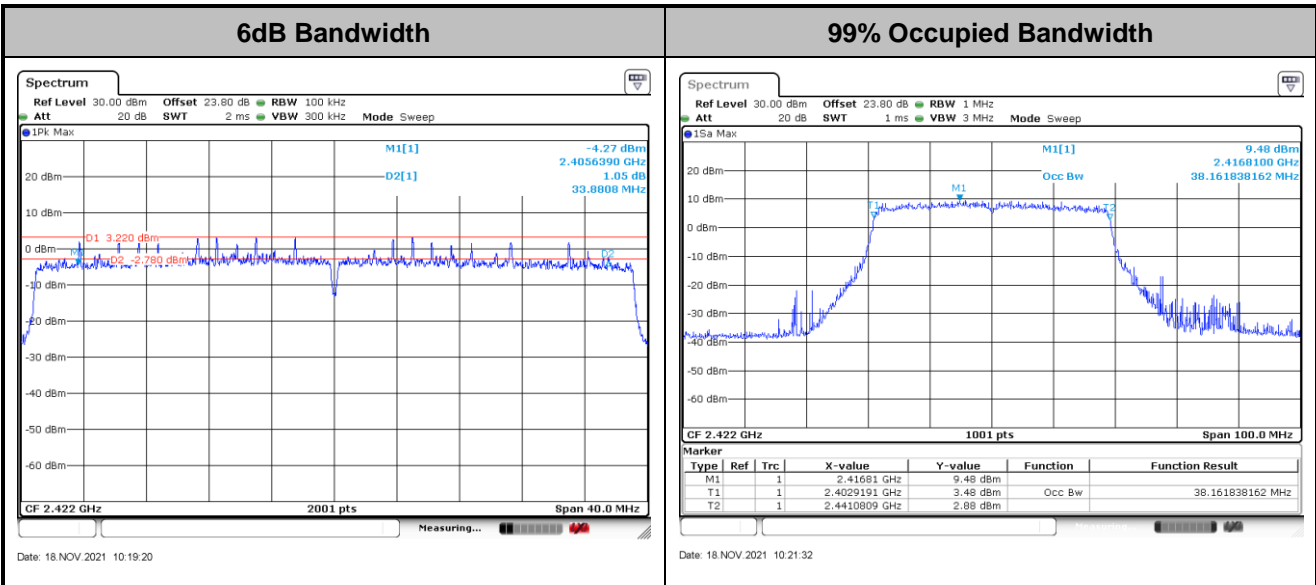

Note: The occupied channel bandwidth is maintained within the band of operation for all of the modulations.

3.2 Output Power Measurement

3.2.1 Limit of Output Power

For systems using digital modulation in the 2400-2483.5 MHz, the limit for output power is 30 dBm. If transmitting antenna with directional gain greater than 6 dBi is used, the output power from the intentional radiator shall be reduced below the above stated value by the amount in dB that the directional gain of the antenna exceeds 6 dBi. In case of point-to-point operation, the limit has to be reduced by 1 dB for every 3 dB that the directional gain of the antenna exceeds 6 dBi.

3.2.2 Measuring Instruments

Please refer to the measuring equipment list in this test report.

3.2.3 Test Procedures

1. For Average Power, the testing follows ANSI C63.10 Section 11.9.2.3.2 Method AVGPM-G
2. The RF output of EUT is connected to the power meter by RF cable and attenuator. The path loss is compensated to the results for each measurement.
3. Set the maximum power setting and enable the EUT to transmit continuously.
4. Measure the conducted output power and record the results in the test report.
5. For MIMO mode, calculation method follows FCC KDB 662911 D01 Multiple Transmitter Output v02r01.

3.2.4 Test Setup

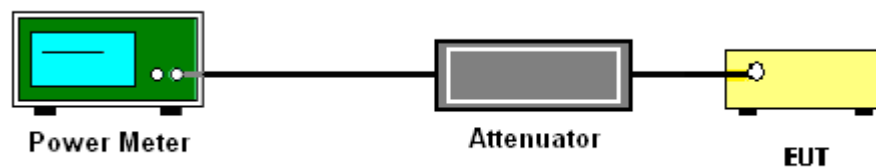

3.2.5 Test Result of Average Output Power

Please refer to Appendix A.

3.3 Power Spectral Density Measurement

3.3.1 Limit of Power Spectral Density

The peak power spectral density shall not be greater than 8 dBm in any 3 kHz band at any time interval of continuous transmission.

3.3.2 Measuring Instruments

Please refer to the measuring equipment list in this test report.

3.3.3 Test Procedures

1. The testing follows the ANSI C63.10 Section 11.10.2 Method PKPSD.
2. The RF output of EUT is connected to the spectrum analyzer by RF cable and attenuator. The path loss is compensated to the results for each measurement.
3. Set the maximum power setting and enable the EUT to transmit continuously.
4. Make the measurement with the spectrum analyzer's resolution bandwidth (RBW) = 3 kHz. Video bandwidth VBW = 10 kHz In order to make an accurate measurement, set the span to 1.5 times DTS Channel Bandwidth. (6dB BW)
5. Detector = peak, Sweep time = auto couple, Trace mode = max hold, Allow trace to fully stabilize. Use the peak marker function to determine the maximum power level.
6. Measure and record the results in the test report.
7. For MIMO mode, calculation method follows FCC KDB 662911 D01 Multiple Transmitter Output v02r01.

If measurements performed using method (2) plus $10 \log(N)$ exceeds the emission limit, the test should choose method (1) before declaring that the device fails the emission limit.

Method (1): Measure and sum the spectra across the outputs.

The total final Power Spectral Density is from a device with 2 transmitter outputs. The spectrum measurements of the individual outputs are all performed with the same span and number of points, the spectrum value in the first spectral bin of output 1 is summed with that in the first spectral bin of output 2 to obtain the value for the first frequency bin of the summed spectrum.

Method (2): Measure and add $10 \log(N)$ dB, where N is the number of outputs. (N=2)

3.3.4 Test Setup

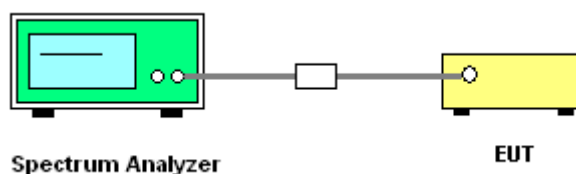



3.3.5 Test Result of Power Spectral Density

Please refer to Appendix A.

<CDD Modes>

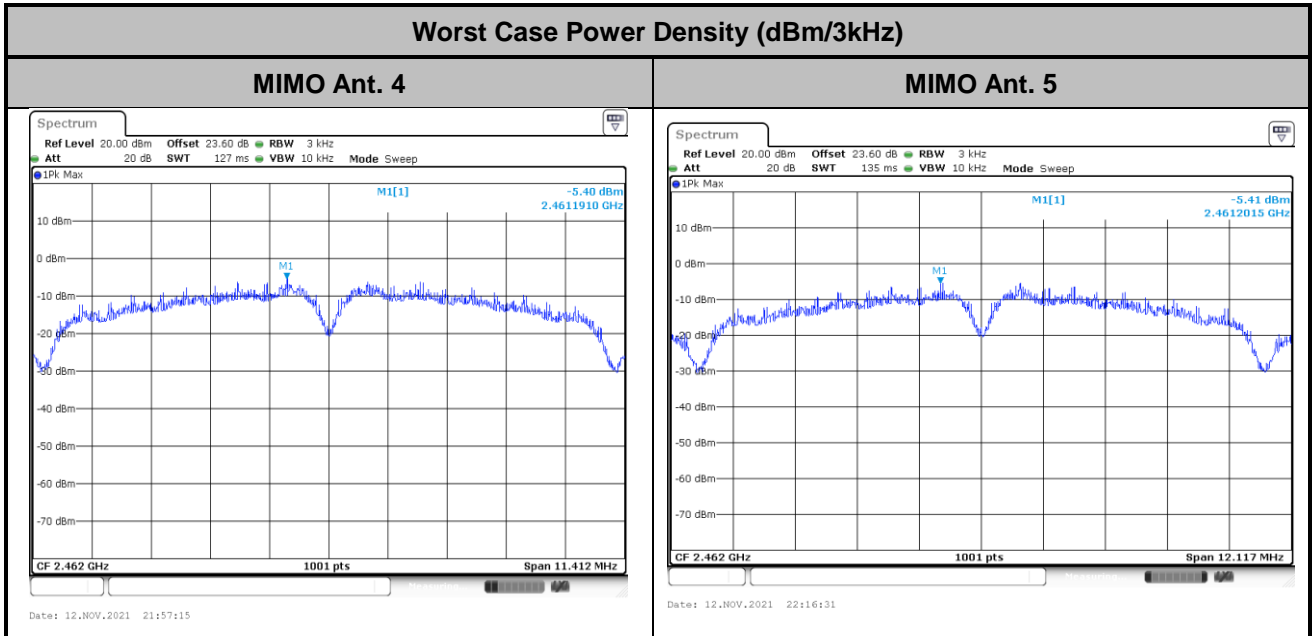

<802.11ax Modes>

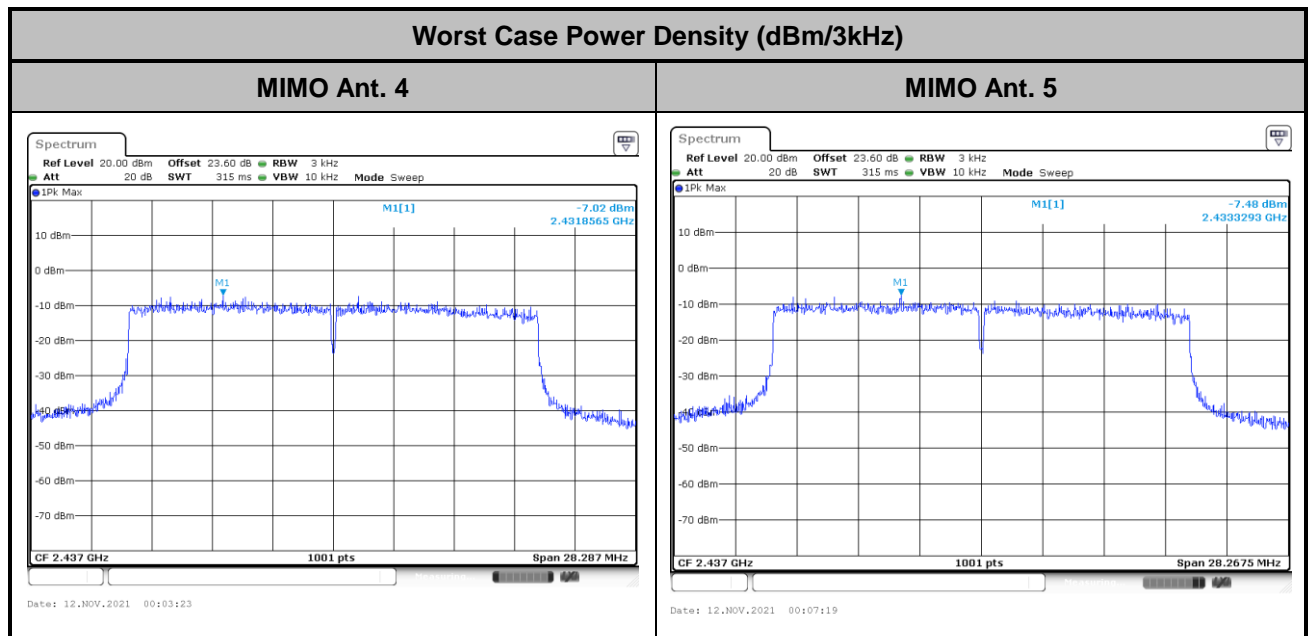



<TXBF Modes>

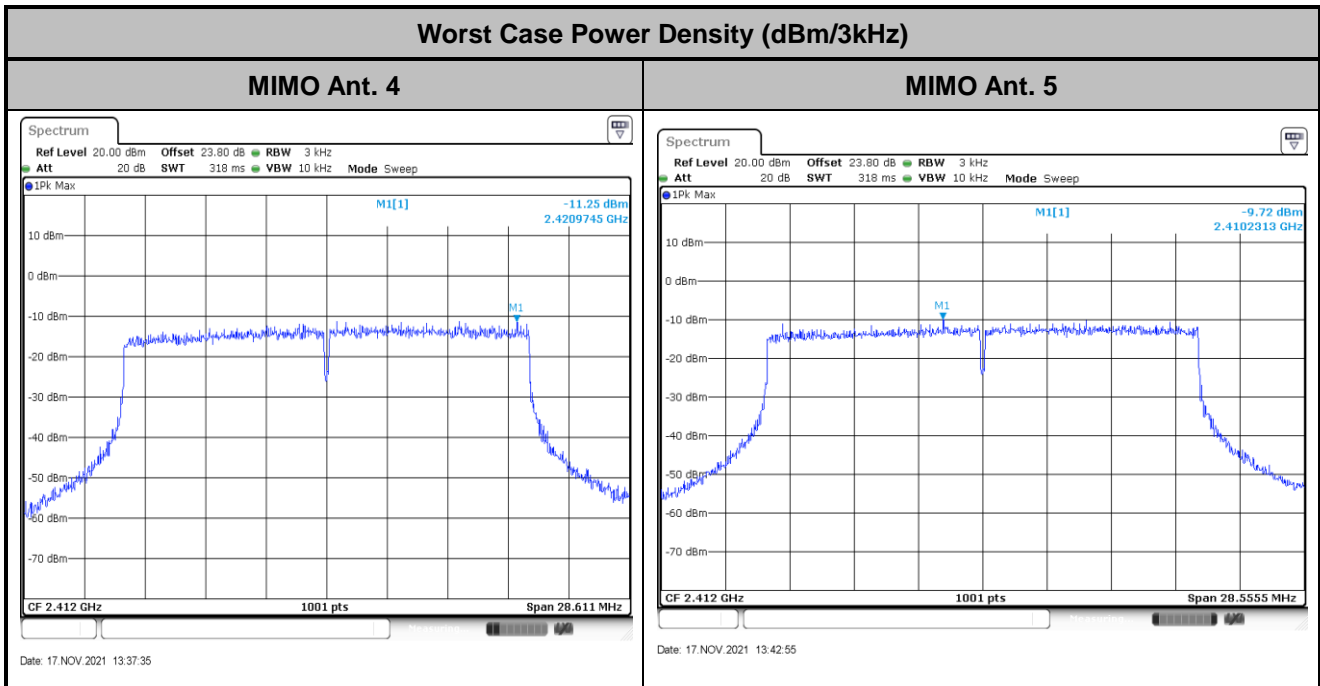

3.4 Conducted Band Edges and Spurious Emission Measurement

3.4.1 Limit of Conducted Band Edges and Spurious Emission Measurement

In any 100 kHz bandwidth outside of the authorized frequency band, the emissions which fall in the non-restricted bands shall be attenuated at least 20 dB / 30dB relative to the maximum PSD level in 100 kHz by RF conducted measurement.

3.4.2 Measuring Instruments

Please refer to the measuring equipment list in this test report.

3.4.3 Test Procedures

1. The testing follows the ANSI C63.10 Section 11.11.3 Emission level measurement
2. The RF output of EUT is connected to the spectrum analyzer by RF cable and attenuator. The path loss is compensated to the results for each measurement.
3. Set the maximum power setting and enable the EUT to transmit continuously.
4. Set RBW = 100 kHz, VBW = 300 kHz, Peak Detector. Unwanted Emissions measured in any 100 kHz bandwidth outside of the authorized frequency band shall be attenuated by at least 20 dB relative to the maximum in-band peak PSD level in 100 kHz when maximum peak conducted output power procedure is used. If the transmitter complies with the conducted power limits based on the use of RMS averaging over a time interval, the attenuation required under this paragraph shall be 30 dB instead of 20 dB per 15.247(d).
5. Measure and record the results in the test report.
6. The RF fundamental frequency should be excluded against the limit line in the operating frequency band.

3.4.4 Test Setup

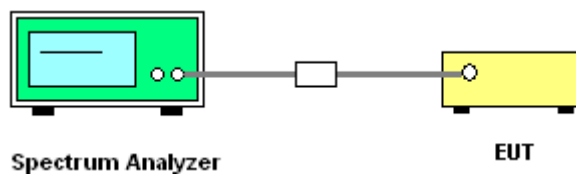



3.4.5 Test Result of Conducted Band Edges and Spurious Emission

<CDD Mode>

Number of TX = 2, Ant. 4 (Measured)

Test Mode :	802.11b	Test Channel :	01
-------------	---------	----------------	----

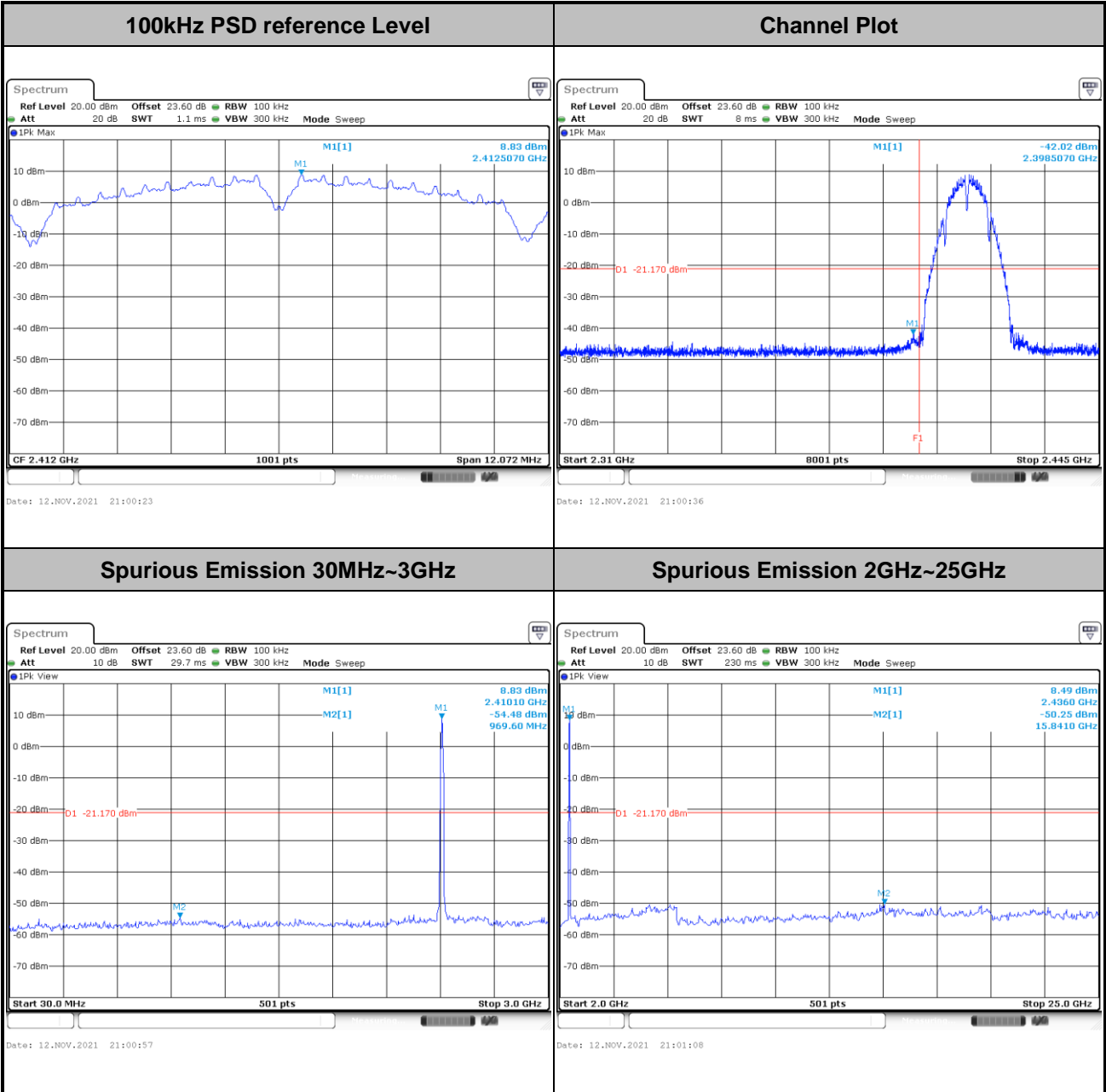



Test Mode :	802.11b	Test Channel :	06
-------------	---------	----------------	----

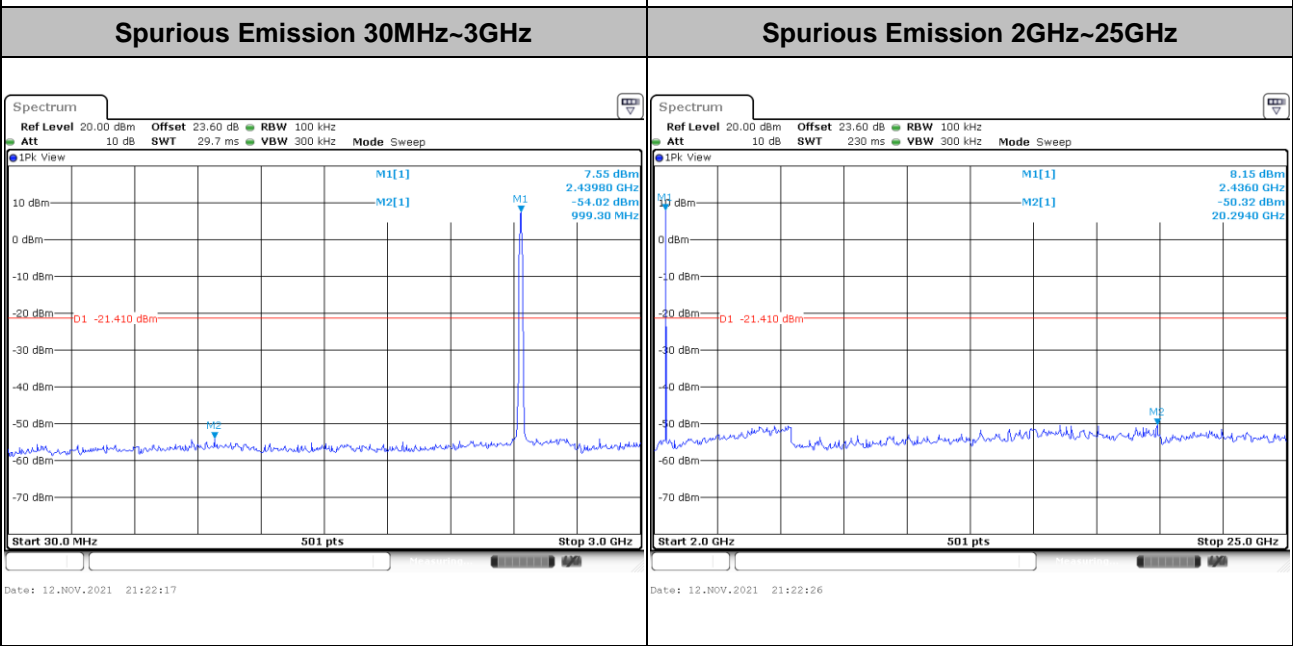
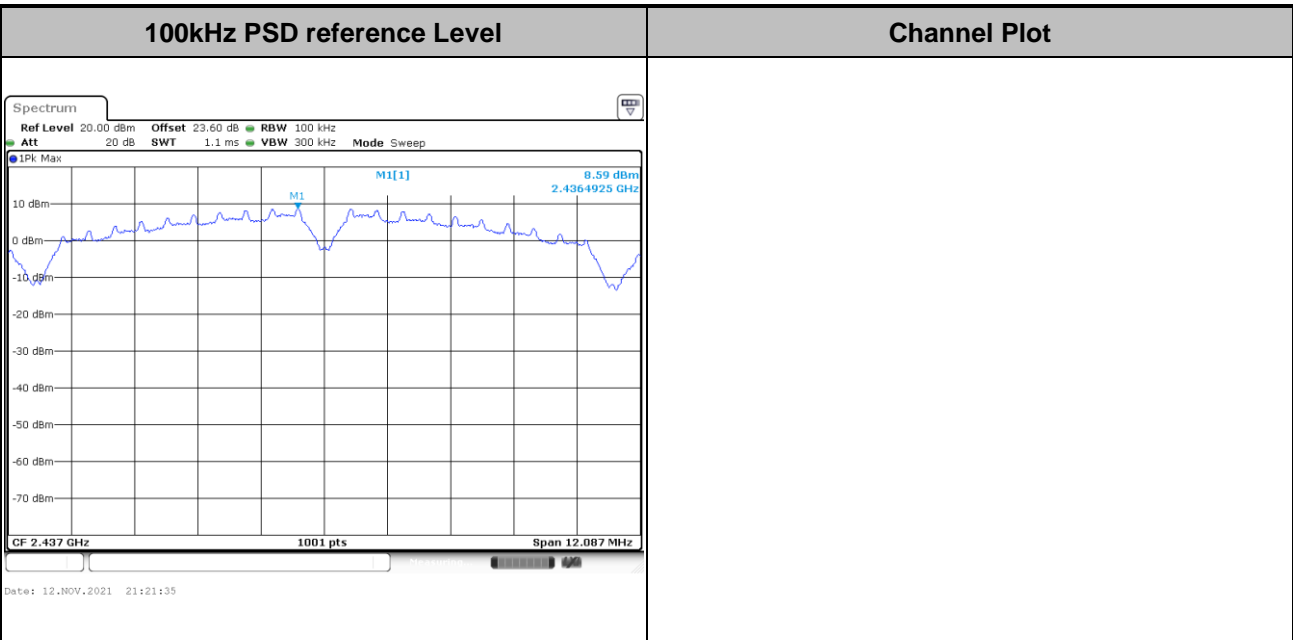



Test Mode :	802.11b	Test Channel :	11
-------------	---------	----------------	----

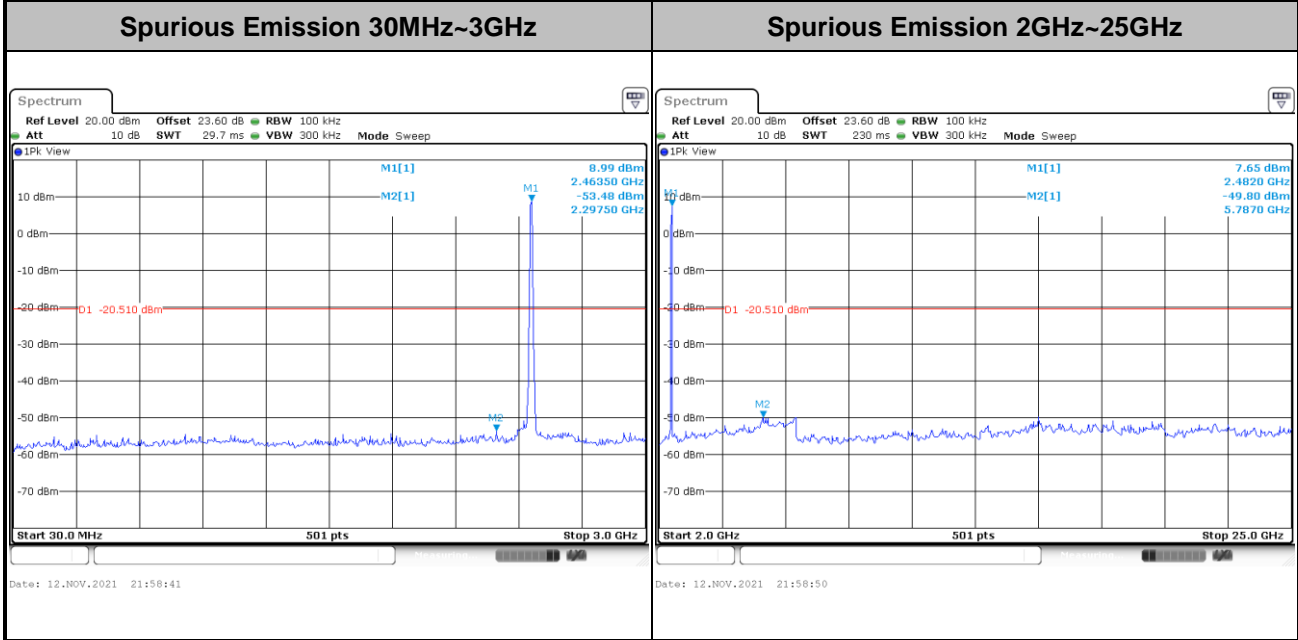
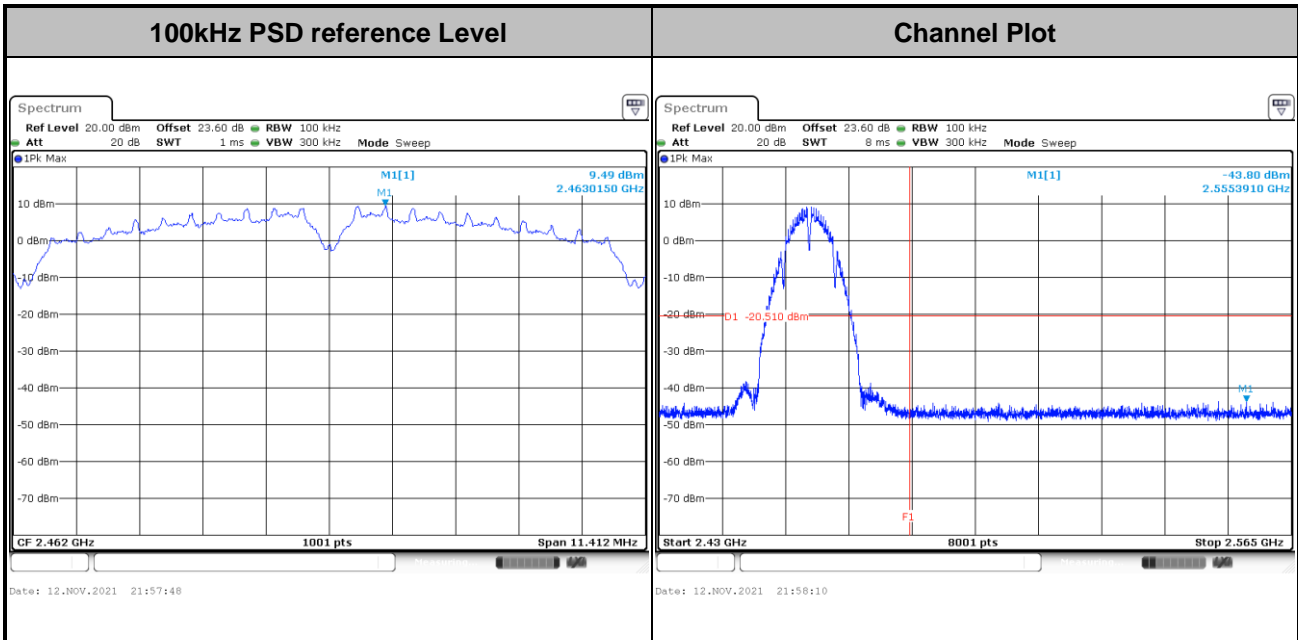



Test Mode : 802.11g Test Channel : 01

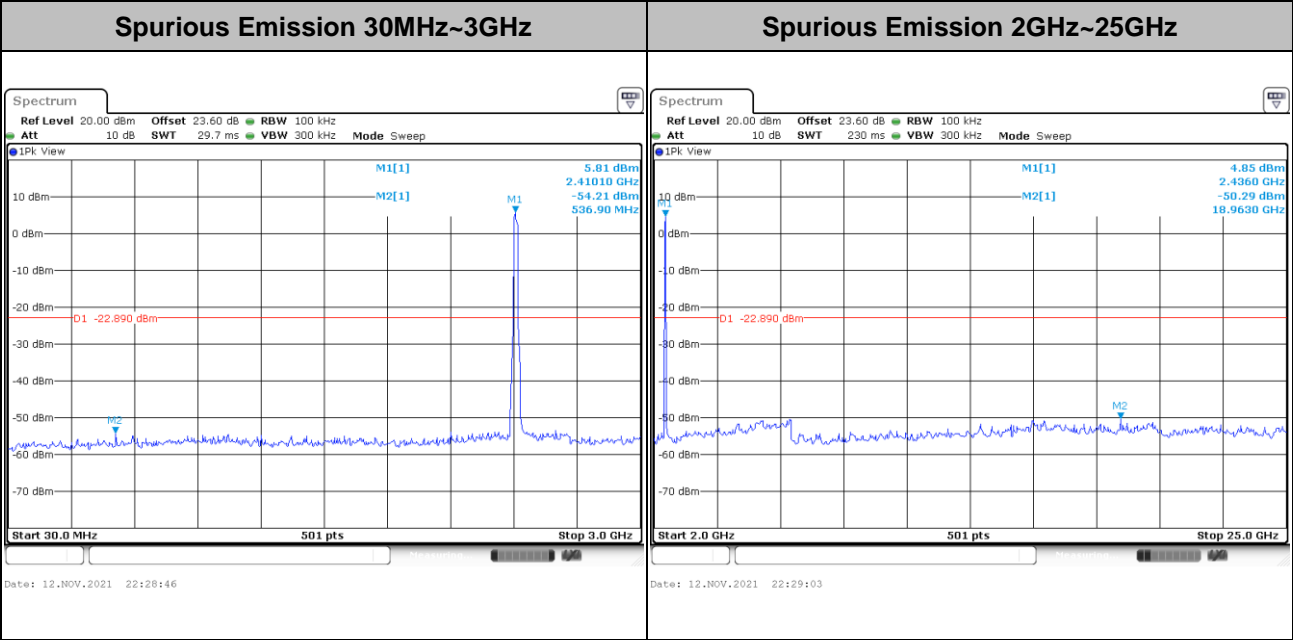
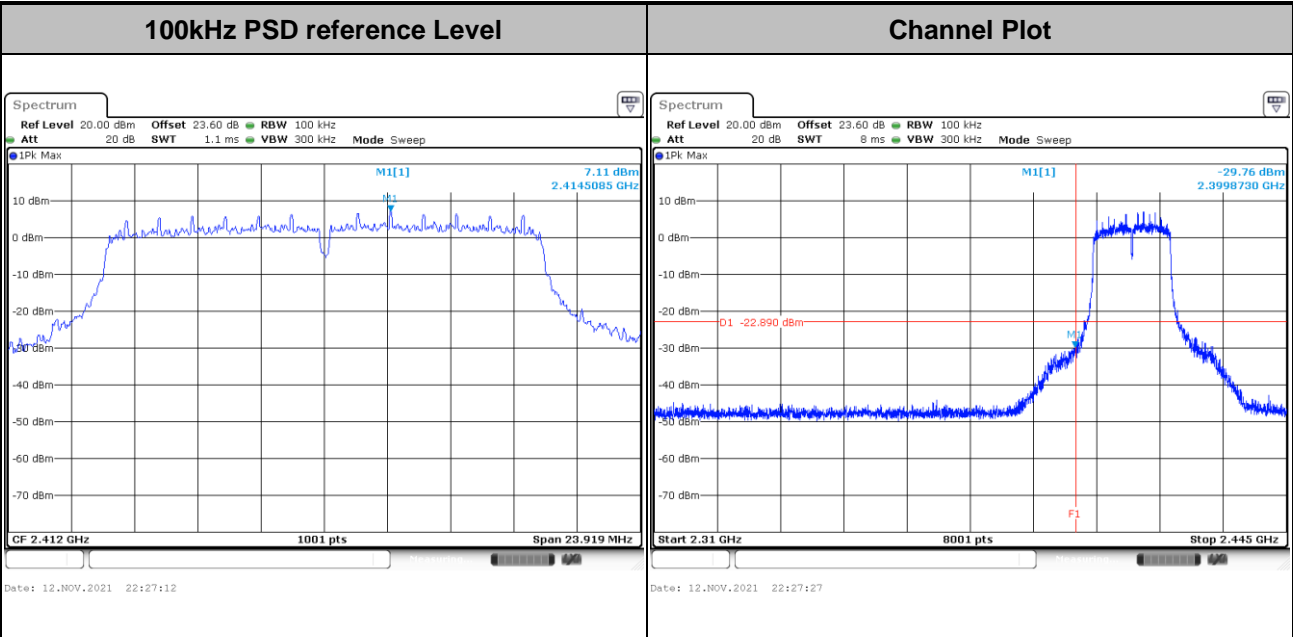



Test Mode :	802.11g	Test Channel :	06
-------------	---------	----------------	----

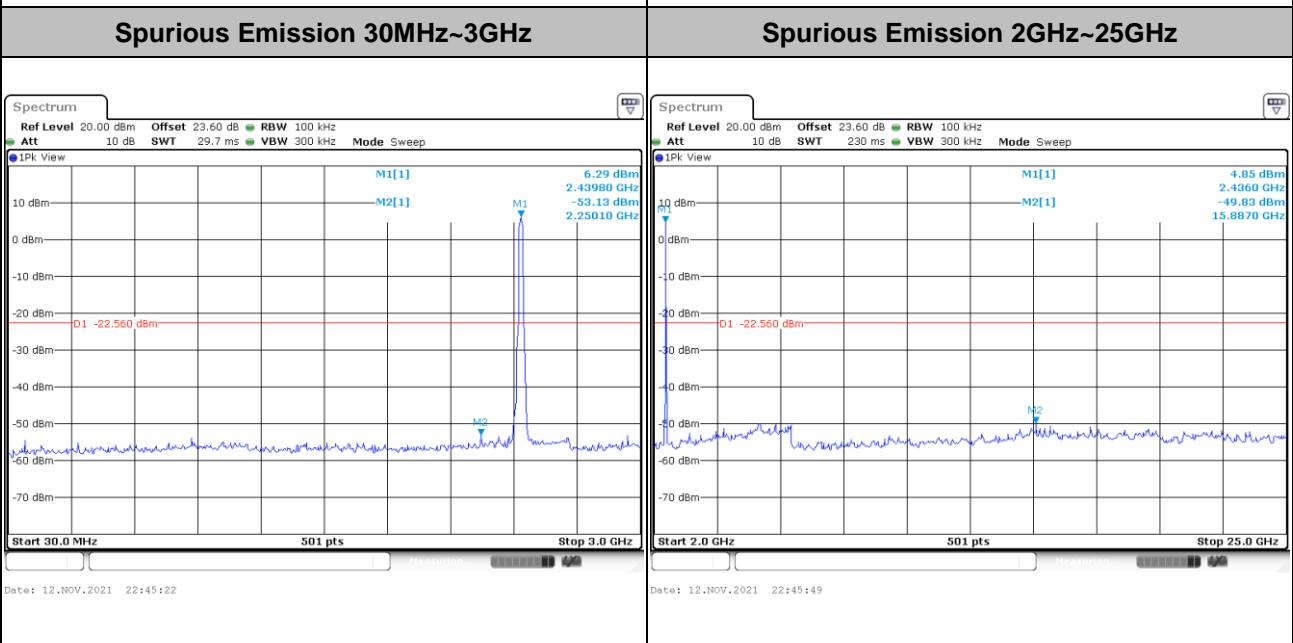
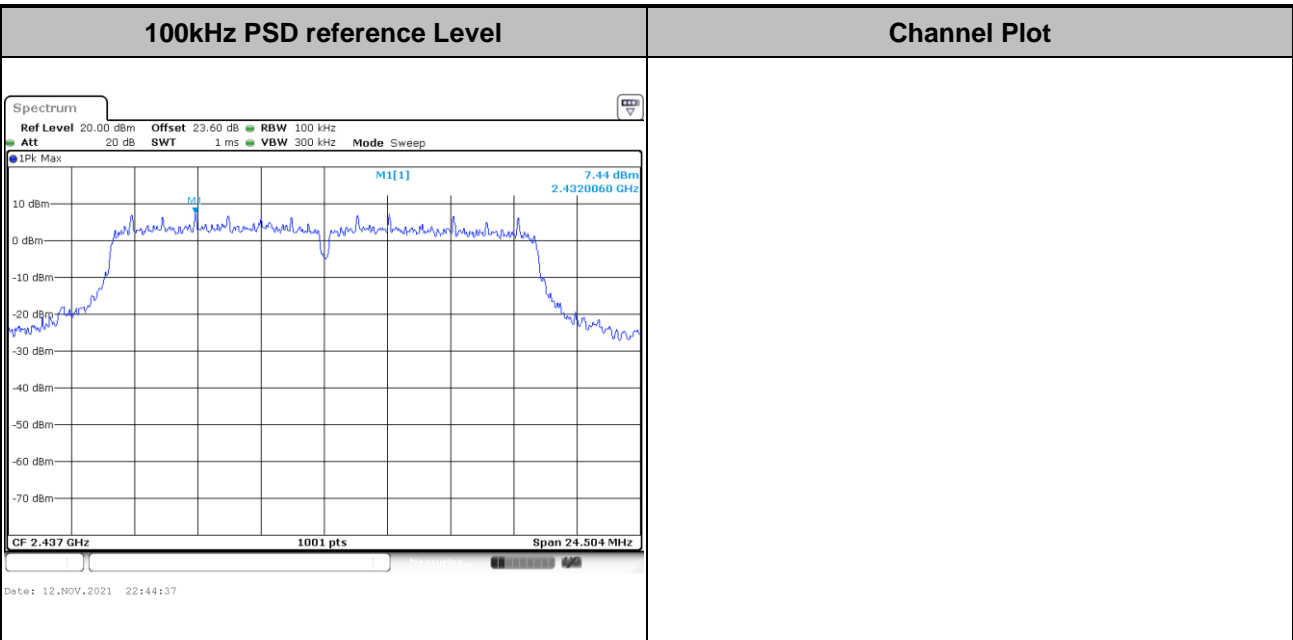



Test Mode :	802.11g	Test Channel :	11
-------------	---------	----------------	----

100kHz PSD reference Level	Channel Plot
-----------------------------------	---------------------

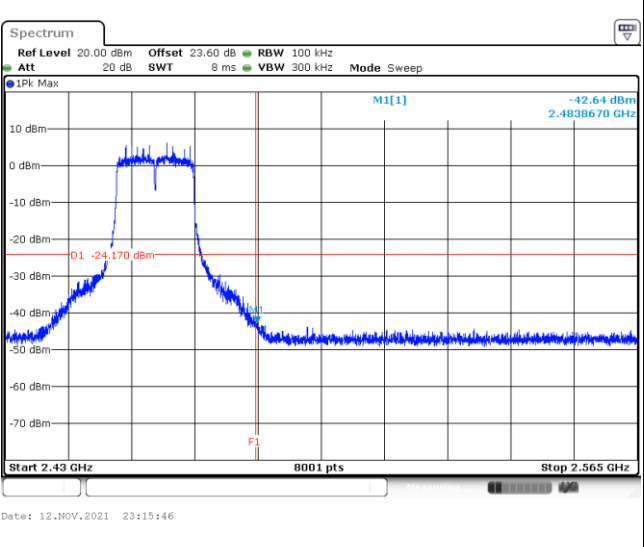
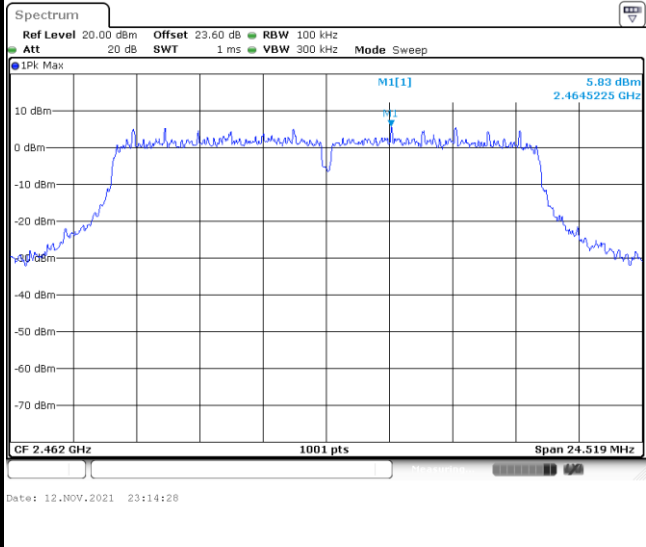

Spurious Emission 30MHz~3GHz

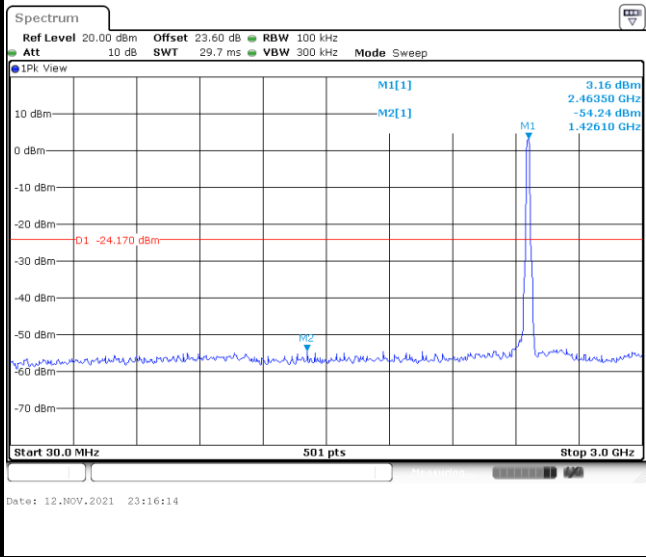

Spurious Emission 2GHz~25GHz

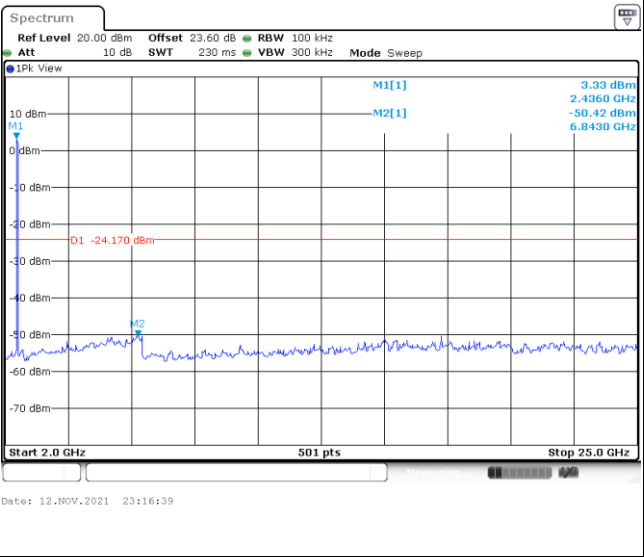



Test Mode :	802.11ax HE20	Test Channel :	01
-------------	---------------	----------------	----

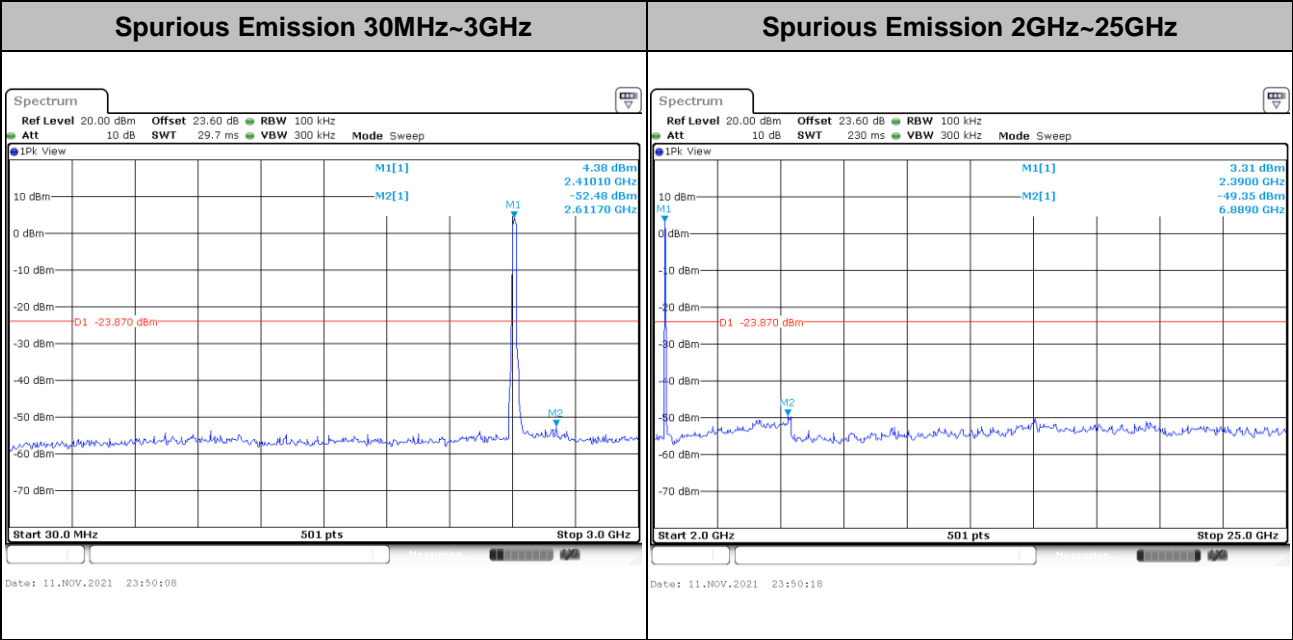
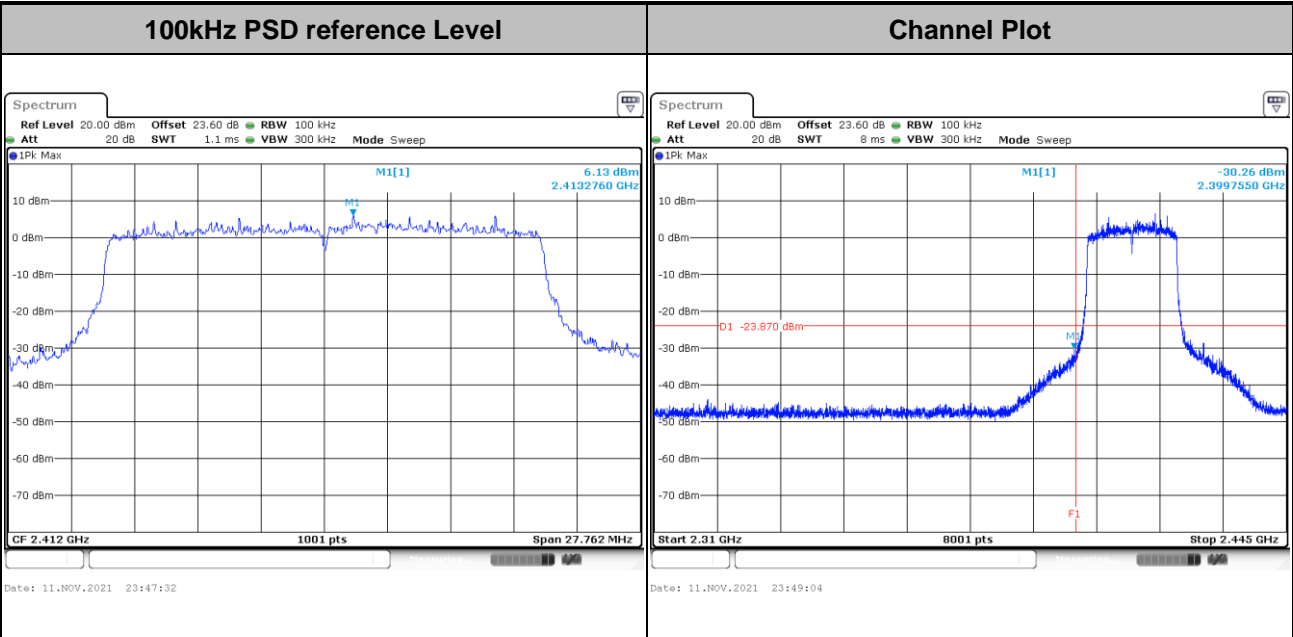



Test Mode :	802.11ax HE20	Test Channel :	06
-------------	---------------	----------------	----

100kHz PSD reference Level	Channel Plot
-----------------------------------	---------------------

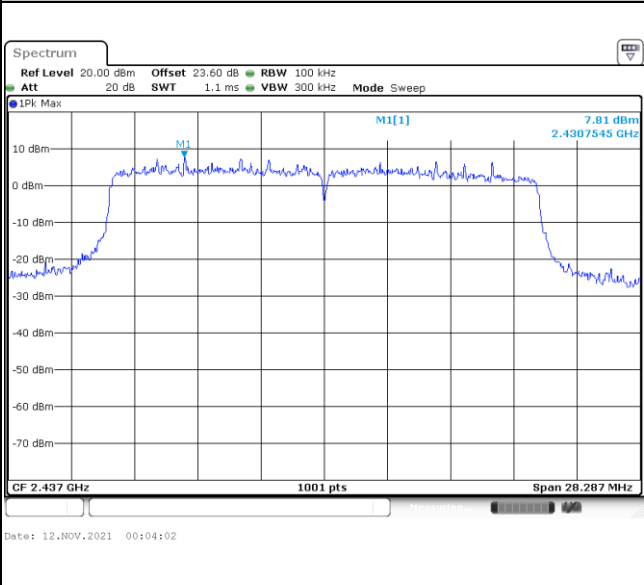

Spurious Emission 30MHz~3GHz

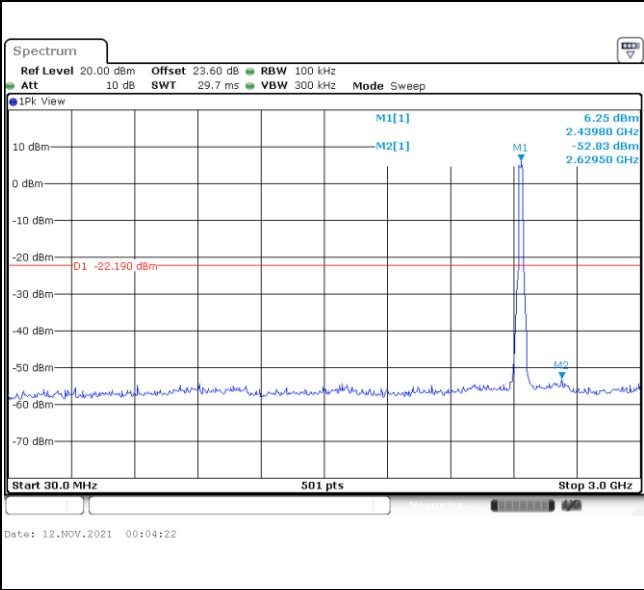

Spurious Emission 2GHz~25GHz

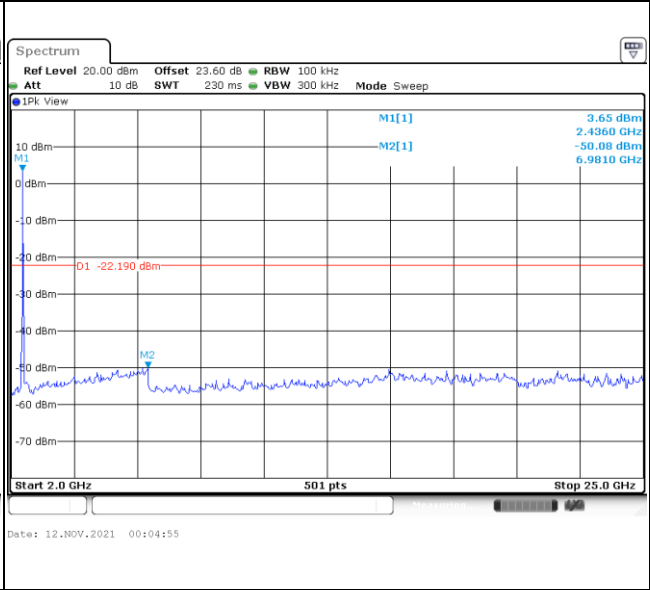



Test Mode :	802.11ax HE20	Test Channel :	11
-------------	---------------	----------------	----

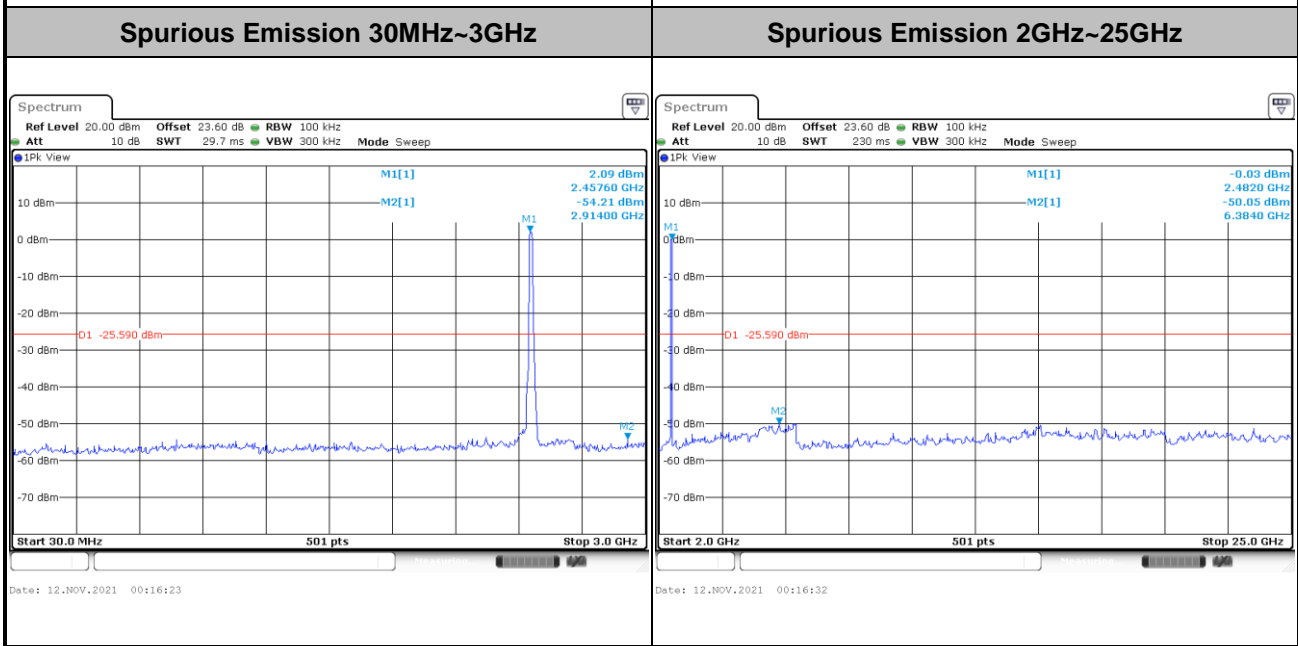
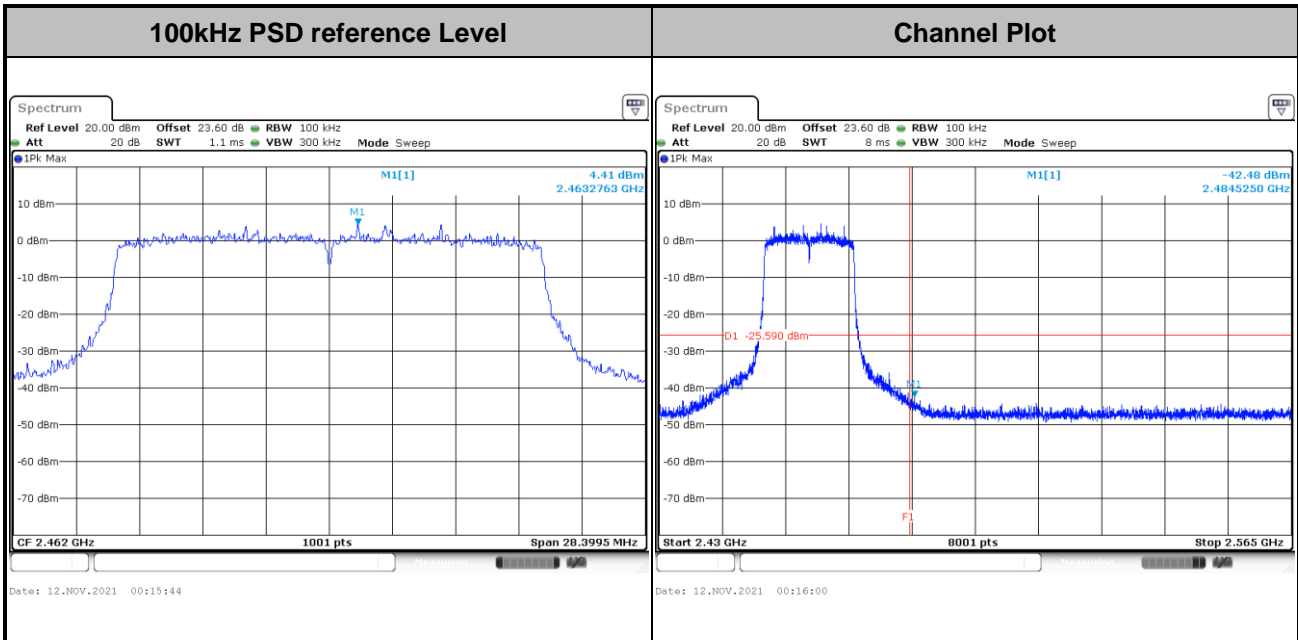



Test Mode : 802.11ax HE40 Test Channel : 03

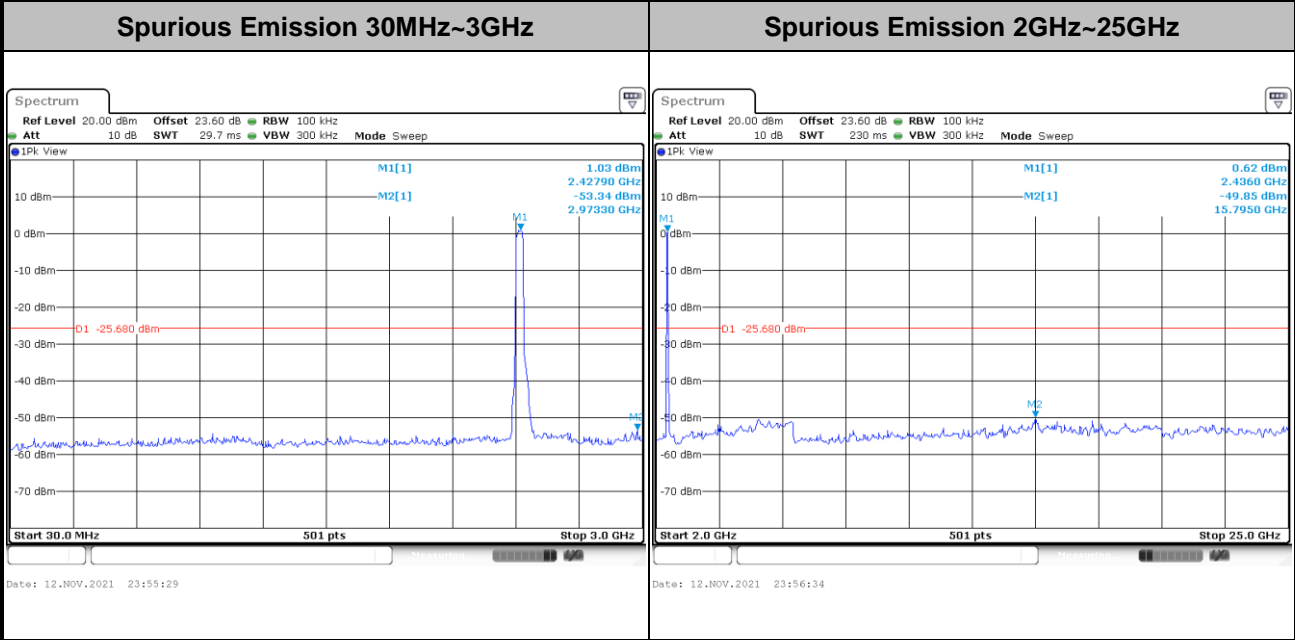
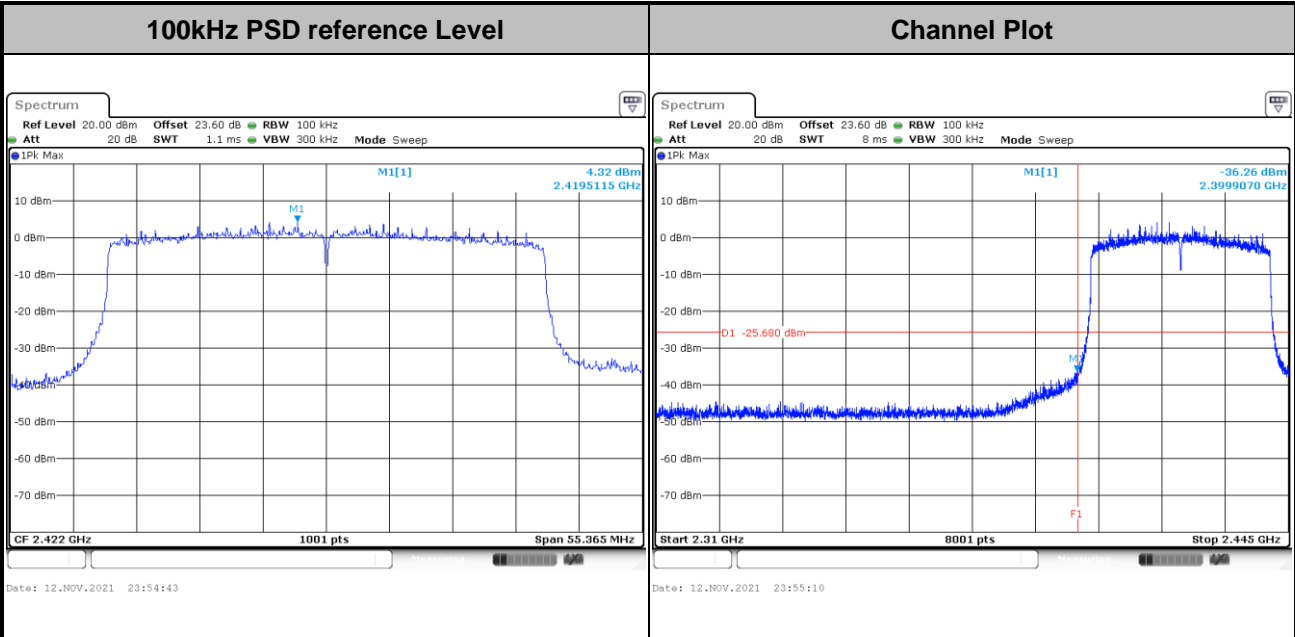



Test Mode :	802.11ax HE40	Test Channel :	06
-------------	---------------	----------------	----

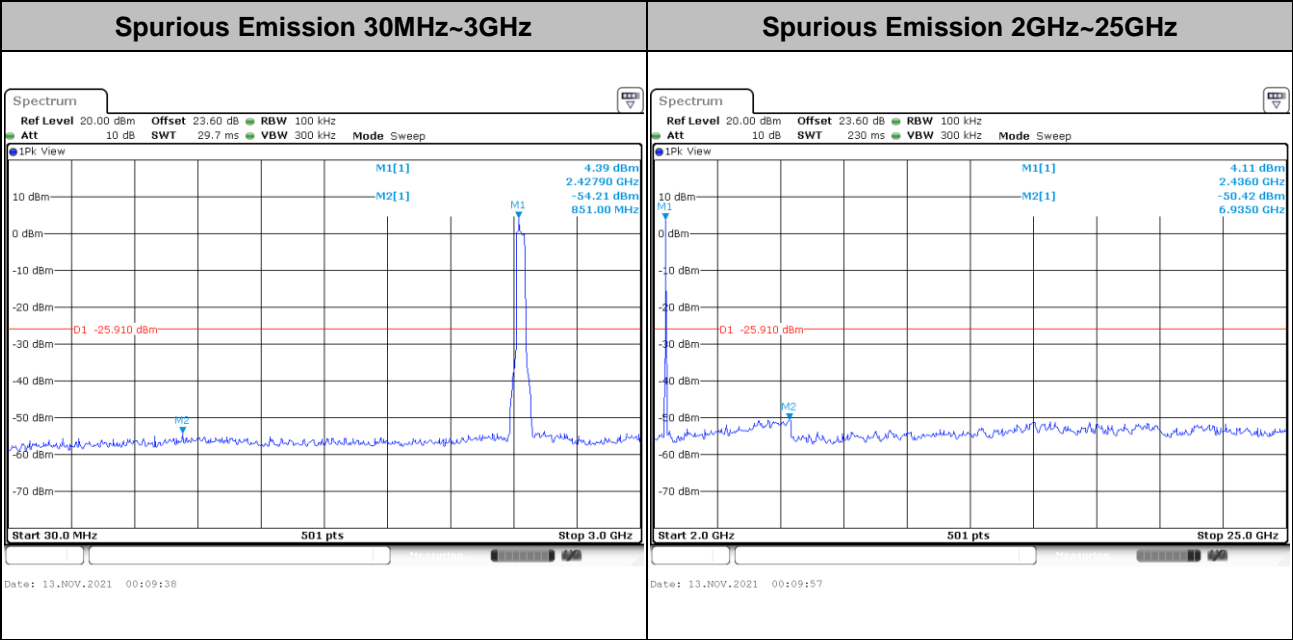
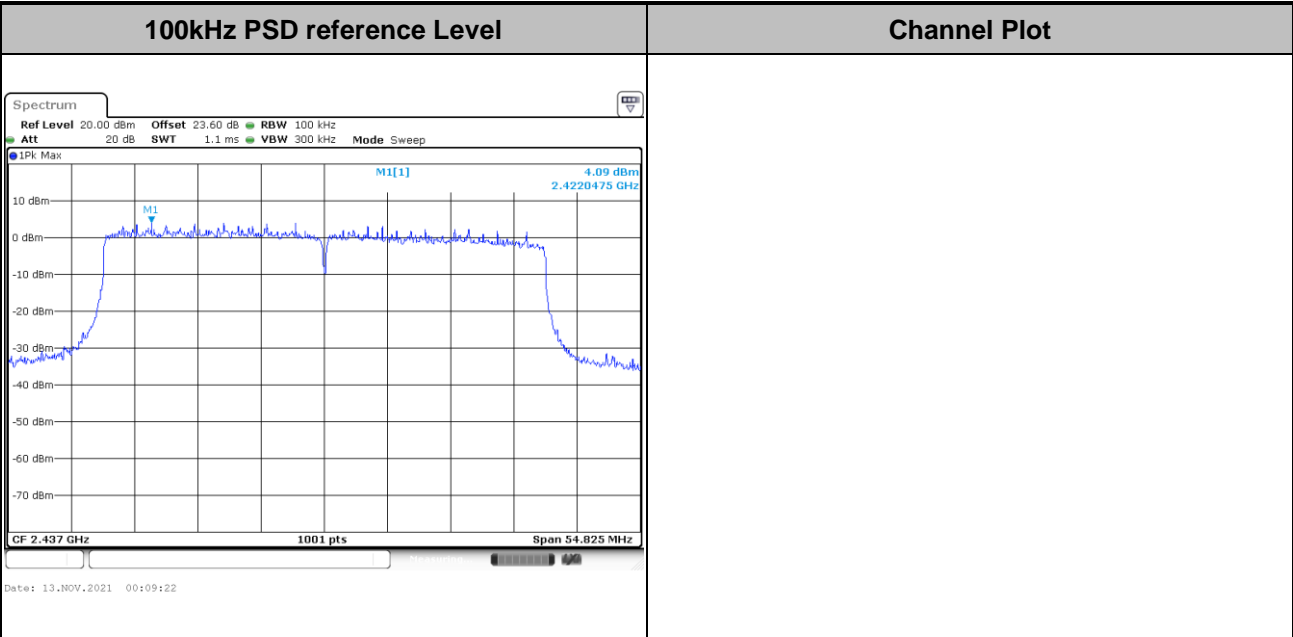



Test Mode : 802.11ax HE40 Test Channel : 09

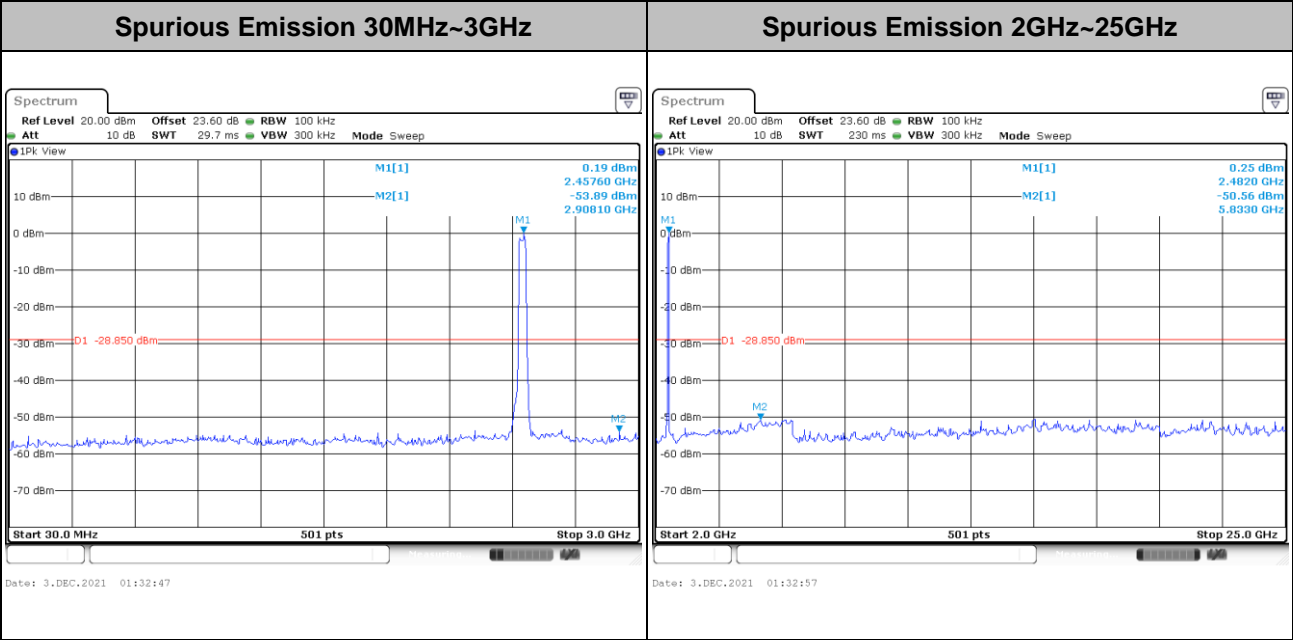
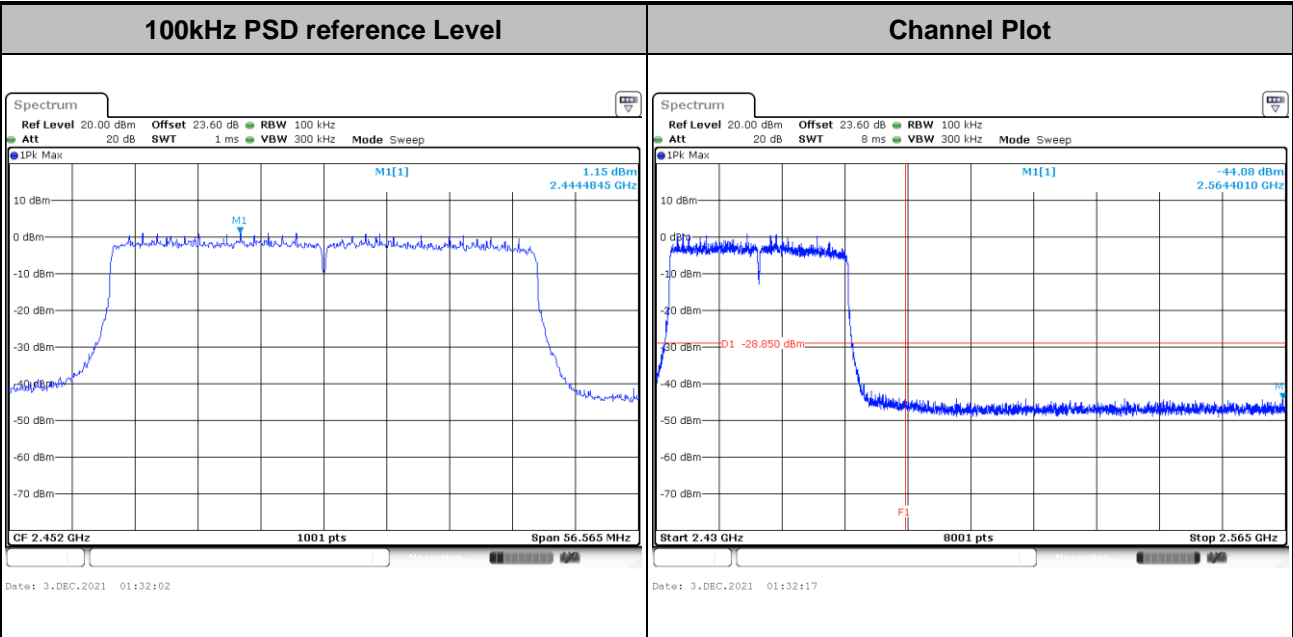



Number of TX = 2, Ant. 5 (Measured)

Test Mode :	802.11b	Test Channel :	01
-------------	---------	----------------	----

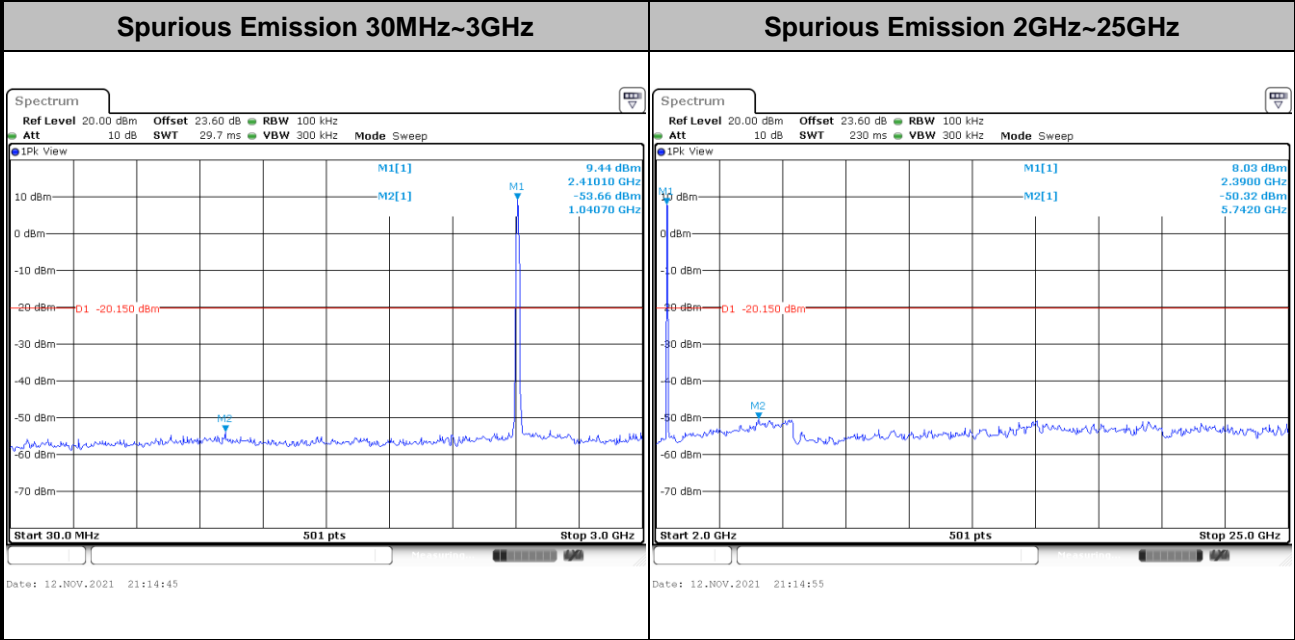
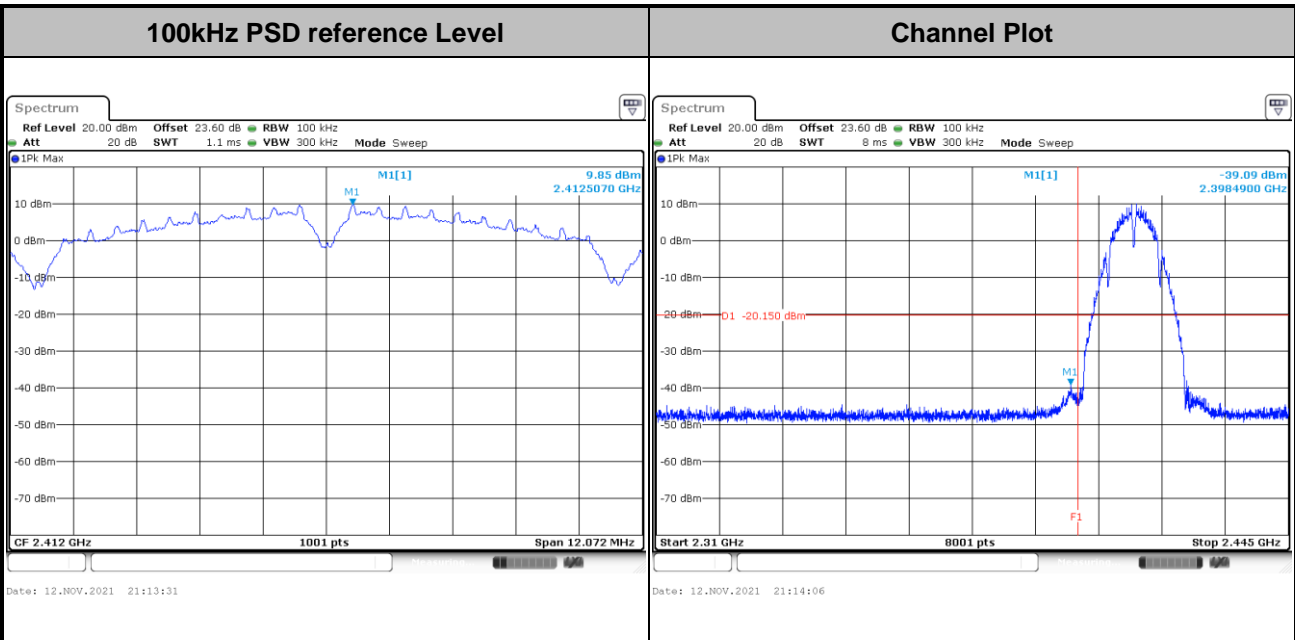



Test Mode :	802.11b	Test Channel :	06
-------------	---------	----------------	----

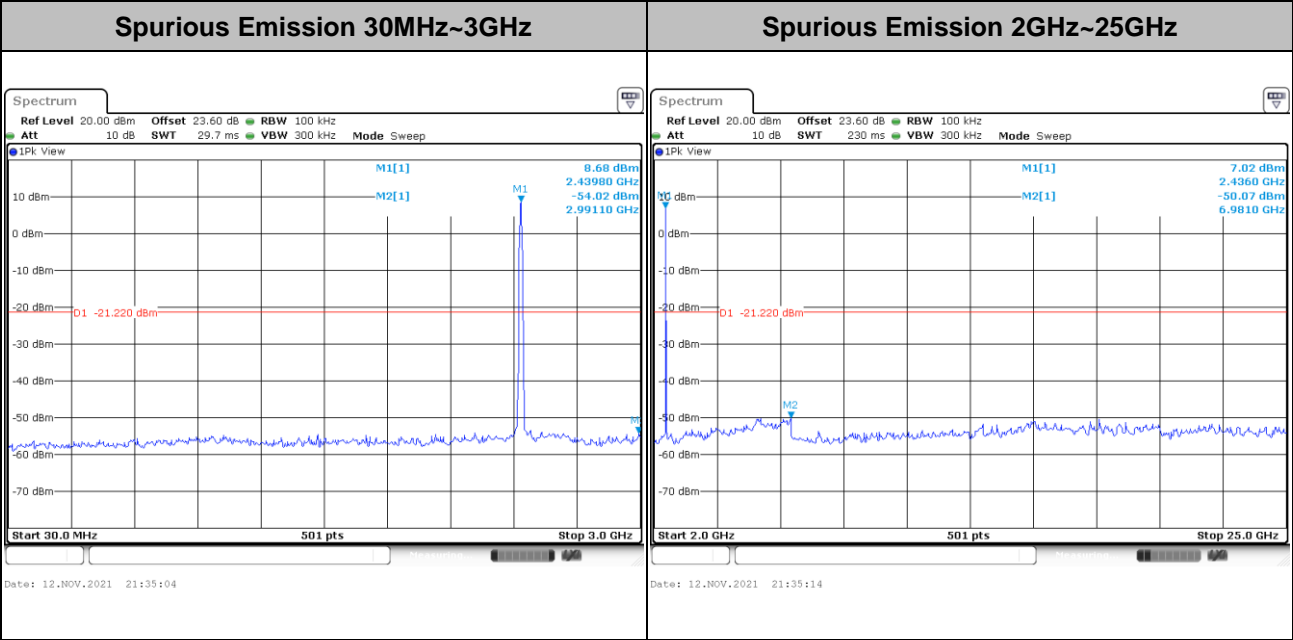
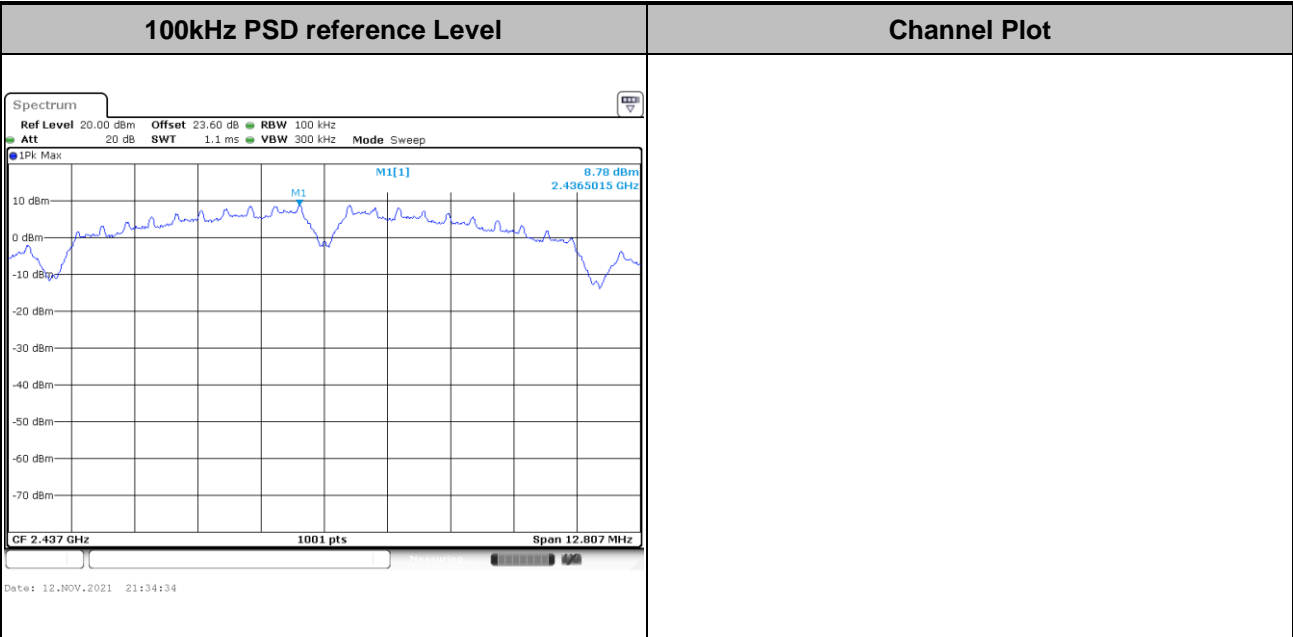



Test Mode :	802.11b	Test Channel :	11
-------------	---------	----------------	----

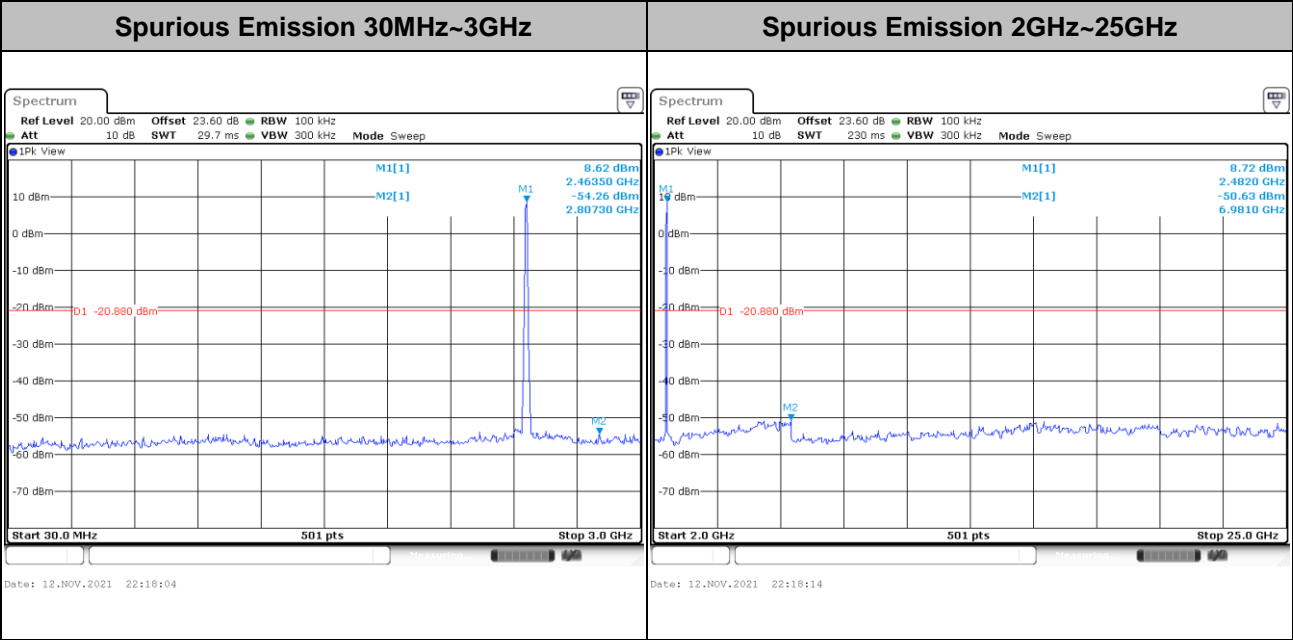
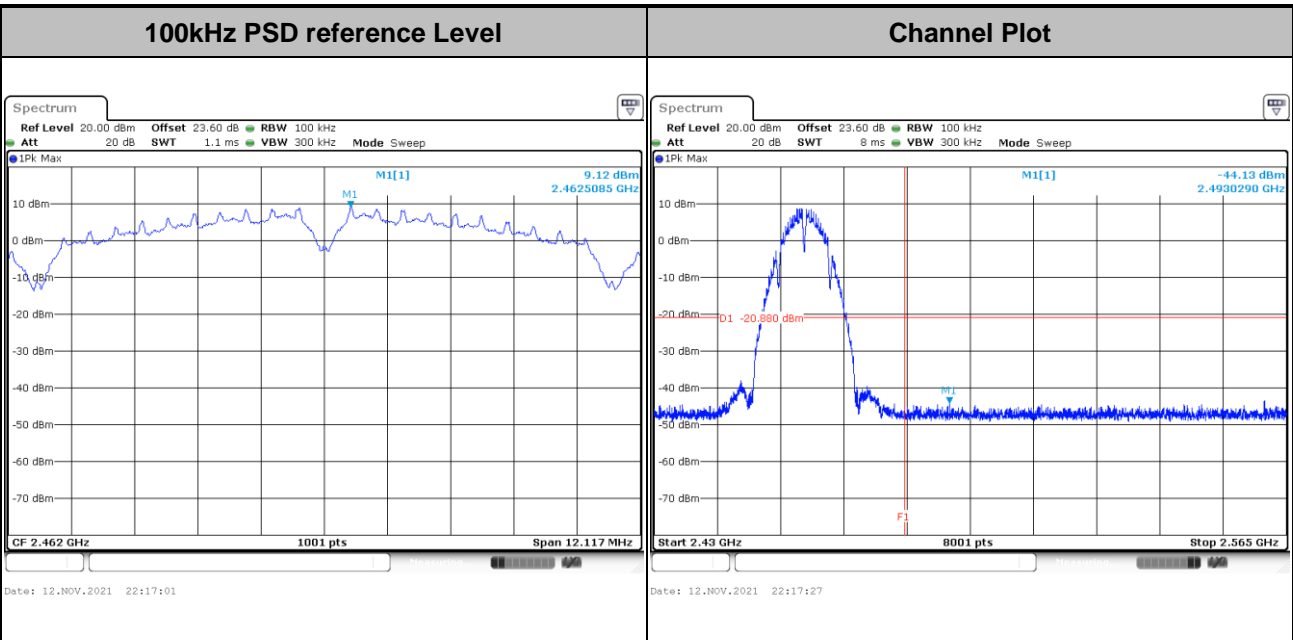



Test Mode : 802.11g Test Channel : 01

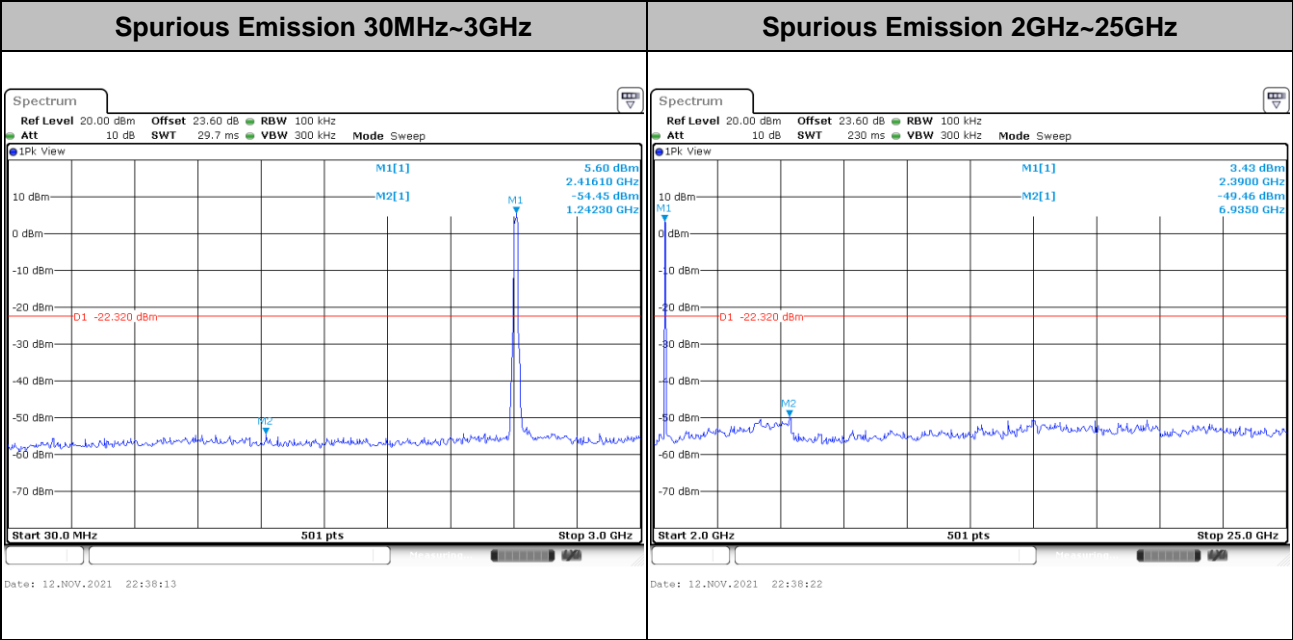
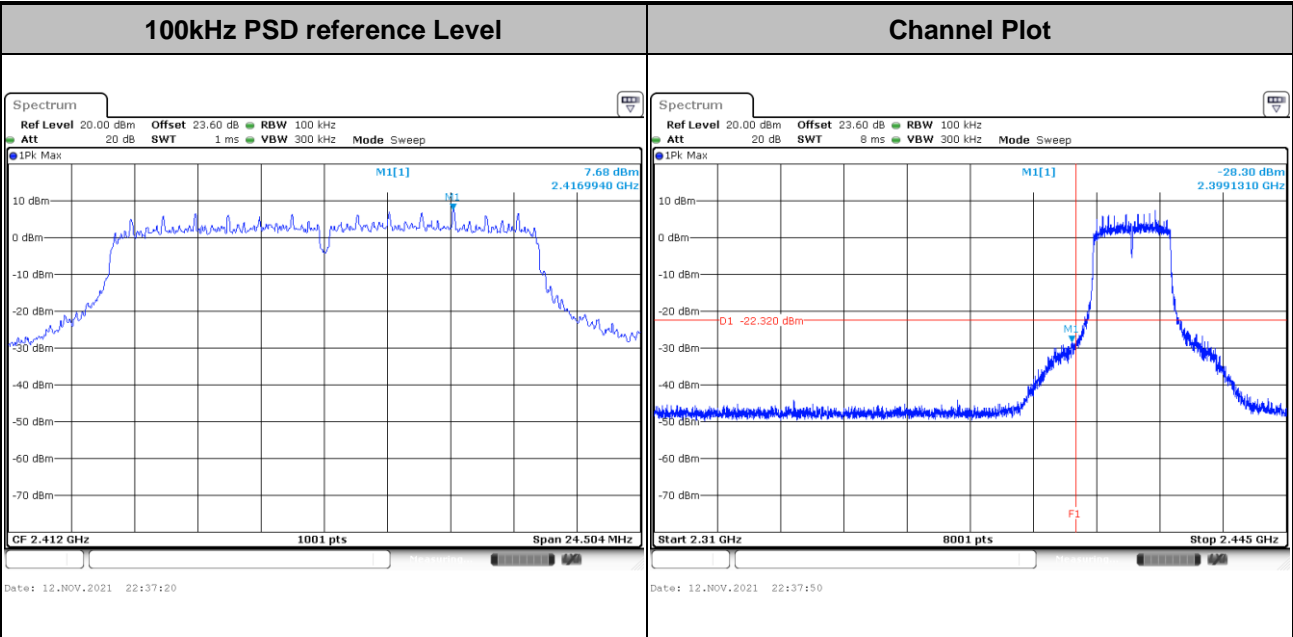



Test Mode :	802.11g	Test Channel :	06
-------------	---------	----------------	----

100kHz PSD reference Level	Channel Plot
-----------------------------------	---------------------

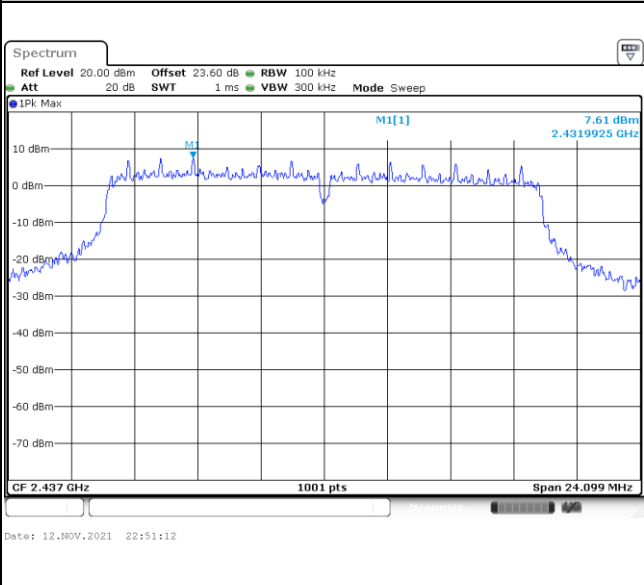

Spurious Emission 30MHz~3GHz	Spurious Emission 2GHz~25GHz
-------------------------------------	-------------------------------------

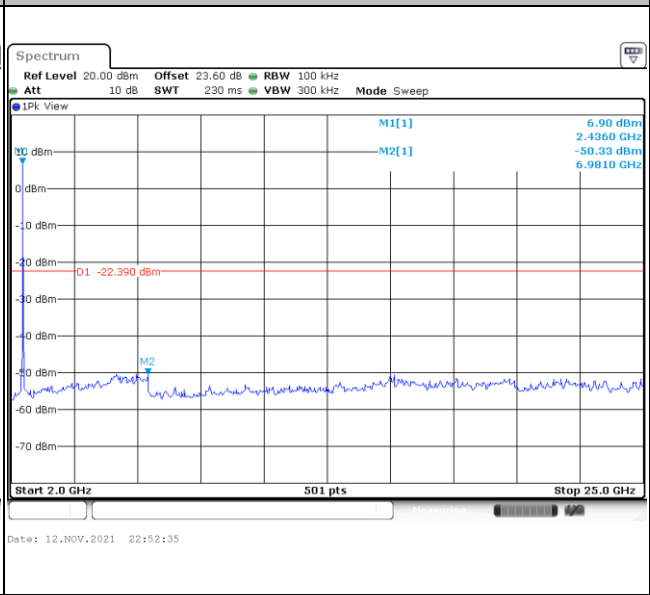
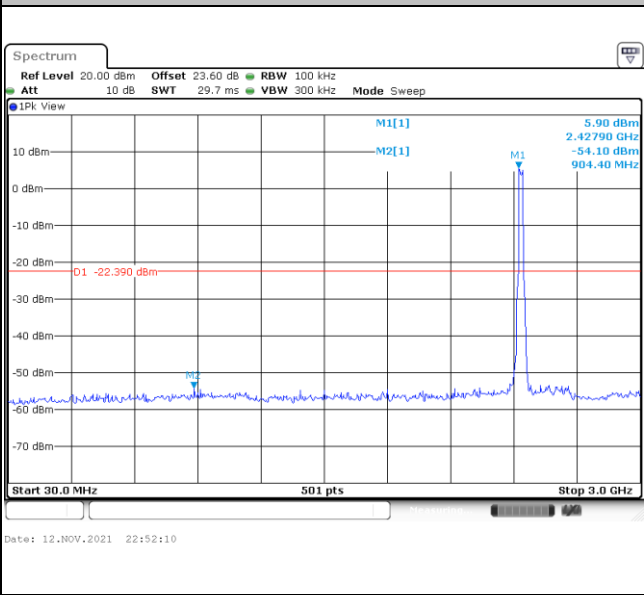



Test Mode : 802.11g Test Channel : 11

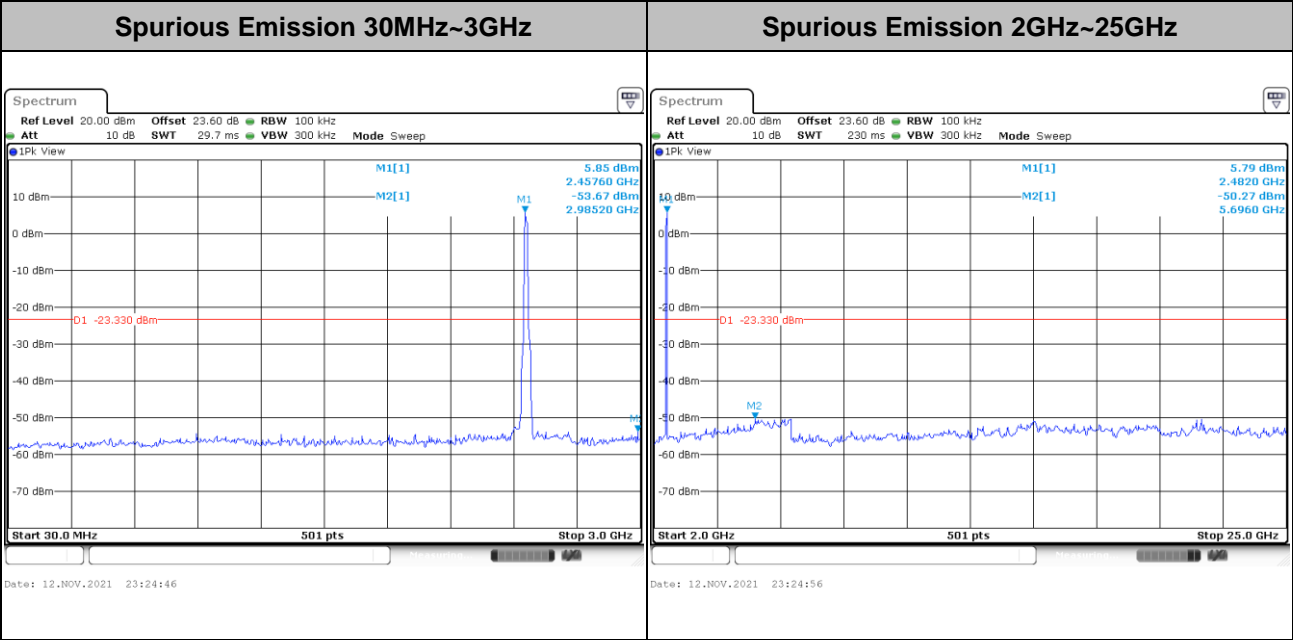
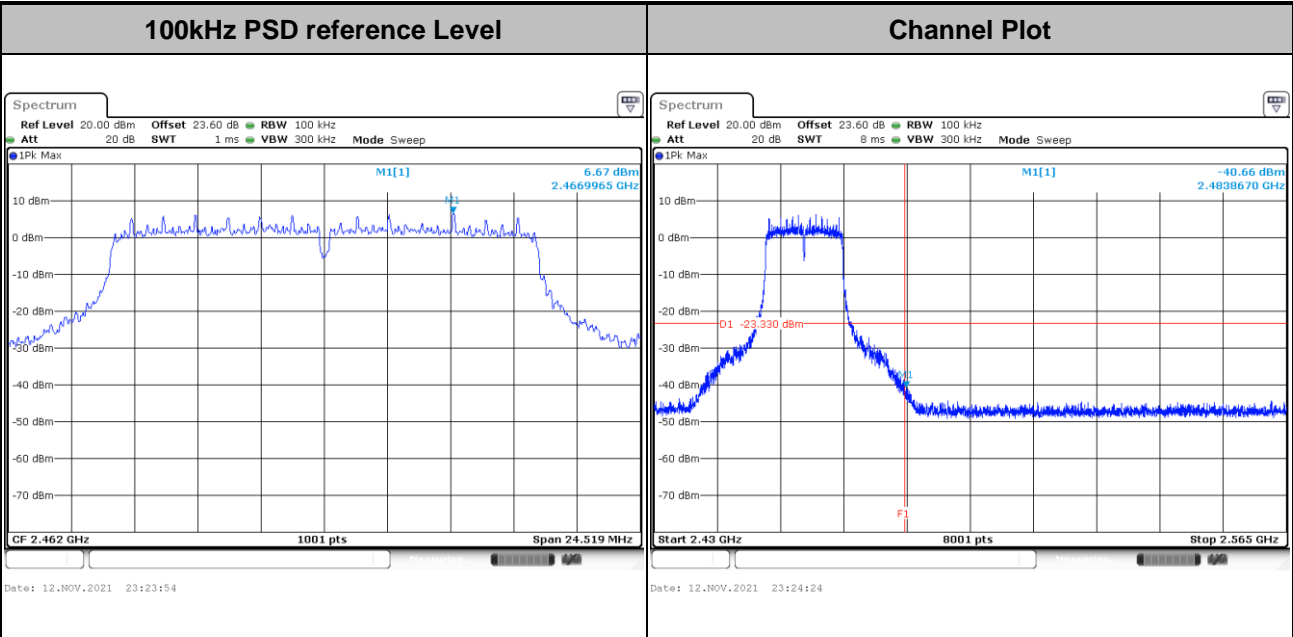



Test Mode : 802.11ax HE20 Test Channel : 01

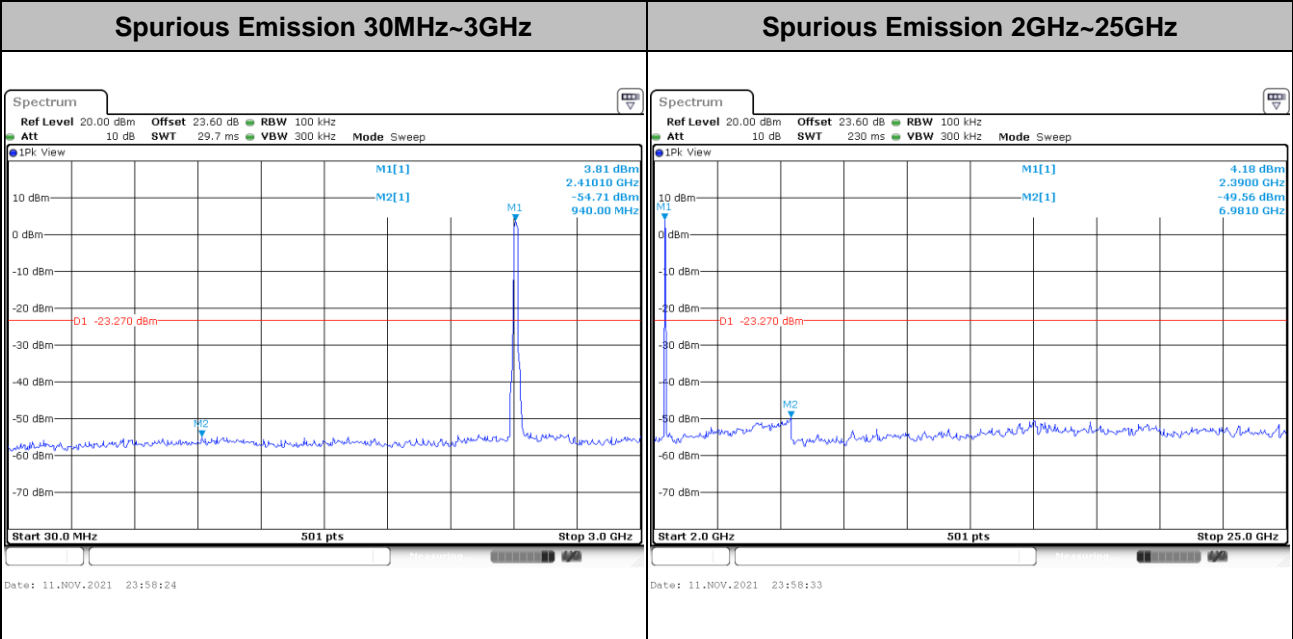
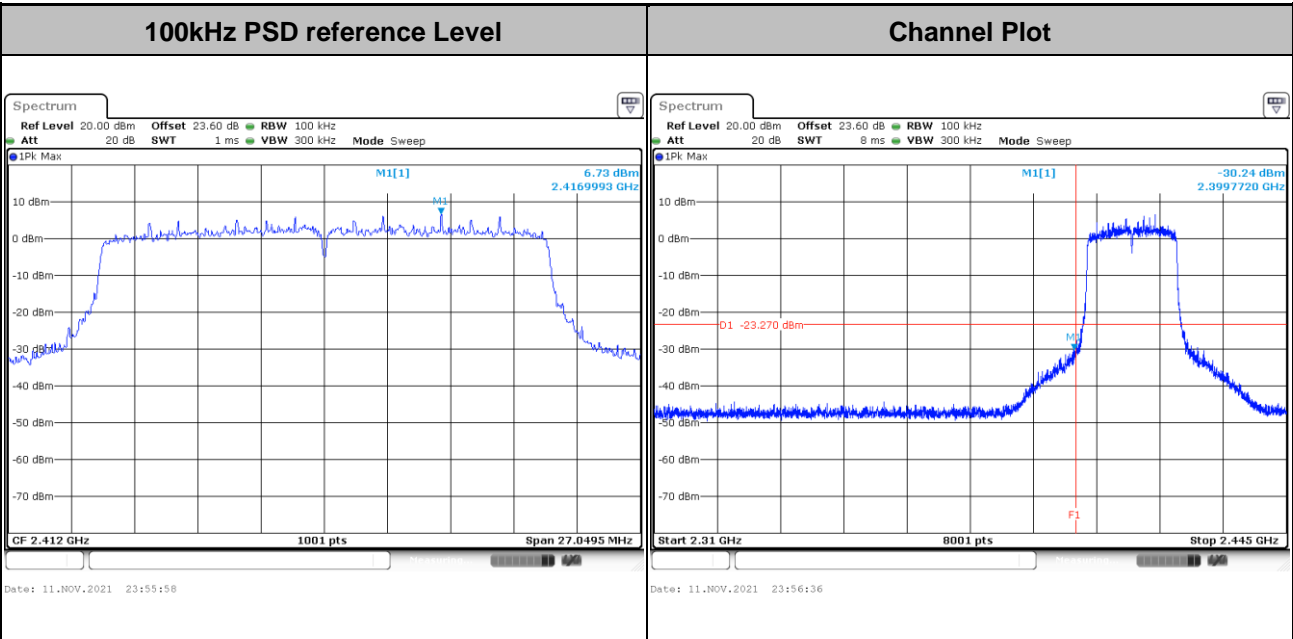



Test Mode :	802.11ax HE20	Test Channel :	06
-------------	---------------	----------------	----

100kHz PSD reference Level	Channel Plot
-----------------------------------	---------------------

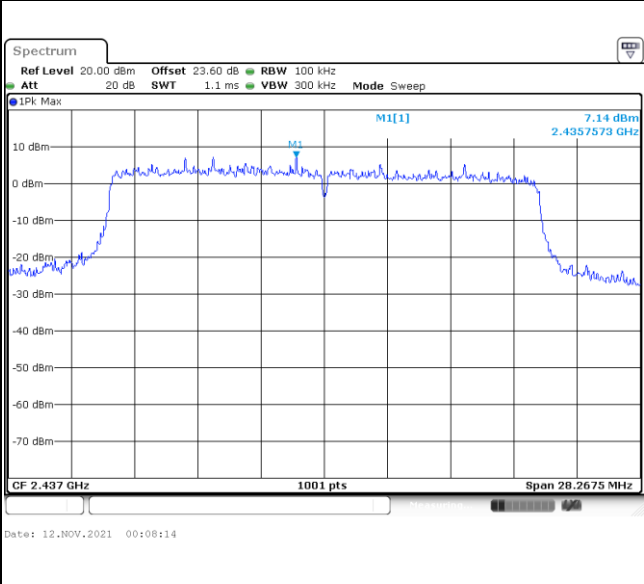

Spurious Emission 30MHz~3GHz	Spurious Emission 2GHz~25GHz
-------------------------------------	-------------------------------------

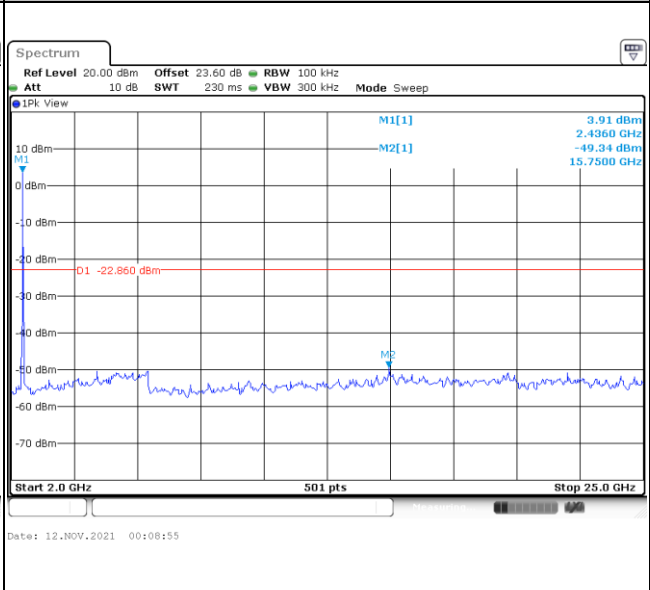
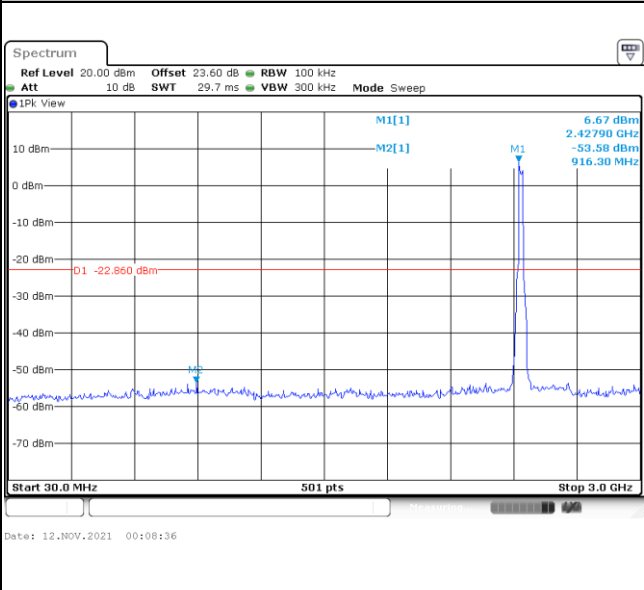



Test Mode :	802.11ax HE20	Test Channel :	11
-------------	---------------	----------------	----

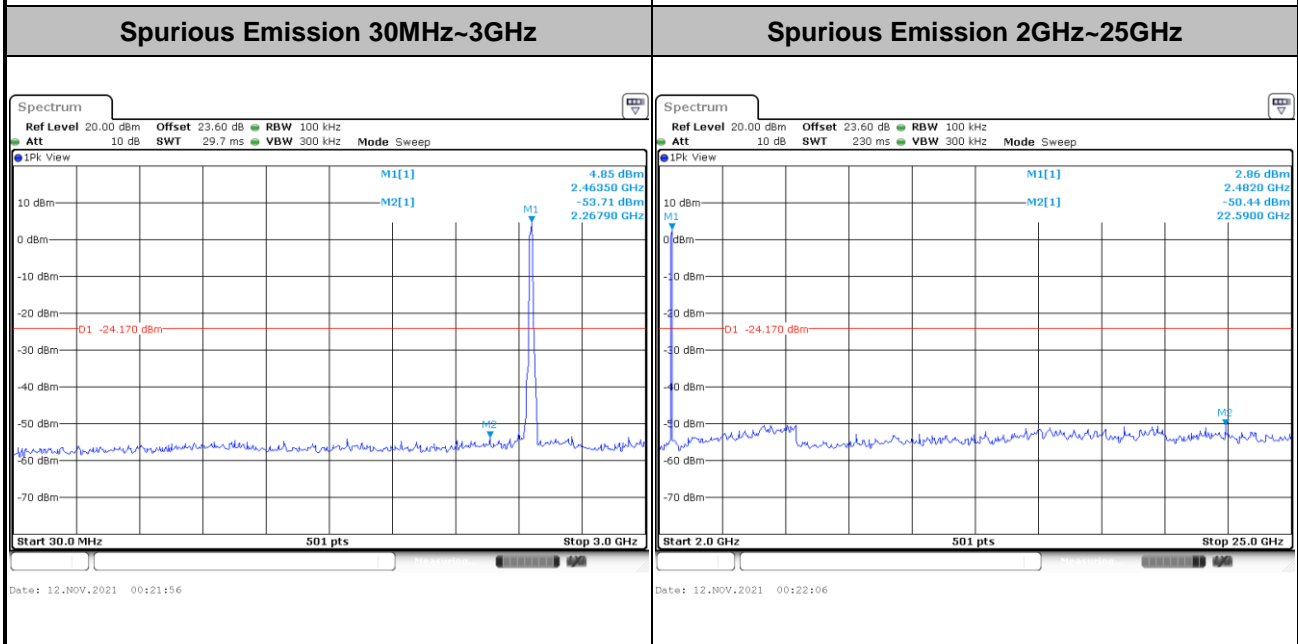
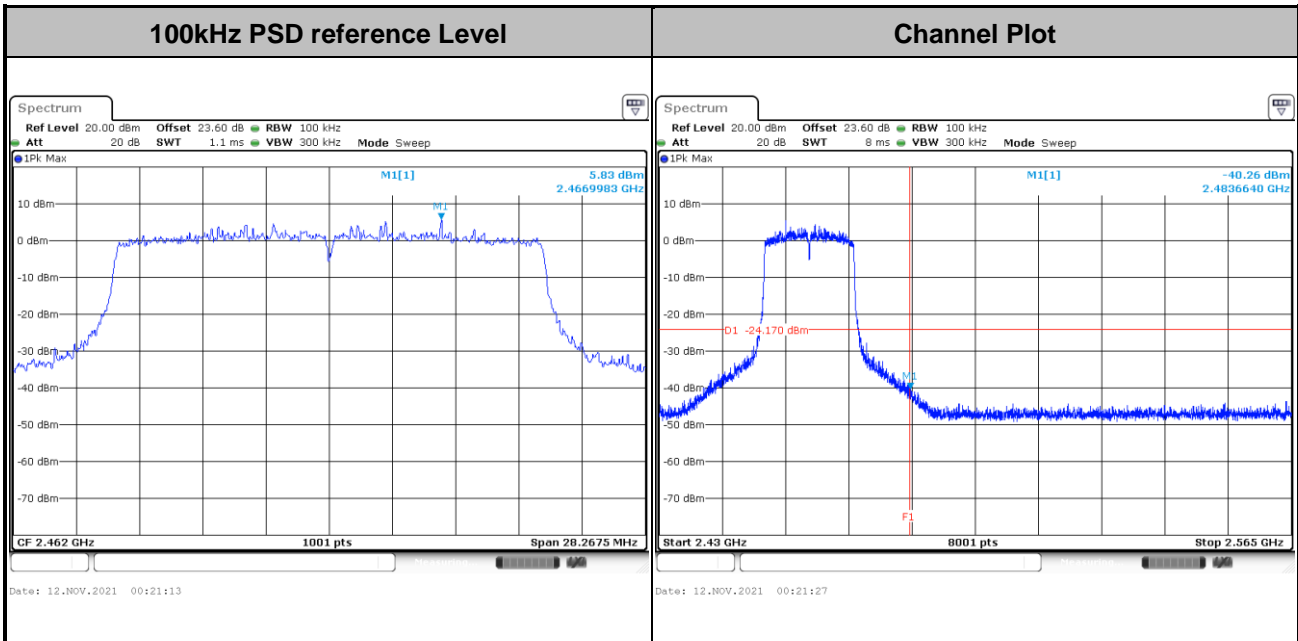



Test Mode : 802.11ax HE40 Test Channel : 03

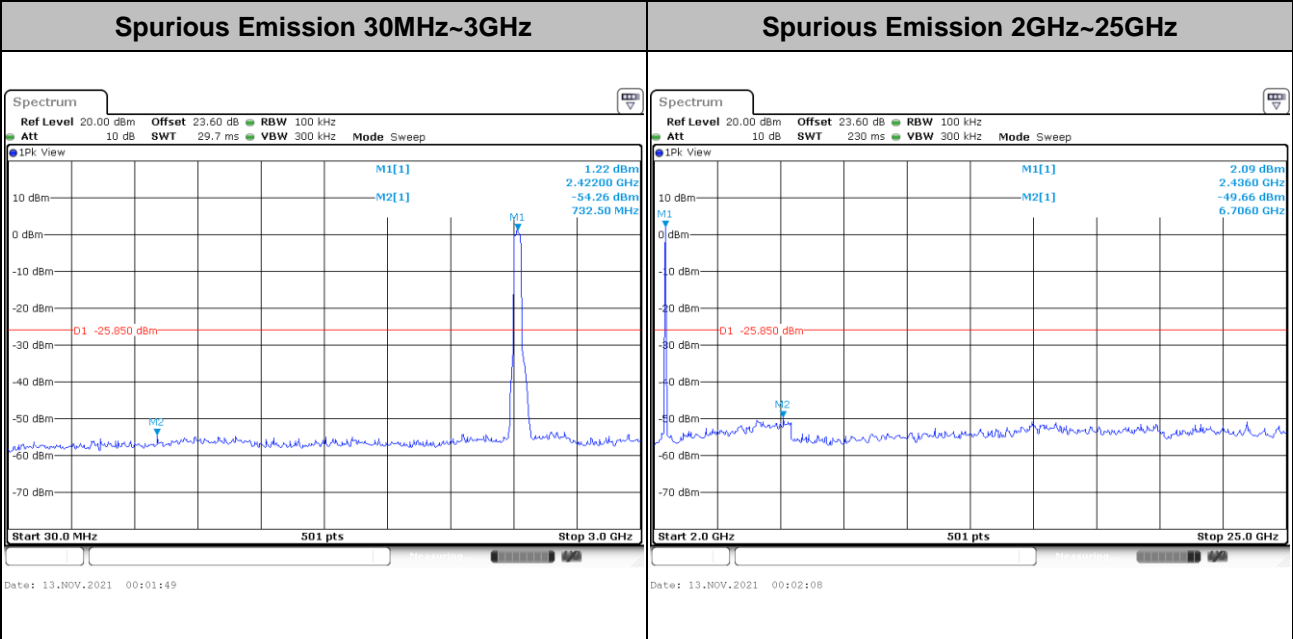
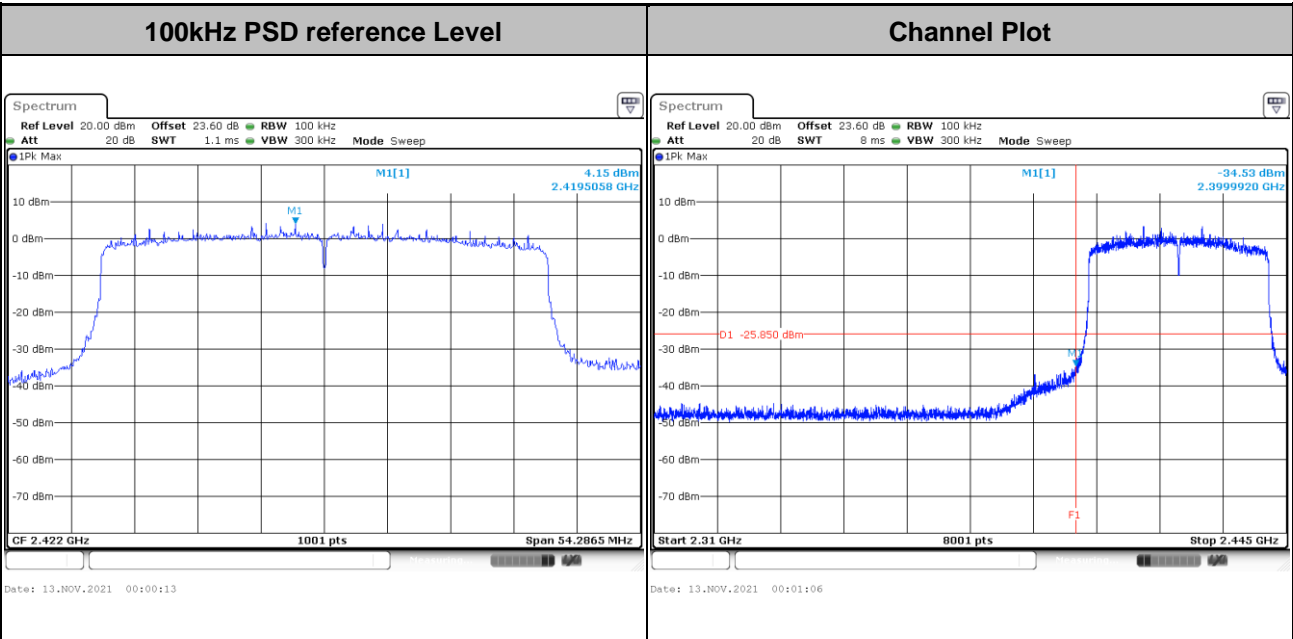



Test Mode :	802.11ax HE40	Test Channel :	06
-------------	---------------	----------------	----

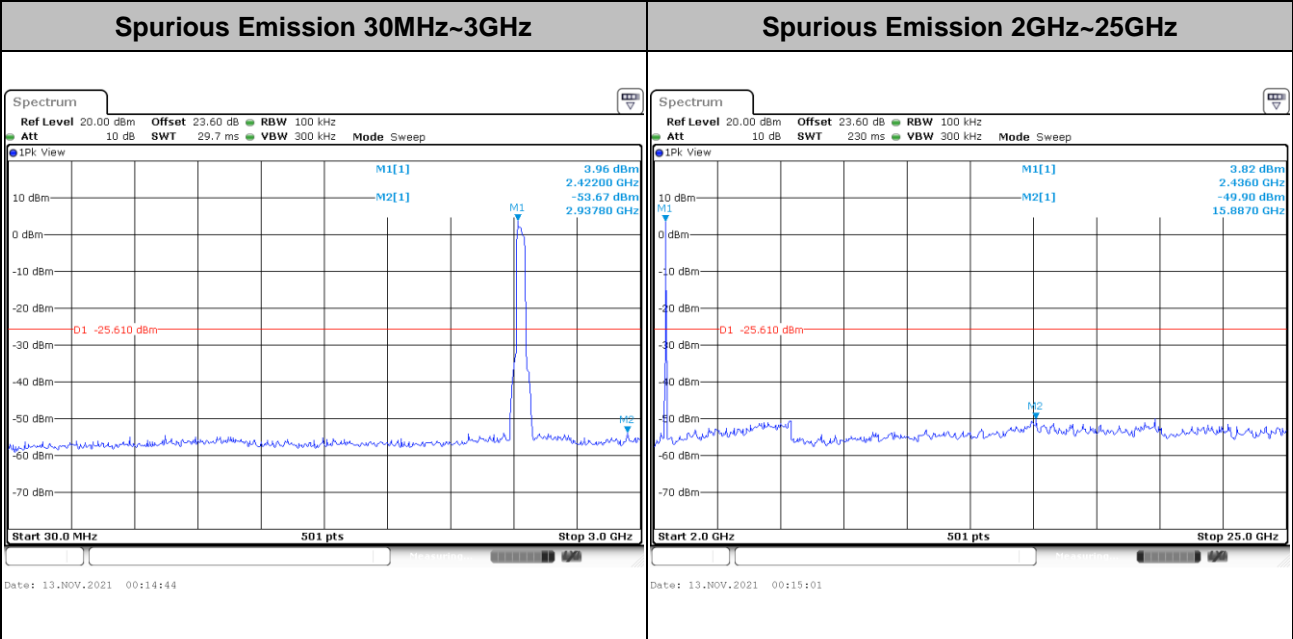
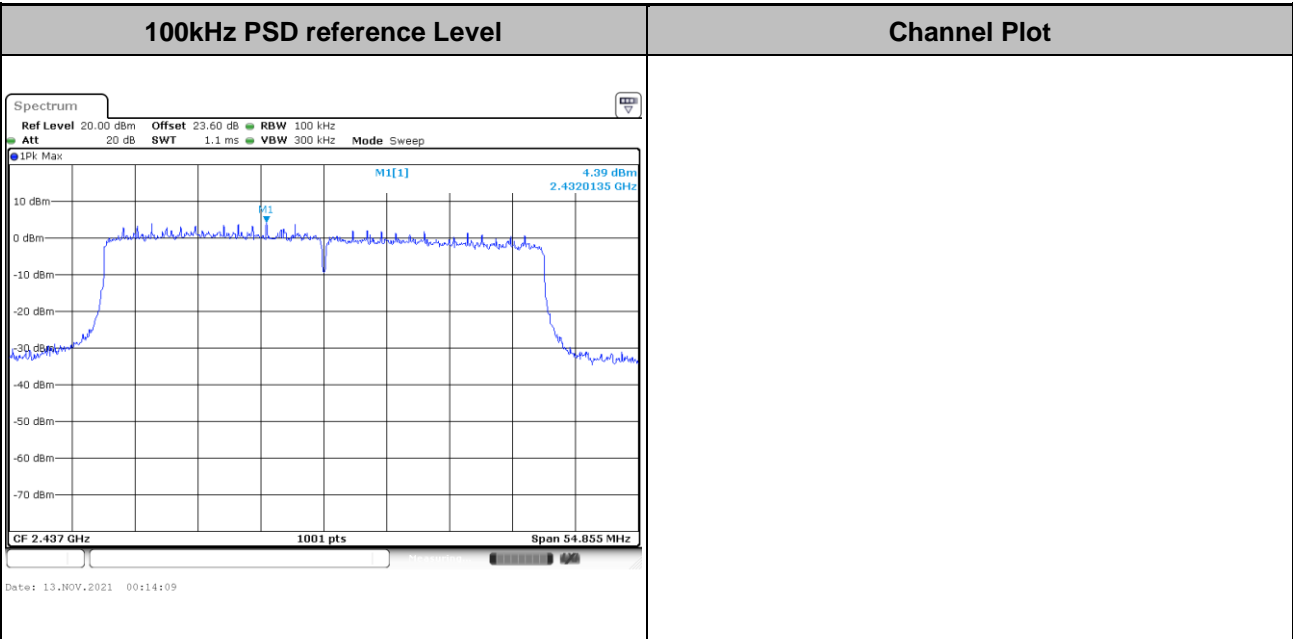



Test Mode : 802.11ax HE40 Test Channel : 09

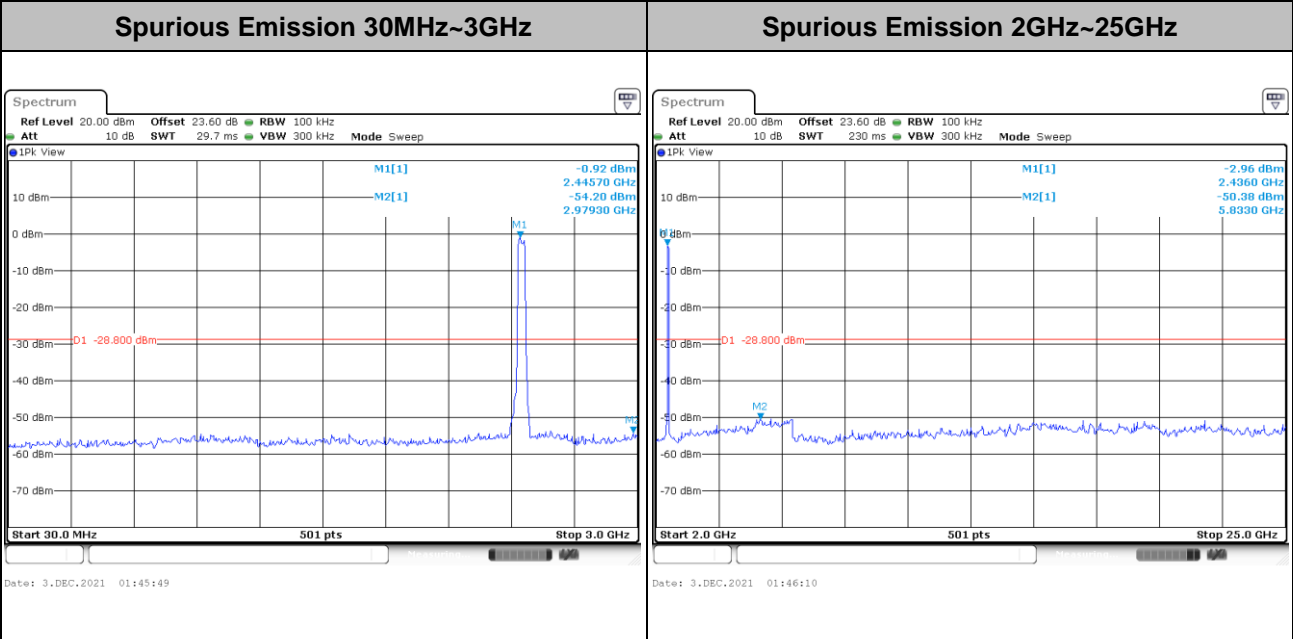
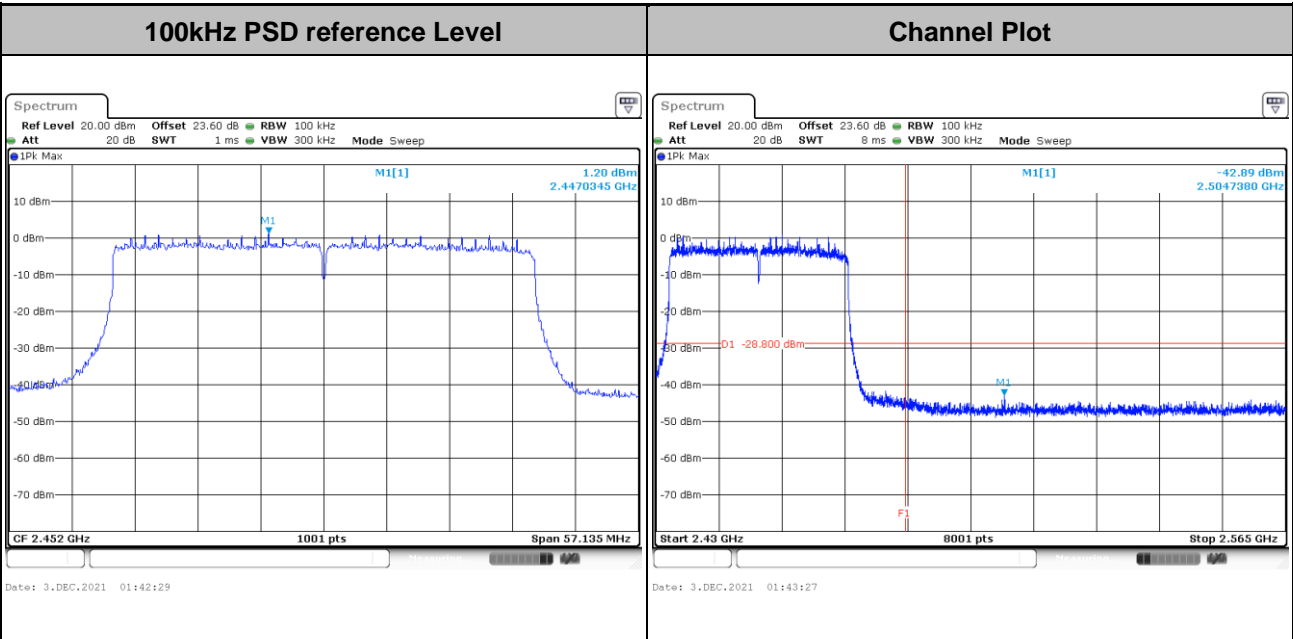



<TXBF Modes>

Number of TX = 2, Ant. 4 (Measured)

Test Mode :	802.11ax HE20	Test Channel :	01
-------------	---------------	----------------	----

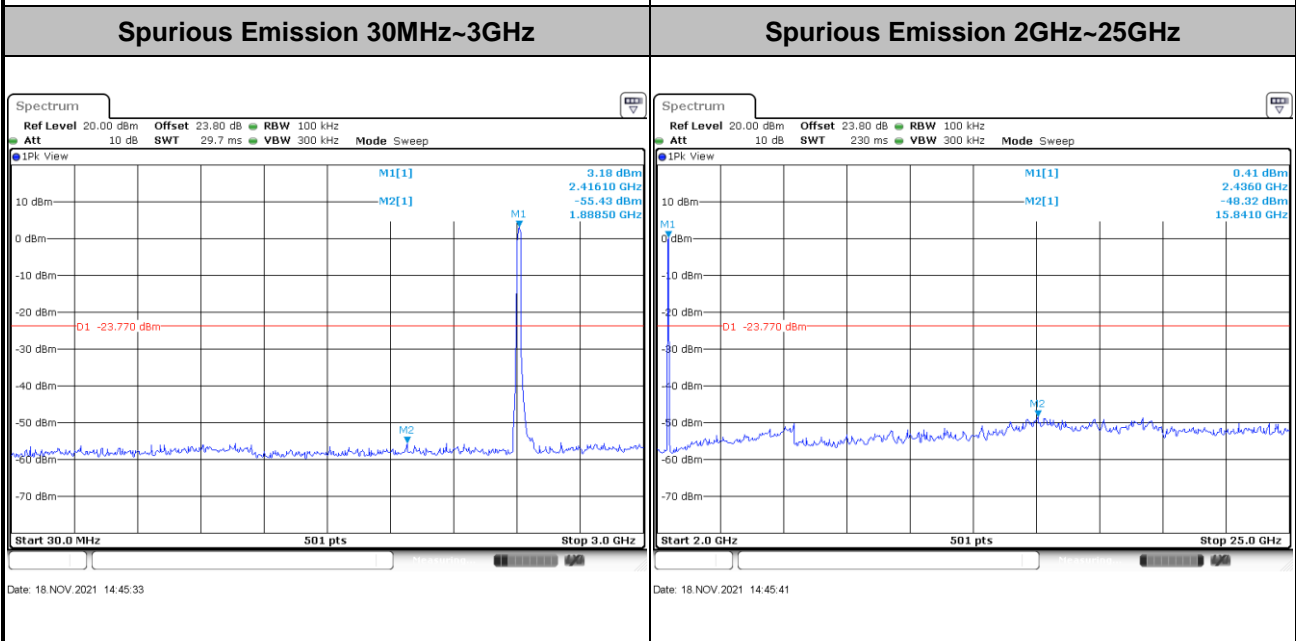
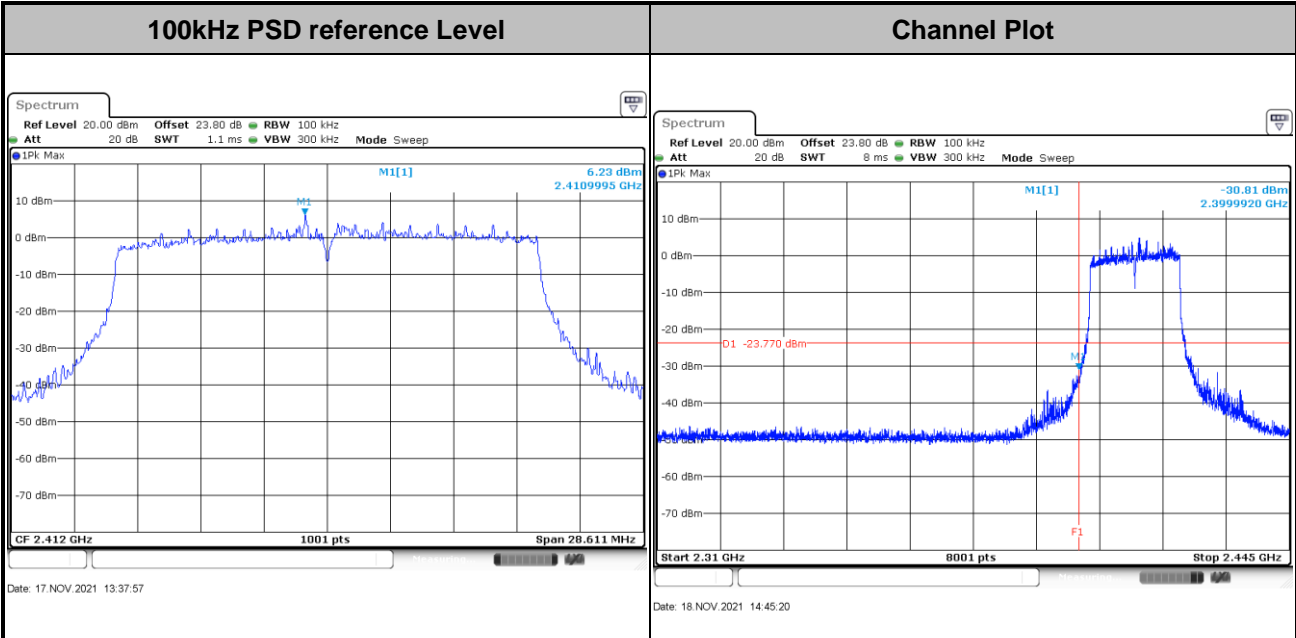



Test Mode :	802.11ax HE20	Test Channel :	06
-------------	---------------	----------------	----

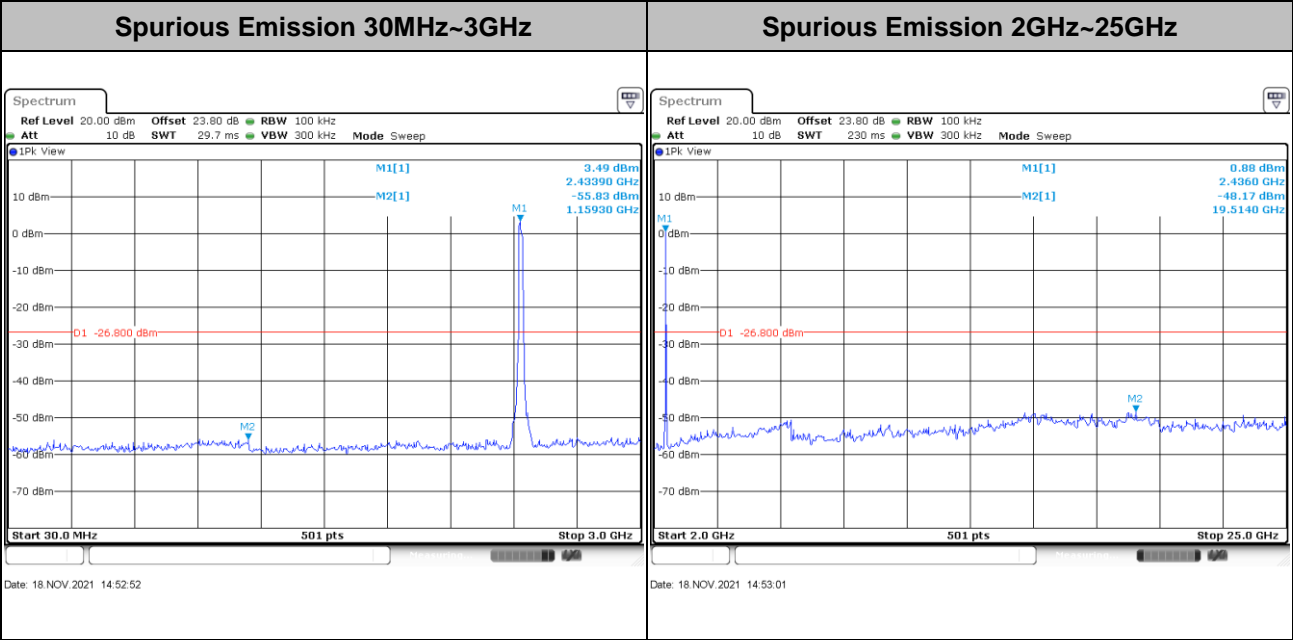
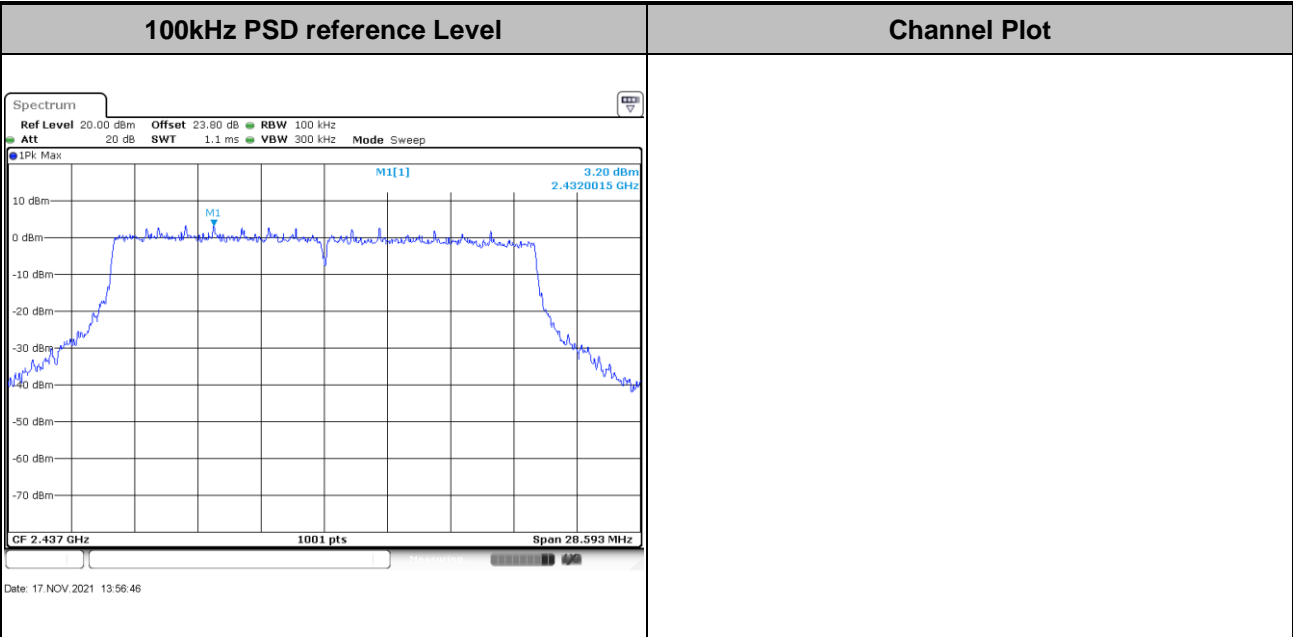



Test Mode :	802.11ax HE20	Test Channel :	11
-------------	---------------	----------------	----

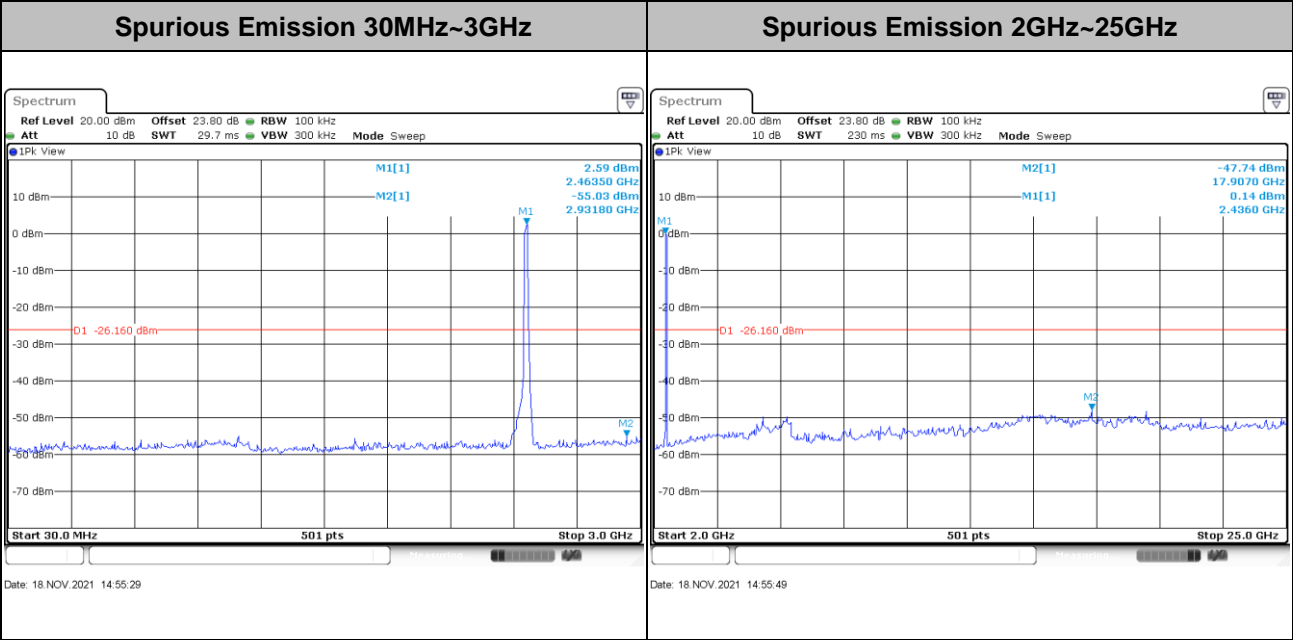
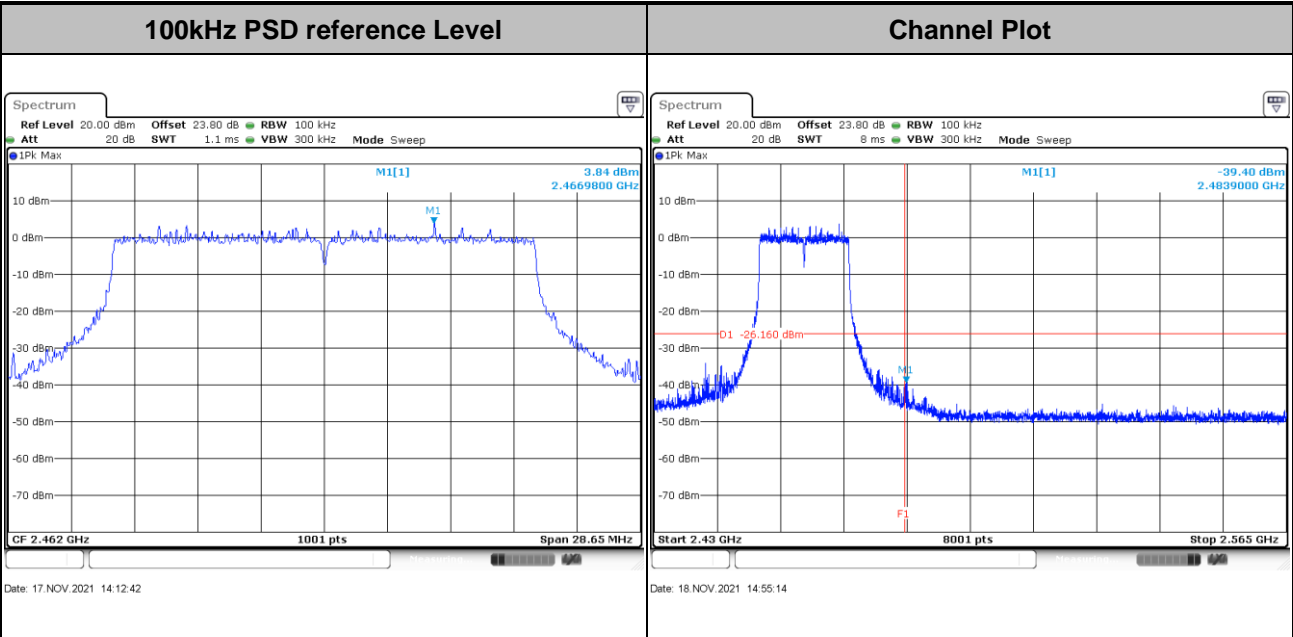



Test Mode : 802.11ax HE40 Test Channel : 01

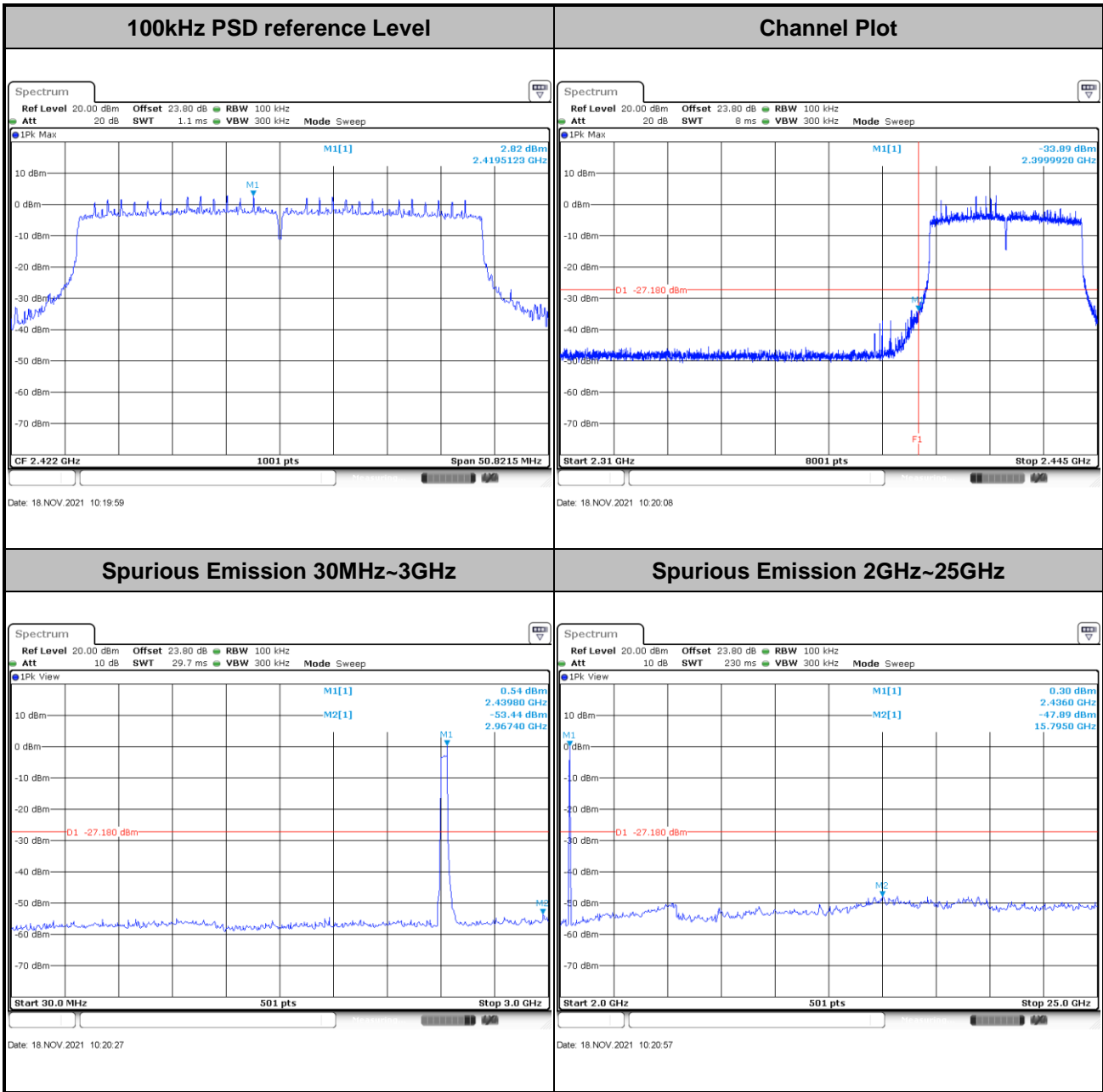



Test Mode :	802.11ax HE40	Test Channel :	06
-------------	---------------	----------------	----

