



FCC RADIO TEST REPORT

FCC ID : IHDT56AA6
Equipment : Wearable Cellular Device
Brand Name : Motorola
Model Name : XT2209-1
Applicant : Motorola Mobility, LLC
222 W Merchandise Mart Plaza, Suite
1800, Chicago, IL 60654, United States
Manufacturer : Motorola Mobility, LLC
222 W Merchandise Mart Plaza, Suite
1800, Chicago, IL 60654, United States
Standard : FCC 47 CFR Part 2, 22(H), 24(E), 27

The product was received on Oct. 19, 2021 and testing was started from Oct. 22, 2021 and completed on Nov. 30, 2021. We, Sporton International Inc. EMC & Wireless Communications Laboratory, would like to declare that the tested sample has been evaluated in accordance with the test procedures given in ANSI / TIA-603-E and has been in compliance with the applicable technical standards.

The test results in this report apply exclusively to the tested model / sample. Without written approval of Sporton International Inc. EMC & Wireless Communications Laboratory, the test report shall not be reproduced except in full.

Louis Wu

Approved by: Louis Wu

Sporton International Inc. EMC & Wireless Communications Laboratory

No. 52, Huaya 1st Rd., Guishan Dist., Taoyuan City 333, Taiwan



Table of Contents

History of this test report.....	3
Summary of Test Result.....	4
1 General Description	5
1.1 Product Feature of Equipment Under Test.....	5
1.2 Product Specification of Equipment Under Test.....	6
1.3 Modification of EUT	6
1.4 Testing Location	7
1.5 Applicable Standards.....	8
2 Test Configuration of Equipment Under Test	9
2.1 Test Mode.....	9
2.2 Connection Diagram of Test System.....	13
2.3 Support Unit used in test configuration and system	13
2.4 Measurement Results Explanation Example.....	13
2.5 Frequency List of Low/Middle/High Channels	14
3 Conducted Test Items.....	20
3.1 Measuring Instruments	20
3.2 Conducted Output Power and ERP/EIRP	21
3.3 Peak-to-Average Ratio	22
3.4 Occupied Bandwidth.....	23
3.5 Conducted Band Edge	24
3.6 Conducted Spurious Emission	26
3.7 Frequency Stability	27
4 Radiated Test Items	28
4.1 Measuring Instruments	28
4.2 Radiated Spurious Emission Measurement	30
5 List of Measuring Equipment.....	31
6 Uncertainty of Evaluation.....	33
Appendix A. Test Results of Conducted Test	
Appendix B. Test Results of Radiated Test	



History of this test report

Report No.	Version	Description	Issued Date
FG1O2008A	01	Initial issue of report	Dec. 06, 2021
FG1O2008A	02	1. Revise antenna information 2. Revise description in section 2.1	Dec. 08, 2021



Summary of Test Result

Report Clause	Ref Std. Clause	Test Items	Result (PASS/FAIL)	Remark
3.2	§2.1046	Conducted Output Power	Reporting only	-
	§22.913 (a)(5)	Effective Radiated Power (Band 5)	Pass	
	§27.50 (b)(10)	Effective Radiated Power (Band 13)		
	§24.232 (c)	Equivalent Isotropic Radiated Power (Band 2)		
	§27.50 (d)(4)	Equivalent Isotropic Radiated Power (Band 4) (Band 66)		
3.3	§24.232 (d) §27.50 (d)(5)	Peak-to-Average Ratio	Pass	-
3.4	§2.1049	Occupied Bandwidth	Reporting only	-
3.5	§2.1051 §22.917 (a) §24.238 (a) §27.53 (c)(2)(4) §27.53 (h)	Conducted Band Edge Measurement (Band 2) (Band 4) (Band 5) (Band 13) (Band 66)	Pass	-
3.6	§2.1051 §22.917 (a) §24.238 (a) §27.53 (c)(2) §27.53 (h)	Conducted Spurious Emission (Band 2) (Band 4) (Band 5) (Band 13) (Band 66)	Pass	-
3.7	§2.1055 §22.355 §24.235 §27.54	Frequency Stability Temperature & Voltage	Pass	-
4.2	§2.1053 §22.917 (a) §24.238 (a) §27.53 (c)(2) §27.53 (f) §27.53 (h)	Radiated Spurious Emission (Band 2) (Band 4) (Band 5) (Band 13) (Band 66)	Pass	Under limit 17.72 dB at 1560.000 MHz

Declaration of Conformity:
The test results with all measurement uncertainty excluded are presented in accordance with the regulation limits or requirements declared by manufacturers.

Comments and Explanations:
The declared of product specification for EUT presented in the report are provided by the manufacturer, and the manufacturer takes all the responsibilities for the accuracy of product specification.

Reviewed by: Keven Cheng
Report Producer: Vivian Hsu



1 General Description

1.1 Product Feature of Equipment Under Test

Product Feature	
Equipment	Wearable Cellular Device
Brand Name	Motorola
Model Name	XT2209-1
FCC ID	IHDT56AA6
IMEI Code	Conducted : 356636550004353 Radiation : 356636550004486
EUT supports Radios application	LTE/5G NR/GNSS WLAN 11a/b/g/n HT20/HT40 WLAN 11ac VHT20/VHT40/VHT80/VHT160 WLAN 11ax HE20/HE40/HE80/HE160 Bluetooth BR/EDR/LE
HW Version	EVT1
EUT Stage	Identical Prototype

Remark: The above EUT's information was declared by manufacturer.

Accessory List		
Battery	Brand Name :	Motorola
	Model Name :	NR70

1.2 Product Specification of Equipment Under Test

Product Specification is subject to this standard	
Tx Frequency	LTE Band 2: 1850.7 MHz ~ 1909.3 MHz LTE Band 4: 1710.7 MHz ~ 1754.3 MHz LTE Band 5: 824.7 MHz ~ 848.3 MHz LTE Band 13: 779.5 MHz ~ 784.5 MHz LTE Band 66: 1710.7 MHz ~ 1779.3 MHz
Rx Frequency	LTE Band 2: 1930.7 MHz ~ 1989.3 MHz LTE Band 4: 2110.7 MHz ~ 2154.3 MHz LTE Band 5: 869.7 MHz ~ 893.3 MHz LTE Band 13: 748.5 MHz ~ 753.5 MHz LTE Band 66: 2110.7 MHz ~ 2199.3 MHz
Bandwidth	LTE Band 2: 1.4MHz / 3MHz / 5MHz / 10MHz / 15MHz / 20MHz LTE Band 4: 1.4MHz / 3MHz / 5MHz / 10MHz / 15MHz / 20MHz LTE Band 5: 1.4MHz / 3MHz / 5MHz / 10MHz LTE Band 13: 5MHz / 10MHz LTE Band 66: 1.4MHz / 3MHz / 5MHz / 10MHz / 15MHz / 20MHz
Maximum Output Power to Antenna	LTE Band 2 : 23.34 dBm LTE Band 4 : 23.34 dBm LTE Band 5 : 23.67 dBm LTE Band 5B : 23.70dBm LTE Band 13 : 23.46 dBm LTE Band 66 : 23.46 dBm LTE Band 66B : 23.97 dBm LTE Band 66C : 23.76 dBm
Antenna Type	<Ant. 0> Fixed Internal Antenna <Ant. 1> Fixed Internal Antenna
Antenna Gain	<Ant. 0> LTE Band 2 : -3.1 dBi LTE Band 4 : -5.0 dBi LTE Band 5 : -9.0 dBi LTE Band 13 : -9.4 dBi <Aan. 1>: LTE Band 2 : -3.5 dBi LTE Band 4 : -4.7 dBi LTE Band 66 : -4.7 dBi
Type of Modulation	QPSK / 16QAM / 64QAM / 256QAM

Remark: The above EUT's information was declared by manufacturer. Please refer to Comments and Explanations in report summary.

1.3 Modification of EUT

No modifications are made to the EUT during all test items.



1.4 Testing Location

Test Site	Sporton International Inc. EMC & Wireless Communications Laboratory
Test Site Location	No. 52, Huaya 1st Rd., Guishan Dist., Taoyuan City 333, Taiwan TEL: +886-3-327-3456 FAX: +886-3-328-4978
Test Site No.	Sporton Site No.
	TH03-HY
Test Engineer	Bryant Liu
Temperature	22.8~23.2°C
Relative Humidity	53.0~56.0 %

Test Site	Sporton International Inc. Wensan Laboratory
Test Site Location	No. 58, Aly. 75, Ln. 564, Wenhua 3rd, Rd., Guishan Dist., Taoyuan City 333010, Taiwan TEL: +886-3-327-0868 FAX: +886-3-327-0855
Test Site No.	Sporton Site No.
	03CH12-HY (TAF Code: 3786)
Test Engineer	Jack Cheng, Lance Chiang and Chuan Chu
Temperature	21.2~24.2°C
Relative Humidity	58.2~68.8%
Remark	The Radiated Spurious Emission test item subcontracted to Sporton International Inc. Wensan Laboratory.

Note: The test site complies with ANSI C63.4 2014 requirement.

FCC Designation No.: TW1190 and TW3786



1.5 Applicable Standards

According to the specifications of the manufacturer, the EUT must comply with the requirements of the following standards:

- ♦ ANSI C63.26-2015
- ♦ ANSI / TIA-603-E
- ♦ FCC 47 CFR Part 2, 22(H), 24(E), 27
- ♦ FCC KDB 971168 D01 Power Meas. License Digital Systems v03r01
- ♦ FCC KDB 412172 D01 Determining ERP and EIRP v01r01
- ♦ FCC KDB 414788 D01 Radiated Test Site v01r01.

Remark:

1. All test items were verified and recorded according to the standards and without any deviation during the test.
2. This EUT has also been tested and complied with the requirements of FCC Part 15, Subpart B, recorded in a separate test report.
3. The TAF code is not including all the FCC KDB listed without accreditation.



2 Test Configuration of Equipment Under Test

2.1 Test Mode

Antenna port conducted and radiated test items listed below are performed according to KDB 971168 D01 Power Meas. License Digital Systems v03r01 with maximum output power.

The measured emission level of the EUT was maximized by rotating the EUT on a turntable, adjusting the orientation of the EUT and EUT antenna in three orthogonal axis (X: flat, Y: portrait, Z: landscape), and adjusting the measurement antenna orientation, following C63.26 exploratory test procedures and find X Plane with Adapter for LTE Band 2, 5, 13, 66, 66B, 66A+2A, 2A+4A; Y Plane with Adapter for LTE Band 5B, 66C as worst plane.

Test Items	Band	Bandwidth (MHz)						Modulation				RB #			Test Channel		
		1.4	3	5	10	15	20	QPSK	16QAM	64QAM	256QAM	1	Half	Full	L	M	H
Max. Output Power	2	v	v	v	v	v	v	v	v	v	v	v	v	v	v	v	v
	4	v	v	v	v	v	v	v	v	v	v	v	v	v	v	v	v
	5	v	v	v	v	-	-	v	v	v	v	v	v	v	v	v	v
	13	-	-	v	v	-	-	v	v	v	v	v	v	v	v	v	v
	66	v	v	v	v	v	v	v	v	v	v	v	v	v	v	v	v
Peak-to-Average Ratio	2						v	v	v	v	v			v		v	
	4	Covered by LTE Band 66															
	5				v	-	-	v	v	v	v			v		v	
	13	-	-		v	-	-	v	v	v	v			v		v	
	66						v	v	v	v	v			v		v	
26dB and 99% Bandwidth	2	v	v	v	v	v	v	v	v	v	v			v		v	
	4	Covered by LTE Band 66															
	5	v	v	v	v	-	-	v	v	v	v			v		v	
	13	-	-	v	v	-	-	v	v	v	v			v		v	
	66	v	v	v	v	v	v	v	v	v	v			v		v	
Conducted Band Edge	2	v	v	v	v	v	v	v	v	v	v	v		v	v		v
	4	Covered by LTE Band 66															
	5	v	v	v	v	-	-	v	v	v	v	v		v	v		v
	13	-	-	v	v	-	-	v	v	v	v	v		v	v		v
	66	v	v	v	v	v	v	v	v	v	v	v	v		v	v	



Test Items	Band	Bandwidth (MHz)						Modulation				RB #			Test Channel		
		1.4	3	5	10	15	20	QPSK	16QAM	64QAM	256QAM	1	Half	Full	L	M	H
Conducted Spurious Emission	2	v	v	v	v	v	v	v				v			v	v	v
	4	Covered by LTE Band 66															
	5	v	v	v	v	-	-	v				v			v	v	v
	13	-	-	v	v	-	-	v				v			v	v	v
	66	v	v	v	v	v	v	v				v			v	v	v
Frequency Stability	2				v			v						v		v	
	4	Covered by LTE Band 66															
	5				v	-	-	v						v		v	
	13	-	-		v	-	-	v						v		v	
	66				v			v						v		v	
E.R.P / E.I.R.P	2	v	v	v	v	v	v	v	v	v	v	Max. Power					
	4	v	v	v	v	v	v	v	v	v	v						
	5	v	v	v	v	-	-	v	v	v	v						
	13	-	-	v	v	-	-	v	v	v	v						
	66	v	v	v	v	v	v	v	v	v	v						
Radiated Spurious Emission	2	Worst Case													v	v	v
	4	Covered by LTE Band 66															
	5	Worst Case													v	v	v
	13	Worst Case													v	v	v
	66	Worst Case													v	v	v
Remark	<ol style="list-style-type: none"> The mark "v" means that this configuration is chosen for testing The mark "-" means that this bandwidth is not supported. The device is investigated from 30MHz to 10 times of fundamental signal for radiated spurious emission test under different RB size/offset and modulations in exploratory test. Subsequently, only the worst case emissions are reported. Wider operating range bandwidth covers narrower one when the power is higher or the same. 																



Test Items	Band	Bandwidth (MHz)					Modulation				RB #			Test Channel					
		3+5	5+3	5+10	10+5	10+10	QPSK	16QAM	64QAM	256QAM	1	Half	Full	L	M	H			
Max. Output Power	5B_CA	v	v	v	v	v	v	v	v	v	v	v	v	v	v	v	v	v	v
26dB and 99% Bandwidth	5B_CA	v	v	v	v	v	v	v	v	v			v			v			
Conducted Band Edge	5B_CA	v	v	v	v	v	v	v	v	v	v		v	v		v			v
Conducted Spurious Emission	5B_CA	v	v	v	v	v	v				v	v		v	v	v			
E.R.P.	5B_CA	v	v	v	v	v	v	v	v	v	Max. Power								
Radiated Spurious Emission	5B_CA	Worst Case											v	v	v				
Remark	1. The mark "v" means that this configuration is chosen for testing 2. The mark "-" means that this bandwidth is not supported. 3. The device is investigated from 30MHz to 10 times of fundamental signal for radiated spurious emission test under different RB size/offset and modulations in exploratory test. Subsequently, only the worst case emissions are reported.																		

Test Items	Band	Bandwidth (MHz)						Modulation				RB #			Test Channel		
		5+5	5+10	10+5	5+15	15+5	10+10	QPSK	16QAM	64QAM	256QAM	1	Half	Full	L	M	H
Max. Output Power	66B_CA	v	v	v	v	v	v	v	v	v	v	v	v	v	v	v	v
26dB and 99% Bandwidth	66B_CA	v	v	v	v	v	v	v	v	v	v			v			v
Conducted Band Edge	66B_CA	v	v	v	v	v	v	v	v	v	v	v		v	v		v
Conducted Spurious Emission	66B_CA	v	v	v	v	v	v	v				v	v		v	v	v
E.I.R.P.	66B_CA	v	v	v	v	v	v	v	v	v		Max. Power					
Radiated Spurious Emission	66B_CA	Worst Case											v	v	v		
Remark	1. The mark "v" means that this configuration is chosen for testing 2. The mark "-" means that this bandwidth is not supported. 3. The device is investigated from 30MHz to 10 times of fundamental signal for radiated spurious emission test under different RB size/offset and modulations in exploratory test. Subsequently, only the worst case emissions are reported.																



Test Items	Band	Bandwidth (MHz)										Modulation				RB #			Test Channel			
		10+15	15+10	10+20	20+10	15+15	15+20	20+15	20+5	5+20	20+20	QPSK	16QAM	64QAM	256QAM	1	Half	Full	L	M	H	
Max. Output Power	66C_CA	v	v	v	v	v	v	v	v	v	v	v	v	v	v	v	v	v	v	v	v	v
26dB and 99% Bandwidth	66C_CA	v	v	v	v	v	v	v	v	v	v	v	v	v	v	v	v	v	v	v	v	v
Conducted Band Edge	66C_CA	v	v	v	v	v	v	v	v	v	v	v	v	v	v	v	v	v	v	v	v	v
Conducted Spurious Emission	66C_CA	v	v	v	v	v	v	v	v	v	v	v	v	v	v	v	v	v	v	v	v	v
E.I.R.P.	66C_CA	v	v	v	v	v	v	v	v	v	v	v	v	v	v	v	v	Max. Power				
Radiated Spurious Emission	66C_CA	Worst Case																v	v	v		
Remark	1. The mark "v" means that this configuration is chosen for testing 2. The mark "-" means that this bandwidth is not supported. 3. The device is investigated from 30MHz to 10 times of fundamental signal for radiated spurious emission test under different RB size/offset and modulations in exploratory test. Subsequently, only the worst case emissions are reported.																					

2.2 Connection Diagram of Test System

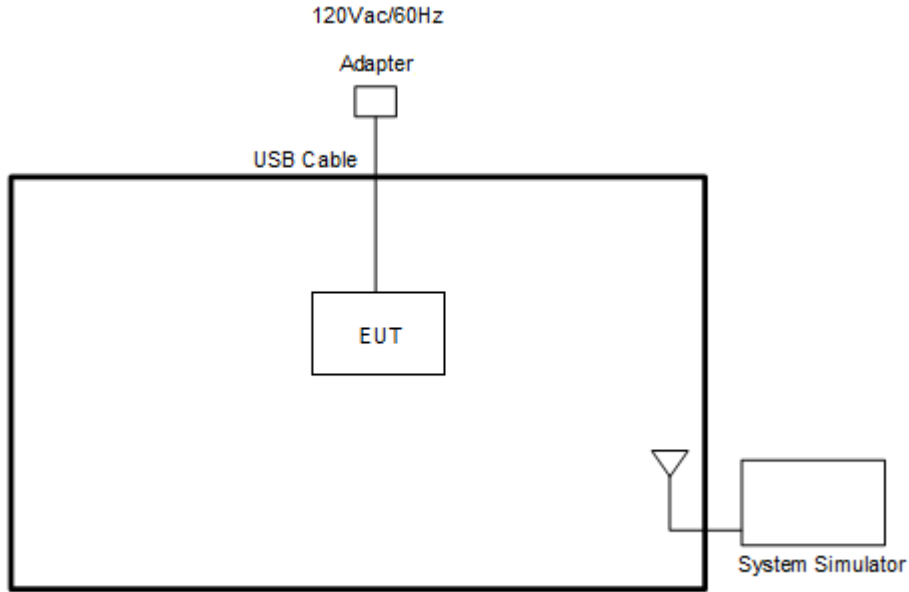

2.3 Support Unit used in test configuration and system

Item	Equipment	Brand Name	Model No.	FCC ID	Data Cable	Power Cord
1.	System Simulator	Anritsu	MT8820C	N/A	N/A	Unshielded, 1.8 m
2.	Adapter	Google	G9BR1	N/A	N/A	N/A
3.	USB Cable	Google	N/A	N/A	N/A	N/A

2.4 Measurement Results Explanation Example

For all conducted test items:

The offset level is set in the spectrum analyzer to compensate the RF cable loss and attenuator factor between EUT conducted output port and spectrum analyzer. With the offset compensation, the spectrum analyzer reading level is exactly the EUT RF output level.

The spectrum analyzer offset is derived from RF cable loss and attenuator factor.

Offset = RF cable loss + attenuator factor.

Following shows an offset computation example with cable loss 4.2 dB and 10dB attenuator.

Example :

$$\begin{aligned} \text{Offset(dB)} &= \text{RF cable loss(dB)} + \text{attenuator factor(dB)} \\ &= 4.2 + 10 = 14.2 \text{ (dB)} \end{aligned}$$



2.5 Frequency List of Low/Middle/High Channels

LTE Band 2 Channel and Frequency List				
BW [MHz]	Channel/Frequency(MHz)	Lowest	Middle	Highest
20	Channel	18700	18900	19100
	Frequency	1860	1880	1900
15	Channel	18675	18900	19125
	Frequency	1857.5	1880	1902.5
10	Channel	18650	18900	19150
	Frequency	1855	1880	1905
5	Channel	18625	18900	19175
	Frequency	1852.5	1880	1907.5
3	Channel	18615	18900	19185
	Frequency	1851.5	1880	1908.5
1.4	Channel	18607	18900	19193
	Frequency	1850.7	1880	1909.3

LTE Band 4 Channel and Frequency List				
BW [MHz]	Channel/Frequency(MHz)	Lowest	Middle	Highest
20	Channel	20050	20175	20300
	Frequency	1720	1732.5	1745
15	Channel	20025	20175	20325
	Frequency	1717.5	1732.5	1747.5
10	Channel	20000	20175	20350
	Frequency	1715	1732.5	1750
5	Channel	19975	20175	20375
	Frequency	1712.5	1732.5	1752.5
3	Channel	19965	20175	20385
	Frequency	1711.5	1732.5	1753.5
1.4	Channel	19957	20175	20393
	Frequency	1710.7	1732.5	1754.3



LTE Band 5 Channel and Frequency List				
BW [MHz]	Channel/Frequency(MHz)	Lowest	Middle	Highest
10	Channel	20450	20525	20600
	Frequency	829	836.5	844
5	Channel	20425	20525	20625
	Frequency	826.5	836.5	846.5
3	Channel	20415	20525	20635
	Frequency	825.5	836.5	847.5
1.4	Channel	20407	20525	20643
	Frequency	824.7	836.5	848.3

LTE Band 13 Channel and Frequency List				
BW [MHz]	Channel/Frequency(MHz)	Lowest	Middle	Highest
10	Channel	-	23230	-
	Frequency	-	782	-
5	Channel	23205	23230	23255
	Frequency	779.5	782	784.5

LTE Band 66 Channel and Frequency List				
BW [MHz]	Channel/Frequency(MHz)	Lowest	Middle	Highest
20	Channel	132072	132322	132572
	Frequency	1720	1745	1770
15	Channel	132047	132322	132597
	Frequency	1717.5	1745	1772.5
10	Channel	132022	132322	132622
	Frequency	1715	1745	1775
5	Channel	131997	132322	132647
	Frequency	1712.5	1745	1777.5
3	Channel	131987	132322	132657
	Frequency	1711.5	1745	1778.5
1.4	Channel	131979	132322	132665
	Frequency	1710.7	1745	1779.3



LTE Band 5B Channel and Frequency List_CA					
BW [MHz]	Channel/Frequency(MHz)		Lowest	Middle	Highest
3+5	PCC	Channel	20416	20501	20586
		Frequency	825.6	834.1	842.6
	SCC	Channel	20455	20540	20575
		Frequency	829.5	838	841.5
5+3	PCC	Channel	20425	20510	20595
		Frequency	826.5	835	843.5
	SCC	Channel	20464	20549	20634
		Frequency	830.4	838.9	847.4
5 + 10	PCC	Channel	20428	20478	20528
		Frequency	826.8	831.8	836.8
	SCC	Channel	20500	20550	20600
		Frequency	834.0	839.0	844.0
10 + 5	PCC	Channel	20450	20500	20550
		Frequency	829.0	834.0	839.0
	SCC	Channel	20522	20572	20622
		Frequency	836.2	841.2	846.2
10 + 10	PCC	Channel	20450	20476	20501
		Frequency	829.0	831.6	834.1
	SCC	Channel	20549	20575	20600
		Frequency	838.9	841.5	844.0



LTE Band 66B Channel and Frequency List_CA					
BW [MHz]	Channel/Frequency(MHz)		Lowest	Middle	Highest
5 + 5	PCC	Channel	131997	132398	132599
		Frequency	1712.5	1752.6	1772.7
	SCC	Channel	132045	133346	132647
		Frequency	1717.3	1757.4	1777.5
5 + 10	PCC	Channel	132000	132375	132550
		Frequency	1712.8	1750.3	1767.8
	SCC	Channel	132072	133347	132622
		Frequency	1720.0	1757.5	1775.0
10 + 5	PCC	Channel	132022	132397	132572
		Frequency	1715.0	1752.5	1770.0
	SCC	Channel	132094	133369	132644
		Frequency	1722.2	1759.7	1777.2
5 + 15	PCC	Channel	132002	132353	132504
		Frequency	1713.0	1748.1	1763.2
	SCC	Channel	132095	133346	132597
		Frequency	1722.3	1757.4	1772.5
15 + 5	PCC	Channel	132047	132398	132549
		Frequency	1717.5	1752.6	1767.7
	SCC	Channel	132140	133391	132642
		Frequency	1726.8	1761.9	1777.0
10 + 10	PCC	Channel	132022	132373	135523
		Frequency	1715.0	1750.1	1765.1
	SCC	Channel	132121	133372	132622
		Frequency	1724.9	1760.0	1775.0



LTE Band 66C Channel and Frequency List_CA					
BW [MHz]	Channel/Frequency(MHz)		Lowest	Middle	Highest
10 + 15	PCC	Channel	132025	132351	132477
		Frequency	1715.3	1747.9	1760.5
	SCC	Channel	132145	133371	132597
		Frequency	1727.3	1759.9	1772.5
15 + 10	PCC	Channel	132047	132373	132499
		Frequency	1717.5	1750.1	1762.7
	SCC	Channel	132167	133393	132619
		Frequency	1729.5	1761.1	1774.7
10 + 20	PCC	Channel	132027	132328	132428
		Frequency	1715.5	1745.6	1755.6
	SCC	Channel	131171	133372	132572
		Frequency	1729.9	1760.0	1770.0
20 + 10	PCC	Channel	132072	132373	132473
		Frequency	1720.0	1750.1	1760.1
	SCC	Channel	132216	133417	132617
		Frequency	1734.4	1764.5	1774.5
15 + 15	PCC	Channel	132047	132347	132447
		Frequency	1717.5	1747.5	1757.5
	SCC	Channel	132197	133397	132597
		Frequency	1732.5	1762.5	1772.5
15 + 20	PCC	Channel	132050	132325	132401
		Frequency	1717.8	1745.3	1752.9
	SCC	Channel	132221	133396	132572
		Frequency	1734.9	1762.4	1770.0
20 + 15	PCC	Channel	132072	132348	132423
		Frequency	1720.0	1747.6	1755.1
	SCC	Channel	132243	133419	132594
		Frequency	1737.1	1764.7	1772.2
20 + 5	PCC	Channel	132072	132397	132522
		Frequency	1720.0	1752.5	1765.0
	SCC	Channel	132189	133414	132639
		Frequency	1731.7	1764.2	1776.7



LTE Band 66C Channel and Frequency List_CA					
5 + 20	PCC	Channel	132005	132330	132455
		Frequency	1713.3	1745.8	1758.3
	SCC	Channel	132122	132447	132572
		Frequency	1725.0	1757.5	1770.0
20 + 20	PCC	Channel	132072	132323	132374
		Frequency	1720.0	1745.1	1750.2
	SCC	Channel	132270	133421	132572
		Frequency	1739.8	1764.9	1770.0

3 Conducted Test Items

3.1 Measuring Instruments

See list of measuring instruments of this test report.

3.1.1 Test Setup

3.1.2 Conducted Output Power

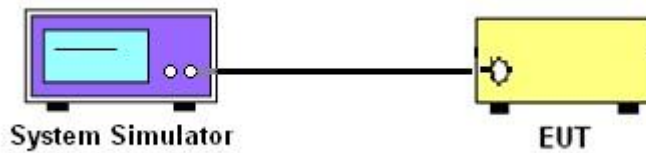

3.1.3 Peak-to-Average Ratio, Occupied Bandwidth ,Conducted Band-Edge and Conducted Spurious Emission

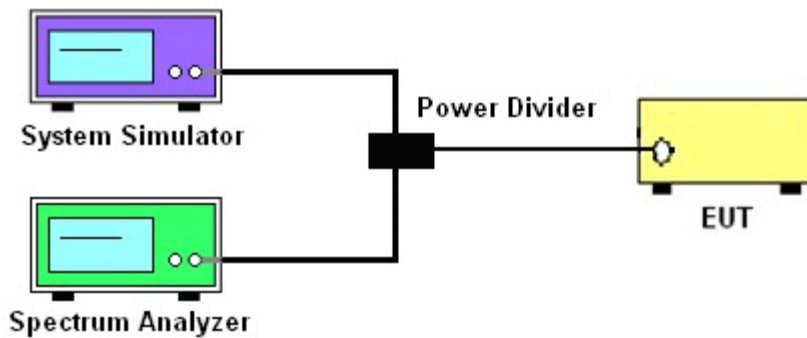

3.1.4 Frequency Stability

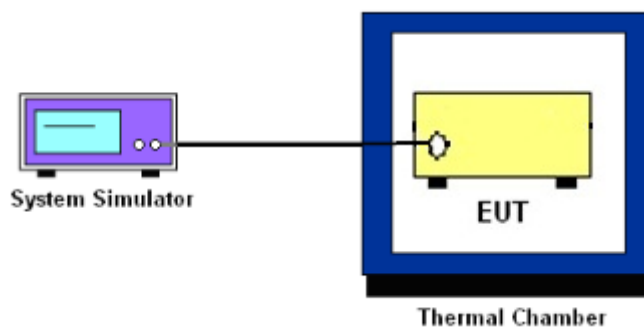

3.1.5 Test Result of Conducted Test

Please refer to Appendix A.



3.2 Conducted Output Power and ERP/EIRP

3.2.1 Description of the Conducted Output Power Measurement and ERP/EIRP Measurement

A system simulator was used to establish communication with the EUT. Its parameters were set to force the EUT transmitting at maximum output power. The measured power in the radio frequency on the transmitter output terminals shall be reported.

The ERP of mobile transmitters must not exceed 7 Watts for LTE Band 5

The ERP of mobile transmitters must not exceed 3 Watts for LTE Band 13

The EIRP of mobile transmitters must not exceed 2 Watts for LTE Band 2

The EIRP of mobile transmitters must not exceed 1 Watts for LTE Band 4 and Band 66

According to KDB 412172 D01 Power Approach,

$EIRP = P_T + G_T - L_C$, $ERP = EIRP - 2.15$, where

P_T = transmitter output power in dBm

G_T = gain of the transmitting antenna in dBi

L_C = signal attenuation in the connecting cable between the transmitter and antenna in dB

3.2.2 Test Procedures

1. The transmitter output port was connected to the system simulator.
2. Set EUT at maximum power through the system simulator.
3. Select lowest, middle, and highest channels for each band and different modulation.
4. Measure and record the power level from the system simulator.



3.3 Peak-to-Average Ratio

3.3.1 Description of the PAR Measurement

Power Complementary Cumulative Distribution Function (CCDF) curves provide a means for characterizing the power peaks of a digitally modulated signal on a statistical basis. A CCDF curve depicts the probability of the peak signal amplitude exceeding the average power level. Most contemporary measurement instrumentation include the capability to produce CCDF curves for an input signal provided that the instrument's resolution bandwidth can be set wide enough to accommodate the entire input signal bandwidth. In measuring transmissions in this band using an average power technique, the peak-to-average ratio (PAR) of the transmission may not exceed 13 dB.

3.3.2 Test Procedures

The testing follows ANSI C63.26-2015 Section 5.2.6

1. The EUT was connected to spectrum and system simulator via a power divider.
2. Set the CCDF (Complementary Cumulative Distribution Function) option in spectrum analyzer.
3. The highest RF powers were measured and recorded the maximum PAPR level associated with a probability of 0.1 %.
4. Record the deviation as Peak to Average Ratio.



3.4 Occupied Bandwidth

3.4.1 Description of Occupied Bandwidth Measurement

The occupied bandwidth is the width of a frequency band such that, below the lower and above the upper frequency limits, the mean powers emitted are each equal to a specified percentage 0.5% of the total mean transmitted power.

The 26 dB emission bandwidth is defined as the frequency range between two points, one above and one below the carrier frequency, at which the spectral density of the emission is attenuated 26 dB below the maximum in-band spectral density of the modulated signal. Spectral density (power per unit bandwidth) is to be measured with a detector of resolution bandwidth equal to approximately 1.0% of the emission bandwidth.

3.4.2 Test Procedures

The testing follows ANSI C63.26-2015 Section 5.4.3 (26dB) and Section 5.4.4 (99OB)

1. The EUT was connected to spectrum analyzer and system simulator via a power divider.
2. The spectrum analyzer center frequency is set to the nominal EUT channel center frequency. The span range for the spectrum analyzer shall be between two and five times the anticipated OBW.
3. The nominal resolution bandwidth (RBW) shall be in the range of 1 to 5 % of the anticipated OBW, and the VBW shall be at least 3 times the RBW.
4. Set the detection mode to peak, and the trace mode to max hold.
5. Determine the reference value: Set the EUT to transmit a modulated signal. Allow the trace to stabilize. Set the spectrum analyzer marker to the highest level of the displayed trace.
(this is the reference value)
6. Determine the “-26 dB down amplitude” as equal to (Reference Value – X).
7. Place two markers, one at the lowest and the other at the highest frequency of the envelope of the spectral display such that each marker is at or slightly below the “-X dB down amplitude” determined in step 6. If a marker is below this “-X dB down amplitude” value it shall be placed as close as possible to this value. The OBW is the positive frequency difference between the two markers.
8. Use the 99 % power bandwidth function of the spectrum analyzer and report the measured bandwidth.



3.5 Conducted Band Edge

3.5.1 Description of Conducted Band Edge Measurement

22.917(a)

For operations in the 824 – 849 MHz band, the FCC limit is $43 + 10\log_{10}(P[\text{Watts}])$ dB below the transmitter power $P(\text{Watts})$ in a 100kHz bandwidth. However, in the 1MHz bands immediately outside and adjacent to the licensee's frequency block, a resolution bandwidth of at least one percent of the emission bandwidth of the fundamental emission of the transmitter may be employed.

24.238 (a)

For operations in the 1850-1910 and 1930-1990 MHz band, the FCC limit is $43 + 10\log_{10}(P[\text{Watts}])$ dB below the transmitter power $P(\text{Watts})$ in a 1MHz bandwidth. However, in the 1 MHz bands immediately outside and adjacent to the frequency block a resolution bandwidth of at least one percent of the emission bandwidth of the fundamental emission of the transmitter may be employed.

27.53 (c)

For operations in the 776-788 MHz band, the FCC limit is $43 + 10\log_{10}(P[\text{Watts}])$ dB below the transmitter power $P(\text{Watts})$ in a 100 kHz bandwidth. However, in the 100 kHz bands immediately outside and adjacent to the frequency block, a resolution bandwidth of at least 30 kHz may be employed. In addition, the power of any unwanted emissions in any 6.25 kHz bandwidth for all frequencies between 763-775 MHz and 793-806 MHz shall be attenuated below the transmitter power, P (dBW), by at least $65 + 10 \log_{10} p(\text{watts})$, dB, for mobile and portable equipment.

27.53 (h)

For operations in the 1710 – 1755 MHz band, 1755-1780 MHz, the FCC limit is $43 + 10\log_{10}(P[\text{Watts}])$ dB below the transmitter power $P(\text{Watts})$ in a 1 MHz bandwidth. However, in the 1MHz bands immediately outside and adjacent to the licensee's frequency block, a resolution bandwidth of at least one percent of the emission bandwidth of the fundamental emission of the transmitter may be employed.



3.5.2 Test Procedures

The testing follows FCC KDB 971168 D01 v03r01 Section 6.1.

1. The EUT was connected to spectrum analyzer and system simulator via a power divider.
2. The band edges of low and high channels for the highest RF powers were measured.
3. Set RBW \geq 1% EBW in the 1MHz band immediately outside and adjacent to the band edge.
4. Beyond the 1 MHz band from the band edge, RBW=1MHz was used.
5. Set spectrum analyzer with RMS detector.
6. The RF fundamental frequency should be excluded against the limit line in the operating frequency band.
7. Checked that all the results comply with the emission limit line.

The limit line is derived from $43 + 10\log(P)$ dB below the transmitter power P(Watts)



3.6 Conducted Spurious Emission

3.6.1 Description of Conducted Spurious Emission Measurement

The power of any emission outside of the authorized operating frequency ranges must be lower than the transmitter power (P) by a factor of at least $43 + 10 \log (P)$ dB.

It is measured by means of a calibrated spectrum analyzer and scanned from 30 MHz up to a frequency including its 10th harmonic.

3.6.2 Test Procedures

The testing follows FCC KDB 971168 D01 v03r01 Section 6.1.

1. The EUT was connected to spectrum analyzer and system simulator via a power divider.
2. The RF output of EUT was connected to the spectrum analyzer by RF cable and attenuator. The path loss was compensated to the results for each measurement.
3. The middle channel for the highest RF power within the transmitting frequency was measured.
4. The conducted spurious emission for the whole frequency range was taken.
5. Make the measurement with the spectrum analyzer's RBW = 1MHz, VBW = 3MHz.
6. Set spectrum analyzer with RMS detector.
7. Taking the record of maximum spurious emission.
8. The RF fundamental frequency should be excluded against the limit line in the operating frequency band.
9. The limit line is derived from $43 + 10\log(P)$ dB below the transmitter power P(Watts)



3.7 Frequency Stability

3.7.1 Description of Frequency Stability Measurement

22.355

The frequency stability shall be measured by variation of ambient temperature and variation of primary supply voltage to ensure that the fundamental emission stays within the authorized frequency block. The frequency stability of the transmitter shall be maintained within $\pm 0.00025\%$ ($\pm 2.5\text{ppm}$) of the center frequency.

24.235 & 27.54

The frequency stability shall be sufficient to ensure that the fundamental emission stays within the authorized frequency block.

3.7.2 Test Procedures for Temperature Variation

The testing follows FCC KDB 971168 D01 v03r01 Section 9.0.

1. The EUT was set up in the thermal chamber and connected with the system simulator.
2. With power OFF, the temperature was decreased to -30°C and the EUT was stabilized before testing. Power was applied and the maximum change in frequency was recorded within one minute.
3. With power OFF, the temperature was raised in 10°C step up to 50°C . The EUT was stabilized at each step for at least half an hour. Power was applied and the maximum frequency change was recorded within one minute.

3.7.3 Test Procedures for Voltage Variation

The testing follows FCC KDB 971168 D01 v03r01 Section 9.0.

1. The EUT was placed in a temperature chamber at $20\pm 5^{\circ}\text{C}$ and connected with the system simulator.
2. The power supply voltage to the EUT was varied from 85% to 115% of the nominal value measured at the input to the EUT.
3. The variation in frequency was measured for the worst case.

4 Radiated Test Items

4.1 Measuring Instruments

See list of measuring instruments of this test report.

4.1.1 Test Setup

For radiated test below 30MHz



For radiated test from 30MHz to 1GHz

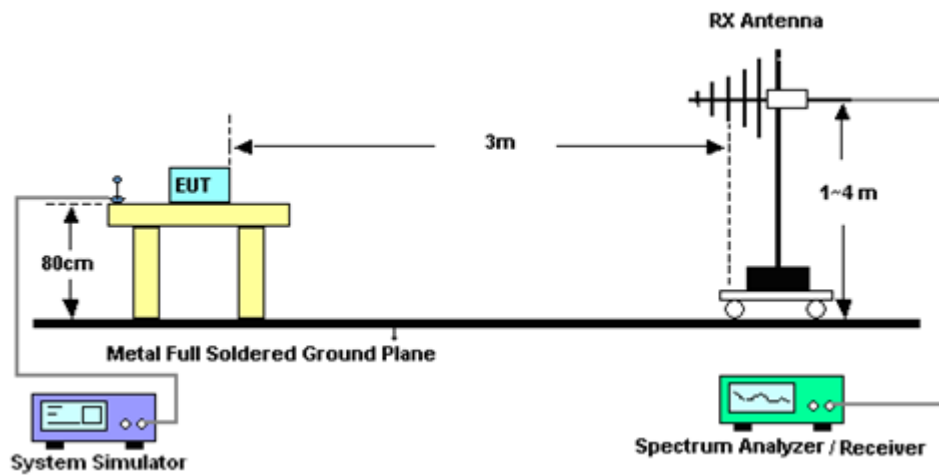

For radiated test from 1GHz to 18GHz



For radiated test above 18GHz

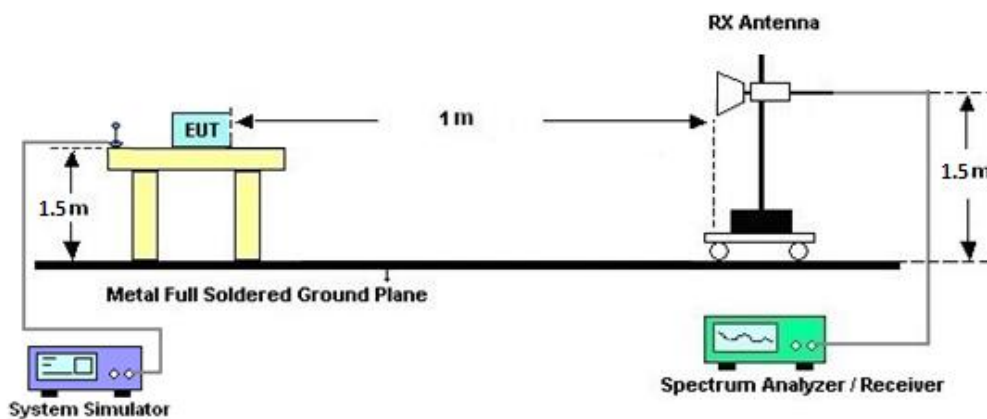

4.1.2 Test Result of Radiated Test

Please refer to Appendix B.

Note:

The low frequency, which started from 9 kHz to 30MHz, was pre-scanned and the result which was 20dB lower than the limit line was not reported.

There is adequate comparison measurement of both open-field test site and alternative test site - semi-Anechoic chamber according to 414788 D01 Radiated Test Site v01r01, and the result came out very similar.



4.2 Radiated Spurious Emission Measurement

4.2.1 Description of Radiated Spurious Emission Measurement

The radiated spurious emission was measured by substitution method according to ANSI / TIA-603-E. The power of any emission outside of the authorized operating frequency ranges must be attenuated below the transmitter power (P) by a factor of at least $43 + 10 \log (P)$ dB.

For LTE Band 13

For operations in the 746-758 MHz, 775-788 MHz, and 805-806 MHz bands, emissions in the band 1559-1610 MHz shall be limited to -70 dBW/MHz equivalent isotropically radiated power (EIRP) for wideband signals, and -80 dBW EIRP for discrete emissions of less than 700 Hz bandwidth.

The spectrum is scanned from 30 MHz up to a frequency including its 10th harmonic.

4.2.2 Test Procedures

The testing follows FCC KDB 971168 D01 v03r01 Section 7 and ANSI / TIA-603-E Section 2.2.12.

1. The EUT was placed on a turntable with 0.8 meter for frequency below 1GHz and 1.5 meter for frequency above 1GHz respectively above ground.
2. The EUT was set 3 meters from the receiving antenna, which was mounted on the antenna tower.
3. The table was rotated 360 degrees to determine the position of the highest spurious emission.
4. The height of the receiving antenna is varied between one meter and four meters to search the maximum spurious emission for both horizontal and vertical polarizations.
5. Make the measurement with the spectrum analyzer's RBW = 1MHz, VBW = 3MHz, taking the record of maximum spurious emission.
6. A horn antenna was substituted in place of the EUT and was driven by a signal generator.
7. Tune the output power of signal generator to the same emission level with EUT maximum spurious emission.
8. Taking the record of output power at antenna port.
9. Repeat step 7 to step 8 for another polarization.
10. The RF fundamental frequency should be excluded against the limit line in the operating frequency band.

The limit line is derived from $43 + 10\log(P)$ dB below the transmitter power P(Watts)

$EIRP$ (dBm) = S.G. Power – Tx Cable Loss + Tx Antenna Gain

ERP (dBm) = $EIRP - 2.15$



5 List of Measuring Equipment

Instrument	Brand Name	Model No.	Serial No.	Characteristics	Calibration Date	Test Date	Due Date	Remark
Loop Antenna	Rohde & Schwarz	HFH2-Z2	100315	9 kHz~30 MHz	Jan. 04, 2021	Nov. 06, 2021~ Nov. 30, 2021	Jan. 03, 2022	Radiation (03CH12-HY)
Bilog Antenna	TESEQ	CCBL 6111D & 00800N1D01N -06	41912 & 05	30MHz~1GHz	Feb. 08, 2021	Nov. 06, 2021~ Nov. 30, 2021	Feb. 07, 2022	Radiation (03CH12-HY)
Bilog Antenna	TESEQ	CCBL 6111D & 00800N1D01N -06	40103 & 07	30MHz~1GHz	Apr. 28, 2021	Nov. 06, 2021~ Nov. 30, 2021	Apr. 27, 2022	Radiation (03CH12-HY)
Horn Antenna	SCHWARZBE CK	BBHA 9120 D	9120D-1326	1GHz~18GHz	Oct. 25, 2021	Nov. 06, 2021~ Nov. 30, 2021	Oct. 24, 2022	Radiation (03CH12-HY)
Horn Antenna	SCHWARZBE CK	BBHA 9120 D	9120D-1212	1GHz~18GHz	May 18, 2021	Nov. 06, 2021~ Nov. 30, 2021	May 17, 2022	Radiation (03CH12-HY)
SHF-EHF Horn Antenna	SCHWARZBE CK	BBHA 9170	BBHA91705 84	18GHz~40GHz	Dec. 11, 2020	Nov. 06, 2021~ Nov. 30, 2021	Dec. 10, 2021	Radiation (03CH12-HY)
SHF-EHF Horn Antenna	SCHWARZBE CK	BBHA 9170	BBHA91705 76	18GHz~40GHz	May 21, 2021	Nov. 06, 2021~ Nov. 30, 2021	May 20, 2022	Radiation (03CH12-HY)
Preamplifier	COM-POWER	PA-103	161075	10MHz~1GHz	Mar. 24, 2021	Nov. 06, 2021~ Nov. 30, 2021	Mar. 23, 2022	Radiation (03CH12-HY)
Preamplifier	Agilent	8449B	3008A02375	1GHz~26.5GHz	May 25, 2021	Nov. 06, 2021~ Nov. 30, 2021	May 24, 2022	Radiation (03CH12-HY)
Preamplifier	JPA0118-55-30 3K	JPA0118-55-30 3K	1710001800 054002	1GHz-18GHz	Jun. 16, 2021	Nov. 06, 2021~ Nov. 30, 2021	Jun. 15, 2022	Radiation (03CH12-HY)
Preamplifier	EMEC	EM18G40G	060715	18GHz~40GHz	Dec. 11, 2020	Nov. 06, 2021~ Nov. 30, 2021	Dec. 10, 2021	Radiation (03CH12-HY)
Spectrum Analyzer	Agilent	N9010A	MY53470118	10Hz~44GHz	Jan. 15, 2021	Nov. 06, 2021~ Nov. 30, 2021	Jan. 14, 2022	Radiation (03CH12-HY)
Filter	Wainwright	WLKS1200-12 SS	SN2	1.2GHz Low Pass Filter	Mar. 17, 2021	Nov. 06, 2021~ Nov. 30, 2021	Mar. 16, 2022	Radiation (03CH12-HY)
Filter	Wainwright	WHKX12-2700 -3000-18000-6 0ST	SN2	3GHz High Pass Filter	Jul. 12, 2021	Nov. 06, 2021~ Nov. 30, 2021	Jul. 11, 2022	Radiation (03CH12-HY)
Filter	Wainwright	WHKX8-5872. 5-6750-18000- 40ST	SN2	6.75GHz High Pass Filter	Mar. 17, 2021	Nov. 06, 2021~ Nov. 30, 2021	Mar. 16, 2022	Radiation (03CH12-HY)
RF Cable	HUBER + SUHNER	SUCOFLEX 104	MY9837/4PE	9kHz~30MHz	Mar. 11, 2021	Nov. 06, 2021~ Nov. 30, 2021	Mar. 10, 2022	Radiation (03CH12-HY)
RF Cable	HUBER + SUHNER	SUCOFLEX 126E	0058/126E	30MHz~18GHz	Dec. 11, 2020	Nov. 06, 2021~ Nov. 30, 2021	Dec. 10, 2021	Radiation (03CH12-HY)
RF Cable	HUBER + SUHNER	SUCOFLEX 102	505134/2	30MHz~40GHz	Feb. 22, 2021	Nov. 06, 2021~ Nov. 30, 2021	Feb. 21, 2022	Radiation (03CH12-HY)
RF Cable	HUBER + SUHNER	SUCOFLEX 102	800740/2	30MHz~40GHz	Feb. 22, 2021	Nov. 06, 2021~ Nov. 30, 2021	Feb. 21, 2022	Radiation (03CH12-HY)
Antenna Mast	EMEC	AM-BS-4500-B	N/A	1m~4m	N/A	Nov. 06, 2021~ Nov. 30, 2021	N/A	Radiation (03CH12-HY)
Turn Table	EMEC	TT2000	N/A	0~360 Degree	N/A	Nov. 06, 2021~ Nov. 30, 2021	N/A	Radiation (03CH12-HY)
Hygrometer	TECPEL	DTM-303B	TP140349	N/A	Sep. 30, 2021	Nov. 06, 2021~ Nov. 30, 2021	Sep. 29, 2022	Radiation (03CH12-HY)
Software	Audix	E3 6.2009-8-24	RK-000989	N/A	N/A	Nov. 06, 2021~ Nov. 30, 2021	N/A	Radiation (03CH12-HY)



Instrument	Brand Name	Model No.	Serial No.	Characteristics	Calibration Date	Test Date	Due Date	Remark
Radio Communication Analyzer	Anritsu	MT8821C	6201664755	2/3/4G/LTE FDD/TDD with44)/LTE-3CC DLCA/2CC ULCA, CatM1/NB1/NB2	Jul. 21, 2021	Oct. 22, 2021~ Nov. 19, 2021	Jul. 20, 2022	Conducted (TH03-HY)
Spectrum Analyzer	Rohde & Schwarz	FSV40	101909	10Hz~40GHz	Aug. 13, 2021	Oct. 22, 2021~ Nov. 19, 2021	Aug. 12, 2022	Conducted (TH03-HY)
Thermal Chamber	ESPEC	SH-641	92013720	-40℃ ~90℃	Sep. 09, 2021	Oct. 22, 2021~ Nov. 19, 2021	Sep. 08, 2022	Conducted (TH03-HY)
Programmable Power Supply	GW Instek	PSS-2005	EL890001	1V~20V 0.5A~5A	Oct. 06, 2021	Oct. 22, 2021~ Nov. 19, 2021	Oct. 05, 2022	Conducted (TH03-HY)
Coupler	Warison	20dB 25W SMA Directional Coupler	#B	1-18GHz	Jan. 09, 2021	Oct. 22, 2021~ Nov. 19, 2021	Jan. 08, 2022	Conducted (TH03-HY)



6 Uncertainty of Evaluation

Uncertainty of Radiated Emission Measurement (30 MHz ~ 1000 MHz)

Measuring Uncertainty for a Level of Confidence of 95% ($U = 2Uc(y)$)	3.10 dB
---	---------

Uncertainty of Radiated Emission Measurement (1 GHz ~ 18 GHz)

Measuring Uncertainty for a Level of Confidence of 95% ($U = 2Uc(y)$)	3.39 dB
---	---------

Uncertainty of Radiated Emission Measurement (18 GHz ~ 40 GHz)

Measuring Uncertainty for a Level of Confidence of 95% ($U = 2Uc(y)$)	4.34 dB
---	---------



Appendix A. Test Results of Conducted Test

Conducted Output Power(Average power & ERP/EIRP)

LTE Band 2 Maximum Average Power [dBm] (GT - LC = -3.1 dB)								
BW [MHz]	RB Size	RB Offset	Mod	Lowest	Middle	Highest	EIRP (dBm)	EIRP (W)
20	1	0	QPSK	23.34	23.29	23.28	20.24	0.1057
20	1	49		23.24	23.26	23.24		
20	1	99		23.27	23.27	23.22		
20	50	0		22.21	22.26	22.19		
20	50	24		22.31	22.35	22.34		
20	50	50		22.47	22.43	22.42		
20	100	0		22.38	22.37	22.26		
20	1	0	16-QAM	22.67	22.64	22.59	19.57	0.0906
20	1	49		22.61	22.57	22.53		
20	1	99		22.40	22.44	22.42		
20	50	0		21.32	21.32	21.26		
20	50	24		21.39	21.39	21.37		
20	50	50		21.45	21.40	21.37		
20	100	0		21.43	21.39	21.36		
20	1	0	64-QAM	21.50	21.46	21.39	18.48	0.0705
20	1	49		21.58	21.56	21.45		
20	1	99		21.57	21.55	21.50		
20	50	0		20.13	20.16	20.08		
20	50	24		20.34	20.37	20.36		
20	50	50		20.36	20.34	20.24		
20	100	0		20.38	20.38	20.35		
20	1	0	256-QAM	18.06	18.29	18.12	15.19	0.0330
20	1	49		18.00	18.20	18.01		
20	1	99		17.91	18.26	18.12		
20	50	0		18.03	18.04	18.08		
20	50	24		17.92	18.01	17.94		
20	50	50		17.90	17.93	18.05		
20	100	0		17.85	18.01	17.96		
Limit	EIRP < 2W			Result			Pass	



LTE Band 2 Maximum Average Power [dBm] (GT - LC = -3.1 dB)								
BW [MHz]	RB Size	RB Offset	Mod	Lowest	Middle	Highest	EIRP (dBm)	EIRP (W)
15	1	0	QPSK	23.25	23.27	23.25	20.17	0.1040
15	1	37		23.18	23.23	23.17		
15	1	74		23.26	23.21	23.12		
15	36	0		22.19	22.23	22.19		
15	36	20		22.27	22.29	22.28		
15	36	39		22.43	22.41	22.38		
15	75	0		22.32	22.31	22.22		
15	1	0	16-QAM	22.59	22.59	22.53	19.49	0.0889
15	1	37		22.52	22.57	22.44		
15	1	74		22.40	22.35	22.41		
15	36	0		21.26	21.29	21.19		
15	36	20		21.31	21.33	21.28		
15	36	39		21.42	21.40	21.35		
15	75	0		21.41	21.37	21.31		
15	1	0	64-QAM	21.41	21.42	21.38	18.44	0.0698
15	1	37		21.54	21.47	21.38		
15	1	74		21.52	21.45	21.46		
15	36	0		20.05	20.08	20.07		
15	36	20		20.34	20.30	20.27		
15	36	39		20.36	20.29	20.20		
15	75	0		20.28	20.28	20.27		
15	1	0	256-QAM	17.98	18.21	18.09	15.11	0.0324
15	1	37		17.92	18.18	17.97		
15	1	74		17.86	18.20	18.04		
15	36	0		17.99	17.98	18.02		
15	36	20		17.84	18.00	17.84		
15	36	39		17.88	17.90	18.00		
15	75	0		17.82	17.95	17.86		
Limit	EIRP < 2W			Result			Pass	



LTE Band 2 Maximum Average Power [dBm] (GT - LC = -3.1 dB)								
BW [MHz]	RB Size	RB Offset	Mod	Lowest	Middle	Highest	EIRP (dBm)	EIRP (W)
10	1	0	QPSK	23.26	23.26	23.28	20.18	0.1042
10	1	25		23.17	23.22	23.21		
10	1	49		23.21	23.18	23.14		
10	25	0		22.13	22.22	22.13		
10	25	12		22.25	22.34	22.26		
10	25	25		22.46	22.40	22.36		
10	50	0		22.33	22.29	22.19		
10	1	0	16-QAM	22.58	22.60	22.50	19.50	0.0891
10	1	25		22.51	22.51	22.48		
10	1	49		22.32	22.41	22.38		
10	25	0		21.29	21.27	21.22		
10	25	12		21.34	21.29	21.35		
10	25	25		21.37	21.38	21.36		
10	50	0		21.42	21.32	21.31		
10	1	0	64-QAM	21.41	21.44	21.33	18.47	0.0703
10	1	25		21.57	21.50	21.35		
10	1	49		21.49	21.45	21.47		
10	25	0		20.13	20.07	20.07		
10	25	12		20.25	20.34	20.26		
10	25	25		20.29	20.27	20.20		
10	50	0		20.29	20.29	20.33		
10	1	0	256-QAM	18.05	18.26	18.08	15.16	0.0328
10	1	25		17.93	18.14	17.99		
10	1	49		17.81	18.16	18.06		
10	25	0		18.02	17.99	18.07		
10	25	12		17.83	17.95	17.90		
10	25	25		17.89	17.91	18.04		
10	50	0		17.84	17.91	17.89		
Limit	EIRP < 2W			Result			Pass	



LTE Band 2 Maximum Average Power [dBm] (GT - LC = -3.1 dB)								
BW [MHz]	RB Size	RB Offset	Mod	Lowest	Middle	Highest	EIRP (dBm)	EIRP (W)
5	1	0	QPSK	23.33	23.23	23.26	20.23	0.1054
5	1	12		23.19	23.23	23.19		
5	1	24		23.18	23.17	23.21		
5	12	0		22.11	22.20	22.14		
5	12	7		22.21	22.26	22.32		
5	12	13		22.37	22.40	22.38		
5	25	0		22.29	22.31	22.17		
5	1	0	16-QAM	22.64	22.58	22.57	19.54	0.0899
5	1	12		22.58	22.56	22.50		
5	1	24		22.37	22.43	22.39		
5	12	0		21.25	21.27	21.22		
5	12	7		21.34	21.35	21.35		
5	12	13		21.40	21.37	21.37		
5	25	0		21.35	21.34	21.32		
5	1	0	64-QAM	21.49	21.39	21.39	18.47	0.0703
5	1	12		21.52	21.48	21.45		
5	1	24		21.57	21.55	21.46		
5	12	0		20.05	20.16	20.03		
5	12	7		20.32	20.32	20.32		
5	12	13		20.30	20.31	20.23		
5	25	0		20.28	20.35	20.25		
5	1	0	256-QAM	18.04	18.22	18.02	15.12	0.0325
5	1	12		17.92	18.10	17.96		
5	1	24		17.87	18.20	18.07		
5	12	0		18.03	18.01	18.02		
5	12	7		17.83	18.01	17.84		
5	12	13		17.83	17.83	17.95		
5	25	0		17.80	17.99	17.88		
Limit	EIRP < 2W			Result			Pass	



LTE Band 2 Maximum Average Power [dBm] (GT - LC = -3.1 dB)								
BW [MHz]	RB Size	RB Offset	Mod	Lowest	Middle	Highest	EIRP (dBm)	EIRP (W)
3	1	0	QPSK	23.32	23.27	23.24	20.22	0.1052
3	1	8		23.16	23.17	23.23		
3	1	14		23.17	23.24	23.13		
3	8	0		22.14	22.25	22.12		
3	8	4		22.26	22.34	22.30		
3	8	7		22.45	22.33	22.34		
3	15	0		22.33	22.33	22.23		
3	1	0	16-QAM	22.64	22.57	22.50	19.54	0.0899
3	1	8		22.57	22.56	22.50		
3	1	14		22.35	22.37	22.42		
3	8	0		21.30	21.32	21.23		
3	8	4		21.38	21.35	21.30		
3	8	7		21.42	21.31	21.28		
3	15	0		21.42	21.39	21.30		
3	1	0	64-QAM	21.42	21.42	21.31	18.45	0.0700
3	1	8		21.55	21.46	21.42		
3	1	14		21.48	21.47	21.42		
3	8	0		20.04	20.13	20.08		
3	8	4		20.28	20.34	20.30		
3	8	7		20.31	20.31	20.14		
3	15	0		20.31	20.38	20.28		
3	1	0	256-QAM	17.97	18.19	18.02	15.15	0.0327
3	1	8		17.91	18.10	17.95		
3	1	14		17.82	18.25	18.04		
3	8	0		17.93	17.97	17.99		
3	8	4		17.91	18.00	17.92		
3	8	7		17.85	17.84	17.97		
3	15	0		17.84	18.00	17.92		
Limit	EIRP < 2W			Result			Pass	



LTE Band 2 Maximum Average Power [dBm] (GT - LC = -3.1 dB)								
BW [MHz]	RB Size	RB Offset	Mod	Lowest	Middle	Highest	EIRP (dBm)	EIRP (W)
1.4	1	0	QPSK	23.26	23.26	23.25	20.17	0.1040
1.4	1	3		23.19	23.23	23.16		
1.4	1	5		23.21	23.19	23.19		
1.4	3	0		23.24	23.19	23.22		
1.4	3	1		23.14	23.20	23.19		
1.4	3	3		23.27	23.21	23.19		
1.4	6	0		22.13	22.23	22.16		
1.4	1	0	16-QAM	22.63	22.58	22.54	19.53	0.0897
1.4	1	3		22.53	22.50	22.51		
1.4	1	5		22.40	22.44	22.37		
1.4	3	0		22.58	22.54	22.58		
1.4	3	1		22.58	22.53	22.46		
1.4	3	3		22.37	22.40	22.41		
1.4	6	0		21.32	21.22	21.24		
1.4	1	0	64-QAM	21.46	21.42	21.32	18.47	0.0703
1.4	1	3		21.57	21.48	21.44		
1.4	1	5		21.49	21.50	21.49		
1.4	3	0		21.44	21.39	21.29		
1.4	3	1		21.52	21.46	21.42		
1.4	3	3		21.47	21.54	21.46		
1.4	6	0		20.11	20.12	20.08		
1.4	1	0	256-QAM	18.02	18.23	18.03	15.14	0.0327
1.4	1	3		17.93	18.17	17.96		
1.4	1	5		17.87	18.24	18.08		
1.4	3	0		17.98	17.96	18.07		
1.4	3	1		17.87	18.01	17.85		
1.4	3	3		17.85	17.92	17.96		
1.4	6	0		17.77	18.00	17.89		
Limit	EIRP < 2W			Result			Pass	



LTE Band 4 Maximum Average Power [dBm] (GT - LC = -4.7 dB)								
BW [MHz]	RB Size	RB Offset	Mod	Lowest	Middle	Highest	EIRP (dBm)	EIRP (W)
20	1	0	QPSK	23.34	23.29	23.27	18.64	0.0731
20	1	49		23.29	23.33	23.24		
20	1	99		23.30	23.28	23.17		
20	50	0		22.34	22.34	22.31		
20	50	24		22.38	22.35	22.31		
20	50	50		22.26	22.27	22.18		
20	100	0		22.37	22.32	22.28		
20	1	0	16-QAM	22.70	22.70	22.63	18.00	0.0631
20	1	49		22.60	22.60	22.54		
20	1	99		22.55	22.51	22.48		
20	50	0		21.31	21.35	21.32		
20	50	24		21.39	21.37	21.30		
20	50	50		21.36	21.32	21.26		
20	100	0		21.37	21.35	21.31		
20	1	0	64-QAM	21.69	21.64	21.62	16.99	0.0500
20	1	49		21.53	21.53	21.47		
20	1	99		21.41	21.38	21.26		
20	50	0		20.44	20.40	20.29		
20	50	24		20.34	20.36	20.25		
20	50	50		20.36	20.32	20.23		
20	100	0		20.36	20.35	20.26		
20	1	0	256-QAM	18.13	18.28	18.27	13.58	0.0228
20	1	49		18.03	18.24	18.18		
20	1	99		18.10	18.12	18.15		
20	50	0		18.02	18.04	18.04		
20	50	24		17.83	17.93	17.95		
20	50	50		18.01	17.89	17.86		
20	100	0		18.00	17.97	17.91		
Limit	EIRP < 1W			Result			Pass	



LTE Band 4 Maximum Average Power [dBm] (GT - LC = -4.7 dB)								
BW [MHz]	RB Size	RB Offset	Mod	Lowest	Middle	Highest	EIRP (dBm)	EIRP (W)
15	1	0	QPSK	23.28	23.26	23.19	18.62	0.0728
15	1	37		23.20	23.32	23.22		
15	1	74		23.25	23.22	23.08		
15	36	0		22.28	22.32	22.29		
15	36	20		22.28	22.31	22.28		
15	36	39		22.25	22.22	22.10		
15	75	0		22.35	22.23	22.25		
15	1	0	16-QAM	22.60	22.62	22.59	17.92	0.0619
15	1	37		22.53	22.57	22.44		
15	1	74		22.47	22.48	22.38		
15	36	0		21.24	21.35	21.25		
15	36	20		21.37	21.27	21.23		
15	36	39		21.35	21.24	21.19		
15	75	0		21.29	21.31	21.23		
15	1	0	64-QAM	21.60	21.63	21.52	16.93	0.0493
15	1	37		21.43	21.49	21.42		
15	1	74		21.32	21.31	21.17		
15	36	0		20.42	20.34	20.20		
15	36	20		20.31	20.28	20.15		
15	36	39		20.30	20.31	20.15		
15	75	0		20.35	20.34	20.25		
15	1	0	256-QAM	18.04	18.26	18.23	13.56	0.0227
15	1	37		17.98	18.23	18.10		
15	1	74		18.09	18.07	18.13		
15	36	0		17.95	17.97	18.04		
15	36	20		17.76	17.92	17.92		
15	36	39		17.95	17.86	17.80		
15	75	0		17.91	17.87	17.86		
Limit	EIRP < 1W			Result			Pass	



LTE Band 4 Maximum Average Power [dBm] (GT - LC = -4.7 dB)								
BW [MHz]	RB Size	RB Offset	Mod	Lowest	Middle	Highest	EIRP (dBm)	EIRP (W)
10	1	0	QPSK	23.31	23.25	23.24	18.61	0.0726
10	1	25		23.27	23.28	23.23		
10	1	49		23.28	23.22	23.10		
10	25	0		22.30	22.31	22.22		
10	25	12		22.26	22.26	22.27		
10	25	25		22.24	22.19	22.14		
10	50	0		22.37	22.27	22.23		
10	1	0	16-QAM	22.70	22.65	22.54	18.00	0.0631
10	1	25		22.52	22.50	22.45		
10	1	49		22.52	22.45	22.47		
10	25	0		21.23	21.29	21.25		
10	25	12		21.39	21.33	21.28		
10	25	25		21.33	21.32	21.19		
10	50	0		21.28	21.31	21.29		
10	1	0	64-QAM	21.64	21.58	21.52	16.94	0.0494
10	1	25		21.49	21.52	21.40		
10	1	49		21.31	21.34	21.20		
10	25	0		20.43	20.31	20.19		
10	25	12		20.31	20.26	20.21		
10	25	25		20.33	20.23	20.21		
10	50	0		20.27	20.31	20.17		
10	1	0	256-QAM	18.08	18.24	18.18	13.54	0.0226
10	1	25		18.02	18.16	18.11		
10	1	49		18.02	18.11	18.14		
10	25	0		18.02	17.95	17.98		
10	25	12		17.78	17.87	17.92		
10	25	25		17.97	17.80	17.79		
10	50	0		17.97	17.95	17.87		
Limit	EIRP < 1W			Result			Pass	



LTE Band 4 Maximum Average Power [dBm] (GT - LC = -4.7 dB)								
BW [MHz]	RB Size	RB Offset	Mod	Lowest	Middle	Highest	EIRP (dBm)	EIRP (W)
5	1	0	QPSK	23.33	23.26	23.27	18.63	0.0729
5	1	12		23.21	23.25	23.17		
5	1	24		23.26	23.25	23.09		
5	12	0		22.34	22.33	22.29		
5	12	7		22.34	22.31	22.24		
5	12	13		22.24	22.19	22.11		
5	25	0		22.31	22.22	22.18		
5	1	0	16-QAM	22.67	22.64	22.58	17.97	0.0627
5	1	12		22.56	22.59	22.46		
5	1	24		22.53	22.46	22.44		
5	12	0		21.25	21.27	21.30		
5	12	7		21.30	21.37	21.25		
5	12	13		21.29	21.24	21.21		
5	25	0		21.37	21.35	21.22		
5	1	0	64-QAM	21.60	21.62	21.62	16.92	0.0492
5	1	12		21.48	21.43	21.47		
5	1	24		21.38	21.33	21.26		
5	12	0		20.37	20.39	20.24		
5	12	7		20.29	20.33	20.18		
5	12	13		20.31	20.28	20.16		
5	25	0		20.27	20.29	20.25		
5	1	0	256-QAM	18.05	18.27	18.22	13.57	0.0228
5	1	12		17.97	18.18	18.13		
5	1	24		18.07	18.07	18.05		
5	12	0		17.94	18.00	17.99		
5	12	7		17.76	17.88	17.85		
5	12	13		17.92	17.88	17.78		
5	25	0		17.97	17.97	17.90		
Limit	EIRP < 1W			Result			Pass	



LTE Band 4 Maximum Average Power [dBm] (GT - LC = -4.7 dB)								
BW [MHz]	RB Size	RB Offset	Mod	Lowest	Middle	Highest	EIRP (dBm)	EIRP (W)
3	1	0	QPSK	23.26	23.19	23.27	18.59	0.0723
3	1	8		23.29	23.26	23.22		
3	1	14		23.23	23.23	23.13		
3	8	0		22.32	22.33	22.22		
3	8	4		22.29	22.33	22.26		
3	8	7		22.18	22.17	22.13		
3	15	0		22.34	22.29	22.18		
3	1	0	16-QAM	22.70	22.66	22.58	18.00	0.0631
3	1	8		22.59	22.52	22.50		
3	1	14		22.52	22.50	22.46		
3	8	0		21.24	21.32	21.22		
3	8	4		21.30	21.32	21.28		
3	8	7		21.29	21.30	21.24		
3	15	0		21.29	21.33	21.24		
3	1	0	64-QAM	21.65	21.63	21.53	16.95	0.0495
3	1	8		21.52	21.47	21.42		
3	1	14		21.35	21.35	21.16		
3	8	0		20.39	20.40	20.27		
3	8	4		20.32	20.34	20.21		
3	8	7		20.31	20.29	20.21		
3	15	0		20.31	20.34	20.22		
3	1	0	256-QAM	18.13	18.27	18.19	13.57	0.0228
3	1	8		17.98	18.24	18.10		
3	1	14		18.08	18.11	18.06		
3	8	0		17.98	18.00	18.01		
3	8	4		17.79	17.84	17.93		
3	8	7		17.96	17.84	17.81		
3	15	0		17.99	17.90	17.83		
Limit	EIRP < 1W			Result			Pass	



LTE Band 4 Maximum Average Power [dBm] (GT - LC = -4.7 dB)								
BW [MHz]	RB Size	RB Offset	Mod	Lowest	Middle	Highest	EIRP (dBm)	EIRP (W)
1.4	1	0	QPSK	23.25	23.23	23.26	18.63	0.0729
1.4	1	3		23.28	23.23	23.14		
1.4	1	5		23.24	23.26	23.10		
1.4	3	0		23.30	23.28	23.23		
1.4	3	1		23.25	23.33	23.14		
1.4	3	3		23.27	23.18	23.08		
1.4	6	0		22.29	22.24	22.24		
1.4	1	0	16-QAM	22.69	22.70	22.55	18.00	0.0631
1.4	1	3		22.60	22.55	22.49		
1.4	1	5		22.49	22.50	22.41		
1.4	3	0		22.65	22.65	22.62		
1.4	3	1		22.50	22.52	22.48		
1.4	3	3		22.50	22.48	22.45		
1.4	6	0		21.26	21.25	21.23		
1.4	1	0	64-QAM	21.62	21.55	21.54	16.93	0.0493
1.4	1	3		21.47	21.51	21.41		
1.4	1	5		21.38	21.29	21.23		
1.4	3	0		21.63	21.55	21.56		
1.4	3	1		21.48	21.44	21.41		
1.4	3	3		21.38	21.34	21.18		
1.4	6	0		20.38	20.33	20.21		
1.4	1	0	256-QAM	18.03	18.20	18.21	13.51	0.0224
1.4	1	3		17.96	18.17	18.18		
1.4	1	5		18.10	18.09	18.05		
1.4	3	0		18.00	18.00	18.04		
1.4	3	1		17.74	17.90	17.87		
1.4	3	3		18.00	17.85	17.86		
1.4	6	0		18.00	17.97	17.90		
Limit	EIRP < 1W			Result			Pass	



LTE Band 5 Maximum Average Power [dBm] (GT - LC = -9 dB)								
BW [MHz]	RB Size	RB Offset	Mod	Lowest	Middle	Highest	ERP (dBm)	ERP (W)
10	1	0	QPSK	23.50	23.49	23.67	12.52	0.0179
10	1	25		23.60	23.62	23.63		
10	1	49		23.65	23.64	23.65		
10	25	0		22.55	22.62	22.79		
10	25	12		22.62	22.67	22.78		
10	25	25		22.69	22.75	22.87		
10	50	0		22.59	22.64	22.77		
10	1	0	16-QAM	22.84	22.85	22.96	11.85	0.0153
10	1	25		22.98	23.00	22.97		
10	1	49		22.96	22.97	22.95		
10	25	0		21.62	21.61	21.78		
10	25	12		21.68	21.70	21.88		
10	25	25		21.75	21.75	21.92		
10	50	0		21.62	21.64	21.76		
10	1	0	64-QAM	21.68	21.76	21.86	10.82	0.0121
10	1	25		21.95	21.97	21.96		
10	1	49		21.88	21.96	21.95		
10	25	0		20.71	20.72	20.81		
10	25	12		20.72	20.75	20.93		
10	25	25		20.86	20.85	20.95		
10	50	0		20.71	20.75	20.84		
10	1	0	256-QAM	18.82	18.80	18.96	7.81	0.0060
10	1	25		18.63	18.65	18.77		
10	1	49		18.82	18.76	18.86		
10	25	0		18.76	18.72	18.77		
10	25	12		18.67	18.72	18.66		
10	25	25		18.62	18.53	18.60		
10	50	0		18.59	18.66	18.74		
Limit	ERP < 7W			Result			Pass	



LTE Band 5 Maximum Average Power [dBm] (GT - LC = -9 dB)								
BW [MHz]	RB Size	RB Offset	Mod	Lowest	Middle	Highest	ERP (dBm)	ERP (W)
5	1	0	QPSK	23.47	23.42	23.66	12.51	0.0178
5	1	12		23.50	23.57	23.57		
5	1	24		23.63	23.55	23.63		
5	12	0		22.52	22.59	22.79		
5	12	7		22.61	22.60	22.74		
5	12	13		22.63	22.71	22.79		
5	25	0		22.54	22.58	22.73		
5	1	0	16-QAM	22.75	22.81	22.92	11.80	0.0151
5	1	12		22.88	22.91	22.95		
5	1	24		22.92	22.89	22.87		
5	12	0		21.52	21.54	21.77		
5	12	7		21.60	21.62	21.79		
5	12	13		21.70	21.73	21.92		
5	25	0		21.60	21.54	21.76		
5	1	0	64-QAM	21.61	21.69	21.78	10.81	0.0121
5	1	12		21.92	21.91	21.96		
5	1	24		21.83	21.94	21.95		
5	12	0		20.64	20.70	20.71		
5	12	7		20.70	20.71	20.92		
5	12	13		20.78	20.84	20.91		
5	25	0		20.70	20.65	20.74		
5	1	0	256-QAM	18.80	18.73	18.86	7.71	0.0059
5	1	12		18.61	18.59	18.71		
5	1	24		18.76	18.76	18.77		
5	12	0		18.67	18.70	18.74		
5	12	7		18.67	18.72	18.64		
5	12	13		18.53	18.44	18.55		
5	25	0		18.53	18.64	18.71		
Limit	ERP < 7W			Result			Pass	



LTE Band 5 Maximum Average Power [dBm] (GT - LC = -9 dB)								
BW [MHz]	RB Size	RB Offset	Mod	Lowest	Middle	Highest	ERP (dBm)	ERP (W)
3	1	0	QPSK	23.44	23.40	23.61	12.47	0.0177
3	1	8		23.51	23.61	23.62		
3	1	14		23.58	23.59	23.58		
3	8	0		22.49	22.57	22.69		
3	8	4		22.53	22.61	22.72		
3	8	7		22.67	22.70	22.83		
3	15	0		22.56	22.57	22.72		
3	1	0	16-QAM	22.80	22.85	22.92	11.81	0.0152
3	1	8		22.95	22.96	22.88		
3	1	14		22.92	22.95	22.92		
3	8	0		21.56	21.55	21.74		
3	8	4		21.62	21.67	21.88		
3	8	7		21.75	21.72	21.86		
3	15	0		21.62	21.56	21.72		
3	1	0	64-QAM	21.66	21.69	21.84	10.80	0.0120
3	1	8		21.95	21.95	21.89		
3	1	14		21.85	21.86	21.87		
3	8	0		20.62	20.62	20.77		
3	8	4		20.67	20.67	20.88		
3	8	7		20.80	20.76	20.92		
3	15	0		20.68	20.75	20.74		
3	1	0	256-QAM	18.74	18.76	18.95	7.80	0.0060
3	1	8		18.58	18.61	18.68		
3	1	14		18.73	18.68	18.85		
3	8	0		18.71	18.66	18.76		
3	8	4		18.67	18.70	18.60		
3	8	7		18.59	18.53	18.54		
3	15	0		18.54	18.59	18.65		
Limit	ERP < 7W			Result			Pass	



LTE Band 5 Maximum Average Power [dBm] (GT - LC = -9 dB)								
BW [MHz]	RB Size	RB Offset	Mod	Lowest	Middle	Highest	ERP (dBm)	ERP (W)
1.4	1	0	QPSK	23.46	23.39	23.67	12.52	0.0179
1.4	1	3		23.57	23.61	23.61		
1.4	1	5		23.60	23.63	23.59		
1.4	3	0		23.41	23.42	23.57		
1.4	3	1		23.58	23.55	23.56		
1.4	3	3		23.64	23.54	23.64		
1.4	6	0		22.48	22.52	22.72		
1.4	1	0	16-QAM	22.74	22.82	22.95	11.82	0.0152
1.4	1	3		22.97	22.96	22.93		
1.4	1	5		22.87	22.96	22.94		
1.4	3	0		22.77	22.83	22.93		
1.4	3	1		22.92	22.96	22.88		
1.4	3	3		22.86	22.89	22.90		
1.4	6	0		21.62	21.54	21.70		
1.4	1	0	64-QAM	21.63	21.67	21.78	10.81	0.0121
1.4	1	3		21.93	21.91	21.96		
1.4	1	5		21.84	21.89	21.92		
1.4	3	0		21.64	21.72	21.85		
1.4	3	1		21.94	21.93	21.95		
1.4	3	3		21.79	21.96	21.85		
1.4	6	0		20.71	20.65	20.77		
1.4	1	0	256-QAM	18.78	18.79	18.92	7.77	0.0060
1.4	1	3		18.62	18.55	18.70		
1.4	1	5		18.75	18.70	18.85		
1.4	3	0		18.69	18.72	18.77		
1.4	3	1		18.66	18.72	18.63		
1.4	3	3		18.55	18.51	18.55		
1.4	6	0		18.50	18.59	18.70		
Limit	ERP < 7W			Result			Pass	



LTE Band 13 Maximum Average Power [dBm] (GT - LC = -9.4 dB)								
BW [MHz]	RB Size	RB Offset	Mod	Lowest	Middle	Highest	ERP (dBm)	ERP (W)
10	1	0	QPSK		23.46		11.91	0.0155
10	1	25			23.45			
10	1	49			23.43			
10	25	0			22.45			
10	25	12			22.48			
10	25	25			22.52			
10	50	0			22.58			
10	1	0	16-QAM		22.83		11.37	0.0137
10	1	25			22.92			
10	1	49			22.88			
10	25	0			21.44			
10	25	12			21.48			
10	25	25			21.56			
10	50	0			21.56			
10	1	0	64-QAM		21.75		10.34	0.0108
10	1	25			21.89			
10	1	49			21.80			
10	25	0			20.47			
10	25	12			20.53			
10	25	25			20.56			
10	50	0			20.61			
10	1	0	256-QAM		18.52		6.97	0.0050
10	1	25			18.44			
10	1	49			18.36			
10	25	0			18.42			
10	25	12			18.24			
10	25	25			18.22			
10	50	0			18.37			
Limit	ERP < 3W			Result			Pass	



LTE Band 13 Maximum Average Power [dBm] (GT - LC = -9.4 dB)								
BW [MHz]	RB Size	RB Offset	Mod	Lowest	Middle	Highest	ERP (dBm)	ERP (W)
5	1	0	QPSK	23.37	23.45	23.39	11.90	0.0155
5	1	12		23.43	23.41	23.38		
5	1	24		23.36	23.34	23.37		
5	12	0		22.39	22.35	22.44		
5	12	7		22.41	22.45	22.46		
5	12	13		22.50	22.45	22.51		
5	25	0		22.55	22.48	22.57		
5	1	0	16-QAM	22.77	22.77	22.76	11.34	0.0136
5	1	12		22.89	22.86	22.89		
5	1	24		22.79	22.88	22.85		
5	12	0		21.37	21.37	21.39		
5	12	7		21.48	21.47	21.41		
5	12	13		21.51	21.52	21.56		
5	25	0		21.55	21.53	21.47		
5	1	0	64-QAM	21.73	21.75	21.68	10.34	0.0108
5	1	12		21.82	21.89	21.89		
5	1	24		21.75	21.72	21.79		
5	12	0		20.46	20.45	20.40		
5	12	7		20.48	20.51	20.44		
5	12	13		20.47	20.52	20.47		
5	25	0		20.51	20.56	20.51		
5	1	0	256-QAM	18.43	18.51	18.48	6.96	0.0050
5	1	12		18.44	18.42	18.36		
5	1	24		18.29	18.28	18.34		
5	12	0		18.36	18.38	18.39		
5	12	7		18.23	18.21	18.20		
5	12	13		18.21	18.20	18.22		
5	25	0		18.37	18.34	18.34		
Limit	ERP < 3W			Result			Pass	



LTE Band 66 Maximum Average Power [dBm] (GT - LC = -4.7 dB)								
BW [MHz]	RB Size	RB Offset	Mod	Lowest	Middle	Highest	EIRP (dBm)	EIRP (W)
20	1	0	QPSK	23.46	23.39	23.37	18.76	0.0752
20	1	49		23.45	23.35	23.35		
20	1	99		23.32	23.32	23.29		
20	50	0		22.44	22.40	22.35		
20	50	24		22.45	22.40	22.36		
20	50	50		22.47	22.44	22.38		
20	100	0		22.40	22.39	22.32		
20	1	0	16-QAM	22.67	22.64	22.57	18.14	0.0652
20	1	49		22.82	22.84	22.80		
20	1	99		22.66	22.65	22.64		
20	50	0		21.41	21.41	21.38		
20	50	24		21.40	21.44	21.38		
20	50	50		21.49	21.47	21.47		
20	100	0		21.43	21.40	21.33		
20	1	0	64-QAM	21.67	21.67	21.61	16.99	0.0500
20	1	49		21.69	21.63	21.65		
20	1	99		21.67	21.64	21.63		
20	50	0		20.43	20.43	20.44		
20	50	24		20.39	20.42	20.41		
20	50	50		20.48	20.42	20.40		
20	100	0		20.42	20.41	20.34		
20	1	0	256-QAM	18.17	18.18	18.11	13.48	0.0223
20	1	49		18.14	18.03	17.93		
20	1	99		18.06	18.00	17.97		
20	50	0		18.07	18.02	18.10		
20	50	24		18.05	17.87	18.00		
20	50	50		18.06	17.87	17.92		
20	100	0		17.93	17.99	18.05		
Limit	EIRP < 1W			Result			Pass	



LTE Band 66 Maximum Average Power [dBm] (GT - LC = -4.7 dB)								
BW [MHz]	RB Size	RB Offset	Mod	Lowest	Middle	Highest	EIRP (dBm)	EIRP (W)
15	1	0	QPSK	23.44	23.30	23.34	18.74	0.0748
15	1	37		23.41	23.40	23.34		
15	1	74		23.22	23.31	23.19		
15	36	0		22.44	22.35	22.35		
15	36	20		22.40	22.35	22.30		
15	36	39		22.37	22.42	22.31		
15	75	0		22.36	22.36	22.31		
15	1	0	16-QAM	22.59	22.59	22.51	18.10	0.0646
15	1	37		22.76	22.80	22.75		
15	1	74		22.66	22.62	22.58		
15	36	0		21.37	21.34	21.36		
15	36	20		21.30	21.38	21.28		
15	36	39		21.47	21.43	21.39		
15	75	0		21.37	21.35	21.25		
15	1	0	64-QAM	21.65	21.57	21.58	16.97	0.0498
15	1	37		21.60	21.55	21.56		
15	1	74		21.67	21.57	21.60		
15	36	0		20.40	20.43	20.41		
15	36	20		20.36	20.36	20.36		
15	36	39		20.43	20.36	20.37		
15	75	0		20.39	20.36	20.30		
15	1	0	256-QAM	18.16	18.12	18.02	13.46	0.0222
15	1	37		18.07	17.97	17.90		
15	1	74		18.03	17.96	17.87		
15	36	0		18.04	17.96	18.09		
15	36	20		18.04	17.83	18.00		
15	36	39		18.00	17.85	17.87		
15	75	0		17.92	17.90	17.99		
Limit	EIRP < 1W			Result			Pass	



LTE Band 66 Maximum Average Power [dBm] (GT - LC = -4.7 dB)								
BW [MHz]	RB Size	RB Offset	Mod	Lowest	Middle	Highest	EIRP (dBm)	EIRP (W)
10	1	0	QPSK	23.44	23.33	23.35	18.74	0.0748
10	1	25		23.37	23.32	23.32		
10	1	49		23.32	23.23	23.27		
10	25	0		22.41	22.38	22.30		
10	25	12		22.40	22.33	22.28		
10	25	25		22.34	22.42	22.31		
10	50	0		22.36	22.34	22.32		
10	1	0	16-QAM	22.62	22.60	22.52	18.14	0.0652
10	1	25		22.76	22.84	22.73		
10	1	49		22.62	22.59	22.63		
10	25	0		21.39	21.31	21.31		
10	25	12		21.37	21.40	21.38		
10	25	25		21.40	21.46	21.38		
10	50	0		21.43	21.32	21.23		
10	1	0	64-QAM	21.61	21.61	21.53	16.91	0.0491
10	1	25		21.59	21.60	21.56		
10	1	49		21.59	21.58	21.57		
10	25	0		20.36	20.41	20.37		
10	25	12		20.37	20.35	20.32		
10	25	25		20.44	20.39	20.36		
10	50	0		20.37	20.32	20.34		
10	1	0	256-QAM	18.12	18.10	18.05	13.42	0.0220
10	1	25		18.09	18.01	17.88		
10	1	49		18.06	17.95	17.88		
10	25	0		17.99	17.92	18.05		
10	25	12		18.04	17.87	18.00		
10	25	25		17.99	17.85	17.87		
10	50	0		17.88	17.94	18.05		
Limit	EIRP < 1W			Result			Pass	



LTE Band 66 Maximum Average Power [dBm] (GT - LC = -4.7 dB)								
BW [MHz]	RB Size	RB Offset	Mod	Lowest	Middle	Highest	EIRP (dBm)	EIRP (W)
5	1	0	QPSK	23.44	23.27	23.31	18.74	0.0748
5	1	12		23.41	23.38	23.25		
5	1	24		23.26	23.23	23.28		
5	12	0		22.39	22.32	22.30		
5	12	7		22.45	22.36	22.30		
5	12	13		22.44	22.37	22.35		
5	25	0		22.31	22.29	22.29		
5	1	0	16-QAM	22.58	22.59	22.55	18.13	0.0650
5	1	12		22.73	22.83	22.71		
5	1	24		22.61	22.63	22.61		
5	12	0		21.34	21.39	21.36		
5	12	7		21.38	21.35	21.32		
5	12	13		21.48	21.44	21.42		
5	25	0		21.39	21.34	21.31		
5	1	0	64-QAM	21.58	21.63	21.56	16.93	0.0493
5	1	12		21.62	21.63	21.56		
5	1	24		21.61	21.62	21.53		
5	12	0		20.33	20.43	20.43		
5	12	7		20.35	20.36	20.34		
5	12	13		20.44	20.35	20.39		
5	25	0		20.37	20.37	20.27		
5	1	0	256-QAM	18.16	18.12	18.01	13.46	0.0222
5	1	12		18.09	17.95	17.85		
5	1	24		18.00	17.95	17.92		
5	12	0		17.97	18.02	18.04		
5	12	7		17.99	17.83	18.00		
5	12	13		18.04	17.79	17.88		
5	25	0		17.92	17.89	18.04		
Limit	EIRP < 1W			Result			Pass	



LTE Band 66 Maximum Average Power [dBm] (GT - LC = -4.7 dB)								
BW [MHz]	RB Size	RB Offset	Mod	Lowest	Middle	Highest	EIRP (dBm)	EIRP (W)
3	1	0	QPSK	23.41	23.28	23.29	18.72	0.0745
3	1	8		23.42	23.32	23.28		
3	1	14		23.24	23.30	23.27		
3	8	0		22.44	22.36	22.31		
3	8	4		22.37	22.39	22.35		
3	8	7		22.43	22.43	22.31		
3	15	0		22.31	22.36	22.30		
3	1	0	16-QAM	22.63	22.62	22.56	18.13	0.0650
3	1	8		22.77	22.83	22.78		
3	1	14		22.66	22.61	22.59		
3	8	0		21.40	21.39	21.28		
3	8	4		21.31	21.44	21.35		
3	8	7		21.46	21.40	21.42		
3	15	0		21.43	21.33	21.32		
3	1	0	64-QAM	21.67	21.64	21.61	16.97	0.0498
3	1	8		21.60	21.55	21.63		
3	1	14		21.63	21.59	21.55		
3	8	0		20.40	20.38	20.40		
3	8	4		20.31	20.40	20.31		
3	8	7		20.38	20.40	20.37		
3	15	0		20.35	20.35	20.33		
3	1	0	256-QAM	18.08	18.09	18.01	13.39	0.0218
3	1	8		18.08	17.93	17.86		
3	1	14		18.00	17.92	17.97		
3	8	0		18.05	17.97	18.00		
3	8	4		17.95	17.87	17.98		
3	8	7		18.06	17.84	17.88		
3	15	0		17.85	17.91	18.05		
Limit	EIRP < 1W			Result			Pass	



LTE Band 66 Maximum Average Power [dBm] (GT - LC = -4.7 dB)								
BW [MHz]	RB Size	RB Offset	Mod	Lowest	Middle	Highest	EIRP (dBm)	EIRP (W)
1.4	1	0	QPSK	23.39	23.35	23.34	18.75	0.0750
1.4	1	3		23.43	23.34	23.35		
1.4	1	5		23.31	23.27	23.28		
1.4	3	0		23.38	23.32	23.36		
1.4	3	1		23.45	23.34	23.29		
1.4	3	3		23.32	23.30	23.29		
1.4	6	0		22.41	22.34	22.30		
1.4	1	0	16-QAM	22.62	22.56	22.48	18.10	0.0646
1.4	1	3		22.72	22.80	22.73		
1.4	1	5		22.63	22.55	22.55		
1.4	3	0		22.59	22.59	22.56		
1.4	3	1		22.76	22.75	22.77		
1.4	3	3		22.60	22.63	22.61		
1.4	6	0		21.36	21.32	21.36		
1.4	1	0	64-QAM	21.65	21.66	21.60	16.96	0.0497
1.4	1	3		21.65	21.61	21.64		
1.4	1	5		21.59	21.61	21.61		
1.4	3	0		21.59	21.65	21.54		
1.4	3	1		21.60	21.61	21.61		
1.4	3	3		21.59	21.62	21.60		
1.4	6	0		20.39	20.36	20.38		
1.4	1	0	256-QAM	18.17	18.13	18.06	13.47	0.0222
1.4	1	3		18.06	17.99	17.89		
1.4	1	5		18.00	17.90	17.96		
1.4	3	0		18.03	17.93	18.06		
1.4	3	1		18.04	17.79	17.95		
1.4	3	3		18.04	17.78	17.84		
1.4	6	0		17.91	17.92	18.00		
Limit	EIRP < 1W			Result			Pass	



LTE Band 5B_CA Maximum Average Power [dBm] (GT - LC = -9 dB)										
BW [MHz]	PCC		SCC		Mod	Lowest	Middle	Highest	ERP (dBm)	ERP (W)
	RB Size	RB Offset	RB Size	RB Offset						
10+10	50	0	50	0	QPSK	22.47	22.40	22.42	12.31	0.0170
10+10	1	0	1	49		15.41	15.32	15.24		
10+10	1	49	1	0		23.46	23.32	23.43		
10+10	50	0	50	0	16-QAM	21.51	21.43	21.50	11.72	0.0149
10+10	1	0	1	49		15.81	15.66	15.71		
10+10	1	49	1	0		22.78	22.65	22.87		
10+10	50	0	50	0	64-QAM	21.48	21.46	21.53	10.60	0.0115
10+10	1	0	1	49		15.65	15.80	15.53		
10+10	1	49	1	0		21.65	21.75	21.60		
10+10	50	0	50	0	256-QAM	19.50	19.45	19.44	8.60	0.0072
10+10	1	0	1	49		15.66	15.66	15.57		
10+10	1	49	1	0		19.55	19.56	19.75		
10+5	50	0	25	0	QPSK	22.50	22.55	22.60	12.36	0.0172
10+5	1	0	1	24		16.01	16.05	16.07		
10+5	1	49	1	0		23.44	23.51	23.49		
10+5	50	0	25	0	16-QAM	21.53	21.60	21.66	11.86	0.0153
10+5	1	0	1	24		16.32	16.43	16.40		
10+5	1	49	1	0		22.66	23.01	22.75		
10+5	50	0	25	0	64-QAM	21.59	21.64	21.62	10.71	0.0118
10+5	1	0	1	24		16.61	16.52	16.30		
10+5	1	49	1	0		21.80	21.86	21.85		
10+5	50	0	25	0	256-QAM	19.54	19.52	19.67	8.60	0.0072
10+5	1	0	1	24		16.20	16.31	16.25		
10+5	1	49	1	0		19.60	19.61	19.75		
5+10	25	0	50	0	QPSK	22.50	22.57	22.58	12.43	0.0175
5+10	1	0	1	49		15.97	15.96	16.07		
5+10	1	24	1	0		23.36	23.47	23.58		
5+10	25	0	50	0	16-QAM	21.53	21.58	21.69	11.76	0.0150
5+10	1	0	1	49		16.29	16.56	16.30		
5+10	1	24	1	0		22.61	22.91	22.76		
5+10	25	0	50	0	64-QAM	21.58	21.57	21.64	10.68	0.0117
5+10	1	0	1	49		16.25	16.25	16.45		
5+10	1	24	1	0		21.67	21.72	21.83		
5+10	25	0	50	0	256-QAM	19.51	19.55	19.65	8.50	0.0071
5+10	1	0	1	49		16.12	16.18	16.10		
5+10	1	24	1	0		19.53	19.63	19.62		
Limit	ERP < 7W					Result			Pass	



LTE Band 5B_CA Maximum Average Power [dBm] (GT - LC = -9 dB)										
BW [MHz]	PCC		SCC		Mod	Lowest	Middle	Highest	ERP (dBm)	ERP (W)
	RB Size	RB Offset	RB Size	RB Offset						
5+3	25	0	15	0	QPSK	22.52	22.60	22.65	12.42	0.0175
5+3	1	0	1	14		16.01	16.06	16.23		
5+3	1	24	1	0		23.49	23.57	23.53		
5+3	25	0	15	0	16-QAM	21.54	21.59	21.76	11.65	0.0146
5+3	1	0	1	14		16.49	16.26	16.48		
5+3	1	24	1	0		22.75	22.80	22.79		
5+3	25	0	15	0	64-QAM	21.62	21.66	21.61	10.64	0.0116
5+3	1	0	1	14		16.40	16.22	16.51		
5+3	1	24	1	0		21.62	21.79	21.71		
5+3	25	0	15	0	256-QAM	19.58	19.59	19.67	8.68	0.0074
5+3	1	0	1	14		16.23	16.31	16.26		
5+3	1	24	1	0		19.57	19.83	19.80		
3+5	15	0	25	0	QPSK	22.58	22.61	22.76	12.55	0.0180
3+5	1	0	1	24		16.10	16.04	16.19		
3+5	1	14	1	0		23.70	23.55	23.58		
3+5	15	0	25	0	16-QAM	21.70	21.62	21.81	12.34	0.0171
3+5	1	0	1	24		23.49	23.25	23.22		
3+5	1	14	1	0		22.62	22.91	22.98		
3+5	15	0	25	0	64-QAM	21.61	21.61	21.81	10.91	0.0123
3+5	1	0	1	24		21.69	21.91	22.06		
3+5	1	14	1	0		21.67	21.71	21.82		
3+5	15	0	25	0	256-QAM	19.64	19.57	19.78	8.75	0.0075
3+5	1	0	1	24		19.75	19.90	19.83		
3+5	1	14	1	0		19.67	19.79	19.85		
Limit	ERP < 7W					Result			Pass	



LTE Band 66B_CA Maximum Average Power [dBm] (GT - LC = -4.7 dB)										
BW [MHz]	PCC		SCC		Mod	Lowest	Middle	Highest	EIRP (dBm)	EIRP (W)
	RB Size	RB Offset	RB Size	RB Offset						
10+10	50	0	50	0	QPSK	22.75	22.48	22.60	18.74	0.0748
10+10	1	0	1	49		15.64	15.46	15.60		
10+10	1	49	1	0		23.44	23.36	23.42		
10+10	50	0	50	0	16-QAM	21.76	21.56	21.68	18.01	0.0632
10+10	1	0	1	49		16.04	15.88	15.89		
10+10	1	49	1	0		22.69	22.39	22.71		
10+10	50	0	50	0	64-QAM	21.72	21.53	21.56	17.02	0.0504
10+10	1	0	1	49		15.92	15.73	15.88		
10+10	1	49	1	0		21.69	21.60	21.59		
10+10	50	0	50	0	256-QAM	19.73	19.72	19.75	15.15	0.0327
10+10	1	0	1	49		15.88	15.98	15.87		
10+10	1	49	1	0		19.73	19.75	19.85		
15+5	75	0	25	0	QPSK	22.61	22.70	22.54	19.00	0.0794
15+5	1	0	1	24		22.69	23.62	23.70		
15+5	1	74	1	0		23.60	23.48	23.29		
15+5	75	0	25	0	16-QAM	21.65	21.78	21.56	19.27	0.0845
15+5	1	0	1	24		23.05	23.83	23.97		
15+5	1	74	1	0		22.71	22.47	22.61		
15+5	75	0	25	0	64-QAM	21.68	21.63	21.55	19.11	0.0815
15+5	1	0	1	24		22.84	23.81	23.64		
15+5	1	74	1	0		21.72	21.64	21.53		
15+5	75	0	25	0	256-QAM	19.76	19.73	19.79	18.14	0.0652
15+5	1	0	1	24		21.83	22.84	22.78		
15+5	1	74	1	0		19.95	19.88	19.89		
5+15	25	0	75	0	QPSK	22.58	22.68	22.59	19.02	0.0798
5+15	1	0	1	74		22.70	23.72	23.67		
5+15	1	24	1	0		23.38	23.42	23.30		
5+15	25	0	75	0	16-QAM	21.69	21.74	21.69	19.19	0.0830
5+15	1	0	1	74		23.05	23.89	23.83		
5+15	1	24	1	0		22.58	22.63	22.63		
5+15	25	0	75	0	64-QAM	21.76	21.71	21.72	19.13	0.0818
5+15	1	0	1	74		23.00	23.71	23.83		
5+15	1	24	1	0		21.66	21.70	21.61		
5+15	25	0	75	0	256-QAM	19.74	19.76	19.82	18.24	0.0667
5+15	1	0	1	74		21.83	22.78	22.94		
5+15	1	24	1	0		19.74	19.54	19.80		
Limit	EIRP < 1W					Result			Pass	



LTE Band 66B_CA Maximum Average Power [dBm] (GT - LC = -4.7 dB)										
BW [MHz]	PCC		SCC		Mod	Lowest	Middle	Highest	EIRP (dBm)	EIRP (W)
	RB Size	RB Offset	RB Size	RB Offset						
10+5	50	0	25	0	QPSK	22.78	22.73	22.70	18.79	0.0757
10+5	1	0	1	24		16.20	16.18	16.16		
10+5	1	49	1	0		23.49	23.30	23.49		
10+5	50	0	25	0	16-QAM	21.76	21.72	21.79	18.22	0.0664
10+5	1	0	1	24		16.46	16.54	16.49		
10+5	1	49	1	0		22.92	22.70	22.70		
10+5	50	0	25	0	64-QAM	21.77	21.77	21.71	17.07	0.0509
10+5	1	0	1	24		16.47	16.27	16.28		
10+5	1	49	1	0		21.77	21.65	21.68		
10+5	50	0	25	0	256-QAM	19.74	19.68	19.74	15.12	0.0325
10+5	1	0	1	24		16.72	16.23	16.63		
10+5	1	49	1	0		19.45	19.82	19.70		
5+10	25	0	50	0	QPSK	22.83	22.76	22.83	18.74	0.0748
5+10	1	0	1	49		16.12	16.20	16.16		
5+10	1	24	1	0		23.37	23.36	23.44		
5+10	25	0	50	0	16-QAM	21.84	21.74	21.82	18.10	0.0646
5+10	1	0	1	49		16.33	16.51	16.57		
5+10	1	24	1	0		22.67	22.80	22.68		
5+10	25	0	50	0	64-QAM	21.73	21.76	21.71	17.17	0.0521
5+10	1	0	1	49		16.53	16.46	16.27		
5+10	1	24	1	0		21.76	21.87	21.53		
5+10	25	0	50	0	256-QAM	19.65	19.67	19.71	15.01	0.0317
5+10	1	0	1	49		16.37	16.30	16.21		
5+10	1	24	1	0		19.56	19.57	19.38		
5+5	25	0	25	0	QPSK	22.81	22.89	22.94	19.02	0.0798
5+5	1	0	1	24		22.43	23.67	23.28		
5+5	1	24	1	0		23.53	23.64	23.72		
5+5	25	0	25	0	16-QAM	21.89	21.90	21.94	18.99	0.0793
5+5	1	0	1	24		22.71	23.69	23.48		
5+5	1	24	1	0		22.75	22.81	22.87		
5+5	25	0	25	0	64-QAM	21.84	21.85	21.83	19.00	0.0794
5+5	1	0	1	24		22.59	23.70	23.49		
5+5	1	24	1	0		21.88	21.91	22.02		
5+5	25	0	25	0	256-QAM	19.85	19.90	19.87	18.26	0.0670
5+5	1	0	1	24		21.80	22.96	22.64		
5+5	1	24	1	0		19.68	19.89	19.93		
Limit	EIRP < 1W					Result			Pass	



LTE Band 66C_CA Maximum Average Power [dBm] (GT - LC = -4.7 dB)										
BW [MHz]	PCC		SCC		Mod	Lowest	Middle	Highest	EIRP (dBm)	EIRP (W)
	RB Size	RB Offset	RB Size	RB Offset						
20+20	100	0	100	0	QPSK	22.85	22.87	22.86	18.71	0.0743
20+20	1	0	1	99		17.86	17.91	17.88		
20+20	1	99	1	0		23.37	23.37	23.41		
20+20	100	0	100	0	16-QAM	21.87	21.77	21.88	18.48	0.0705
20+20	1	0	1	99		18.15	18.15	18.25		
20+20	1	99	1	0		22.71	22.88	23.18		
20+20	100	0	100	0	64-QAM	21.88	21.82	21.81	17.18	0.0522
20+20	1	0	1	99		18.23	18.13	18.22		
20+20	1	99	1	0		21.75	21.68	21.78		
20+20	100	0	100	0	256-QAM	19.89	19.86	19.84	15.19	0.0330
20+20	1	0	1	99		17.99	17.91	18.05		
20+20	1	99	1	0		19.50	19.59	19.63		
20+15	100	0	75	0	QPSK	22.04	22.10	22.06	18.02	0.0634
20+15	1	0	1	74		16.90	16.94	17.09		
20+15	1	74	1	0		22.50	22.56	22.72		
20+15	100	0	75	0	16-QAM	21.14	21.13	21.08	17.30	0.0537
20+15	1	0	1	74		17.36	17.26	17.37		
20+15	1	74	1	0		21.81	21.89	22.00		
20+15	100	0	75	0	64-QAM	21.18	21.17	21.04	16.48	0.0445
20+15	1	0	1	74		17.38	17.18	17.21		
20+15	1	74	1	0		20.69	20.93	20.94		
20+15	100	0	75	0	256-QAM	19.05	18.99	19.05	14.35	0.0272
20+15	1	0	1	74		16.99	17.01	17.44		
20+15	1	74	1	0		18.94	18.77	18.80		
15+20	75	0	100	0	QPSK	22.80	22.78	22.87	18.79	0.0757
15+20	1	0	1	99		17.82	17.88	17.83		
15+20	1	74	1	0		23.43	23.49	23.40		
15+20	75	0	100	0	16-QAM	21.85	21.84	21.81	18.47	0.0703
15+20	1	0	1	99		18.32	18.05	18.21		
15+20	1	74	1	0		22.88	22.71	23.17		
15+20	75	0	100	0	64-QAM	21.82	21.89	21.77	17.19	0.0524
15+20	1	0	1	99		18.07	18.11	18.27		
15+20	1	74	1	0		21.58	21.77	21.71		
15+20	75	0	100	0	256-QAM	19.49	19.62	19.66	14.96	0.0313
15+20	1	0	1	99		17.68	17.59	17.64		
15+20	1	74	1	0		19.43	19.46	19.35		
Limit	EIRP < 1W				Result			Pass		



LTE Band 66C_CA Maximum Average Power [dBm] (GT - LC = -4.7 dB)										
BW [MHz]	PCC		SCC		Mod	Lowest	Middle	Highest	EIRP (dBm)	EIRP (W)
	RB Size	RB Offset	RB Size	RB Offset						
20+10	100	0	50	0	QPSK	22.55	22.31	22.21	18.23	0.0665
20+10	1	0	1	49		17.37	17.13	17.28		
20+10	1	99	1	0		22.76	22.85	22.93		
20+10	100	0	50	0	16-QAM	21.58	21.36	21.27	17.72	0.0592
20+10	1	0	1	49		17.78	17.45	17.72		
20+10	1	99	1	0		22.24	22.11	22.42		
20+10	100	0	50	0	64-QAM	21.35	21.13	21.27	16.65	0.0462
20+10	1	0	1	49		17.74	17.48	17.36		
20+10	1	99	1	0		21.29	21.15	21.09		
20+10	100	0	50	0	256-QAM	19.32	19.11	19.22	14.62	0.0290
20+10	1	0	1	49		17.37	17.19	17.26		
20+10	1	99	1	0		19.28	19.24	19.10		
10+20	50	0	100	0	QPSK	22.63	22.84	22.87	18.89	0.0774
10+20	1	0	1	99		17.88	17.82	17.90		
10+20	1	49	1	0		23.51	23.55	23.59		
10+20	50	0	100	0	16-QAM	21.87	21.83	21.85	18.25	0.0668
10+20	1	0	1	99		18.09	18.03	18.37		
10+20	1	49	1	0		22.89	22.95	22.83		
10+20	50	0	100	0	64-QAM	21.91	21.82	21.81	17.21	0.0526
10+20	1	0	1	99		18.11	18.03	18.14		
10+20	1	49	1	0		21.82	21.73	21.88		
10+20	50	0	100	0	256-QAM	19.74	19.67	19.70	15.04	0.0319
10+20	1	0	1	99		17.88	16.25	17.84		
10+20	1	49	1	0		17.92	19.56	19.62		
20+5	100	0	25	0	QPSK	22.06	22.07	22.22	18.26	0.0670
20+5	1	0	1	24		17.07	17.08	17.30		
20+5	1	99	1	0		22.76	22.75	22.96		
20+5	100	0	25	0	16-QAM	21.06	21.08	21.17	17.51	0.0564
20+5	1	0	1	24		17.41	17.40	17.66		
20+5	1	99	1	0		22.17	22.21	22.07		
20+5	100	0	25	0	64-QAM	21.00	21.15	21.19	16.50	0.0447
20+5	1	0	1	24		17.30	17.33	17.64		
20+5	1	99	1	0		20.71	20.92	21.20		
20+5	100	0	25	0	256-QAM	18.99	19.17	19.20	14.59	0.0288
20+5	1	0	1	24		17.16	17.27	17.41		
20+5	1	99	1	0		18.83	19.09	19.29		
Limit	EIRP < 1W				Result			Pass		



LTE Band 66C_CA Maximum Average Power [dBm] (GT - LC = -4.7 dB)										
BW [MHz]	PCC		SCC		Mod	Lowest	Middle	Highest	EIRP (dBm)	EIRP (W)
	RB Size	RB Offset	RB Size	RB Offset						
5+20	25	0	100	0	QPSK	21.93	22.36	22.19	18.39	0.0690
5+20	1	0	1	99		17.24	17.48	17.19		
5+20	1	24	1	0		22.97	22.70	23.09		
5+20	25	0	100	0	16-QAM	21.21	21.34	21.25	17.69	0.0587
5+20	1	0	1	99		17.70	17.66	17.55		
5+20	1	24	1	0		22.39	21.99	22.39		
5+20	25	0	100	0	64-QAM	21.20	21.42	21.16	16.72	0.0470
5+20	1	0	1	99		17.53	17.62	17.37		
5+20	1	24	1	0		21.28	21.08	21.39		
5+20	25	0	100	0	256-QAM	19.25	19.42	19.18	14.72	0.0296
5+20	1	0	1	99		17.39	16.99	17.45		
5+20	1	24	1	0		19.30	19.11	18.86		
Limit	EIRP < 1W					Result			Pass	



LTE Band 66C_CA Maximum Average Power [dBm] (GT - LC = -4.7 dB)										
BW [MHz]	PCC		SCC		Mod	Lowest	Middle	Highest	EIRP (dBm)	EIRP (W)
	RB Size	RB Offset	RB Size	RB Offset						
15+10	75	0	50	0	QPSK	22.77	22.76	22.84	18.76	0.0752
15+10	1	0	1	49		17.85	17.84	17.86		
15+10	1	74	1	0		23.34	23.42	23.46		
15+10	75	0	50	0	16-QAM	21.78	21.74	21.91	18.11	0.0647
15+10	1	0	1	49		18.09	18.11	18.31		
15+10	1	74	1	0		22.71	22.71	22.81		
15+10	75	0	50	0	64-QAM	21.80	21.78	21.80	17.13	0.0516
15+10	1	0	1	49		18.03	18.10	18.11		
15+10	1	74	1	0		21.83	21.59	21.67		
15+10	75	0	50	0	256-QAM	19.57	19.65	18.21	14.95	0.0313
15+10	1	0	1	49		17.91	17.81	17.84		
15+10	1	74	1	0		18.98	19.51	19.41		
10+15	50	0	75	0	QPSK	22.74	22.76	22.81	18.75	0.0750
10+15	1	0	1	74		17.83	17.83	17.67		
10+15	1	49	1	0		23.35	23.39	23.45		
10+15	50	0	75	0	16-QAM	21.77	21.77	21.87	18.23	0.0665
10+15	1	0	1	74		18.06	18.15	18.17		
10+15	1	49	1	0		22.75	22.93	22.62		
10+15	50	0	75	0	64-QAM	21.79	21.81	21.85	17.15	0.0519
10+15	1	0	1	74		18.18	18.11	18.17		
10+15	1	49	1	0		21.67	21.58	21.80		
10+15	50	0	75	0	256-QAM	19.91	19.81	19.85	15.21	0.0332
10+15	1	0	1	74		17.98	17.93	17.85		
10+15	1	49	1	0		19.61	19.72	19.69		
15+15	75	0	75	0	QPSK	22.78	22.83	22.82	19.06	0.0805
15+15	1	0	1	74		17.79	17.79	17.80		
15+15	1	74	1	0		23.76	23.37	23.44		
15+15	75	0	75	0	16-QAM	21.78	21.81	21.94	18.05	0.0638
15+15	1	0	1	74		18.24	18.16	18.19		
15+15	1	74	1	0		22.63	22.64	22.75		
15+15	75	0	75	0	64-QAM	21.82	21.84	21.87	17.17	0.0521
15+15	1	0	1	74		18.16	18.02	17.89		
15+15	1	74	1	0		21.84	21.78	21.65		
15+15	75	0	75	0	256-QAM	19.66	19.71	19.69	15.01	0.0317
15+15	1	0	1	74		17.88	17.75	17.88		
15+15	1	74	1	0		18.37	19.43	19.59		
Limit	EIRP < 1W					Result			Pass	



LTE Band 2

Peak-to-Average Ratio

Mode	LTE Band 2 / 20MHz				
Mod.	QPSK	16QAM	64QAM	256QAM	Limit: 13dB
RB Size	Full RB	Full RB	Full RB	Full RB	Result
Middle CH	4.93	6.00	6.46	6.72	PASS



LTE Band 2 / 20MHz / QPSK

Middle Channel / Full RB

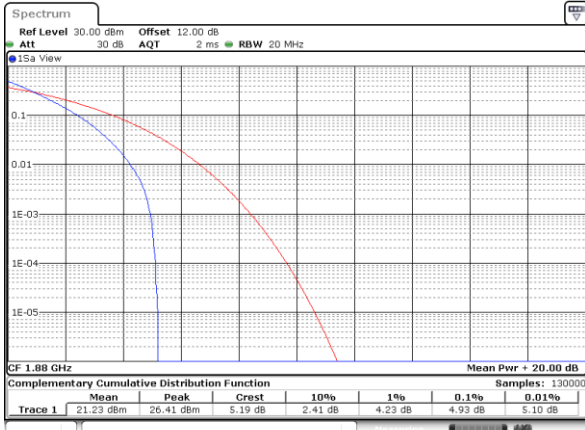

Date: 23.OCT.2021 01:30:46

LTE Band 2 / 20MHz / 16QAM

Middle Channel / Full RB

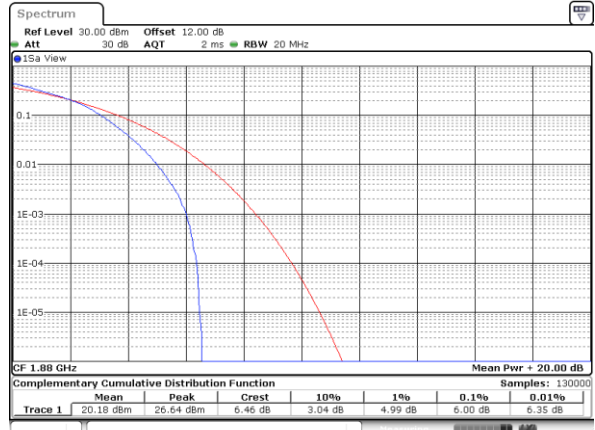

Date: 23.OCT.2021 01:30:22

LTE Band 2 / 20MHz / 64QAM

Middle Channel / Full RB

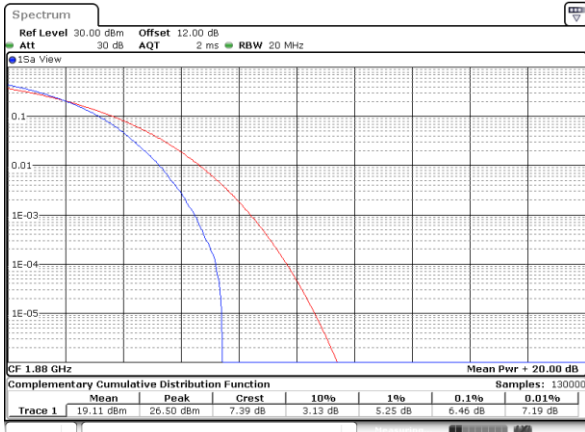

Date: 23.OCT.2021 01:31:11

LTE Band 2 / 20MHz / 256QAM

Middle Channel / Full RB

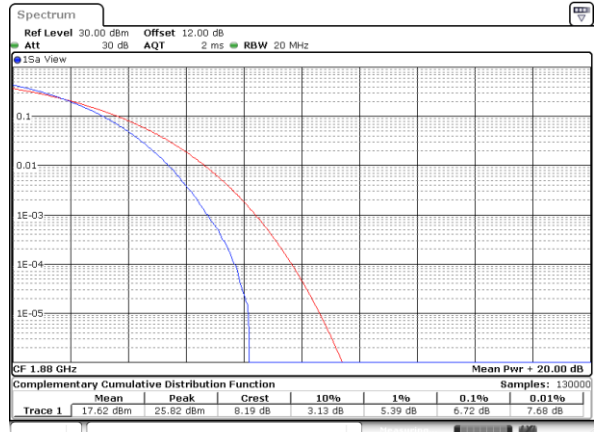

Date: 24.OCT.2021 16:29:30



26dB Bandwidth

Mode	LTE Band 2 : 26dB BW(MHz)											
BW	1.4MHz		3MHz		5MHz		10MHz		15MHz		20MHz	
Mod.	QPSK	16QAM	QPSK	16QAM	QPSK	16QAM	QPSK	16QAM	QPSK	16QAM	QPSK	16QAM
Middle CH	1.32	1.35	3.11	3.08	4.94	4.96	9.85	9.95	14.51	14.69	18.86	19.58
Mode	LTE Band 2 : 26dB BW(MHz)											
BW	1.4MHz		3MHz		5MHz		10MHz		15MHz		20MHz	
Mod.	64QAM	256 QAM	64QAM	256 QAM	64QAM	256 QAM	64QAM	256 QAM	64QAM	256 QAM	64QAM	256 QAM
Middle CH	1.34	1.32	3.08	3.15	5.04	5.07	9.93	9.95	14.15	14.15	19.18	19.34



LTE Band 2

Middle Channel / 1.4MHz / QPSK

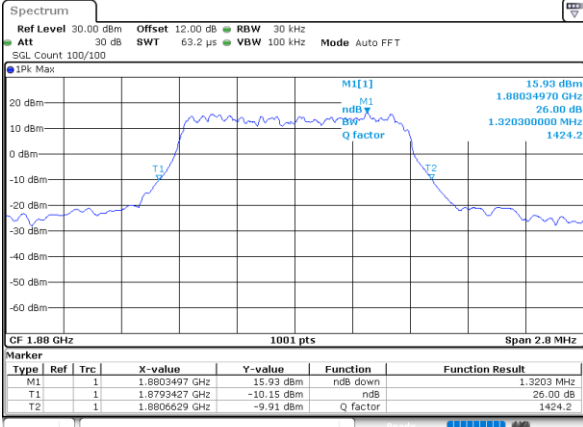

Date: 22.OCT.2021 23:34:10

Middle Channel / 1.4MHz / 16QAM

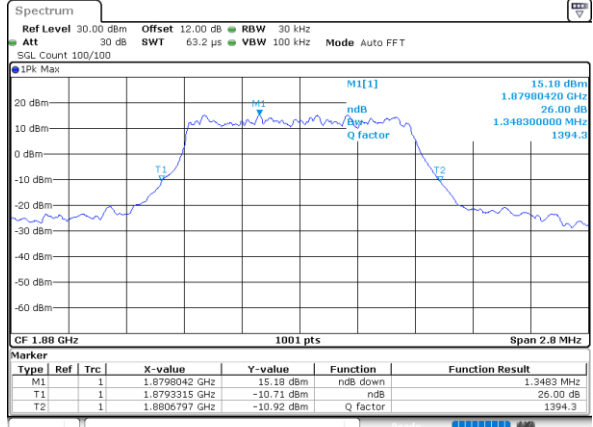

Date: 22.OCT.2021 23:34:49

Middle Channel / 3MHz / QPSK

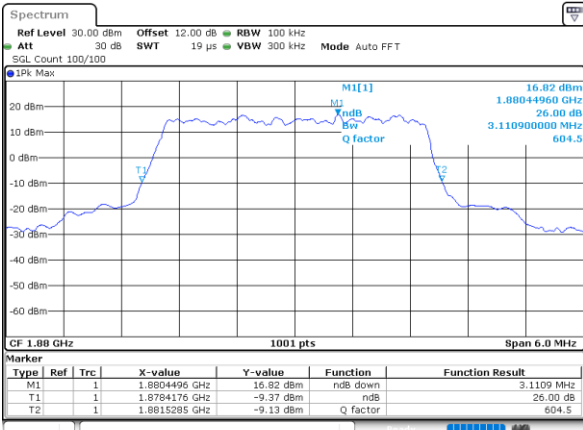

Date: 22.OCT.2021 23:56:13

Middle Channel / 3MHz / 16QAM

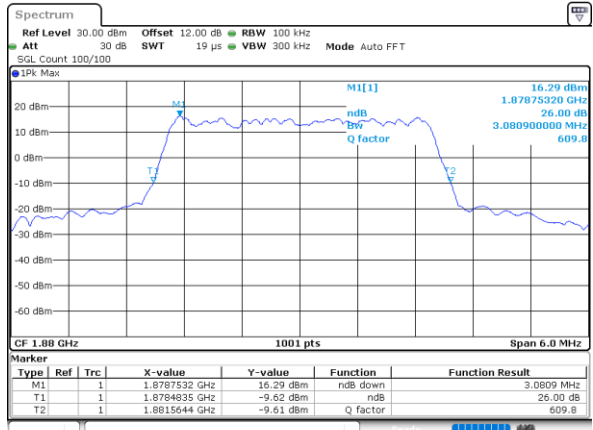

Date: 22.OCT.2021 23:56:51

Middle Channel / 5MHz / QPSK

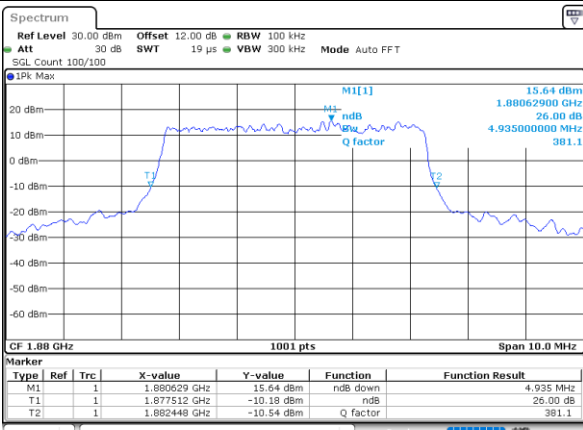

Date: 23.OCT.2021 00:06:16

Middle Channel / 5MHz / 16QAM

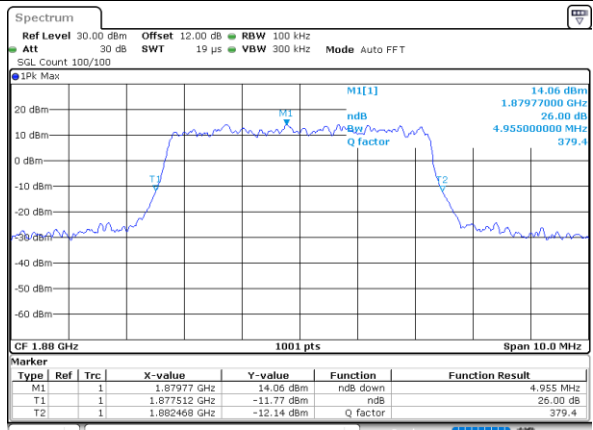

Date: 23.OCT.2021 00:06:54



LTE Band 2

Middle Channel / 10MHz / QPSK

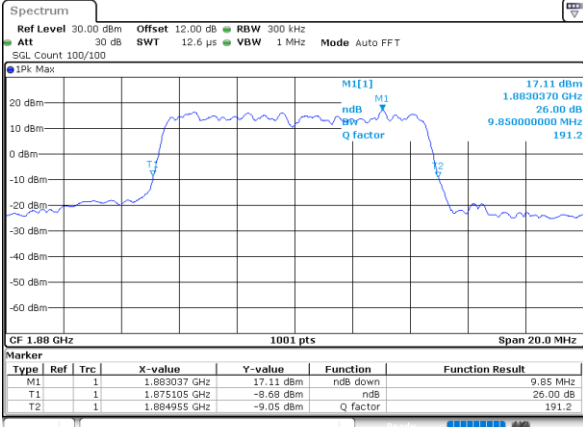

Date: 23.OCT.2021 00:22:19

Middle Channel / 10MHz / 16QAM

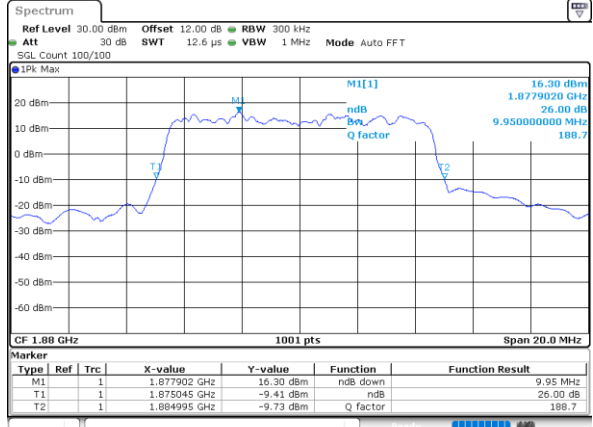

Date: 23.OCT.2021 00:22:57

Middle Channel / 15MHz / QPSK

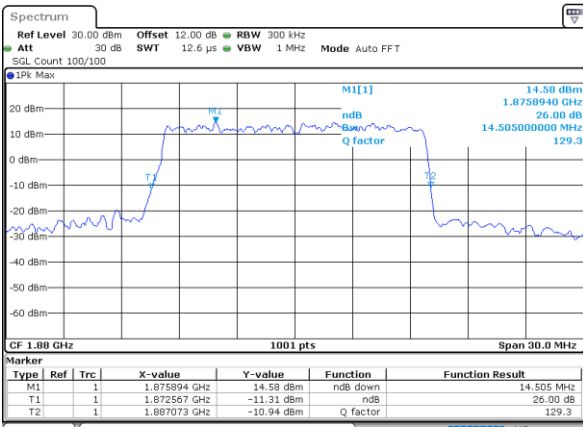

Date: 23.OCT.2021 00:38:22

Middle Channel / 15MHz / 16QAM

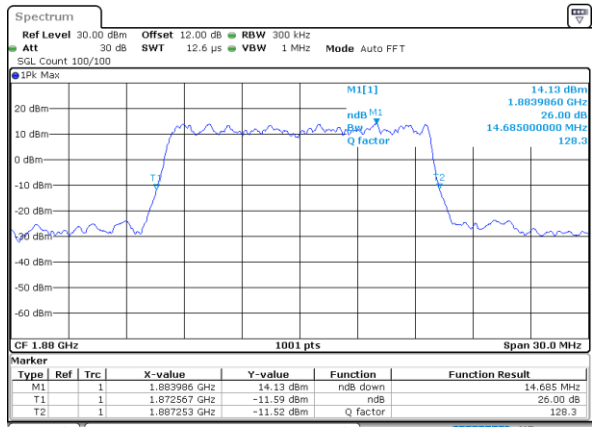

Date: 23.OCT.2021 00:39:00

Middle Channel / 20MHz / QPSK

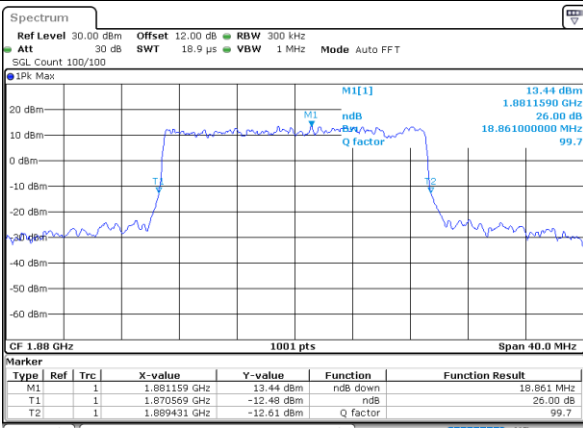

Date: 23.OCT.2021 00:54:25

Middle Channel / 20MHz / 16QAM

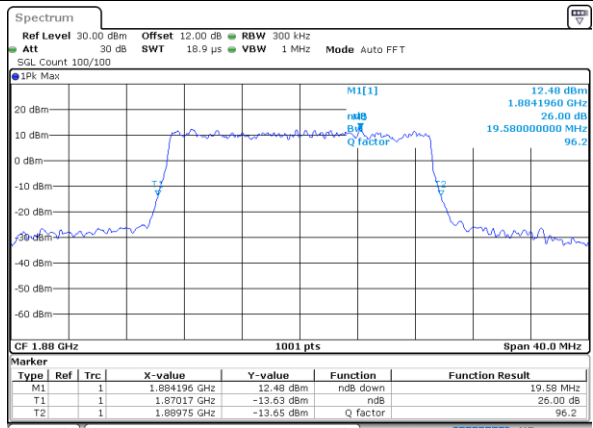

Date: 23.OCT.2021 00:55:03



LTE Band 2

Middle Channel / 1.4MHz / 64QAM

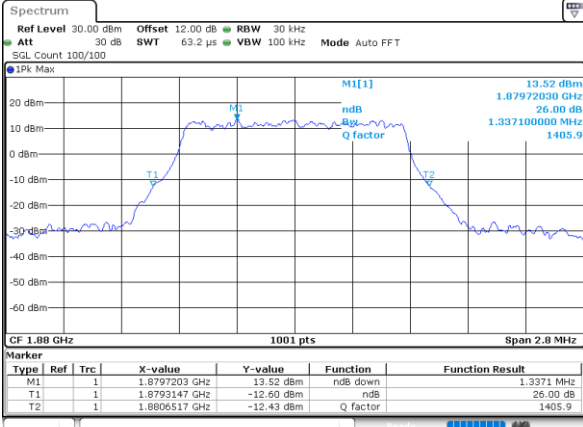

Date: 22.OCT.2021 23:23:58

Middle Channel / 3MHz / 64QAM

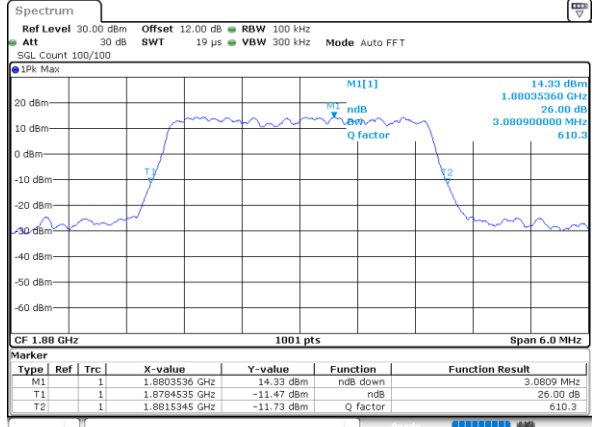

Date: 23.OCT.2021 01:05:40

Middle Channel / 5MHz / 64QAM

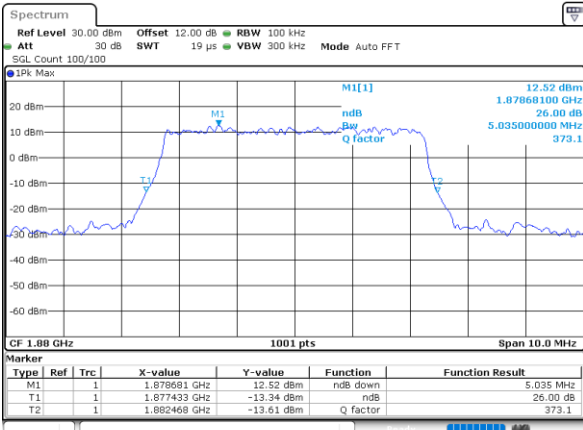

Date: 23.OCT.2021 01:11:07

Middle Channel / 10MHz / 64QAM

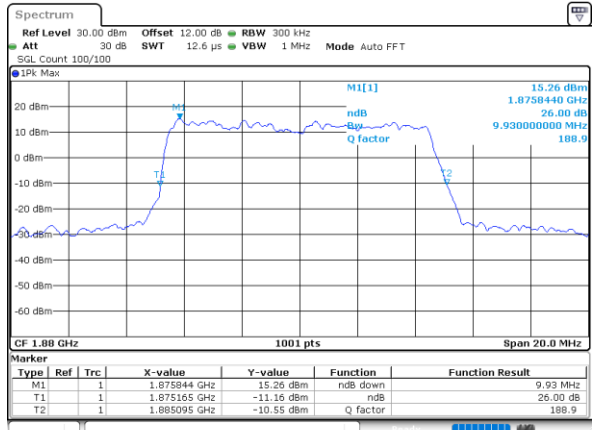

Date: 23.OCT.2021 01:16:33

Middle Channel / 15MHz / 64QAM

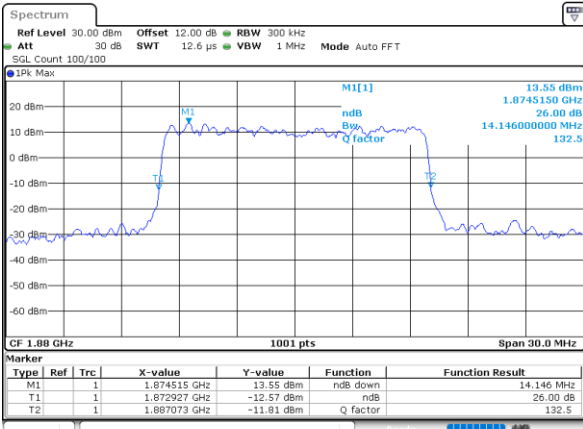

Date: 23.OCT.2021 01:21:59

Middle Channel / 20MHz / 64QAM

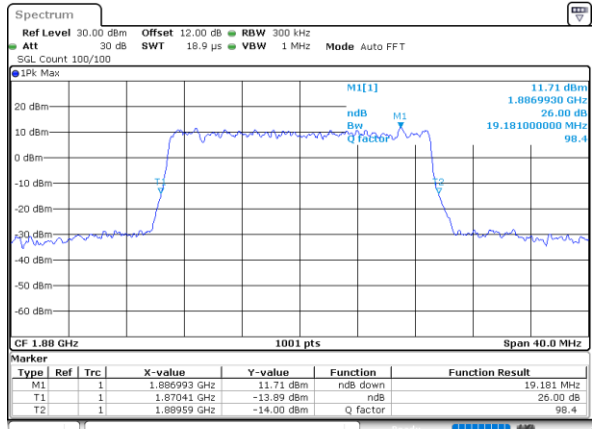

Date: 23.OCT.2021 01:27:26



LTE Band 2

Middle Channel / 1.4MHz / 256QAM

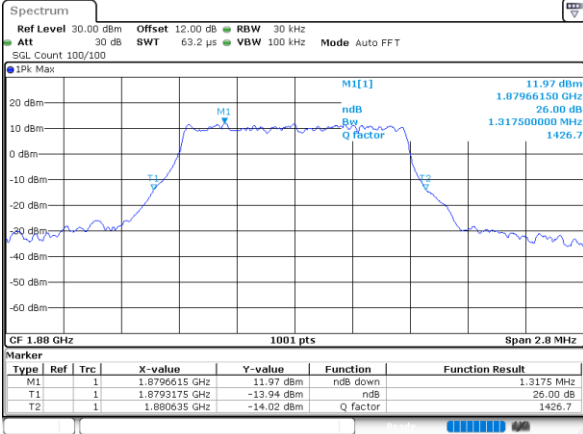

Date: 24.OCT.2021 15:41:16

Middle Channel / 3MHz / 256QAM

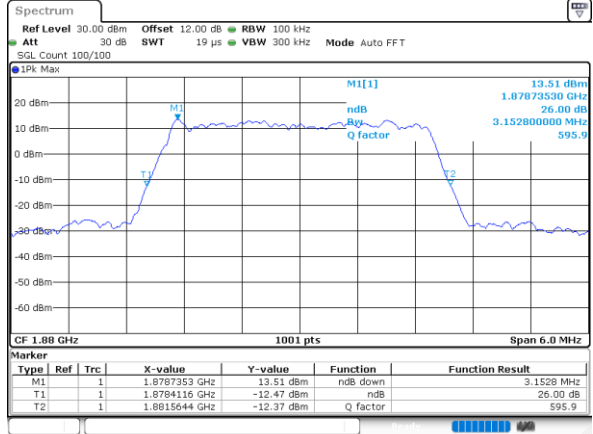

Date: 24.OCT.2021 15:46:42

Middle Channel / 5MHz / 256QAM

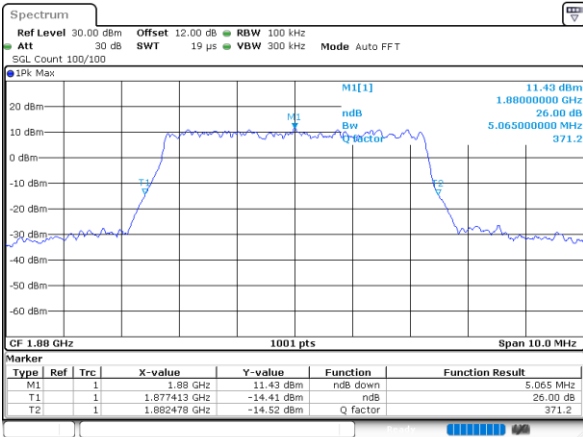

Date: 24.OCT.2021 16:10:48

Middle Channel / 10MHz / 256QAM

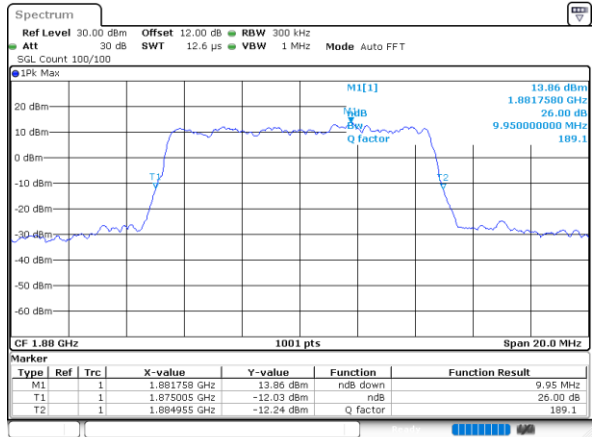

Date: 24.OCT.2021 16:15:17

Middle Channel / 15MHz / 256QAM

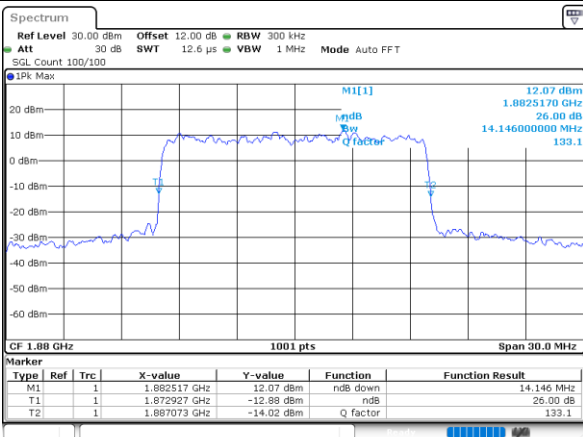

Date: 24.OCT.2021 16:21:55

Middle Channel / 20MHz / 256QAM

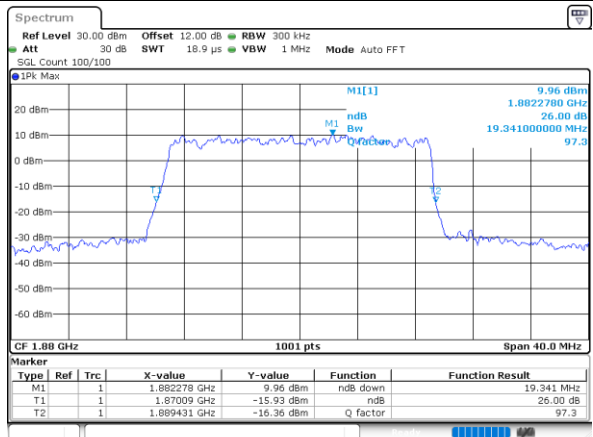

Date: 24.OCT.2021 16:27:28



Occupied Bandwidth

Mode	LTE Band 2 : 99%OBW(MHz)											
BW	1.4MHz		3MHz		5MHz		10MHz		15MHz		20MHz	
Mod.	QPSK	16QAM	QPSK	16QAM	QPSK	16QAM	QPSK	16QAM	QPSK	16QAM	QPSK	16QAM
Middle CH	1.10	1.10	2.73	2.72	4.51	4.51	9.05	9.03	13.40	13.52	17.98	17.94
Mode	LTE Band 2 : 99%OBW(MHz)											
BW	1.4MHz		3MHz		5MHz		10MHz		15MHz		20MHz	
Mod.	64QAM	256 QAM	64QAM	256 QAM	64QAM	256 QAM	64QAM	256 QAM	64QAM	256 QAM	64QAM	256 QAM
Middle CH	1.09	1.10	2.73	2.72	4.51	4.51	9.05	9.07	13.52	13.52	17.94	17.90



LTE Band 2

Middle Channel / 1.4MHz / QPSK

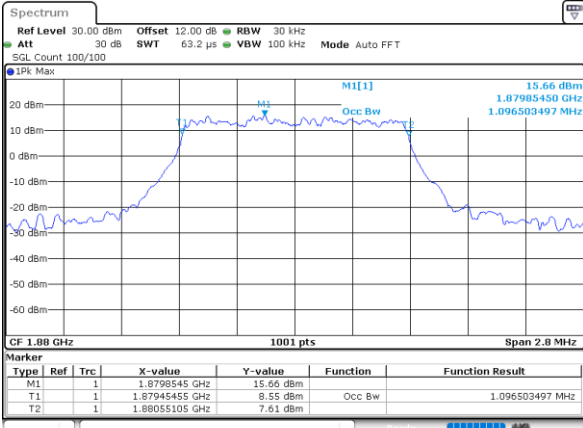

Date: 22.OCT.2021 23:32:54

Middle Channel / 1.4MHz / 16QAM

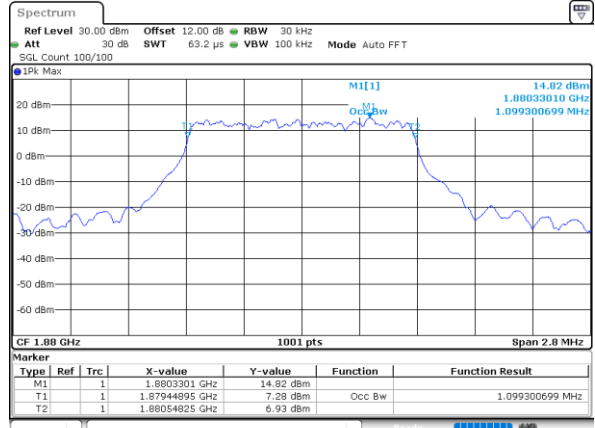

Date: 22.OCT.2021 23:33:32

Middle Channel / 3MHz / QPSK

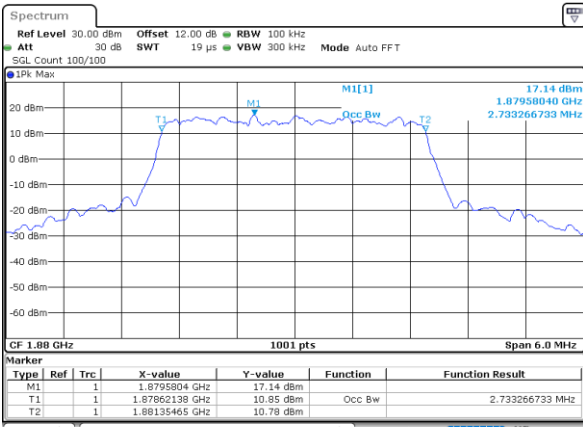

Date: 22.OCT.2021 23:48:56

Middle Channel / 3MHz / 16QAM

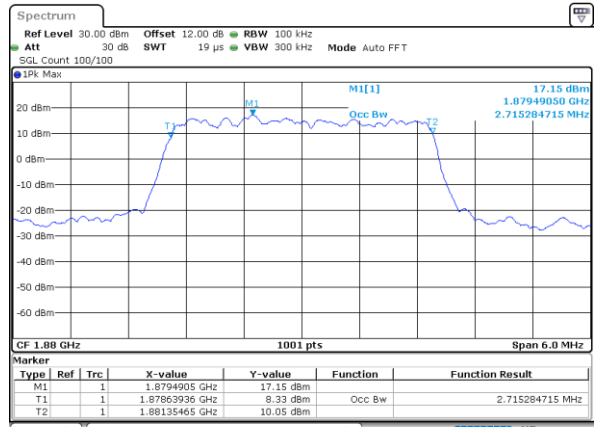

Date: 22.OCT.2021 23:49:35

Middle Channel / 5MHz / QPSK

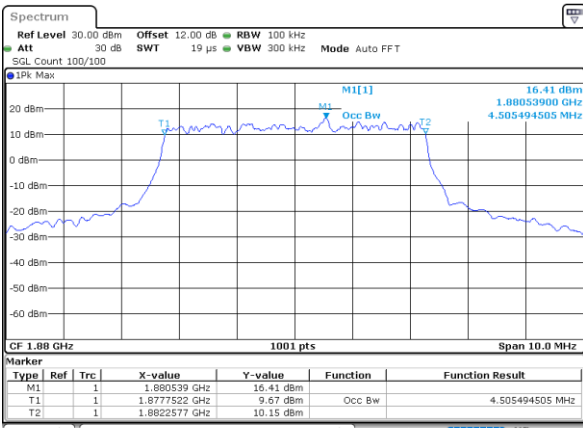

Date: 23.OCT.2021 00:04:59

Middle Channel / 5MHz / 16QAM

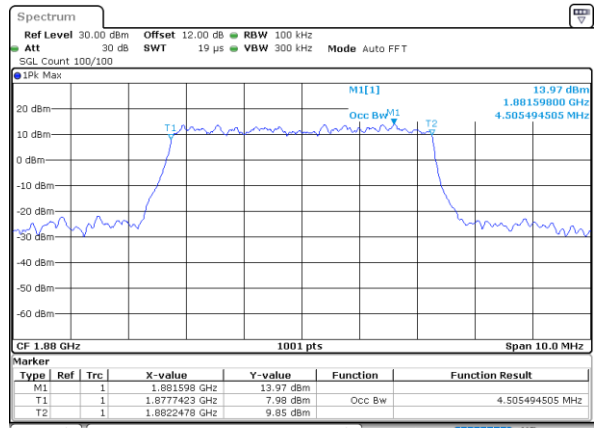

Date: 23.OCT.2021 00:05:38



LTE Band 2

Middle Channel / 10MHz / QPSK

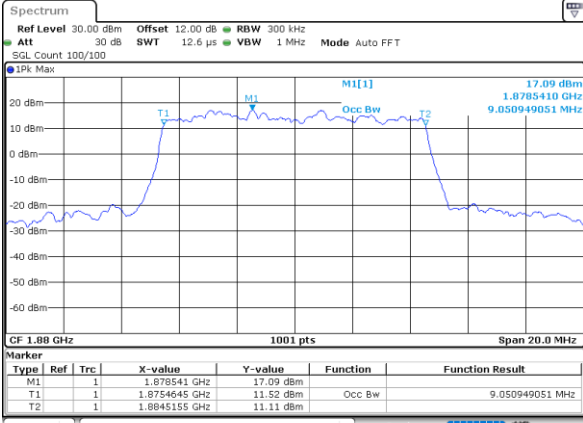

Date: 23.OCT.2021 00:21:02

Middle Channel / 10MHz / 16QAM

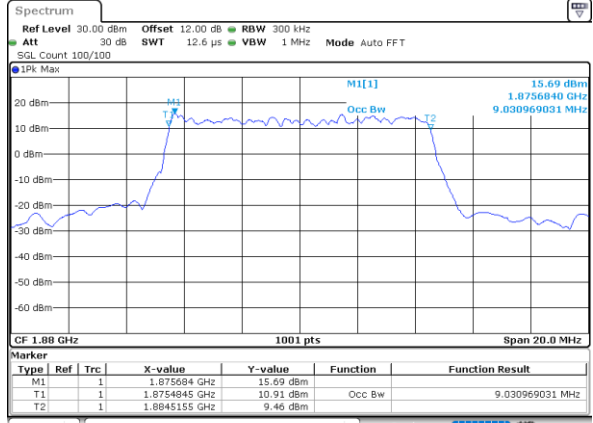

Date: 23.OCT.2021 00:21:40

Middle Channel / 15MHz / QPSK

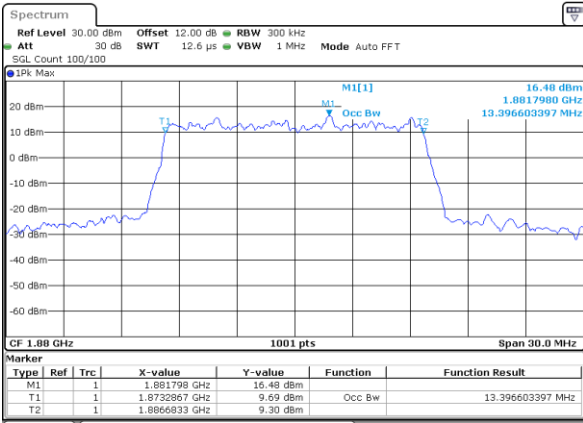

Date: 23.OCT.2021 00:37:05

Middle Channel / 15MHz / 16QAM

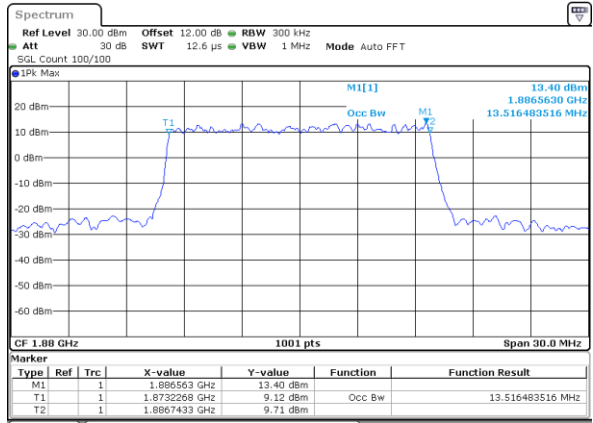

Date: 23.OCT.2021 00:37:43

Middle Channel / 20MHz / QPSK

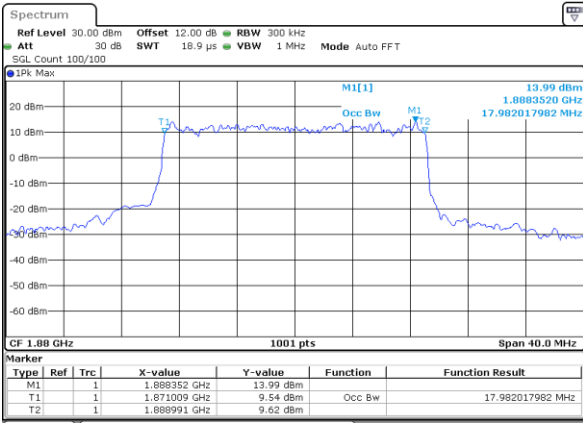

Date: 23.OCT.2021 00:53:08

Middle Channel / 20MHz / 16QAM

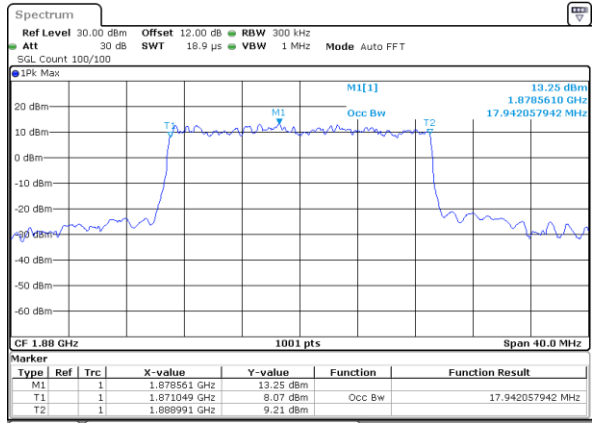

Date: 23.OCT.2021 00:53:46



LTE Band 2

Middle Channel / 1.4MHz / 64QAM

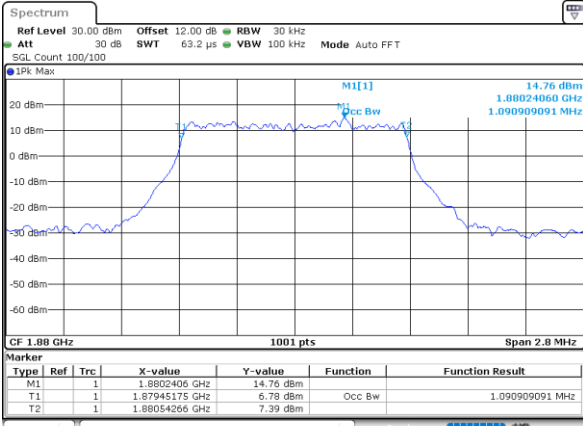

Date: 22.OCT.2021 23:23:43

Middle Channel / 3MHz / 64QAM

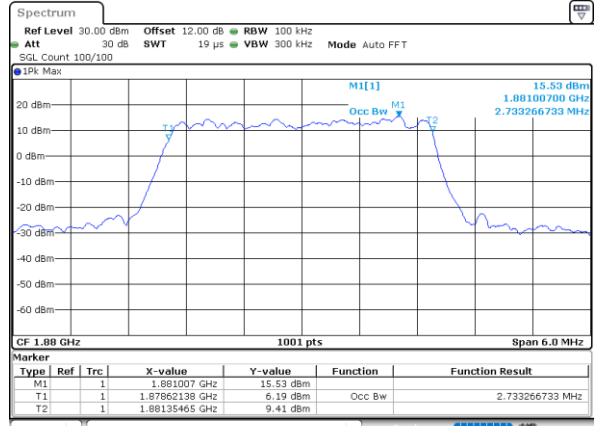

Date: 23.OCT.2021 01:05:26

Middle Channel / 5MHz / 64QAM

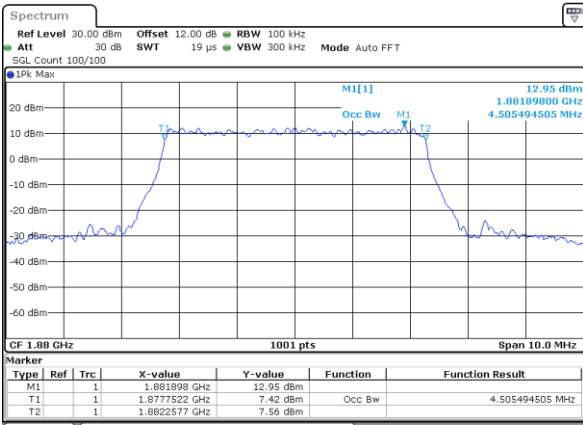

Date: 23.OCT.2021 01:16:52

Middle Channel / 10MHz / 64QAM

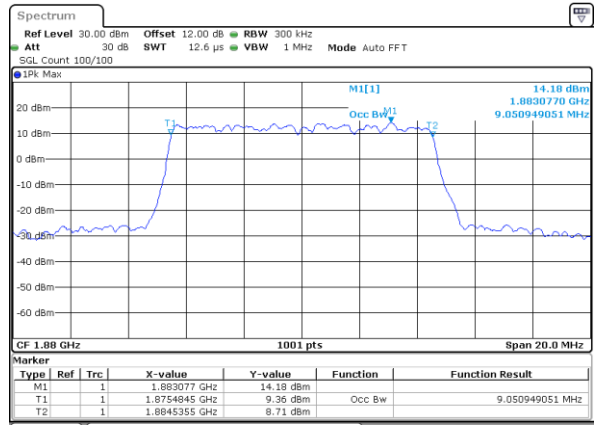

Date: 23.OCT.2021 01:16:18

Middle Channel / 15MHz / 64QAM

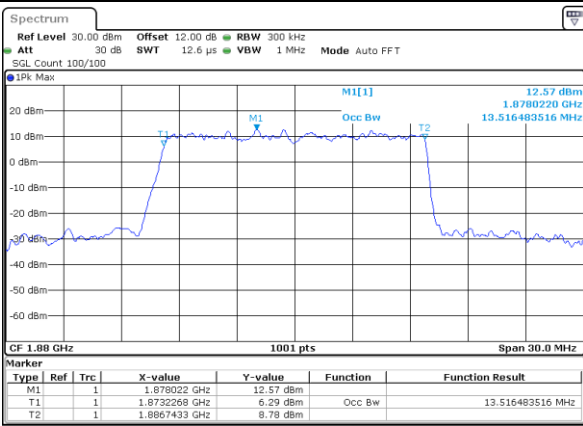

Date: 23.OCT.2021 01:21:45

Middle Channel / 20MHz / 64QAM

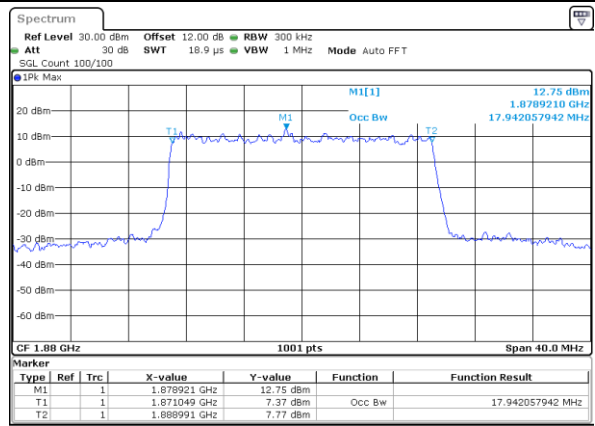

Date: 23.OCT.2021 01:27:11



LTE Band 2

Middle Channel / 1.4MHz / 256QAM

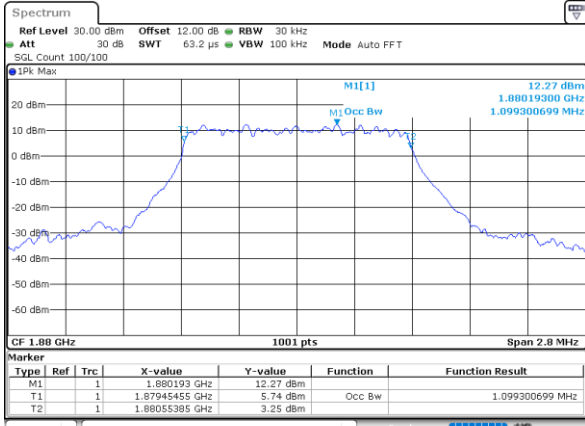

Middle Channel / 3MHz / 256QAM

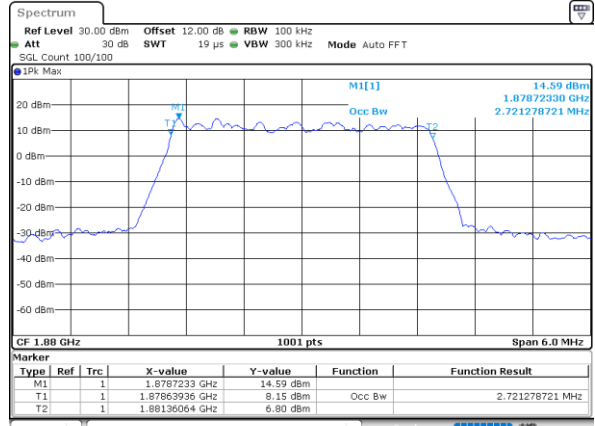

Middle Channel / 5MHz / 256QAM

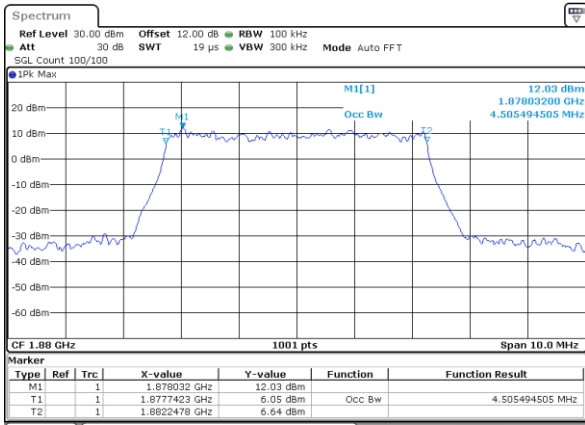

Middle Channel / 10MHz / 256QAM

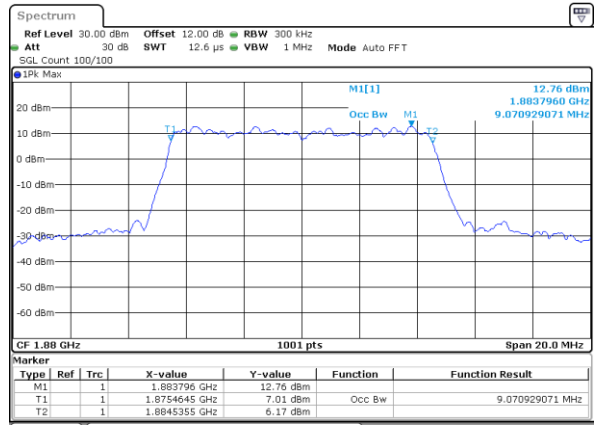

Middle Channel / 15MHz / 256QAM

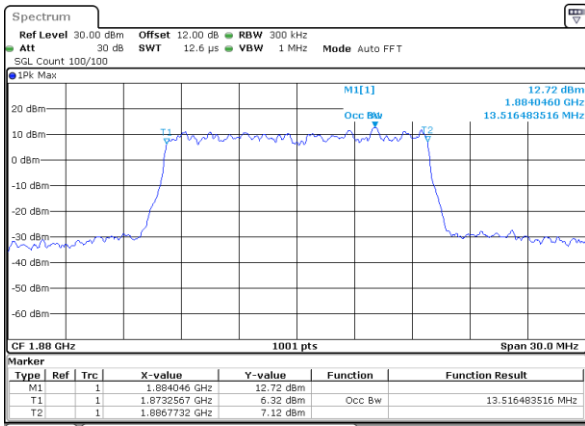

Middle Channel / 20MHz / 256QAM

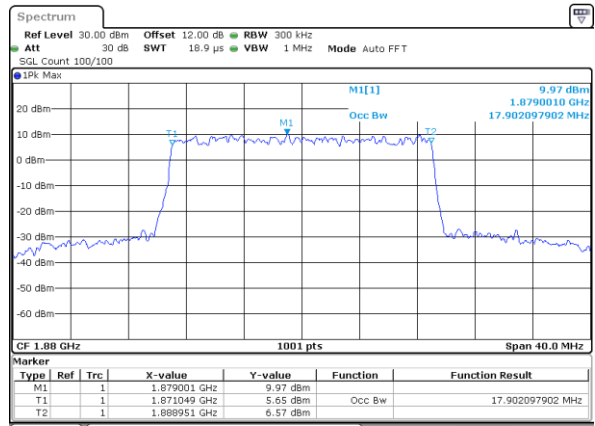



Conducted Band Edge

LTE Band 2 / 1.4MHz / QPSK

Lowest Band Edge / 1RB

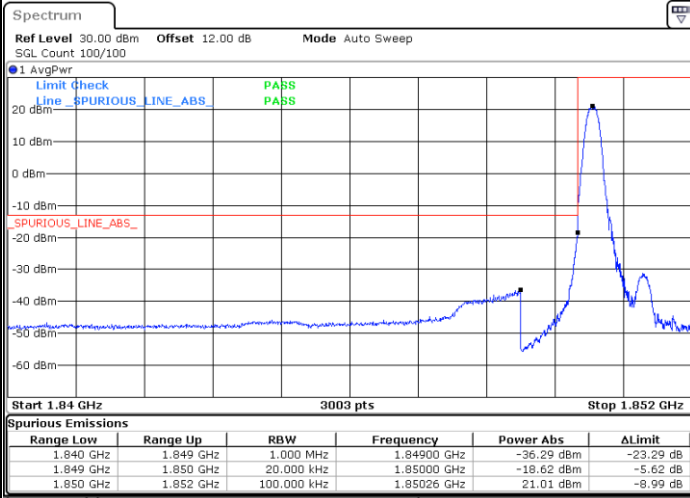

Date: 22.OCT.2021 23:27:22

Highest Band Edge / 1RB

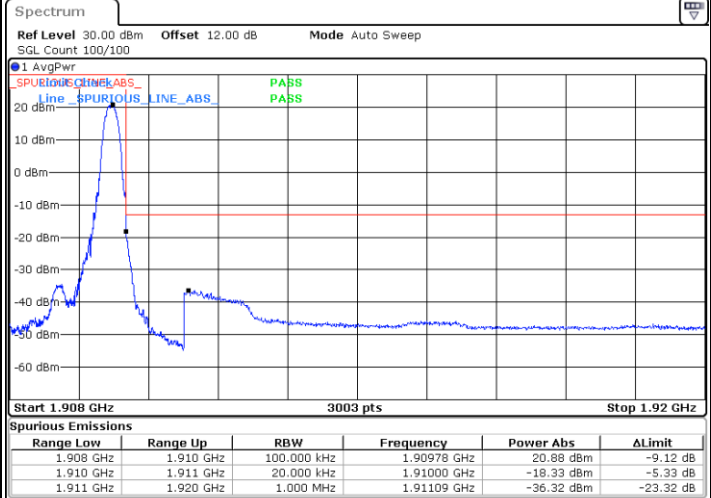

Date: 22.OCT.2021 23:37:24

Lowest Band Edge / Full RB

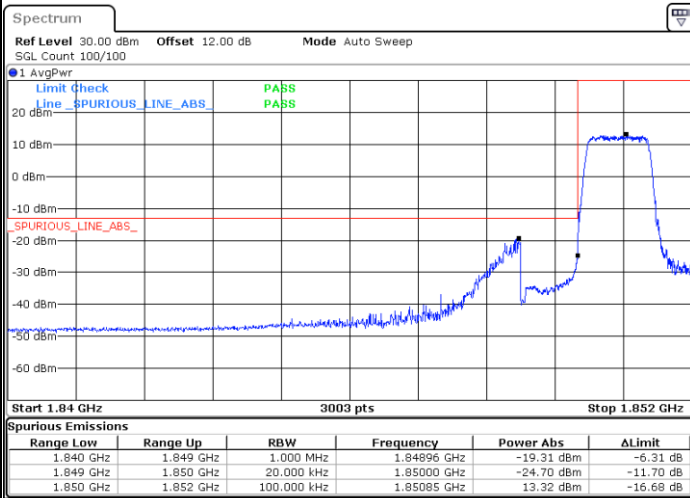

Date: 22.OCT.2021 23:29:39

Highest Band Edge / Full RB

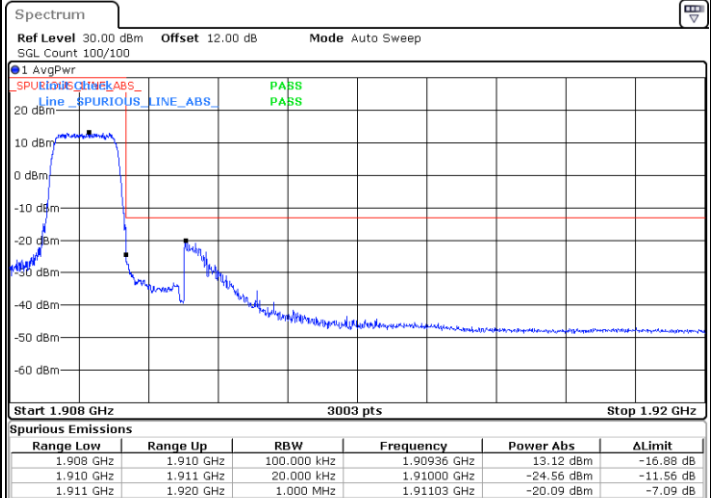

Date: 22.OCT.2021 23:39:40



LTE Band 2 / 1.4MHz / 16QAM

Lowest Band Edge / 1 RB

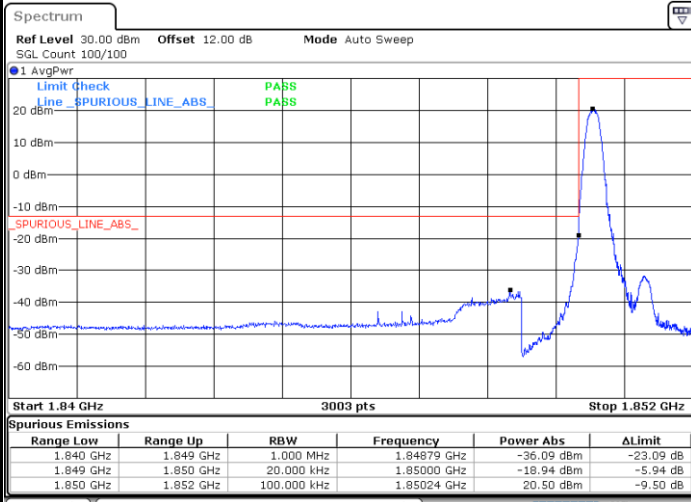

Highest Band Edge / 1 RB

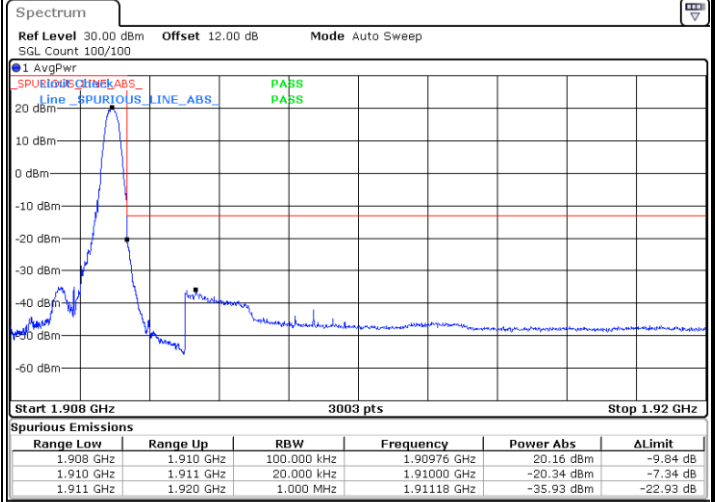

Lowest Band Edge / Full RB

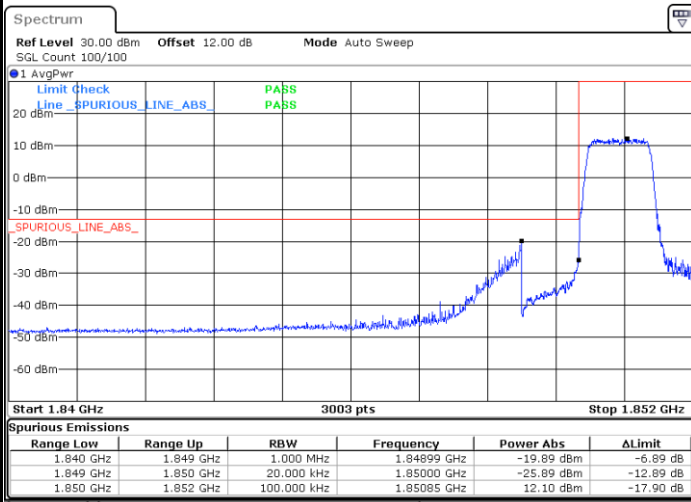

Highest Band Edge / Full RB

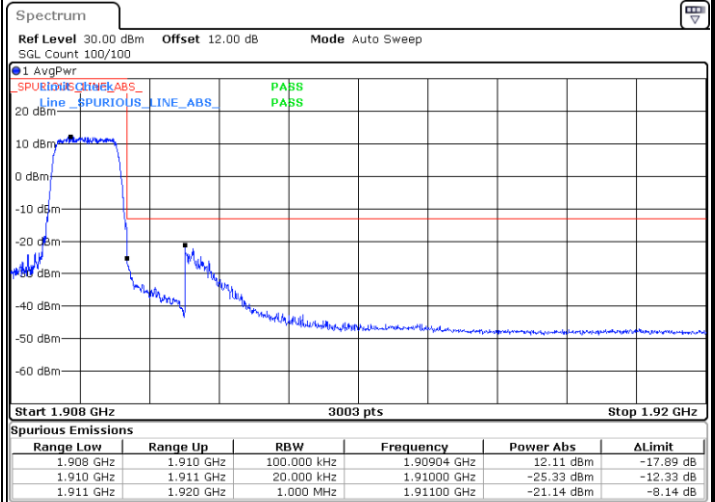



LTE Band 2 / 1.4MHz / 64QAM

Lowest Band Edge / 1 RB

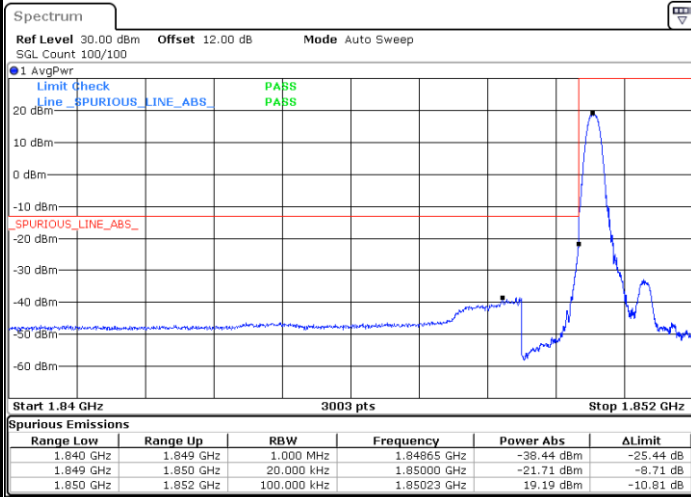

Date: 22.OCT.2021 23:21:56

Highest Band Edge / 1 RB

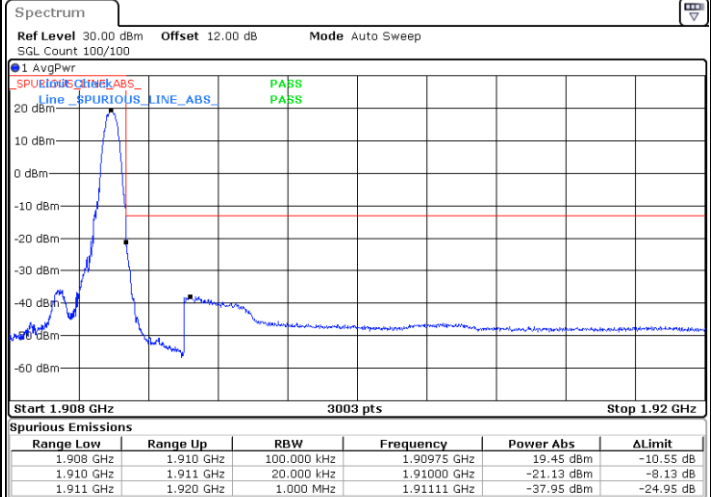

Date: 22.OCT.2021 23:25:06

Lowest Band Edge / Full RB

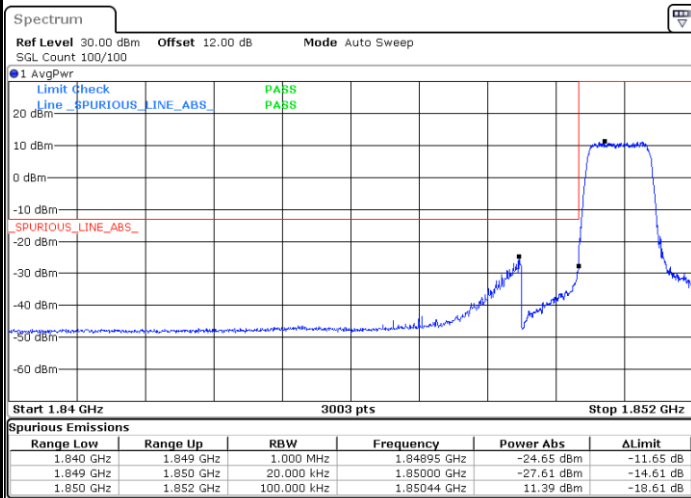

Date: 22.OCT.2021 23:23:05

Highest Band Edge / Full RB

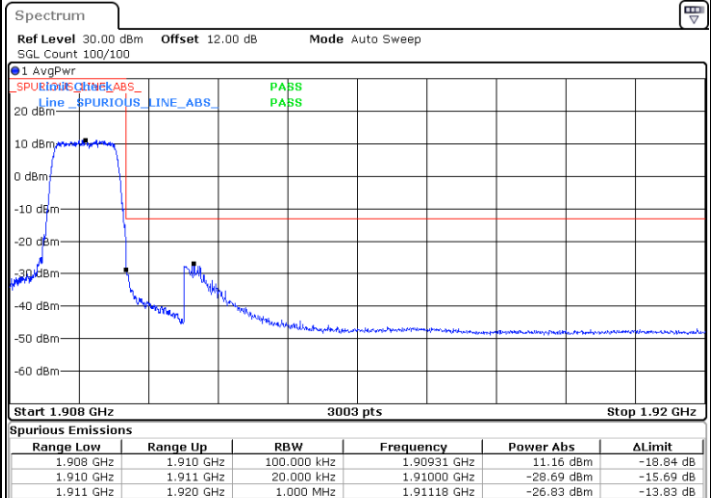

Date: 22.OCT.2021 23:26:14



LTE Band 2 / 1.4MHz / 256QAM

Lowest Band Edge / 1 RB

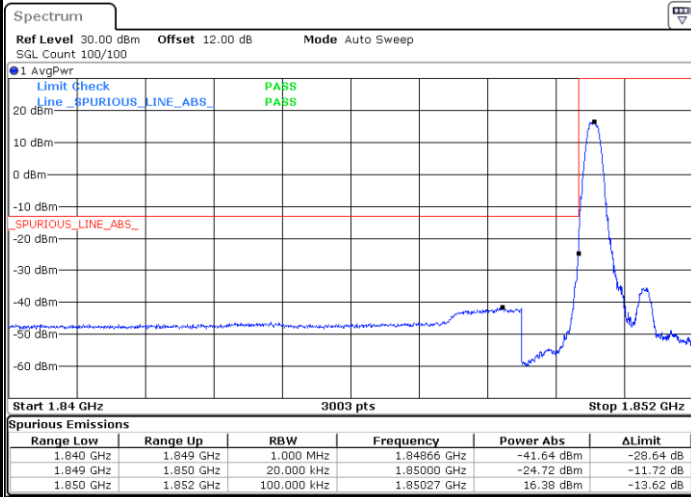

Date: 24.OCT.2021 15:39:38

Highest Band Edge / 1 RB

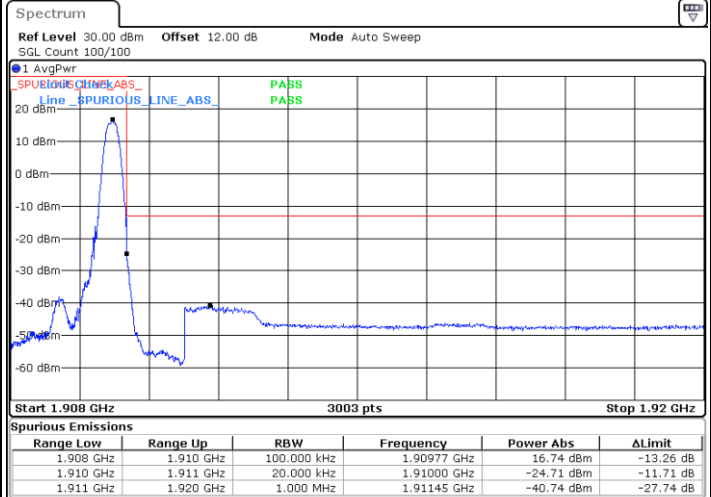

Date: 24.OCT.2021 15:41:57

Lowest Band Edge / Full RB

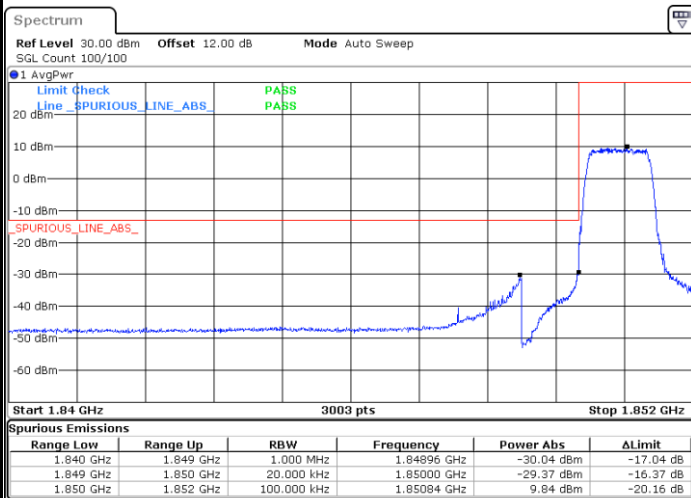

Date: 24.OCT.2021 15:40:19

Highest Band Edge / Full RB

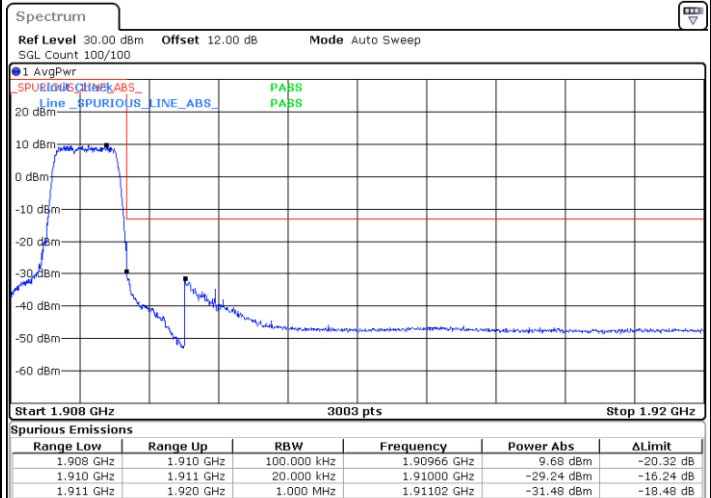

Date: 24.OCT.2021 15:42:37



LTE Band 2 / 3MHz / QPSK

Lowest Band Edge / 1RB

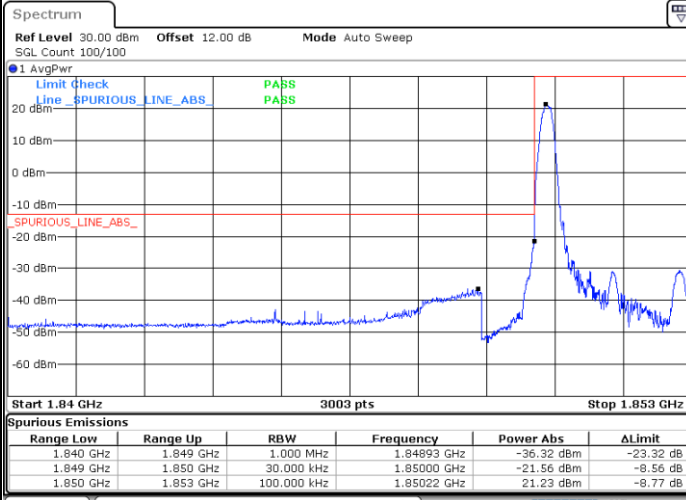

Date: 22.OCT.2021 23:43:25

Highest Band Edge / 1 RB

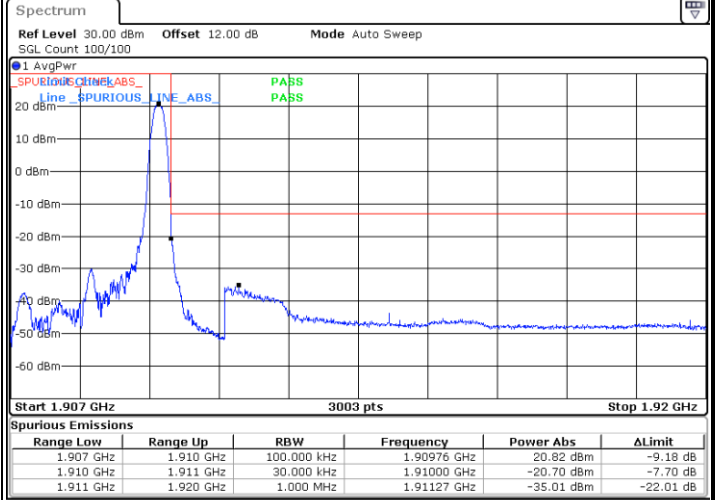

Date: 22.OCT.2021 23:53:27

Lowest Band Edge / Full RB

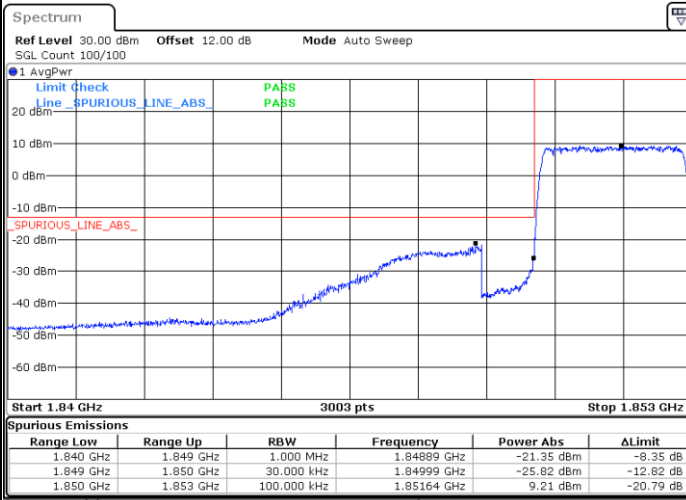

Date: 22.OCT.2021 23:45:41

Highest Band Edge / Full RB

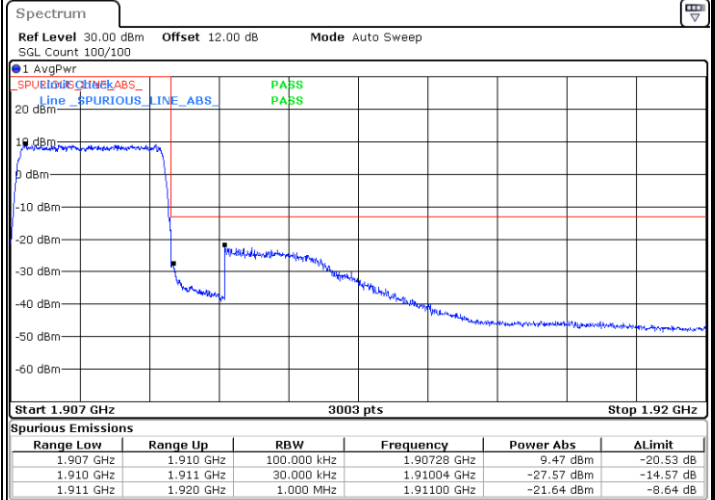

Date: 22.OCT.2021 23:55:43



LTE Band 2 / 3MHz / 16QAM

Lowest Band Edge / 1 RB

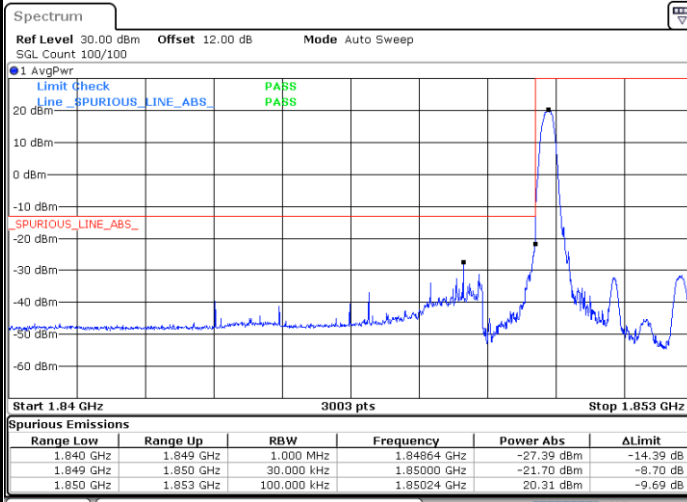

Date: 22.OCT.2021 23:44:33

Highest Band Edge / 1 RB

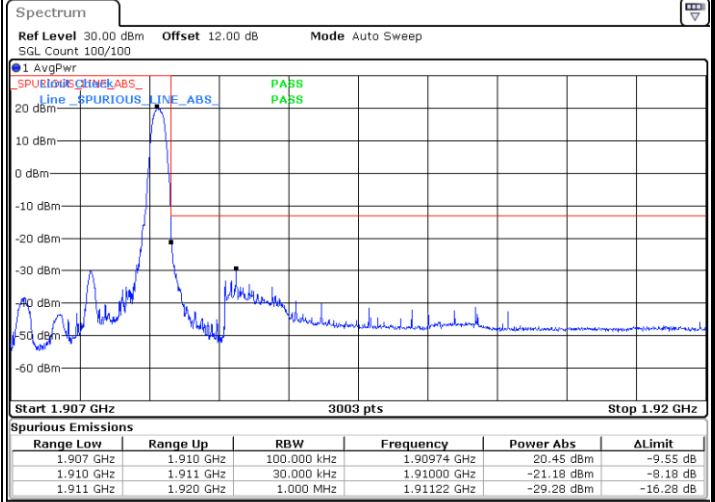

Date: 22.OCT.2021 23:54:35

Lowest Band Edge / Full RB

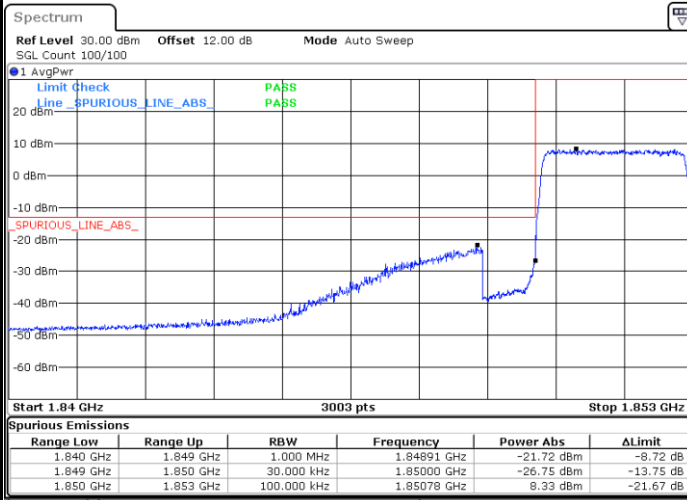

Date: 22.OCT.2021 23:46:50

Highest Band Edge / Full RB

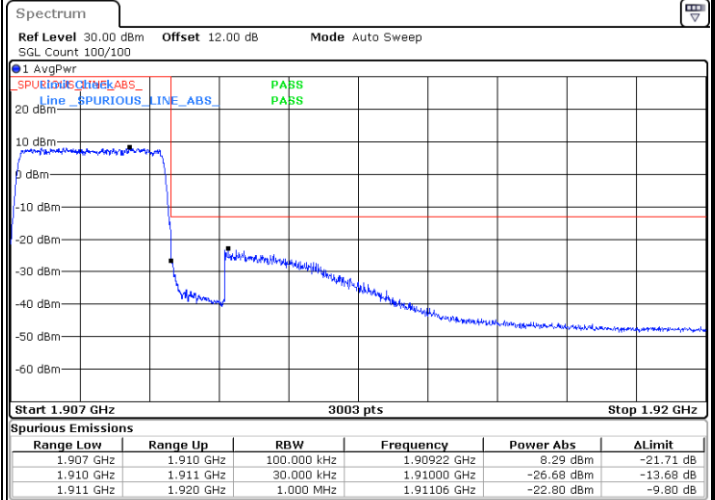

Date: 22.OCT.2021 23:56:51



LTE Band 2 / 3MHz / 64QAM

Lowest Band Edge / 1 RB

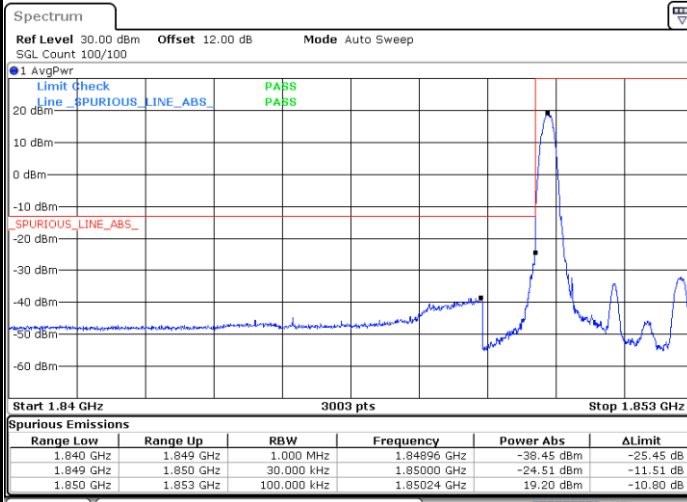

Date: 23.OCT.2021 01:03:39

Highest Band Edge / 1 RB

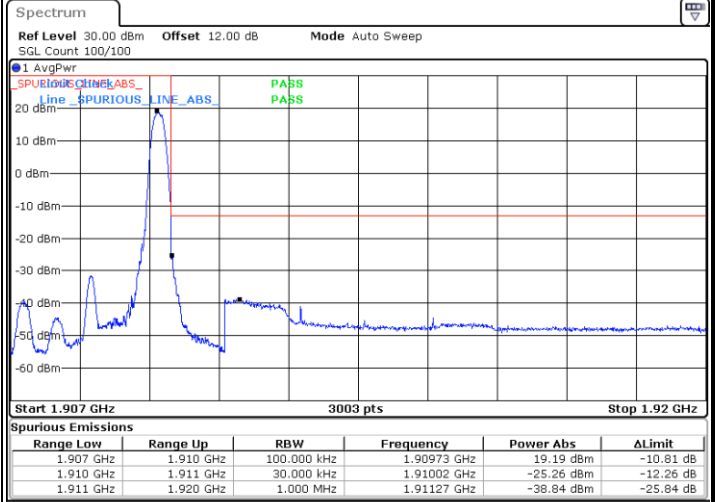

Date: 23.OCT.2021 01:06:48

Lowest Band Edge / Full RB

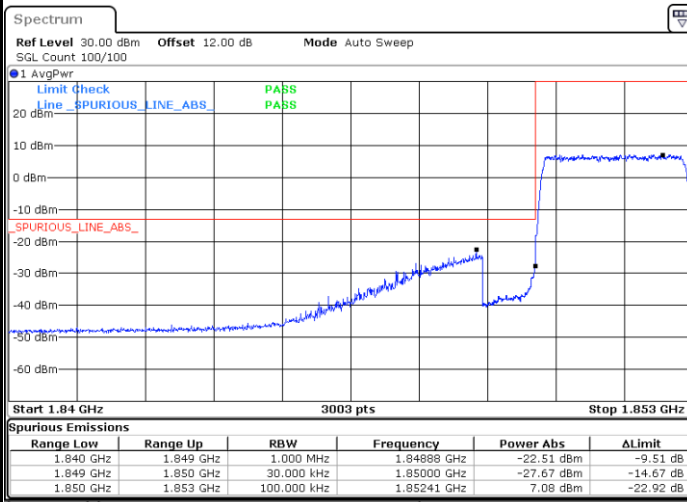

Date: 23.OCT.2021 01:04:47

Highest Band Edge / Full RB

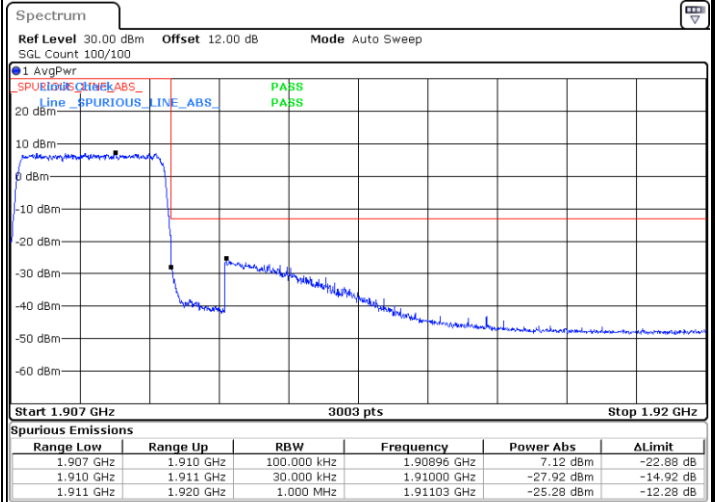

Date: 23.OCT.2021 01:07:57



LTE Band 2 / 3MHz / 256QAM

Lowest Band Edge / 1 RB

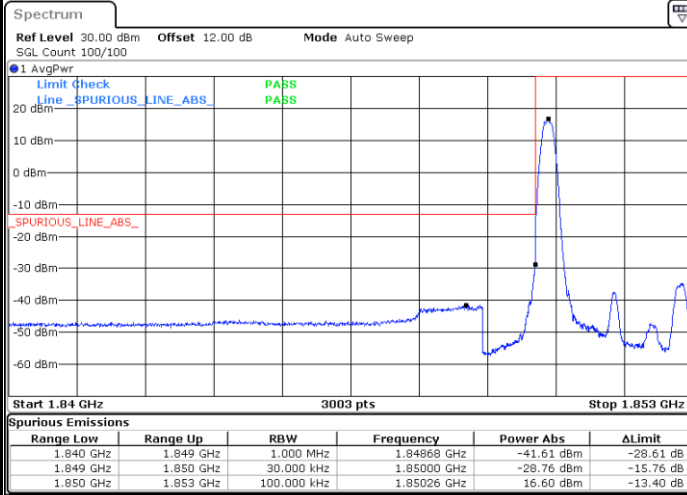

Highest Band Edge / 1 RB

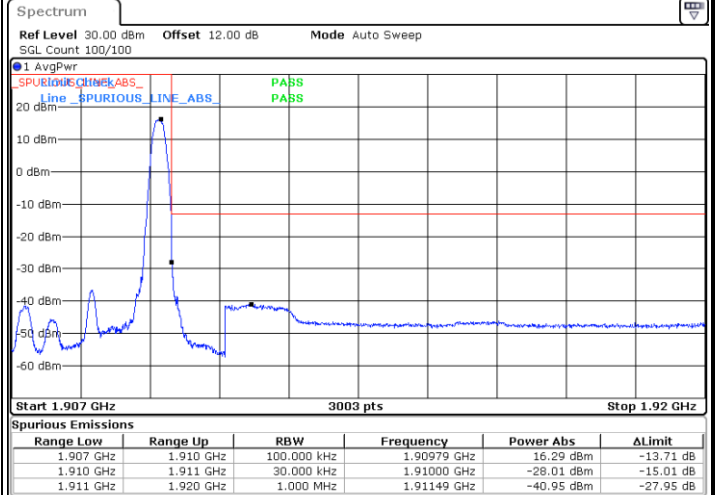

Lowest Band Edge / Full RB

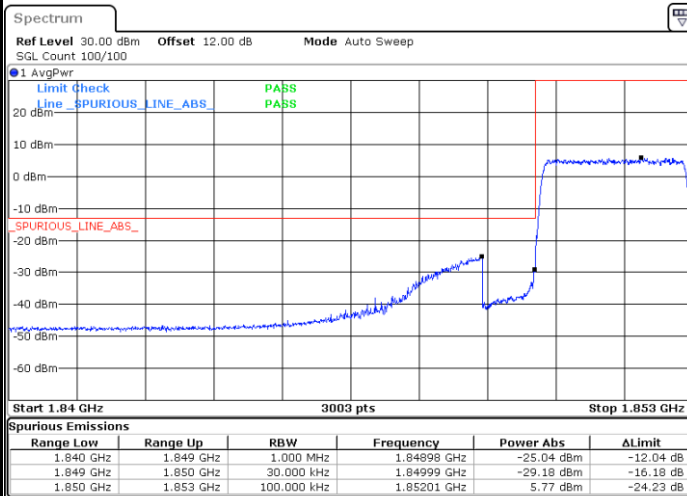

Highest Band Edge / Full RB

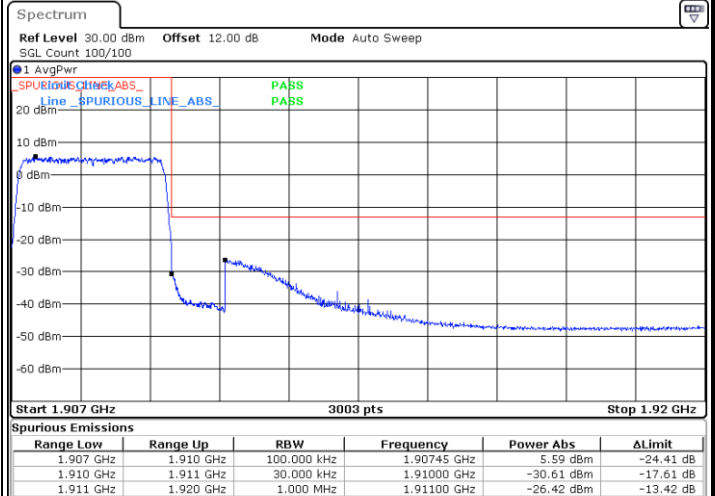



LTE Band 2 / 5MHz / QPSK

Lowest Band Edge / 1 RB

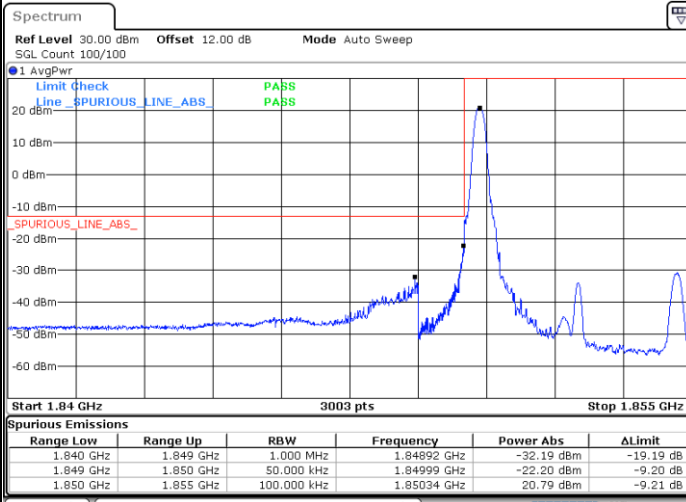

Date: 22.OCT.2021 23:59:28

Highest Band Edge / 1 RB

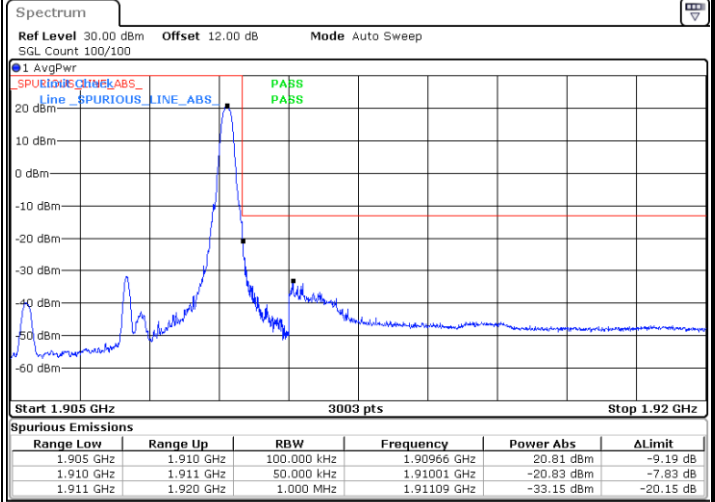

Date: 23.OCT.2021 00:09:29

Lowest Band Edge / Full RB

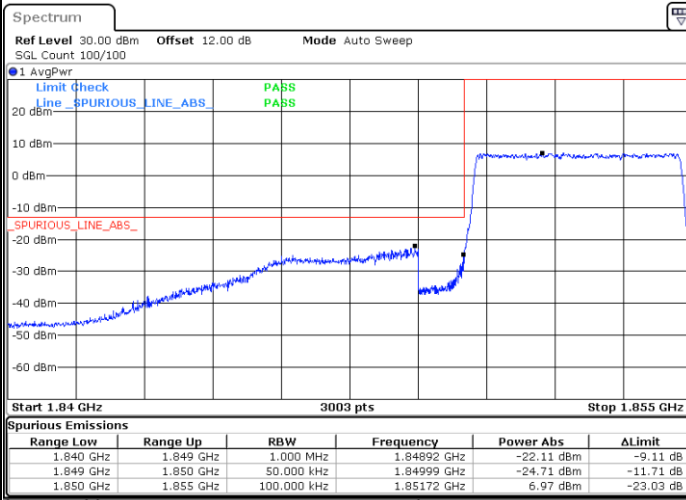

Date: 23.OCT.2021 00:01:44

Highest Band Edge / Full RB

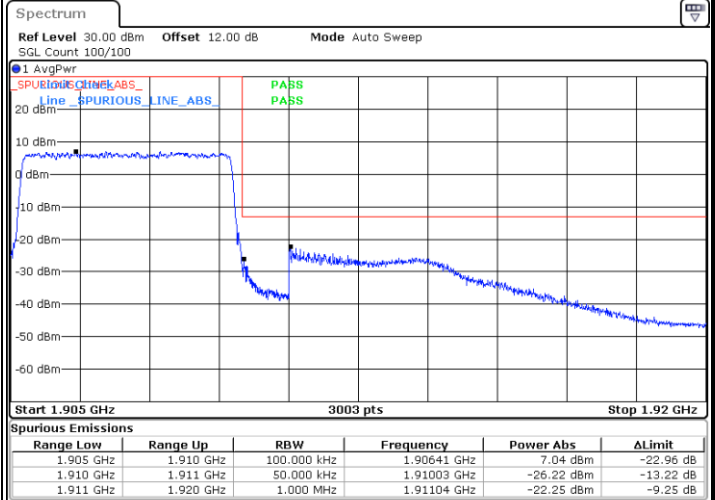

Date: 23.OCT.2021 00:11:46



LTE Band 2 / 5MHz / 16QAM

Lowest Band Edge / 1RB

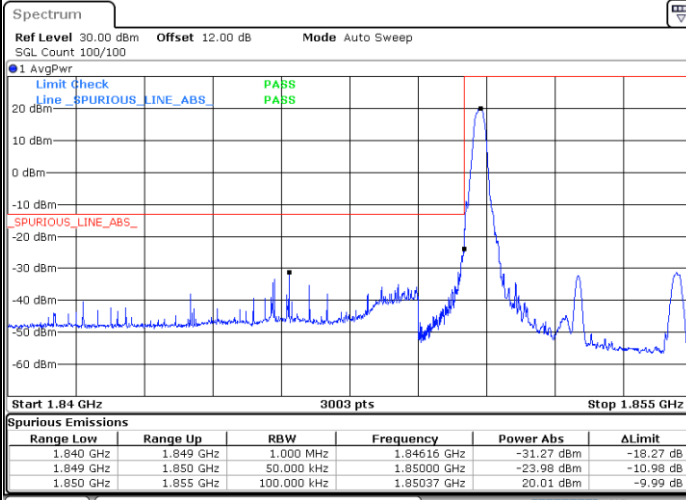

Date: 23.OCT.2021 00:00:36

Highest Band Edge / 1 RB

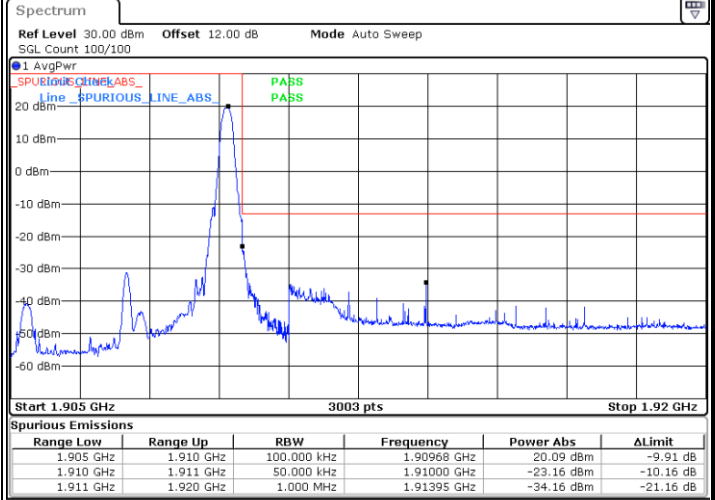

Date: 23.OCT.2021 00:10:38

Lowest Band Edge / Full RB

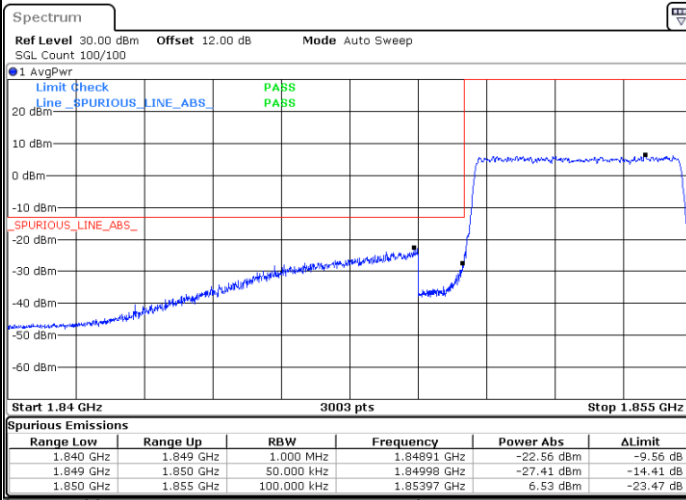

Date: 23.OCT.2021 00:02:53

Highest Band Edge / Full RB

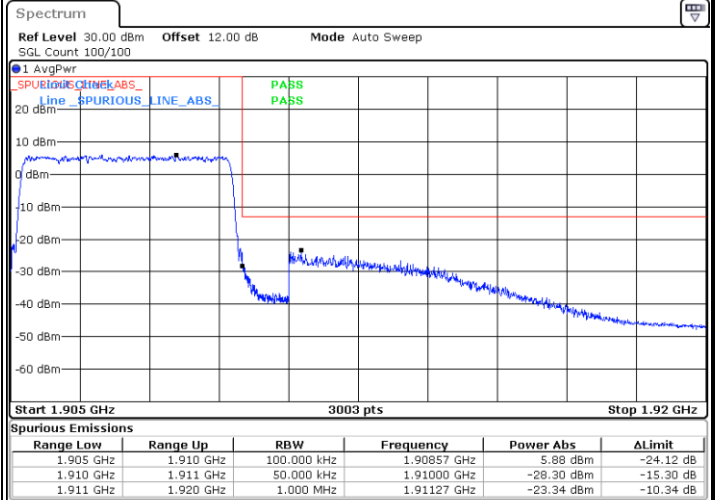

Date: 23.OCT.2021 00:12:54



LTE Band 2 / 5MHz / 64QAM

Lowest Band Edge / 1RB

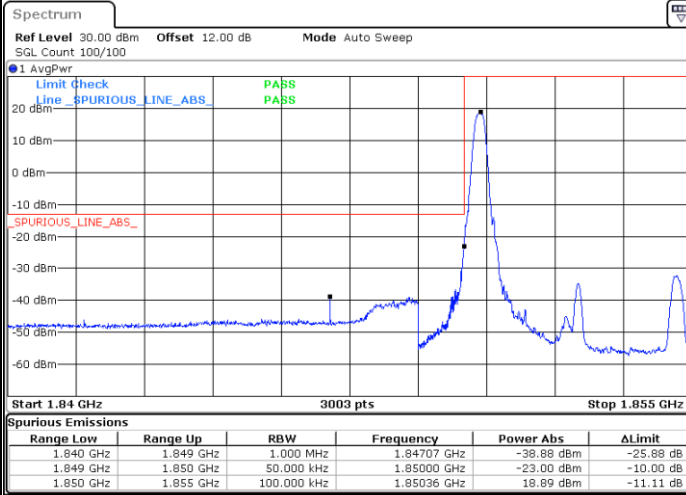

Date: 23.OCT.2021 01:09:05

Highest Band Edge / 1 RB

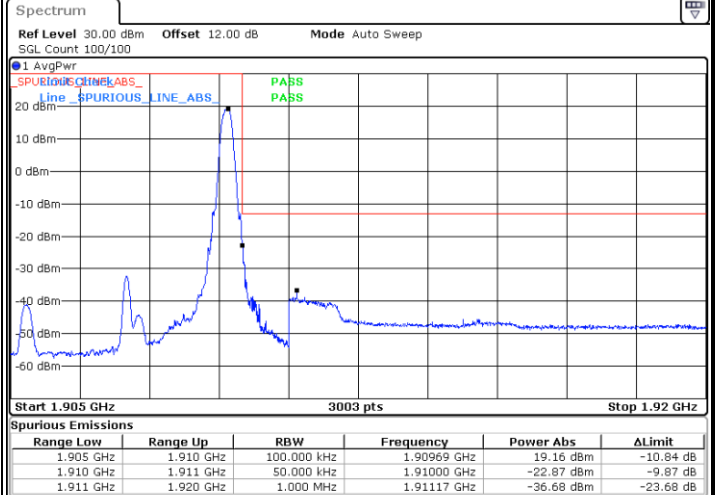

Date: 23.OCT.2021 01:12:15

Lowest Band Edge / Full RB

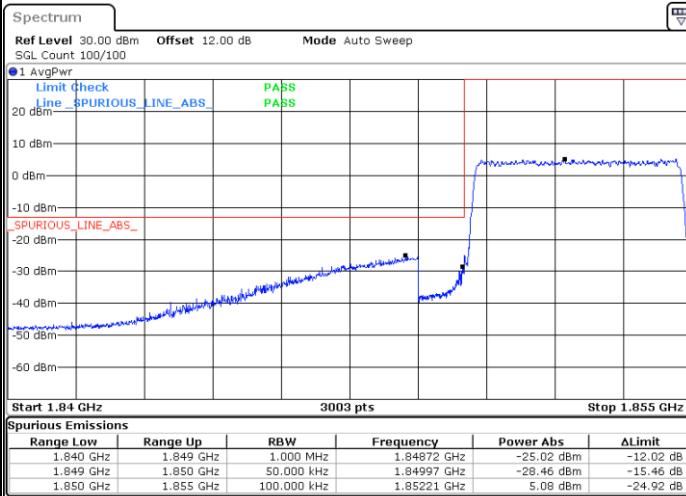

Date: 23.OCT.2021 01:10:14

Highest Band Edge / Full RB

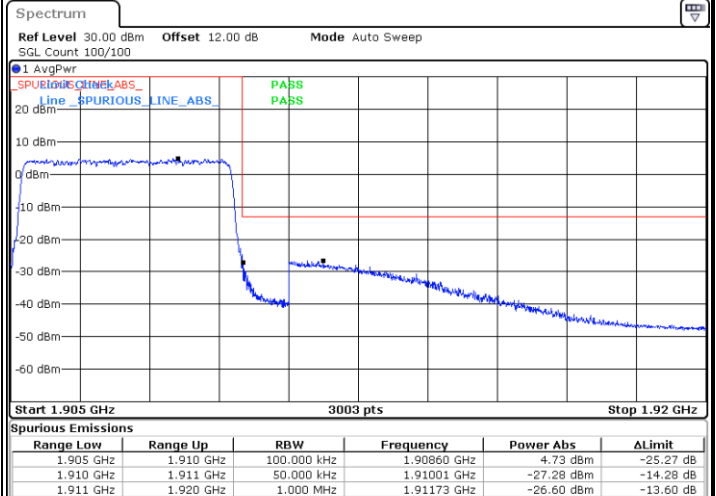

Date: 23.OCT.2021 01:13:23



LTE Band 2 / 5MHz / 256QAM

Lowest Band Edge / 1RB

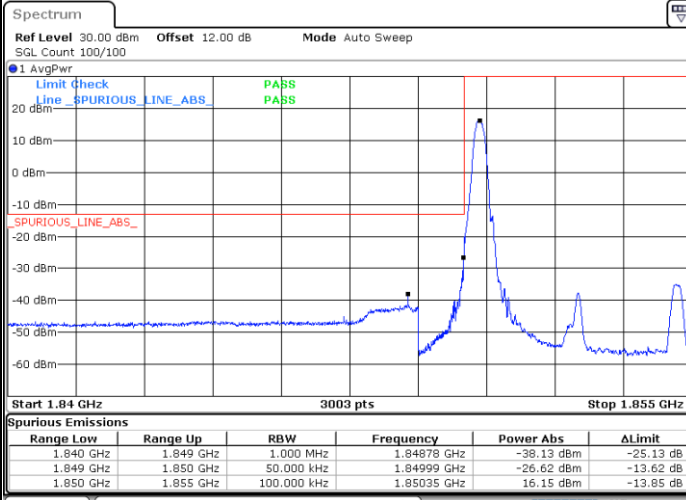

Date: 24.OCT.2021 16:07:50

Highest Band Edge / 1 RB

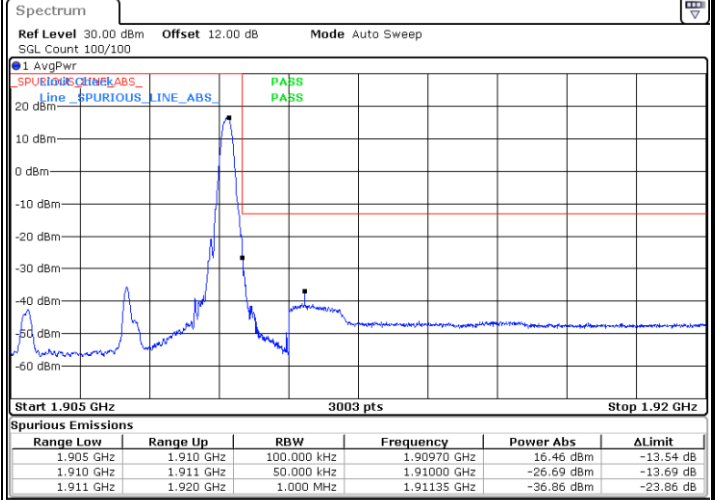

Date: 24.OCT.2021 16:12:03

Lowest Band Edge / Full RB

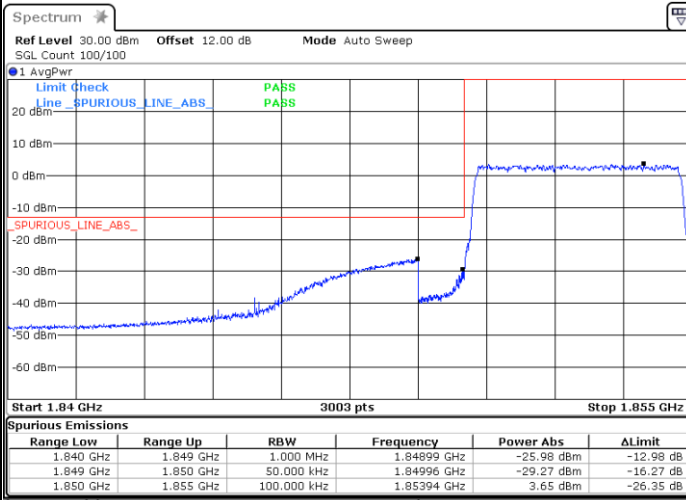

Date: 24.OCT.2021 16:09:51

Highest Band Edge / Full RB

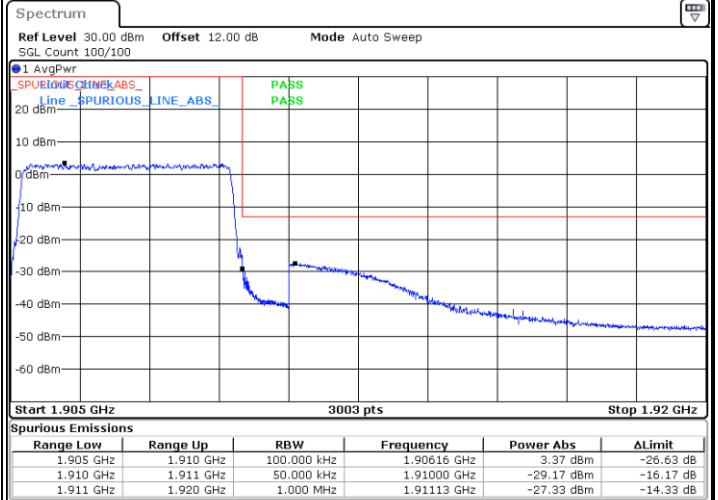

Date: 24.OCT.2021 16:12:47